





# Safgard™

450 Series

## Low Water Cut-Offs For Steam Boilers

120 VAC Operating Voltage  
Max. Pressure 15 psi

-  Low maintenance. No moving parts to wear stick or hang up, as in float devices.
-  Solid state circuitry. Designed for the highest level of performance and reliability.
-  Automatically shuts off burner, after delay, in a low water condition to prevent dry firing.
-  Time delay allows water to feed above the probe to a safe operating level.

## HOW TO INSTALL

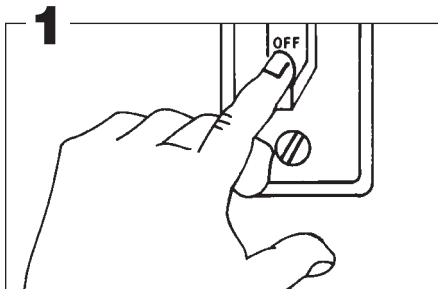

**WARNING** – To prevent electrical shock or equipment damage, power must be off during installation or servicing of the control. To prevent serious burns, the boiler should be thoroughly cooled before installing or servicing control. Only qualified personnel may install or service the control in accordance with local codes and ordinances. Read instructions completely before proceeding.

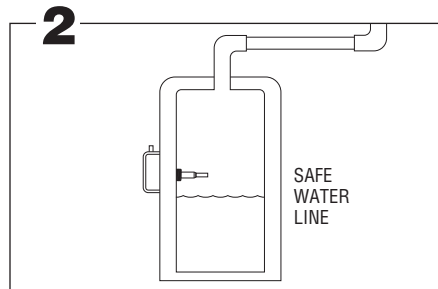

The probe may be installed in the boiler above the lowest safe water level established by the boiler manufacturer. Most manufacturers provide a suitable opening in the side of the boiler.

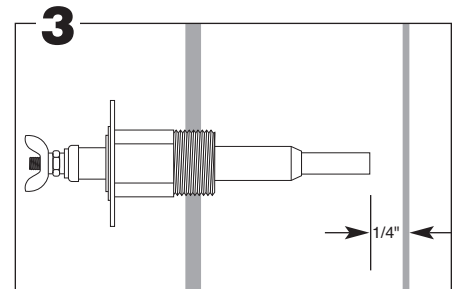

Allow 1/4" clearance from the probe to any boiler surface, tube or baffle. NOTE: Excessive use of Teflon tape to seal probe piping threads may insulate the control from boiler ground. This could result in the control not operating.

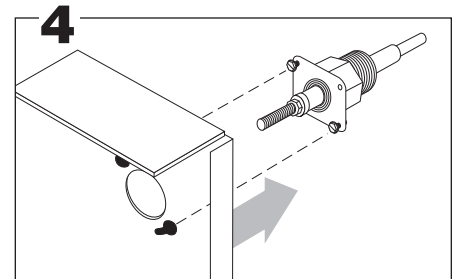

Loosen the two control cover binding head screws and remove the cover. Assemble the chassis to the probe flange and secure with the screws provided with the probe.

**REMOTE MOUNTED MODELS ONLY**

**A**

**B**

**A.** To secure mounting plate to boiler jacket,\* pre-drill two 3/32" pilot holes using the mounting plate as a template. Secure plate with sheet metal screws provided. Attach control to mounting plate by slipping keyholes in back of chassis over pre-mounted screws on plate. Tighten screws.

**B.** Using a wire nut, attach a wire (min 90°C) to the pigtail lead in the control box. Attach the other end to the probe terminal in the remote probe housing. Attach a second wire between the ground screw on the control chassis and one of the four screws in the remote probe housing. Note: Wires and wire nuts not provided.

\*Or other suitable surface

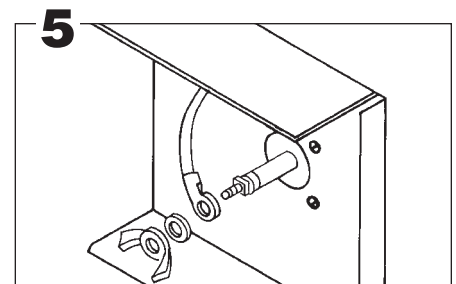

Connect the ring terminal wire lead to the probe terminal stud and secure with the lock washer and wing nut provided. With the power removed, proceed with installation and wiring according to the instructions on page 2. Upon completion of wiring replace control cover.

**HYDROLEVEL  
COMPANY**

P.O. Box 1847  
New Haven, CT 06508  
Phone: (203) 776-0473  
FAX: (203) 773-1019

## WIRING METHOD A: SAME POWER SOURCE FOR CONTROL AND BURNER CIRCUIT.

### A1

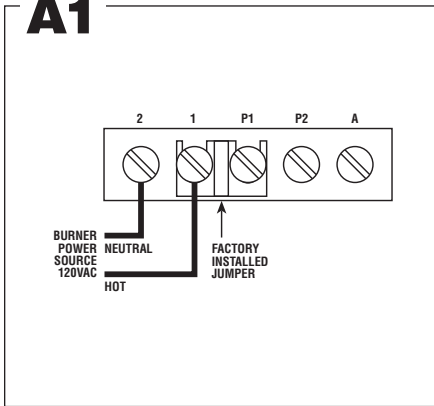

**A1** Connect input voltage (120 VAC, 60 HZ) to terminals 1 and 2. 120 VAC, 60 HZ must be supplied to terminals 1 and 2 for internal operation of the control.

### A2

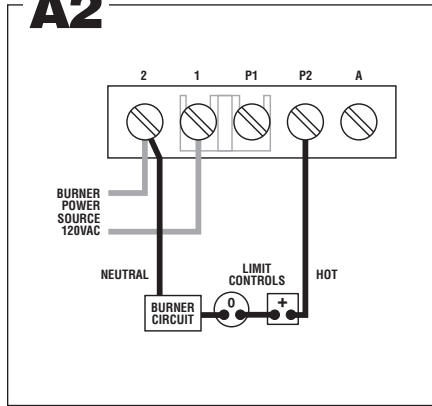

**A2** Connect terminal 2 to burner circuit neutral. Connect terminal P2 to burner circuit in series with other limit controls. Consult boiler manufacturer instructions for proper terminal connections. Control should be wired in series with and before other limit controls.

### A3

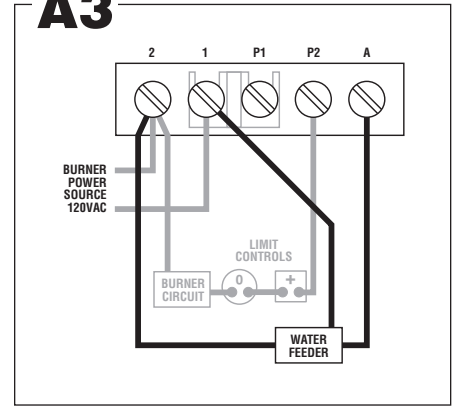

**A3** Optional water feeder connection. Connect feeder N to terminal 2. Connect Feeder H to terminal 1. Connect feeder "FEED" or "W" to terminal A. For water feeders with 2 leads, connect feeder neutral to terminal 2 and feeder hot to terminal A. **Note:** Use of a solenoid valve or McDonnell & Miller Model 101A water feeder may cause flooding and is not recommended for use with this low water cut-off.

## WIRING METHOD B: SEPARATE POWER SOURCE FOR CONTROL AND BURNER CIRCUIT.

### B1

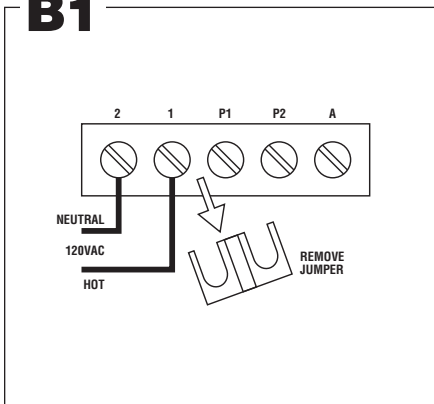

**B1** Remove jumper between terminals 1 and P1. Connect input voltage (120 VAC, 60 HZ) to terminals 1 and 2. 120 VAC 60 HZ must be supplied to terminals 1 and 2 for internal operation of the control.

Connect hot lead from the burner control circuit to terminal P1. This terminal supplies power to terminal P2 in normal operating conditions when water is at the probe. Connect neutral to burner circuit. Note: consult boiler manufacturer instructions for proper terminal connections.

### B2

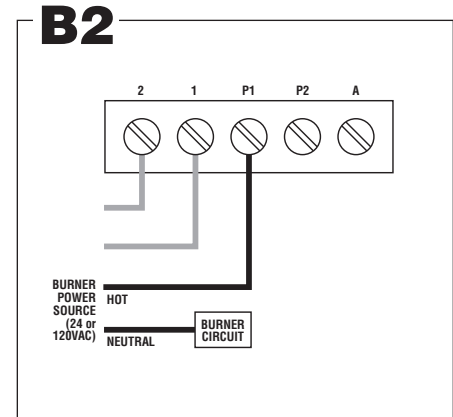

### B2

### B3

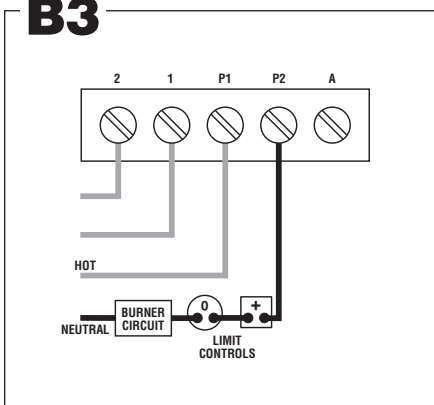

**B3** Connect terminal P2 to burner circuit in series with and before other limit controls.

Optional water feeder connection. Connect feeder H to terminal P1. Connect feeder "FEED" or "W" to terminal A. Connect terminal N to neutral of the burner circuit supply. For feeders with two leads, connect feeder hot to terminal A and connect feeder neutral to neutral of the burner circuit supply. **Note:** Use of solenoid valve or McDonnell & Miller model 101A water feeder may cause flooding and is not recommended for use with this low water cut-off.

### B4

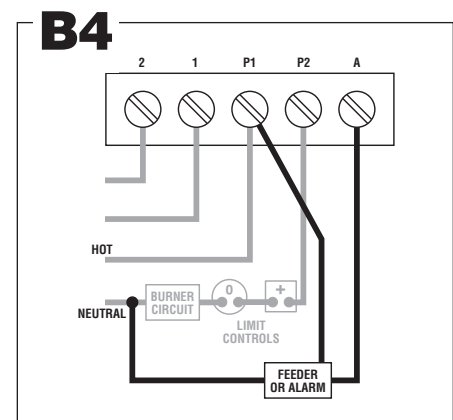

### B4

# Principle of Operation

Hydrolevel controls are electrically operated. A probe is installed in the boiler shell and connected to the control unit. Water is used as a conductor to complete a circuit from the probe to the control unit. The control unit provides switching contacts to complete the burner control circuit and to operate an optional alarm or water feeder.

## NORMAL OPERATION

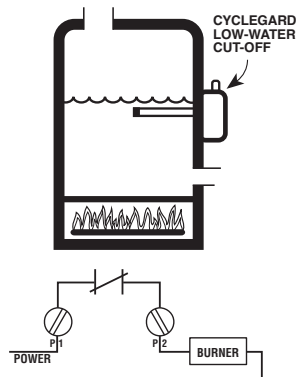

With water present at the probe, the control circuit is complete. Contact between terminals P1 and P2 completes the burner circuit, allowing for normal operation of the burner.

## LOW WATER CONDITION

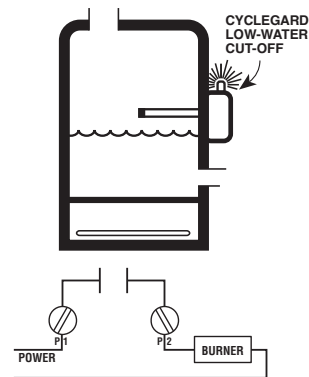

Whenever the water falls below the probe, a time delay is activated in the control. After 15 seconds of a low water condition, the control interrupts the burner circuit and shuts down the boiler. This time delay feature prevents short cycling of the burner circuit during temporary low water levels common in turbulent steam boiler environments.

# Operating Instructions

## NOTE

For proper low water cut-off operation, the boiler should be cleaned at initial installation and periodically thereafter. Refer to the boiler manufacturer's instructions for cleaning procedures.

## OPERATING TEST PROCEDURE

1. After installation, bring the boiler water to a safe operating level, turn on power and set the thermostat to call for heat. The amber LED lamp should be off. **The boiler will fire after a 30 second delay.**
2. *Slowly* lower the boiler water to a point below the probe. The amber LED lamp on the control will light. The lamp may begin to flicker with the bouncing water level. Stop draining the boiler when the lamp glows steadily. NOTE: The water should not be lowered beyond a visible point in the gauge glass.
3. The boiler will shut down within 15 seconds.

## IF BURNER DOES NOT SHUT DOWN IN LOW WATER

1. Check terminal block wiring to insure that all connections are correct.

2. Check the probe installation to insure that there is 1/4" clearance from any surface within the boiler or pipe. (Refer to Step 3 on page 1 of this instruction sheet.
3. Clean the boiler in accordance to the manufacturer's instructions. Machining oils, grease, rust and other contaminants in the boiler water can cause foaming or surging and make a low water condition difficult to detect during burner operation.

## IF THE AMBER LED LAMP IS ON

The amber LED lamp indicates that the water is below the probe. If the gauge glass shows that the water is at the correct operating level and the amber LED is lit check the following:

1. Check for plugged gauge glass.
2. Make sure probe lead wire is properly secured to the terminal.
3. Check for proper ground between probe and boiler shell. Excessive use of Teflon tape or sealing compound may isolate the probe from the boiler shell.
4. Remove probe and examine for oily residue. Clean probe with steel wool and skim boiler.

# Maintenance

To ensure optimum performance remove and inspect probe annually. Clean any sediment or scale from the probe using a scouring pad or steel wool. Re-install the probe and perform the Operating Test Procedure described above.

# VXT WATER FEEDER



The VXT Water Feeder (available separately) can be installed with Hydrolevel or other low water cut-offs to automatically replenish boiler water in the event of a low water condition. The VXT offers programmable *feed amount* and *feed delay* settings. These can easily be set to ensure the proper feed amount and to provide adequate time for condensate to return to

the boiler before starting a feed cycle. The VXT Feeder's *Digital Feed Counter* tracks the amount of water added to the boiler exposing system leaks, which can significantly shorten the life of a cast iron boiler. Additional features including a manual feed button, underfeed and flood protection make the VXT an ideal choice for safety and convenience.

## PROBES

Test Pressure: 1000 PSI, All Models

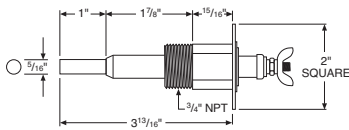

**EL1214 – STANDARD MODEL – 3/4" NPT**  
For 1/2", order Model No. EL-1220

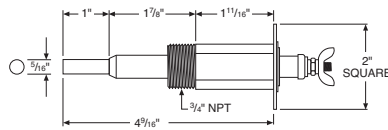

**EL1214-P – 3/4" NPT**



**EL1214-R  
REMOTE PROBE**

## THE PROBE MAKES THE DIFFERENCE

The probe used in all Hydrolevel controls offers you distinctive advantages. Unlike float devices, there are no moving parts to wear stick, or "hang-up" in the harsh boiler environment.

A stuck or "hung-up" float can cause dangerous low water conditions. And if suddenly released, a float can feed cold water into overheated tubes or plates and cause explosive results.

The Hydrolevel control has no float bowl so sediment cannot collect. The reliable solid state circuitry and low maintenance probe are designed to provide years of troublefree operation.

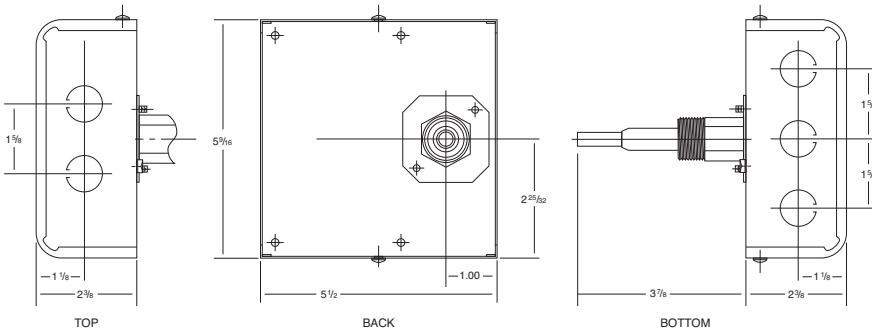

**MAXIMUM PRESSURE:** 15 PSI  
**INPUT VOLTAGE:** 120 VAC, 60 HZ  
**SWITCH CONTACTS:** SPDT  
**SWITCH RATINGS  
AND ALARM CIRCUIT:** 125 VA @ 120 VAC  
Pilot Duty



### LIMITED MANUFACTURER'S WARRANTY

We warrant products manufactured by Hydrolevel Company to be free from defects in material and workmanship for a period of two years from the date of manufacture or one year from the date of installation, whichever occurs first. In the event of any claim under this warranty or otherwise with respect to our products which is made within such period, we will, at our option, repair or replace such products or refund the purchase price paid to us by you for such products. In no event shall Hydrolevel Company

be liable for any other loss or damage, whether direct, indirect, incidental or consequential. This warranty is your EXCLUSIVE remedy and shall be IN PLACE OF any other warranty or guarantee, express or implied, including, without limitation, any warranty of MERCHANTABILITY or fitness for a particular purpose. This warranty may not be assigned or transferred and any unauthorized transfer or assignment thereof shall be void and of no force or effect.

# HYDROLEVEL COMPANY

P.O. Box 1847  
New Haven, CT 06508  
Phone: (203) 776-0473  
FAX: (203) 773-1019