



I-600

FIELD INSTALLATION HANDBOOK

Copper Connection Products

- GASKET INFORMATION
- PIPE PREPARATION
- PRODUCT INSTALLATION
- PRODUCT DATA

WARNING



- Read and understand all instructions before attempting to install, remove, adjust, or maintain any Victaulic products.
- Depressurize and drain piping systems before attempting to install, remove, adjust, or maintain any Victaulic products.
- Wear safety glasses, hardhat, foot protection, and hearing protection.

Failure to follow instructions and warnings could cause system failure, resulting in serious personal injury and/or property damage.

If you need additional copies of any instructions, or if you have questions about the safe and proper installation or operation of Victaulic products, contact Victaulic.

For the most up-to-date information on Victaulic products, visit:
www.victaulic.com

Table of Contents

INDEX	iii
-------------	-----

GENERAL INFORMATION

HAZARD IDENTIFICATION.....	2
INTRODUCTION	2
IMPORTANT INFORMATION	3
OPERATOR SAFETY GUIDELINES FOR TOOLS	4
COPPER TUBING PREPARATION	5
TOOL RATINGS.....	6
Roll Grooving Tool Ratings (Maximum Capacity) – ASTM B-88 Hard-Drawn Copper Tubing and DWV per ASTM B-306.....	6
Roll Grooving Tool Ratings (Maximum Capacity) – European Standard EN 1057 R250 (Half-Hard)	6
Roll Grooving Tool Ratings (Maximum Capacity) – Australian Standard AS 1432	7
COLOR-CODE IDENTIFICATION FOR CTS US STANDARD (ASTM B-88) HARD-DRAWN COPPER TUBING	7
COLOR-CODE IDENTIFICATION FOR AUSTRALIAN STANDARD (AS 1432) TABLES A, B, AND D COPPER TUBING.....	7
IDENTIFICATION FOR EUROPEAN STANDARD EN 1057 R250 (HALF-HARD) COPPER TUBING.....	7
TUBING LENGTH REQUIREMENTS FOR GROOVING.....	8
EXPLANATION OF CRITICAL ROLL GROOVE DIMENSIONS	9
GROOVE DIMENSIONS	10
CTS US Standard – ASTM B-88 Hard-Drawn Copper Tubing and DWV per ASTM B-306	10
European Standard – EN 1057 R250 (Half-Hard) Copper Tubing	11
Australian Standard – AS 1432 Tables A, B, and D Copper Tubing	12
GASKET SELECTION.....	13
Standard Gaskets for Victaulic Copper Connection Products ...	13
LUBRICATION	14
VICTAULIC LUBRICANT USAGE GUIDE	14
SPACING REQUIREMENTS FOR VICTAULIC COPPER CONNECTION SYSTEMS.....	15
Recommended Minimum Copper Tubing Spacing.....	15
External Clearance Allowance	15



INSTALLATION OF VICTAULIC COPPER CONNECTION PRODUCTS TO ACCOMMODATE THERMAL EXPANSION AND/OR CONTRACTION.....	16
Calculated Loop Lengths for Various Expansions.....	17
SUPPORT SPACING FOR VICTAULIC COPPER CONNECTION SYSTEMS.....	18
CTS US Standard	18
European Standard – EN 1057	19
Australian Standard – AS 1432.....	19
VICTAULIC COPPER CONNECTION PRODUCT INSTALLATION GUIDELINES.....	20
INSTALLATION INSPECTION	21

COUPLINGS FOR GROOVED-END COPPER TUBING INSTALLATION INSTRUCTIONS

Style 606 Rigid Coupling	26
Style 607 QuickVic® Rigid Coupling.....	29
Impact Wrench Usage Guidelines.....	33

FLANGE ADAPTER FOR GROOVED-END COPPER TUBING INSTALLATION INSTRUCTIONS

Flange Washer Notes for Style 641 Vic-Flange Adapter	36
Style 641 Vic-Flange Adapter.....	37

HOLE-CUT PRODUCT FOR COPPER TUBING

Style 622 Copper Mechanical-T® Bolted Branch Outlet.....	42
--	----

BUTTERFLY VALVE INSTALLATION AND OPERATION

Series 608 Copper Connection Butterfly Valve.....	48
---	----

PERMALYNX PERMANENT PUSH-TO-CONNECT SYSTEM INSTALLATION INSTRUCTIONS

Important Information and Installer Safety Requirements	50
Tube Preparation Requirements.....	52
Product Installation.....	57
System Testing.....	57

PRODUCT DATA..... 59

HELPFUL INFORMATION..... 73



Index

The following table provides a listing of products and installation information. If you need additional copies of any installation information, contact Victaulic at 1-800-PICK VIC.

NOTE: If two sources of instructions are referenced in this index, Victaulic recommends the use of both to ensure proper product installation.

Product	Where to Find Instructions
Depend-O-Lok Couplings	Instructions Shipped with Coupling
FireLock Automatic Sprinkler Products	I-40
FireLock CPVC Sprinkler System Products	I-800
FireLock Fire Protection Valves and Accessories	Manual Shipped with Valve or Accessory
PermaLynx Permanent Push-to-Connect System Products	I-PermaLynx and I-600
Pipe Preparation Tools	Manual Shipped with Pipe Preparation Tool
Pressfit Products	I-500
Series 317 AWWA Check Valve	I-317
Series 365 AWWA Vic-Plug Valve (3 – 12-inch/88.9 – 323.9-mm Sizes)	I-365/366/377.3-12
Series 365 AWWA Vic-Plug Valve (14 – 18-inch/ 355.6 – 457.0-mm Sizes)	I-365.14-18
Series 366 AWWA Vic-Plug Valve	I-365/366/377.3-12
Series 377 Vic-Plug Balancing Valve	I-365/366/377.3-12
Series 608 Copper Connection Butterfly Valve	I-600
Series 700 Butterfly Valve	I-100
Series 705W FireLock Butterfly Valve	I-705W
Series 706 Butterfly Valve	I-100
Series 707 Supervised Closed Butterfly Valve	I-707
Series 709 Butterfly Valve	I-100
Series 712/712S Swinger Check Valve	I-100
Series 713 Swinger Check Valve	I-100
Series 716 Vic-Check Valve	I-100
Series 717 FireLock Check Valve	I-100
Series 717R FireLock Riser Check Valve	I-100
Series 723 Diverter Ball Valve	I-100
Series 726 Ball Valve	I-100
Series 728 FireLock Ball Valve	I-728
Series 730 Vic-Strainer® Tee Type	I-730/732/AGS
Series W730 AGS Vic-Strainer Tee Type	I-730/732/AGS



Product	Where to Find Instructions
Series 731-I Suction Diffuser	I-731I/W731I
Series W731-I AGS Suction Diffuser	I-731I/W731I
Series 732 Vic-Strainer Wye Type	I-730/732/AGS
Series W732 AGS Vic-Strainer Wye Type	I-730/732/AGS
Series 733 Venturi Indicator	I-100
Series 747M FireLock Zone Control Riser Module Assembly	I-747M
Series 763 Butterfly Valve	I-100
Series 779 Venturi Check Valve	I-100
Series 782/783 TA Bypass	Instructions Shipped with Valve
Series 785 TA TBVS Sweated-End Mini Circuit Balancing Valve	Instructions Shipped with Valve
Series 786 TA STAS Soldered-End Circuit Balancing Valve	Instructions Shipped with Valve
Series 787 TA STAD NPT Female Threaded Circuit Balancing Valve	Instructions Shipped with Valve
Series 788 TA STAF Flanged-End Circuit Balancing Valve	Instructions Shipped with Valve
Series 789 TA STAG Grooved-End Circuit Balancing Valve	Instructions Shipped with Valve
Vic-300 Butterfly Valve	I-100
Style 005 FireLock Rigid Coupling	I-100
Style 009/009V FireLock EZ™ Rigid Coupling	I-100
Style 07 Zero-Flex Rigid Coupling (1 – 12-inch/33.7 – 323.9-mm Sizes)	I-100
Style 07 Zero-Flex Rigid Coupling (14 – 24-inch/355.6 – 610.0-mm Sizes)	I-100 and IT-07
Style W07 AGS Rigid Coupling	I-100 and I-W07/W77
Style 22 Coupling for Vic-Ring Adapters and Shouldered-End Pipe	I-6000
Style 31 Coupling for AWWA Ductile Iron	I-300
Style 31 Coupling for Vic-Ring Adapters and Shouldered-End Pipe	I-6000
Style 41 Coupling for Vic-Ring Adapters and Shouldered-End Pipe	I-6000
Style 44 Coupling for Vic-Ring Adapters and Shouldered-End Pipe	I-6000
Style 72 Outlet Coupling	I-100
Style 74 OD Flexible Coupling	I-100
Style 75 Flexible Coupling	I-100
Style 77 Flexible Coupling	I-100
Style W77 AGS Flexible Coupling	I-100 and I-W07/W77



Product	Where to Find Instructions
Style 78 Snap-Joint Coupling	I-100
Style 89 Rigid Coupling for Stainless Steel	I-100 and IT-89
Style 99 Roust-A-Bout Coupling for Plain-End Steel	I-100 and IT-99
Style 107 QuickVic® Rigid Coupling for Steel Pipe	I-107 and I-100
Style 150 Mover Expansion Joint	Submittal 09.06
Style 155 Expansion Joint	Submittal 09.06
Style 307 Coupling for Grooved IPS Steel to Grooved AWWA Ductile Iron	I-300
Style 341 Vic-Flange Adapter for AWWA Ductile Iron	I-300
Style 441 Vic-Flange for Stainless Steel	I-100 and I-441
Style 475 Lightweight, Flexible Stainless Steel Coupling	I-100
Style 489 Rigid Coupling for Stainless Steel (1½ – 4-inch/48.3 – 114.3-mm Sizes)	I-100 and IT-489.2-4
Style 489 Rigid Coupling for Stainless Steel (6 – 12-inch and 139.7 – 318.5-mm Metric and JIS Sizes)	I-100 and IT-489
Style 606 Rigid Coupling for Copper Tubing	I-600
Style 607 QuickVic® Rigid Coupling for Copper Tubing	I-607 and I-600
Style 622 Mechanical-T® Bolted Branch Outlet for Copper Tubing	I-622 and I-600
Style 641 Vic-Flange Adapter for Copper Tubing	I-600
Style 707-IJ Transition Coupling for NPS to JIS	I-100
Style 720 TestMaster II Alarm Test Module	I-720
Style 720 TestMaster II Alarm Test Module with Pressure Relief Option	I-720PR
Style 730 Vic-Strainer Tee-Type	I-730/732
Style 731-G Suction Diffuser	I-731G
Style 732 Wye-Type Vic-Strainer	I-730/732
Style 733 Venturi Flow Metering Sensor	I-100
Style 734/734S Orifice/Indicator Flow Metering System	I-100
Style 735 Fire Pump Test Meter	I-100
Style 738 TA Portable Differential Meter	Instructions Shipped with Meter
Style 739 Portable Master Meter	Instructions Shipped with Meter



Product	Where to Find Instructions
Style 740 TA CBI Meter	Instructions Shipped with Meter
Style 741 IPS and Metric Vic-Flange Adapter	I-100
Style W741 AGS Vic-Flange Adapter	I-100 and IT-W741
Style 743 Vic-Flange Adapter	I-100
Style 744 FireLock Flange Adapter	I-100
Style 750 Reducing Coupling	I-100
Style 770 Large-diameter Coupling	I-100 and IT-770
Style 791 Vic-Boltless Coupling	I-100
Style 808 Duo-Lock Coupling	I-808
Style 920 and 920N Mechanical-T Outlets	I-100 and I-920N
Style 922 FireLock Outlet-T	I-100 and I-922
Style 923 Vic-Let Strapless Outlet	I-100 and I-923
Style 924 Vic-O-Well Strapless Thermometer Outlet	I-100
Style 926 Mechanical-T Spigot Assembly	I-100 and I-926
Style 931 Vic-Tap II Mechanical-T	VT-II
Style 994 Vic-Flange Adapter for HDPE	I-900 and IT-994
Style 995 Coupling for Plain-End IPS and Metric HDPE	I-900 and IT-995
Style 997 Transition Coupling for HDPE to Steel	I-900 and IT-997
Style 2970 Aquamine Coupling for Plain-end IPS PVC	IT-2970
Style 2971 Aquamine Transition Coupling for Plain-End IPS PVC to Plain-End HDPE	IT-2971
Style 2972 Aquamine Transition Coupling for Plain-End IPS PVC to Grooved IPS Steel	IT-2972
Style HP-70 Rigid Coupling (2 – 12-inch/60.3 – 323.9-mm Sizes)	I-100
Style HP-70 Rigid Coupling (14 – 16-inch/355.6 – 406.4-mm Sizes)	I-100 and IT-70
Style HP-70ES Rigid Coupling with EndSeal Gasket (2 – 12-inch/60.3 – 323.9-mm Sizes)	I-100

General Information

HAZARD IDENTIFICATION

Definitions for identifying the various hazard levels are provided below.



This safety alert symbol indicates important safety messages. When you see this symbol, be alert to the possibility of personal injury. Carefully read and fully understand the message that follows.

DANGER

- Use of the word “DANGER” identifies an immediate hazard with a likelihood of death or serious personal injury if instructions, including recommended precautions, are not followed.

WARNING

- Use of the word “WARNING” identifies the presence of hazards or unsafe practices that could result in death or serious personal injury if instructions, including recommended precautions, are not followed.

CAUTION

- Use of the word “CAUTION” identifies possible hazards or unsafe practices that could result in personal injury and product or property damage if instructions, including recommended precautions, are not followed.

NOTICE

- Use of the word “NOTICE” identifies special instructions that are important but not related to hazards.

INTRODUCTION

This field assembly and installation handbook is a basic field reference guide for Victaulic mechanical piping products for copper tubing. This handbook provides easy reference to proper installation information. In addition to this handbook, Victaulic offers the following handbooks for other products/materials:

- I-100 – Instructions for IPS and Metric Carbon Steel, Stainless Steel, and Aluminum Products
- I-300 – Instructions for AWWA Products
- I-500 – Instructions for Pressfit Products
- I-800 – Instructions for FireLock CPVC Sprinkler System Products
- I-900 – Instructions for HDPE Products

Additional copies of installation information are available from Victaulic, or Victaulic stocking distributors, upon request.

Always follow good piping practices. Specified pressures, temperatures, external loads, internal loads, performance standards, and tolerances must never be exceeded.

Many applications require recognition of special conditions, code requirements, and the use of safety factors. Qualified engineers should reference Section 26 of the Victaulic General Catalog (G-100) and Victaulic publication 05.01, “Gasket Selection Guide,” when determining requirements for special applications.



NOTICE

- Victaulic Company maintains a continual policy of product improvement. Therefore, Victaulic reserves the right to change product specifications, designs, and standard equipment without notice and without incurring obligation.
- Victaulic is not responsible for system design, nor does the Company assume any responsibility for systems that are designed improperly.
- This handbook is not intended to be a substitute for competent, professional assistance, which is a prerequisite for any product application.
- The information published in this handbook and other Victaulic literature supersedes all previously published information.
- Drawings and/or pictures in this manual may be exaggerated for clarity.
- The field assembly handbook contains trademarks, copyrights, and products with patented features that are the exclusive property of Victaulic Company.
- While every effort has been made to ensure its accuracy, Victaulic Company, its subsidiaries, and its affiliated companies make no expressed or implied warranty of any kind regarding the information contained or referenced in this handbook. Anyone who uses the information contained herein does so at their risk and assumes any liability that results from such use.

IMPORTANT INFORMATION

Victaulic Copper Connection products are designed for use only with the following types of copper tubing grooved to Victaulic specifications.

- K, L, M, and DWV Copper Tubing Size (CTS)
- Types A, B, and D Australian Standard (AS 1432)
- R250 (Half-Hard) European Standard (EN 1057) - **NOTE:** EN 1057 includes the former DIN Standard (DIN 1786) and British Standard (BS 2871) specifications

In addition, Victaulic Copper Connection mechanical couplings are designed for use only with Victaulic Copper Connection grooved-end fittings, valves, and related grooved-end components. Victaulic Copper Connection mechanical couplings are not intended for use with plain-end copper tubing and/or fittings.

Gaskets for Victaulic Copper Connection mechanical couplings must be lubricated for proper assembly. Lubrication prevents gasket pinching and assists installation. A thin coat of Victaulic Lubricant or another compatible material, such as silicone or soap-based lubricants, is required.

Victaulic gaskets are designed to perform in a wide range of temperatures and operating conditions. As with all installations, there is a direct relationship between temperature, continuity of service, and gasket life. Victaulic publication 05.01, "Gasket Selection Guide," must be referenced to determine gasket grade recommendations for each application.

Canadian Customers – Provincial Boilers and Pressure Vessels Acts: For piping applications that fall under the jurisdiction of the Provincial Boilers and Pressure Vessels Acts, intended users should obtain Victaulic Technical Sheet TS-226, which outlines approved services, products, pressure ratings, and temperature ratings.



OPERATOR SAFETY GUIDELINES FOR TOOLS

NOTICE

- Although Victaulic pipe preparation tools are manufactured for safe, dependable operation, it is impossible to anticipate all combinations of circumstances that could result in an accident. The following instructions are recommended for safe operation of Victaulic pipe preparation tools. Always refer to the specific operating and maintenance instructions manual for complete safety guidelines.

- 1. Read and understand the operating and maintenance instruction manual for the tool.** Read the supplied manual carefully before operating or performing maintenance on any tool. Become familiar with the tool's features, operations, applications, and limitations. Be particularly aware of its specific hazards. Store the operator's manual in a readily available location.
- 2. Secure the tool, power drive, and equipment.** Make sure that the tool and power drive are fastened securely to the floor.
- 3. Prevent accidental start-ups.** Place any power switches in the "OFF" position before plugging the tool into the electrical system. Always use a safety foot switch for the power source that is easily accessible to the operator.
- 4. Ground the power source.** Make sure the power source is connected to an internally grounded electrical system.
- 5. Operating environment.** Do not operate tools in damp locations. Wear hearing protection in noisy shop operations. Ensure the work area is well lit.
- 6. Wear proper clothing.** Do not wear unbuttoned jackets, loose sleeve cuffs, neckties, or anything else that can become tangled in moving parts. Always wear safety glasses and foot protection.
- 7. Stay alert.** Do not operate tools if you are drowsy from medication or fatigue. Avoid horseplay around the equipment, and keep bystanders a safe distance away from the equipment.
- 8. Inspect the equipment.** Before starting the tool, check all moveable parts for any obstructions. Make sure tool parts are installed and secured.
- 9. Keep work areas clean.** Keep the work area around the tool clear of obstructions that could limit the movement of the operator. Clean up all oil and coolant spills. Remove shavings from the tool to maintain proper operation.
- 10. Use supports for copper tubing.** For long sections of copper tubing and heavier work, use floor-mounted stands. Make sure that the work is secured properly in a vise that is fastened securely to the floor.
- 11. Operate the tool on the switch side only.** Operate tools with a safety foot switch located at an easily accessible area. Never reach across moving parts or material being worked on.
- 12. Do not misuse tools.** Perform only the functions for which the tool was designed. Do not force the tool. Do not operate the tool at speeds exceeding those specified in the operating and maintenance instructions manual.
- 13. Disconnect the power cord before servicing tools.** Only authorized personnel should attempt to service tools. Always disconnect the power source before servicing or making any adjustments.
- 14. Always maintain tools.** Keep tools clean and cutting tools sharp for safe, dependable operation. Follow all lubricating instructions. Report any unsafe conditions to authorized personnel for immediate correction.



COPPER TUBING PREPARATION

The Victaulic Copper Connection method for joining copper tubing is based upon the proper preparation of a groove to receive the housings' keys. The groove serves as a recess in copper tubing, which allows ample depth for secure engagement of the housing, yet ample wall thickness for full pressure rating.

Copper tubing must be prepared to Victaulic specifications that are outlined in this manual. Copper tubing must be roll grooved to the dimensions shown in the "Groove Dimensions" tables, using only Copper Connection roll sets.

Victaulic recommends square-cut copper tubing for use with Victaulic Copper Connection products.

WARNING



- **Before setting up and operating any Victaulic pipe preparation tools, read and understand the operating and maintenance instructions manual for the tool.**
- **Learn the operation, applications, and potential hazards peculiar to the tool.**

Failure to follow these instructions could cause improper product installation, resulting in serious personal injury and/or property damage.

TOOL RATINGS

The following table contains general information on tools that can be used to roll groove copper tubing. **REQUIREMENTS FOR VICTAULIC COPPER CONNECTION ROLL SETS MUST BE SPECIFIED AT THE TIME OF ORDER. ONLY COPPER CONNECTION ROLL SETS MUST BE USED TO GROOVE COPPER TUBING.** Certain tools are designed for high-use shop fabrication, while others are designed for field fabrication. For detailed information on tools, refer to Victaulic publication 24.01. For information about maintenance and operation of tools, refer to the applicable operating and maintenance instructions manual for the tool.

Roll Grooving Tool Ratings (Maximum Capacity) - ASTM B-88 Hard-Drawn Copper Tubing and DWV per ASTM B-306

Tool Model	Copper Tubing Size/Thickness						
	2	2½	3	4	5	6	8
VE106	K, L, M, & DWV						
VE266FS	K, L, M & DWV						
VE272FS	K, L, M & DWV						
VE272SFS	K, L, M, & DWV						
VE270FSD	K, L, M & DWV						
VE276FSD	K, L, M & DWV						
VE416FS	K, L, M & DWV						
VE416FSD	K, L, M & DWV						
VE26C	K, L, M & DWV						
VE226C	K, L, M & DWV						
VE268	K, L, M & DWV						
VE274	K, L, M & DWV						
VE414	K, L, M & DWV						

Roll Grooving Tool Ratings (Maximum Capacity) - European Standard EN 1057 R250 (Half-Hard)

Tool Model	Copper Tubing Size/Thickness							
	54	64	66.7	76.1	88.9	108	133	159
VE26EC								
VE226EC								
VE269								
VE271FSD	1.2 – 2.0	2.0	1.2 – 2.0	1.5 – 2.0	2.0	1.5 – 2.5	1.5 – 3.0	2.0 – 3.0
VE272SFS								
VE275								
VE277FSD								



Roll Grooving Tool Ratings (Maximum Capacity) - Australian Standard AS 1432

Tool Model	Copper Tubing Size/Thickness					
	DN 50 (50.8)	DN 65 (63.5)	DN 80 (76.2)	DN 100 (101.6)	DN 125 (127.0)	DN 150 (152.4)
VE26AC	Tables A, B, and D					
VE226AC	Tables A, B, and D					
VE269	Tables A, B, and D					
VE271FSD	Tables A, B, and D					
VE272SFS	Tables A, B, and D					
VE275	Tables A, B, and D					
VE277FSD	Tables A, B, and D					

COLOR-CODE IDENTIFICATION FOR CTS US STANDARD (ASTM B-88) HARD-DRAWN COPPER TUBING

CTS US Standard (ASTM B-88) Hard-Drawn Copper Tubing is marked as follows:

- Type K – Green
- Type L – Blue
- Type M – Red
- Type DWV – Yellow

COLOR-CODE IDENTIFICATION FOR AUSTRALIAN STANDARD (AS 1432) TABLES A, B, AND D COPPER TUBING

Australian Standard (AS 1432) Tables A, B, and D Copper Tubing is marked as follows:

- Type A – Green
- Type B – Blue
- Type D – Black

IDENTIFICATION FOR EUROPEAN STANDARD EN 1057 R250 (HALF-HARD) COPPER TUBING

Copper tubing to European Standard EN 1057 is marked *HH*, which is the identifier for half-hard temper (R250).

TUBING LENGTH REQUIREMENTS FOR GROOVING

The following table identifies the minimum tubing lengths that can be grooved safely by using Victaulic Grooving Tools. In addition, this table identifies the minimum tubing lengths that can be grooved without the use of a pipe stand. Tubing that exceeds the maximum lengths listed in this table require the use of a pipe stand. Always refer to the operating and maintenance manual for the applicable grooving tool for proper setup and grooving techniques.

CTS US Standard ASTM B-88 and DWV per ASTM B-306 Copper Tubing Size	Tubing Length inches/mm	
	Minimum	Maximum
Nominal Size inches/Actual mm		
2 54.0	8 205	36 915
2½ 66.7	8 205	36 915
3 79.4	8 205	36 915
4 104.8	8 205	36 915
5 130.2	8 205	32 815
6 155.6	10 255	28 715
8 206.4	10 255	24 610

Copper Tubing Size		Tubing Length millimeters	
European Standard Nominal Size mm	Australian Standard Nominal Size (Actual Size)	Minimum	Maximum
54	DN 50 (50.8)	205	915
64	DN 65 (63.5)	205	915
66.7		205	915
76.1	DN 80 (76.2)	205	915
88.9		205	915
108	DN 100 (101.6)	205	915
133	DN 125 (127.0)	205	815
159	DN 150 (152.4)	255	715

If tubing is required that is shorter than the minimum length listed in this table, shorten the next-to-last piece so that the last piece is as long (or longer) than the minimum length specified. **EXAMPLE:** A 20-foot, 4-inch/6.2-m length of 6-inch/155.6-mm diameter copper tubing is required to finish a section and only 20-foot/6.1-m lengths are available. Instead of roll grooving a 20-foot, 6.1-m length of copper tubing and a 4-inch/102-mm length of copper tubing, follow these steps:

1. Refer to the table above, and note that for 6-inch/155.6-mm diameter copper tubing, the minimum length that should be roll grooved is 10 inches/255 mm.
2. Roll groove a 19-foot, 6-inch/5.9-m length of copper tubing and a 10-inch/255-mm length of copper tubing.



EXPLANATION OF CRITICAL ROLL GROOVE DIMENSIONS

WARNING

- Copper tubing dimensions and groove dimensions must be within the tolerances specified in the charts on the following pages. Failure to follow these specifications could cause joint failure, resulting in serious personal injury and property damage.

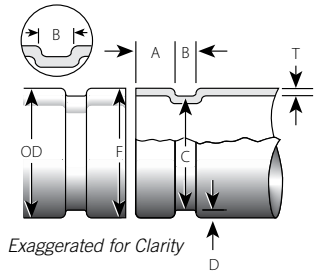

Copper Tubing Outside Diameter – The average copper tubing outside diameter must not vary from the specifications listed in the tables on the following pages. Maximum allowable tubing ovality should not vary by more than 1%. Greater variations between the major and minor diameters will result in difficult coupling assembly.

“A” Dimension – The “A” dimension, or the distance from the end of the copper tubing to the groove, identifies the gasket seating area. This area must be free from indentations, projections, and roll marks from the end of the copper tubing to the groove to provide a leak-tight seal. All foreign material, such as oil, grease, chips, and dirt must be removed.

“B” Dimension – The “B” dimension, or groove width, controls expansion and angular deflection by the distance it is located from the end of the copper tubing and its width in relation to the housings’ “key” width. The bottom of the groove must be free from all foreign material that may interfere with proper coupling assembly.

“C” Dimension – The “C” dimension is the proper diameter at the base of the groove. This dimension must be within the diameter’s tolerance and concentric with the OD for proper coupling fit. The groove must be of uniform depth for the entire circumference of the copper tubing.

“D” Dimension – The “D” dimension is the normal depth of the groove and is a reference for a “trial groove” only. Variations in the OD of copper tubing affect this dimension and must be altered, if necessary, to keep the “C” dimension within tolerance. The groove must conform to the “C” dimension described above.

“F” Dimension – Maximum allowable flare diameter is measured at the extreme copper tubing end diameter. **NOTE:** This applies to average (pi tape) and single-point readings.

“T” Dimension – The “T” dimension is the lightest grade (minimum, nominal wall thickness) of copper tubing that is suitable for roll grooving.

NOTICE

- Coatings that are applied to the interior surfaces of Victaulic couplings must not exceed 0.010 inch/0.25 mm. This includes the bolt pad mating surfaces.

GROOVE DIMENSIONS

CTS US Standard – ASTM B-88 Hard-Drawn Copper Tubing and DWV per ASTM B-306

Copper Tubing Size		Dimensions – inches/mm																						
		Copper Tubing Outside Diameter †		Gasket Seat "A"		Groove Width "B"		Groove Diameter "C"		Groove Depth "D" (Ref. Only)		Min. Allow. Wall Thick. "T"	Max. Allow. Flare Dia. "F"											
Nominal Size inches/Actual mm	Max.	Min.	Basic	Max.	Min.	Max.	Min.	Max.	Min.	Max.	Max.	Min.	Max.	Min.	Max.									
2	2.127	2.123	0.610	0.640	0.580	0.330	0.300	2.029	2.009	0.048	DWV*	2.220	54.0	54.0	53.9	15.5	16.3	14.7	8.4	7.6	51.5	51.0	1.2	56.4
2½	2.627	2.623	0.610	0.640	0.580	0.330	0.300	2.525	2.505	0.050	0.065	2.720	66.7	66.6	66.6	15.5	16.3	14.7	8.4	7.6	64.1	63.6	1.2	69.1
3	3.127	3.123	0.610	0.640	0.580	0.330	0.300	3.025	3.005	0.050	DWV*	3.220	79.4	79.3	79.3	15.5	16.3	14.7	8.4	7.6	76.8	76.3	1.2	81.8
4	4.127	4.123	0.610	0.640	0.580	0.330	0.300	4.019	3.999	0.053	DWV*	4.220	104.8	104.7	104.7	15.5	16.3	14.7	8.4	7.6	102.1	101.6	1.4	107.2
5	5.127	5.123	0.610	0.640	0.580	0.330	0.300	4.999	4.979	0.063	DWV*	6.220	130.2	130.1	130.1	15.5	16.3	14.7	8.4	7.6	127.0	126.5	1.6	132.6
6	6.127	6.123	0.610	0.640	0.580	0.330	0.300	5.999	5.979	0.063	DWV*	6.220	155.6	155.5	155.5	15.5	16.3	14.7	8.4	7.6	152.3	151.9	1.6	158.0
8	8.127	8.121	0.610	0.640	0.580	0.330	0.300	7.959	7.939	0.083	DWV*	8.220	206.4	206.3	206.3	15.5	16.3	14.7	8.4	7.6	202.2	201.7	2.1	208.8

† The outside diameter of roll grooved copper tubing cannot vary from the tolerance listed. The maximum allowable tolerance from square cut ends is 0.030inch/0.8mm for 2 – 3-inch/ 54.0 – 79.4-mm sizes and 0.045inch/1.1 mm for 4 – 6-inch/104.8 – 155.6-mm sizes; this is measured from the true square line.

* ASTM B-306 drain-waste and vent (DWV) is the minimum wall thickness of copper tubing that can be roll grooved.



GROOVE DIMENSIONS

European Standard – EN 1057 R250 (Half-Hard) Copper Tubing

European Standard Copper Tubing Nominal Size † mm		Dimensions – mm/inches												Max. Allow. Flare Dia. "F"
		Actual OD*		Gasket Seat "A"		Groove Width "B"		Groove Diameter "C"		Groove Depth "D" (Ref. Only)	Max. Allow. Flare Dia. "F"			
		Max.	Min.	Basic	Max.	Min.	Max.	Min.	Max.			Min.		
54	54.07 2.129	53.93 2.123	15.87 0.625	16.64 0.655	15.11 0.595	8.38 0.330	7.62 0.300	51.01 2.008	51.51 2.028	1.25 0.049	56.38 2.220			
64	64.07 2.522	63.93 2.517	15.87 0.625	16.64 0.655	15.11 0.595	8.38 0.330	7.62 0.300	60.96 2.400	61.47 2.420	1.27 0.050	66.41 2.615			
66.7	66.77 2.629	66.63 2.623	15.87 0.625	16.64 0.655	15.11 0.595	8.38 0.330	7.62 0.300	63.63 2.505	64.14 2.525	1.27 0.050	69.09 2.720			
76.1	76.17 2.999	76.03 2.993	15.87 0.625	16.64 0.655	15.11 0.595	8.38 0.330	7.62 0.300	72.90 2.870	73.41 2.890	1.35 0.053	78.61 3.095			
88.9	88.97 3.503	88.83 3.497	15.87 0.625	16.64 0.655	15.11 0.595	8.38 0.330	7.62 0.300	85.19 3.354	85.70 3.374	1.60 0.063	91.63 3.607			
108	108.07 4.255	107.93 4.249	15.87 0.625	16.64 0.655	15.11 0.595	8.38 0.330	7.62 0.300	104.29 4.106	104.80 4.126	1.60 0.063	110.54 4.352			
133	133.20 5.244	132.80 5.228	15.87 0.625	16.64 0.655	15.11 0.595	8.38 0.330	7.62 0.300	128.78 5.070	129.29 5.090	1.85 0.073	135.79 5.346			
159	159.20 6.280	158.80 6.252	15.87 0.625	16.64 0.655	15.11 0.595	8.38 0.330	7.62 0.300	154.79 6.094	155.30 6.114	1.85 0.073	161.80 6.370			

† European Standard Copper Tubing: Nominal EN 1057 drawn copper tubing size

* The outside diameter of roll grooved copper tubing cannot vary from the tolerance listed. The maximum allowable tolerance from square cut ends is 0.8mm/0.030inch for 54 – 88.9-mm sizes and 1.1 mm 0.045inch for 108 – 159-mm sizes; this is measured from the true square line.



GROOVE DIMENSIONS

Australian Standard – AS 1432 Tables A, B, and D Copper Tubing

Dimensions – mm/inches

Australian Standard Copper Tubing Nominal Size (Actual Size)	Actual OD*		Gasket Seat "A"		Groove Width "B"		Groove Diameter "C"		Groove Depth "D" (Ref. Only)	Max. Allow. Flare Dia. "F"
	Max.	Min.	Basic	Max.	Min.	Max.	Min.	Max.		
	mm	mm	mm	mm	mm	mm	mm	mm		
DN 50 (50.8)	50.80	50.67	15.87	16.64	15.11	8.38	7.62	48.21	1.25	53.06
	2.000	1.995	0.625	0.655	0.595	0.330	0.300	1.898	0.049	2.089
DN 65 (63.5)	63.50	63.35	15.87	16.64	15.11	8.38	7.62	60.88	1.27	65.38
	2.500	2.494	0.625	0.655	0.595	0.330	0.300	2.397	0.050	2.592
DN 80 (76.2)	76.20	76.02	15.87	16.64	15.11	8.38	7.62	73.56	1.27	78.51
	3.000	2.993	0.625	0.655	0.595	0.330	0.300	2.896	0.050	3.091
DN 100 (101.6)	101.60	101.35	15.87	16.64	15.11	8.38	7.62	98.78	1.35	103.88
	4.000	3.990	0.625	0.655	0.595	0.330	0.300	3.889	0.053	4.090
DN 125 (127.0)	127.00	126.75	15.87	16.64	15.11	8.38	7.62	123.67	1.60	128.77
	5.000	4.990	0.625	0.655	0.595	0.330	0.300	4.869	0.063	5.070
DN 150 (152.4)	152.40	152.10	15.87	16.64	15.11	8.38	7.62	149.05	1.60	154.66
	6.000	5.988	0.625	0.655	0.595	0.330	0.300	5.868	0.063	6.089

† Nominal AS 1432 drawn copper tubing size

* The outside diameter of roll grooved copper tubing cannot vary from the tolerance listed. The maximum allowable tolerance from square cut ends is 0.8mm/0.030inch for DN 50 – 80-mm sizes and 1.1mm/0.045inch for DN 100 – 150-mm sizes; this is measured from the true square line.

GASKET SELECTION

! CAUTION

- To ensure maximum gasket performance, always specify the proper gasket grade for the intended service. Failure to select the proper gasket for the service may cause joint failure, resulting in property damage.

Many factors must be considered for optimum gasket performance. Do not subject gaskets to temperatures beyond the recommended limits, since excessive temperatures will degrade gasket life and performance.

The services listed below are general service recommendations, and they apply only to Victaulic gaskets. Recommendations for a particular service do not necessarily imply compatibility of the coupling housings, related fittings, or other components for the same service. Always refer to the latest Victaulic Gasket Selection Guide (05.01) for gasket service recommendations.

NOTE: These recommendations do not apply to rubber-lined valves or other rubber-lined products. Refer to the applicable product literature, or contact Victaulic for recommendations.

Standard Gaskets for Victaulic Copper Connection Products

Grade	Temp. Range	Compound	Color Code †	General Service Recommendation
E	-30°F/-34°C to +230°F/+110°C	EPDM	Green Stripe	Recommended for hot water service within the specified temperature range, plus a variety of dilute acids, oil-free air, and many chemical services. UL classified in accordance with ANSI/NSF 61 for cold +86°F/+30°C and hot +180°F/+82°C potable water service. NOT RECOMMENDED FOR PETROLEUM SERVICES.
EHP@	-30°F/-34°C to +250°F/+120°C	EPDM	Red Stripe	Recommended for hot water service within the specified temperature range. UL classified in accordance with ANSI/NSF 61 for cold +86°F/+30°C and hot +180°F/+82°C potable water service. NOT RECOMMENDED FOR PETROLEUM SERVICES.
T	-20°F/-29°C to +180°F/+82°C	Nitrile	Orange Stripe	Recommended for petroleum products, hydrocarbons, air with oil vapors, vegetable oil, and mineral oil, within the specified temperature range. NOT RECOMMENDED FOR HOT WATER SERVICES OVER +150°F/+66°C OR FOR HOT, DRY AIR OVER +140°F/+60°C.
L	-30°F/-34°C to +350°F/+177°C	Silicone	Red Gasket	Recommended for dry heat, air without hydrocarbons to +350°F, and certain chemical services.

† Gaskets for Copper Connection Products have a copper-colored stripe in addition to the stripe for the color code

@ The Grade EHP gasket is available only for QuickVic® Rigid Couplings



LUBRICATION

Lubrication of the gasket exterior/gasket sealing lips or the housings' interiors/ copper tubing ends is essential to prevent gasket pinching. Lubrication also eases installation of the gasket onto the end of the copper tubing. Use Victaulic Lubricant or another compatible material, such as silicone, on Grade "E" and Grade "L" gaskets. Refer to Victaulic publication 05.02 for the Vic-Lube MSDS sheet.

Canadian Customers – Canadian WHMIS Requirements: Canadian customers should contact Victaulic Company of Canada for a Vic-Lube MSDS sheet that meets Canadian WHMIS requirements.

VICTAULIC LUBRICANT USAGE GUIDE

The following table provides approximations for the number of gaskets that can be lubricated with a 4.5-ounce/125-gram tube or a 1-quart/32-ounce/907-gram container of Victaulic Lubricant. **NOTE:** Victaulic Lubricant has full WRAS approval (Approval No. 0507514).

Copper Tubing Size		Number of Gaskets	
CTS US Standard Nominal Size inches/Actual mm	Per 4.5-ounce Tube		Per Quart
	2 60.3	55	
3 88.9	36	270	
4 114.3	26	200	
6 168.3	17	125	
8 219.1	13	100	

Copper Tubing Size		Number of Gaskets	
European Standard Nominal Size mm	Australian Standard Nominal Size (Actual Size)	Per 125-gram Tube	Per 32-ounce (907-gram) Container
54	DN 50 (50.8)	55	400
64 66.7	DN 65 (63.5)	55	400
76.1 88.9	DN 80 (76.2)	36	270
108	DN 100 (101.6)	26	200
133	DN 125 (127.0)	17	125
159	DN 150 (152.4)	13	100



SPACING REQUIREMENTS FOR VICTAULIC COPPER CONNECTION SYSTEMS

Since the Victaulic Copper Connection joining method incorporates externally mounted housings, consideration must be given to external dimensions beyond the OD of the copper tubing. **NOTE:** Allowance for insulation, when necessary, is not included in the following examples.

Recommended Minimum Copper Tubing Spacing

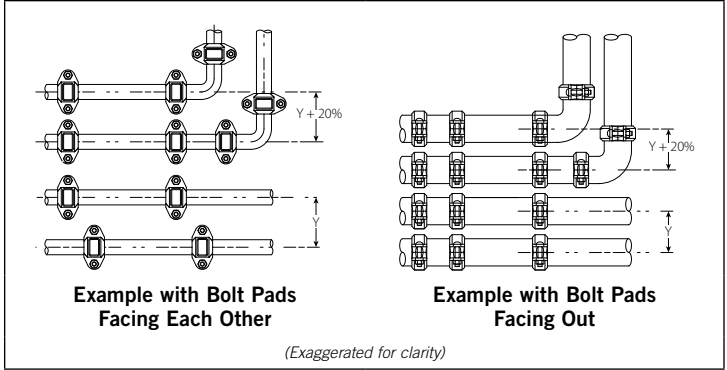

To allow for easy installation, insulation, and maintenance, consideration must be given to proper spacing between copper tubing. Since Victaulic Copper Connection Couplings are externally mounted housings that contain bolt pads, allow enough access space to tighten the bolts. In addition, provide enough space to prevent interference between copper tubing and adjacent couplings.

The centerline of the copper tubing must be spaced with the width of the coupling housings (“Y” dimension) for systems where couplings are staggered. Add an additional 20% to the width (Y) when couplings are in line, as shown above.

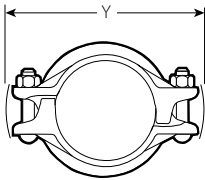

NOTE: The “Y” dimension is the maximum dimension across the coupling. Bolt pads can be positioned in any orientation to provide adequate clearance if the orientation shown causes interference with other system components.

External Clearance Allowance

When installing Victaulic Copper Connection systems in confined areas, such as a shaft, a tunnel, a narrow trench, or when assembling risers and dropping them through riser holes, consideration must be given to the external clearance of the housings. This clearance must be slightly greater than the “Y” dimension of the widest point. The necessary clearance will vary depending upon installation procedures, the proximity of other copper tubing, and other factors.

INSTALLATION OF VICTAULIC COPPER CONNECTION PRODUCTS TO ACCOMMODATE THERMAL EXPANSION AND/OR CONTRACTION

The following is a brief overview of methods to accommodate expansion and/or contraction in Victaulic Copper Connection systems. Refer to Section 26 of the Victaulic General Catalog (G-100) for details.

Copper tubing expands and contracts with temperature changes; therefore, the pipeline can buckle or bend when it expands, unless compensation for expansion and contraction is built into the system.

Expansion loops prevent harmful stresses, buckling, and bending. Expansion loops, or "U" bends, are frequently used to accommodate thermal expansion and/or contraction.

The following table provides information on calculating thermal expansion and contraction of 100-foot/31-m lengths of copper tubing. The following method may be used to size and construct expansion loops using Style 606 Couplings and No. 610 Copper 90° Elbows.

Temperature °F/°C	Expansion/ Contraction of Copper inches/mm	Temperature °F/°C	Expansion/ Contraction of Copper inches/mm	Temperature °F/°C	Expansion/ Contraction of Copper inches/mm
-40 -40	-0.421 -10.7	60 16	0.684 17.4	180 82	2.051 52.1
-20 -29	-0.210 -5.3	80 27	0.896 22.8	200 93	2.296 58.3
0 -18	0 0	100 38	1.134 28.8	212 100	2.428 61.7
20 -7	0.238 6.1	120 49	1.366 34.7	220 104	2.516 63.9
32 0	0.366 9.3	140 60	1.590 40.4	230 110	2.636 67.0
40 4	0.451 11.5	160 71	1.804 45.8		



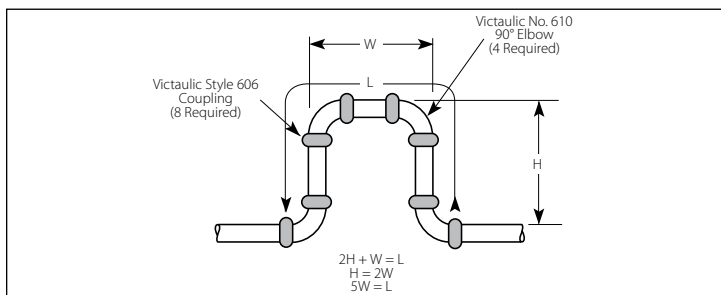

Calculated Loop Lengths for Various Expansions

Expansion inches/mm	Loop Length "L" for Copper Tubing Sizes Shown Nominal Size inches/mm						
	2 50	2½ 65	3 80	4 100	5 125	6 150	8 200
½ 12.7	91 2311	102 2591	111 2819	127 3226	142 3607	155 3937	178 4521
1 25.4	129 3277	144 3658	157 3988	180 4572	200 5080	219 5563	252 6401
1½ 38.1	158 4013	176 4470	192 4877	220 5588	245 6223	268 6807	309 7849
2 50.8	182 4623	203 5156	221 5613	254 6452	283 7188	310 7874	356 9042
2½ 65.5	204 5182	227 5766	247 6274	284 7214	317 8052	346 8788	398 10109
3 76.2	223 5664	248 6299	271 6883	311 7899	347 8814	379 9627	436 11074

NOTE: The expansion loop should be located between two anchors, and the copper tubing should be guided to direct movement into the loop.

EXAMPLE:

The necessary length of the copper-tubing expansion loop can be calculated by using the following formula:

$$L = \sqrt{\frac{3 E D e}{S}} \quad (1)$$

or simplified,

$$L = 88.32 \sqrt{D e} \quad (2)$$

where:

L = Loop Length in inches (shown in the figure to the left)

E = Modulus of Elasticity of Copper (15,600,000 psi)

S = Allowable Stress of Material in Flexure (6,000 psi)

D = Outside Diameter of Copper Tubing (inches)

e = Amount of Expansion to be Absorbed (inches)

References:

Equation 1 – *Copper/Brass/Bronze Product Handbook*, Copper Development Association, Inc.

Equation 2 – *Source Book of Copper and Copper Alloys*, American Society for Metals



SUPPORT SPACING FOR VICTAULIC COPPER CONNECTION SYSTEMS

Copper tubing that is joined with Victaulic Copper Connection products requires support to carry the weight of copper tubing and equipment. The support or hanging method must eliminate stress on joints, copper tubing, and other components. In addition, the method of support must allow pipeline movement, where required, along with other design requirements, such as drainage. The system designer must consider any special requirements while designing the support system.

The following table lists the suggested maximum span between supports for straight, horizontal runs of copper tubing, joined with Victaulic Copper Connection Couplings, that carry water or other similar liquids.

NOTICE

- **These values are not intended to be used as specifications for all installations, and they DO NOT apply where critical calculations are made or where there are concentrated loads between supports.**
- **Victaulic Company is not responsible for system design, nor does the Company assume any responsibility for systems that are designed improperly.**

CTS US Standard

CTS US Standard Copper Tubing Size	Suggested Maximum Span Between Supports – feet/meters		
	Water Service		Gas or Air Service
	B 31.9†	NFPA‡	B 31.9†
Nominal Size inches/Actual mm			
2 54.0	8 2.4	12 3.7	10 3.1
2½ 66.7	10 3.1	12 3.7	11 3.4
3 79.4	10 3.1	12 3.7	12 3.7
4 104.8	12 3.7	15 4.6	14 4.3
5 130.2	13 4.0	15 4.6	15 4.6
6 155.6	15 4.6	15 4.6	17 5.2
8 206.4	15 4.6	15 4.6	17 5.2

† Spacing corresponds to ASME B 31.9

‡ Spacing corresponds to NFPA 13



European Standard - EN 1057

Copper Tubing Size	Suggested Maximum Span Between Supports
European Standard Nominal Size mm	meters
54	2.7
64	3.0
66.7	3.0
76.1	3.0
88.9	3.0
108	3.0
133	3.0
159	3.6

Australian Standard - AS 1432

Copper Tubing Size	Suggested Maximum Span Between Supports
Australian Standard Nominal Size (Actual Size)	meters
DN 50 (50.8)	3.0
DN 65 (63.5)	3.0
DN 80 (76.2)	3.5
DN 100 (101.6)	3.5
DN 125 (127.0)	4.0
DN 150 (152.4)	4.0

VICTAULIC COPPER CONNECTION PRODUCT INSTALLATION GUIDELINES



WARNING



- **Depressurize and drain the piping system before attempting to install, remove, or adjust any Victaulic piping products.**

Failure to follow this instruction could result in serious personal injury, property damage, product damage, joint leakage, and/or joint failure.

The following instructions are a general guideline for the installation of Victaulic Copper Connection products. These instructions must be followed to ensure proper joint assembly.

1. Always check the gasket to make sure it is suitable for the intended service. Refer to the "Gasket Selection" section for details.
2. Valve bodies, discs, and other wetted components must be compatible with the material flowing through the system. Refer to the most current Victaulic literature, or contact Victaulic for details.
3. Always read the operating and maintenance instruction manuals for the copper tubing preparation tools.
4. The outside diameter and grooving dimensions of copper tubing must be within published tolerances; these tolerances are subject to specific standards for acceptability. Refer to copper tubing preparation specifications in this manual for details.
5. For rigid, angle-bolt-pad couplings, the nuts must be tightened evenly by alternating sides until metal-to-metal contact occurs at the bolt pads. In addition, there must be equal offset at the bolt pads.
6. ClearFlow* dielectric waterways should be used at transitions between copper to steel piping components.
7. When mating Style 641 Vic-Flange Adapters to iron or steel body components, a Type F (phenolic) Vic-Flange Washer and a commercial flange gasket must be used. In addition, good piping practice dictates the use of commercially available bolt-isolation kits.

*ClearFlow is a registered trademark of Perfection Corporation



INSTALLATION INSPECTION

⚠ WARNING



- Always inspect each joint to ensure that the product was properly installed.
- Undersized or oversized copper tubing/ fittings, shallow grooves, eccentric grooves, bolt pad gaps, etc. are unacceptable. Any of these conditions must be corrected before attempting to pressurize the system.

Failure to follow these instructions could cause joint failure, resulting in serious personal injury and property damage.

Proper Installation

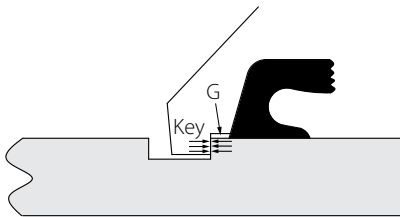

PROPER INSTALLATION

Exaggerated for Clarity

Proper copper tubing preparation and Victaulic Copper Connection Coupling installation is essential for maximum joint performance. **THE FOLLOWING CONDITIONS MUST BE PRESENT TO ENSURE PROPER JOINT ASSEMBLY.**

1. The OD of the copper tubing and groove dimensions must be within the tolerance published in current Victaulic grooving specifications.
2. Victaulic Copper Connection Couplings **MUST** be properly assembled with the bolt pads in firm, metal-to-metal contact.
3. The housings' keys must be fully engaged against the face of the groove.
4. The gasket must be slightly compressed, which adds to the strength of the seal.



Installations with Undersized Copper Tubing/Fittings – NOT ACCEPTABLE

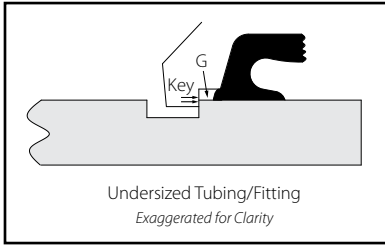

When the OD of the copper tubing or fitting is below tolerance, engagement of the housings' key sections is considerably lowered. **THIS RESULTS IN REDUCED WORKING PRESSURE FOR THE JOINT.**

Additionally, there is little or no added compression of the gasket. The increased gap "G" between the copper tubing and the housing may also result in gasket extrusion. These factors can contribute to reduced gasket life and joint leakage.

Installations with Oversized Copper Tubing/Fittings – NOT ACCEPTABLE

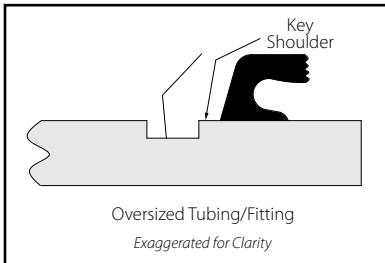

When the OD of the copper tubing or fitting exceeds the allowable tolerance, engagement of the housings' key sections is increased to the point that the shoulder can grip onto the copper tubing. Under these conditions, the bolt pads cannot join with metal-to-metal contact, the gasket may extrude, the working pressure of the joint may be reduced, and gasket life may be reduced.

Installations on Copper Tubing with Shallow Grooves – NOT ACCEPTABLE

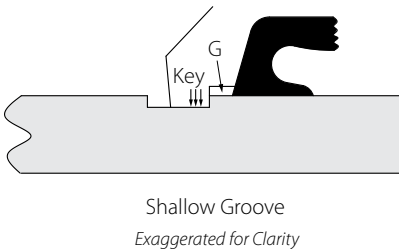

A groove that is not deep enough will have the same effect as the conditions described in the previous "Installations with Undersized Copper Tubing/Fittings" section.

Installations on Copper Tubing with Deep Grooves – NOT ACCEPTABLE

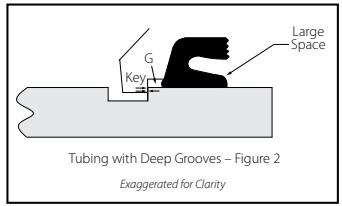
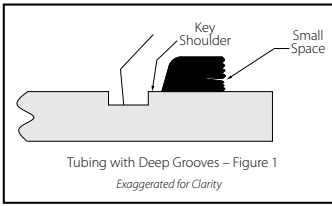

A groove that is too deep will allow the coupling to shift so that one housing will have full key engagement (Figure 1 above) and the other housing will have significantly reduced key engagement (Figure 2 above). This will have the same effect as the conditions described in the previous “Installations with Undersized Copper Tubing/Fittings” section. Additionally, roll grooving copper tubing to an undersized dimension may overstress and weaken the wall of the copper tubing.

Installations on Copper Tubing with Eccentric Grooves – NOT ACCEPTABLE

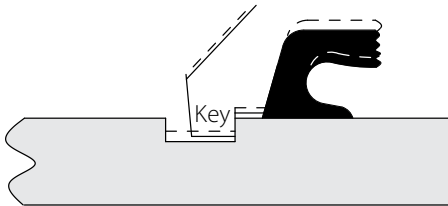

Eccentric Groove

Exaggerated for Clarity

Eccentric grooves generally occur because of out-of-round copper tubing that is grooved with a stationary tool bit (such as a lathe). Tools that rotate the copper tubing, rather than rotate around the copper tubing, may affect this condition. An eccentric groove means that the groove is too shallow on one side and too deep on the other. This may lead to a combination of the conditions outlined in the previous “Installations with Oversized Copper Tubing/Fittings” and “Installations on Copper Tubing with Shallow Grooves” sections.

Bolt Pad Gaps – NOT ACCEPTABLE

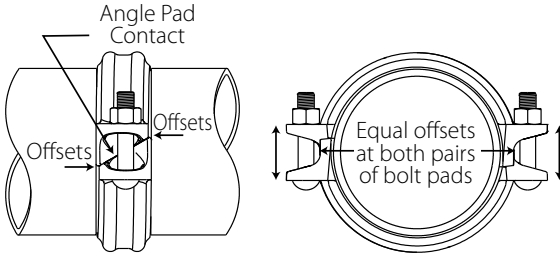

Exaggerated for Clarity

Victaulic Copper Connection Couplings MUST always be assembled with the bolt pads in firm, metal-to-metal contact. If you have any questions concerning an installation, contact Victaulic.

If the bolt pads are not in full metal-to-metal contact:

1. Make sure coupling keys are engaged in the grooves. Coupling keys must not rest on the outside surface of the copper tubing.
2. Make sure the bolts have been tightened fully.
3. Make sure the gasket is not pinched. If the gasket is pinched, replace it immediately.
4. Make sure oversized copper tubing or fittings were not used.
5. Make sure the groove conforms to Victaulic specifications. If the groove is shallow, groove the copper tubing to Victaulic specifications. If the groove is too deep, discard that section of copper tubing, and groove another section to Victaulic specifications.
6. Always re-inspect joints before and after the field test to identify points of possible failure. Look for gaps at the bolt pads and/or keys that ride up on the shoulders. If any of these conditions exist, depressurize the system, and replace any questionable joints.

NOTICE

- **A SUCCESSFUL INITIAL SYSTEM PRESSURE TEST DOES NOT VALIDATE PROPER INSTALLATION AND IS NOT A GUARANTEE OF LONG-TERM PERFORMANCE.**
- **Victaulic will not assume any liability for pipe joint leakage or failure that may result from an installer's failure to follow Victaulic Company's installation instructions.**
- **As with any pipe joining method, success is determined by close attention to details. Careful adherence to the instructions found in this handbook is critical to ensure maximum system reliability.**

Couplings for Grooved-End Copper Tubing

Installation Instructions



Style 606 Coupling



Style 607 QuickVic® Coupling

Style 606
Rigid Coupling

! WARNING



- Read and understand all instructions before attempting to install any Victaulic piping products.
 - Depressurize and drain the piping system before attempting to install, remove, or adjust any Victaulic piping products.
 - Wear safety glasses, hardhat, and foot protection during installation.
- Failure to follow these instructions could result in serious personal injury, improper product installation, and/or property damage.



1. CHECK COPPER TUBING ENDS:

The outside surface of the copper tubing, between the groove and the tubing end, must be smooth and free from indentations, projections, and roll marks to provide a leak-tight seal. All oil, grease, dirt, and cutting particles must be removed. Measurements taken across grooved tubing ends must not exceed the maximum allowable flare diameter. Refer to current Victaulic specifications for the maximum allowable flare diameter.



2. CHECK GASKET: Check the gasket to make sure it is suitable for the intended service. Victaulic Copper Connection gaskets contain two marks: the copper-colored mark identifies that the gasket is specifically for Victaulic Copper Connection products, and the other mark identifies the gasket grade.

! CAUTION

- Always use a compatible lubricant to prevent the gasket from pinching or tearing during installation.
- Failure to follow this instruction could result in joint leakage.



3. LUBRICATE GASKET: Apply a thin coat of Victaulic Lubricant or silicone lubricant to the gasket lips and exterior.



4. INSTALL GASKET: Install the gasket over one end of the copper tubing. Make sure the gasket lip does not overhang the end of the copper tubing.





5. JOIN COPPER TUBING ENDS: Align and bring the two copper tubing ends together. Slide the gasket into position, and make sure it is centered between the grooves. **NOTE:** Make sure no portion of the gasket extends into the grooves in the copper tubing.



6. ASSEMBLE HOUSINGS: Insert one bolt into the housings, and thread the nut loosely onto the bolt (nut should be flush with end of bolt) to allow for the “swing-over” feature.

6a. INSTALL HOUSINGS: Using the “swing-over” feature, install the housings over the gasket. Make sure the housings’ keys engage the grooves properly on both sections of copper tubing.



CAUTION

- Make sure the gasket does not become rolled or pinched while installing the housings. Failure to follow this instruction could cause damage to the gasket, resulting in joint leakage.



7. INSTALL REMAINING BOLT/ NUT: Install the remaining bolt, and thread the nut finger-tight onto the bolt. Make sure the oval neck of the bolts seat properly in the bolt holes.



8. TIGHTEN NUTS: Tighten all nuts evenly by alternating sides until metal-to-metal contact occurs at the angle bolt pads. Make sure the housings’ keys completely engage the grooves. Make sure the offsets are equal at the bolt pads. This is necessary to ensure a rigid joint (refer to the example above). **NOTE:** It is important to tighten all nuts evenly to prevent gasket pinching.

9. Visually inspect the bolt pads at each joint to ensure metal-to-metal contact is achieved.



WARNING

- For Victaulic rigid, angle-bolt-pad couplings, the nuts must be tightened evenly by alternating sides until metal-to-metal contact occurs at the bolt pads.
- For Victaulic rigid, angle-bolt-pad couplings, equal offsets must be present at the bolt pads.
- Keep hands away from coupling openings during tightening.

Failure to follow these instructions could cause joint failure, serious personal injury, and property damage.

Style 606 Helpful Information

CTS US Standard Copper Tubing Size	Nut Size	Socket Size
Nominal Size inches/Actual mm	inches	inches
2 54.0	$\frac{3}{8}$	$1\frac{1}{16}$
2½ 66.7	$\frac{3}{8}$	$1\frac{1}{16}$
3 79.4	$\frac{1}{2}$	$\frac{7}{8}$
4 104.8	$\frac{5}{8}$	$1\frac{1}{16}$
5 130.2	$\frac{5}{8}$	$1\frac{1}{16}$
6 155.6	$\frac{5}{8}$	$1\frac{1}{16}$
8 206.4	$\frac{5}{8}$	$1\frac{1}{16}$

Copper Tubing Size		Nut Size	Socket Size
European Standard Copper Tubing Nominal Size	Australian Standard Copper Tubing Nominal Size (Actual Size)	Metric	Metric
54	DN 50 (50.8)	M10	17
64	DN 65 (63.5)	M10	17
66.7			
76.1	DN 80 (76.2)	M12	22
88.9			
108	DN 100 (101.6)	M12	22
133	DN 125 (127.0)	M16	27
159	DN 150 (152.4)	M16	27

Style 607

QuickVic® Rigid Coupling

WARNING



- Read and understand all instructions before attempting to install any Victaulic piping products.
 - Depressurize and drain the piping system before attempting to install, remove, or adjust any Victaulic piping products.
 - Wear safety glasses, hardhat, and foot protection during installation.
- Failure to follow these instructions could result in serious personal injury, improper product installation, and/or property damage.

INSTRUCTIONS FOR THE INITIAL INSTALLATION OF STYLE 607 COUPLINGS

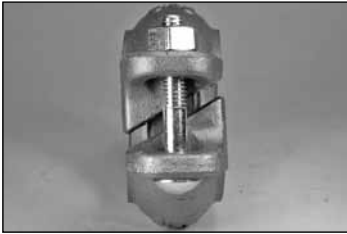

1. DO NOT DISASSEMBLE THE COUPLING: Style 607 Couplings are installation ready. The coupling is designed so that the installer does not need to remove the bolts and nuts for installation. This design facilitates installation by allowing the installer to “stab” the grooved end of copper mating components into the coupling.

2. CHECK COPPER MATING COMPONENT ENDS: The outside surface of the copper mating components, between the groove and the mating component ends, must be smooth and free from indentations, projections, and roll marks to ensure a leak-tight seal. All oil, grease, dirt, and cutting particles must be removed. Measurements taken across grooved mating component ends must not exceed the maximum allowable flare diameter. Refer to current Victaulic specifications for the maximum allowable flare diameter.

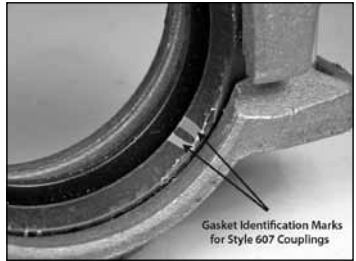

3. CHECK GASKET: Check the gasket to make sure it is suitable for the intended service. Victaulic gaskets for copper products contain two marks: the copper-colored mark identifies that the gasket is specifically for Victaulic copper products, and the additional mark identifies the gasket grade. Refer to submittal 05.01 or the “Gasket Selection” section of this manual for the color code chart.

WARNING

- Always use a compatible lubricant to prevent the gasket from pinching or tearing during installation.
- Failure to follow this instruction could result in joint leakage.



4. LUBRICATE GASKET: Apply a thin coat of Victaulic Lubricant or silicone lubricant only to the sealing lips of the gasket interior. **NOTE:** The gasket exterior is supplied with a factory-applied lubricant, so there is no need to remove the gasket from the housings to apply additional lubricant to the exterior surface.

5. ASSEMBLE JOINT: Assemble the joint by inserting (“stabbing”) the grooved end of a copper mating component into each opening of the coupling. The ends of the grooved mating components must be inserted into the coupling until contact with the center leg of the gasket occurs. A visual check is required to ensure the coupling keys align with the grooves in the mating components.



WARNING

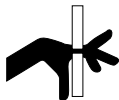

- Never leave a Style 607 Coupling partially assembled. A partially assembled Style 607 Coupling poses a drop hazard.
- Keep hands away from the mating component ends and the openings of the coupling when attempting to “stab” the grooved end of mating components into the coupling.

Failure to follow these instructions could cause serious personal injury and/or property damage.



WARNING

- For Victaulic rigid, angle-bolt-pad couplings, the nuts must be tightened evenly by alternating sides until metal-to-metal contact occurs at the bolt pads.
- For Victaulic rigid, angle-bolt-pad couplings, equal offsets must be present at the bolt pads.
- Keep hands away from coupling openings during tightening.

Failure to follow these instructions could cause joint failure, serious personal injury, and property damage.

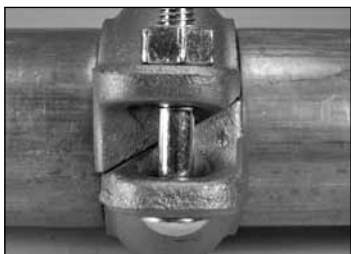

NOTICE

Visual inspection of each joint is critical. Improperly assembled joints must be corrected before the system is placed in service.

GOOD

BAD

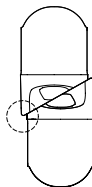

PROPER
ASSEMBLY

PROPER
ASSEMBLY

IMPROPER
ASSEMBLY

POSITIVE
OFFSET
WITH BOLT
PAD
CONTACT

NEUTRAL
OFFSET
WITH BOLT
PAD
CONTACT

BOLT PAD
GAP

Drawings are exaggerated for clarity

6. TIGHTEN NUTS: Tighten the nuts evenly by alternating sides until metal-to-metal contact occurs at the angle bolt pads. Make sure the housings' keys completely engage the grooves and the offsets are equal at the bolt pads. This is necessary to ensure a rigid joint. **NOTE:** It is important to tighten the nuts evenly to prevent gasket pinching. An impact wrench or standard socket wrench can be used to bring the bolt pads into metal-to-metal contact. Refer to the "Impact Wrench Usage Guidelines" section in this handbook.

7. Visually inspect the bolt pads at each joint to ensure metal-to-metal contact is achieved.

INSTRUCTIONS FOR RE-INSTALLATION OF STYLE 607 COUPLINGS

Since the coupling housings conform to the outside diameter of the copper mating components during an initial installation, "stabbing" the mating components into the coupling may not be possible upon re-installation. If this is the case, refer to the following steps for re-installing the coupling.

1. Make sure the system is depressurized and drained completely before attempting to disassemble any couplings.
2. Follow steps 2 – 3 on page 29.



3. **LUBRICATE GASKET:** Apply a thin coat of Victaulic Lubricant or silicone lubricant to the gasket sealing lips and exterior.



4. INSTALL GASKET: Insert the grooved end of a mating component into the gasket until it contacts the center leg of the gasket.



5. JOIN COPPER TUBING/ MATING COMPONENTS: Align the two grooved ends of the mating components. Insert the other mating component into the gasket until it contacts the center leg of the gasket. **NOTE:** Make sure no portion of the gasket extends into the groove of either mating component.



6. ASSEMBLE HOUSINGS: Insert one bolt into the housings, and thread the nut loosely onto the bolt to allow for the “swing-over” feature, as shown above. **NOTE:** The nut should be backed off no further than flush with the end of the bolt.

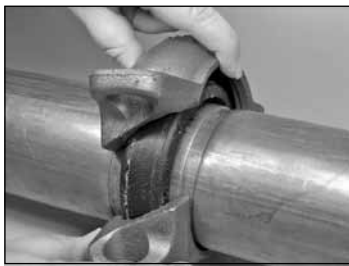

7. INSTALL HOUSINGS: Using the “swing-over” feature, install the housings over the gasket. Make sure the housings’ keys engage the grooves properly on both mating components.

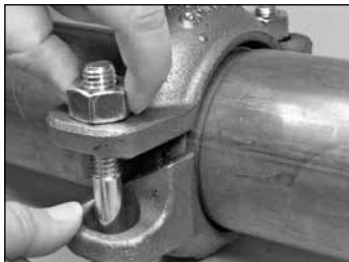

8. INSTALL REMAINING BOLT/ NUT: Install the remaining bolt, and thread the nut finger-tight onto the bolt. **NOTE:** Make sure the oval necks of the bolts seat properly in the bolt holes.

9. TIGHTEN NUTS: Follow steps 6 and 7 on the previous page to complete the assembly.

Style 607 Helpful Information

CTS US Standard Copper Tubing Size	Nut Size	Socket Size
Nominal Size inches/Actual mm	inches	inches
2 – 2½ 54.0 – 66.7	¾	1⅛
3 – 4 79.4 – 104.8	½	¾
5 – 8 130.2 – 206.4	⅝	1⅛

IMPACT WRENCH USAGE GUIDELINES

WARNING

- Nuts must be tightened evenly by alternating sides until metal-to-metal contact occurs at the bolt pads. For angle-bolt-pad couplings, even offsets must be present at the bolt pads to obtain pipe-joint rigidity.
- **DO NOT** continue to use an impact wrench after the visual installation guidelines for the coupling are achieved.

Failure to follow these instructions could cause gasket pinching and coupling damage, resulting in joint failure, serious personal injury, and property damage.

Due to the speed of assembly when using an impact wrench, the installer should take extra care to ensure nuts are tightened evenly by alternating sides until proper assembly is complete. Always refer to the Victaulic assembly instructions, supplied with the product, for complete installation requirements.

Impact wrenches do not provide the installer with direct “wrench feel” or torque to judge nut tightness. Since some impact wrenches are capable of high output, it is important to develop a familiarity with the impact wrench to avoid damaging or fracturing bolts or coupling bolt pads during installation.

DO NOT continue to use an impact wrench after the visual installation requirements for the coupling are achieved.

Perform trial assemblies with the impact wrench and socket or torque wrenches to help determine the capability of the impact wrench. Using the same method, periodically check additional nuts throughout the system installation.

For safe and proper use of impact wrenches, always refer to the impact wrench manufacturer’s operating instructions. In addition, verify that proper impact grade sockets are being used for coupling installation.



I-600_34

Flange Adapter for Grooved-End Copper Tubing

Installation Instructions



Style 641 Vic-Flange Adapter

FLANGE WASHER NOTES

Style 641 Vic-Flange Adapter

Style 641 Vic-Flange Adapters require a smooth, hard surface at the mating flange face for proper sealing. Some applications, for which the Vic-Flange Adapter is otherwise well suited, do not provide an adequate mating surface. In such cases, it is recommended that a phenolic (Type F) Vic-Flange washer be inserted between the Vic-Flange Adapter and the mating flange to provide the necessary sealing surface.

- A. When mating to a serrated flange** – A flange gasket should be used against the serrated flange. The Vic-Flange washer should then be inserted between the Vic-Flange Adapter and the flange gasket.
- B. When mating to a rubber-faced, wafer-type valve** – The Vic-Flange washer should be placed between the valve and the Vic-Flange Adapter
- C. When mating to a rubber-faced flange** – The Vic-Flange washer should be placed between the Vic-Flange Adapter and the rubber-faced flange.
- D. When mating AWWA cast flanges or IPS flanges to copper tubing size (CTS) flanges** – The Vic-Flange washer should be placed between two Vic-Flange Adapters. If one flange is not a Vic-Flange Adapter (i.e. flanged valve), a flange gasket must be placed against that flange. The Vic-Flange washer must then be inserted between the flange gasket and the Vic-Flange Adapter.
- E. When mating Style 641 Vic-Flange Adapter to iron or steel body components** – A bolt isolation kit is recommended.
- F. When mating to components (valves, strainers, etc.) where the component flange face has an insert** – Follow the same arrangement as if the Vic-Flange Adapter was being mated to a serrated flange. Refer to application “A” above.

EXAMPLE

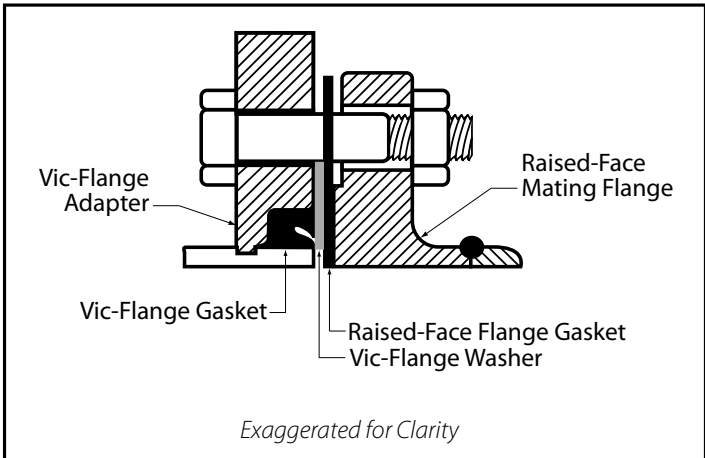

Style 641

Vic-Flange Adapter

! WARNING



- Read and understand all instructions before attempting to install any Victaulic piping products.
- Depressurize and drain the piping system before attempting to install, remove, or adjust any Victaulic piping products.
- Wear safety glasses, hardhat, and foot protection during installation.

Failure to follow these instructions could result in serious personal injury, improper product installation, and/or property damage.



1. CHECK COPPER TUBING

ENDS: The outside surface of the copper tubing, between the groove and the tubing end, must be smooth and free from indentations, projections, and roll marks to provide a leak-tight seal. All oil, grease, dirt, and cutting particles must be removed. Measurements taken across grooved tubing ends must not exceed the maximum allowable flare diameter. Refer to current Victaulic specifications for the maximum allowable flare diameter.

NOTICE

- Make sure there is sufficient clearance behind the groove in the copper tubing to permit proper assembly of the Vic-Flange Adapter.



2. CHECK GASKET: Check the gasket to make sure it is suitable for the intended service. Victaulic Copper Connection gaskets contain two marks: the copper-colored mark identifies that the gasket is specifically for Victaulic Copper Connection products, and the other mark identifies the gasket grade.



CAUTION

- Always use a compatible lubricant to prevent the gasket from pinching or tearing during installation.

Failure to follow this instruction could result in joint leakage.

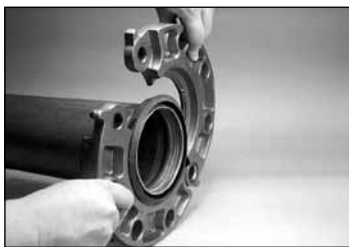

3. LUBRICATE GASKET: Apply a thin coat of Victaulic Lubricant or silicone lubricant to the gasket lips and exterior. **NOTE:** This gasket is designed to provide the primary seal. Refer to the previous “Flange Washer Notes” section for special applications.



Closure lugs are provided for ease of installation. If necessary, use an adjustable wrench to align the mating holes.

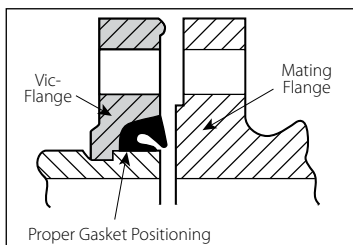

(Exaggerated for Clarity)

4. INSTALL GASKET: Install the gasket over the end of the copper tubing. Make sure the gasket is positioned properly, as shown above. **NOTE:** The lettering on the outside of the gasket must face the flange-adapter gasket pocket. When installed correctly, the lettering on the gasket will not be visible.

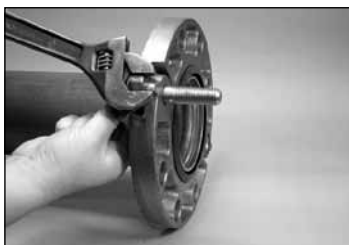

6. While squeezing the closure lugs together, insert a standard flange bolt through each of the two mating holes in the Vic-Flange Adapter; this will maintain the position of the flange in the groove.



6a. Make sure the gasket is still seated properly in the flange adapter.



CAUTION

- Bolt sizes specified in this section must be used to ensure proper assembly of Vic-Flange Adapters. Failure to follow this instruction could cause joint failure, resulting in serious personal injury and/or property damage.



8. INSTALL REMAINING BOLTS/ NUTS: Insert a standard flange bolt through each remaining hole in the Vic-Flange Adapter/mating flange. Thread a standard flange nut finger-tight onto all bolts.



9. TIGHTEN NUTS: Tighten the nuts evenly, as with a regular flange assembly. Continue tightening until the flange faces come into metal-to-metal contact or the bolts reach the standard, flange-joint torque requirement.



7. JOIN VIC-FLANGE ADAPTER AND MATING FLANGE: Join the Vic-Flange Adapter with the mating flange by aligning the bolt holes.



7a. Thread standard flange nuts finger-tight onto the two mating bolts.

Style 641 Helpful Information

CTS US Standard Copper Tubing Size	Number of Bolts	Bolt Size	Required Mating Face Sealing Surface inches/mm	
			"A" Maximum	"B" Minimum
Nominal Size inches/Actual mm	Required †	inches		
2 54.0	4	5/8 x 3	2.13 54	3.20 81
2½ 66.7	4	5/8 x 3	2.63 67	3.91 99
3 79.4	4	5/8 x 3	3.13 80	4.53 115
4 104.8	8	5/8 x 3	4.13 105	5.53 140
5 130.2	8	¾ x 3½	5.13 130	6.71 170
6 155.6	8	¾ x 3½	6.13 156	7.78 198

Copper Tubing Size	Number of Bolts	Bolt Size	Required Mating Face Sealing Surface millimeters	
			"A" Maximum	"B" Minimum
European Standard Nominal Size mm	Required †	Metric		
54	4	M16	54	78
64	4	M16	64	89
66.7	4	M16	67	92
76.1 #	4	M16	76	101
76.1 #	8	M16	76	101
88.9	8	M16	89	114
108	8	M16	108	133
133	8	M16	133	160
159	8	M16	159	186

† Total bolts required are to be supplied by the installer. Bolt sizes are for conventional flange-to-flange connections. Longer bolts are required when Vic-Flange Adapters are used with wafer-type valves.

The desired bolt hole configuration must be specified on the order.

NOTE: Style 641 Vic-Flange Adapters for copper tubing provide rigid joints when used on copper tubing that is roll grooved to Victaulic specifications. Consequently, no linear or angular movement is allowed at the joint.

The shaded area of the mating face (shown at right) must be free from gouges, undulations, or deformities of any type for proper sealing.

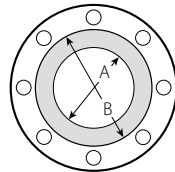

Hole-Cut Product for Copper Tubing

Installation Instructions



Style 622 Copper Mechanical-T® Bolted Branch Outlet

Style 622

Copper Mechanical-T® Bolted Branch Outlet

WARNING



- Read and understand all instructions before attempting to install any Victaulic piping products.
 - Depressurize and drain the piping system before attempting to install, remove, or adjust any Victaulic piping products.
 - Wear safety glasses, hardhat, and foot protection.
- Failure to follow these instructions could result in serious personal injury, improper product installation, and/or property damage.

COPPER TUBING PREPARATION REQUIREMENTS FOR MECHANICAL-T OUTLET AND MECHANICAL-T CROSS INSTALLATION

NOTICE

- Victaulic hole-cutting tools are recommended for proper hole preparation.
- Proper preparation of the hole is essential for sealing and product performance. Make sure the correct hole saw size is being used. Refer to the “Copper Tubing Preparation Requirements” table on the next page for the proper hole saw size.
- Holes MUST be drilled on the centerline of the tubing. Holes for Mechanical-T Cross assemblies must be drilled on the centerline of the tubing at predetermined locations for each branch. Holes for Mechanical-T Cross assemblies must be in line within $\frac{1}{16}$ inch/1.6 mm of each other.
- Ensure that a $\frac{5}{8}$ -inch/16-mm area around the hole is clean, smooth, and free from indentations and/or projections that could affect gasket sealing (refer to the sketch on the next page). Remove any burrs and sharp or rough edges from the hole. Burrs and sharp edges could affect product assembly, seating of the locating collar, flow from the outlet, and gasket sealing.
- The tubing around the entire circumference, within the “A” dimension shown in the sketch on the next page, must be free from any dirt, scale, projections, and cutting particles that could prevent the housing from seating fully on the tubing. Refer to the “Copper Tubing Preparation Requirements” table on the next page for the “A” dimension.

COPPER TUBING PREPARATION REQUIREMENTS

Size	Hole Dimensions		Surface Preparation Dimensions
	Minimum Hole Diameter/ Hole Saw Size inches/mm	Maximum Allowable Hole Diameter inches/mm	"A" Dimension inches/mm
All 3/4-inch/20-mm Outlets	1.50 38.1	1.63 41.4	3.50 88.9
All 1-inch/25-mm Outlets	1.50 38.1	1.63 41.4	3.50 88.9
All 1 1/2-inch/40-mm Outlets	2.00 50.8	2.13 54.1	4.00 101.6

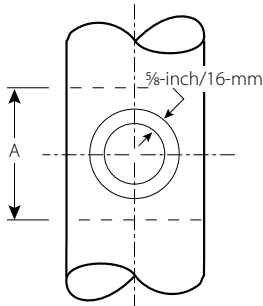

(Exaggerated for clarity)

(Not to scale)

MECHANICAL-T INSTALLATION

CAUTION

- **Make sure tubing is prepared properly in accordance with the instructions in this section. Failure to follow these instructions could cause improper gasket sealing.**



1. CHECK GASKET AND

LUBRICATE: Inspect the sealing surface of the gasket to make sure no debris is present. It is not necessary to remove the gasket from the housing. Lubricate the exposed sealing surface of the gasket with a thin coat of Victaulic Lubricant or silicone lubricant. **DO NOT** use petroleum-based lubricants.



2. ASSEMBLE HOUSINGS: Insert a bolt (provided) into the two housings. Thread a nut loosely onto the end of the bolt.



3. INSTALL HOUSINGS: Rotate the lower housing so that it is positioned approximately 90° to the upper (outlet) housing, as shown above.

Place the upper (outlet) housing onto the face of the tubing in line with the hole in the tubing.



3a. Rotate the lower housing around the tubing.



4. CHECK PRODUCT

ENGAGEMENT: Make sure the locating collar engages the outlet hole properly. Check this engagement by rocking the upper (outlet) housing in the hole.



5. INSTALL REMAINING BOLT/

NUT: Insert the remaining bolt (provided) into the two housings. Thread a nut onto the bolt finger-tight. Make sure the bolt track heads seat properly in the bolt holes.



6. TIGHTEN NUTS: Make sure the locating collar is still positioned properly in the outlet hole. Tighten the nuts evenly by alternating sides until the upper (outlet) housing contacts the tubing completely.

6a. Torque the nuts to 50 – 70 ft-lbs/ 68 – 95 N•m with even gaps between the bolt pads. DO NOT exceed 70 ft-lbs/95 N•m of torque on the nuts. **NOTE:** For a properly assembled joint, the bolt pads shall not touch. Each joint must be inspected to ensure even gaps between the bolt pads are achieved.

6b. For threaded outlets, complete the assembly using standard threading practices.

WARNING

- **Nuts must be torqued to 50 – 70 ft-lbs/68 – 95 N•m.**
 - **DO NOT exceed 70 ft-lbs/95 N•m of torque on the nuts. Increased bolt torque will not improve sealing and may cause product failure.**
- Failure to torque nuts properly could cause product failure, resulting in serious personal injury and/or property damage.**

BRANCH CONNECTIONS

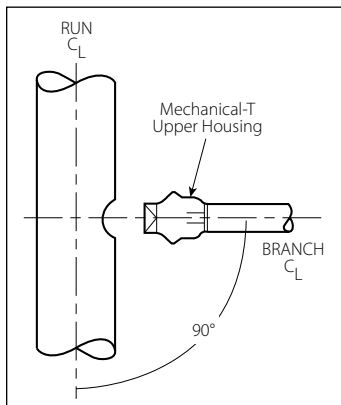

(Exaggerated for clarity)

- If a branch connection is made to the upper (outlet) housing before the Mechanical-T Outlet is installed on the tubing, make sure the branch connection is 90° to the run before completing the tightening sequence of the Mechanical-T Outlet assembly.
- When the Mechanical-T Outlet is used as a transition piece between two runs, it must be assembled onto the runs before the branch connection is made.
- Victaulic female-threaded products are designed to accommodate standard ANSI male threads only. Use of male threaded products with special features, such as probes, dry pendent sprinkler heads, etc., should be verified as suitable for use with this Victaulic product. Failure to verify suitability in advance may result in assembly problems or leakage.

STYLE 622 MECHANICAL-T CROSSES

Cross connections can be made by using two upper (outlet) housings of the same run size. Different branch sizes are allowable.

1. Refer to the “Copper Tubing Preparation Requirements for Copper Mechanical-T Outlet and Copper Mechanical-T Cross Installation” section for preparing both outlet holes.

2. CHECK GASKETS AND LUBRICATE:

Inspect the sealing surface of the gaskets in both upper (outlet) housings to make sure no debris is present. It is not necessary to remove the gaskets from the two upper (outlet) housings. Lubricate the exposed sealing surface of both gaskets with a thin coat of Victaulic Lubricant or silicone lubricant. DO NOT use petroleum-based lubricants.



3. **INSTALL HOUSINGS:** Insert a bolt into each bolt hole of the first upper (outlet) housing. Place the first upper (outlet) housing onto the face of the tubing in line with the one outlet hole.

3a. Align the bolt holes of the second upper (outlet) housing with the bolts, and place this housing onto the face of the tubing in line with the other outlet hole.



4. CHECK PRODUCT ENGAGEMENT:

Make sure the locating collars of the upper (outlet)

housings engage the outlet holes properly. Check this engagement by rocking both upper (outlet) housings in the outlet holes.

5. INSTALL AND TIGHTEN NUTS:

Thread a nut onto each bolt until finger-tight. Make sure the bolt track heads seat properly in the bolt holes and that the locating collars of the upper (outlet) housings are still positioned properly in the outlet holes. Tighten the nuts evenly by alternating sides until the upper (outlet) housings contact the tubing completely.

5a. Torque the nuts to 50 – 70 ft-lbs/ 68 – 95 N•m with even gaps between the bolt pads. DO NOT exceed 70 ft-lbs/95 N•m of torque on the nuts. **NOTE:** For a properly assembled joint, the bolt pads shall not touch. Each joint must be inspected to ensure even gaps between the bolt pads are achieved.

5b. For threaded outlets, complete the assembly using standard threading practices.



WARNING

- Nuts must be torqued to 50 – 70 ft-lbs/68 – 95 N•m.
 - DO NOT exceed 70 ft-lbs/95 N•m of torque on the nuts. Increased bolt torque will not improve sealing and may cause product failure.
- Failure to torque nuts properly could cause product failure, resulting in serious personal injury and/or property damage.

Style 622 Helpful Information

Run Size	Nut Size	Socket Size
	inches/mm	inches/mm
All Sizes	1/2	7/8
	12	22



Butterfly Valve Installation and Operation



Series 608 Butterfly Valve

BUTTERFLY VALVE INSTALLATION AND OPERATION

For installing a Victaulic butterfly valve into a piping system, follow the instructions supplied with the coupling. Refer to the notes below for applications/limitations.

DO NOT INSTALL BUTTERFLY VALVES INTO THE SYSTEM WITH THE DISC IN THE FULLY OPEN POSITION.

When using butterfly valves for throttling service, Victaulic recommends the disc to be positioned no less than 30 degrees open. For best results, the disc should be between 30 and 70 degrees open. High pipeline velocities and/or throttling with the disc less than 30 degrees open may result in noise, vibration, cavitation, severe line erosion, and/or loss of control. For details regarding throttling services, contact Victaulic.

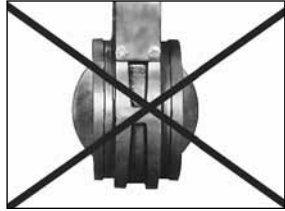

Flow velocities in copper piping systems are typically limited to 5 feet/second (1.5 m/second). When higher flow velocities are necessary, contact Victaulic.

Victaulic butterfly valves are designed with grooved ends for use with grooved pipe couplings. If flange connections are required, refer to the following notes regarding Vic-Flange Adapter restrictions.

When directly connecting an end cap to a butterfly valve, use only a tapped end cap for pressure relief. If the butterfly valve is opened then closed unknowingly while the end cap is attached, the space between the disc and end cap will be filled and pressurized. A sudden release of energy can occur if the end cap is removed while the space behind it is pressurized. **PRESSURE MUST BE VENTED THROUGH THE TAP BEFORE ATTEMPTING TO REMOVE THE CAP.**

⚠ DANGER



- When directly connecting an end cap to a butterfly valve, use only a tapped end cap for pressure relief.
- Pressure must be vented through the tap before attempting to remove the cap.

Failure to follow these instructions could result in death or serious personal injury.

Series 608 Copper Connection Butterfly Valve

- Style 641 Vic-Flange Adapters can be used only on one side of 2½ - 6-inch/66.7 – 155.6-mm Series 608 Butterfly Valves.

PermaLynx™

Installation Instructions

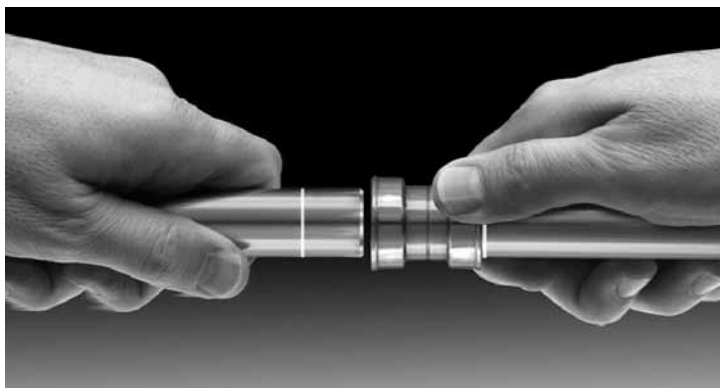

Victaulic

I-600_49

WARNING



- Read and understand all instructions before attempting to install any Victaulic piping products.
 - Depressurize and drain the piping system before attempting to install, remove, or adjust any Victaulic piping products.
 - Wear safety glasses, hardhat, and foot protection during installation.
- Failure to follow these instructions could result in serious personal injury, improper product installation, and/or property damage.

IMPORTANT INFORMATION AND INSTALLER SAFETY REQUIREMENTS

- **Approved Copper Tube:** PermaLynx products are approved for use only with ½ - 1½-inch/12.7 - 41.3-mm Type K, L, or M copper tube that is ASTM B88 compliant.
- **Pressure Rating:** The maximum pressure rating for PermaLynx products is 200psi/1379kPa.
- **Applications:** PermaLynx products are recommended for use in potable hot and cold water distribution systems* up to 180° F/82° C. In addition, PermaLynx products are recommended for use in ambient, oil-free compressed air systems. PermaLynx products are not recommended for use in heating systems.
 - * Refer to the current version of the Uniform Plumbing Code, International Plumbing Code, International Residential Code, and NSF 61.
- **Wet or Dry Installations:** PermaLynx products can be installed on wet or dry tube. NEVER attempt to cut into or remove fittings from a pressurized system. Use caution around hot water piping and hot water.
- **Rotating Product:** PermaLynx products and/or tubing can be rotated while the system is depressurized. DO NOT attempt to rotate fittings/tubing while the system is pressurized.
- **Installer Safety:** DO NOT use electrically-powered tools in damp or wet locations. Maintain proper footing at all times. DO NOT over-reach while installing PermaLynx products. DO NOT insert fingers into PermaLynx products, and protect fingers from burrs and sharp edges that may exist on the tubing.
- **Tools:** DO NOT squeeze or grip PermaLynx products with pliers, wrenches, or any other tool containing metal teeth. DO NOT strike PermaLynx products with a hammer or other similar tools.
- **Support Hangers:** Support the tubing system in accordance with local code requirements, using sweat/solder system tables.
- **Electrical Grounding:** Electrical grounding for a PermaLynx system works on the same principles as a sweat/solder system. Ground the tubing system in accordance with local code requirements.

- **Adapting to a Threaded System:** Use PermaLynx male/female threaded adapters.
- **Adapting to a Pressed System:** Keep PermaLynx products a minimum of 6 inches/152 mm away from pressed fittings. Pressed fittings may distort the shape of the tube, which can cause leaks in nearby PermaLynx products.
- **Underground Applications:** PermaLynx products in an underground application work on the same principles as a sweat/solder system. Prevent deflection of joints due to backfilling and ground settlement, and prevent the system from freezing.
- **Sweating/Soldering Near PermaLynx Products:** When sweating/soldering near PermaLynx products, use a wet towel to cover the fitting plus 3 inches/76 mm of the tube closest to the sweat/solder point. The flame MUST be kept a minimum of 6 inches/152 mm away from the product (refer to sketch below). Heat damage to the rubber seals in PermaLynx products will cause leaks.

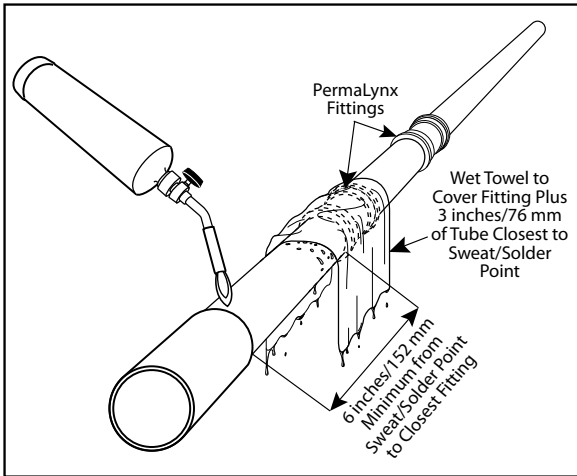

TUBE PREPARATION REQUIREMENTS

MINIMUM TUBE LENGTHS

WARNING

- Extra attention must be given to proper end preparation and alignment during installation when using tube lengths shorter than the recommended length listed in the table below.
- **DO NOT** attempt to use tube lengths shorter than the absolute minimum lengths listed in the table below.
- Always keep hands a minimum of ½ inch/13 mm away from the chamfering tool during the chamfering operation.

Failure to follow these instructions could result in serious personal injury.

The following table identifies the recommended minimum tube lengths and the absolute minimum tube lengths for use with PermaLynx products. Tube end preparation and tube/fitting alignment during assembly become more sensitive when using tube shorter than the recommended minimum lengths listed in the table below. Therefore, extra attention must be given to proper end preparation (per the requirements in this section) and alignment during installation. DO NOT attempt to use tube lengths shorter than the absolute minimum lengths listed below.

Copper Tube/ Fitting Size	Recommended Minimum Length	Absolute Minimum Length
Nominal inches/ Actual mm	inches/ mm	inches/ mm
½	5	1¼
12.7	127	29
¾	5	1¾
22.2	127	35
1	5	1½
28.6	127	38

Copper Tube/ Fitting Size	Recommended Minimum Length	Absolute Minimum Length
Nominal inches/ Actual mm	inches/ mm	inches/ mm
1¼	5	1¾
34.9	127	44
1½	5	2
41.3	127	51

SQUARE CUT AND INSPECT TUBE ENDS

Tube ends must be square cut within 0.030 inch/0.8mm ("S" dimension shown below). Victaulic recommends factory-prepared tube ends or the use of a tube cutter to ensure square cuts. Hacksaws or reciprocating saws can be used; however, extra attention must be given to the square cut requirement and the proper end preparation requirements listed in this section.

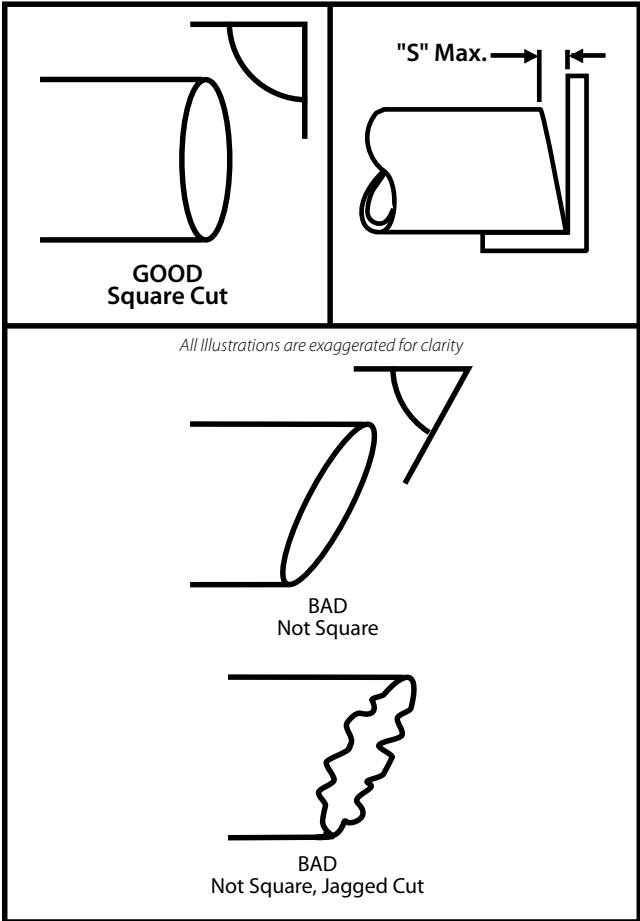

INSPECT TUBE CONDITION

Tube condition must be inspected. DO NOT use tube that is out-of-round or tube that contains dents/flat spots, gouges, or saw marks/scratches within $\frac{3}{4}$ inch/19 mm from the tube end.

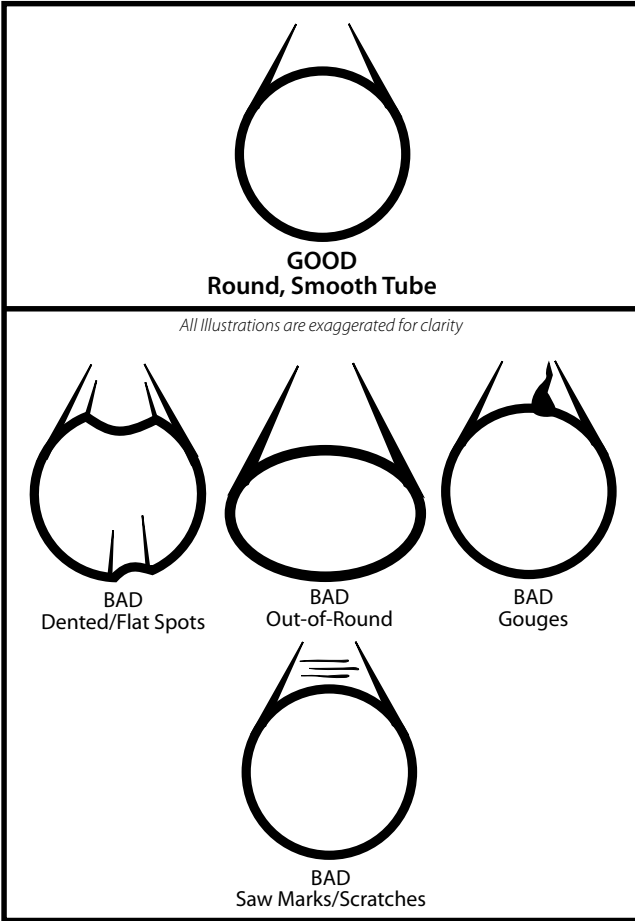



CAUTION

- Victaulic strongly recommends the use of the Tube Prep Max Tool or the Tube Prep Tool for preparing tube ends. If a different tool is used, extra attention must be given to the proper tube end preparation procedures outlined on this page.
- Victaulic makes no expressed or implied guarantee of any kind regarding the ability of other commercially available tools to provide performance that is comparable to the Tube Prep Max Tool and the Tube Prep Tool.

Failure to properly chamfer and deburr tube ends may cause difficult installation and gasket damage, resulting in joint leakage, personal injury, and property damage.

Two tools are available from Victaulic and are strongly recommended for chamfering and deburring tube ends. The Tube Prep Max Tool is power-drill operated, and the Tube Prep Tool is driven by a power drive. It is important to inspect the tube end periodically during the chamfering process to prevent the tube end from being chamfered too much (resulting in a knife-edge effect). Burrs, rough edges, and over-chamfered ends can damage the rubber seal in PermaLynx products.



WARNING

- **Always keep hands a minimum of ½ inch/13 mm away from the chamfering tool during the chamfering operation.**

Failure to follow this instruction could result in serious personal injury.

1. Center the chamfering tool over the tube end. Push the tube against the rotating tool, while turning the tube clockwise. Continue this procedure, and check the tube end periodically until a 360° chamfer is achieved.
2. Ream the inside of tube ends to remove all burrs and sharp edges.
3. Use emery cloth or another fine-grit abrasive cloth to remove any remaining protrusions from the tube end.

CHAMFER AND DEBURR TUBE ENDS (CONTINUED)

$\frac{1}{32}$ inch/0.8 mm
(Reference)

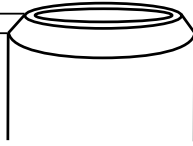

GOOD
360° Smooth Chamfer,
No Burrs, No Rough Edges, No Ridges,
No Raised Edges

All Illustrations are Exaggerated for Clarity

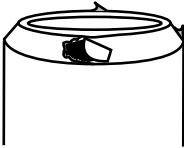

BAD
Sharp Burrs

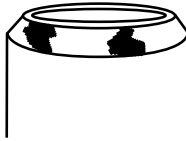

BAD
Rough Edges



BAD
Not Chamfered
360°

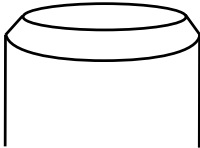

BAD
**Excess Chamfer/
Knife Edge**

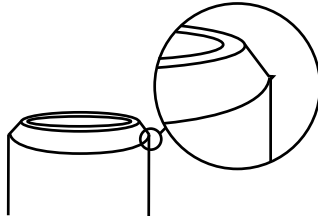

BAD
Ridges and Raised Edges

PRODUCT INSTALLATION

NOTICE

- The insertion depth (witness mark) **MUST** be made prior to installing PermaLynx products. This mark serves as an important aid during visual inspection of the system.



1. Refer to the “Insertion Depth Requirements” table below. Using a tape measure or ruler, measure the required distance back from the tube end. Place a mark around the tube circumference with a bright-colored marker or paint stick, as shown above.

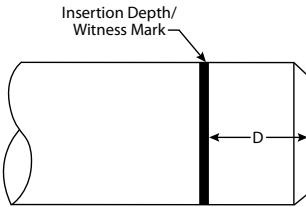

Exaggerated for Clarity

Insertion Depth (Witness Mark) Requirements

Copper Tube/ Fitting Size	Insertion Depth “D”
Nominal inches/ Actual mm	inches/ mm
½	½
12.7	13
¾	9/16
22.2	14
1	5/8
28.6	16
1¼	11/16
34.9	17
1½	¾
41.3	19

CAUTION



- **DO NOT** insert fingers into the openings of PermaLynx products.
- Failure to follow this instruction could result in personal injury.



2. Using a brush, apply a thin coat of Victaulic lubricant or silicone lubricant to the seals inside the fitting ends. **DO NOT** over-lubricate the seals.



3. Align the tube with the opening of the fitting. Push the tube straight into the fitting until the edge of the fitting lines up with the insertion depth mark on the tube. **NOTE:** The insertion depth mark **MUST NOT** be further than 1/16 inch/1.6 mm from the edge of the fitting. **DO NOT** rock the tube in the fitting during insertion.

4. Inspect each joint to ensure tube ends are inserted fully into the fittings. Any joint that is not assembled properly must be cut out and replaced before the system is pressurized.

SYSTEM TESTING

Pressure test the system with air or water. Normal testing to 1½ times the design pressure is allowable up to a maximum test pressure of 300 psi/2068 kPa.



I-600_58

Product Data

The following information contains center-to-end, end-to-end, take-out, and similar overall dimensions for couplings, flange adapters, and fittings. Refer to the current Victaulic publication for complete dimensional information and for products not shown.

COUPLINGS FOR GROOVED-END COPPER TUBING

Style 606 Coupling

Copper Tubing Size	"Y" Dimension
Nominal Size inches/Actual mm	inches/mm
2 54.0	4.86 123.4
2½ 66.7	5.34 135.6
3 79.4	6.50 165.1
4 104.8	7.34 186.4
5 130.2	9.21 233.9
6 155.6	10.13 257.3
8 206.4	12.42 315.5

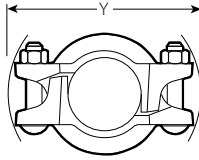

Style 606 Coupling

Style 606 (Australian Standard) Coupling

Copper Tubing Size	"Y" Dimension
Australian Standard Nominal Size (Actual Size)	inches/mm
DN 50 (50.8)	122.3 4.81
DN 65 (63.5)	134.8 5.31
DN 80 (76.2)	164.6 6.48
DN 100 (101.6)	188.9 7.44
DN 125 (127.0)	233.8 9.20
DN 150 (152.4)	256.9 10.11

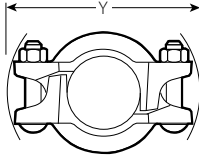

Style 606 (Australian Standard) Coupling

COUPLINGS FOR GROOVED-END COPPER TUBING

Style 606 (European Standard) Coupling

Copper Tubing Size	"Y" Dimension
Nominal Size mm/ Actual inches	mm/inches
54.0 2.125	117.6 4.63
64.0 2.250	129.0 5.08
66.7 2.625	130.3 5.13
76.1 3.000	151.6 5.97
88.9 3.500	162.1 6.38
108.0 4.250	181.4 7.14
133.0 5.236	228.9 9.01
159.0 6.260	254.5 10.02

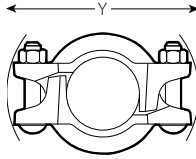

Style 606 (European Standard) Coupling

Style 607 QuickVic® Rigid Coupling for Copper Tubing

Copper Tubing Size	"Y" Dimension
Nominal Size inches/Actual mm	inches/mm
2 54.0	5.50 139.7
2½ 66.7	6.00 152.4
3 79.4	7.00 177.8
4 104.8	8.00 203.2
5 130.2	10.00 254.0
6 155.6	11.00 279.4
8 206.4	13.00 330.2

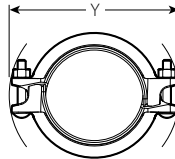

Style 607 QuickVic Rigid Coupling

VIC-FLANGE ADAPTER FOR COPPER TUBING

Style 641 Vic-Flange Adapter

Copper Tubing Size	"W" Dimension
Nominal Size inches/Actual mm	mm/inches
2 54.0	6.88 174.8
2 1/2 66.7	7.88 200.2
3 79.4	8.44 214.4
4 104.8	9.94 252.5
5 130.2	11.00 279.4
6 155.6	12.00 304.8

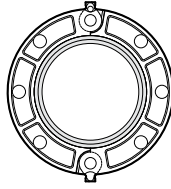

Style 641 Vic-Flange Adapter

Style 641 (European Standard) Vic-Flange Adapter

Copper Tubing Size	"W" Dimension
Nominal Size mm/Actual inches	mm/inches
54.0 2.125	175.0 6.89
64.0 2.250	214.1 8.43
66.7 2.625	199.9 7.87
76.1 * 3.000 *	208.0 8.19
76.1 ‡ 3.000 ‡	215.4 8.48
88.9 3.500	220.0 8.66
108.0 4.250	243.1 9.57
133.0 5.236	273.8 10.78
159.0 6.260	307.1 12.09

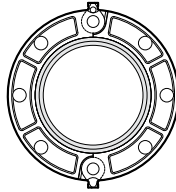

Style 641 (European Standard) Vic-Flange Adapter

* Four-bolt-hole configuration

‡ Eight-bolt-hole configuration

HOLE-CUT PRODUCT FOR COPPER TUBING

Style 622 Copper Mechanical-T Bolted Branch Outlet

Size	Dimensions – inches/mm			
	Run x Branch Nominal Size inches/Actual mm	T ** Takeout	V ‡ Threaded	Y
2½ 66.7	x ¾	2.05	2.61	5.90
	x 22.5	52.0	66.2	149.8
	x 1	1.93	2.61	5.90
	x 28.6	49.02	66.2	149.8
	x 1½	2.15	2.87	6.06
3 79.4	x 41.3	54.6	72.8	153.9
	x ¾	2.30	2.86	6.30
	x 22.5	58.4	72.6	160.0
	x 1	2.19	2.87	6.30
	x 28.6	55.6	72.8	160.0
4 104.8	x 1½	2.59	3.31	6.30
	x 41.3	65.7	84.0	160.0
	x ¾	2.81	3.37	7.25
	x 22.5	71.3	85.5	184.1
	x 1	2.69	3.37	7.25
	x 28.6	68.3	85.5	184.1
	x 1½	3.09	3.81	7.25
	x 41.3	78.4	96.7	184.1

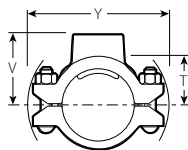

**Style 622 Copper
Mechanical-T Bolted
Branch Outlet**

** Center of run to engaged pipe end for female threaded outlets only (dimensions are approximate)

‡ Center of run to end of fitting

FITTINGS FOR COPPER TUBING

No. 610 – 90° Elbow

No. 611 – 45° Elbow

No. 620 – Tee

Copper Tubing Size	No. 610 90° Elbow	No. 611 45° Elbow	No. 620 Tee
Nominal Size inches/ Actual mm	C to E inches/mm	C to E inches/mm	C to E inches/mm
2 54.0	2.91 73.9	2.19 55.6	2.69 68.3
2½ 66.7	3.31 84.1	2.31 58.7	3.20 81.3
3 79.4	3.81 96.8	2.59 65.8	3.52 89.4
4 104.8	4.75 120.7	3.19 81.0	4.25 108.0
5 130.2	5.94 150.9	3.25 82.6	5.94 150.9
6 155.6	6.94 176.3	3.63 92.2	6.94 176.3
8 206.4	7.75 196.9	4.25 108.0	7.75 196.9

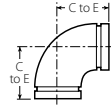

No. 610 90° Elbow



No. 611 45° Elbow

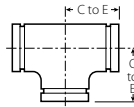

No. 620 Tee

No. 610 (European Standard) – 90° Elbow

No. 611 (European Standard) – 45° Elbow

No. 620 (European Standard) – Tee

Copper Tubing Size	No. 610 90° Elbow	No. 611 45° Elbow	No. 620 Tee
Nominal Size mm/Actual inches	C to E mm/inches	C to E mm/inches	C to E mm/inches
54.0 2.125	73.9 2.91	55.6 2.19	68.3 2.69
64.0 2.250	84.1 3.31	58.7 2.31	81.3 3.20
66.7 2.625	84.1 3.31	58.7 2.31	81.3 3.20
76.1 3.000	96.8 3.81	65.8 2.59	89.4 3.52
88.9 3.500	109.0 4.29	+ +	89.9 3.54
108.0 4.250	120.7 4.75	81.0 3.19	108.0 4.25
133.0 5.236	150.9 5.94	+ +	150.9 5.94
159.0 6.260	176.3 6.94	92.2 3.63	176.3 6.94

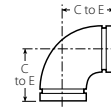

No. 610 (European Standard) 90° Elbow



No. 611 (European Standard) 45° Elbow

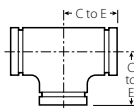

No. 620 (European Standard) Tee

+ Contact Victaulic for details



FITTINGS FOR COPPER TUBING

No. 625 – Grooved x Grooved x Grooved Reducing Tee

No. 626 – Grooved x Grooved x Cup Reducing Tee

Size			No. 625		No. 626		
			Grv. x Grv. x Grv.		Grv. x Grv. x Cup		
Nominal inches/ Actual mm			C to E inches/ mm	C to B inches/ mm	C to E inches/ mm	C to B inches/ mm	Cup inches/ mm
2 x 2 54.0 x 54.0	2 x 2 54.0 x 54.0	x ¾ x 22.2	—	—	2.20 55.9	1.98 50.3	0.75 19.1
		x 1 x 28.6	—	—	2.33 59.2	2.20 55.9	0.91 23.1
		x 1¼ x 34.9	—	—	2.48 63.0	2.35 59.7	0.97 24.6
		x 1½ x 41.3	—	—	2.55 64.8	2.28 57.9	1.09 27.7
		x 2 x 54.0	3.28 83.3	3.38 85.9	—	—	—
2½ x 2½ 66.7 x 66.7	2½ x 2½ 66.7 x 66.7	x 1 x 28.6	—	—	2.40 61.0	2.40 61.0	0.91 23.1
		x 1¼ x 34.9	—	—	2.52 64.0	2.57 65.3	0.97 24.6
		x 1½ x 41.3	—	—	2.70 68.6	2.68 68.1	1.09 27.7
		x 2 x 54.0	3.00 76.2	3.38 85.9	—	—	—
		x 2½ x 66.7	3.25 82.6	3.50 88.9	—	—	—
3 x 3 79.4 x 79.4	3 x 3 79.4 x 79.4	x 1 x 28.6	—	—	2.54 64.5	2.79 70.9	0.91 23.1
		x 1¼ x 34.9	—	—	2.63 66.8	2.89 73.4	0.97 24.6
		x 1½ x 41.3	—	—	2.85 72.4	3.00 76.2	1.09 27.7
		x 2 x 54.0	3.00 76.2	3.38 85.9	—	—	—
		x 2½ x 66.7	3.25 82.6	3.50 88.9	—	—	—
4 x 4 104.8 x 104.8	4 x 4 104.8 x 104.8	x 1 x 28.6	—	—	3.10 78.7	3.22 81.8	0.91 23.1
		x 1¼ x 34.9	—	—	3.25 82.6	3.47 88.1	0.97 24.6
		x 1½ x 41.3	—	—	3.25 85.1	3.65 92.7	1.09 27.7
		x 2 x 54.0	3.66 93.0	4.13 104.9	—	—	—
		x 2½ x 66.7	3.94 100.1	4.06 103.1	—	—	—
		x 3 x 79.4	4.19 106.4	4.16 105.7	—	—	—
5 x 5 130.2 x 130.2	5 x 5 130.2 x 130.2	x 3 x 79.4	3.75 95.3	4.63 117.6	—	—	—
		x 4 x 104.8	4.25 108.0	4.56 115.8	—	—	—
6 x 6 155.6 x 155.6	6 x 6 155.6 x 155.6	x 2½ x 66.7	3.63 92.2	5.13 130.3	—	—	—
		x 3 x 79.4	3.69 93.7	5.19 131.8	—	—	—
		x 4 x 104.8	4.19 106.4	5.13 130.3	—	—	—
		x 5 x 130.2	4.69 119.1	5.19 131.8	—	—	—
		x 6 x 155.6	5.19 131.8	5.19 131.8	—	—	—

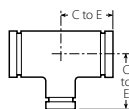

No. 625

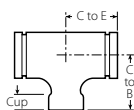

No. 626

FITTINGS FOR COPPER TUBING

No. 625 (European Standard) – Grooved x Grooved x Grooved Reducing Tee

Grv. x Grv. x Grv.				C to E mm/inches			
Nominal Size mm/ Actual inches							
67.0 2.625	x	67.0 2.625	x 54.0 2.125	83.1 3.27			
76.1 3.000	x	76.1 3.000	x 54.0 2.125	75.9 2.99			
			x 66.7 2.626	83.1 3.27			
			x 76.1 3.000	100.1 3.94			
108.0 4.252	x	108.0 4.252	x 66.7 2.626	105.9 4.17			
			x 76.1 3.000	105.9 4.17			
133.0 5.236	x	133.0 5.236	x 54.0 2.125	+ +			
			x 67.0 2.626	+ +			
			x 76.1	+			
			x 3.000	+			
			x 108.0	+			
			x 4.252	+			
			159.0 6.260	x	159.0 6.260	x 54.0 2.125	+ +
						x 66.7 2.626	+ +
x 76.1	+						
x 3.000	+						
x 108.0	105.9						
x 4.252	4.17						
x 133.0	119.1						
x 5.236	4.69						

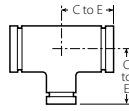

**No. 625
(European
Standard)**

+ Contact Victaulic for details

FITTINGS FOR COPPER TUBING

No. 626 (European Standard) – Grooved x Grooved x Cup Reducing Tee

Grv. x Grv. x Cup			C to E inches/ mm	C to B inches/ mm	Cup inches/ mm
Nominal Size mm/ Actual inches					
54.0 x 54.0 x 35.0	2.125 x 2.125 x 1.378	x 1.378	125.0	78.0	24.9
x 42.0			4.92	3.07	0.98
x 1.654			4.92	3.07	29.0
67.0 x 67.0 x 35.0	2.626 x 2.626 x 1.378	x 1.378	125.0	85.1	24.9
x 42.0			4.92	3.35	0.98
x 1.654			4.92	3.35	29.0
76.1 x 76.1 x 35.0	3.000 x 3.000 x 1.378	x 1.378	125.0	88.9	24.9
x 42.0			4.92	3.50	0.98
x 1.654			4.92	3.50	29.0
108.0 x 108.0 x 35.0	4.252 x 4.252 x 1.378	x 1.378	150.1	104.9	24.9
x 42.0			5.91	4.13	0.98
x 1.654			4.06	3.94	41.9
133.0 x 133.0 x 35.0	5.236 x 5.236 x 1.378	x 1.378	99.1	96.0	24.9
x 42.0			3.90	3.78	0.98
x 1.654			4.06	3.94	41.9
159.0 x 159.0 x 35.0	6.260 x 6.260 x 1.378	x 1.378	99.1	109.0	24.9
x 42.0			3.90	4.29	0.98
x 1.654			4.06	4.45	29.0

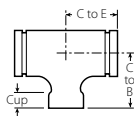

**No. 626
(European
Standard)**

FITTINGS FOR COPPER TUBING

No. 650 – Grooved x Grooved Reducer

No. 652 – Grooved x Cup Reducer

Size	No. 650 Grooved x Grooved		No. 652 Grooved x Cup	
	Nominal Size inches/Actual mm	E to E inches/mm	E to E inches/mm	Cup inches/mm
2 x 1 54.0 x 28.6	—	2.70 68.6	0.91 23.1	
x 1¼ x 34.9	—	3.00 76.2	0.97 24.6	
x 1½ x 41.3	—	2.94 74.7	1.09 27.7	
2½ x 1 66.7 x 28.6	—	3.25 82.6	0.91 23.1	
x 1¼ x 34.9	—	3.52 89.4	0.97 24.6	
x 1½ x 41.3	—	3.45 87.6	1.09 27.7	
x 2 x 54.0	3.29 83.6	3.30 83.8	1.34 34.0	
3 x 1½ 79.4 x 41.3	—	3.68 93.5	1.09 27.7	
x 2 x 54.0	2.50 63.5	4.10 104.1	1.34 34.0	
x 2½ x 66.7	3.38 85.9	—	—	
4 x 2 104.8 x 54.0	4.75 120.7	4.75 120.7	1.34 34.0	
x 2½ x 66.7	3.00 76.2	—	—	
x 3 x 79.4	3.00 76.2	—	—	
5 x 3 130.2 x 79.4	3.88 98.6	—	—	
x 4 x 104.8	3.38 85.9	—	—	
6 x 3 155.6 x 79.4	4.38 111.3	—	—	
x 4 x 104.8	3.88 98.6	—	—	
x 5 x 130.2	3.38 85.9	—	—	
8 x 6 206.4 x 155.6	5.00 127.0	—	—	



No. 650

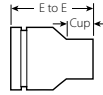

No. 652

FITTINGS FOR COPPER TUBING

No. 650 (European Standard) – Grooved x Grooved Reducer

No. 652 (European Standard) – Grooved x Cup Reducer

Size		No. 650 Grooved x Grooved		No. 652 Grooved x Cup	
Nominal Size mm/ Actual inches		E to E mm/inches	E to E mm/inches	Cup mm/inches	
54.0 x 35.0 #		+	+	-	
2.125 x 1.378		+	+	-	
x 42.0 #		74.9	74.9	-	
x 1.654		2.95	2.95	-	
64.0 x 54.0		+	+	-	
2.250 x 2.125		+	+	-	
66.7 x 35.0 #		+	+	-	
2.626 x 1.378		+	+	-	
x 42.0 #		87.9	87.9	-	
x 1.654		3.46	3.46	-	
x 54.0		83.1	83.1	86.1	
x 2.125		3.27	3.27	3.39	
76.1 x 54.0		64.0	64.0	-	
3.000 x 2.125		2.52	2.52	-	
x 64.0		64.0	64.0	-	
x 2.250		2.52	2.52	-	
x 66.7		64.0	64.0	-	
x 2.626		2.52	2.52	-	
88.9 x 54.0		75.9	75.9	-	
3.500 x 2.125		2.99	2.99	-	
x 64.0		+	+	-	
x 2.250		+	+	-	
x 76.1		75.9	75.9	-	
x 3.000		2.99	2.99	-	
108.0 x 54.0		+	+	-	
4.252 x 2.125		+	+	-	
x 64.0		+	+	-	
x 2.250		+	+	-	
x 66.7		75.9	75.9	-	
x 2.626		2.99	2.99	-	
x 76.1		75.9	75.9	-	
x 3.000		2.99	2.99	-	
x 88.9		75.9	75.9	-	
x 3.500		2.99	2.99	-	
133.0 x 76.1		+	+	-	
5.236 x 3.000		+	+	-	
x 108.0		+	+	-	
x 4.252		+	+	-	
159.0 x 54.0		+	+	-	
6.260 x 2.125		+	+	-	
x 66.7		+	+	-	
x 2.626		+	+	-	
x 76.1		+	+	-	
x 3.000		+	+	-	
x 108.0		+	+	-	
x 4.252		+	+	-	
x 133.0		+	+	-	
x 5.236		+	+	-	



No. 650 (European Standard)

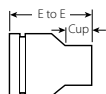

No. 652 (European Standard)

No. 652; Cup Connection

+ Contact Victaulic for details



FITTINGS FOR COPPER TUBING

No. 660 – Cap

Copper Tubing Size	Thickness "T" inches/mm
2 54.0	0.96 24.4
2½ 66.7	0.96 24.4
3 79.4	0.96 24.4
4 104.8	0.96 24.4
5 130.2	0.96 24.4
6 155.6	0.96 24.4



No. 660

No. 660 (European Standard) – Cap

Copper Tubing Size	Thickness "T" mm/inches
54.0 2.125	24.4 0.96
64.0 2.250	+ +
66.7 2.625	24.4 0.96
76.1 3.000	+ +
88.9 3.500	24.4 0.96
108.0 4.250	24.4 0.96
133.0 5.236	+ +
159.0 6.260	+ +



No. 660 (European Standard)

+ Contact Victaulic for details

VALVE FOR GROOVED-END COPPER TUBING

Series 608 – Butterfly Valve

Copper Tubing Size	“A” End-To-End Dimension	“B” Overall Height Dimension
Nominal Size inches/mm	inches/mm	inches/mm
2½ 66.7	3.77 95.8	6.12 155.4
3 79.4	3.77 95.8	6.58 167.1
4 104.8	4.63 117.6	9.25 235.0
5 130.2	5.88 149.4	10.13 257.3
6 155.6	5.88 149.4	11.15 283.2

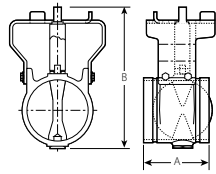

Series 608

Style 608 (Australian Standard) – Butterfly Valve

Copper Tubing Size	“A” End-To-End Dimension	“B” Overall Height Dimension
Nominal Size (Actual Size)	inches/mm	inches/mm
DN 65 (63.5)	95.8 3.77	151.9 5.98
DN 80 (76.2)	95.8 3.77	164.1 6.46
DN 100 (101.6)	117.6 4.63	226.3 8.91
DN 125 (127.0)	149.4 5.88	249.4 9.82
DN 150 (152.4)	150.1 5.91	273.6 10.77

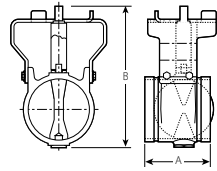

Series 608 (Australian Standard)

Series 608 (European Standard) – Butterfly Valve

Copper Tubing Size	“A” End-To-End Dimension	“B” Overall Height Dimension
Nominal Size mm/ Actual inches	inches/mm	inches/mm
66.7	95.8	121.2
2.625	3.77	4.77
76.1	95.8	136.9
3.000	3.77	5.39

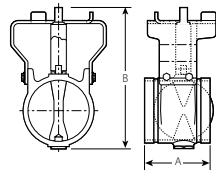

Series 608 (European Standard)

ACCESSORY FOR GROOVED-END COPPER TUBING

Style 47-GG Grooved X Grooved Dielectric Waterway (Grooved-End Steel to Grooved Copper Transition)

Size			End-to-End Dimension
Nominal Size inches/mm	Actual Outside Diameter inches/mm		inches/mm
	Steel (IPS)	Copper (CTS)	
2 50	2.375 60.3	2.125 54	4.19 106.4
2½ 65	2.875 73.0	2.625 66.7	6.19 157.2
3 80	3.500 88.9	3.125 79.4	6.19 157.2
4 100	4.500 114.3	4.125 104.8	6.19 157.2
5 125	5.563 141.3	5.125 130.2	6.19 157.2
6 150	6.625 168.3	6.125 155.6	6.19 157.2
8 200	8.625 219.1	8.125 206.4	6.19 157.2



**Style 47-GG
Grooved X
Grooved**

PERMALYNX PERMANENT PUSH-TO-CONNECT SYSTEM FOR COPPER TUBING

Refer to the current revision of Victaulic publication 22.20 for information regarding PermaLynx product dimensions.

Helpful Information

English and Metric Conversion Chart

Commercial Copper Tubing Sizes, Wall Thicknesses, and
Approximate Weights

Decimal Equivalents of Fractions

Water Pressure to Feet-of-Head

Feet-of-Head of Water to Pressure

Water Pressure to Meter Water Column

Meter Water Column to Pressure

ENGLISH AND METRIC CONVERSION CHART

Convert US to Metric		Convert Metric to US	
25.4 X inches (in)	=	millimeters (mm)	X 0.03937
0.3048 X feet (ft)	=	meters (m)	X 3.281
0.4536 X pounds (lbs)	=	kilograms (kg)	X 2.205
28.35 X ounces (oz)	=	grams (g)	X 0.03527
6.894 X pressure (psi)	=	kilopascals (kPa)	X 0.145
.069 X pressure	=	Bar	X 14.5
4.45 X end load (lbs)	=	Newtons (N)	X 0.2248
1.356 X torque (ft-lbs)	=	Newton meters (N·m)	X 0.738
F – 32 ÷ 1.8 temperature (°F)	=	Celsius (°C)	C ÷ 1.778 X 1.8
745.7 X horsepower (hp)	=	watts (W)	X 1.341 X 10 ⁻³
3.785 X gallons per minute (gpm)	=	liters per minute (l/m)	X 0.2642
3.7865 X 10 ⁻³ gallons per minute (gpm)	=	cubic meters per minute (m ³ /m)	X 264.2



**COMMERCIAL COPPER TUBING SIZES, WALL THICKNESSES, AND APPROXIMATE WEIGHTS –
 CTS US STANDARD (ASTM B-88) AND DWV PER ASTM B-306**

Copper Tubing Size		Type "K" ASTM B-88			Type "L" ASTM B-88			Type "M" ASTM B-88			DWV ASTM B-306	
Nominal Size inches/mm	Actual Outside Diameter inches/mm	Wall Thickness inches/mm	Approx. Weight lbs/ft kg/m	Wall Thickness inches/mm	Approx. Weight lbs/ft kg/m	Wall Thickness inches/mm	Approx. Weight lbs/ft kg/m	Wall Thickness inches/mm	Approx. Weight lbs/ft kg/m	Wall Thickness inches/mm	Approx. Weight lbs/ft kg/m	
2	2.125	0.083	2.1	0.070	1.8	0.058	1.5	0.042	1.1	—	—	
50	54.0	2.1	3.1	1.8	2.6	1.5	2.2	1.1	1.6	—	—	
2½	2.625	0.095	2.9	0.080	2.5	0.065	2.0	—	—	—	—	
65	66.7	2.4	4.4	2.0	3.7	1.7	3.0	—	—	—	—	
3	3.125	0.109	4.0	0.090	3.3	0.072	2.7	0.045	1.7	—	—	
80	79.4	2.8	5.9	2.3	4.9	1.8	4.0	1.1	2.5	—	—	
4	4.125	0.134	6.5	0.110	5.4	0.095	4.7	0.058	2.9	—	—	
100	104.8	2.8	9.7	2.8	8.0	2.4	7.0	1.5	4.3	—	—	
5	5.125	0.160	9.7	0.125	7.6	0.109	6.7	0.072	4.4	—	—	
125	130.2	4.1	14.4	3.2	11.3	2.8	9.9	1.8	6.6	—	—	
6	6.125	0.192	13.9	0.140	10.2	0.122	8.9	0.083	6.1	—	—	
150	155.6	4.9	20.7	3.6	15.7	3.2	13.3	2.1	9.1	—	—	
8	8.125	0.271	25.9	0.200	19.3	0.170	16.5	0.109	10.6	—	—	
200	206.4	6.9	38.5	5.1	28.7	4.3	24.6	2.8	15.8	—	—	

COMMERCIAL COPPER TUBING SIZES, WALL THICKNESSES, AND APPROXIMATE WEIGHTS – EUROPEAN STANDARD EN 1057 (HALF-HARD)

Copper Tubing Size			Recommended Wall Thicknesses and Weights									
European Standard Nominal Size mm	Actual Outside Diameter mm/inches		1.2 mm/ 0.047 inch	Approx. Weight kg/m lbs/ft	1.5 mm/ 0.059 inch	Approx. Weight kg/m lbs/ft	2.0 mm/ 0.078 inch	Approx. Weight kg/m lbs/ft	2.5 mm/ 0.098 inch	Approx. Weight kg/m lbs/ft	3.0 mm/ 0.118 inch	Approx. Weight kg/m lbs/ft
	Max.	Min.										
54	54.07	53.93	Rec.	1.8	Rec.	2.2	Rec.	3.0	Not Rec.	–	Not Rec.	–
	2.129	2.123		1.2		1.5		2.0		–		–
64	64.07	63.93	Not Rec.	–	Not Rec.	–	Rec.	3.4	Not Rec.	–	Not Rec.	–
	2.522	2.517		–		–		2.3		–		–
66.7	66.77	66.63	Rec.	2.2	Not Rec.	–	Rec.	3.6	Not Rec.	–	Not Rec.	–
	2.629	2.623		1.5		–		2.4		–		–
76.1	76.17	76.03	Not Rec.	–	Rec.	3.1	Rec.	4.2	Not Rec.	–	Not Rec.	–
	2.999	2.993		–		2.1		2.8		–		–
88.9	88.97	88.83	Not Rec.	–	Not Rec.	–	Rec.	4.9	Not Rec.	–	Not Rec.	–
	3.503	3.497		–		–		3.3		–		–
108	108.07	107.93	Not Rec.	–	Rec.	4.5	Not Rec.	–	Rec.	7.4	Not Rec.	–
	4.255	4.249		–		3.0		–		5.0		–
133	133.20	132.80	Not Rec.	–	Rec.	5.5	Not Rec.	–	Not Rec.	–	Rec.	10.9
	5.244	5.228		–		3.7		–		–		7.3
159	159.20	158.80	Not Rec.	–	Not Rec.	–	Rec.	8.8	Not Rec.	–	Rec.	13.1
	6.280	6.252		–		–		5.9		–		8.8

"Rec." = Recommended (the wall thickness is recommended for the particular copper tubing size)

"Not Rec." = Not Recommended (the wall thickness is not recommended for the particular copper tubing size)



COMMERCIAL COPPER TUBING SIZES, WALL THICKNESSES, AND APPROXIMATE WEIGHTS – AUSTRALIAN STANDARD AS 1432 TABLES A, B, AND D

Australian Standard Nominal Size (Actual Size)	Copper Tubing Size		Table 1, Type "A" (AS 1432)		Table 2, Type "B" (AS 1432)		Table 4, Type "D" (AS 1432)	
	Actual Outside Diameter mm/inches		Wall Thickness mm/inches	Approx. Weight kg/m lbs/ft	Wall Thickness mm/inches	Approx. Weight kg/m lbs/ft	Wall Thickness mm/inches	Approx. Weight kg/m lbs/ft
	Max.	Min.						
DN 50 (50.8)	50.80	50.67	1.6 0.063	2.2 1.5	1.2 0.047	1.6 1.1	0.9 0.035	1.2 0.8
	2.000	1.995						
DN 65 (63.5)	63.50	63.35	1.6 0.063	2.8 1.9	1.2 0.047	2.1 1.4	0.9 0.035	1.6 1.1
	2.500	2.494						
DN 80 (76.2)	76.20	76.02	2.0 0.079	4.2 2.8	1.6 0.063	3.3 2.2	1.2 0.047	2.5 1.7
	3.000	2.993						
DN 100 (101.6)	101.60	101.35	2.0 0.079	5.5 3.7	1.6 0.063	4.5 3.0	1.2 0.047	3.4 2.3
	4.000	3.990						
DN 125 (127.0)	127.00	126.75	2.0 0.079	7.0 4.7	1.6 0.063	5.7 3.8	1.4 0.055	4.9 3.3
	5.000	4.990						
DN 150 (152.4)	152.40	152.10	2.6 0.102	10.9 7.3	2.0 0.079	8.5 5.7	1.6 0.063	6.7 4.5
	6.000	5.988						

DECIMAL EQUIVALENTS OF FRACTIONS

Fraction in inches	Decimal Equivalent inches	Decimal Equivalent millimeters
$\frac{1}{64}$	0.016	0.397
$\frac{1}{32}$	0.031	0.794
$\frac{3}{64}$	0.047	1.191
$\frac{1}{16}$	0.063	1.588
$\frac{5}{64}$	0.781	1.984
$\frac{3}{32}$	0.094	2.381
$\frac{7}{64}$	0.109	2.778
$\frac{1}{8}$	0.125	3.175
$\frac{9}{64}$	0.141	3.572
$\frac{5}{32}$	0.156	3.969
$\frac{11}{64}$	0.172	4.366
$\frac{3}{16}$	0.188	4.763
$\frac{13}{64}$	0.203	5.159
$\frac{7}{32}$	0.219	5.556
$\frac{15}{64}$	0.234	5.953
$\frac{1}{4}$	0.250	6.350
$\frac{17}{64}$	0.266	6.747
$\frac{9}{32}$	0.281	7.144
$\frac{19}{64}$	0.297	7.541
$\frac{5}{16}$	0.313	7.938
$\frac{21}{64}$	0.328	8.334
$\frac{1}{3}$	0.333	8.467
$\frac{11}{32}$	0.344	8.731
$\frac{23}{64}$	0.359	9.128
$\frac{3}{8}$	0.375	9.525
$\frac{25}{64}$	0.391	9.922
$\frac{13}{32}$	0.406	10.319
$\frac{27}{64}$	0.422	10.716
$\frac{7}{16}$	0.438	11.113
$\frac{29}{64}$	0.453	11.509
$\frac{15}{32}$	0.469	11.906
$\frac{1}{2}$	0.500	12.700

Fraction in inches	Decimal Equivalent inches	Decimal Equivalent millimeters
$\frac{33}{64}$	0.516	13.097
$\frac{17}{32}$	0.531	13.494
$\frac{35}{64}$	0.547	13.891
$\frac{9}{16}$	0.563	14.288
$\frac{37}{64}$	0.578	14.684
$\frac{19}{32}$	0.594	15.081
$\frac{39}{64}$	0.609	15.478
$\frac{5}{8}$	0.625	15.875
$\frac{41}{64}$	0.641	16.272
$\frac{21}{32}$	0.656	16.669
$\frac{43}{64}$	0.672	17.066
$\frac{11}{16}$	0.688	17.463
$\frac{45}{64}$	0.703	17.859
$\frac{23}{32}$	0.719	18.256
$\frac{47}{64}$	0.734	18.653
$\frac{3}{4}$	0.750	19.050
$\frac{49}{64}$	0.766	19.447
$\frac{25}{32}$	0.781	19.844
$\frac{51}{64}$	0.797	20.241
$\frac{13}{16}$	0.813	20.638
$\frac{53}{64}$	0.828	21.034
$\frac{27}{32}$	0.844	21.431
$\frac{55}{64}$	0.859	21.828
$\frac{7}{8}$	0.875	22.225
$\frac{57}{64}$	0.891	22.622
$\frac{29}{32}$	0.906	23.019
$\frac{59}{64}$	0.922	23.416
$\frac{15}{16}$	0.938	23.813
$\frac{61}{64}$	0.953	24.209
$\frac{31}{32}$	0.969	24.606
$\frac{63}{64}$	0.984	25.003
1	1.000	25.400

WATER PRESSURE TO FEET-OF-HEAD

Pounds Per Square Inch	Feet of Head
1	2.31
2	4.62
3	6.93
4	9.24
5	11.54
6	13.85
7	16.16
8	18.47
9	20.78
10	23.09
15	34.63
20	46.18
25	57.72
30	69.27
40	92.36
50	115.45
60	138.54
70	161.63
80	184.72
90	207.81

Pounds Per Square Inch	Feet of Head
100	230.90
110	253.93
120	277.07
130	300.16
140	323.25
150	346.34
160	369.43
170	392.52
180	415.61
200	461.78
250	577.24
300	692.69
350	808.13
400	922.58
500	1154.48
600	1385.39
700	1616.30
800	1847.20
900	2078.10
1000	2309.00

FEET-OF-HEAD OF WATER TO PRESSURE

Feet of Head	Pounds Per Square Inch
1	0.43
2	0.87
3	1.30
4	1.73
5	2.17
6	2.60
7	3.03
8	3.46
9	3.90
10	4.33
15	6.50
20	8.66
25	10.83
30	12.99
40	17.32
50	21.65
60	25.99
70	30.32
80	34.65
90	39.98

Feet of Head	Pounds Per Square Inch
100	43.31
110	47.64
120	51.97
130	56.30
140	60.63
150	64.96
160	69.29
170	73.63
180	77.96
200	86.62
250	108.27
300	129.93
350	151.58
400	173.24
500	216.55
600	259.85
700	303.16
800	346.47
900	389.78
1000	433.00

WATER PRESSURE TO METER WATER COLUMN

kPa	Meter Water Column
10	1.02
15	1.53
20	2.04
25	2.55
30	3.06
40	4.08
50	5.10
60	6.12
70	7.14
80	8.16
90	9.18
100	10.20
110	11.22
120	12.24
130	13.26
140	14.28
150	15.30
160	16.32
170	17.34
180	18.36

kPa	Meter Water Column
180	18.36
190	19.38
200	20.40
250	25.50
300	30.60
400	40.80
500	51.00
600	61.20
700	71.40
800	81.60
900	91.80
1000	102.00
1500	153.00
2000	204.00
2500	255.00
3000	306.00
4000	408.00
5000	510.00
6000	612.00
7000	714.00

METER WATER COLUMN TO PRESSURE

Meter Water Column	kPa
1	9.8
2	19.6
3	29.4
4	39.2
5	49.0
6	58.8
7	68.6
8	78.4
9	88.2
10	98.0
11	108.0
12	118.0
13	127.0
14	137.0
15	147.0
20	196.0
25	245.0
30	294.0
35	343.0
40	392.0

Meter Water Column	kPa
45	441.0
50	490.0
55	539.0
60	588.0
70	686.0
80	784.0
90	882.0
100	980.0
150	1470.0
200	1960.0
250	2450.0
300	2940.0
350	3430.0
400	3920.0
450	4410.0
500	4900.0
550	5390.0
600	5880.0
650	6370.0
700	6860.0

NOTES

NOTES

VICTAULIC® GLOBAL CONTACT INFORMATION

**UNITED STATES AND
WORLD HEADQUARTERS**

4901 Kesslersville Road
Easton, PA 18040 USA

1 800 PICK VIC
1 800 742 5842
(within North America)
1 610 559 3300

pickvic@victaulic.com

CANADA

123 Newkirk Road
Richmond Hill
Ontario L4C 3G5 Canada
1 905 884 7444

viccanada@victaulic.com

MEXICO

Calle Circuito del Marqués
No 8 al 11
Parque Industrial El Marqués
Municipio El Marqués
Queretaro, Mexico
CP 76246

52 442 253 0066

vic@victaulic.com

BRAZIL

Av. Marquês de São Vicente
446 Cj 1303
Várzea da Barra Funda –
São Paulo-SP
CEP 01139-000 – Brazil
55 11 3548 4280

vicbr@victaulic.com

**BELGIUM
EUROPE HEADQUARTERS**

Prijkelstraat 36
9810 Nazareth, Belgium
32 9 381 15 00

49 6151 9573 0
(within Germany)

viceuro@victaulic.com

UNITED KINGDOM

Units B1 & B2, SG1 Industrial Park
Cockerell Close, Gunnels Wood Road
Stevenage, Hertfordshire, UK
SG 1 2NB

44 1438 310 690

viceuro@victaulic.com

UNITED ARAB EMIRATES

P.O. Box 17683, Unit XB 8
Jebel Ali Free Zone
Dubai, United Arab Emirates
971 4 883 88 70

viceuro@victaulic.com

INDIA

India Land Global Industrial Park
Plot 4, Hinjewadi, Phase-1, Mulshi
Pune 411057, India
91 20 67 919 300

viceuro@victaulic.com

CHINA

Unit 808, Building B
Hongwell International Plaza
No.1602 West Zhongshan Road
Shanghai, China 200235

86 21 6021 9400

vicap@victaulic.com

KOREA

4F, Seoil Building, 1430-5,
Seocho-Dong, Seocho-Gu
Seoul, Korea 137-070

82 2 521 7235

vicap@victaulic.com

TAIWAN

No. 55, NanGong Rd, LuZhu District
TaoYuan City 338, Taiwan
886 3 222 3220

vicap@victaulic.com

**AUSTRALIA AND
NEW ZEALAND**

7 Chambers Road
Unit 1
Altona North, Victoria
Australia 3025

1 300 PIC VIC
1 300 742 842
(within Australia)

0 508 PICK VIC
0 508 7425 842
(within New Zealand)

61 3 9392 4000

vicaust@victaulic.com

For additional locations, information, and support,
visit www.victaulic.com/contactus

UPDATED 5/2009

I-600 3700 REV. B Z000600PHB

VICTAULIC IS A REGISTERED TRADEMARK OF VICTAULIC COMPANY.

© 2009 VICTAULIC COMPANY. ALL RIGHTS RESERVED.

