

MAX-DRIVE

V-BELTS

OIL & HEAT RESISTANT

Rugged polyester cord and neoprene construction with specially treated natural and synthetic elastomeric compounds make the **MAX-DRIVE** V-belt the ideal choice for heavy loads under extreme heat or for constant exposure to oil.

When replacing a V-belt, always clean pulley grooves and check that shafts are parallel and pulley alignment is correct.

Standard V-Belt Types

	3L	4L	5L
W	3/8"	1/2"	21/32"

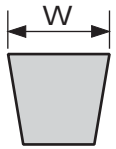

Outside Length (inches)	 No.		
	3L	4L	5L
20	S30-20	S40-20	-
21	S30-21	S40-21	-
22	S30-22	S40-22	-
23	S30-23	S40-23	S50-23
24	S30-24	S40-24	S50-24
25	S30-25	S40-25	S50-25
26	S30-26	S40-26	S50-26
27	S30-27	S40-27	S50-27
28	S30-28	S40-28	S50-28
29	S30-29	S40-29	S50-29
30	S30-30	S40-30	S50-30
31	S30-31	S40-31	S50-31
32	S30-32	S40-32	S50-32
33	S30-33	S40-33	S50-33
34	S30-34	S40-34	S50-34
35	S30-35	S40-35	S50-35
36	S30-36	S40-36	S50-36
37	S30-37	S40-37	S50-37
38	S30-38	S40-38	S50-38
39	S30-39	S40-39	S50-39

Outside Length (inches)	 No.		
	3L	4L	5L
40	S30-40	S40-40	S50-40
41	S30-41	S40-41	S50-41
42	S30-42	S40-42	S50-42
43	S30-43	S40-43	S50-43
44	S30-44	S40-44	S50-44
45	S30-45	S40-45	S50-45
46	S30-46	S40-46	S50-46
47	S30-47	S40-47	S50-47
48	S30-48	S40-48	S50-48
49	S30-49	S40-49	S50-49
50	S30-50	S40-50	S50-50
51	S30-51	S40-51	S50-51
52	S30-52	S40-52	S50-52
53	S30-53	S40-53	S50-53
54	S30-54	S40-54	S50-54
55	S30-55	S40-55	S50-55
56	S30-56	S40-56	S50-56
57	S30-57	S40-57	S50-57
58	S30-58	S40-58	S50-58
59	S30-59	S40-59	S50-59
60	S30-60	S40-60	S50-60



SPECIAL FOR LENNOX BURNER

 No.	Ref. No.	Lennox Burner No.	Belt Type	Outside Length
S20-16	VB-1049	DV-1049	2L - Cogged	16"

Westwood ceramic fibre chambers

SOUND ABSORBING • RED HOT IN SECONDS • FIRES DRY • 2,300° - 3,000°F

WET COMBUSTION CHAMBER LINERS - Sealed in a plastic bag and individually boxed*

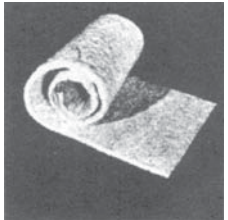

 No.	Ref. No.	Type		GPH	Description and Representative Picture	
S70-9 S70-10 S70-11 S70-12 S70-13 S70-15	#9 #10 #11 #12 #13 #15	Wet	Westwood Round - Preshaped	.50 - .75	9" diameter, 12" high	
				.85 - 1.00	10" diameter, 12" high	
				1.10 - 1.25	11" diameter, 12" high	
				1.35 - 1.50	12" diameter, 12" high	
				1.65 - 1.85	13" diameter, 14" high	
				2.00 - 2.50	15" diameter, 14" high	
S70-25 S70-27	#135 #200	Wet	Westwood Rect. - Preshaped	.75 - 1.35	14" x 11" x 12"	
				1.35 - 2.00	14" x 12" x 12"	
S70-30 S70-35 S70-40 S70-45	#1 #2 #3 #4	Wet	Westwood Flat sheet(s)	1.25	(1) - 14" x 48"	
				2.50	(1) - 14" x 48" (1) - 16" x 16"	
				2.65	(1) - 16" x 48" (1) - 16" x 16"	
				1.25	(1) - 16" x 48"	

*Wet chambers have a shelf life and should be ordered such that they are not held in inventory longer than 6 months.

J-M Cerafelt™

Dry Refractory Liners

DRY COMBUSTION CHAMBER LINERS

 No.	Ref. No.	Type		GPH	Description and Representative Picture	
S70-50 S70-51 S70-52	141608 141612 144824	Dry	Cerafelt blanket	-	1/4" x 16" x 8 ft.	
				-	1/4" x 16" x 12 ft.	
				-	1/4" x 48" x 25 ft.	
S70-60	SS Kit	Dry	Cerafelt SS Kit (For lining burned out stainless steel combustion chambers)	.50 - 1.75	(1) - 14" x 48" (1) - 16" x 33" (8) - Stainless Steel Clips	

Westwood

HIGH TEMPERATURE ROPE

NON-ASBESTOS • KNITTED FIBERGLASS

This strong, flexible, resilient knit-braided rope is ideal for industrial boilers, cast iron boilers, wood burning stoves, ovens, and furnaces. Will not "bloom" or untwist like braided twisted glass rope. Made of 100% texturized fiberglass, it will not burn or support combustion. Resists temperatures to 1,000° F.

**NON-ASBESTOS HIGH TEMPERATURE ROPE**

 No.	Type	Description	Length
S70-101	Round	1/4" diameter	10 ft.
S70-102	Round	1/4" diameter	25 ft.
S70-104	Round	3/8" diameter	10 ft.
S70-106	Round	3/8" diameter	25 ft.
S70-108	Round	1/2" diameter	10 ft.
S70-110	Round	1/2" diameter	25 ft.
S70-111	Round	3/4" diameter	10 ft.
S70-112	Round	3/4" diameter	25 ft.
S70-114	Round	1" diameter	10 ft.
S70-116	Round	1" diameter	25 ft.
S70-140	Flat	1" wide x 1/8" thick	25 ft.
S70-142	Flat	1" wide x 1/8" thick with adhesive backing	100 ft.
S70-150	Flat	2" wide x 1/8" thick	25 ft.
S70-152	Flat	2" wide x 1/8" thick with adhesive backing	100 ft.

Other types and sizes of high temperature materials are available on special order. Consult the factory for price and availability.

BECKETT BURNER FLANGE GASKET

 No.	Description
S70-170	Gasket for Beckett and Aero burner flange 8-1/2" OD x 3-5/16" ID

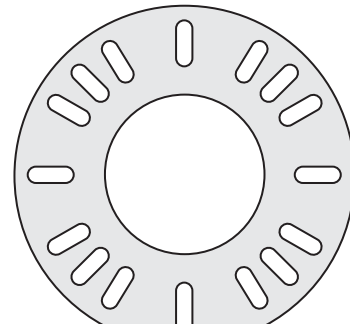

Westwood ONE PIECE MOTOR COUPLINGS

HEAVY DUTY FOR GENERAL USE ON BURNERS AND MOTOR DRIVEN EQUIPMENT



Rugged, precision machined end pieces are held in place by heavy steel collars. Set screws at each end insure that there is no slippage on the shaft flats. Quiet, noise and vibration absorbing, these premium couplings out-perform conventional couplings where misalignment exists or where punishing service is the norm. Available for 1/2" x 7/16" and 1/2" x 5/16" shaft sizes, or 7/16" shaft x spline socket.

ONE PIECE COUPLINGS

Length	No.		
	1/2" x 7/16"	1/2" x 5/16"	7/16" x Spline
2"	S80-200*	S81-200*	-
2-3/8"	S80-237	S81-237*	-
2-1/2"	S80-250*	S81-250*	-
3"	S80-300*	S81-300*	S82-300*
3-1/4"	S80-325	S81-325*	S82-325
3-3/8"	S80-337	S81-337*	S82-337
3-1/2"	S80-350*	S81-350	S82-350
4"	S80-400*	S81-400	S82-400*
4-1/2"	S80-450*	S81-450	S82-450
5"	S80-500	S81-500	S82-500*
5-1/2"	S80-550	S81-550	S82-550
6"	S80-600	S81-600	S82-600
6-1/2"	S80-650	S81-650	S82-650
7"	S80-700	S81-700	S82-700
7-1/2"	S80-750	S81-750	S82-750
8"	S80-800	S81-800	S82-800

* Included in One Piece Coupling Kit No. S83-200, shown below

REDUCER BUSHING & COUPLING KIT

No.	Ref. No.	Description
S83-10	Reducer Bushing	5/16" I.D. x 7/16" O.D. bushing
S83-200	1890	One piece coupling kit containing those couplings marked with an asterisk above, plus (6) S83-10 reducer bushings

Westwood

Nylo-Flex™ BURNER COUPLINGS

EASILY INSTALLED 3 PIECE COUPLING • NO SET SCREWS



Cut

Assemble

Chosen by top service professionals and original equipment (oem) burner manufacturers. Three piece design allows for custom fit in all installations.

Nylo-Flex™ COMPONENTS

W/P No.	Reference No.	Description and Representative Picture
S85-6	6" Nyloshaft	Nylo-Flex™ 6" Nyloshaft center piece
S85-10	10" Nyloshaft	Nylo-Flex™ 10" Nyloshaft center piece
S85-12	12" Nyloshaft	Nylo-Flex™ 12" Nyloshaft center piece
S85-15	15" Nyloshaft	Nylo-Flex™ 15" Nyloshaft center piece
S85-30	30" Nyloshaft	Nylo-Flex™ 30" Nyloshaft center piece
S85-100	Red End Fitting	Nylo-Flex™ 5/16" shaft size end piece, RED
S85-110	Blue End Fitting	Nylo-Flex™ 7/16" shaft size end piece, BLUE
S85-120	Black End Fitting	Nylo-Flex™ 1/2" shaft size end piece, BLACK
S85-130	TA	Nylo-Flex™ Torrington adapter, 1/2" shaft

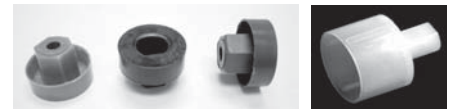

Nylo-Flex™ OEM SPEC COUPLINGS*

Two end pieces, plus a Nyloshaft correctly cut to OEM specs

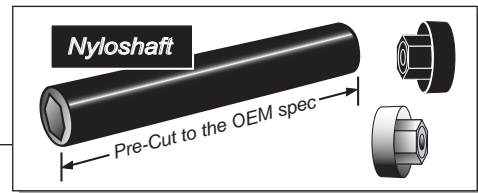

W/P No.	Description
S85-200	Nylo-Flex™ Pre-cut Coupling for Beckett AF (2454), 1/2" & 5/16" Ends, 3-13/32" Nyloshaft
S85-210	Nylo-Flex™ Pre-cut Coupling for Beckett (2290), 1/2" & 5/16" Ends, 2-7/8" Nyloshaft
S85-220	Nylo-Flex™ Pre-cut Coupling for Carlin 99-100 (99RA10208), 1/2" & 5/16" Ends, 2-3/16" Nyloshaft
S85-222	Nylo-Flex™ Pre-cut Coupling for Carlin (99RA5220), 1/2" & 7/16" Ends, 3-1/16" Nyloshaft
S85-223	Nylo-Flex™ Pre-cut Coupling for Carlin CRDA (1020J), 1/2" & 7/16" Ends, 2-3/4" Nyloshaft
S85-224	Nylo-Flex™ Pre-cut Coupling for Carlin 1020 (A Pump), 1/2" & 5/16" Ends, 2-11/32" Nyloshaft
S85-225	Nylo-Flex™ Pre-cut Coupling for Ducane (B1011503), 1/2" & 5/16" Ends, 3-13/16" Nyloshaft
S85-227	Nylo-Flex™ Pre-cut Coupling for Lennox (65A4101), 1/2" & 5/16" Ends, 3-5/8" Nyloshaft
S85-229	Nylo-Flex™ Pre-cut Coupling for Wayne E (13279), 1/2" & 5/16" Ends, 4-5/16" Nyloshaft
S85-230	Nylo-Flex™ Pre-cut Coupling for Wayne (13424), 1/2" & 5/16" Ends, 3-13/16" Nyloshaft
S85-231	Nylo-Flex™ Pre-cut Coupling for Wayne M, 1/2" & 5/16" Ends, 3-1/4" Nyloshaft

* Each coupling individually sealed in a plastic bag and labeled



Nylo-Flex™ COUPLING KITS on page S6

Please order by No.

Westwood

Nylo-Flex™ BURNER COUPLINGS

THE WIDEST SELECTION TO MEET ALL SERVICING NEEDS

COUPLING
KITS



 No. S85-550



 No. S85-560



 No. S85-525

Nylo-Flex™ COUPLING KITS

 No.	Ref. No.	Quantity of End Pieces			Nyloshaft Quantity & Length	S85-130 Torrington Adapter	T100-300 Coupler Popper™	T100-310 Coupling Cutter	Molded Plastic Box
		1/2"	7/16"	5/16"					
S85-500	#88	1	1	1	1 - 6"	-	-	-	-
S85-502	-	1	1	1	1 - 12"	-	-	-	-
S85-510	#99A	2	2	1	1 - 6"	-	-	-	-
S85-520	#101	2	1	2	1 - 6"	-	-	-	-
S85-525	-	8	6	5	6 - 6"	-	-	-	-
S85-530	#1240	16	8	8	8 - 9"	-	-	-	YES
S85-540	#1240C	16	8	8	8 - 9"	-	-	-	-
S85-550	#1242	16	8	8	8 - 9"	-	YES	YES	YES
S85-560	#1250	12	12	5	12 - 6"	5	-	-	-
S85-570	#1251	12	12	5	12 - 6"	5	YES	-	-

Westwood

BURNER TUNE-UP KITS

A REAL TIME SAVER FOR THE MOST POPULAR BURNERS

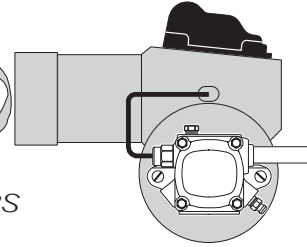
**TUNE-UP & ELECTRODE KITS**

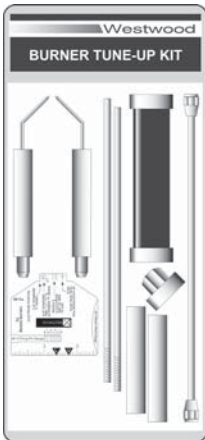
 No.	Ref. No.	Description
 No. S88-10	BK5780	TUNE-UP KIT for Beckett AF, AFG, AR, SF, SR (up to 9" air tube)
		2 - Electrode assemblies 1 - 12" oil line assembly 1 - Pump coupling kit S85-500
S88-12	NBK5780	TUNE-UP KIT for Beckett AF, AFG, AR, SF, SR (up to 9" air tube)
		2 - Electrode assemblies 1 - 12" oil line assembly 1 - Pump coupling kit S85-500 2 - Extension rods with nuts
S88-14	BK5782	TUNE-UP KIT for Beckett AF, AFG, AR, SF, SR (over 9" air tube)
		2 - Electrode assemblies 1 - 12" oil line assembly 2 - E5-2M4 insulators 1 - Pump coupling kit S85-500
S88-16	NBK5782	TUNE-UP KIT for Beckett AF, AFG, AR, SF, SR (over 9" air tube)
		2 - Electrode assemblies 1 - 12" oil line assembly 2 - E5-2M4 insulators 1 - Pump coupling kit S85-500
S88-20	W5780	ELECTRODE KIT for Beckett AF, AFG, SF, SR (up to 9" air tube)
		2 - Electrode assemblies 2 - Extension rods with nuts
S88-22	W5781	ELECTRODE KIT for Beckett A and S (up to 9" air tube)
		2 - Electrode assemblies 2 - Extension rods with nuts
S88-24	W5782	ELECTRODE KIT for Beckett AF, AFG, SF, SR (over 9" air tube)
		2 - Electrode assemblies 2 - Extension rods with nuts 2 - Insulators
S88-26	W5783	ELECTRODE KIT for Beckett AQ and S (over 9" air tube)
		2 - Electrode assemblies 2 - Extension rods with nuts
S88-28	W5940	ELECTRODE KIT for Beckett MB and MD (up to 9" air tube)
		2 - Electrode assemblies 2 - Extension rods with nuts

Packaging may vary from that shown

Please order by  No.

rev. 1-1-09

S7

Westwood

BURNER TUNE-UP KITS

A REAL TIME SAVER FOR THE MOST POPULAR BURNERS

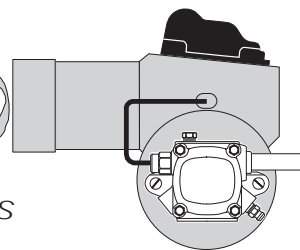
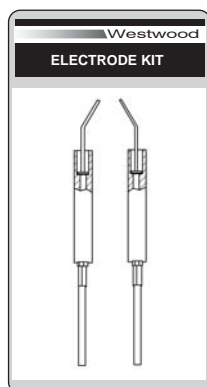
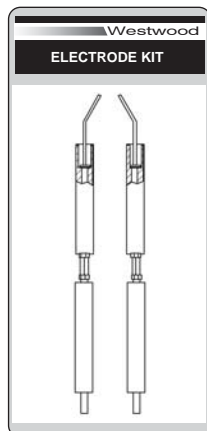
**TUNE-UP & ELECTRODE KITS (Continued)**Westwood
ELECTRODE KIT
No. S88-36Westwood
ELECTRODE KIT
No. S88-38Westwood
TUNE-UP-REPAIR KIT
No. S88-74

Westwood No.	Ref. No.	Description
S88-32	51484U	ELECTRODE KIT for Beckett AF II, HLX (up to 9" air tube)
		2 - Electrode assemblies 2 - Extension rods with nuts
S88-34	51670U	ELECTRODE KIT for Beckett AF II, FBX (up to 9" air tube)
		2 - Electrode assemblies 2 - Extension rods with nuts
S88-36	BK-1	ELECTRODE KIT for Beckett AF, AFG, AR, SF, SR (up to 9" air tube)
		2 - Beckett 1510 electrodes 2 - 3/16" x 6" buss bar rods
S88-38	BK-2	ELECTRODE KIT for Beckett AF, AFG, AR, SF, SR (all size air tube)
		2 - Beckett 1510 electrodes 2 - 3/16" x 13" buss bar rods 2 - E5-2M4 insulators
S88-50	CK 780	TUNE-UP KIT for Carlin 98 - 102, Elite, 201CRD, 301CRD
		2 - Electrode assemblies 1 - 12" oil line assembly 1 - Red tip setting gauge
S88-60	WMK-100	TUNE-UP KIT for Weil McLain burner
		1 - One piece electrode assembly 2 - Ignition cable leads
S88-70	31156	TUNE-UP KIT for Wayne ER, ERA, EH, EHA, EHASR, M, MSR, MH, OE, OEA
		2 - Electrode stems 2 - Electrode assemblies w/insul. 2 - Insulator bushings 2 - Buss bars (8") 1 - Buss bar support
S88-72	31156W	TUNE-UP KIT for Wayne ER, ERA, EH, EHA, EHASR, M, MSR, MH, OE, OEA
		Same components as S88-70, manufactured by Westwood
S88-74	31157	TUNE-UP KIT for Wayne Blue Angel model HS
		2 - Electrode assemblies w/buss bars 1 - Electrode support 1 - Buss bar support 1 - Oil line assembly
S88-76	31157W	TUNE-UP KIT for Wayne Blue Angel model HS
		Same components as S88-74, manufactured by Westwood

Packaging may vary from that shown

S8



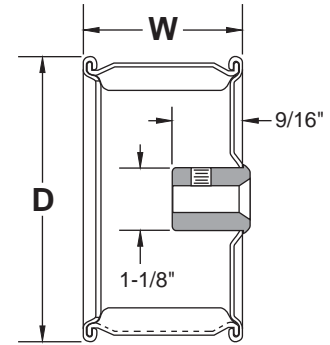

Westwood
BLOWER WHEELS

Precision balanced general purpose blower wheel ideal for oil burners. Blade strip is continuous and roll-locked front and back.





BLOWER WHEELS (Rotation as viewed from closed end)

CW		CCW		D	W	Fits shaft size	Comments
 No.	Ref. No.	 No.	Ref. No.				
STANDARD							
S90-10	4030	-	-	4"	3"	1/2"	
S90-12	4230	-	-	4-1/4"	3"	1/2"	
S90-14	4235	-	-	4-1/4"	3-1/2"	1/2"	
S90-16	4725	-	-	4-3/4"	2-1/2"	1/2"	
S90-18	4729	S91-18	4729-1	4-3/4"	3"	1/2"	
S90-20	4734	S91-20	4734-1	4-3/4"	3-1/2"	1/2"	
S90-22	5220	S91-22	5220-1	5-1/4"	2"	1/2"	
S90-24	5225	S91-24	5225-1	5-1/4"	2-1/2"	1/2"	
S90-26	5229	S91-26	5229-1	5-1/4"	3"	1/2"	
S90-28	5234	S91-28	5234-1	5-1/4"	3-1/2"	1/2"	
S90-30	5729	S91-30	5729-1	5-3/4"	3"	1/2"	
S90-32	5734	S91-32	5734-1	5-3/4"	3-1/2"	1/2"	
S90-34	5738	S91-34	5738-1	5-3/4"	3-7/8"	1/2"	
S90-36	6325	-	-	6-1/4"	2-1/2"	1/2"	
S90-38	6329	S91-38	6329-1	6-1/4"	3"	1/2"	
S90-40	6334	S91-40	6334-1	6-5/16"	3-1/2"	1/2"	
S90-42	6338	S91-42	6338-1	6-1/4"	3-7/8"	1/2"	
S90-44	6342	S91-44	6342-1	6-1/4"	4-1/4"	1/2"	
S90-46	6346	-	-	6-1/4"	4-5/8"	1/2"	
-	-	S91-48	7243-1	7"	4-1/4"	1/2"	
SPECIAL							
S90-60	475-243	-	-	4-3/4"	2-7/16"	1/2"	Outside hub
S90-62	475-287	-	-	4-3/4"	2-7/8"	1/2"	Lovejoy prongs
S90-64	575-287	-	-	5-3/4"	2-7/8"	1/2"	Lovejoy prongs
S90-66	625-400	-	-	6-1/4"	4"	1"	Cast hub
S90-68	951-78	-	-	7"	4"	1"	Heavy braces
S90-70	951-81	-	-	9-3/16"	5"	5/8"	Heavy braces
-	-	S91-72	951-170	9-3/16"	5"	7/8"	Heavy braces
-	-	S91-74	951-57	11-3/4"	6"	1-1/8"	Heavy braces

PRESSURE GAUGES





PRESSURE

 No.	Ref. No.	Mount	Face	Range	 No.	Ref. No.	Mount	Face	Range
S100-100	146010	1/8" CBM	1-1/2"	0-15 PSI	S100-142	47738	1/4" LM	2-1/2"	0-30 PSI
S100-102	146011	1/8" CBM	1-1/2"	0-30 PSI	S100-144	47495	1/4" LM	2-1/2"	0-60 PSI
S100-104	146013	1/8" CBM	1-1/2"	0-100 PSI	S100-146	45331	1/4" LM	2-1/2"	0-100 PSI
S100-106	49488	1/4" CBM	2"	0-30 PSI	S100-148	48365	1/4" LM	2-1/2"	0-160 PSI
S100-108	47615	1/4" LM	2"	0-15 PSI	S100-150	46913	1/4" LM	2-1/2"	0-200 PSI
S100-110	46644	1/4" LM	2"	0-30 PSI	S100-152	45765	1/4" LM	2-1/2"	0-300 PSI
S100-112	45764	1/4" LM	2"	0-60 PSI	S100-154	49611	1/4" LM	2-1/2"	0-400 PSI
S100-114	45330	1/4" LM	2"	0-100 PSI	S100-156	46648	1/4" LM	2-1/2"	0-600 PSI
S100-116	46912	1/4" LM	2"	0-160 PSI	S100-158	5504	1/4" LM	3-1/2"	0-30 PSI
S100-118	47101	1/4" LM	2"	0-200 PSI	S100-160	5506	1/4" LM	3-1/2"	0-60 PSI
S100-120	46778	1/4" LM	2"	0-300 PSI	S100-162	5508	1/4" LM	3-1/2"	0-100 PSI
S100-122	47492	1/4" LM	2"	0-400 PSI	S100-164	5510	1/4" LM	3-1/2"	0-160 PSI
S100-124	47493	1/4" LM	2"	0-600 PSI	S100-166	5512	1/4" LM	3-1/2"	0-200 PSI
S100-126	52420	1/8" LM	2"	0-15 PSI	S100-168	5514	1/4" LM	3-1/2"	0-300 PSI
S100-128	47490	1/8" LM	2"	0-30 PSI	S100-170	5515	1/4" LM	3-1/2"	0-400 PSI
S100-130	52576	1/8" LM	2"	0-60 PSI	S100-172	5516	1/4" LM	3-1/2"	0-600 PSI
S100-132	47491	1/8" LM	2"	0-100 PSI	S100-174	5551	1/4" LM	4-1/2"	0-60 PSI
S100-134	48302	1/8" LM	2"	0-160 PSI	S100-176	5554	1/4" LM	4-1/2"	0-100 PSI
S100-136	46645	1/8" LM	2"	0-200 PSI	S100-178	5561	1/4" LM	4-1/2"	0-200 PSI
S100-138	48363	1/8" LM	2"	0-300 PSI	S100-180	5563	1/4" LM	4-1/2"	0-300 PSI
S100-140	47102	1/4" LM	2-1/2"	0-15 PSI					

PRESSURE GAUGES - LIQUID FILLED - Stainless steel case



PRESSURE



 No.	Ref. No.	Mount	Face	Range	 No.	Ref. No.	Mount	Face	Range
S100-200	166664	1/8" CBM	1-1/2"	0-30 PSI	S100-238	165295	1/4" CBM	2"	0-1000 PSI
S100-202	166665	1/8" CBM	1-1/2"	0-60 PSI	S100-240	165296	1/4" LM	2-1/2"	0-30 PSI
S100-204	166666	1/8" CBM	1-1/2"	0-100 PSI	S100-242	165297	1/4" LM	2-1/2"	0-60 PSI
S100-206	166667	1/8" CBM	1-1/2"	0-160 PSI	S100-244	165298	1/4" LM	2-1/2"	0-100 PSI
S100-208	166668	1/8" CBM	1-1/2"	0-300 PSI	S100-246	165299	1/4" LM	2-1/2"	0-160 PSI
S100-210	166669	1/8" CBM	1-1/2"	0-1000 PSI	S100-248	165300	1/4" LM	2-1/2"	0-300 PSI
S100-212	165282	1/4" LM	2"	0-30 PSI	S100-250	165301	1/4" LM	2-1/2"	0-600 PSI
S100-214	165283	1/4" LM	2"	0-60 PSI	S100-252	165302	1/4" LM	2-1/2"	0-1000 PSI
S100-216	165284	1/4" LM	2"	0-100 PSI	S100-254	165377	1/4" LM	2-1/2"	0-2000 PSI
S100-218	165285	1/4" LM	2"	0-160 PSI	S100-256	165378	1/4" LM	2-1/2"	0-3000 PSI
S100-220	165286	1/4" LM	2"	0-300 PSI	S100-258	165303	1/4" CBM	2-1/2"	0-30 PSI
S100-222	165287	1/4" LM	2"	0-600 PSI	S100-260	165304	1/4" CBM	2-1/2"	0-60 PSI
S100-224	165288	1/4" LM	2"	0-1000 PSI	S100-262	165305	1/4" CBM	2-1/2"	0-100 PSI
S100-226	165289	1/4" CBM	2"	0-30 PSI	S100-264	165306	1/4" CBM	2-1/2"	0-160 PSI
S100-228	165290	1/4" CBM	2"	0-60 PSI	S100-266	165307	1/4" CBM	2-1/2"	0-300 PSI
S100-230	165291	1/4" CBM	2"	0-100 PSI	S100-268	165308	1/4" CBM	2-1/2"	0-600 PSI
S100-232	165292	1/4" CBM	2"	0-160 PSI	S100-270	165309	1/4" CBM	2-1/2"	0-1000 PSI
S100-234	165293	1/4" CBM	2"	0-300 PSI	S100-272	165380	1/4" CBM	2-1/2"	0-2000 PSI
S100-236	165294	1/4" CBM	2"	0-600 PSI	S100-274	165381	1/4" CBM	2-1/2"	0-3000 PSI

1/4" = 1/4" NPT pipe thread
1/8" = 1/8" NPT pipe thread

CBM = Center back mount
LM = Low mount
LBM = Low back mount



S10

LOW PRESSURE DIAPHRAGM GAUGES

 No.	Ref. No.	Mount	Face	Range	 No.	Ref. No.	Mount	Face	Range
S100-300	161963	1/4" LM	2-1/2"	15" WC	S100-318	161971	1/4" LM	2-1/2"	10 PSI
S100-302	161964	1/4" LM	2-1/2"	30" WC	S100-320	161972	1/4" LM	2-1/2"	20 oz.-35" WC
S100-304	162787	1/4" LM	2-1/2"	60" WC	S100-322	21551	1/4" CBM	2-1/2"	15" WC
S100-306	161965	1/4" LM	2-1/2"	100" WC	S100-324	21552	1/4" CBM	2-1/2"	35" WC
S100-308	161966	1/4" LM	2-1/2"	200" WC	S100-326	75995	1/4" CBM	2-1/2"	60" WC
S100-310	161967	1/4" LM	2-1/2"	20 oz.	S100-328	75991	1/4" CBM	2-1/2"	20 oz.
S100-312	161968	1/4" LM	2-1/2"	32 oz.	S100-330	21553	1/4" CBM	2-1/2"	36 oz.
S100-314	161969	1/4" LM	2-1/2"	36 oz.	S100-332	21554	1/4" CBM	2-1/2"	5 PSI
S100-316	161970	1/4" LM	2-1/2"	5 PSI	S100-334	75996	1/4" CBM	2-1/2"	10 PSI



COMPOUND GAUGES

 No.	Ref. No.	Mount	Face	Range	 No.	Ref. No.	Mount	Face	Range
S100-400	47925	1/8" LM	2"	30"-60 PSI	S100-408	46646	1/4" LM	2-1/2"	30"-60 PSI
S100-402	49609	1/8" LM	2"	30"-150 PSI	S100-410	47411	1/4" LM	2-1/2"	30"-150 PSI
S100-404	75260	1/8" LM	2"	30"-300 PSI	S100-412	58156	1/4" LM	2-1/2"	30"-300 PSI
S100-406	47105	1/4" LM	2-1/2"	30"-30 PSI					



GAUGE ADAPTER

 No.	Description
S100-10	1/4"-NPT (F) x 1/8"-NPT (M) Brass gauge adapter

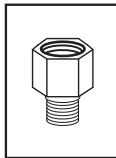

VACUUM GAUGES

 No.	Ref. No.	Mount	Face	Range
S100-500	47225	1/8" LM	2"	0 - 30" Hg
S100-502	47103	1/4" LM	2"	0 - 30" Hg
S100-504	47104	1/4" LM	2-1/2"	0 - 30" Hg



TEST GAUGES

 No.	Ref. No.	Type	Mount	Face	Range	Refrigerant Scale	For Westwood Tester
S100-280	-	Pressure*	1/8" LM	2"	0 - 300 PSI	-	T10
S100-285	-	Pressure*	1/8" LM	2-1/2"	0 - 300 PSI	-	T20
S100-290	-	Vacuum*	1/8" LM	2"	0 - 30" Hg	-	T15
S100-295	-	Vacuum*	1/8" LM	2-1/2"	0 - 30" Hg	-	T20
S100-600	169128	Refrigerant	1/8" LM	2-1/2"	30" Hg - 350 PSI	R-12, R-22, R-502	-
S100-610	169129	Refrigerant	1/8" LM	2-1/2"	0 - 500 PSI	R-12, R-22, R-502	-
S100-620	169130	Refrigerant	1/8" LM	2-1/2"	30" Hg - 350 PSI	R-134A	-
S100-630	169131	Refrigerant	1/8" LM	2-1/2"	0 - 500 PSI	R-134A	-
S100-640	169132	Refrigerant	1/8" LM	2-1/2"	30" Hg - 500 PSI	R-410A	-
S100-650	169133	Refrigerant	1/8" LM	2-1/2"	0 - 800 PSI	R-410A	-



* Liquid filled, stainless steel case

1/4" = 1/4" NPT pipe thread
1/8" = 1/8" NPT pipe thread

CBM = Center back mount
LM = Low mount
LBM = Low back mount



PRESSURE & VACUUM TESTERS starting on page T1

Please order by  No.

Westwood
OIL BURNER PUMP STRAINERS & GASKETS
 STAINLESS STEEL MESH • NYLON ENDS • SONICALLY WELDED

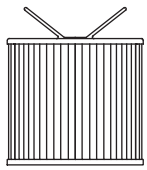
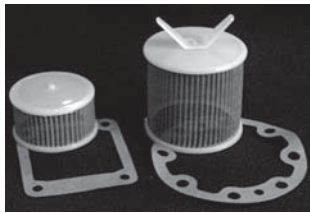

 No. **S150 (Series)**
 Suntec J, H, S



 No. **S160 (Series)**
 Suntec A70

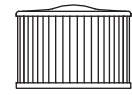

 No. **S170 (Series)**
 Suntec B80, 1-3/8"

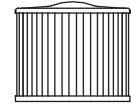

 No. **S180 (Series)**
 Suntec B80, 1-5/8"

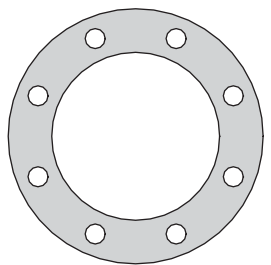

 No. **S150 (Series)**
 Suntec J, H, S

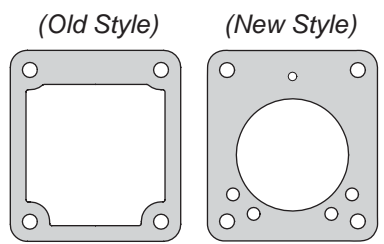

 No. **S190 (Series)**
 Suntec A70 & B80



 No. **S195**
 Riello



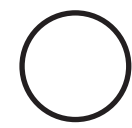

 No. **S197**
 Danfoss



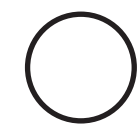

 No. **S195-5**
 Riello



 No. **S197-5**
 Danfoss

 No.	Ref. No.	Description	biofuels COMPATIBLE 
S150	JHS	Strainer for Suntec J, H, S, individually boxed w/gasket	
S150-10	-	Strainer for Suntec J, H, S, individually bagged w/gasket	
S150-12	-	"P" Strainer for Suntec J, H, S, high capacity (coarse mesh), individually bagged w/gasket	
S150-55	-	Cover gasket for Suntec J, H, S, package of 10 gaskets	
S150-60	-	Cover gasket for Suntec J, H, S, package of 50 gaskets	
S150-65	-	Cover gasket for Suntec J, H, S, package of 100 gaskets	
S160-10	-	Strainer for Suntec A70 single-stage mini pump, individually bagged w/old style gasket	
S160-12	-	Strainer for Suntec A70 single-stage mini pump, individually bagged w/new style gasket	
S170	-	Strainer for Suntec B80 two-stage mini pump, 1-3/8" long, indiv. boxed w/old style gasket	
S170-1	-	Strainer for Suntec B80 two-stage mini pump, 1-3/8" long, indiv. boxed w/new style gasket	
S180	-	Strainer for Suntec B80 two-stage mini pump, 1-5/8" long, indiv. boxed w/old style gasket	
S180-1	-	Strainer for Suntec B80 two-stage mini pump, 1-5/8" long, indiv. boxed w/new style gasket	
S190	-	Cover gasket for Suntec A70 and B80 mini pumps, old style, package of 50 gaskets	
S190-1	-	Cover gasket for Suntec A70 and B80 mini pumps, old style, package of 100 gaskets	
S190-2	-	Cover gasket for Suntec A70 and B80 mini pumps, old style, package of 10 gaskets	
S190-5	-	Cover gasket for Suntec A70 and B80 mini pumps, new style, package of 50 gaskets	
S190-6	-	Cover gasket for Suntec A70 and B80 mini pumps, new style, package of 100 gaskets	
S190-7	-	Cover gasket for Suntec A70 and B80 mini pumps, new style, package of 10 gaskets	
S195	-	Strainer for Riello pump, individually bagged w/'O' ring gasket	
S195-5	-	Cover 'O' ring gasket for Riello pump, package of 6 'O' rings	
S197	-	Strainer for Danfoss pump, individually bagged w/'O' ring gasket	
S197-5	-	Cover 'O' ring gasket for Danfoss pump, package of 6 'O' rings	

FUEL SYSTEM PARTS

BY-PASS PLUGS		
 1/16" THREAD For Suntec A, B Webster M	 1/8" THREAD For Suntec J, H Webster R	 METRIC THREAD For RIELLO pump

 No. **S211, -1**

 No. **S211-2, -3**

 No. **S211-4, -5**



 No. **S213 & S214 (Series)**

MILLER FURNACE OIL LINE KIT

- 1 · S213-7 oil line. For Wayne Home Equip. OE, OE-LS, M-LS, MSRH, Nu-Way FM, FM-LS, FS-LS, Beckett AF-15, when burner does not have a Sundstrand A1VA 17J1600 pump.
- 1 · S213-11 oil line. For Wayne Home Equip. OE, OE-LS, Nu-Way FM, FM-LS, when burner has Sundstrand A1VA 17J1600 pump.
- 1 · 1/4" flare x 3/16" flare reducer adapter for certain Wayne OE & OE-LS burners
- 1 · 3/16" flare x 1/8" · NPT elbow for certain Wayne OE & OE-LS burners

 No. **S214-25**

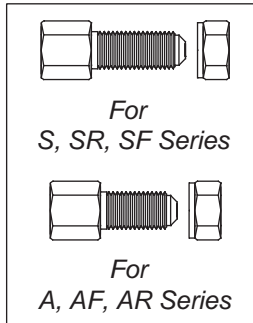

 No. **S215, -1**

MAGIC*PATCH™
FOR TEMPORARY USE ON LEAKING FUEL OIL TANKS

TAKE THE **MAGIC*PATCH™** CHALLENGE

PUT A MAGIC*PATCH AGAINST A REGULAR MAGNETIC PATCH (PAD TO PAD, HELD TOGETHER BY THE MAGNETS) AND LEAVE THEM FOR 24 HOURS. AFTER THAT TIME TEST THE MAGNETS. YOU'LL SEE WHAT MAKES THE MAGIC*PATCH, "MAGIC"

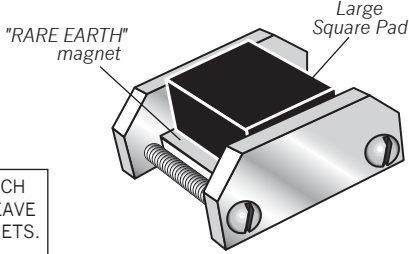

...holds like magic!

 No. **S216**

BY-PASS PLUGS, OIL LINES & FITTINGS, MAGIC-PATCH

 No.	Ref. No.	Description
S211	-	By-Pass Plug for Suntec A, B and Webster M, 1/16"- NPT, package of 10
S211-1	-	By-Pass Plug for Suntec A, B and Webster M, 1/16"- NPT, package of 100
S211-2	-	By-Pass Plug for Suntec J, H and Webster R, 1/8" NPT, package of 10
S211-3	-	By-Pass Plug for Suntec J, H and Webster R, 1/8" NPT, package of 100
S211-4	-	By-Pass Plug for RIELLO pump, (takes 2.5mm hex key), package of 10
S211-5	-	By-Pass Plug for RIELLO pump, (takes 2.5mm hex key), package of 100
S213-5	3605	Nozzle line w/flare nuts, 3/16" O.D. copper tubing, 5" long
S213-7	3607	Nozzle line w/flare nuts, 3/16" O.D. copper tubing, 7" long
S213-8	3608	Nozzle line w/flare nuts, 3/16" O.D. copper tubing, 8" long
S213-11	3611	Nozzle line w/flare nuts, 3/16" O.D. copper tubing, 11" long
S213-12	3612	Nozzle line w/flare nuts, 3/16" O.D. copper tubing, 12" long
S213-16	3616	Nozzle line w/flare nuts, 3/16" O.D. copper tubing, 16" long
S214-12	1412	Nozzle line w/flare nuts, 1/4" O.D. copper tubing, 12" long
S214-16	1416	Nozzle line w/flare nuts, 1/4" O.D. copper tubing, 16" long
S214-25	OL-711	Oil line parts kit for Miller furnaces, (1) S213-7, (1) S213-11, (2) fittings
S215	-	Replacement nozzle line fitting for Beckett S, SR, SF series burners
S215-1	-	Replacement nozzle line fitting for Beckett A, AF, AR series burners
S216	-	MAGIC*PATCH magnetic emergency tank leak patch

Please order by  No.



newest
 The ~~New~~
Tigerloop®

World's most advanced oil de-aerator
 ...and the only one that's UL Listed!



see page S16

Tigerloop®

Model TN

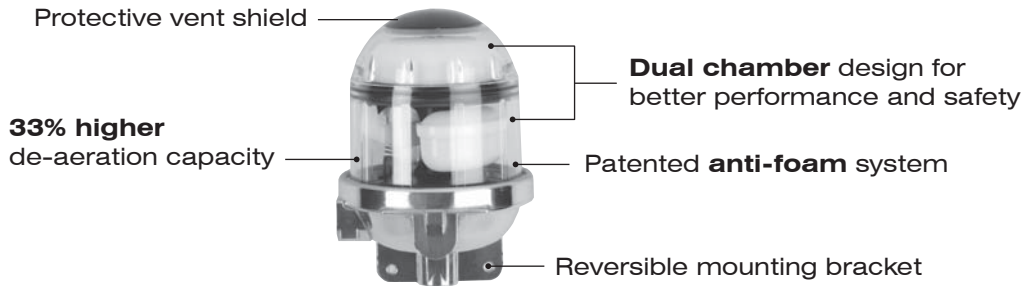

World's most advanced oil de-aerator!

After years of development, the next generation Tigerloop® oil de-aerator has arrived! With over 30 years experience and more than 3.5 million Tigerloops® installed worldwide, Tigerholm is uniquely qualified to take oil de-aeration to the next level.

More than just a problem solver!

For years, Tigerloop® has been primarily thought of as a problem solver, a "band-aid," used to easily cure air and suction line problems. But, that's only part of the story! All systems benefit from Tigerloop's® unique ability to condition the oil prior to burning. Whether it's air elimination, nozzle coking problems, vacuum reduction, oil preheating, or just the elimination of that potentially leaky return line, Tigerloop® is today's safe, economical, environmentally friendly choice for all oil supply systems.

The Advantages of Tigerloop®...

- Safely Handles suction line air leaks*
- Removes air entrained in oil during transporting and delivery*
- Reduces running vacuum for clear, foam-free oil at the nozzle*
- Eliminates potential leak hazard by eliminating the return line*
- Preheats the oil for cleaner combustion*
- Extends filter element life*

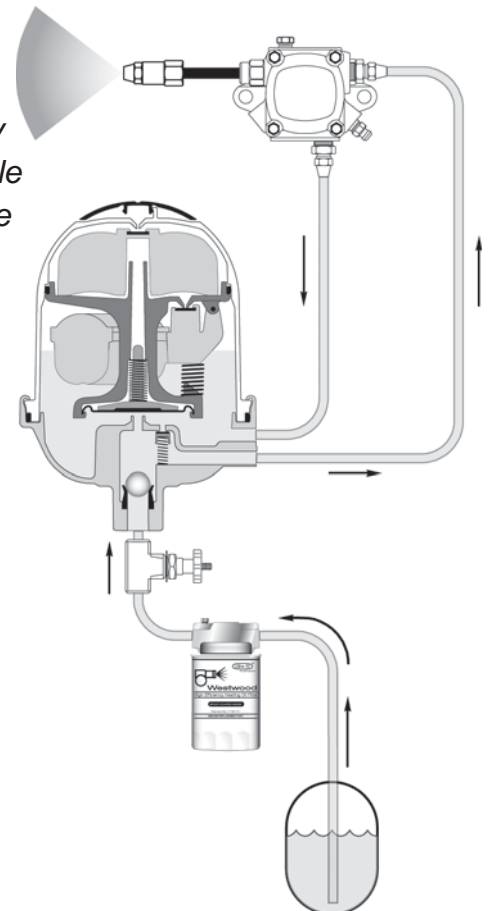

Technical Information

MAX. NOZZLE CAPACITY 20 GPH
 MAX. RETURN OIL FLOW 30 GPH
 TEMPERATURE RANGE 20° - 105° F
 MAX. INLET PRESSURE 8 PSI
 CONNECTIONS 1/4"- NPT (female)
 FUEL No. 1 & 2 HEATING OIL, B5 BioHeat®
Not for use with E-diesel or any fuel containing Ethanol (alcohol)



No.	Description
S220 S220-10	Tigerloop® oil de-aerator, model TN, UL Listed 3/8"- NPT Fiomatic fusible valve with reducing nipple installed (3/8"- NPT x 1/4"- NPT)

The New

Tigerloop®

ULTRA™

The economical Tigerloop®/Spin-On filter combination that's fast and easy to install. Costs less than installing a Tigerloop® and Spin-On separately! Designed specifically for the demands of American heating systems.



Costs less than installing a Tigerloop® and Spin-On separately!

Technical Information

MAX. NOZZLE CAPACITY 20 GPH
 MAX. RETURN OIL FLOW 30 GPH
 TEMPERATURE RANGE 20° - 105° F
 MAX. INLET PRESSURE 8 PSI
 CONNECTIONS 1/4" NPT (female)

REPLACEMENT ELEMENT F100-10
 ELEMENT MEDIA 10 Micron
 ELEMENT CANISTER EPOXY INSIDE
 FUEL No. 1 & 2 HEATING OIL, B5 BioHeat®
Not for use with E-diesel or any fuel containing Ethanol (alcohol)

Tigerloop® ULTRA™ OIL DE-AERATOR & SPIN-ON FILTER

W/P	No.	Description
	S220-8	Tigerloop® ULTRA™ oil de-aerator & Spin-On filter, UL Listed
	F100-10	Replacement Spin-On element, standard thread, see page F4

Tigerloop®

Bio™

NEW!

A standard Tigerloop® with B100 compatibility!

Totally **Metallic** Housing



Technical Information

MAX. NOZZLE CAPACITY 20 GPH
 MAX. RETURN OIL FLOW 30 GPH
 TEMPERATURE RANGE 20° - 105° F
 MAX. INLET PRESSURE 8 PSI
 CONNECTIONS 1/4"- NPT (female)
 FUEL **B100 BioHeat®**, No. 1 & 2 OIL
Not for use with E-diesel or any fuel containing Ethanol (alcohol)

 No.	Description
S220-1	Tigerloop® Bio™ oil de-aerator for biofuels to B100

Tigerloop®

ULTRA-B™

NEW!

A standard Tigerloop® ULTRA™ with B100 compatibility!

Totally **Metallic** Housing



Technical Information

MAX. NOZZLE CAPACITY 20 GPH
 MAX. RETURN OIL FLOW 30 GPH
 TEMPERATURE RANGE 20° - 105° F
 MAX. INLET PRESSURE 8 PSI
 CONNECTIONS 1/4"- NPT (female)
 REPLACEMENT ELEMENT F100-10
 ELEMENT MEDIA 10 Micron
 ELEMENT CANISTER EPOXY INSIDE
 FUEL **B100 BioHeat®**, No. 1 & 2 HEATING OIL
Not for use with E-diesel or any fuel containing Ethanol (alcohol)

 No.	Description
S220-9	Tigerloop® ULTRA™-B oil de-aerator & filter

Tigerloop®

Combi™

A European Favorite



The **Tigerloop® Combi™** was developed for the low firing rate burners of Europe. It features a clear plastic bowl which houses a high efficiency sintered plastic filter element. The forerunner of the **Tigerloop® ULTRA™**.

Tigerloop® Combi™ OIL DE-AERATOR & FILTER

 No.	Description
S220-4	Tigerloop® Combi™ oil de-aerator & filter
S220-6	Replacement sintered plastic filter element for S220-4 (Combi)

Technical specs are the same as for the S220. See page S15

Tigerloop®

Twin™

*For
Commercial
Burners*

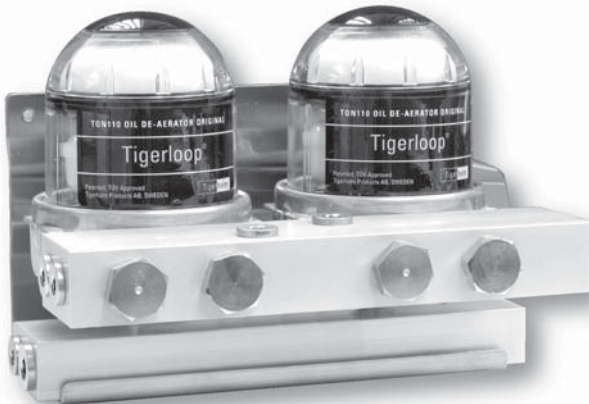

**If something is good...
then two are better!**

The **Tigerloop® Twin™** has twice the capacity for those large commercial jobs. Get all the benefits of Tigerloop's famous de-aeration capabilities...in a bigger way! Comes complete with Westwood's commercial duty Spin-On filter.

Technical Information

MAX. NOZZLE CAPACITY 40 GPH
 MAX. RETURN OIL FLOW 60 GPH
 TEMPERATURE RANGE 20° - 105° F
 MAX. INLET PRESSURE 8 PSI
 TANK CONNECTION 3/8"- NPT
 PUMP CONNECTIONS 1/4"- NPT

SPIN-ON FILTER SUPPLIED F100-1
 REPLACEMENT ELEMENT F100-11
 ELEMENT MEDIA 30 Micron
 ELEMENT CANISTER EPOXY INSIDE
 FUEL No. 1 & 2 HEATING OIL, B5 BioHeat®
Not for use with E-diesel or any fuel containing Ethanol (alcohol)

Tigerloop® Twin™ OIL DE-AERATOR & SPIN-ON FILTER

 No.	Description
S220-15 F100-11	Tigerloop® Twin™ oil de-aerator & commercial duty Spin-On filter Replacement Spin-On element, standard thread, see page F4

GENUINE



Tigerloop®

FLEXIBLE OIL LINES

Steel Braided Covering
24" & 36" Long
145 PSI - 200 °F



For swing-out doors and oil de-aerators

FLEXIBLE OIL LINES, Standard

 No.	Description
S220-24	Flexible oil line, braided steel outside covering, 1/4"- NPT (MxM), 24" long
S220-36	Flexible oil line, braided steel outside covering, 1/4"- NPT (MxM), 36" long
S220-40	Replacement fitting for flexible oil line, 3/8" inv. flare x 1/4"-NPT
S222-36	Flexible oil line, braided steel outside covering, 3/8" Flare (FxF), 36" long



Steel Braided Covering
24" & 36" Long
145 PSI - 200 °F
Color coded Red & Blue
for easy identification

FLEXIBLE OIL LINES

SPECIAL FOR RIELLO



European thread connects directly to **RIELLO** pump adaptor

PUMP END



Two piece swivel connector for easy installation and service

OTHER END

FLEXIBLE OIL LINES, Special for RIELLO burners

 No.	Description
S221-24	Flexible oil line, braided steel outside covering, 1/4"- NPT (M) x RIELLO pump adapter thread, 24" long
S221-36	Flexible oil line, braided steel outside covering, 1/4"- NPT (M) x RIELLO pump adapter thread, 36" long



For testing RIELLO pumps see page T2 & T3

Please order by  No.

rev. 1-1-09

E-Z Connect ADAPTOR FITTING

One fitting quickly connects the 1/4"-NPT male end of flexible oil lines to 3/8" FLARE!

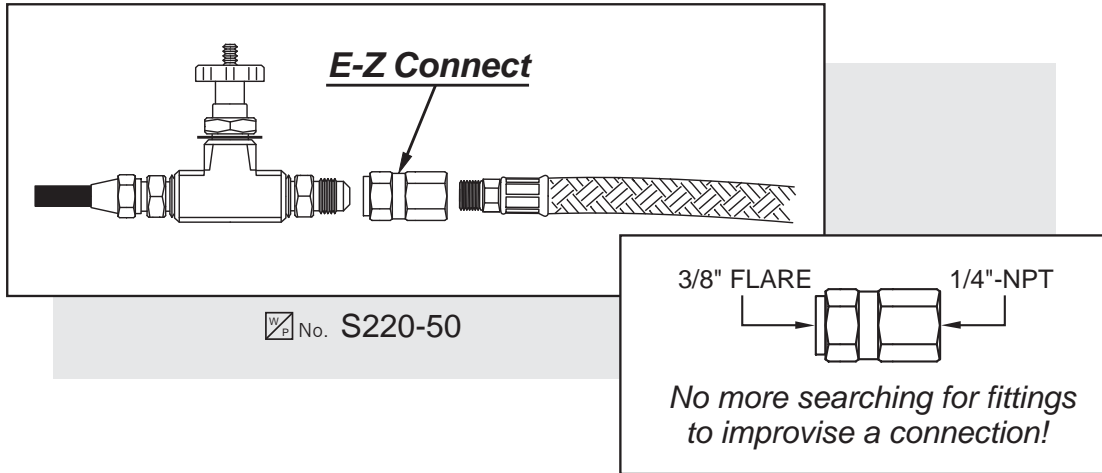

 No. S220-50

No more searching for fittings to improvise a connection!

CHECK VALVES

3/8" - NPT



 No. S230



1/2" - NPT

 No. S230-1



PRV Oil Line Safety Valve

Isolates burner components from fuel supply line pressure. Requires pump vacuum to draw oil from the tank.

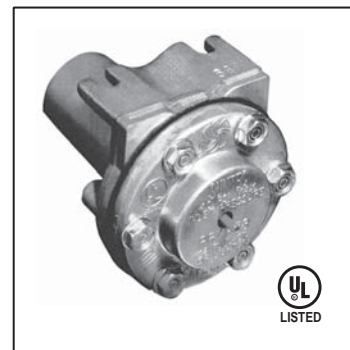

 No. S225

Technical Information

MAXIMUM FLOW 20 GPH
 TEMPERATURE RANGE 0 - 160° F
 MAX. INLET PRESSURE 40 PSI

FUEL No. 2 OR LIGHTER
 APPROVAL UL LISTED
 CONNECTIONS 3/8" - NPT

Westwood



OIL SAFETY VALVE & SPIN-ON FILTER

Combines the Suntec PRV-38P oil safety valve with the Westwood Products Ultra-10™ (10 micron) high efficiency Spin-On filter element number F100-10. This combination provides the ultimate in protection for oil supply systems and costs less than installing an oil safety valve and Spin-On separately!

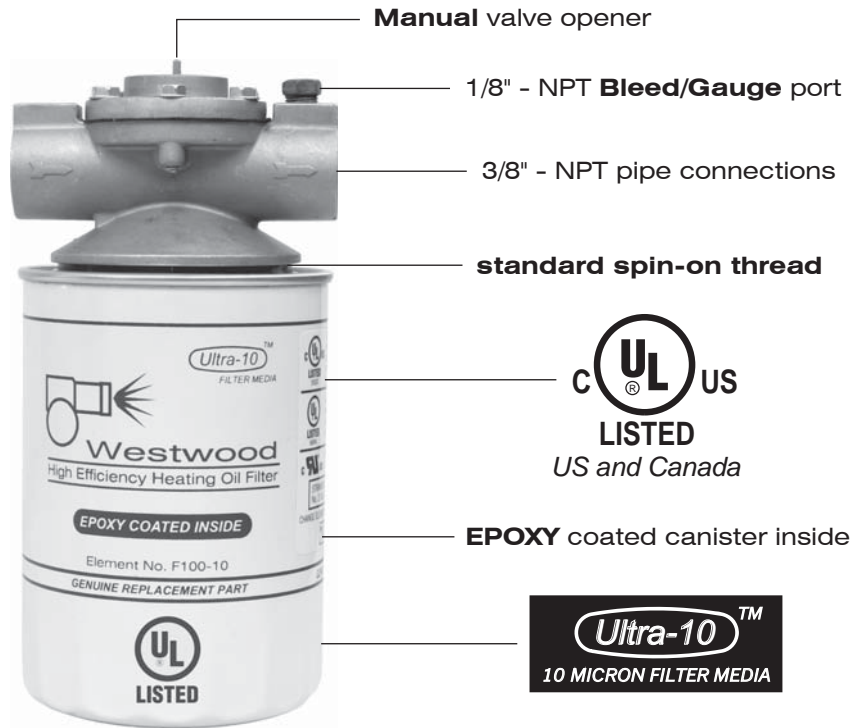

Costs less than installing an Oil Safety Valve and Spin-On separately!

Technical Information

CONNECTIONS 3/8"-NPT	MAXIMUM FIRING RATE 17 GPH
INLET PRESSURE 40 PSI MAX	REPLACEMENT ELEMENT F100-10
TEMPERATURE RANGE 0 - 160° F	ELEMENT MEDIA 10 Micron
FUEL No. 2 OIL OR LIGHTER	ELEMENT CANISTER EPOXY INSIDE
MAXIMUM FLOW 45 GPH	APPROVAL UL LISTED

Westwood OIL SAFETY VALVE & SPIN-ON FILTER



 No.	Description
S226	Westwood oil safety valve and Spin-On filter, UL Listed
F100-10	Replacement Spin-On element, standard thread, see page F4

EXACTA

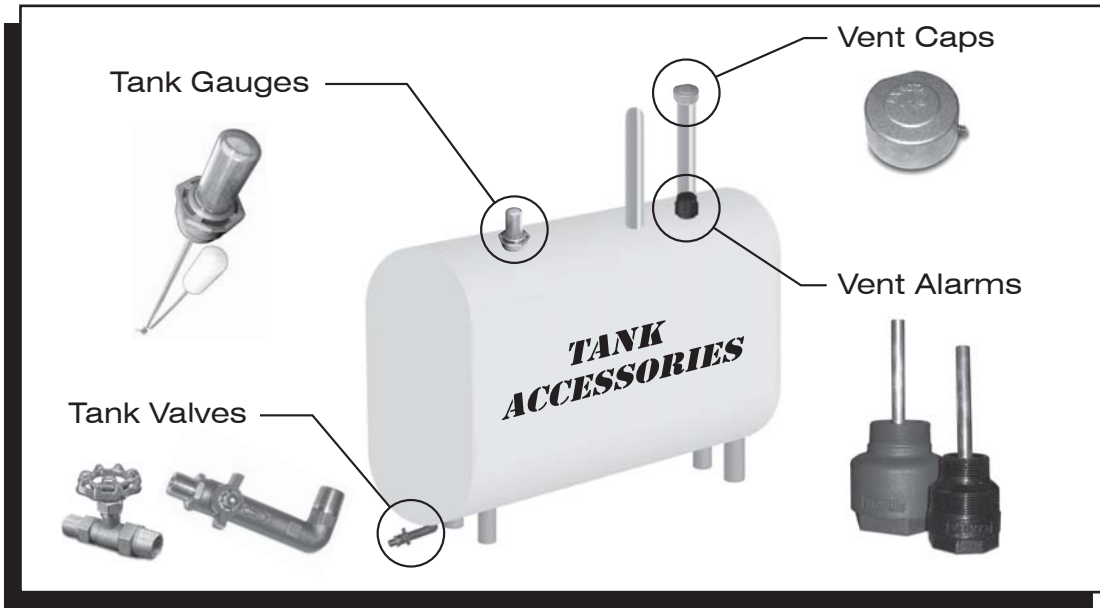

HEATING OIL TANK ACCESSORIES



 No.	Description	 No.	Description
S270	1-1/4" Vent alarm	S270-10	2" Aluminum vent cap, set screw, screen
S270-1	2" Vent alarm	S270-20	1/2" x 3/8" Oil tank valve, straight
S270-4	1-1/4" Aluminum vent cap, set screw	S270-22	1/2" x 3/8" Oil tank valve, 90° angle
S270-6	1-1/4" Aluminum vent cap, set screw, screen	S270-24	1-1/2" and 2" Tank gauge, 24"
S270-8	2" Aluminum vent cap, set screw	S270-44	1-1/2" and 2" Tank gauge, 44"

EXACTA

UNIVERSAL DRAFT REGULATOR

Fits the most popular smoke pipe sizes.

6" - 7" - 8"



 No.	Ref. No.	Description
S300-300	#678	3 in 1 combination draft regulator, fits 6", 7", 8" smoke pipe

Westwood

CRANK ARMS - SWIVELS - PUSH RODS

PRECISION MACHINED • HEAVY DUTY • PLATED STEEL

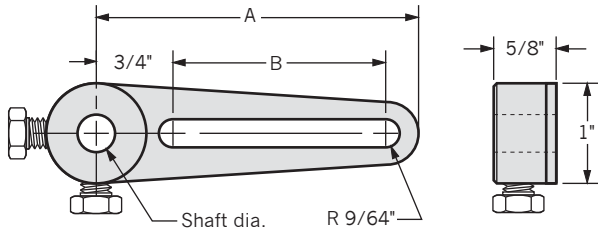

Slotted Crank Arm

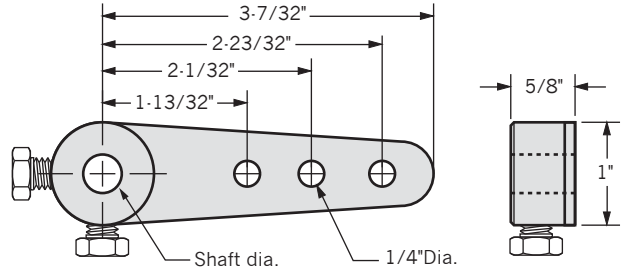

3 Hole Crank Arm

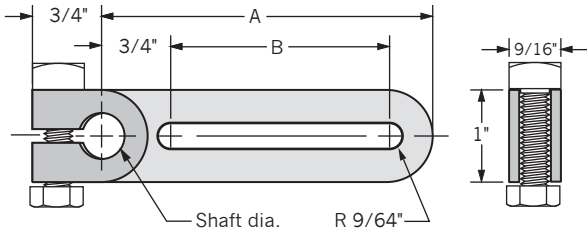

Slotted Crank Arm
(shaft clamping)

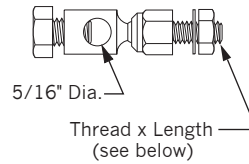

Swivel

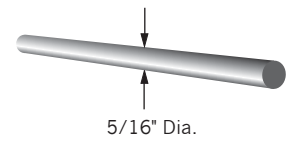

Push Rod

 No.	Ref. No.	Shaft Dia.	A	B	Swivel Thread x Length	Push Rod Length	Description
S300-400	ARM-3S	3/8"	3-3/16"	2-1/8"	-	-	Slotted crank arm
S300-402	ARM-5S	1/2"	3-3/16"	2-1/8"	-	-	Slotted crank arm
S300-404	ARM-3L	3/8"	4-15/16"	3-7/8"	-	-	Slotted crank arm
S300-406	ARM-5L	1/2"	4-15/16"	3-7/8"	-	-	Slotted crank arm
S300-408	ARM-14	3/8"	-	-	-	-	3 hole crank arm
S300-410	ARM-15	1/2"	-	-	-	-	3 hole crank arm
S300-412	ARM-5C	1/2"	3-19/32"	2-3/8"	-	-	Clamping crank arm
S300-414	SW-4	-	-	-	1/4-20 x 7/16"	-	Swivel
S300-416	SW-5	-	-	-	5/16-24 x 41/64"	-	Swivel
S300-418	SW-6	-	-	-	5/16-24 x 33/64"	-	Swivel
S300-420	SW-8	-	-	-	1/4-28 x 9/16"	-	Swivel
S300-422	SW-9	-	-	-	1/4-20 x 9/16"	-	Swivel
S300-424	PR-12	-	-	-	-	12"	5/16" dia. push rod
S300-426	PR-18	-	-	-	-	18"	5/16" dia. push rod
S300-428	PR-24	-	-	-	-	24"	5/16" dia. push rod
S300-430	PR-36	-	-	-	-	36"	5/16" dia. push rod
S300-432	PR-48	-	-	-	-	48"	5/16" dia. push rod

Westwood

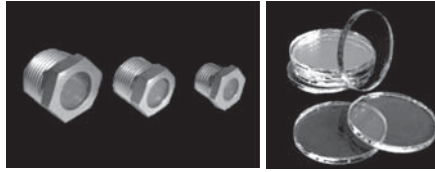

HIGH TEMPERATURE GLASSWARE

BOROSILICATE & SODA LIME WINDOW GLASS

**OBSERVATION PORTS****Clear - Soda Lime Window Glass - Male Pipe Thread Mount - 500° F**

 No.	Reference No.	Pipe Thread	Working Pressure
S305-37	OBS-38	3/8"- NPT	3,700 PSI
S305-50	OBS-50	1/2"- NPT	3,500 PSI
S305-75	OBS-75	3/4"- NPT	3,000 PSI
S305-100	OBS-100	1"- NPT	2,500 PSI
S305-125	OBS-125	1-1/4"- NPT	2,000 PSI
S305-150	OBS-153	1-1/2"- NPT	1,500 PSI

ROUND SIGHT GLASSES - Clear - Borosilicate Glass - 600° to 800° F

Diameter	 No.			Diameter	 No.		
	1/8" Thick	3/16" Thick	1/4" Thick		1/8" Thick	3/16" Thick	1/4" Thick
1"	S312-100	S318-100	S325-100	2-5/8"	S312-262	S318-262	S325-262
1-1/8"	S312-112	S318-112	S325-112	2-3/4"	S312-275	S318-275	S325-275
1-3/16"	S312-118	S318-118	S325-118	3"	S312-300	S318-300	S325-300
1-1/4"	S312-125	S318-125	S325-125	3-1/8"	S312-312	S318-312	S325-312
1-3/8"	S312-137	S318-137	S325-137	3-3/16"	S312-318	S318-318	S325-318
1-7/16"	S312-143	S318-143	S325-143	3-1/4"	S312-325	S318-325	S325-325
1-1/2"	S312-150	S318-150	S325-150	3-3/8"	S312-337	S318-337	S325-337
1-5/8"	S312-162	S318-162	S325-162	3-7/16"	S312-343	S318-343	S325-343
1-3/4"	S312-175	S318-175	S325-175	3-1/2"	S312-350	S318-350	S325-350
2"	S312-200	S318-200	S325-200	3-5/8"	S312-362	S318-362	S325-362
2-1/8"	S312-212	S318-212	S325-212	3-3/4"	S312-375	S318-375	S325-375
2-3/16"	S312-218	S318-218	S325-218	4"	S312-400	S318-400	S325-400
2-1/4"	S312-225	S318-225	S325-225	4-1/2"	S312-450	S318-450	S325-450
2-3/8"	S312-237	S318-237	S325-237	5"	S312-500	S318-500	S325-500
2-7/16"	S312-243	S318-243	S325-243	6"	S312-600	S318-600	S325-600
2-1/2"	S312-250	S318-250	S325-250				

Special size round, square, rectangular shapes, and colors available. Consult the factory for price and delivery.

BOILER & FURNACE CLEANING ITEMS

"SERVICE-SAW" BOILER SCALE BUSTING TOOL



Length: 32 in.

 No. S400

"SOOT SABER" BOILER CLEANING TOOLS

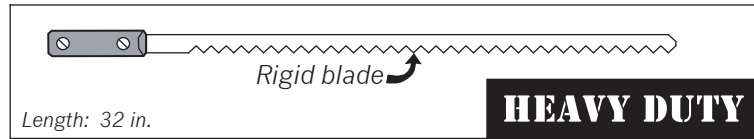

Length: 32 in.

 No. S402

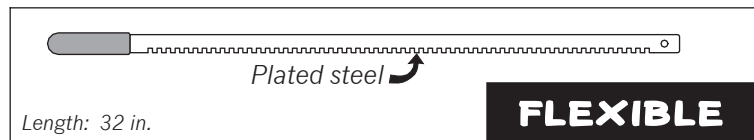

Length: 32 in.

 No. S405

"SOOT SNAKE" VAC HOSE

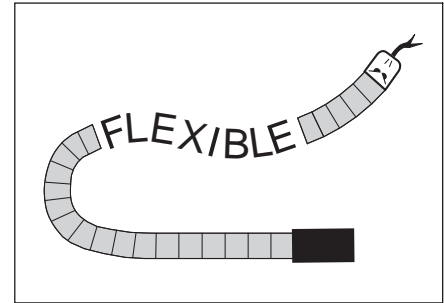

 No. S410

SOOT SHOVEL

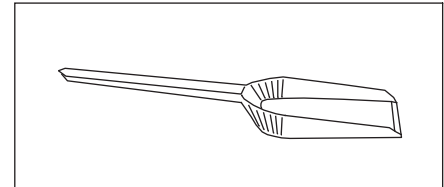

 No. S412

VACUUM CLEANER BAGS - Wrap around seam sealed for strength

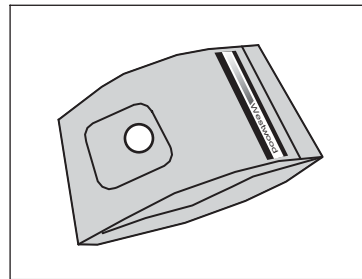

 No. S450-14, -15

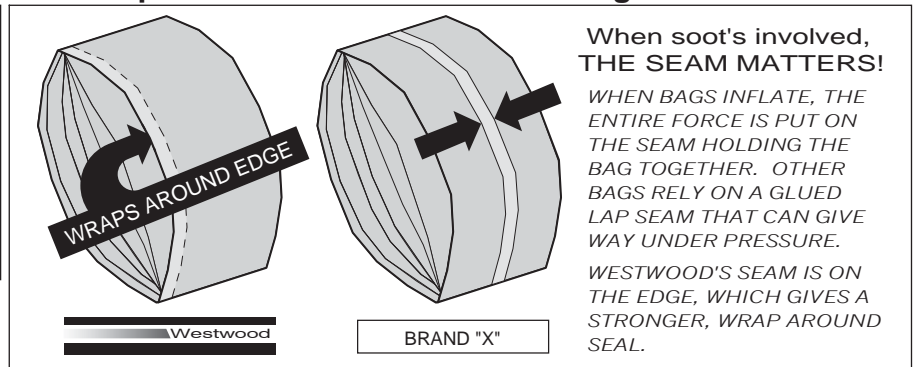













CLEANING TOOLS & VACUUM CLEANER BAGS

 No.	Reference No.	Description
S400	Service-Saw	"Service-Saw" boiler scale cleaning tool, tempered steel saw blade, plastic handle
S402	-	"SOOT SABER" Heavy Duty (rigid) boiler cleaning tool, zinc coated steel, wood handle
S405	-	"SOOT SABER" Flexible boiler cleaning tool, zinc coated steel, soft vinyl handle
S410	-	"SOOT SNAKE" Flexible steel vacuum cleaner hose, 7/8" dia., 48" long, with installed rubber adapter to fit a standard 1-1/2" rubber vacuum cleaner hose
S412	-	Soot Shovel, 4-1/2" wide, 19-1/2" long, steel with black enamel finish
S450-14	-	Style 4464 (3-1/2 gal.) vacuum cleaner bags. Fits Mastercraft 605, 641, 1100, 6500 and others; Sid Harvey S12. Package of 5 bags
S450-15	-	Style 4465 (5 gal.) vacuum cleaner bags. Fits Mastercraft 652, 653, 880, 990, 1005, 1010, 1015, 1200, 7000, 13008, D6508, D6520, D6530, W6508, W6509, W6510, 6513, and others; Sid Harvey S14. Package of 5 bags

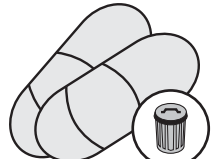
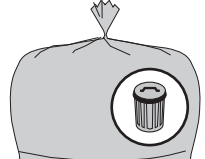
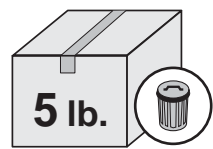
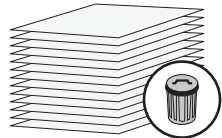
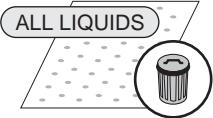

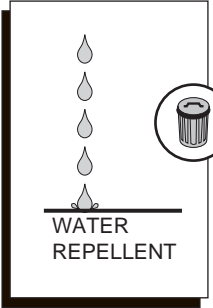
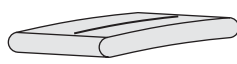
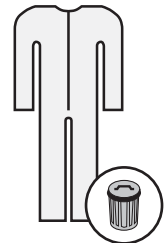
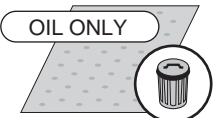
Safety and Spill Cleanup Supplies

CLOTH	NITRILE	MASKS	GLASSES	
 <p>No. S500 PAIR <i>Brown jersey gloves man's hand size</i></p>	 <p>No. S500-4 BOX OF 100 <i>Disposable oil resistant nitrile gloves, LARGE</i></p>	 <p>No. S500-10 EACH <i>Disposable dust mask, elastic strap, not rated</i></p>	 <p>No. S500-14 EACH <i>Adjustable Plastic safety glasses, clear lenses</i></p>	
 <p>No. S500-2 PAIR <i>White cotton gloves man's hand size</i></p>	 <p>No. S500-8* PAIR <i>Reusable heavy duty oil resistant nitrile gloves, man's hand size</i></p>	 <p>No. S500-12 EACH <i>Disposable dust mask, elastic strap, N95 rated</i></p>	 <p>No. S500-16 EACH <i>Adjustable Plastic safety glasses, smoked lenses</i></p>	
GOGGLES	SHOE COVERS	BAGS	RAGS	WIPES
 <p>No. S500-18* EACH <i>Plastic splash goggles, elastic strap</i></p>	 <p>No. S500-20 PAIR <i>Disposable non-woven fabric slip-on shoe covers</i></p>	 <p>No. S500-22* PACKAGE OF 20 <i>7 bu. plastic (3 mil.) contractor disposal bags</i></p>	 <p>No. S500-24 5 lb. BOX <i>Rags (polo shirt material) mixed colors</i></p>	 <p>No. S500-26 PACKAGE OF 100 <i>Flat paper wipes, 13" x 13"</i></p>
PADS	SOCKS	DROP CLOTH	SPILL KIT	COVERALLS
 <p>No. S500-28* PACKAGE OF 100 <i>Absorbent pads 17" x 18" x 1/8" thick</i></p>	 <p>No. S500-32* PACKAGE OF 40 <i>Absorbent socks 3" dia. x 48" long</i></p>	 <p>No. S500-36 EACH <i>Large non-woven fabric drop cloth, water repellent</i></p>	 <p>No. S500-38 EACH <i>Economy Spill Kit in zippered carrying bag</i></p> <p><i>Contains:</i> 1 - splash goggles 1 - pr. nitrile reusable gloves 2 - contractor bags 1 - All liquid absorbent sock 1 - Oil only absorbent sock 5 - All liquid absorbent pads 5 - Oil only absorbent pads 1 - Heavy duty clear plastic zippered carrying bag</p>	 <p>No. S500-50 LARGE</p> <p>No. S500-60 X - LARGE</p> <p><i>Disposable, white non-woven fabric</i></p>
 <p>No. S500-30* PACKAGE OF 100 <i>Absorbent pads 16-1/2" x 19-1/2" x 3/16" thick</i></p>	 <p>No. S500-34* PACKAGE OF 40 <i>Absorbent socks 3" dia. x 48" long</i></p>			

* Part of the S500-38 Economy Spill Kit (see listing above for quantities of each included in the kit).