



# Swivel Sink and Pantry Faucets

TAG:

## B-0230-CR-LN

## Double Pantry Faucet

### Architect/Engineering Specifications:

8" wall mount mixing faucet with polished chrome plated brass body, swivel outlet (less nozzle), ceramic cartridges with check valves, lever handles, and 1/2" NPT female inlets. Certified to ASME A112.18.1/CSA B125.1, NSF 61-Section 9 and NSF 372. Meets ADA ANSI/ICC A117.1 requirements.

Job Name \_\_\_\_\_  
 Model Specified \_\_\_\_\_ Quantity \_\_\_\_\_  
 Variations Specified \_\_\_\_\_  
 Date \_\_\_\_\_

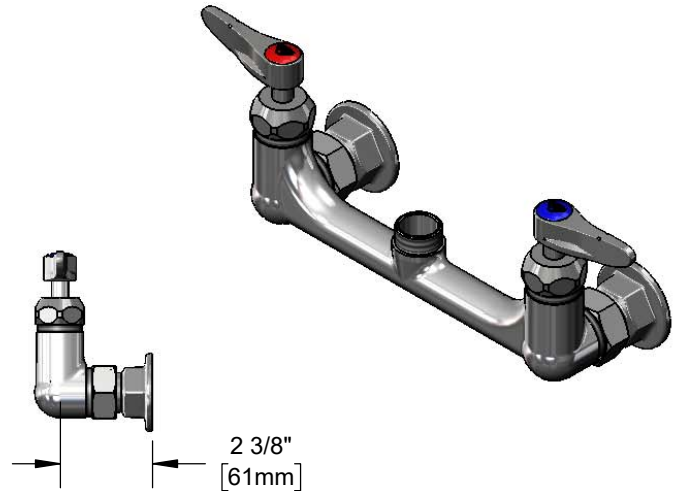
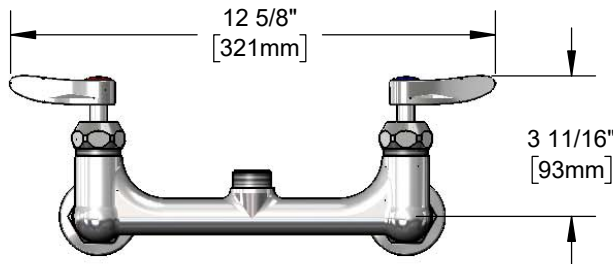

### Features & Benefits:

- 8" wall mount mixing faucet with polished chrome plated brass body
- Swivel outlet accepts T&S swing nozzles
- Lock washer provided for rigid application
- Quarter-turn Cerama cartridges w/ check valves to prevent cross flow of water
- Lever handle w/ color coded indexes
- 1/2" NPT female eccentric inlets w/ Ø 2" flanges
- Adjustable centers from 7 3/4" to 8 1/4"
- Material: Polished chrome plated brass body and chrome plated metal handles

### Product Compliance:

- ASME A112.18.1 / CSA B125.1
- NSF 61 - Section 9
- NSF 372 (Low Lead Content)
- ANSI A117.1 (ADA)



### Warranty: One Year (Limited)

- Cerama Cartridge: Lifetime (Limited)

### Performance Data:

- Pressure: 20 - 125 psi
- Temperature: 40°F - 180°F
- Flow Rate: 14.53 GPM @ 60 psi  
(Outlet Device &/or Final Configuration May Reduce Flow Rate)



### T&S Swing Nozzles

- 059X 6" Swing Nozzle
- 060X 8" Swing Nozzle
- 061X 10" Swing Nozzle
- 062X 12" Swing Nozzle
- 063X 14" Swing Nozzle
- 064X 16" Swing Nozzle
- 065X 18" Swing Nozzle
- 066X 12" Double Joint Swing Nozzle
- 067X 15" Double Joint Swing Nozzle
- 068X 18" Double Joint Swing Nozzle
- 069X 24" Double Joint Swing Nozzle

GPM	Aerated	Non-Aerated (Laminar)	VR Aerated	VR Non-Aerated (VR Laminar)
0.35	N/A	<input type="checkbox"/> B-0199-01-N035	N/A	<input type="checkbox"/> B-0199-06-N035
0.5	N/A	<input type="checkbox"/> B-0199-01-N05	N/A	<input type="checkbox"/> B-0199-06-N05
1.0	<input type="checkbox"/> B-0199-01-F10	N/A	<input type="checkbox"/> B-0199-06-F10	N/A
1.2	<input type="checkbox"/> B-0199-01-F12	<input type="checkbox"/> B-0199-01-LF12	<input type="checkbox"/> B-0199-06-F12	<input type="checkbox"/> B-0199-06-LF12
1.5	<input type="checkbox"/> B-0199-01-WS	<input type="checkbox"/> B-0199-29	<input type="checkbox"/> B-0199-06-WS	<input type="checkbox"/> B-0199-29VR
2.2	<input type="checkbox"/> B-0199-01	<input type="checkbox"/> B-0199-21	<input type="checkbox"/> B-0199-06	<input type="checkbox"/> B-0199-21-VRF

### Optional Outlets (Series 1 / VR Series 6)

### T&S Swivel Goosenecks (D x K)

- 131X 2 13/16" x 2 9/16" Swivel Gooseneck
- 132X 2 5/8" x 5 7/16" Swivel Gooseneck
- 133X 5 11/16" x 6 1/4" Swivel Gooseneck
- 135X 8 3/4" x 5 5/8" Swivel Gooseneck

### Optional Handles

- 4" Wrist Action
- Lever (Standard)
- 4-Arm

### Optional Cartridges With Checks

- Quarter-Turn Cerama w/ Check Valve (Standard)
- Quarter-Turn Eterna w/ Spring Check



T&S BRASS AND BRONZE WORKS, INC.



• 2 Saddleback Cove • Travelers Rest, SC 29690  
 Ph 800-476-4103 • Fax 864-834-3518  
 • Simi Valley, CA • Ph 800-423-0150 • www.tsbrass.com

Date: 01/22/18