

### Features

- Comfort Depth® design offers a convenient 19" step-over height while retaining the same depth as a standard 21" bath.
- Generous 6-foot length provides an incredibly spacious bathing area.
- Molded lumbar support offers extra comfort while bathing.
- Slotted overflow allows for deep soaking.
- Integral apron.
- Integral flange helps prevent water from seeping behind wall and simplifies alcove installation.
- Textured bottom surface.
- Coordinates with other products in the Archer collection.

### Material

- Acrylic.

### Installation

- Left drain.
- Alcove.

### Required Products/Accessories

K-7271 Brass Slotted Overflow Bath Drain

or

K-7272 PVC Slotted Overflow Bath Drain

### Recommended Products/Accessories

K-9529 Removable Bath Seat

K-23726 Drain treatment

K-23732 Tub & shower cleaner



ADA

### Codes/Standards

CSA B45.5/IAPMO Z124

ASTM E162

ASTM E662

ADA









ICC/ANSI A117.1

### KOHLER® Plastic Baths and Receptors Lifetime Limited Warranty

See website for detailed warranty information.

### Available Colors/Finishes

*Color tiles intended for reference only.*

Color	Code	Description
	0	White
	96	Biscuit
	NY	Dune
	95	Ice™ Grey
	G9	Sandbar
	K4	Cashmere
	58	Thunder™ Grey
	7	Black Black™

No change in measurements if connected with drain illustrated. (K-7272)

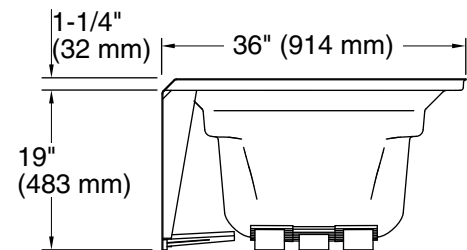
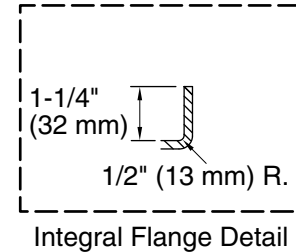
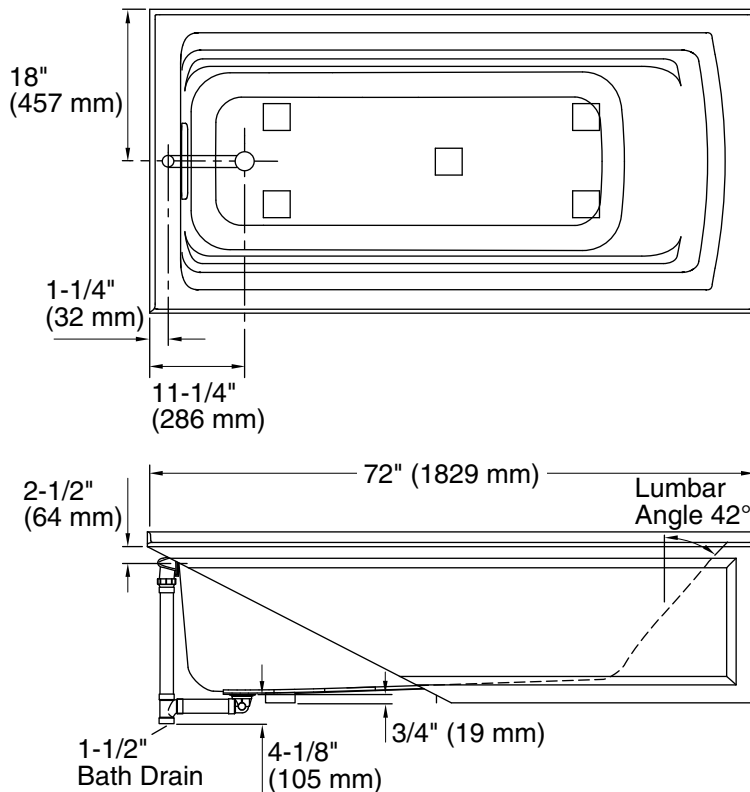

### Technical Information

All product dimensions are nominal.

Installation:	Three-wall alcove
Drain location:	Left
Basin area, bottom:	51-3/8" x 21" (1305 mm x 533 mm)
Basin area, top:	64-1/2" x 30-1/2" (1638 mm x 775 mm)
Weight:	80 lbs (36.3 kg)
Minimum floor load:	40 lbs/ft <sup>2</sup> (195.3 kg/m <sup>2</sup> )
Water depth:	15" (381 mm)
Water capacity:	72 gal (272.5 L)
Minimum flat for door:	1-9/16" (40 mm)

### Notes

- Measure your actual product for rough-in details. Install this product according to the installation instructions.
- The hot water supply should be 70% of the capacity of the bath or greater. Installations will vary.
- ADA compliant when installed to the specific requirements of these regulations.