



For Fire Protection & Other Low Pressure Piping Systems

SPF Welded Outlet Fittings offer the user a high strength, low cost forged threaded and grooved line of fittings specifically designed and manufactured to be installed on proprietary thin wall flow pipe, Schedule 5, 10, and 40 standard wall pipes.

SPF Welded Outlets are forged steel welding outlet fittings. The material used in manufacture meets the chemical and physical requirements of ASTM A 53. SPF Welded Outlet Fittings employ a low weld volume design to provide either a partial or full penetration weld employing a single pass with minimum burn-through and pipe distortion. Threads comply with ANSI B1.20.1. The SPF Welded Outlets are UL Listed and FM Approved for use conforming to the requirements of NFPA 13. SPF Welded Outlet Fittings are rated for 300 psi when used in fire sprinkler system applications.



For Listings/Approval Details and Limitations, visit our website at www.anvilintl.com or contact an Anvil® Sales Representative.

SPF WELDED OUTLET FITTINGS

Outlet Model	Outlet Pipe Size <i>In.</i>	Header Pipe Size <i>In.</i>	Rated Pressure <i>psig</i>
MTM-40	½, ¾, 1	½ - 8 (Sch. 10, 40)	300
	1¼, 1½, 2, 2½, 3, 4	½ - 4 (Sch. 5, DynaFlow)	
	2	4, 6 (EZ-Flow)	
GR-40	1 - 8	1¼ - 8 (Sch. 10, 40)	300
	2½ - 8	2½ - 8 (Sch. 5, DynaFlow)	

- 1) Size-on size (i.e. 2 x 2) SPF Welded Outlet Fittings are not FM Approved.
- 2) FM rated working pressure when welded on Sch. 5 or lightwall pipe is 175 psi.
- 3) Refer to the UL and FM websites for the most current pressure ratings.

PROJECT INFORMATION

APPROVAL STAMP

Project:	<input type="checkbox"/> Approved
Address:	<input type="checkbox"/> Approved as noted
Contractor:	<input type="checkbox"/> Not approved
Engineer:	Remarks:
Submittal Date:	
Notes 1:	
Notes 2:	

SPF Welded Outlets are designed and Manufactured to reduce the amount of weld required to install the Tee-Lets on thin wall or proprietary flow pipe. Typically only one weld-pass completes the installation. SPF Welded Outlets install with less weld volume than any other brand of welding outlet fittings for fire sprinkler applications. To accomplish this:

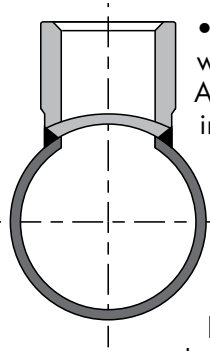

- The contoured end of the fittings employs a reduced outside diameter. Two major advantages are immediately apparent:
- The thinner wall on the contoured end permits welding temperatures to be matched to the thickness of the branch line or main thereby insuring complete penetration without cold welds, weld roll-off, burn-through or excessive distortion.
- On smaller sizes a heavier section is maintained on the threaded end of the fitting. This protects the threads from damage during shipping and handling prior to installation as well as from weld distortion.
- Each outlet size 1 1/2" and larger, whether female threaded, cut grooved or beveled requires the same hole size in the header pipe. This simplifies the installation process.

GENERAL SPECIFICATIONS

- Welded outlet fittings are manufactured from highly weldable steel which conforms to the chemical and physical requirements of ASTM A-53, Grades A or B, Type E. Ease of installation is assured when automatic welding equipment is used to install SPF Welded Outlets.
- Threads are cut in accordance with the requirements of ANSI B1.20.1, national standard for tapered pipe threads.

- SPF Welded Outlets threaded and grooved welding outlet fittings are UL/ULC Listed and FM Approved for use in the fire sprinkler systems installed in accordance with the requirements of NFPA 13. They are rated for 300 PSI operation in fire sprinkler systems, and higher pressures in other non-critical piping systems.
- SPF Welded Outlets are offered in a wide variety of header sizes. The consolidated header sizes shown in the following charts allow the fittings to be installed on more than one header size, permitting the first size listed to fit the header perfectly, while a small gap along the longitudinal center line of the header will appear for the second size listed.
- SPF Welded Outlets are identified by a lot number that provides full traceability.

FOR YOUR PIPING SYSTEMS SPECIFY SPF WELDED OUTLETS

Branch Outlet Fittings shall be SPF Welded Outlets, Lightweight forged steel, employing low weld volume profile to provide for full penetration welds with minimum burn through and pipe distortion on Schedule 5 thru 10, proprietary thin wall, and standard wall pipe. Threads are to be ANSI B1.20.1 and the bore of the fittings calculated to improve flow. Welding outlets to be UL Listed, FM Approved for use conforming to NFPA 13, and pressure rated for 300 PSI maximum.

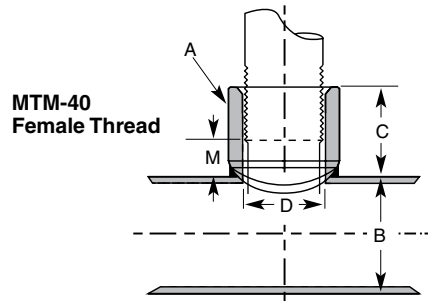

SPF WELDED OUTLETS - MTM-40

Part Number	Nominal Outlet A	Nominal Header B	Outlet Length C	Inside Diameter D	Make Up M	Weight Each
<i>NPT</i>	<i>ln./mm</i>	<i>ln./mm</i>	<i>ln./mm</i>	<i>ln./mm</i>	<i>ln./mm</i>	<i>Lbs./kg</i>
0870001005	1/2 x 13 x	1 1/4 - 1 1/2 32 - 40	1.063 27.0	0.700 17.8	0.500 12.7	0.171 0.08
0870001013		1 1/2 - 2 40 - 50	1.063 27.0	0.700 17.8	0.500 12.7	0.171 0.08
0870001021		2 - 2 1/2 50 - 65	1.063 27.0	0.700 17.8	0.500 12.7	0.171 0.08
0870001039		2 1/2 - 8 65 - 200	1.063 27.0	0.700 17.8	0.500 12.7	0.169 0.08
0870001054	3/4 x 19 x	1 1/4 - 1 1/2 32 - 40	1.125 28.6	0.900 22.9	0.500 12.7	0.260 0.12
0870001062		1 1/2 - 2 40 - 50	1.125 28.6	0.900 22.9	0.500 12.7	0.260 0.12
0870001070		2 - 2 1/2 50 - 65	1.125 28.6	0.900 22.9	0.500 12.7	0.260 0.12
0870001088		2 1/2 - 8 65 - 200	1.125 28.6	0.900 22.9	0.500 12.7	0.256 0.12
0870001096	1 x 25 x	1 1/4 - 1 1/2 32 - 40	1.250 31.8	1.145 29.1	0.500 12.7	0.331 0.15
0870001104		1 1/2 - 2 40 - 50	1.250 31.8	1.145 29.1	0.500 12.7	0.331 0.15
0870001112		2 - 2 1/2 50 - 65	1.250 31.8	1.145 29.1	0.500 12.7	0.320 0.15
0870001120		2 1/2 - 3 65 - 80	1.250 31.8	1.145 29.1	0.500 12.7	0.314 0.14
0870001138		3 - 4 80 - 100	1.250 31.8	1.145 29.1	0.500 12.7	0.309 0.14
0870001146		5 - 8 125 - 200	1.250 31.8	1.145 29.1	0.500 12.7	0.291 0.13
0870001153	1 1/4 x 32 x	1 1/4 - 1 1/2 32 - 40	1.375 34.9	1.490 37.8	0.500 12.7	0.432 0.19
0870001161		1 1/2 - 2 40 - 50	1.375 34.9	1.490 37.8	0.500 12.7	0.421 0.19
0870001179		2 - 2 1/2 50 - 65	1.375 34.9	1.490 37.8	0.500 12.7	0.421 0.19
0870001187		2 1/2 - 3 65 - 80	1.375 34.9	1.490 37.8	0.500 12.7	0.411 0.19
0870001195		3 - 4 80 - 100	1.375 34.9	1.490 37.8	0.500 12.7	0.389 0.18
0870001203		5 - 8 125 - 200	1.375 34.9	1.490 37.8	0.500 12.7	0.389 0.18
0870001211	1 1/2 x 40 x	1 1/2 40	1.625 41.3	1.610 40.9	0.875 22.2	0.477 0.22
0870001229		2 50	1.625 41.3	1.610 40.9	0.875 22.2	0.477 0.22
0870001237		2 1/2 65	1.625 41.3	1.610 40.9	0.875 22.2	0.477 0.22
0870001245		3 - 4 80 - 100	1.625 41.3	1.610 40.9	0.875 22.2	0.477 0.22
0870001252		4 100	1.625 41.3	1.610 40.9	0.875 22.2	0.477 0.22
0870001260		5 - 8 125 - 200	1.625 41.3	1.610 40.9	0.875 22.2	0.477 0.22

SPF WELDED OUTLETS - MTM-40

Part Number	Nominal Outlet A	Nominal Header B	Outlet Length C	Inside Diameter D	Make Up M	Weight Each
<i>NPT/BSPT</i>	<i>ln./mm</i>	<i>ln./mm</i>	<i>ln./mm</i>	<i>ln./mm</i>	<i>ln./mm</i>	<i>Lbs./kg</i>
0870001278	2 x 50 x	2 50	1.750 44.5	2.067 52.5	0.875 22.2	0.857 0.38
0870001286		2 1/2 65	1.750 44.5	2.067 52.5	0.875 22.2	0.829 0.38
0870001294		3 80	1.750 44.5	2.067 52.5	0.875 22.2	0.829 0.39
0870001302		4 100	1.750 44.5	2.067 52.5	0.875 22.2	0.800 0.36
0870001310		6 150	1.750 44.5	2.067 52.5	0.875 22.2	0.743 0.34
0870001328		8 200	1.750 44.5	2.067 52.5	0.875 22.2	0.743 0.34

For Listings/Approval Details and Limitations, visit our website at www.anvilintl.com or contact an Anvil® Sales Representative.

GR-40 Cut Groove Standard Weight

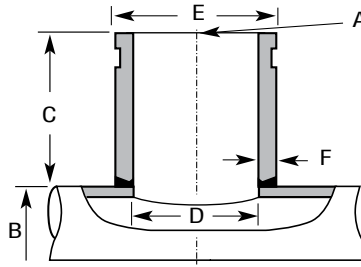

SPF WELDED OUTLETS - GR-40 (Nominal Sizes 1 1/4" thru 2")

GR-40 Cut Groove Std. Wt.	Nominal Outlet A	Nominal Header B	Outlet Length C	Inside Diameter D	Outside Diameter E	Wall Thickness F
<i>NPT</i>	<i>ln./mm</i>	<i>ln./mm</i>	<i>ln./mm</i>	<i>ln./mm</i>	<i>ln./mm</i>	<i>ln./mm</i>
0870004009	1 1/4 x 32 x	1 1/4 32	3 80	1.368 34.7	1.660 42.2	0.140 3.6
0870004025		1 1/2 40	3 80	1.368 34.7	1.660 42.2	0.140 3.6
0870004041		2 - 2 1/2 50 - 65	3 80	1.368 34.7	1.660 42.2	0.140 3.6
0870004066		3 - 4 80 - 100	3 80	1.368 34.7	1.660 42.2	0.140 3.6
0870004082		5 - 8 125 - 200	3 80	1.368 34.7	1.660 42.2	0.140 3.6
0870004108	1 1/2 x 40 x	1 1/2 40	3 80	1.610 40.9	1.900 48.3	0.145 3.7
0870004124		2 50	3 80	1.610 40.9	1.900 48.3	0.145 3.7
0870004140		2 1/2 65	3 80	1.610 40.9	1.900 48.3	0.145 3.7
0870004165		3 - 4 80 - 100	3 80	1.610 40.9	1.900 48.3	0.145 3.7
0870004181		5 - 8 125 - 200	3 80	1.610 40.9	1.900 48.3	0.145 3.7
0870004207	2 x 50 x	2 50	3 80	2.067 52.5	2.375 60.3	0.154 3.9
0870004223		2 1/2 65	3 80	2.067 52.5	2.375 60.3	0.154 3.9
0870004249		3 80	3 80	2.067 52.5	2.375 60.3	0.154 3.9
0870004264		4 100	3 80	2.067 52.5	2.375 60.3	0.154 3.9
0870004280		6 150	3 80	2.067 52.5	2.375 60.3	0.154 3.9
0870004306		8 200	3 80	2.067 52.5	2.375 60.3	0.154 3.9

Note: Welded Outlets are manufactured to fit size-on-size, that is the contoured shape on a given Welded Outlet is made to fit perfectly on the first listed header size. If installed on the second header size marked on the fitting, a slight gap of approximately 1/32" will appear along the longitudinal centerline of the header. For example, a 1" x 2 - 2 1/2" Welded Outlet, is a 1" outlet fitting manufactured to fit perfectly on the 2" header size listed, while leaving a 1/32" gap along the longitudinal centerline of the 2 1/2" size. If a perfect fit is required for a 2 1/2" header pipe, then a 1" x 2 1/2 - 3" Welded Outlet would be ordered. Size consolidations are employed to reduce inventory and provide for greater flexibility.

(Additional larger sizes on next page.)

GR-40 Cut Groove Standard Weight

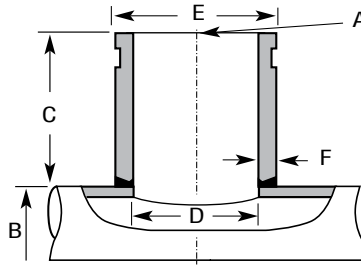

SPF WELDED OUTLETS - GR-40 (Nominal Sizes 2 1/2" thru 8")

GR-40 Cut Groove Std. Wt.	Nominal Outlet A	Nominal Header B	Outlet Length C	Inside Diameter - D		Outside Diameter E	Wall Thickness - F	
				Standard Weight	Schedule 10		Standard Weight	Schedule 10
<i>NPT</i>	<i>ln./mm</i>	<i>ln./mm</i>	<i>ln./mm</i>	<i>ln./mm</i>	<i>ln./mm</i>	<i>ln./mm</i>	<i>ln./mm</i>	<i>ln./mm</i>
0870004322	2 1/2 x 65 x	2 1/2 65	3 80	2.469 62.7	2.635 67.0	2.875 76.2	0.203 5.0	0.120 3.0
0870004348		4 100	3 80	2.469 62.7	2.635 67.0	2.875 76.2	0.203 5.0	0.120 3.0
0870004363		6 175	3 80	2.469 62.7	2.635 67.0	2.875 76.2	0.203 5.0	0.120 3.0
0870004389		8 200	3 80	2.469 62.7	2.635 67.0	2.875 76.2	0.203 5.0	0.120 3.0
0870004405	3 x 80 x	3 80	3 80	3.068 78.0	3.260 83.0	3.500 88.0	0.216 5.0	0.120 3.0
0870004421		4 100	3 80	3.068 78.0	3.260 83.0	3.500 88.0	0.216 5.0	0.120 3.0
0870004447		6 150	3 80	3.068 78.0	3.260 83.0	3.500 88.0	0.216 5.0	0.120 3.0
0870004462		8 200	3 80	3.068 78.0	3.260 83.0	3.500 88.0	0.216 5.0	0.120 3.0
0870004504	4 x 100 x	4 100	4 100	4.026 102.0	4.260 108.0	4.500 114.0	0.237 6.0	0.120 3.0
0870004520		6 150	4 100	4.026 102.0	4.260 108.0	4.500 114.0	0.237 6.0	0.120 3.0
0870004546		8 200	4 100	4.026 102.0	4.260 108.0	4.500 114.0	0.237 6.0	0.120 3.0
0870004603	6 x 150 x	6 150	4 100	6.065 155.0	6.357 161.5	6.625 168.3	0.280 7.1	0.134 3.0
0870004629		8 200	4 100	6.065 155.0	6.357 161.5	6.625 168.3	0.280 7.1	0.134 3.0
0870004702	8 x 200 x	8 200	4 100	7.981 203.0	8.329 212.0	8.625 213.0	0.322 8.0	0.148 3.0

Note: Welded Outlets are manufactured to fit size-on-size, that is the contoured shape on a given Welded Outlet is made to fit perfectly on the first listed header size. If installed on the second header size marked on the fitting, a slight gap of approximately 1/32" will appear along the longitudinal centerline of the header. For example, a 1" x 2 - 2 1/2" Welded Outlet, is a 1" outlet fitting manufactured to fit perfectly on the 2" header size listed, while leaving a 1/32" gap along the longitudinal centerline of the 2 1/2" size. If a perfect fit is required for a 2 1/2" header pipe, then a 1" x 2 1/2 - 3" Welded Outlet would be ordered. Size consolidations are employed to reduce inventory and provide for greater flexibility.

Threading Practice

SPF Welded Outlets thread form is consistent with Aeronautical National Form (ANPT) AS71051. The thread is fully formed over both the L-1 hand tight and L-3 wrench tight. NPT tapered threads are typically gauged only over the L-1 threads. This makes SPF Welded Outlets more forgiving of field cut threaded pipe that may only marginally conform to the specification. Fewer leaks translate into lower costs.

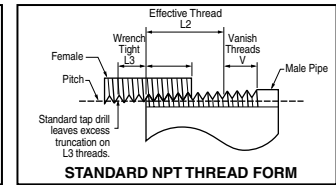
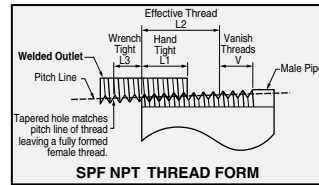

Ease of Installation

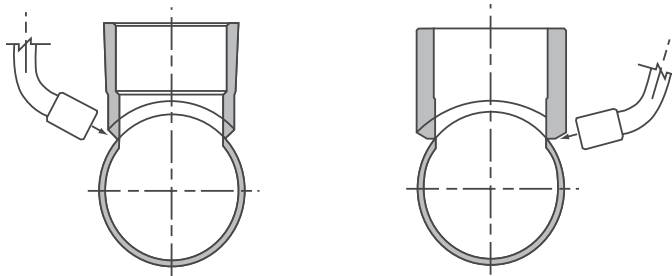

SPF Welded Outlets are designed to sit higher on the pipe, thereby requiring less weld and eliminating burn through. SPF Welded Outlets sit higher on the header or branch line pipe than competitive fittings. This allows the welding torch to remain in an optimum position for welding. In addition, 1 1/2" and larger female threaded and grooved welded outlets require the same hole size for installation. This results in fewer change overs when installed using automatic welders.

NPT TAPERED PIPE THREADS

Drop Nipple or Tee-Let Outlet Size	L1 Hand Tight		L3 Wrench Tight		Total L1 - L3 Length		L2 Effective Threads	
	In./mm	In./mm Threads	In./mm	Threads	In./mm	Threads	In./mm	Threads
1/2	0.320	4.48	0.214	3.00	0.534	7.48	0.534	7.47
15	8.1		5.4		13.6		13.6	
3/4	0.339	4.75	0.214	3.00	0.553	7.75	0.546	7.64
20	8.6		5.4		14.0		13.9	
1	0.400	4.60	0.261	3.00	0.661	7.60	0.683	7.85
25	10.2		6.6		16.8		17.3	
1 1/4	0.420	4.83	0.261	3.00	0.681	7.83	0.707	8.13
32	10.7		6.6		17.3		18.0	
1 1/2	0.420	4.83	0.261	3.00	0.697	7.83	0.724	8.32
40	10.7		6.6		17.7		18.4	
2	0.436	5.01	0.261	3.00	0.706	8.01	0.757	8.70
50	11.1		6.6		17.9		19.2	
2 1/2	0.682	5.46	0.250	2.00	0.932	7.46	1.138	9.10
65	17.3		6.4		23.7		28.9	
3	0.766	6.13	0.250	2.00	1.016	8.13	1.200	9.60
80	19.5		6.4		25.8		30.5	
4	0.844	6.75	0.250	2.00	1.094	8.75	1.300	10.40
100	21.4		6.4		27.8		33.0	

Welding Practice

When measured with respect to linear inches of weld required for installation, SPF Welded Outlets require up to 15% less weld than competitive fittings. This reduces time and savings over time are substantial. The diameter of the contoured end of Welded Outlet has been reduced so that the wall thickness more nearly matches the header or branch line pipe wall thickness. Therefore, current and voltage settings required for welding are set to provide for adequate penetration without burn through and cold shutting. Also, weld volume required for installation is lower for SPF Welded Outlets than most other fittings. Typically, SPF Welded Outlets require one-weld pass for attachment.

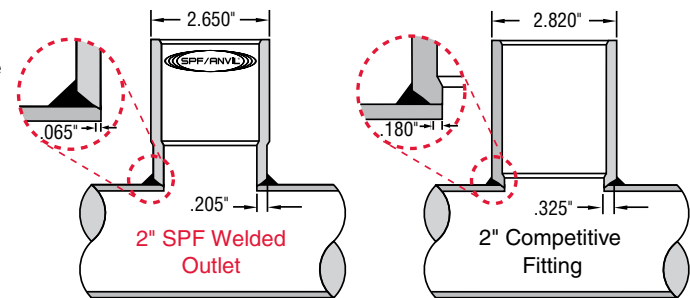

WELDING PRACTICE

Outlet Size	SPF WELDED OUTLETS				COMPETITIVE FITTING			
	WELD VOLUME*		LINEAR WELDING		WELD VOLUME*		LINEAR WELDING	
In. (mm)	Cross Sec. Area	%less	In. (mm)	%less	Cross Sec. Area	%more	In. (mm)	%less
1" 25	0.051 sq. in. 32.9 sq mm	12%	2.48 62.9	0%	0.058 sq. in. 37.4 sq mm	12%	2.48 62.9	0%
1 1/4" 32	0.032" 20.6	48%	2.88 73.1	4%	0.063 40.6	48%	3.01 76.4	4%
1 1/2" 40	0.036" 23.2	40%	3.12 79.2	10%	0.060 38.7	40%	3.46 87.8	10%
2" 50	0.040" 25.8	62%	3.77 95.7	15%	0.106 68.3	62%	4.41 112.0	15%

Recommended Installation Procedures

SPF Welded Outlet Fittings are designed and manufactured to reduce the cost of installation from both the standpoint of labor required and energy consumed. In addition, by following the recommended installation procedures, many of the problems associated with installing welding outlet fittings on standard weight or light weight pipe are eliminated, including burn through and excessive shrinkage resulting in pipe distortion.

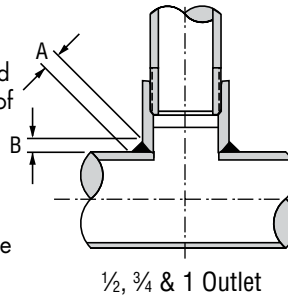

Recommended Hole Sizes

The hole cut in the branch or header pipe can be cut prior or subsequent to attachment of the Welded Outlets. One advantage of cutting the hole after welding is that the pipe is left intact during welding, thereby, reducing shrinkage and possible distortion. If holes are cut prior to welding, as some codes require, then the following hole sizes are recommended.

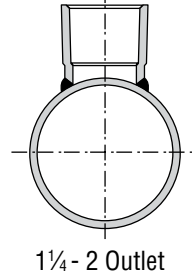

Recommended Welding Procedures

SPF Welded Outlet Fittings are designed to be installed on standard weight or light weight pipe with one weld pass on sizes through 4". Moreover, the wall thickness at the weld end of the fitting approximately matches standard weight pipe. Accordingly, heat settings can be made to optimize penetration on both the fitting and the pipe which it is being welded. Aside from reducing the likelihood of burn through and distortion resulting from excessive heat, the amount of weld required for adequate penetration is significantly reduced.

As a general rule, the weld should be only as hot as required to allow the weld to penetrate the materials being welded while concomitantly allowing gases developed in the welding process to escape. Every effort must be made to avoid welding too hot or overheating both the pipe and the Welded Outlets. Excessive heat may cause the wrench tight threads (those in the bottom of the Welded Outlets near the weld zone) to distort while also causing the branch pipe to bend. It should be noted that SPF Welded Outlet Fittings have been subjected to exhaustive testing and evaluation, and only negligibly distort when subjected to excessive heat. The threads, on the other hand, may not return to their gauged form after cooling if excessive heat causes them to expand. The following is intended only as a guide, and assumes that the welding equipment is properly calibrated and functioning normally and the operator is qualified.

Note: Please refer to www.anvilintl.com or latest catalog for recommended hole size and welding practice.

RECOMMENDED AMOUNT OF WELD		
Outlet Size	A	B
ln./mm	ln./mm	ln./mm
1 25	1/4 7	3/16 5
1 1/4 31	1/4 7	3/16 5
1 1/2 38	5/16 8	1/4 7
2 50	5/16 8	1/4 7
2 1/2 63	5/16 8	1/4 7
3 75	3/8 10	5/16 8
4 100	3/8 10	5/16 8

RECOMMENDED OUTLET HOLE SIZES		
Welded Outlet Size	Type	Recommended Hole Size
ln./mm		ln./mm
1/2 13	MTM-40	5/8 16
3/4 19	MTM-40	7/8 22
1 25	MTM-40	1 1/8 28
1 1/4 31	MTM-40	1 1/2 38
1 1/4 31	GR-40	1 3/8 35
1 1/2 38	MTM-40 or GR-40	1 5/8 41
2 50	MTM-40 or GR-40	2 50
2 1/2 63	GR-40	2 7/8 61
3 75	GR-40	3 75
4 100	GR-40	4 100

Holes may be cut employing mechanical means – including hole sawing, mechanical flame cutting (oxy-acetylene or propane), and air plasma cutting (constricted tungsten arc) machines. Anvil offers a simple approach to cutting the hole. Hand-held templates are sized to match your plasma cutter.



RECOMMENDED SETTINGS FOR MICROWIRE WELDING PROCESS							
Header Size	Pipe Wall Thickness	Welded Outlet MTM-40 & GR-40	Electrode Size	Welding Current	Arc. Volts	Wire Feed	Travel Speed
<i>In./mm</i>	<i>In./mm</i>	<i>In./mm</i>		<i>AMPS-DC</i>	<i>POS.</i>	<i>IPM</i>	<i>IPM</i>
1¼ - 2 31-50	0.065 2	½ - 2 13-50	0.035	100-130	16-20	210	25-30
		2½ - 4 63-100	0.035	115-150	17-21	270	20-25
	0.109 3	½ - 2 13-50	0.035	110-140	18-22	220	25-30
		2½ - 4 63-100	0.035	120-160	19-22	290	20-25
2½ - 4 63-100	0.083 2.5	½ - 2 13-50	0.035	110-140	17-20	210	20-25
		2½ - 4 63-100	0.035	120-150	17-20	270	20-25
	0.120 3	½ - 2 13-50	0.035	120-160	19-22	290	20-25
		2½ - 4 63-100	0.035	130-160	19-22	240	20-25
5-6 125-150	0.109 3	½ - 2 13-50	0.035	120-150	17-20	210	20-25
		2½ - 4 63-100	0.035	130-150	18-20	270	15-20
	0.134 3.5	½ - 2 13-50	0.035	130-160	19-22	290	20-25
		2½ - 4 63-100	0.035	140-160	20-22	270	15-20
8 200	0.109 3	2½ - 4 63-100	0.045	180-205	20-24	245	27-32
		½ - 2 13-50	0.035	120-150	17-20	240	20-25
		2½ - 4 63-100	0.035	130-150	18-20	260	15-20
	0.148 3.5	2½ - 4 63-100	0.045	170-220	18-22	290	12-18
		½ - 2 13-50	0.035	130-160	19-22	240	20-25
		2½ - 4 63-100	0.035	140-160	20-22	260	15-20
2½ - 4 63-100	0.045	180-225	20-24	290	12-18		

Shielding Gas Flow (FOR ALL SIZES) 20-25 CFH

- 1) Co₂ - Deeper penetration, faster welding, low cost.
- 2) 25% - Argon, 75% - Co₂, Recommended for .134 wall and lighter, high welding speeds without melt through, minimum distortion and spatter, good penetration.

Anvil assumes no liability for any consequential damages resulting from the improper use of its Welded Outlet Fittings, nor for any recommendations made with respect to installation procedures.