

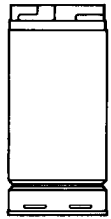

# METAL-FAB INC.

## MetalFab Pipe and Fittings Class B Vent for Gas Only



Vent Pipe

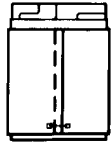

Adjustable Vent Pipe



Cap 3"-6"

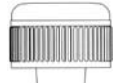

Universal Cap

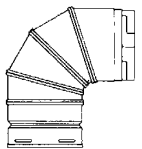

90 Degree Ell

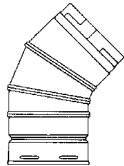

45 Degree Ell

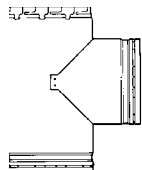

Tee

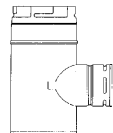

Swivel Tee 3-6"



Tee Cap

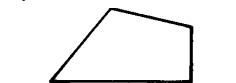

Adjustable Flashing

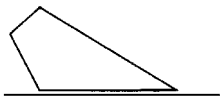

Flashing 12/12 Pitch



Tall Cone Flashing

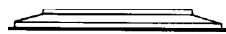

Storm Collar



Thimble

Model#	Description	Ctn Qty.	Code#
<b>3 Inch RD B-Vent</b>			
466-0100	3 x 5 Foot B-Vent Pipe	4	3M5
466-0105	3 x 4 Foot B-Vent Pipe	6	3M4
466-0110	3 x 3 Foot B-Vent Pipe	6	3M3
466-0115	3 x 2 Foot B-Vent Pipe	6	3M24
466-0120	3 x 18 Inch B-Vent Pipe	6	3M18
466-0125	3 x 12 Inch B-Vent Pipe	6	3M12
466-0130	3 x 12 Inch Adj B-Vent Pipe	6	3M12A
466-0135	3 Inch 90 Adj Ell	6	3M90
466-0140	3 Inch Adj Angle	6	3M45/60
466-0150	3 Inch Tee Cap	6	3MTC
466-0155	3 Inch Vent Cap	12	3MCHP
466-0160	3 Inch Std. Adj. Flashing	12	3MF
466-0164	3 Inch Flashing 12/12 Pitch	6	3MF-12
466-0165	3 Inch Flat Tall Cone Flashing	6	3MFT
466-0170	3 Inch Storm Collar	12	3MSC
466-0175	3 Inch Partition Thimble	6	3MPT
466-0176	3 - 4" B Vent Increaser	6	3MI4
466-0326	3 - 5" B Vent Increaser	6	3MI5

<b>4 Inch RD B-Vent</b>			
466-0180	4 x 5 Foot B-Vent Pipe	6	4M5
466-0185	4 x 4 Foot B-Vent Pipe	6	4M4
466-0190	4 x 3 Foot B-Vent Pipe	6	4M3
466-0195	4 x 2 Foot B-Vent Pipe	6	4M24
466-0192	4 x 18 Inch B-Vent Pipe	6	4M18
466-0200	4 x 12 Inch B-Vent Pipe	6	4M12
466-0205	4 x 12 Inch Adj B-Vent Pipe	6	4M12A
466-0208	4 x 6 Inch Adv B-Vent Pipe	6	4M6A
466-0209	4 x 6 Inch B-Vent Pipe	6	4M6
466-0210	4 Inch 90 Adj Ell	6	4M90
466-0215	4 Inch Adj Angle	6	4M45/60
466-0217	4 Inch Swivel Tee	6	4M4ST4
466-0218	4 x 4 x 3 Swivel Tee	6	4M4ST3
466-0206	4 Inch Swivel Wye	6	4M4SYS4
466-0207	4 x 4 x 3 Swivel Wye	6	4M4SY3
466-0220	4 Inch Tee Cap	6	4MTC
466-0225	4 Inch Vent Cap	12	4MCHP
466-0246	4 Inch Universal Cap	6	4MCUHP
466-0230	4 Inch Std. Adj. Flashing	12	4MF
466-0234	4 Inch Flashing 12/12 Pitch	6	4MF-12
466-0235	4 Inch Flat Tall Cone Flashing	6	4MFT
466-0240	4 Inch Storm Collar	12	4MSC
466-0245	4 Inch Partition Thimble	6	4MPT
466-0327	4 - 5 Inch Vent Increaser	6	4MI5
466-0406	4 x 6 Inch B Vent	6	4MI6



# METAL-FAB INC.

## Class B Vent for Gas Only

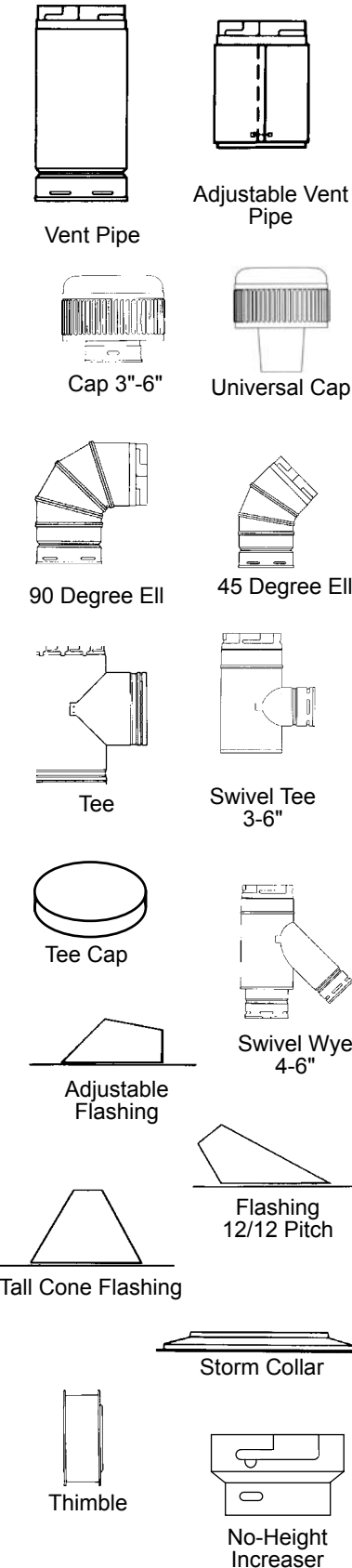

Model#	Description	Ctn Qty.	Code#
--------	-------------	----------	-------

### 5 Inch RD B-Vent

466-0250	5 x 5 Foot B-Vent Pipe	6	5M5
466-0255	5 x 4 Foot B-Vent Pipe	6	5M4
466-0260	5 x 3 Foot B-Vent Pipe	6	5M3
466-0265	5 x 2 Foot B-Vent Pipe	6	5M24
466-0270	5 x 18 Inch B-Vent Pipe	6	5M18
466-0275	5 x 12 Inch B-Vent Pipe	6	5M12
466-0280	5 x 12 Inch Adj B-Vent Pipe	6	5M12A
466-0281	5 x 6 Inch B-Vent Pipe	6	5M6
466-0285	5 Inch 90 Adj Ell	6	5M90
466-0290	5 Inch Adj Angle	6	5M45/60
466-0291	5 x 5 x 4 Swivel Wye	6	5M5SY4
466-0292	5 x 5 x 3 Swivel Wye	6	5M5SY3
466-0293	5 x 4 x 3 Swivel Wye	6	5M4SY3
466-0408	5 x 4 x 4 B Vent Swivel Wye	6	5M4SY4
466-0296	5 Inch Swivel Tee	6	5M5ST5
466-0297	5 x 5 x 4 Swivel Tee	6	5M5ST4
466-0298	5 x 5 x 3 Swivel Tee	6	5M5ST3
466-0300	5 Inch Tee Cap	6	5MTC
466-0305	5 Inch Vent Cap	12	5MCHP
466-0321	5 Inch Universal Cap	6	5MCUHP
466-0310	5 Inch Std. Adj. Flashing	12	5MF
466-0314	5 Inch Flashing 12/12 Pitch	6	5MF-12
466-0315	5 Inch Flat Tall Cone Flashing	6	5MFT
466-0320	5 Inch Storm Collar	12	5MSC
466-0325	5 Inch Partition Thimble	6	5MPT
466-0407	5 x 6 No-Height Increaser	6	5MIN6

### 6 Inch RD B-Vent

466-0330	6 x 5 Foot B-Vent Pipe	6	6M5
466-0335	6 x 4 Foot B-Vent Pipe	6	6M4
466-0340	6 x 3 Foot B-Vent Pipe	6	6M3
466-0345	6 x 2 Foot B-Vent Pipe	6	6M24
466-0350	6 x 18 Inch B-Vent Pipe	6	6M18
466-0355	6 x 12 Inch B-Vent Pipe	6	6M12
466-0360	6 x 12 Inch Adj B-Vent Pipe	6	6M12A
466-0365	6 Inch Adj 90Ell	6	6M90
466-0370	6 Inch Adj Angle	6	6M45/60
466-0372	6 x 6 x 4 Swivel Wye	6	6M6SY4
466-0373	6 x 6 x 3 Swivel Wye	6	6M6SY3
466-0376	6 Inch Swivel Tee	6	6M6ST6
466-0377	6 x 6 x 5 Swivel Tee	6	6M6ST5
466-0378	6 x 6 x 4 Swivel Tee	6	6M6ST4
466-0379	6 x 6 x 3 Swivel Tee	6	6M6ST3
466-0381	6 x 5 x 4 Swivel Tee	6	6M5ST4
466-0380	6 Inch Tee Cap	6	6MTC
466-0385	6 Inch Vent Cap	12	6MCHP
466-0411	6 Inch Universal Cap	6	6MCUHP
466-0390	6 Inch Std. Adj. Flashing	12	6MF
466-0394	6 Inch Flashing 12/12 Pitch	6	6MF-12
466-0395	6 Inch Flat Tall Cone Flashing	6	6MFT
466-0400	6 Inch Storm Collar	12	6MSC
466-0405	6 Inch Partition Thimble	6	6MPT



# METAL-FAB INC.

## Class B Vent for Gas Only

Model#	Description	Ctn Qty.	Code#
--------	-------------	----------	-------

### 7 Inch RD B-Vent

466-0410	7 x 5 Foot B-Vent Pipe	6	7M5
466-0415	7 x 4 Foot B-Vent Pipe	6	7M4
466-0430	7 x 18 Inch B-Vent Pipe	6	7M18
466-0445	7 Inch Adj 90EII	6	7M90
466-0450	7 Inch 45 Adj Angle	6	7M45
466-0455	7 Inch Standard Tee	6	7MT
466-0460	7 Inch Tee Cap	6	7MTC
466-0465	7 Inch Vent Cap	12	7MC
466-0470	7 Inch Std. Adj. Flashing	12	7MF
466-0474	7 Inch Flashing 12/12 Pitch	6	7MF-12
466-0480	7 Inch Storm Collar	12	7MSC

### 8 Inch RD B-Vent

466-0485	8 x 5 Foot B-Vent Pipe	4	8M5
466-0486	8 x 4 Foot B-Vent Pipe	4	8M4
466-0490	8 x 3 Foot B-Vent Pipe	4	8M3
466-0500	8 x 12 Inch B-Vent Pipe	4	8M12
466-0510	8 Inch 45 Adj Angle	4	8M45
466-0515	8 Inch Standard Tee	4	8MT
466-0520	8 Inch Tee Cap	1	8MTC
466-0525	8 Inch Vent Cap	4	8MC
466-0530	8 Inch Std. Adj. Flashing	12	8MF
466-0534	8 Inch Flashing 12/12 Pitch	6	8MF-12
466-0535	8 Inch Storm Collar	12	8MSC

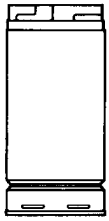

Vent Pipe

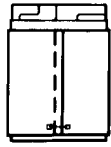

Adjustable Vent Pipe

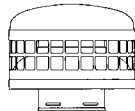

Cap 7"-12"

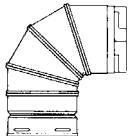

90 Degree EII



45 Degree EII

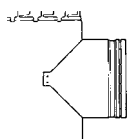

Tee

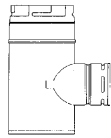

Swivel Tee 3-6"



Tee Cap

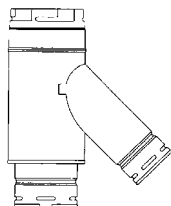

Swivel Wye 4-6"



Adjustable Flashing

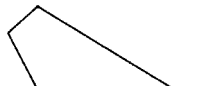

Flashing 12/12 Pitch



Tall Cone Flashing



Storm Collar



Thimble



# METAL-FAB INC.

## Class A Vent for Wood, Oil or Gas

Model#	Description	Ctn Qty.	Code#
--------	-------------	----------	-------

### 6 Inch RD A-Vent

466-1000	6 x 4 Foot A-Vent Pipe		6TGG48
466-1005	6 x 3 Foot A-Vent Pipe		6TGG36
466-1010	6 x 2 Foot A-Vent Pipe		6TGG24
466-1015	6 x 12 Inch A-Vent Pipe		6TGG12
466-1020	6 Inch 30 Angle		6TGG30
466-1025	6 Inch Ceiling Support		6TGCSP
466-1035	6 Inch Wall Band		6TGWB
466-1045	6 Inch Firestop Assembly		6TGFSFA
466-1050	6 Inch Insulation Shield		6TGIS
466-1055	6 Inch Rain Cap		6TGRC
466-1060	6 Inch Storm Collar		6TGSC
466-1065	6 Inch Std Flashing		6TGF
466-1067	6 Inch Tee with Cap		6TGG



Class A Vent Pipe

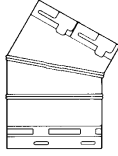

30 Angle

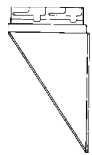

Wall Support

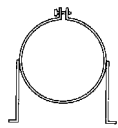

Wall Band

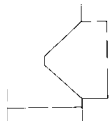

Stainless Steel Drip Tee w/ Cap

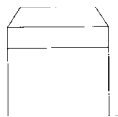

Insulation Shield

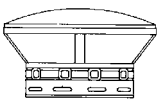

Std Flashing

### 8 Inch RD A-Vent

466-1200	8 x 4 Foot A-Vent Pipe		8TGG48
466-1205	8 x 3 Foot A-Vent Pipe		8TGG36
466-1210	8 x 2 Foot A-Vent Pipe		8TGG24
466-1220	8 Inch 30 Angle		8TGG30
466-1225	8 Inch Ceiling Support		8TGCSP
466-1230	8 Inch Wall Support		8TGWS
466-1235	8 Inch Wall Band		8TGWB
466-1245	8 Inch Firestop Assembly		8TGFSFA
466-1255	8 Inch Rain Cap		8TGRC
466-1260	8 Inch Storm Collar		8TGSC
466-1265	8 Inch Std Flashing		8TGF
466-1267	8 Inch Tee with Cap		8TGGT

### Chimney Liner

Complete Handle Kits - Include specified length of 2-ply aluminum flex with quick connect couplers on each end, vent cap, storm collar, flashing, mortar guard and tag. Flexible product that can snake through bends, curves, and offsets. Liner guard protects the lower coupling from damage as it is pulled down through bends, curves and offsets of masonry chimneys.

466-3001	3 x 35 Foot Chimney Liner		MLK0335
466-3006	4 x 35 Foot Chimney Liner		MLK0435
466-3011	5 x 35 Foot Chimney Liner		MLK0535
466-3016	6 x 35 Foot Chimney Liner		MLK0635
466-3002	4 x 25 Foot Chimney Liner		MLK0425
466-3003	5 x 25 Foot Chimney Liner		MLK0525
466-3004	6 x 25 Foot Chimney Liner		MLK0625



Chimney Liner



# METAL-FAB INC.



## 3" Diameter Corr/Guard - Single Wall

Model#	Description	Ctn Qty.	Code#
--------	-------------	----------	-------

### Pipe Lengths

466-5001	6" long straight length, single wall	6	3CGSW6
466-5003	12" long straight length, single wall	6	3CGSW12
466-5005	18" long straight length, single wall	6	3CGSW18
466-5007	24" long straight length, single wall	6	3CGSW24
466-5009	36" long straight length, single wall	6	3CGSW36
466-5011	48" long straight length, single wall	6	3CGSW48

### Variable Lengths

466-5015	7.5" - 22" variable length, single wall	4	3CGSWVL22
----------	---	---	-----------

### Fittings

466-5017	45 degree elbow, single wall	6	3CGSW45L
466-5019	90 degree elbow, single wall	6	3CGSW90L
466-5021	Tee, single wall	4	3CGSWT
466-5023	Tee cap w/drain, single wall	4	3CGSWTC
466-5025	Horizontal drain section, single wall	4	3CGSWDS

### Terminations

466-5027	Horizontal male termination, single wall	4	3CGSWHTM
466-5029	90 degree male termination, single wall	4	3CGSW90LTM

### Roof/Wall Penetrations/Accessories

466-5031	Single wall, wall penetration	1	3CGSWWPK
----------	-------------------------------	---	----------

### Support/Guides

466-5033	Wall support 2" clearance, single wall	4	3CGSWWS2
466-5035	Plate support/firestop, single wall	4	3CGSWPS
466-5037	Wall hanger 2" clearance, single wall	4	3CGSWWH2
466-5039	Horizontal Vent Kit	1	3CGSWHVK

### Adapter

466-5036	Adapter for WMC CGI/CGS Boilers	3CGWLA
466-5038	Adapter for WMC GV Series 3&4 Boilers	3CGWTA
466-5041	Adapter for Rheem Tankless	3CGSWPA

### 4" Diameter Corr/Guard - Single Wall

466-5043	Horz. 4 Vent Kit for Rheem 7.4 Tankless Water Heater	4CGSWHVK
466-5044	7.5" - 22" Variable Length	4CGSWVL22
466-5045	6" Straight Length	4CGSW6

