

- A** Sharp hose bends. Horizontal run does not have minimum pitch of 2 in. per ft.
- B** Sharp hose bends. Hose not continuously supported at least every 12 in., resulting in hose sag.
- C** Sharp hose bends. Does not have at least 6 in. vertical rise immediately out of humidifier, and nozzle is not pitched up.
- D** Horizontal run does not have minimum pitch of 2 in. per ft. Sharp hose bends. Downward pitch does not have trap at its lowest point.

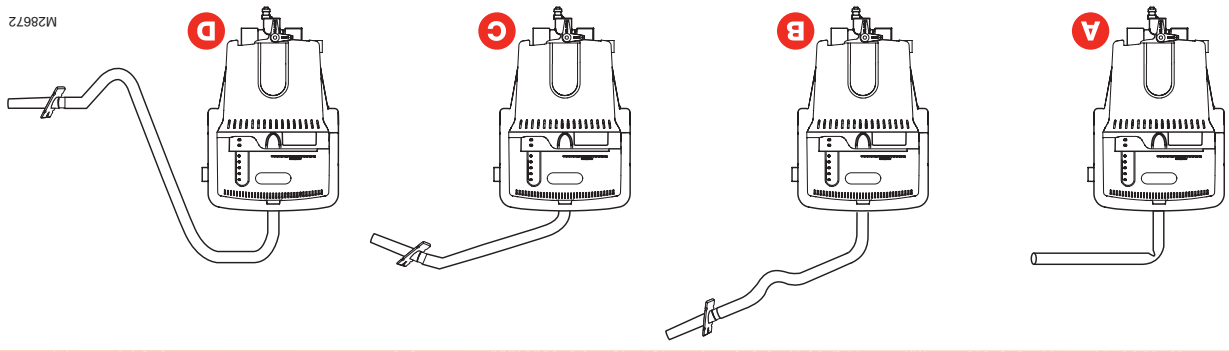

AVOID THESE COMMON MISTAKES

OPEN FOR STEP-BY-STEP INSTRUCTION

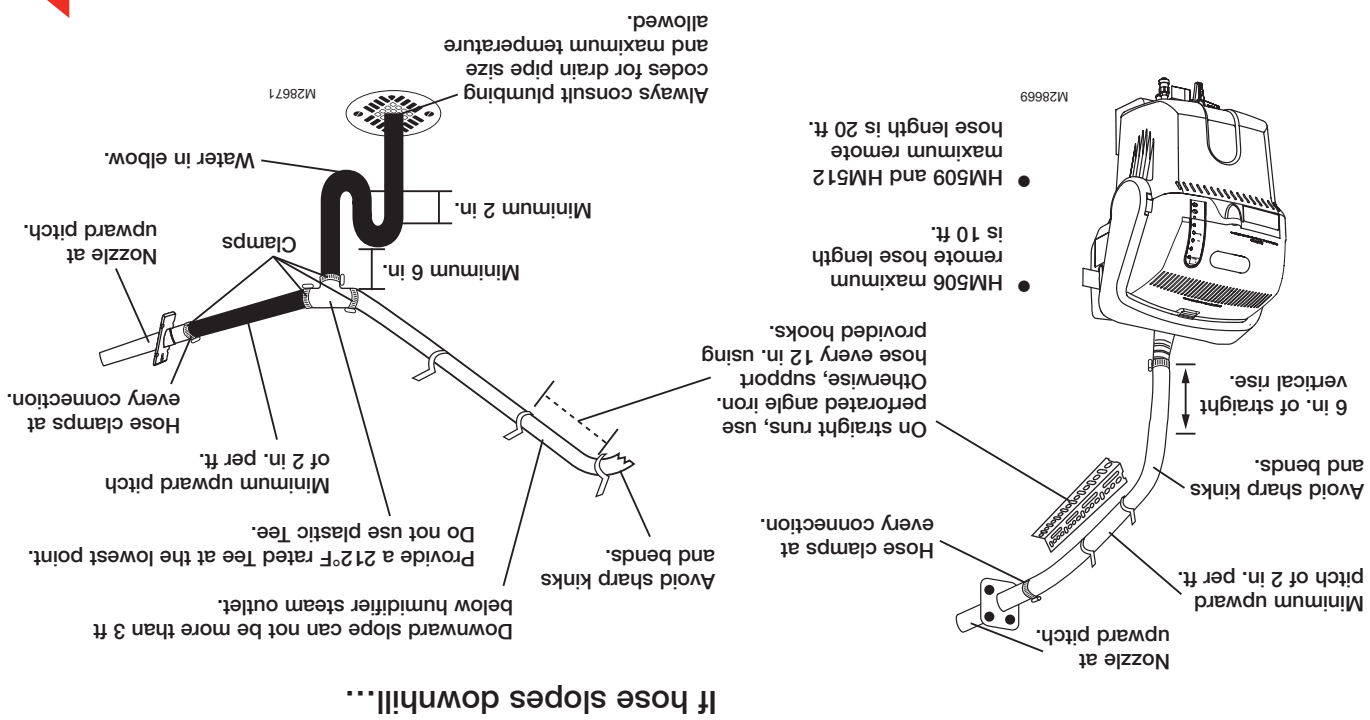

REQUIREMENTS FOR PROPER INSTALLATION

ENDLESS INSTALLATION OPTIONS

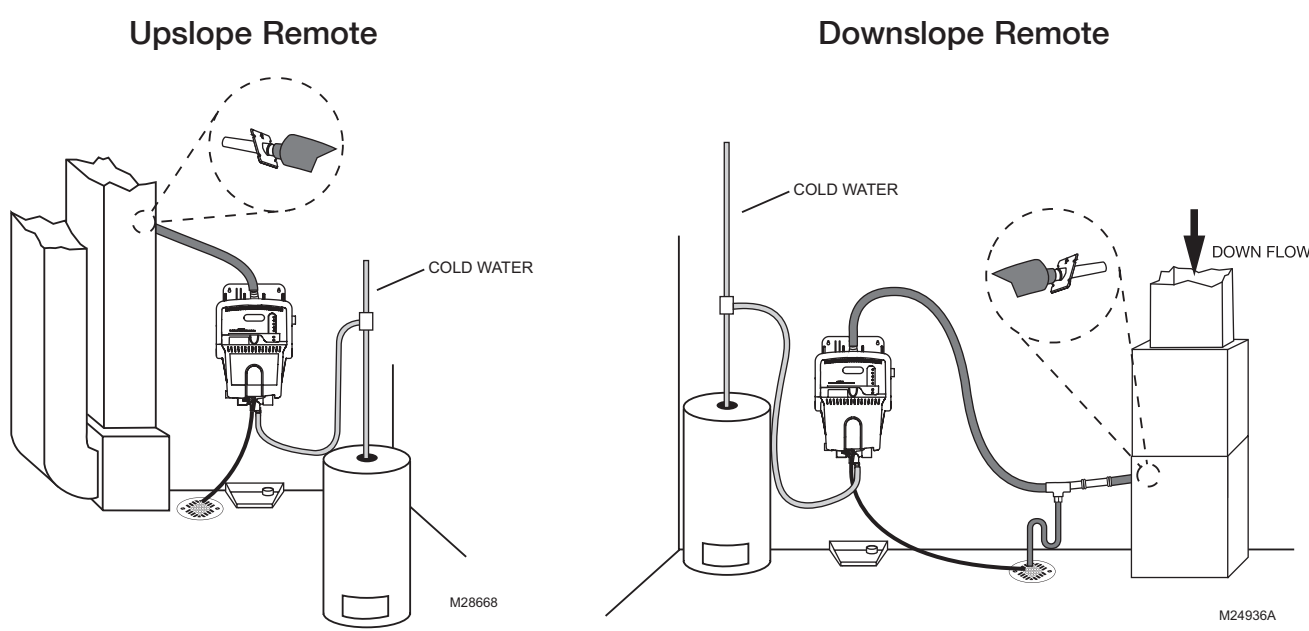

Living Area Remote Options

Garage Remote

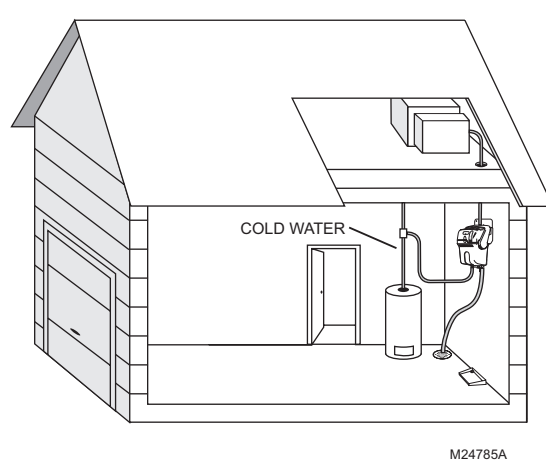
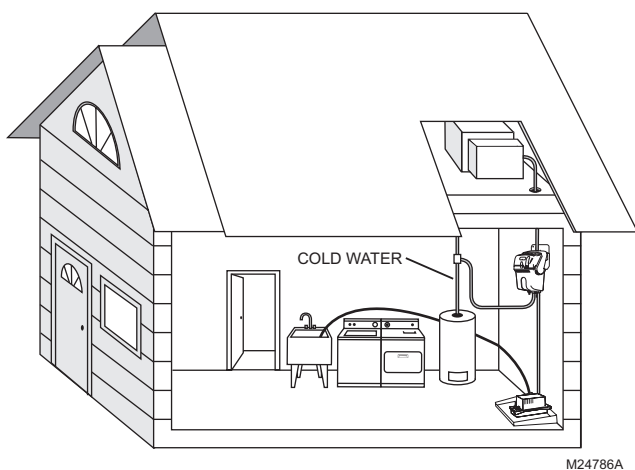

Automation and Control Solutions

Honeywell International Inc. Honeywell Limited-Honeywell Limitée
 1985 Douglas Drive North 35 Dynamic Drive
 Golden Valley, MN 55422 Toronto, Ontario M1V 4Z9
<http://yourhome.honeywell.com>



TrueSTEAM™ Remote Mount Kit

INSTALLATION INSTRUCTIONS



READ THIS BEFORE BEGINNING REMOTE INSTALLATION NON-COMPLIANCE WILL VOID WARRANTY

- ▶ HM506 maximum remote hose length is 10 ft. HM509 and HM512 maximum is 20 ft. For best performance, mount the humidifier as close as possible to the remote nozzle location.
- ▶ Horizontal installation **MUST** have upward pitch of at least **2 IN. PER FT.**
- ▶ Remote hose must be supported to prevent sags. Where there are long, straight runs, 1-1/2 in. x 2-1/4 in. perforated metal angle is recommended to provide continuous support under the hose. Other rigid materials, such as 2x4 lumber, may also be used to continuously support the hose.
- ▶ Never support the hose by attaching it to PVC pipe or other materials that may sag over time, or materials that cannot support the weight of the hose.
- ▶ Where it is not possible to provide continuous support, anchor the hose every 12 inches by securing it to a rigid support using the support hooks provided.
- ▶ Use the provided insulated hose to sustain output efficiency.
- ▶ Never make sharp bends in the steam hose, as this will cause kinks. Pay particular attention when routing the steam hose around rafters or joists and avoid sharp bends and kinks in these areas.
- ▶ Attach the remote humidifier nozzle so it directs the hose upward. Do not attempt to route the hose through the hole in the mounting bracket.
- ▶ Down sloping remote hose must have a drain with a wetted trap installed at the lowest point. Use a Tee that is rated for continuous use for steam. Do not use a plastic Tee and do not use more than one downward slope.
- ▶ ALWAYS inspect the hose installation after the humidifier has been operating for at least one hour to confirm that there are no sags or leaks. Note that the hose gets softer after it heats up so sags may develop after the initial installation.
- ▶ Install drain line according to the instructions on the next page.
- ▶ Install a drip pan with a wet switch under the humidifier when installed in finished spaces.

ADDITIONAL MATERIALS REQUIRED IF...

- ▶ Remote hose has a downward slope. You must use a 212°F rated Tee and P-trap.
- ▶ Do not use a plastic Tee.
- ▶ TrueSTEAM is using an auxiliary drain. You must install a wetted drain trap or condensate pump rated at 212°F. Pump must have total minimum capacity of 1 gallon per minute water flow for the vertical rise of the installation.
- ▶ TrueSTEAM is installed in a living space. You must install a drip pan with overflow wet switch under the TrueSTEAM. Wire switch to TrueSTEAM according to the wiring diagram in this document.

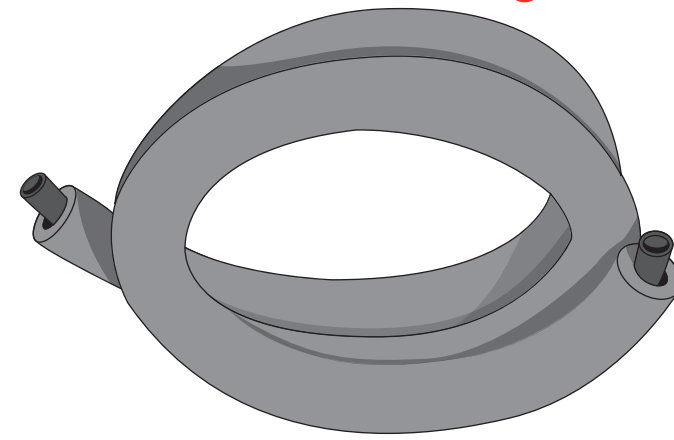
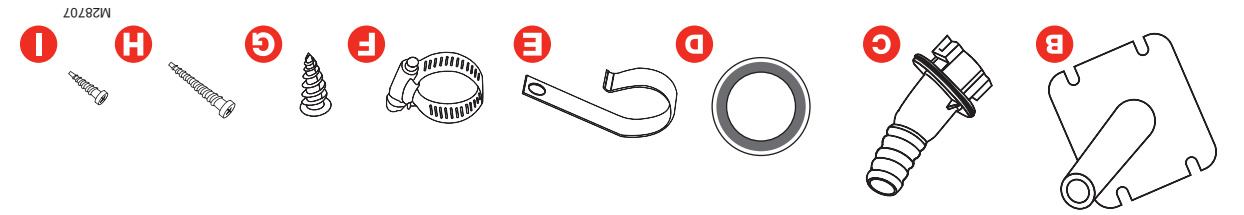

MATERIALS PROVIDED



1 MOUNTING

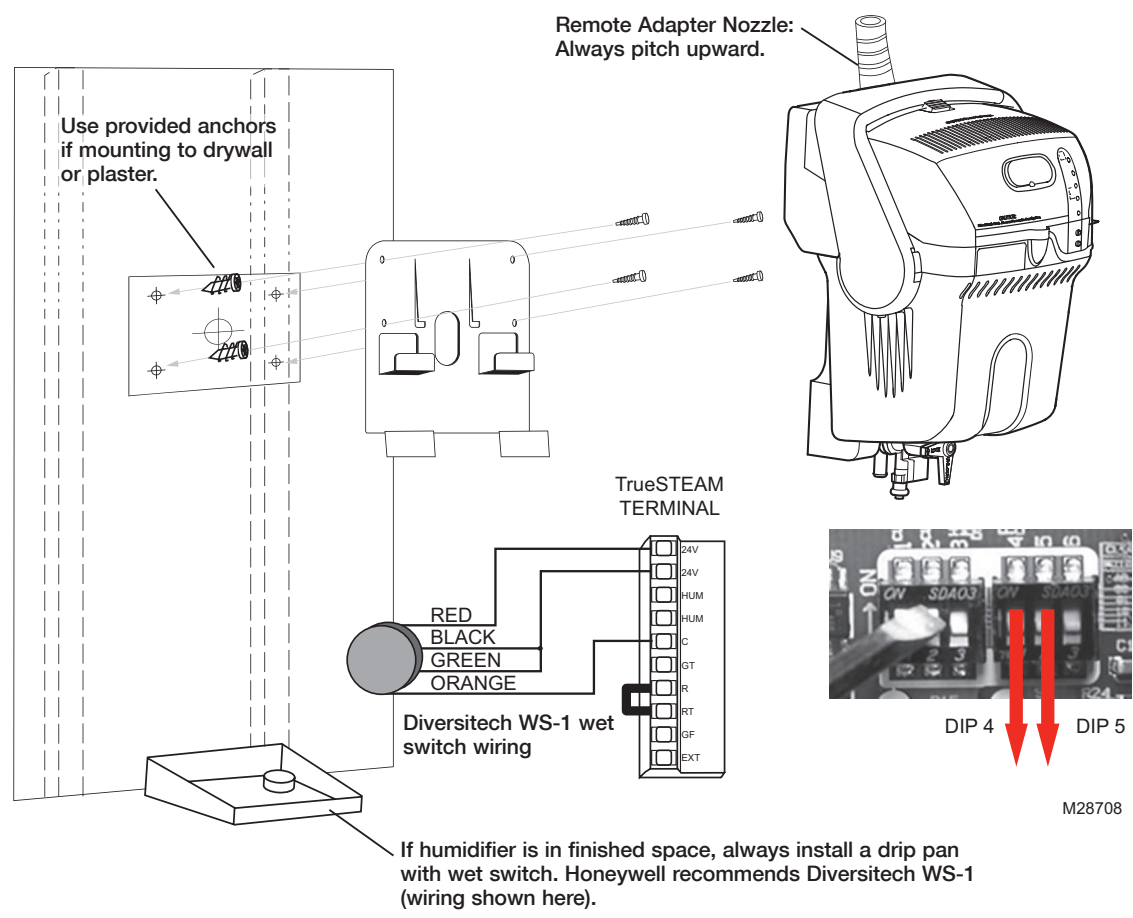

2 SECURE HOSE

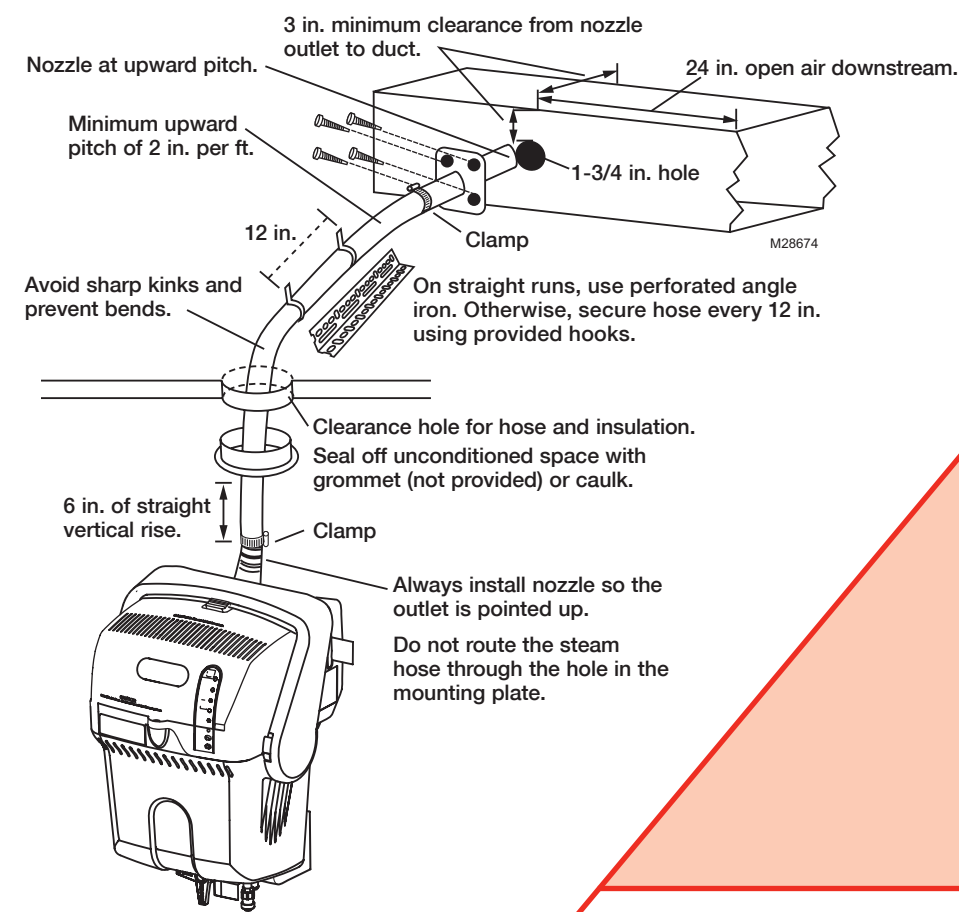
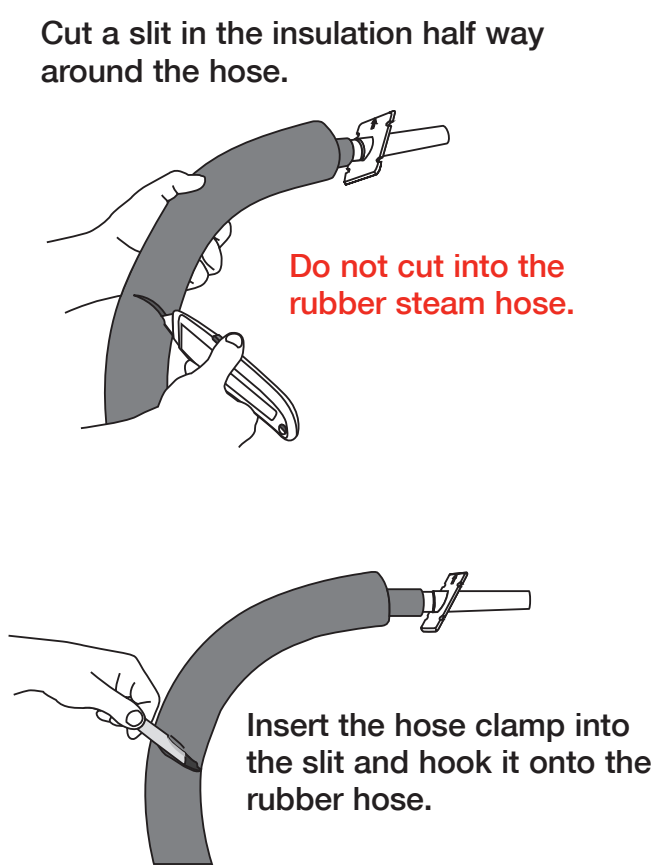

If hose slopes downhill...

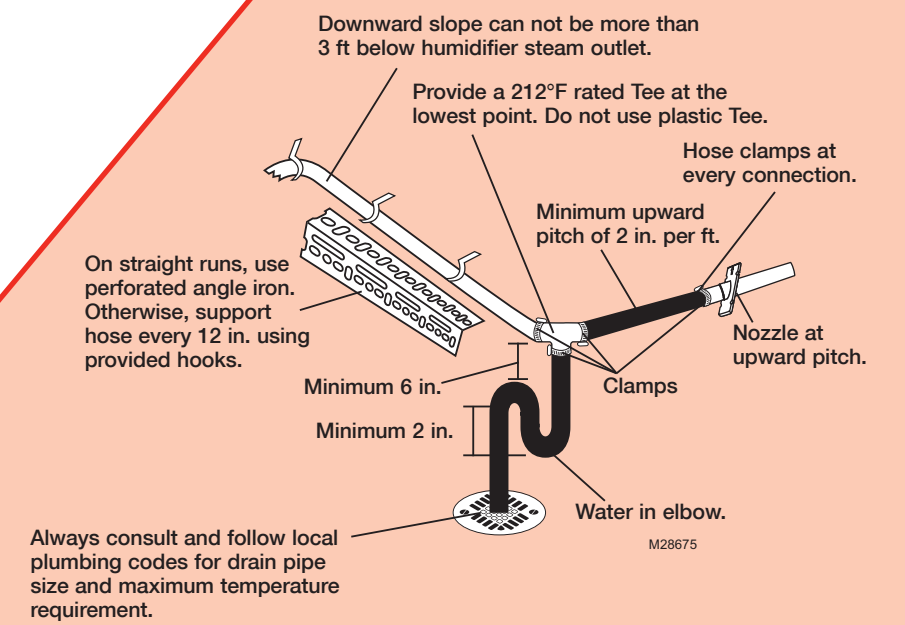

3A PLUMBING TO FLOOR DRAIN

Ideal for Installation

Draining water may be hot. Direct and secure the hose outlet into the floor drain to reduce risk of hot water pooling or splashing.

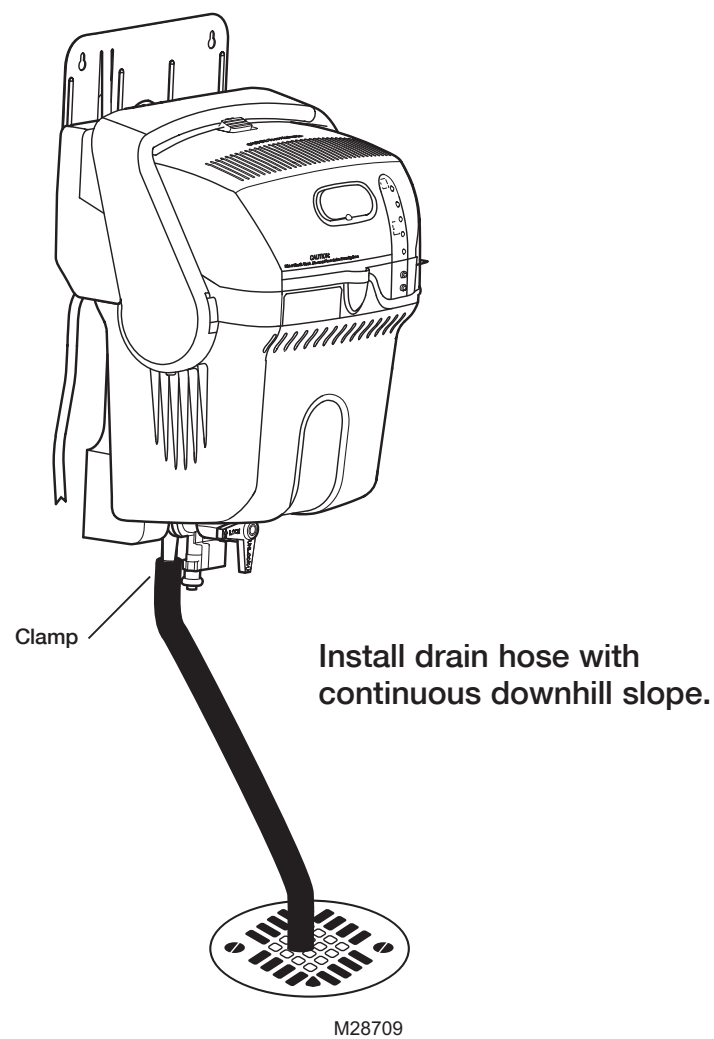

Consult and follow plumbing codes for drain pipe size and maximum temperature requirement.

3B OTHER PLUMBING OPTIONS

Choose the plumbing option that suits your installation. Use A, B, C, or D based on type of pipe or condensate pump. Consult and follow local plumbing codes in addition to these instructions.

Option 1: Plumbing to drain with condensate pump.

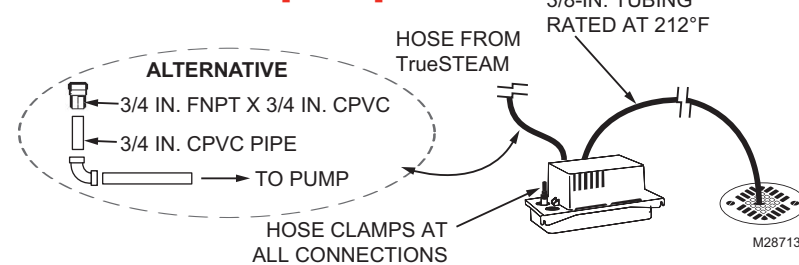

- Use Hartell A3X-115 condensate pump or equivalent (212°F temperature rating, > 1 GPM pump flow rate).
- Pump must be powered when TrueSTEAM is operating.
- Use a pump with a built-in overflow sensor or install the pump in a drip pan with wet switch wired to turn off TrueSTEAM.

Option 3: Plumbing to sink with a dedicated trap.

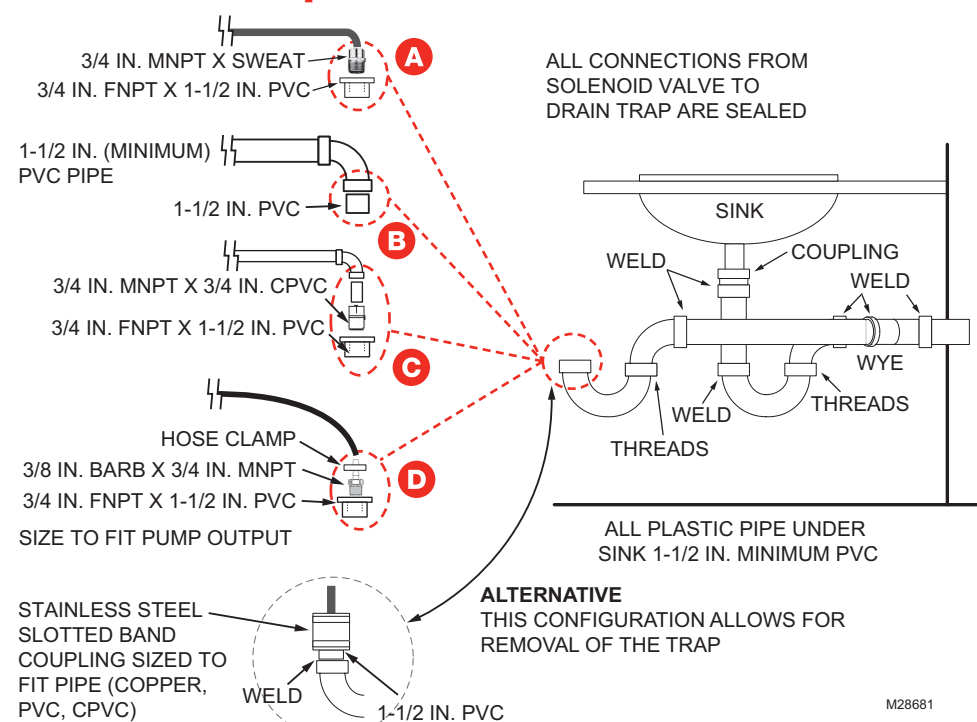

- FOR ALL OPTIONS SHOWN:**
- Support rubber hose every 6 in.
 - PVC must be schedule 40 or higher rating.
 - All plastic pipe joints are welded.
 - Drain into a P-trap that will remain wetted at all times.

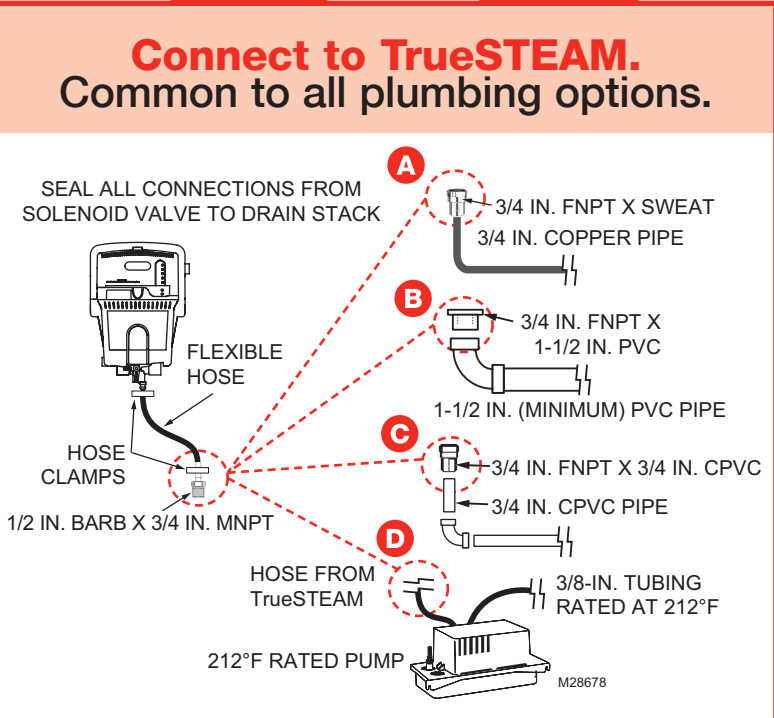

Option 2: Plumbing to a dedicated trap.

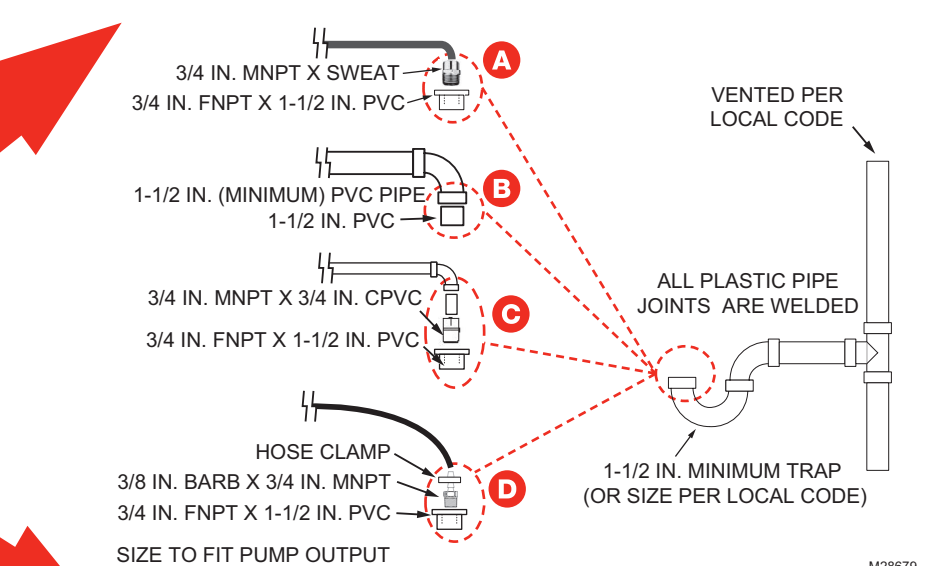

Option 4: Plumbing to sink trap.

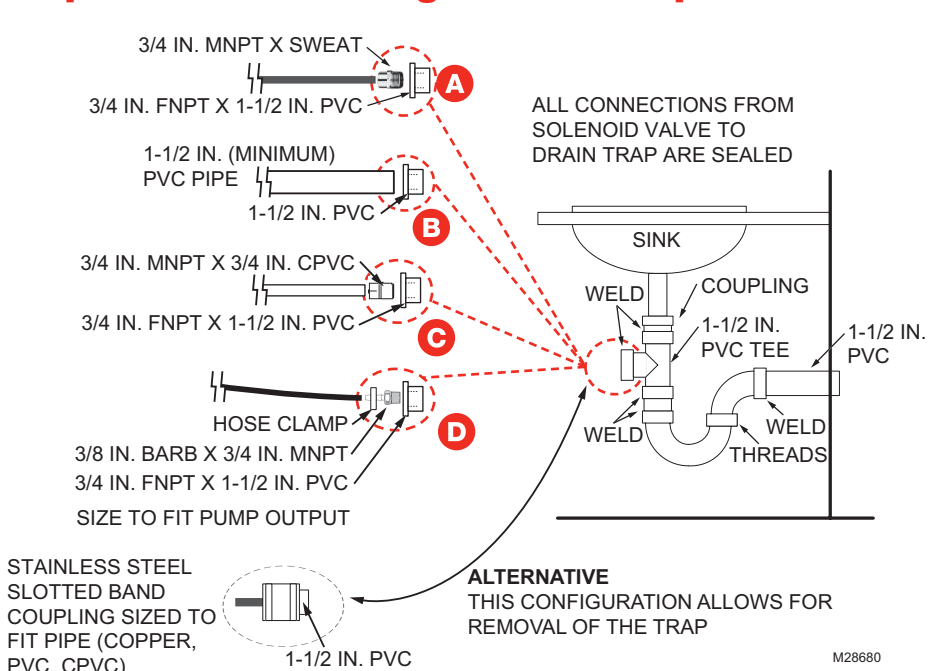

COMPLETING TRUESTEAM INSTALLATION

Refer to TrueSTEAM Installation Guide (# 69-2285) to complete wiring and checkout.