

Square Washer with Channel Guide Figs. AS 2504, AS 619, AS 601, AS 602, AS 620, AS 888

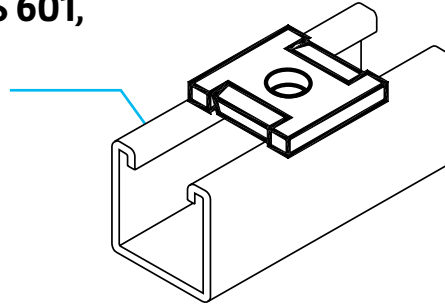

Description

Anvil-Strut Flat Plates are designed to fit with all Anvil-Strut 1⁵/₈" wide channels. Unless otherwise noted, Anvil-Strut Miscellaneous Fittings are manufactured from 1/4" thick carbon steel, 1⁵/₈" wide, all holes are 9/16" diameter, spaced 1⁷/₈" on center and 1³/₁₆" from the end.

Square Washer

AS 619 EG, GR, SS, ZTC

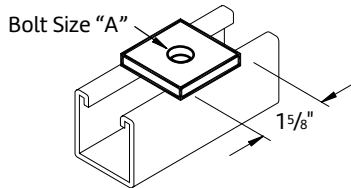

Square Washer with Channel Guide

AS 2504 EG, GR, ZTC

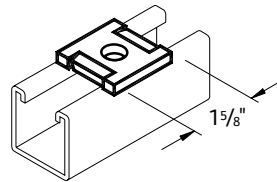

A	Wt./100 Pcs.
1/4"	18
3/8"	18
1/2"	17
5/8"	16
3/4"	15
7/8"	14

Rod Size	Hole Size	Wt./100 Pcs.
1/4"	5/16"	18
3/8"	7/16"	18
1/2"	9/16"	17

Std Pkg 100 – Wt/100 pcs: See chart above.

Std Pkg 100 – Wt/100 pcs: See chart above.

Page notes unless otherwise specified: 1/4" thick, 1⁵/₈" wide, holes 9/16" diameter, spaced 1⁷/₈" on center and 1³/₁₆" from end.

LEGEND:

GR: Powder Coated Supr-Green **EG:** Electro-Galvanized **PG:** Pre-Galvanized **AL:** Aluminum
HG: Hot Dipped Galvanized **PL:** Plain **SS:** Stainless Steel **ZTC:** Zinc Trivalent Chromium.
Stainless Steel (**SS**), Zinc Trivalent Chromium (**ZTC**) and Hot Dipped Galvanized (**HG**) are specialty finishes.
Pricing is located in the Specialty Strut Section of the Anvil-Strut price book.



PROJECT INFORMATION	APPROVAL STAMP
Project:	Approved
Address:	Approved as noted
Contractor:	Not approved
Engineer:	Remarks:
Submittal Date:	
Notes 1:	
Notes 2:	

Square Washer with Channel Guide Figs. AS 2504, AS 619, AS 601, AS 602, AS 620, AS 888

2-Hole Splice Plate

AS 601 EG, GR, ZTC

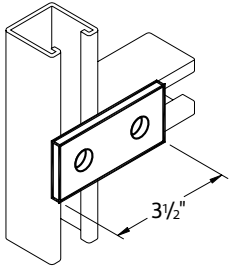

Std Pkg 50 - Wt/100 pcs: 37 Lbs.

2-Hole Connecting Plate

AS 620 EG, GR

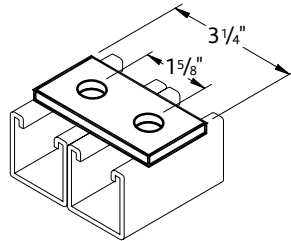

Std Pkg 50 - Wt/100 pcs: 34 Lbs.

3-Hole Splice Plate

AS 602 EG, GR, ZTC

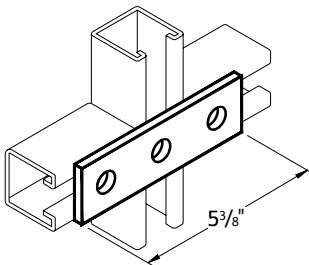

Std Pkg 25 - Wt/100 pcs: 57 Lbs.

4-Hole Splice Plate

AS 888 EG, GR, ZTC

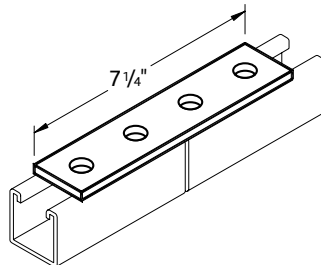

Std Pkg 25 - Wt/100 pcs: 76 Lbs.

LEGEND:

GR: Powder Coated Supr-Green EG: Electro-Galvanized PG: Pre-Galvanized AL: Aluminum
HG: Hot Dipped Galvanized PL: Plain SS: Stainless Steel ZTC: Zinc Trivalent Chromium.
Stainless Steel (SS), Zinc Trivalent Chromium (ZTC) and Hot Dipped Galvanized (HG) are specialty finishes.
Pricing is located in the Specialty Strut Section of the Anvil-Strut price book.