

Setting the Standard of Quality Since 1890



MARSHALLTOWN

The Premier Line

Catalog 117



MARSHALLTOWN
The Premier Line

The **MARSHALLTOWN** line is designed to meet the exacting needs and wearability expected by the professional tradesman



BY MARSHALLTOWN

The **QLT by MARSHALLTOWN** line has a wide assortment of well-made and dependable tools, ranging from value priced tools for the homeowner up to higher-grade, competitively priced tools aimed at the serious DIYer and general contractor.

MASONRY TOOLS 06-30

GILSON MIXERS 31-38

CONCRETE TOOLS 39-139

ASPHALT TOOLS 140-148

**DRYWALL, PLASTERING,
PAINT SUNDRY & WALLCOVERING TOOLS** 149-203

FLOORING & TILING TOOLS 204-227

EIFS TOOLS 228-234

MISCELLANEOUS ITEMS & DISPLAYS 235-252

INDEX 253-282

MARSHALLTOWN

proud sponsor of



A team of one mason and one tender compete to lay a double wythe, 26 foot wall in 60 minutes. The goal, to construct a finished, quality wall containing as many units as possible. Prior to this event is the Toughest Tender competition. Tenders compete to see who can accurately set up their work zones in the least amount of time.

MCAA Fastest Trowel on the Block



Each team consists of one mason and two tenders. They have 20 minutes to build as much of an 18 block long wall as possible

MCAA Skills Challenge



This competition consists of first, second and third year masonry apprentices. Each level is given a project appropriate to their know-how that they have not seen before.



Visit our booth at the Las Vegas Convention Center.



WORLD OF CONCRETE
WORLD OF MASONRY | TECHNOLOGY FOR CONSTRUCTION

Tools For Schools

from **MARSHALLTOWN**

A good education begins with the right tools and Marshalltown Company has the right tools for your vo-tech program. Marshalltown has implemented programs to aid instructors in getting the proper tools into the hands of their students. These programs are available to any instructors who use masonry, concrete, drywall/plastering, paint, tiling, or archaeology tools in their classrooms.

Student Award Program

This program was created to recognize outstanding students (secondary, post secondary or apprenticeships) for their exemplary work. Follow these three steps:

- Choose one student (per term) who has excelled in the masonry, plastering, drywall, concrete, paint or tile trades. This student should be actively training for a career in the trade.
- Fill out the Marshalltown Student Award form which asks for the student's name and desired trowel (including type, size and pattern, or part number, if known).
- Fax or mail this completed form and Marshalltown will send the following materials to your attention: a letter of commendation, certificate of merit, complimentary trowel, and Marshalltown hat.

Marshalltown Match Program

This program is designed for schools or training facilities buying Marshalltown tools from a local retailer. Marshalltown will match those dollars spent in free tools up to \$400.00 per year. Follow these two steps:

- Send Marshalltown a copy of the paid receipt from your local retailer with our part numbers and the cost clearly marked.
- Fax or email your hand tool request to us on your school's letterhead. For proper handling please mark your order Attn: Marketing – Tools for Schools.

Contact us for the full Tools for Schools information packet that has all your tool buying options.
You can reach us at 800-888-0127 or email education@marshalltown.com.

Marshalltown Sponsored Events

Among the many competitions that Marshalltown is involved with SkillsUSA is the largest. SkillsUSA is a national organization serving high school and college students who are preparing for a career in technical, skilled and service occupations. These young masons compete against the clock and themselves to demonstrate their level of expertise. The contest consists of a written test and the construction of a brick and block composite project. They have up to six hours to complete the project. Once finished they are judged on several criteria to determine the overall winner.



MARSHALLTOWN[®]

BRICK TROWELS

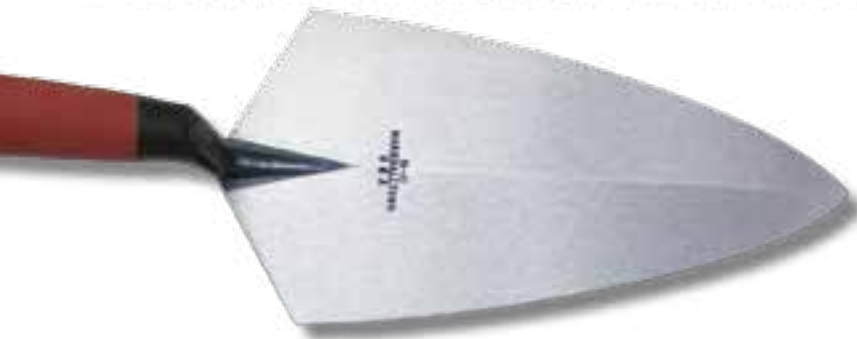

PHILADELPHIA PATTERN

Philadelphia pattern trowels are better suited for laying block because they allow for more mortar to be placed on the blade



LONDON PATTERN

London pattern trowels are the standard blade type for laying brick.



WIDE LONDON PATTERN

Wide London pattern trowels can be used for laying brick or block. The rounded heel places the mortar further forward on the blade than the Philadelphia style trowels.

When you purchase a MARSHALLTOWN[®] Brick Trowel There Are No Surprises

No other brick trowel manufacturer can match MARSHALLTOWN's commitment to providing consistent quality. It all starts with our steel; a proprietary formula developed for the unique requirements of a brick trowel. We take our steel and carefully forge and heat treat it into brick trowels by using state of the art equipment that we have developed and refined into a unique factory dedicated to making the best brick trowels in the world. Our handle rise is always set at precisely the same angle. We hold extremely tight tolerances on blade thickness to maintain consistent flexibility and strength on every trowel we sell. We precisely maintain blade chemistry and hardness to guarantee that your trowel will perform better than expected. This all means that every single MARSHALLTOWN brick trowel we make is great. Most manufacturers can make a few good brick trowels, and maybe even one or two great ones. But they also make bad trowels, and you have to suffer through those bad trowels to get the few good ones. Choosing a MARSHALLTOWN brick trowel means that you choose to get a great brick trowel every time, so there are no surprises.



PermaShape® London Style

- PermaShape® process guarantees no blade droop
- Forged from a single piece of high carbon steel, then heat treated for strength and durability
- Handle rise is set for the correct hang and balance
- Blade is taper ground and polished
- Impact area is extra strong
- Four handle styles to choose from
- Sold 2 per inner pack/12 per outer pack



MADE IN
U.S.A.

U.S. Patent Nos. for
PermaShape®
5,697,265 & 5,791,009;
U.K. Patent No. 2,335,942

Philadelphia Style

- Forged from a single piece of high carbon steel, then heat treated for strength and durability
- Blade is taper ground and polished
- Handle rise is set for the correct hang and balance
- Impact area is extra strong
- Four handle styles to choose from
- Sold 2 per inner pack/12 per outer pack, sold 2 per inner pack/2 per outer pack where noted with *



MADE IN
U.S.A.

DuraSoft® Handle
U.S. Patent Nos.
5,327,612 & 5,446,941

MARSHALLTOWN The Premier Line

| EDI | Part# | Size-in. | Size-mm | Handle |
|-------|---------|----------|-----------|--------|
| 10142 | 3312FGS | 12 X 5½ | 305 X 130 | |
| 10235 | 33P12S | 12 X 5½ | 305 X 130 | |
| 10736 | 33L12S | 12 X 5½ | 305 X 130 | |
| 10143 | 3313FGS | 13 X 5¾ | 330 X 137 | |
| 10141 | 3313S | 13 X 5¾ | 330 X 137 | |
| 10237 | 33P13S | 13 X 5¾ | 330 X 137 | |
| 10737 | 33L13S | 13 X 5¾ | 330 X 137 | |

MARSHALLTOWN The Premier Line

| EDI | Part# | Size-In. | Size-mm | Handle |
|-------|-----------|----------|-----------|--------|
| 10189 | 19 9.5FG | 9½ X 4¾ | 241 X 121 | |
| 10190 | 19 9.5 | 9½ X 4¾ | 241 X 121 | |
| 10730 | 19P9.5 | 9½ X 4¾ | 241 X 121 | |
| 10731 | 19 L9.5 | 9½ X 4¾ | 241 X 121 | |
| 10105 | 19 10FG | 10 X 5 | 254 X 127 | |
| 10106 | 19 10 | 10 X 5 | 254 X 127 | |
| 10206 | 19P10 | 10 X 5 | 254 X 127 | |
| 10306 | 19L10* | 10 X 5 | 254 X 127 | |
| 10118 | 1910.5FG | 10½ X 5¼ | 267 X 133 | |
| 10108 | 19 10.5 | 10½ X 5¼ | 267 X 133 | |
| 10208 | 19P10.5 | 10½ X 5¼ | 267 X 133 | |
| 10308 | 19L10.5* | 10½ X 5¼ | 267 X 133 | |
| 10109 | 19 11FG | 11 X 5½ | 279 X 140 | |
| 10110 | 19 11 | 11 X 5½ | 279 X 140 | |
| 10210 | 19P11 | 11 X 5½ | 279 X 140 | |
| 10310 | 19L11* | 11 X 5½ | 279 X 140 | |
| 10112 | 19 11.5 | 11½ X 5¾ | 292 X 146 | |
| 10733 | 19 11.5FG | 11½ X 5¾ | 292 X 146 | |
| 10212 | 19P11.5 | 11½ X 5¾ | 292 X 146 | |
| 10312 | 19L11.5* | 11½ X 5¾ | 292 X 146 | |
| 10116 | 19 12FG | 12 X 6 | 305 X 152 | |
| 10114 | 19 12 | 12 X 6 | 305 X 152 | |
| 10214 | 19P12 | 12 X 6 | 305 X 152 | |
| 10314 | 19L12* | 12 X 6 | 305 X 152 | |

Wide London Style

- Forged from a single piece of high carbon steel, then heat treated for strength and durability
- Blade is taper ground and polished
- Impact area is extra strong
- Handle rise is set for the correct hang and balance
- Four handle styles to choose from
- Sold 2 per inner pack/12 per outer pack, sold 2 per inner pack/2 per outer pack where noted with *



MADE IN
U.S.A.

DuraSoft® Handle
U.S. Patent Nos.
5,327,612 & 5,446,941

MARSHALLTOWN The Premier Line

| EDI | Part# | Size-in. | Size-mm | Handle |
|-------|----------|----------|-----------|--------|
| 10735 | 3410.5FG | 10½ X 5¾ | 267 X 146 | |
| 10148 | 3410.5 | 10½ X 5¾ | 267 X 146 | |
| 10248 | 34P10.5 | 10½ X 5¾ | 267 X 146 | |
| 10348 | 34L10.5* | 10½ X 5¾ | 267 X 146 | |
| 10152 | 3411FG | 11 X 5¾ | 279 X 146 | |
| 10150 | 34 11 | 11 X 5¾ | 279 X 146 | |
| 10250 | 34P11 | 11 X 5¾ | 279 X 146 | |
| 10350 | 34L11* | 11 X 5¾ | 279 X 146 | |
| 10153 | 3412FG | 12 X 5¾ | 305 X 146 | |
| 10154 | 34 12 | 12 X 5¾ | 305 X 146 | |
| 10254 | 34P12 | 12 X 5¾ | 305 X 146 | |
| 10354 | 34L12* | 12 X 5¾ | 305 X 146 | |



DuraSoft® Handle
U.S. Patent Nos.
5,327,612 & 5,446,941

London Style

- Forged from a single piece of high carbon steel, then heat treated for strength and durability
- Handle rise is set for the correct hang and balance
- Blade is taper ground and polished
- Impact area is stronger
- Four handle styles to choose from, options are shown in table
- Sold 2 per inner pack/12 per outer pack, sold 2 per outer pack where noted with*



MADE IN
U.S.A.
DuraSoft® Handle
U.S. Patent Nos.
5,327,612 & 5,446,941

MARSHALLTOWN The Premier Line

| EDI | Part# | Size-in. | Size-mm | Handle |
|-------|-----------|----------|-----------|--------|
| 10185 | 33 9FG | 9 X 4¼ | 229 X 108 | |
| 10186 | 33 9 | 9 X 4¼ | 229 X 108 | |
| 10362 | 33P9 | 9 X 4¼ | 229 X 108 | |
| 10171 | 33L9 | 9 X 4¼ | 229 X 108 | |
| 10187 | 33 9.5FG | 9½ X 4¾ | 241 X 111 | |
| 10188 | 33 9.5 | 9½ X 4¾ | 241 X 111 | |
| 10363 | 33P9.5 | 9½ X 4¾ | 241 X 111 | |
| 10173 | 33L9.5 | 9½ X 4¾ | 241 X 111 | |
| 10121 | 33 10FG | 10 X 4¾ | 254 X 118 | |
| 10126 | 33 10 | 10 X 4¾ | 254 X 118 | |
| 10226 | 33P10 | 10 X 4¾ | 254 X 118 | |
| 10326 | 33L10* | 10 X 4¾ | 254 X 118 | |
| 10122 | 33 10.5FG | 10½ X 4¾ | 267 X 121 | |
| 10128 | 33 10.5 | 10½ X 4¾ | 267 X 121 | |
| 10228 | 33P10.5 | 10½ X 4¾ | 267 X 121 | |
| 10328 | 33L10.5* | 10½ X 4¾ | 267 X 121 | |

MARSHALLTOWN The Premier Line

| EDI | Part# | Size-in. | Size-mm | Handle |
|-------|-----------|----------|-----------|--------|
| 10123 | 33 11FG | 11 X 4¾ | 279 X 124 | |
| 10130 | 33 11 | 11 X 4¾ | 279 X 124 | |
| 10230 | 33P11 | 11 X 4¾ | 279 X 124 | |
| 10330 | 33L11* | 11 X 4¾ | 279 X 124 | |
| 10124 | 33 11.5FG | 11½ X 5 | 292 X 127 | |
| 10132 | 33 11.5 | 11½ X 5 | 292 X 127 | |
| 10232 | 33P11.5 | 11½ X 5 | 292 X 127 | |
| 10332 | 33L11.5* | 11½ X 5 | 292 X 127 | |
| 10125 | 33 12FG | 12 X 5½ | 305 X 130 | |
| 10134 | 33 12 | 12 X 5½ | 305 X 130 | |
| 10234 | 33P12 | 12 X 5½ | 305 X 130 | |
| 10334 | 33L12* | 12 X 5½ | 305 X 130 | |
| 10138 | 33 13FG | 13 X 5¾ | 330 X 137 | |
| 10136 | 33 13 | 13 X 5¾ | 330 X 137 | |
| 10236 | 33P13 | 13 X 5¾ | 330 X 137 | |
| 10336 | 33L13* | 13 X 5¾ | 330 X 137 | |

Brick Trowel Handles

- Will fit all of our **MARSHALLTOWN** brick trowels
- Sold 1 per inner pack/12 per outer pack

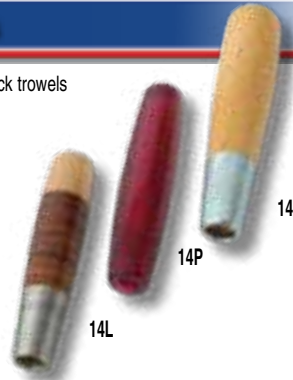

MARSHALLTOWN The Premier Line

| EDI | Part# | Description | Dia.-in. | Dia.-mm |
|-------|-------|-------------|----------|---------|
| 19106 | 14 | Wood | 1¼ | 31 |
| 19108 | 14P | Plastic | 1½ | 38 |
| 19107 | 14L | Leather | 1½ | 32 |

Trowel Handle Bumper

- Replacement bumper for DuraSoft® brick trowel handles
- Sold 1 per inner pack/1 per outer pack



MARSHALLTOWN The Premier Line

| EDI | Part# | Size-in. | Size-mm |
|-------|-------|----------|---------|
| 19104 | 19104 | N/A | N/A |

Ceremonial Trowel

- Excellent for retirement gifts, award presentations or ground breaking ceremonies
- Laser etched graphics on carbon steel blade, clear powder coated for rust protection
- Sold 1 per inner pack/ 1 per outer pack

DuraSoft® Handle
U.S. Patent Nos.
5,327,612 & 5,446,941



MADE IN
U.S.A.

MARSHALLTOWN The Premier Line

| EDI | Part# | Size-in. | Size-mm |
|-------|-------|----------------------|-----------|
| 16031 | 16031 | 10 X 4 $\frac{5}{8}$ | 254 X 118 |

London & Wide London Style

- Durable construction
- Perfect for projects of any size
- Designed for repeated use but priced for the Do-It-Yourselfer
- Soft grip handle for increased comfort
- Sold 6 per inner pack/6 per outer pack

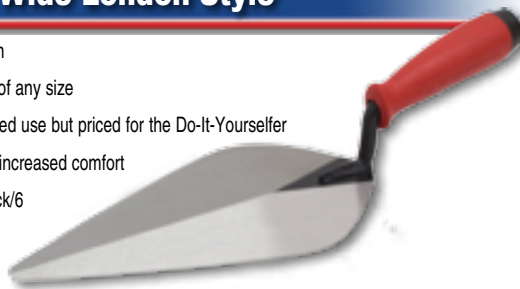

QLT^{BY}MARSHALLTOWN

| EDI | Part# | Style | Size-in. | Size-mm |
|-------|----------|-------------|----------------------|-----------|
| 10752 | BTSG11 | London | 11 X 4 $\frac{3}{4}$ | 279 X 121 |
| 18588 | BTSG1155 | Wide London | 11 X 5 $\frac{1}{2}$ | 279 X 140 |
| 18586 | BTSG12 | London | 12 X 5 | 305 X 127 |

London Style

- Durable construction
- Designed for repeated use but priced for the Do-It-Yourselfer
- Perfect for projects of any size
- Plastic no slip grip handle
- Sold 6 per inner pack/60 per outer pack



QLT^{BY}MARSHALLTOWN

| EDI | Part# | Size-in. | Size-mm |
|-------|-------|----------------------|-----------|
| 10746 | BTP10 | 10 X 4 $\frac{3}{4}$ | 254 X 121 |

Philadelphia Style

- Blade is tempered, ground and polished
- Hardwood handle
- Philadelphia pattern allows more mortar to be placed on the blade
- Sold 6 per inner pack/60 per outer pack



QLT^{BY}MARSHALLTOWN

| EDI | Part# | Size-in. | Size-mm |
|-------|-------|----------|-----------|
| 16196 | 96 | 10 X 5 | 254 X 127 |

London Style

- Blade is tempered, ground and polished
- Hardwood handle
- London pattern trowels are designed for laying brick
- Rounded heel shapes the blade so that the mortar is carried a little further forward on the blade
- Sold 6 per inner pack/60 per outer pack



QLT^{BY}MARSHALLTOWN

| EDI | Part# | Size-in. | Size-mm |
|-------|-------|----------------------|-----------|
| 16126 | 926 | 10 X 4 $\frac{3}{4}$ | 254 X 121 |

Philadelphia Style

- Durable construction
- Perfect for projects of any size
- Designed for repeated use but priced for the Do-It-Yourselfer
- Soft grip handle for increased comfort
- Sold 1 per inner pack/12 per outer pack

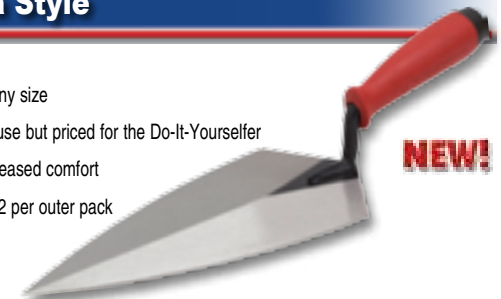

QLT^{BY}MARSHALLTOWN

| EDI | Part# | Size-in. | Size-mm |
|-------|--------|----------|-----------|
| 18587 | BTSG10 | 10 X 5 | 254 X 127 |

Left & Right Handed Bucket Trowels

- Forged from a single piece of high carbon steel
- Available for right or left handed use
- Sold 6 per inner pack/6 per outer pack



MARSHALLTOWN The Premier Line

| EDI | Part# | Description | Size-in. | Size-mm |
|-------|----------|--------------|-----------------|---------|
| 10102 | 19 7.5 | Right Angled | 7 $\frac{1}{2}$ | 191 |
| 10104 | 19 8.25 | Right Angled | 8 $\frac{1}{4}$ | 210 |
| 10823 | 19 7.5L | Left Angled | 7 $\frac{1}{2}$ | 191 |
| 10824 | 19 8.25L | Left Angled | 8 $\frac{1}{4}$ | 210 |

MADE IN
U.S.A.

Bucket Trowels

- Durable construction
- Designed for repeated use but priced for the Do-It-Yourselfer
- Soft grip handle for increased comfort
- BKTSG75SS is made of stainless steel
- Sold 1 per inner pack/12 per outer pack, sold 1 per inner pack/6 per outer pack where noted with *



QLT BY MARSHALLTOWN

| EDI | Part# | Description | Size-in. | Size-mm |
|-------|-----------|-----------------|----------|---------|
| 18738 | BKTSG75SS | Stainless Steel | 7½ | 191 |
| 18736 | BKTSG75* | Carbon Steel | 7½ | 191 |
| 18737 | BKTSG825* | Carbon Steel | 8¼ | 210 |

Pointing Trowels

- Durable construction
- Perfect for projects of any size
- Designed for repeated use but priced for the Do-It-Yourselfer
- Soft grip handle for increased comfort
- **New items indicated in red**
- Sold 6 per inner pack/6 per outer pack, sold 1 per inner pack/6 per outer pack where noted with *



QLT BY MARSHALLTOWN

| EDI | Part# | Size-in. | Size-mm |
|-------|------------------|----------|----------|
| 10744 | PTSG525 | 5 X 2½ | 127 X 64 |
| 18633 | PTSG6275* | 6 X 2¾ | 152 X 70 |
| 18634 | PTSG73* | 7 X 3 | 178 X 76 |

Philadelphia Style Pointing Trowels

- Forged from a single piece of high carbon steel for unsurpassed strength
- Choice of resilient DuraSoft® handle with integral finger guard or hardwood handle with metal ferrule
- Extra flexible blade indicated in table with *
- Sold 6 per inner pack/6 per outer pack



MARSHALLTOWN The Premier Line

| EDI | Part# | Size-in. | Size-mm | Handle |
|-------|---------|----------|----------|--------|
| 11119 | 45 4.5D | 4½ X 2¼ | 114 X 57 | |
| 11122 | 45 4.5 | 4½ X 2¼ | 114 X 57 | |
| 11125 | 45 5D | 5 X 2½ | 127 X 64 | |
| 11124 | 45 5 | 5 X 2½ | 127 X 64 | |
| 11133 | 45 6A* | 6 X 2¾ | 152 X 70 | |
| 11127 | 45 6D | 6 X 2¾ | 152 X 70 | |
| 11128 | 45 6 | 6 X 2¾ | 152 X 70 | |
| 11131 | 45 7D | 7 X 3 | 178 X 76 | |
| 11130 | 45 7 | 7 X 3 | 178 X 76 | |

Pointing Trowel

- Durable construction
- Perfect for projects of any size
- Designed for repeated use but priced for the Do-It-Yourselfer
- Plastic no slip grip handle
- Sold 12 per inner pack/120 per outer pack



QLT BY MARSHALLTOWN

| EDI | Part# | Size-in. | Size-mm |
|-------|--------|----------|----------|
| 10743 | PTP525 | 5 X 2½ | 127 X 64 |
| 10745 | PTP73 | 7 X 3 | 178 X 76 |

London Style Pointing Trowels

- Forged from a single piece of high carbon steel for unsurpassed strength
- Resilient DuraSoft® handle provides a soft feel, reduces fatigue and offers excellent durability
- Integral finger guard protects against calluses, heat and cold
- Sold 6 per inner pack/6 per outer pack



MARSHALLTOWN The Premier Line

| EDI | Part# | Size-in. | Size-mm | Handle |
|-------|---------|----------|----------|--------|
| 11113 | 46 114D | 4 X 2 | 102 X 51 | |
| 11117 | 46 115D | 5 X 2¼ | 127 X 57 | |
| 11118 | 46 116D | 6 X 2½ | 152 X 64 | |

Pointing Trowels

- Tempered blade is fully ground and polished
- Hardwood handle
- Sold 12 per inner pack/120 per outer pack



QLT BY MARSHALLTOWN

| EDI | Part# | Size-in. | Size-mm |
|-------|-------|----------|----------|
| 16195 | 95 | 5½ X 2¾ | 140 X 70 |
| 16125 | 925 | 7 X 3 | 178 X 76 |

Pointing Trowel

- Durable plastic construction
- Won't rust or corrode
- Sold 24 per inner pack/24 per outer pack



MADE IN
U.S.A.

QLT BY MARSHALLTOWN

| EDI | Part# | Size-in. | Size-mm |
|-------|--------|-----------|----------|
| 16282 | PPT282 | 6 X 3 3/8 | 152 X 79 |

Margin Trowels

- Forged from a single piece of high carbon steel
- Tempered, ground and polished from toe to heel
- Choice of resilient DuraSoft® handle with integral finger guard or hardwood handle with metal ferrule
- Sold 6 per inner pack/6 per outer pack



MADE IN
U.S.A.

U.S. Patent Nos.
5,327,612 & 5,446,941

MARSHALLTOWN The Premier Line

| EDI | Part# | Size-in. | Size-mm | Handle |
|-------|-------|-----------|----------|--------|
| 11198 | 52D | 5 X 2 | 127 X 51 | |
| 11202 | 52 | 5 X 2 | 127 X 51 | |
| 11205 | 54D | 5 X 1 1/2 | 127 X 38 | |
| 11204 | 54 | 5 X 1 1/2 | 127 X 38 | |
| 11207 | 56D | 6 X 2 | 152 X 51 | |
| 11206 | 56 | 6 X 2 | 152 X 51 | |
| 11209 | 58D | 8 X 2 | 203 X 51 | |
| 11208 | 58 | 8 X 2 | 203 X 51 | |

Margin Trowels

- Durable construction
- Perfect for projects of any size
- Designed for repeated use but priced for the Do-It-Yourselfer
- Soft grip handle for increased comfort
- MTSG52SS is made of stainless steel
- **New items indicated in red**
- Sold 6 per inner pack/6 per outer pack, sold 1 per inner pack/6 per outer pack where noted with *

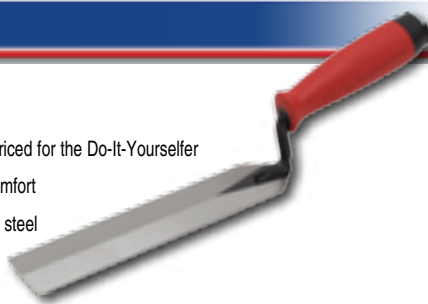

QLT BY MARSHALLTOWN

| EDI | Part# | Description | Size-in. | Size-mm |
|-------|-----------|-----------------|-----------|----------|
| 18632 | MTSG52SS* | Stainless Steel | 5 X 2 | 127 X 51 |
| 18630 | MTSG515* | Carbon Steel | 5 X 1 1/2 | 127 X 38 |
| 10739 | MTSG52 | Carbon Steel | 5 X 2 | 127 X 51 |
| 10740 | MTSG62 | Carbon Steel | 6 X 2 | 152 X 51 |
| 18631 | MTSG82* | Carbon Steel | 8 X 2 | 203 X 51 |

Margin Trowel

- Durable construction
- Perfect for projects of any size
- Designed for repeated use but priced for the Do-It-Yourselfer
- Plastic no slip grip handle
- Sold 12 per inner pack/120 per outer pack



QLT BY MARSHALLTOWN

| EDI | Part# | Size-in. | Size-mm |
|-------|-------|----------|----------|
| 10738 | MTP52 | 5 X 2 | 127 X 51 |

Margin Trowels

- Tempered steel blade is fully ground and polished
- Hardwood handle
- Sold 12 per inner pack/120 per outer pack



QLT BY MARSHALLTOWN

| EDI | Part# | Size-in. | Size-mm |
|-------|-------|-----------|----------|
| 16197 | 97 | 5 X 2 | 127 X 51 |
| 16200 | 934 | 5 X 1 1/2 | 127 X 38 |

Margin Trowel

- Hard temper steel blade
- Durable contoured plastic handle
- Sold 12 per inner pack/120 per outer pack



QLT BY MARSHALLTOWN

| EDI | Part# | Size-in. | Size-mm |
|-------|-------|----------|----------|
| 16233 | 202 | 5 X 2 | 127 X 51 |

Margin Trowel

- Durable plastic construction
- Won't rust or corrode
- Sold 12 per inner pack/12 per outer pack

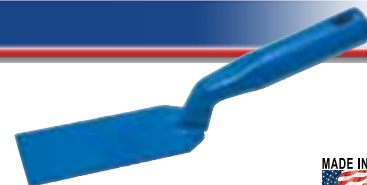

MADE IN
U.S.A.

QLT BY MARSHALLTOWN

| EDI | Part# | Size-in. | Size-mm |
|-------|--------|----------|----------|
| 16280 | PMT280 | 5 X 2 | 127 X 51 |

Archaeology Trowels

- Forged from a single piece of highest grade tool steel; good for cutting compacted sediment and compressed soils
- Heavy duty trowels have a thicker blade that withstands the intense pressures of scraping and cutting
- Tempered, ground and polished
- Hardwood handle with metal ferrule
- Holster has rugged construction and long-wearing protective insert, riveted belt loop for secure and easy portability
- Standard archaeology trowels sold 1 per inner pack/1 per outer pack
- Heavy duty archaeology trowels sold 6 per inner pack/6 per outer pack, sold 1 per inner pack/6 per outer pack where noted with *

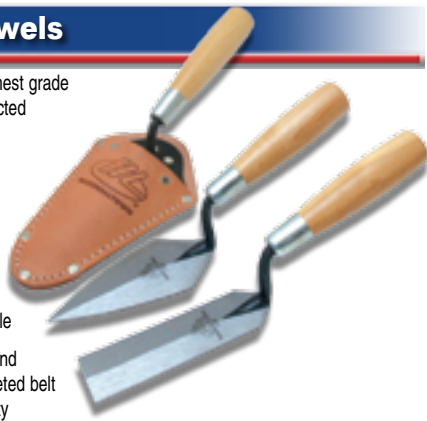

MARSHALLTOWN The Premier Line

| EDI | Part# | Description | Size-in. | Size-mm |
|-------|-------|---------------------------|----------|----------|
| 11121 | ATH45 | Pointing Trowel w/Holster | 4½ X 2¼ | 115 X 57 |
| 11123 | ATH50 | Pointing Trowel w/Holster | 5 X 2½ | 127 X 64 |
| 11203 | ATH54 | Margin Trowel w/Holster | 5 X 1½ | 127 X 38 |
| 11163 | ATH63 | Leather Holster | N/A | N/A |

Heavy Duty Archaeology Trowels

| EDI | Part# | Description | Size-in. | Size-mm |
|-------|----------|-----------------------------------|----------|----------|
| 16942 | ATH114S* | London Pointing Trowel w/ Holster | 4 X 2 | 102 X 51 |
| 16940 | ATH45S* | Pointing Trowel w/ Holster | 4½ X 2¼ | 114 X 57 |
| 16941 | ATH50S* | Pointing Trowel w/ Holster | 5 X 2½ | 127 X 64 |
| 16943 | ATH54S* | Margin Trowel w/ Holster | 5 X 1½ | 127 X 38 |
| 16946 | 46 114S | London Pointing Trowel-Wood | 4 X 2 | 102 X 51 |
| 16944 | 45 4.5S | Pointing Trowel - Wood | 4½ X 2¼ | 114 X 57 |
| 16945 | 45 5S | Pointing Trowel-Wood | 5 X 2½ | 127 X 64 |
| 16947 | 54S | Margin Trowel-Wood | 5 X 1½ | 127 X 38 |
| 16950 | 46 114SD | London Pointing Trowel-DuraSoft® | 4 X 2 | 102 X 51 |
| 16948 | 45 4.5SD | Pointing Trowel-DuraSoft® | 4½ X 2¼ | 114 X 57 |
| 16949 | 45 5SD | Pointing Trowel-DuraSoft® | 5 X 2½ | 127 X 64 |
| 16951 | 54SD | Margin Trowel-DuraSoft® | 5 X 1½ | 127 X 38 |

Gauging Trowels

- Forged from a single piece of high carbon steel
- Carefully taper ground and polished
- Many uses, including mixing or "gauging" small quantities of mortar or quick setting plaster
- Choice of resilient DuraSoft® handle with integral finger guard or hardwood handle with metal ferrule
- Sold 12 per inner pack/12 per outer pack



U.S. Patent Nos. 5,327,612 & 5,446,941

MARSHALLTOWN The Premier Line

| EDI | Part# | Size-in. | Size-mm | Handle |
|-------|-------|----------|----------|--------|
| 10749 | 48D | 7X 3¾ | 178 X 86 | |
| 10748 | 48 | 7X 3¾ | 178 X 86 | |

Gauging Trowel

- Durable construction
- Perfect for projects of any size
- Designed for repeated use but priced for the Do-It-Yourselfer
- Soft grip handle for increased comfort
- Sold 1 per inner pack/6 per outer pack



QLT[™] MARSHALLTOWN

| EDI | Part# | Size-in. | Size-mm |
|-------|--------|----------|----------|
| 18635 | GTSG35 | 7X 3¾ | 178 X 86 |

Gauging Trowel

- Durable construction
- Perfect for projects of any size
- Designed for repeated use but priced for the Do-It-Yourselfer
- Plastic no slip grip handle
- Sold 6 per inner pack/60 per outer pack



QLT[™] MARSHALLTOWN

| EDI | Part# | Size-in. | Size-mm |
|-------|-------|----------|----------|
| 10742 | GTP7 | 7X 3¾ | 178 X 86 |

Gauging Trowel

- Tempered blade; fully ground and polished
- Hardwood handle
- Many uses, including mixing or "gauging" small quantities of mortar or quick setting plaster
- Sold 6 per inner pack/60 per outer pack



QLT[™] MARSHALLTOWN

| EDI | Part# | Size-in. | Size-mm |
|-------|-------|----------|----------|
| 16124 | 924 | 7X 3¾ | 178 X 86 |

Coke Trowels

- Forged from a single piece of the highest grade tool steel
- Tempered, ground and polished
- Hardwood handle with metal ferrule
- Sold 6 per inner pack/6 per outer pack

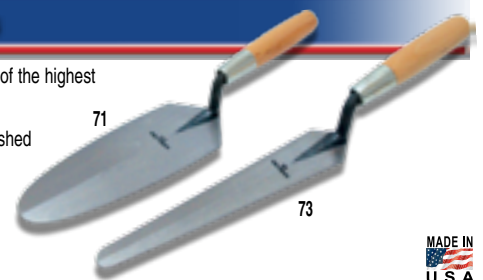

MARSHALLTOWN The Premier Line

| EDI | Part# | Size-in. | Size-mm |
|-------|-------|----------|----------|
| 10671 | 71 | 9½ X 3¾ | 242 X 95 |
| 10673 | 73 | 10 X 2 | 254 X 51 |

Insulator's Trowels

- Forged from a single piece of the highest grade tool steel
- Tempered, ground and polished
- Hardwood handle with metal ferrule
- Flexible blade is ideal for working with insulation
- Sold 12 per inner pack/12 per outer pack

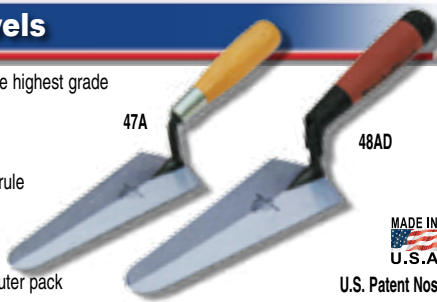

MADE IN
U.S.A

U.S. Patent Nos.
5,327,612 & 5,446,941

MARSHALLTOWN The Premier Line

| EDI | Part# | Size-in. | Size-mm | Handle |
|-------|-------|----------|----------|--------|
| 11102 | 47A | 5½ X 17½ | 140 X 48 | |
| 10750 | 48A | 7 X 3¾ | 178 X 86 | |
| 10751 | 48AD | 7 X 3¾ | 178 X 86 | |

Adjustable Aluminum Hawk

- Unique adjustable handle allows for more forearm support
- Oversized hard-rolled aluminum blade for increased capacity
- Edges have been smoothed and corners rounded
- Handle and sponge callus preventer included
- Sold 1 per inner pack/12 per outer pack



MADE IN
U.S.A

U.S. Patent No. 554,966

MARSHALLTOWN The Premier Line

| EDI | Part# | Size-in. | Size-mm |
|-------|--------|-----------|-----------|
| 15212 | AH212D | 15¾ X 19½ | 400 X 500 |

Magnesium Hawks

- Made of lightweight durable magnesium
- Score marks are machined to a uniform depth and specially shaped to help the blade remain flat
- Callus preventer and handle included
- "W" indicates wood, "D" indicates DuraSoft® handle
- Sold 1 per inner pack/12 per outer pack, sold 1 per inner pack/18 per outer pack where noted with *

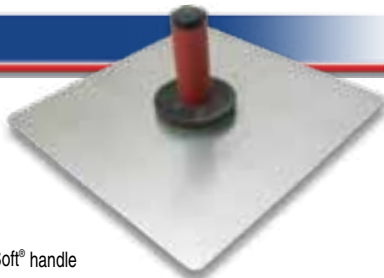

MADE IN
U.S.A

MARSHALLTOWN The Premier Line

| EDI | Part# | Size-in. | Size-mm | Handle |
|-------|--------|-----------|-----------|--------|
| 13808 | 5205W* | 8 X 8 | 203 X 203 | |
| 13809 | 5205D* | 8 X 8 | 203 X 203 | |
| 15207 | 5207W* | 10 X 10 | 254 X 254 | |
| 15220 | 5207D* | 10 X 10 | 254 X 254 | |
| 13814 | 5209W | 12 X 12 | 305 X 305 | |
| 13815 | 5209D | 12 X 12 | 305 X 305 | |
| 15209 | 5206W | 13 X 13 | 330 X 330 | |
| 15219 | 5206D | 13 X 13 | 330 X 330 | |
| 13816 | 5210W | 13½ X 13½ | 343 X 343 | |
| 13821 | 5210D | 13½ X 13½ | 343 X 343 | |
| 15208 | 5208W | 14 X 14 | 356 X 356 | |
| 15221 | 5208D | 14 X 14 | 356 X 356 | |
| 13825 | 5211W | 16 X 16 | 406 X 406 | |
| 13826 | 5211D | 16 X 16 | 406 X 406 | |

Aluminum Hawks

- Made of heavy gauge, hard-rolled aluminum
- Edges have been smoothed and the corners rounded
- Callus preventer and handle included
- "W" indicates wood, "D" indicates DuraSoft® handle
- Sold 1 per inner pack/12 per outer pack, 18 per outer pack where noted with *



MADE IN
U.S.A

MARSHALLTOWN The Premier Line

| EDI | Part# | Size-in. | Size-mm | Handle |
|-------|-------|-----------|-----------|--------|
| 13833 | 8W* | 8 X 8 | 203 X 203 | |
| 13835 | 8D* | 8 X 8 | 203 X 203 | |
| 13850 | 7W* | 9 X 9 | 229 X 229 | |
| 13851 | 7D* | 9 X 9 | 229 X 229 | |
| 15203 | 3W* | 10 X 10 | 254 X 254 | |
| 15217 | 3D* | 10 X 10 | 254 X 254 | |
| 15205 | 5W | 12 X 12 | 305 X 305 | |
| 15218 | 5D | 12 X 12 | 305 X 305 | |
| 15200 | 1W | 13 X 13 | 330 X 330 | |
| 15215 | 1D | 13 X 13 | 330 X 330 | |
| 15202 | 2W | 13½ X 13½ | 343 X 343 | |
| 15216 | 2D | 13½ X 13½ | 343 X 343 | |
| 13853 | 6W | 14 X 14 | 356 X 356 | |
| 14400 | 6D | 14 X 14 | 356 X 356 | |

Composite Hawk

- Made of unique composite material
- Won't warp or react with caustic materials
- DuraSoft® handle and sponge rubber callus preventer
- Sold 1 per inner pack/12 per outer pack



MADE IN
U.S.A

MARSHALLTOWN The Premier Line

| EDI | Part# | Size-in. | Size-mm |
|-------|-------|----------|-----------|
| 15222 | 2166D | 12 X 12 | 305 X 305 |

Aluminum Hawk

- Made of heavy gauge, hard-rolled aluminum
- Lightweight but durable
- Smoothed edges and rounded corners
- Has a threaded 3⅝" (92mm) flange
- Wood handle and sponge callus preventer included
- Sold 6 per inner pack/24 per outer pack



QLT[™] MARSHALLTOWN

| EDI | Part# | Size-in. | Size-mm |
|-------|-------|----------|-----------|
| 14659 | AH659 | 13 X 13 | 330 X 330 |

Tuck Pointers

- Forged from one piece of high carbon steel
- Tapered for the required sturdiness and correct flexibility
- High shank and high lift give plenty of hand room
- Choice of resilient DuraSoft® handle with integral finger guard or hardwood handle with metal ferrule
- Sold 6 per inner pack/6 per outer pack

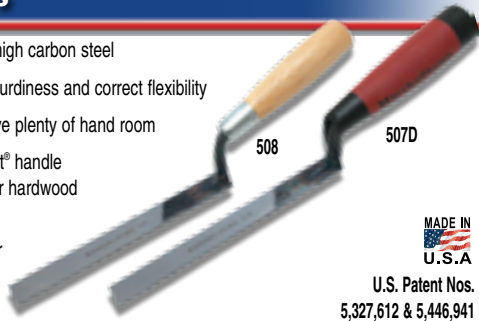

MADE IN
U.S.A.
U.S. Patent Nos.
5,327,612 & 5,446,941

MARSHALLTOWN The Premier Line

| EDI | Part# | Size-in. | Size-mm | Handle |
|-------|-------|----------|----------|--------|
| 10523 | 502D | 6½ X ⅜ | 165 X 4 | |
| 10522 | 502 | 6½ X ⅜ | 165 X 4 | |
| 11311 | 503D | 6½ X ¼ | 165 X 6 | |
| 11303 | 503 | 6½ X ¼ | 165 X 6 | |
| 11313 | 504D | 6¾ X ⅝ | 172 X 8 | |
| 11304 | 504 | 6¾ X ⅝ | 172 X 8 | |
| 11315 | 505D | 6¾ X ¾ | 172 X 10 | |
| 11305 | 505 | 6¾ X ¾ | 172 X 10 | |
| 11317 | 506D | 6¾ X ½ | 172 X 13 | |
| 11306 | 506 | 6¾ X ½ | 172 X 13 | |
| 11319 | 507D | 6¾ X ⅝ | 172 X 16 | |
| 11307 | 507 | 6¾ X ⅝ | 172 X 16 | |
| 11321 | 508D | 6¾ X ¾ | 172 X 19 | |
| 11308 | 508 | 6¾ X ¾ | 172 X 19 | |
| 11323 | 509D | 6¾ X 7/8 | 172 X 22 | |
| 11309 | 509 | 6¾ X 7/8 | 172 X 22 | |
| 11324 | 510D | 6¾ X 1 | 172 X 25 | |
| 11310 | 510 | 6¾ X 1 | 172 X 25 | |

Tuck Pointers

- Durable construction
- Perfect for projects of any size
- Designed for repeated use but priced for the Do-It-Yourselfer
- Soft grip handle for increased comfort
- **New items indicated in red**
- Sold 1 per inner pack/6 per outer pack, sold 6 per inner pack/6 per outer pack where noted with *



QLT^{BY}MARSHALLTOWN

| EDI | Part# | Size-in. | Size-mm |
|-------|---------|----------|----------|
| 18637 | TPSG614 | 6½ X ¼ | 165 X 6 |
| 10741 | TPSG38* | 6 X ⅜ | 152 X 10 |
| 18638 | TPSG655 | 6¾ X ½ | 172 X 13 |

Tuck Pointers

- Tempered blade that is fully ground and polished
- Hardwood handle
- Sold 12 per inner pack/120 per outer pack



QLT^{BY}MARSHALLTOWN

| EDI | Part# | Size-in. | Size-mm |
|-------|-------|----------|----------|
| 16129 | 929 | 6 X ¼ | 152 X 6 |
| 16198 | 98 | 6 X ⅜ | 152 X 10 |
| 16130 | 930 | 6 X ½ | 152 X 13 |

Thick Slickers

- Slickers are 1/8" (3mm) thick to last longer
- High carbon steel is tempered, hardened and polished
- Used to make a flat joint between brick and block
- 10" (254mm) length
- Sold 6 per inner pack/72 per outer pack

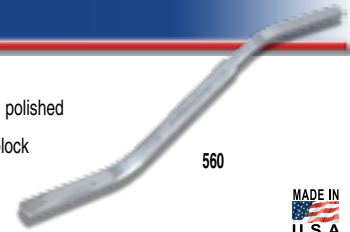

MADE IN
U.S.A.

MARSHALLTOWN The Premier Line

| EDI | Part# | Size-in. | Size-mm |
|-------|-------|-----------|---------|
| 15558 | 558 | 1/4 & 3/8 | 6 & 10 |
| 15560 | 560 | 3/8 & 1/2 | 10 & 13 |
| 15562 | 562 | 1/2 & 5/8 | 13 & 16 |
| 15564 | 564 | 5/8 & 3/4 | 16 & 19 |
| 15566 | 566 | 3/4 & 7/8 | 19 & 22 |
| 15568 | 568 | 7/8 & 1 | 22 & 25 |

Single-Size Thick Slickers

- Steel thickness is 1/8" (3mm)
- High carbon steel is tempered, hardened and polished
- 10" (254mm) overall length
- Same joint width on both ends
- Sold 6 per inner pack/72 per outer pack



MADE IN
U.S.A.

MARSHALLTOWN The Premier Line

| EDI | Part# | Size-in. | Size-mm |
|-------|-------|----------|---------|
| 10361 | SL316 | 3/16 | 5 |
| 10349 | SL14 | 1/4 | 6 |
| 10351 | SL38 | 3/8 | 10 |
| 10352 | SL12 | 1/2 | 13 |
| 10353 | SL58 | 5/8 | 16 |
| 10355 | SL34 | 3/4 | 19 |
| 10356 | SL78 | 7/8 | 22 |
| 10357 | SL1 | 1 | 25 |

Standard Slickers

- High carbon steel is tempered, hardened and polished
- Used to make a flat joint between brick and block
- 10" (254mm) length
- Sold 6 per inner pack/72 per outer pack

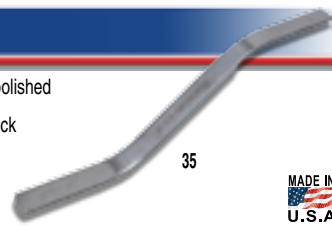

MADE IN
U.S.A

MARSHALLTOWN The Premier Line

| EDI | Part# | Size-in. | Size-mm |
|-------|-------|----------|---------|
| 15523 | 32 | ¼ & ¾ | 6 & 10 |
| 15525 | 35 | ½ & 5/8 | 13 & 16 |

Brick Jointers

- Made from high carbon steel
- Each end is a different joint size
- 10½" (267mm) length
- Sold 6 per inner pack/72 per outer pack

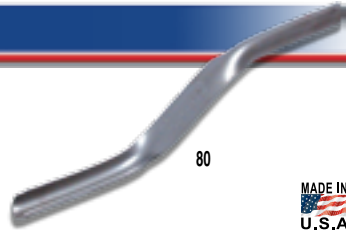

MADE IN
U.S.A

MARSHALLTOWN The Premier Line

| EDI | Part# | Size-in. | Size-mm |
|-------|-------|----------|---------|
| 15522 | 80 | ½ & 5/8 | 13 & 16 |
| 15524 | 81 | ¾ & 7/8 | 19 & 22 |
| 15526 | 82 | 5/8 & ¾ | 16 & 19 |
| 15528 | 83 | ¾ & 1/2 | 10 & 13 |

Brick Jointers

- Made from carbon steel and polished to make a slick joint
- 10½" (267mm) length
- Sold 6 per inner pack/72 per outer pack

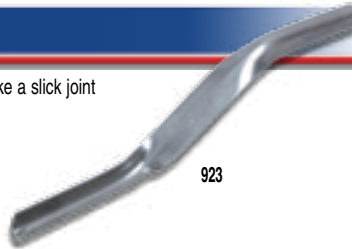

923

QLTTM BY MARSHALLTOWN

| EDI | Part# | Size-in. | Size-mm |
|-------|-------|-----------|---------|
| 16122 | 922 | 5/8 & ¾ | 16 & 19 |
| 16123 | 923 | ¾ & 1/2 | 10 & 13 |
| 16131 | 931 | 1/2 & 5/8 | 13 & 16 |

Concave & Convex Brick Jointers

- Made from high carbon steel
- Hardwood handle with metal ferrule
- High lift handle for increased knuckle clearance
- Concave/convex refers to the joint left by the tool
- Sold 6 per inner pack/6 per outer pack

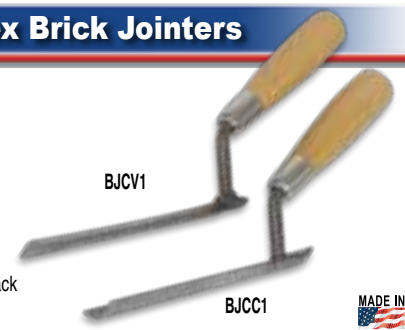

BJCV1

BJCC1

MADE IN
U.S.A

MARSHALLTOWN The Premier Line

| EDI | Part# | Description | Size-in. | Size-mm |
|-------|--------|-------------|----------|---------|
| 10315 | BJCC38 | Concave | ¾ | 10 |
| 10316 | BJCC12 | Concave | ½ | 13 |
| 10317 | BJCC58 | Concave | 5/8 | 16 |
| 10318 | BJCC34 | Concave | ¾ | 19 |
| 10319 | BJCC1 | Concave | 1 | 25 |
| 10320 | BJCV38 | Convex | ¾ | 10 |
| 10321 | BJCV12 | Convex | ½ | 13 |
| 10322 | BJCV58 | Convex | 5/8 | 16 |
| 10323 | BJCV34 | Convex | ¾ | 19 |
| 10324 | BJCV1 | Convex | 1 | 25 |

Acrylic Jointers

- Shaped from hardened acrylic material
- Will not mark or discolor white mortar
- Durable and lightweight
- Ideal for work with glass block
- 11½" (292mm) length
- Sold 6 per inner pack/6 per outer pack

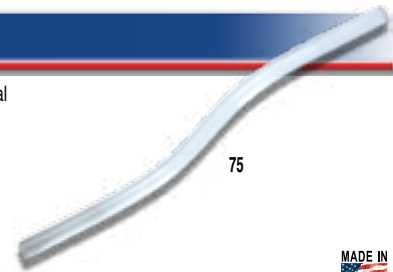

75

MADE IN
U.S.A

MARSHALLTOWN The Premier Line

| EDI | Part# | Size-in. | Size-mm |
|-------|-------|----------|---------|
| 15550 | 75 | ¾ | 10 |
| 15552 | 76 | ½ | 13 |
| 15554 | 77 | 5/8 | 16 |
| 15556 | 78 | ¾ | 19 |

Barrel Jointer

- Barrel jointer set includes four popular sizes of changeable hardened steel barrels - 1/2, 5/8, 3/4 and 7/8" (13mm, 16 mm, 19mm, and 22mm)
- Threaded barrels are easy to change
- Sold 6 per inner pack/60 per outer pack, replacement barrels are sold 6 per inner pack/6 per outer pack



QLT BY MARSHALLTOWN

| EDI | Part# | Description | Size-in. | Size-mm |
|-------|-------|----------------|---------------|----------|
| 10850 | BJ850 | Barrel Jointer | 8 1/2 X 2 1/2 | 216 X 64 |
| 10851 | RB851 | Repl. Barrels | 1/2 | 13 |
| 10852 | RB852 | Repl. Barrels | 5/8 | 16 |
| 10853 | RB853 | Repl. Barrels | 3/4 | 19 |
| 10854 | RB854 | Repl. Barrels | 7/8 | 22 |

Ball Jointer

- Ball head allows for consistent joints from every angle
- Compact design fits into pockets quickly and easily
- Two joint sizes in one: 1/2" and 5/8" (13mm and 16mm)
- Sold 1 pair per inner pack/6 pair per outer pack



MADE IN U.S.A.

MARSHALLTOWN The Premier Line

| EDI | Part# | Size-in. | Size-mm |
|-------|---------|-----------|---------|
| 10799 | BBJ1258 | 1/2 & 5/8 | 13 & 16 |

Grapevine Jointer

- Forged from high grade tool steel and heat treated
- Straight true bit makes a clean "colonial" joint
- Blade length is 3 1/2" (89mm)
- Bit size is 1/8" (3mm)
- Sold 6 per inner pack/6 per outer pack



MADE IN U.S.A.

U.S. Patent Nos. 5,327,612 & 5,446,941

MARSHALLTOWN The Premier Line

| EDI | Part# | Size-in. | Size-mm |
|-------|-------|----------|---------|
| 15532 | 84HD | 1/2 | 13 |

Double Sided Grapevine Jointers

- Forged from high grade tool steel and heat treated
- Straight true bit makes a clean "colonial" joint
- A different size on each end of the jointer
- Sold 6 per inner pack/6 per outer pack



MADE IN U.S.A.

MARSHALLTOWN The Premier Line

| EDI | Part# | Size-in. | Size-mm |
|-------|--------|-----------|---------|
| 10302 | GJ5834 | 5/8 & 3/4 | 16 & 19 |
| 10303 | GJ1258 | 1/2 & 5/8 | 13 X 16 |

Grapevine Jointers

- Forged from high grade tool steel and heat treated
- Straight true bit makes a clean "colonial" joint
- Double-ended design gives twice the wear as others
- Length is 8 1/2" (216mm), bit size is 1/8" (3mm)
- Sold 6 per inner pack/6 per outer pack



MADE IN U.S.A.

MARSHALLTOWN The Premier Line

| EDI | Part# | Size-in. | Size-mm |
|-------|-------|----------|---------|
| 15529 | 84 | 1/2 | 13 |
| 15530 | 85 | 5/8 | 16 |

Joint Raker

- Large 1 3/4" (44mm) skate wheels
- Strong aluminum handle is contoured to fit the hand and squared off at the end
- Hardened nail, adjusts to proper depth
- Sold 12 per inner pack/12 per outer pack



MADE IN U.S.A.

MARSHALLTOWN The Premier Line

| EDI | Part# | Size-in. | Size-mm |
|-------|-------|-----------|----------|
| 15502 | 89 | 8 1/2 X 3 | 216 X 76 |

Steel Body Skate Raker

- Durable all steel body
- Rugged 2 1/4" (57mm) plastic wheels
- Soft rubber grip
- Hardened nail can be adjusted to proper depth
- Sold 1 per inner pack/12 per outer pack



QLT BY MARSHALLTOWN

| EDI | Part# | Size-in. | Size-mm |
|-------|-------|---------------|-----------|
| 15668 | SR668 | 8 7/8 X 4 1/4 | 225 X 108 |

Joint Raker

- Die-cut from 1/8" (3mm) steel
- A 5/16" (8mm) and a 3/8" (10mm) tab at either end rakes corners
- Sold 6 per inner pack/72 per outer pack



MADE IN U.S.A.

QLT BY MARSHALLTOWN

| EDI | Part# | Size-in. | Size-mm |
|-------|-------|----------|---------|
| 16193 | 93 | N/A | N/A |

Solid Half Round Sled Runners

- Blade of solid construction with heavy gauge steel mounting
- Resilient DuraSoft® handle provides a soft feel, reduces fatigue and offers excellent durability
- Both ends are turned up for use in either direction
- Sold 6 per inner pack/6 per outer pack



MADE IN
U.S.A

MARSHALLTOWN The Premier Line

| EDI | Part# | Size-in. | Size-mm |
|-------|-------|----------|----------|
| 16548 | 609D | 15 X ½ | 381 X 13 |
| 16549 | 610D | 15 X ⅝ | 381 X 16 |
| 14391 | 619D | 15 X ¾ | 381 X 19 |
| 16567 | 617D | 18 X ½ | 457 X 13 |
| 16568 | 618D | 18 X ⅝ | 457 X 16 |
| 14392 | 620D | 18 X ¾ | 457 X 19 |

Half Round Sled Runners

- Heavy gauge steel mounting
- Resilient DuraSoft® handle provides a soft feel, reduces fatigue and offers excellent durability
- Popular for making half-round sunken or half-round rodded joints
- Both ends are turned up for use in either direction
- Sold 6 per inner pack/6 per outer pack



MADE IN
U.S.A

MARSHALLTOWN The Premier Line

| EDI | Part# | Size-in. | Size-mm |
|-------|-------|----------|----------|
| 16561 | 611D | 15 X ½ | 381 X 13 |
| 16562 | 612D | 15 X ⅝ | 381 X 16 |
| 14393 | 621D | 15 X ¾ | 381 X 19 |
| 16563 | 613D | 18 X ½ | 457 X 13 |
| 16564 | 614D | 18 X ⅝ | 457 X 16 |
| 14394 | 622D | 18 X ¾ | 457 X 19 |
| 18641 | 623D | 24 X ½ | 610 X 13 |
| 18642 | 624D | 24 X ⅝ | 610 X 16 |
| 18643 | 625D | 24 X ¾ | 610 X 19 |

"V" Joint Sled Runners

- Heavy gauge steel mounting
- Resilient DuraSoft® handle provides a soft feel, reduces fatigue and offers excellent durability
- Sides are ¾" (19mm)
- "V" pattern provides a center line to emphasize the joint and conceal irregularities
- Sold 6 per inner pack/6 per outer pack



MADE IN
U.S.A

MARSHALLTOWN The Premier Line

| EDI | Part# | Size-in. | Size-mm |
|-------|-------|----------|---------|
| 16565 | 615D | 15 | 381 |
| 16566 | 616D | 18 | 457 |

Barrel Sled Runners

- Quick switch barrel system - no more fumbling with screws and end pieces
- Heat-treated carbon steel barrels
- Lightweight die cast aluminum end pieces
- Comfortable structural foam handle
- Barrels are 16" (406mm) long
- Sold 1 per inner pack/12 per outer pack,

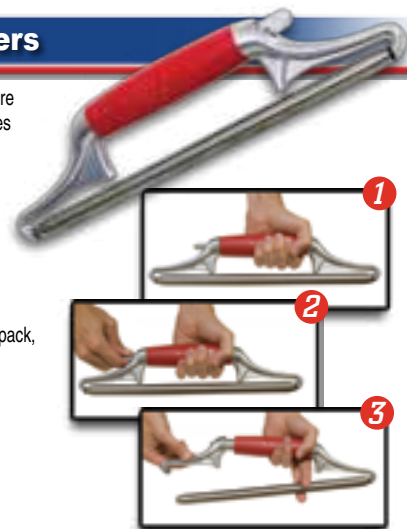

QLT BY MARSHALLTOWN

| EDI | Part# | Description | Size-in. | Size-mm |
|-------|--------|------------------|----------|----------|
| 10675 | BSR16 | ¾" Sled Runner | 16 | 406 |
| 10685 | BSR16H | Repl. Handle | 7¾ | 197 |
| 10680 | RB1612 | Barrel for BSR16 | ½ X 16 | 13 X 406 |
| 10681 | RB1658 | Barrel for BSR16 | ⅝ X 16 | 16 X 406 |
| 10682 | RB1634 | Barrel for BSR16 | ¾ X 16 | 19 X 406 |
| 10683 | RB1678 | Barrel for BSR16 | 7⁄8 X 16 | 22 X 406 |

Grout Bags

- Made of seamless black vinyl
- Available with or without a ⅜" (10mm) metal tip
- Replacement tip sold separately
- Sold 1 per inner pack/72 per outer pack



MADE IN
U.S.A

MARSHALLTOWN The Premier Line

| EDI | Part# | Description | Size-in. | Size-mm |
|-------|-------|-------------|----------|-----------|
| 17817 | GB691 | w/o Tip | 12 X 24 | 305 X 610 |
| 17818 | GB692 | w/ Tip | 12 X 24 | 305 X 610 |
| 17819 | RT693 | Tip Only | N/A | N/A |

Blu-Tip™ Grout Bag

- Made from seamless white plastic
- Blue molded-in tip can be cut to the desired opening
- Easy cleanup
- Sold 1 per inner pack/72 per outer pack



MADE IN
U.S.A

MARSHALLTOWN The Premier Line

| EDI | Part# | Size-in. | Size-mm |
|-------|-------|----------|-----------|
| 17816 | GB690 | 12 X 24 | 305 X 610 |

Disposable Grout Bag

- Great for hard to clean materials
- Trim tip to desired opening
- 50 bags per box
- Use with or without a metal tip RT693 (sold separately), see page 17
- Thermally sealed edge and tip to prevent leaks
- Sold 1 per inner pack/4 per outer pack



QLT BY MARSHALLTOWN

| EDI | Part# | Size-in. | Size-mm |
|-------|--------|----------|-----------|
| 16661 | DGB661 | 11 X 21 | 279 X 533 |

Estwing Brick Hammers

- Made of a single piece of forged steel with nylon-vinyl cushion bricklayer grip
- Fully polished face
- Designed for breaking, trimming and cleaning brick
- Not intended for striking chisels or metal
- **WARNING:** Always wear safety goggles when using this tool
- Inner/outer pack quantities are shown in table

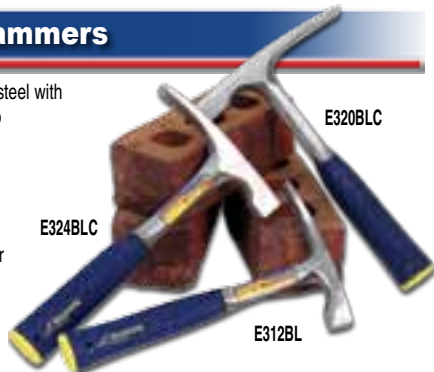

MADE IN
U.S.A

MARSHALLTOWN The Premier Line

| EDI | Part# | Length-in. | Length-mm | Weight-oz. | Inner/Outer |
|-------|---------|------------|-----------|------------|-------------|
| 16666 | E312BL | 10 | 254 | 12 | 4/48 |
| 16668 | E320BLC | 11 | 279 | 20 | 4/24 |
| 16669 | E324BLC | 11 | 279 | 24 | 2/24 |

Brick Hammers

- Strong fiberglass shaft with cushion grip built to last
- Fully polished face
- Not intended for striking chisels or metal
- **WARNING:** Always wear safety goggles when using this tool
- Sold 4 per inner pack/24 per outer pack, sold 4 per inner pack/12 per outer pack where noted with*



MADE IN
U.S.A

MARSHALLTOWN The Premier Line

| EDI | Part# | Length-in. | Length-mm | Weight-oz. |
|-------|---------|------------|-----------|------------|
| 16673 | BHF616 | 12½ | 318 | 16 |
| 16674 | BHF624* | 14 | 356 | 24 |

Brick Hammers

- Forged in one piece from high grade steel
- Perfectly balanced and securely fitted with a comfortable hickory handle
- Designed for breaking, trimming and cleaning brick
- Not intended for striking chisels or metal
- **WARNING:** Always wear safety goggles when using this tool
- Sold 4 per inner pack/24 per outer pack



MADE IN
U.S.A

MARSHALLTOWN The Premier Line

| EDI | Part# | Length-in. | Length-mm | Weight-oz. |
|-------|-------|------------|-----------|------------|
| 16560 | 600 | 11 | 279 | 16 |
| 16559 | 601 | 11½ | 292 | 24 |

Solid Steel Brick Hammer

- 20 oz. solid steel construction
- Soft grip handle
- Designed for breaking, trimming and cleaning brick
- Not intended for striking chisels or metal
- **WARNING:** Always wear safety goggles when using this tool
- Sold 4 per inner pack/24 per outer pack



QLT BY MARSHALLTOWN

| EDI | Part# | Length-in. | Length-mm | Weight-oz. |
|-------|--------|------------|-----------|------------|
| 10809 | BHS720 | 11 | 279 | 20 |

Brick Hammers

- Drop forged from high grade steel
- Expertly balanced and securely fitted with a comfortable hardwood handle
- Has a fully polished, milled face
- Not intended for striking chisels or metal
- **WARNING:** Always wear safety goggles when using this tool
- BH760 sold 6 per inner pack/36 per outer pack, BH761 sold 6 per inner pack/24 per outer pack



QLT BY MARSHALLTOWN

| EDI | Part# | Length-in. | Length-mm | Weight-oz. |
|-------|-------|------------|-----------|------------|
| 10845 | BH760 | 11½ | 292 | 16 |
| 10846 | BH761 | 11½ | 292 | 24 |

Plumb® Wide Bit Brick Hammer

- Forged head with sharp, 2" wide bit for cleaner cutting of the brick
- Durable, black epoxy powder coated head
- Strong Fiberglass handle with comfortable cushion grip
- Permabond® between the head and handle
- **WARNING:** Always wear safety goggles when using this tool
- Sold 1 per inner pack/1 per outer pack



MARSHALLTOWN The Premier Line

| EDI | Part# | Size-oz. | Size-kg |
|-------|--------|----------|---------|
| 15544 | M11502 | 20 | .57 |

Toothed Bush Hammers

- Creates a rough, pockmarked texture that resembles naturally weathered rock
- Heavy duty 16" hickory handle
- WARNING:** Always wear safety goggles when using this tool
- Sold 1 per inner pack/6 per outer pack



QLT BY MARSHALLTOWN

| EDI | Part# | Length-in. | Length-mm | Weight-lb. |
|-------|-------|------------|-----------|------------|
| 10476 | TBH3 | 15 1/2 | 394 | 3 |
| 10477 | TBH4 | 15 3/4 | 400 | 4 |

Stone Mason's Hammer

- Sharp end used to chip off edges or small pieces of stone
- Heavy duty 16" hickory handle
- WARNING:** Always wear safety goggles when using this tool
- Sold 1 per inner pack/6 per outer pack



QLT BY MARSHALLTOWN

| EDI | Part# | Weight-lbs | Weight-oz |
|-------|-------|------------|-----------|
| 10473 | SMH3 | 3 | 48 |
| 10474 | SMH4 | 4 | 64 |
| 10475 | SMH6 | 6 | 96 |

Stainless Steel Wall Capping Tools

- Blade of heavy gauge stainless steel
- Resilient DuraSoft® handle provides a soft feel, reduces fatigue and offers excellent durability
- Sturdy steel mounting
- Produces a clean rounded cap on masonry walls
- Sold 2 per inner pack/2 per outer pack



MADE IN U.S.A.

MARSHALLTOWN The Premier Line

| EDI | Part# | Size-in. | Size-mm |
|-------|-------|----------|---------|
| 16224 | WCT6 | 6 | 152 |
| 16226 | WCT8 | 8 | 203 |

Carbide Tipped Point Chisels

- For roughing out and knocking off high spots
- WARNING:** Always wear safety goggles when using this tool
- Sold 1 per inner pack/1 per outer pack



CTHPOINT78

MADE IN U.S.A.

MARSHALLTOWN The Premier Line

| EDI | Part# | Length | Width | Stock |
|-------|------------|-----------------|--------------|--------------|
| 13258 | CTHPOINT58 | 8 1/4" (209 mm) | 5/8" (16 mm) | 5/8" (16 mm) |
| 13259 | CTHPOINT78 | 8 1/4" (209 mm) | 7/8" (22 mm) | 7/8" (22 mm) |
| 13260 | CTHPOINT1 | 8 1/4" (209 mm) | 1" (25 mm) | 1" (25 mm) |

Carbide Tipped Hand Sets

- For trimming stone to size when the surface is relatively flat
- Forged from the finest quality tool steel, hardened, tempered and well-balanced
- WARNING:** Always wear safety goggles when using this tool
- Sold 1 per inner pack/1 per outer pack



CTHSET2

MADE IN U.S.A.

MARSHALLTOWN The Premier Line

| EDI | Part# | Length | Width | Stock |
|-------|-----------|----------------|----------------|----------------|
| 13220 | CTHSET112 | 8 1/4" (209mm) | 1 1/2" (38 mm) | 1" (25 mm) |
| 13231 | CTHSET2 | 8 1/4" (209mm) | 2" (63 mm) | 1" (25 mm) |
| 13237 | CTHSET214 | 8 1/4" (209mm) | 2 1/4" (57 mm) | 1 1/8" (28 mm) |
| 13242 | CTHSET3 | 8 1/4" (209mm) | 3" (76 mm) | 1 1/4" (31 mm) |

Carbide Tipped Hand Tracers

- For splitting stone or scoring lines before trimming
- Forged from the finest quality tool steel, hardened, tempered and well-balanced
- WARNING:** Always wear safety goggles when using this tool
- Sold 1 per inner pack/1 per outer pack



CTHTRACER2

MADE IN U.S.A.

MARSHALLTOWN The Premier Line

| EDI | Part# | Length | Width | Stock |
|-------|--------------|-----------------|----------------|----------------|
| 13243 | CTHTRACER112 | 8 1/4" (209 mm) | 1 1/2" (38 mm) | 1" (25 mm) |
| 13253 | CTHTRACER2 | 8 1/4" (209 mm) | 2" (63 mm) | 1" (25 mm) |
| 13254 | CTHTRACER3 | 8 1/4" (209 mm) | 3" (76 mm) | 1 1/4" (31 mm) |

Carbide Tipped Hand Chisels

- For general carving or roughing out
- WARNING:** Always wear safety goggles when using this tool
- Sold 1 per inner pack/1 per outer pack



CTHCHISEL12

MADE IN U.S.A.

MARSHALLTOWN The Premier Line

| EDI | Part# | Length | Width | Stock |
|-------|-------------|-----------------|--------------|--------------|
| 13255 | CTHCHISEL38 | 7 1/4" (184 mm) | 3/8" (10 mm) | 3/8" (10 mm) |
| 13256 | CTHCHISEL12 | 7 1/4" (184 mm) | 1/2" (13 mm) | 1/2" (13 mm) |
| 13257 | CTHCHISEL34 | 8 1/4" (209 mm) | 3/4" (19 mm) | 3/4" (19 mm) |

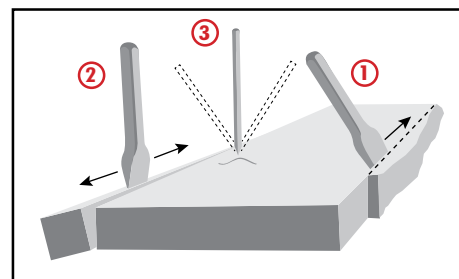

DuraSoft® Guarded Chisels

- Chisels are forged from the finest quality tool steel, hardened, tempered and well-balanced
- Comfortable DuraSoft® grip handle helps reduce fatigue and provides superior comfort
- Snug hand guard fit helps prevent slippage down the chisel
- **WARNING:** Always wear safety goggles when using this tool
- Made in England
- Sold 1 per inner pack/10 per outer pack



MARSHALLTOWN The Premier Line

| EDI | Part# | Description | Length | Width | Stock |
|-------|--------|------------------------------|--------------|-------------|------------|
| 11142 | 657SG | Brick Bolster | 9" (229mm) | 2½" (64 mm) | ⅞" (22 mm) |
| 11143 | 603SG | Brick Bolster | 9" (229mm) | 3" (76 mm) | ⅞" (22 mm) |
| 11144 | 604SG | Brick Bolster | 9" (229mm) | 4" (102 mm) | ⅞" (22 mm) |
| 11145 | 606SG | Mason's Chisel | 9" (229mm) | 2" (51 mm) | ⅝" (16 mm) |
| 11146 | 646SG | Stone Mason's Chisel | 8" (203mm) | 1¼" (32 mm) | ⅞" (22 mm) |
| 11147 | 647SG | Stone Mason's Chisel | 8" (203mm) | 1¾" (44 mm) | ⅞" (22 mm) |
| 11148 | 648SG | Stone Mason's Chisel | 8" (203mm) | 2¼" (57 mm) | 1" (25mm) |
| 11149 | 654SG | Toothed Stone Mason's Chisel | 8" (203mm) | 1¾" (44 mm) | ⅞" (22 mm) |
| 11150 | 655SG | Toothed Stone Mason's Chisel | 8" (203mm) | 2¼" (57 mm) | ⅞" (22 mm) |
| 11151 | 607SG | Fluted Plugging Chisel | 10" (254 mm) | 1" (25 mm) | ⅝" (16 mm) |
| 11152 | ST34SG | Stone Hand Chisel | 8" (203mm) | ¾" (19 mm) | ⅝" (16 mm) |
| 11153 | ST78SG | Stone Hand Chisel | 8" (203mm) | ⅞" (22 mm) | ¾" (19 mm) |
| 11154 | B212SG | Brick Set | 8½" (203mm) | 2½" (63 mm) | ⅞" (22 mm) |
| 11155 | B300SG | Brick Set | 8½" (203mm) | 3" (76 mm) | ⅞" (22 mm) |
| 11156 | B312SG | Brick Set | 8½" (203mm) | 3½" (89 mm) | ⅞" (22 mm) |
| 11162 | S200SG | Standard Hand Set | 9" (229 mm) | 2" (51 mm) | ⅞" (22 mm) |
| 11157 | P200SG | Pitching Chisel | 9" (229 mm) | 2" (51 mm) | ⅞" (22 mm) |
| 11158 | PLUGSG | Plugging Chisel | 10" (254 mm) | 1" (25 mm) | ⅝" (16 mm) |
| 11159 | T200SG | Tracer Hand Set | 9" (229mm) | 2 (51 mm) | ⅞" (22 mm) |
| 11160 | T212SG | Tracer Hand Set | 9" (229mm) | 2½" (64 mm) | ⅞" (22 mm) |
| 11161 | T300SG | Tracer Hand Set | 9" (229mm) | 3" (76 mm) | ⅞" (22 mm) |

Brick Chisel

- Forged from the finest quality tool steel, hardened, tempered and well-balanced
- Rubber grip to prevent slippage
- For cutting, trimming or cleaning brick
- **WARNING:** Always wear safety goggles when using this tool
- Made in England
- Sold 10 per inner pack/10 per outer pack



MARSHALLTOWN The Premier Line

| EDI | Part# | Length | Width | Stock |
|-------|-------|------------|-------------|------------|
| 16541 | 604 | 9" (229mm) | 4" (102 mm) | ¾" (19 mm) |

Brick Bolsters

- Forged from the finest quality tool steel, hardened, tempered and well-balanced
- Thin, strong blade ensures a clean, crisp cut
- For cutting, trimming or cleaning brick
- **WARNING:** Always wear safety goggles when using this tool
- Made in England
- Sold 10 per inner pack/10 per outer pack

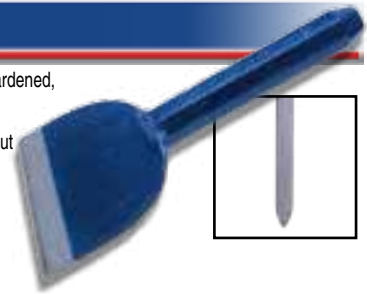

MARSHALLTOWN The Premier Line

| EDI | Part# | Length | Width | Stock |
|-------|-------|------------|--------------|------------|
| 16617 | 657 | 9" (229mm) | 2½" (64 mm) | ⅞" (22 mm) |
| 16618 | 658 | 9" (229mm) | 3" (76 mm) | ⅞" (22 mm) |
| 16619 | 659 | 9" (229mm) | 4½" (114 mm) | ⅞" (22 mm) |

Brick Set

- For cutting brick
- Forged from the finest quality tool steel, hardened, tempered and well-balanced
- **WARNING:** Always wear safety goggles when using this tool
- Made in England
- Sold 10 per inner pack/10 per outer pack

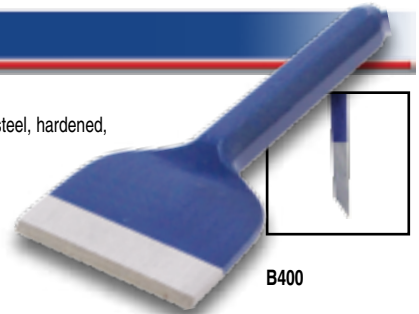

B400

MARSHALLTOWN The Premier Line

| EDI | Part# | Length | Width | Stock |
|-------|-------|-------------|--------------|------------|
| 15185 | B212 | 8½" (203mm) | 2½" (63 mm) | ⅞" (22 mm) |
| 15186 | B300 | 8½" (203mm) | 3" (76 mm) | ⅞" (22 mm) |
| 15187 | B312 | 8½" (203mm) | 3½" (89 mm) | ⅞" (22 mm) |
| 15188 | B400 | 8½" (203mm) | 4" (102 mm) | 1" (25mm) |
| 15189 | B412 | 8½" (203mm) | 4½" (115 mm) | 1" (25mm) |

Mason's Chisel

- Forged from the finest quality tool steel, hardened, tempered and well-balanced
- **WARNING:** Always wear safety goggles when using this tool
- Made in England
- Sold 10 per inner pack/10 per outer pack



MARSHALLTOWN The Premier Line

| EDI | Part# | Length | Width | Stock |
|-------|-------|------------|------------|------------|
| 16543 | 606 | 9" (229mm) | 2" (51 mm) | ⅝" (16 mm) |

Stone Hand Chisels

- Forged from the finest quality tool steel, hardened, tempered and well-balanced
- For general carving or roughing out
- **WARNING:** Always wear safety goggles when using this tool
- Made in England
- Sold 10 per inner pack/10 per outer pack

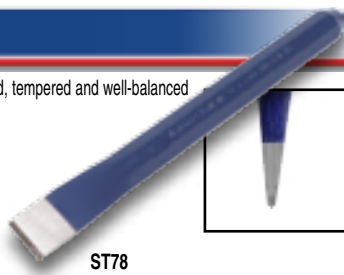

ST78

MARSHALLTOWN The Premier Line

| EDI | Part# | Length | Width | Stock |
|-------|-------|------------|--------------|--------------|
| 15181 | ST12 | 8" (203mm) | 1/2" (13 mm) | 1/2" (13 mm) |
| 15182 | ST34 | 8" (203mm) | 3/4" (19 mm) | 5/8" (16 mm) |
| 15183 | ST78 | 8" (203mm) | 7/8" (22 mm) | 3/4" (19 mm) |

Tracer Hand Set

- For splitting stone or scoring lines before trimming
- Forged from the finest quality tool steel, hardened, tempered and well-balanced
- **WARNING:** Always wear safety goggles when using this tool
- Made in England
- Sold 10 per inner pack/10 per outer pack

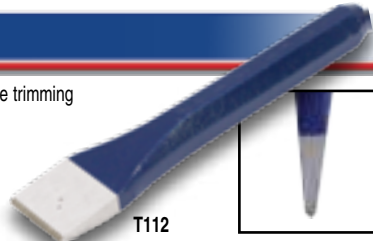

T112

MARSHALLTOWN The Premier Line

| EDI | Part# | Length | Width | Stock |
|-------|-------|------------|----------------|--------------|
| 15184 | T112 | 9" (229mm) | 1 1/2" (38 mm) | 7/8" (22 mm) |
| 10479 | T200 | 9" (229mm) | 2" (51 mm) | 7/8" (22 mm) |
| 10480 | T212 | 9" (229mm) | 2 1/2" (64 mm) | 7/8" (22 mm) |
| 10481 | T300 | 9" (229mm) | 3" (76 mm) | 7/8" (22 mm) |

Standard Hand Set

- For trimming stone to size when the surface is relatively flat
- Forged from the finest quality tool steel, hardened, tempered and well-balanced
- **WARNING:** Always wear safety goggles when using this tool
- Made in England
- Sold 10 per inner pack/10 per outer pack

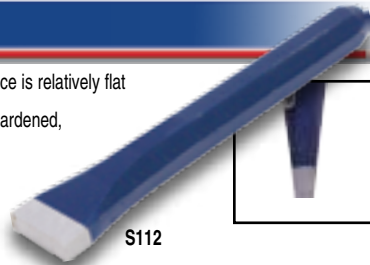

S112

MARSHALLTOWN The Premier Line

| EDI | Part# | Length | Width | Stock |
|-------|-------|-------------|----------------|--------------|
| 15190 | S112 | 9" (229 mm) | 1 1/2" (38 mm) | 7/8" (22 mm) |
| 10482 | S200 | 9" (229 mm) | 2" (51 mm) | 7/8" (22 mm) |

Pitching Chisels

- For pounding stone on edge to put a facing on it
- Forged from the finest quality tool steel, hardened, tempered and well-balanced
- **WARNING:** Always wear safety goggles when using this tool
- Made in England
- Sold 10 per inner pack/10 per outer pack

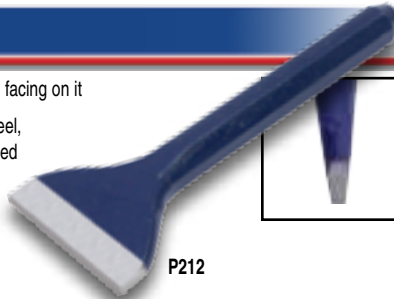

P212

MARSHALLTOWN The Premier Line

| EDI | Part# | Length | Width | Stock |
|-------|-------|-------------|----------------|--------------|
| 15191 | P200 | 9" (229 mm) | 2" (51 mm) | 7/8" (22 mm) |
| 15192 | P212 | 9" (229 mm) | 2 1/2" (63 mm) | 1" (25mm) |
| 15193 | P300 | 9" (229 mm) | 3" (76 mm) | 1" (25mm) |

Stone Mason's Chisels

- Thin, strong, forged steel blade assures clean, crisp cuts
- Perfect for cutting concrete block, cinder block, brick and veined stones such as Arizona or Crab Orchard
- **WARNING:** Always wear safety goggles when using this tool
- Made in England
- Sold 10 per inner pack/10 per outer pack

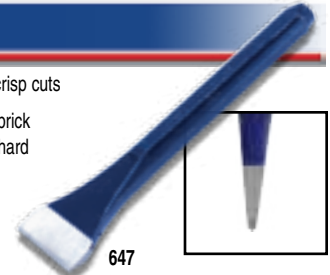

647

MARSHALLTOWN The Premier Line

| EDI | Part# | Length | Width | Stock |
|-------|-------|------------|----------------|--------------|
| 16606 | 646 | 8" (203mm) | 1 1/4" (32 mm) | 7/8" (22 mm) |
| 16607 | 647 | 8" (203mm) | 1 3/4" (44 mm) | 7/8" (22 mm) |
| 16608 | 648 | 8" (203mm) | 2 1/4" (57 mm) | 1" (25mm) |

Toothed Stone Mason's Chisels

- Forged from hard steel
- Strong sharp teeth cut cleanly and accurately
- Ideal for cutting through soft stone such as Bedford
- Not to be used on hard stone or concrete
- **WARNING:** Always wear safety goggles when using this tool
- Made in England
- Sold 10 per inner pack/10 per outer pack



656

MARSHALLTOWN The Premier Line

| EDI | Part# | Length | Width | Stock |
|-------|-------|------------|----------------|--------------|
| 16614 | 654 | 8" (203mm) | 1 3/4" (44 mm) | 7/8" (22 mm) |
| 16615 | 655 | 8" (203mm) | 2 1/4" (57 mm) | 7/8" (22 mm) |
| 16616 | 656 | 8" (203mm) | 2 3/4" (70 mm) | 1" (25mm) |

Plugging Chisels

- For cleaning out hardened mortar
- Forged from the finest quality tool steel, hardened, tempered and well-balanced
- **607 has a fluted bit**
- **WARNING:** Always wear safety goggles when using this tool
- Made in England
- Sold 10 per inner pack/10 per outer pack

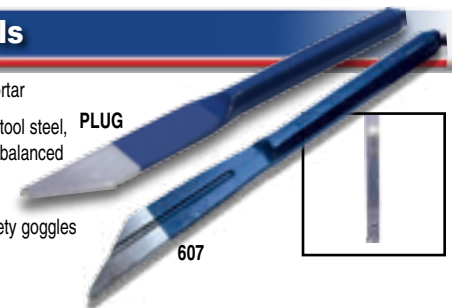

607

MARSHALLTOWN The Premier Line

| EDI | Part# | Length | Width | Stock |
|-------|-------|--------------|------------|--------------|
| 16544 | 607 | 10" (254 mm) | 1" (25 mm) | 5/8" (16 mm) |
| 15194 | PLUG | 10" (254 mm) | 1" (25 mm) | 5/8" (16 mm) |

Stone Splitting Wedge & Shims

- Sold in sets which include one wedge and two shims
- Drill hole, insert shims and wedge, hammer to split
- **WARNING:** Always wear safety goggles when using this tool
- Sold 1 per inner pack/1 per outer pack



MADE IN
U.S.A.

MARSHALLTOWN The Premier Line

| EDI | Part# | Diameter | Size-in. | Size-mm |
|-------|-------|------------|----------|---------|
| 11284 | SW212 | ½" (13mm) | 2½ | 64 |
| 11285 | SW3 | ⅝" (16mm) | 3 | 76 |
| 11286 | SW4 | ¾" (19mm) | 4 | 102 |
| 11287 | SW6 | 1" (25mm) | 6 | 152 |
| 11288 | SW8 | 1¼" (31mm) | 8 | 203 |
| 11289 | SW12 | 1½" (38mm) | 12 | 305 |

Mini Brick Splitter

- Durable steel construction for longer life
- Sturdy steel base
- Carrying handle for easy transportation
- Hardened steel blades for clean cuts
- 12" ruler built in
- **WARNING:** Always wear safety goggles when using this tool
- Sold 1 per inner pack, 1 per outer pack



MADE IN
U.S.A.

MARSHALLTOWN The Premier Line

| EDI | Part# | Description | Size-in. | Size-mm |
|-------|---------|----------------|----------|---------|
| 16222 | MBS22 | Brick Splitter | N/A | N/A |
| 16223 | MBS22RB | Repl. Blades | N/A | N/A |

Rub Bricks

- Available in many sizes with or without handle
- Ideal for dressing down and removing form marks from concrete or cleaning brick
- Sold 1 per inner pack/4 per outer pack, 5 per outer pack where noted with *



MADE IN
U.S.A.

MARSHALLTOWN The Premier Line

| EDI | Part# | Grit/Description | Size-in. | Size-mm |
|-------|--------|--------------------|-------------|---------------|
| 16533 | 16533 | 20 Round w/Handle | 6 X 1 | 152 X 25 |
| 16535 | 16535* | 60 w/Handle | 6 X 3 X 1 | 152 X 76 X 25 |
| 16537 | 16537* | 20 w/Handle | 8 X 3½ X ¼ | 203 X 89 X 19 |
| 16547 | 16547 | 20 Fluted | 6 X 2 X 2 | 152 X 51 X 51 |
| 16545 | 16545 | 20 Fluted | 8 X 2 X 2 | 203 X 51 X 51 |
| 16440 | 840* | 20 Fluted w/Handle | 6 X 3 X 1 | 152 X 76 X 25 |
| 16441 | 841* | 20 Fluted w/Handle | 8 X 3½ X 1½ | 203 X 89 X 38 |

Rub Bricks

- Fluted 20-grit silicon carbide surface
- Ideal for dressing down and removing marks from concrete or cleaning brick
- Sold 1 per inner pack/5 per outer pack



QLT BY MARSHALLTOWN

| EDI | Part# | Grit/Description | Size-in. | Size-mm |
|-------|-------|------------------|-------------|---------------|
| 16192 | RB192 | 20 Fluted | 6 X 3 X 1 | 152 x 76 X 25 |
| 16194 | RB194 | 20 Fluted | 8 X 3½ X 1½ | 203 x 89 x 38 |

Brick Tongs

- Heavy duty design, built for long wear, maintenance free
- Can be quickly adjusted to carry from six to ten bricks
- Sold 1 per inner pack/12 per outer pack



QLT BY MARSHALLTOWN

| EDI | Part# | Size-in. | Size-mm |
|-------|-------|----------|-----------|
| 16510 | 88 | 16 - 26½ | 406 - 673 |

Square Tube Brick Tongs

- Heavy duty tongs designed and built for long wear
- Can be quickly adjusted to carry from six to eleven bricks
- Tongs are maintenance free
- Soft grip handle
- Sold 1 per inner pack/12 per outer pack



QLT BY MARSHALLTOWN

| EDI | Part# | Size-in. | Size-mm |
|-------|-------|-----------|-----------|
| 16049 | SBT49 | 16½ - 27½ | 419 - 695 |

Shovels

- For details and size options on Shovels
see pages 239-241



Bucket Scoops

- For details and size options on Bucket Scoops
see page 165



Brick & Block Cart

- Load capacity of 800 lbs (362kg).
- Large hole pattern allows for multiple prong positions
- Includes one set of 7½" (191mm) brick prongs
- 15" (381mm) block prongs available
- Rugged 13" (330mm) pneumatic tires
- Cart ships LTL
- Sold 1 per inner pack/1 per outer pack



MARSHALLTOWN The Premier Line

| EDI | Part# | Description | Size-in. | Size-mm |
|-------|-----------|--------------------|----------|------------|
| 13697 | BC3697 | Brick & Block Cart | 29½ X 55 | 750 X 1397 |
| 13698 | PR75 | Short Cart Prongs | 7½ | 191 |
| 13699 | PR15 | Long Cart Prongs | 15 | 381 |
| 16532 | BCBEARING | Repl. Bearing | N/A | N/A |
| 16536 | BCWHEEL | Repl. Wheel | N/A | N/A |
| 16530 | BCAXLE | Repl. Axle | N/A | N/A |

Mortar Boxes

- Over 5" (127mm) of forklift clearance
- Durable 10 gauge steel with reinforced top rim
- 15536 has a 6 cubic foot (.17 cubic meter) capacity
- 15537 has a 10 cubic foot (.28 cubic meter) capacity
- Ships LTL, sold 1 per inner pack/1 per outer pack



MARSHALLTOWN The Premier Line

| EDI | Part# | Size-in. | Size-mm |
|-------|-------|----------------|------------------|
| 15536 | 15536 | 37 X 20½ X 24¾ | 940 X 521 X 629 |
| 15537 | 15537 | 47 X 25½ X 24¾ | 1194 X 648 X 629 |

Mortar Boxes

- Powder coated for rust resistance
- Reinforced top rim resists job site abuse
- Heavy duty, welded 16 gauge steel construction
- 10375 has a 6 cubic foot (.17 cubic meter) capacity 10376 has a 9 cubic foot (.23 cubic meter) capacity and 10377 has a 15 cubic foot (.42 cubic meter) capacity
- Sold 1 per inner pack/1 per outer pack



MARSHALLTOWN The Premier Line

| EDI | Part# | Size-in. | Size-mm |
|-------|-------|-----------------|-------------------|
| 10375 | 10375 | 33¾ X 54¼ X 12¼ | 844 X 1378 X 311 |
| 10376 | 10376 | 35¾ X 64¼ X 12¼ | 912 X 1628 X 311 |
| 10377 | 10377 | 42 X 82½ X 12¼ | 1066 X 2086 X 311 |

Steel Mortar Pan

- Powder-coated 12 gauge steel
- Has a 3 cubic foot (.08 cubic meter) capacity
- Durable leak-proof construction
- Smooth rounded corners and side walls for better mixing
- Sold 1 per inner pack/1 per outer pack



MARSHALLTOWN The Premier Line

| EDI | Part# | Size-in. | Size-mm |
|-------|-------|-------------|-----------------|
| 14892 | 14892 | 30 X 30 X 7 | 762 X 762 X 178 |

Mortar Hoe

- Steel ferrule riveted to one piece forged carbon steel head
- 14281 has a heavy duty 18" (457mm) hardwood handle with sturdy "D" grip
- 14278 has a 60° (1524mm) straight hardwood handle
- 14279 has a 66° (1676mm) straight hardwood handle
- Sold 1 per inner pack/4 per outer pack, 1 per outer pack where noted with *



MARSHALLTOWN The Premier Line

| EDI | Part# | Description | Blade-in. | Blade-mm |
|-------|--------|-----------------|-----------|-----------|
| 14281 | 14281 | D-Grip | 4¾ X 7 | 121 X 178 |
| 14278 | 14278* | Straight Handle | 4¾ X 7 | 121 X 178 |
| 14279 | 14279* | Straight Handle | 6 X 10 | 152 X 254 |

Short Handle Mortar Hoe

- 21" (533mm) contoured wood handle
- Rounded corners make this ideal for mixing mortar in a wheelbarrow or mortar pan
- Holes in blade for more effective mixing
- Sold 1 per inner pack/6 per outer pack



QLTSM MARSHALLTOWN

| EDI | Part# | Blade-in. | Blade-mm |
|-------|-------|-----------|-----------|
| 14246 | 14246 | 6¾ X 5 | 162 X 127 |

Gatorback® Mortar Board

- Water resistant, contour surface is designed to keep mortar and stucco at optimal workability and consistency
- Made of a lightweight, impact and UV resistant polymer that won't conduct heat and is nearly indestructible
- Reinforced integrated handle for easy transportation
- Reinforced ribbing enables Gatorback® mortarboards to hold up to 150lbs of material with little flex
- Sold 1 per inner pack/1 per outer pack



MARSHALLTOWN The Premier Line

| EDI | Part# | Size-in. | Size-mm |
|-------|---------|----------|-----------|
| 14999 | GBK0306 | 24 X 24 | 610 X 610 |

Gatorback® Mortar Pan



- Made of a lightweight, impact and UV resistant polymer that won't conduct heat like steel pans and is nearly indestructible
- Lightest pan on the market at only 8 lbs
- Reinforced integrated handles for easy transportation
- Impervious, rigid surface made with a double thick bottom for superior durability
- Holds up to 1.75 cubic feet (225lbs) of mortar
- Open faced design and 6" depth makes it easier for masons to efficiently remove mortar
- Sold 1 per inner pack/1 per outer pack

MARSHALLTOWN The Premier Line

| EDI | Part# | Size-in. | Size-mm |
|-------|-------|----------|-----------|
| 14998 | 14998 | 30 X 30 | 762 X 762 |

Mortar Box



- Made of extra high density, UV stabilized polyethylene
- Durable, lightweight and easy to clean
- Dry mortar will not stick
- Not affected by heat and cold, rust, plaster, mortar and water
- 10 cubic foot (.28 cubic meter) capacity
- Sold 1 per inner pack/1 per outer pack



MARSHALLTOWN The Premier Line

| EDI | Part# | Size-in. | Size-mm |
|-------|-------|--------------|------------------|
| 11165 | 11165 | 60 X 32 X 11 | 1524 X 813 X 279 |

Mortar Pan



- Made of extra high density, UV stabilized polyethylene
- Durable, lightweight and easy to clean
- Dry mortar will not stick
- Not affected by heat and cold, rust, plaster, mortar and water
- Sold 1 per inner pack/1 per outer pack



MARSHALLTOWN The Premier Line

| EDI | Part# | Size-in. | Size-mm |
|-------|-------|-------------|-----------------|
| 11166 | 11166 | 30 X 30 X 7 | 762 X 762 X 178 |

Mortar Board



- Made of extra high density, UV stabilized polyethylene
- Durable, lightweight and easy to clean
- Dry mortar will not stick
- Not affected by heat and cold, rust, plaster, mortar and water
- Sold 1 per inner pack/1 per outer pack



MARSHALLTOWN The Premier Line

| EDI | Part# | Size-in. | Size-mm |
|-------|-------|----------|-----------|
| 11167 | 11167 | 24 X 24 | 610 X 610 |

Heavy Duty Rubber Pails



- Heavy duty rubber-will not rust, dent, leak or chip
- Bounce back upon impact
- Resist heat and cold, lime, acids, salt, water, fuels, grease and chemicals
- Sold 1 per inner pack/12 per outer pack, 1 per inner pack/3 per outer pack where noted with *



MARSHALLTOWN The Premier Line

| EDI | Part# | Description | Size-qt. | Size-L |
|-------|-------|---------------------|----------|--------|
| 10636 | HP15* | Large Tub | 60 | 57 |
| 10637 | DF12 | Pail w/Standard Lip | 12 | 11.4 |
| 10638 | DF10 | Pail w/Standard Lip | 10 | 9.5 |
| 10639 | DFP18 | Pail w/Pouring Lip | 18 | 17 |

Folding Mortar Stand

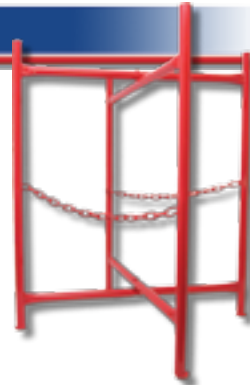

- Made from tubular steel and can be used on scaffolding or ground
- Folds for easy storage
- Lightweight and easy to handle
- Stands 30" (762mm) tall, can also be laid on its side to provide a 19" (483mm) high horizontal support
- Sold 1 per inner pack/1 per outer pack

QLT BY MARSHALLTOWN

| EDI | Part# | Size-in. | Size-mm |
|-------|-------|----------|-----------|
| 10819 | 10819 | 30 X 19 | 762 X 483 |

Line Level



- Break resistant reversed line hooks for positive hold
- Lightweight design eliminates line sag
- Sold 10 per inner pack/100 per outer pack



MARSHALLTOWN The Premier Line

| EDI | Part# | Size-in. | Size-mm |
|-------|-------|----------|---------|
| 16554 | 16554 | N/A | N/A |

Crick® Levels

- Standard 3-Piece Level is strong and durable
- Accurate to .015" in length of level
- Optional rubber end cushions
- 3 year warranty
- Inner/outer pack quantities listed in table

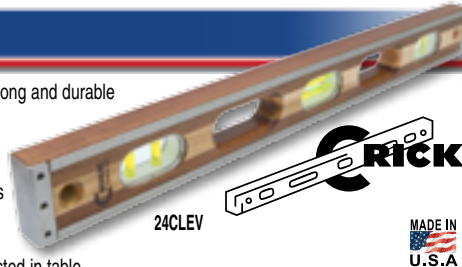

MADE IN
U.S.A

MARSHALLTOWN The Premier Line

| EDI | Part# | Description | Inner/Outer |
|-------|---------|-----------------|-------------|
| 11074 | 24CLEV | 24" Green Vials | 1/16 |
| 18707 | 24CLEVC | 24" Clear Vials | 1/16 |
| 11075 | 36CLEV | 36" Green Vials | 1/8 |
| 18708 | 36CLEVC | 36" Clear Vials | 1/8 |
| 11076 | 42CLEV | 42" Green Vials | 1/8 |
| 18709 | 42CLEVC | 42" Clear Vials | 1/8 |
| 11077 | 48CLEV | 48" Green Vials | 1/8 |
| 18710 | 48CLEVC | 48" Clear Vials | 1/8 |

Crick Levels with Rubber End Cushions

| EDI | Part# | Description | Inner/Outer |
|-------|-----------|-----------------|-------------|
| 18711 | 24CLEVCRB | 24" Clear Vials | 1/16 |
| 18715 | 24CLEVGRB | 24" Green Vials | 1/16 |
| 18712 | 36CLEVCRB | 36" Clear Vials | 1/8 |
| 18716 | 36CLEVGRB | 36" Green Vials | 1/8 |
| 18713 | 42CLEVCRB | 42" Clear Vials | 1/8 |
| 18717 | 42CLEVGRB | 42" Green Vials | 1/8 |
| 18714 | 48CLEVCRB | 48" Clear Vials | 1/8 |
| 18718 | 48CLEVGRB | 48" Green Vials | 1/8 |

Crick Levels Care Kit

| EDI | Part# | Description | Inner/Outer |
|-------|-------|----------------|-------------|
| 11078 | 11078 | Level Care Kit | 1/16 |

Kit includes: 6 lenses, 12 lens clips, clip removal tool, 1 pint linseed oil, 1 hanging hook

Masonry Guides

- The most versatile corner pole system available
- Intended to be used with brick veneer, solid load bearing walls, and block work
- Poles and brackets are made out of high grade aluminum
- Kits are available with brackets for use with both inside and outside corners
- Quick to assemble and easy to align
- All poles are 9' tall
- Can ship via small parcel carrier
- Inner and outer pack quantities shown in table



MADE IN
U.S.A

MARSHALLTOWN The Premier Line

| EDI | Part# | Description | Size-in. | Size-mm | Inner/Outer |
|-------|-------|----------------------------|----------|---------|-------------|
| 14908 | 4908 | Inside Guide Assy. | 108 | 2,743 | 1/1 |
| 14910 | 4910 | Line Holder (Inside Assy.) | NA | NA | 6/36 |
| 14911 | 4911 | Top Sliding Bracket | NA | NA | 6/36 |
| 14912 | 4912 | Bottom Outside Corner | NA | NA | 6/36 |
| 14913 | 4913 | Top Outside Corner | NA | NA | 6/36 |
| 14914 | 4914 | Bottom Inside Corner | NA | NA | 6/36 |
| 14915 | 4915 | Top Inside Corner | NA | NA | 6/36 |

Braided Nylon Mason's Line

- Size #18
- ML591 thru ML604 have a 4" (102mm) core; succeeding part numbers have a 6" (152mm) core
- Will not unravel if struck by a trowel
- Not affected by extreme moisture or dryness
- Won't mildew and it stays taut
- Inner/outer pack quantities shown in table



MARSHALLTOWN The Premier Line

| EDI | Part# | Description | Inner/Outer |
|-------|-------|-------------------------|-------------|
| 10239 | ML591 | 125' (38M) White | 1/24 |
| 10240 | ML592 | 125' (38M) Yellow | 1/24 |
| 10246 | ML598 | 250' (76M) White | 1/12 |
| 10247 | ML599 | 250' (76M) Yellow | 1/12 |
| 10251 | ML601 | 250' (76M) Fl. Pink | 1/12 |
| 10252 | ML602 | 250' (76M) Fl. Orange | 1/12 |
| 10253 | ML603 | 250' (76M) Fl. Green | 1/12 |
| 10255 | ML604 | 250' (76M) Fl. Yellow | 1/12 |
| 16572 | 622 | 250' (76M) White | 1/48 |
| 10256 | ML605 | 250' (76M) Yellow | 1/24 |
| 10257 | ML606 | 250' (76M) Green | 1/24 |
| 16581 | 631 | 250' (76M) Fl. Pink | 1/24 |
| 10258 | ML607 | 250' (76M) Fl. Orange | 1/24 |
| 16582 | 632 | 250' (76M) Fl. Yellow | 1/24 |
| 16573 | 623 | 500' (152M) White | 1/24 |
| 16574 | 624 | 500' (152M) Yellow | 1/24 |
| 16576 | 626 | 500' (152M) Green | 1/24 |
| 10840 | ML340 | 500' (152M) Fl. Pink | 1/24 |
| 10839 | ML339 | 500' (152M) Fl. Yellow | 1/24 |
| 10838 | ML338 | 500' (152M) Fl. Orange | 1/24 |
| 10841 | ML341 | 500' (152M) Fl. Green | 1/24 |
| 16575 | 625 | 1000' (305M) White | 1/12 |
| 16578 | 628 | 1000' (305M) Yellow | 1/12 |
| 16577 | 627 | 1000' (305M) Green | 1/12 |
| 10260 | ML609 | 1000' (305M) Fl. Pink | 1/12 |
| 10261 | ML610 | 1000' (305M) Fl. Orange | 1/12 |
| 10262 | ML611 | 1000' (305M) Fl. Green | 1/12 |
| 10263 | ML612 | 1000' (305M) Fl. Yellow | 1/12 |

Twisted Nylon Mason's Line

- Size #18
- **ML566** thru **ML571** have a 4" (102mm) core; succeeding part numbers have a 6" (152mm) core
- "Heat-set" after winding to stabilize
- Not affected by mortar, oil, or mildew and will not absorb water
- Inner and outer pack quantities shown in table



MARSHALLTOWN The Premier Line

| EDI | Part# | Description | Inner/Outer |
|-------|-------|-------------------------|-------------|
| 10201 | ML566 | 250' (76M) White | 1/12 |
| 10202 | ML567 | 250' (76M) Yellow | 1/12 |
| 10204 | ML569 | 250' (76M) Fl. Pink | 1/12 |
| 10205 | ML570 | 250' (76M) Fl. Orange | 1/12 |
| 10207 | ML571 | 250' (76M) Fl. Green | 1/12 |
| 16570 | 620 | 285' (87M) White | 1/48 |
| 16571 | 621 | 285' (87M) Yellow | 1/48 |
| 10217 | ML577 | 285' (87M) Fl. Yellow | 1/48 |
| 10218 | ML578 | 500' (152M) White | 1/24 |
| 10219 | ML579 | 500' (152M) Yellow | 1/24 |
| 10221 | ML581 | 500' (152M) Fl. Pink | 1/24 |
| 10222 | ML582 | 500' (152M) Fl. Orange | 1/24 |
| 10223 | ML583 | 500' (152M) Fl. Green | 1/24 |
| 10224 | ML584 | 500' (152M) Fl. Yellow | 1/24 |
| 16586 | 629 | 1000' (305M) White | 1/12 |
| 10225 | ML585 | 1000' (305M) Yellow | 1/12 |
| 10229 | ML587 | 1000' (305M) Fl. Pink | 1/12 |
| 10231 | ML588 | 1000' (305M) Fl. Orange | 1/12 |
| 10233 | ML589 | 1000' (305M) Fl. Green | 1/12 |
| 10238 | ML590 | 1000' (305M) Fl. Yellow | 1/12 |

Bonded Mason's Line

- Bonded and braided for greater durability
- Not affected by mortar, oil, or mildew and will not absorb water
- Core size is 6" (152mm)
- Sold 1 per inner pack/12 per outer pack



MARSHALLTOWN The Premier Line

| EDI | Part# | Description | Size |
|-------|-------|----------------------------|------|
| 16588 | 635 | 500' (152M) White & Black | 18 |
| 10264 | ML613 | 500' (152M) Yellow & Black | 18 |
| 10265 | ML614 | 500' (152M) Orange & Black | 18 |
| 10266 | ML615 | 500' (152M) Pink & Black | 18 |
| 10267 | ML616 | 500' (152M) White & Black | 21 |
| 10268 | ML617 | 500' (152M) Yellow & Black | 21 |
| 10269 | ML618 | 500' (152M) Orange & Black | 21 |

Refillable Stake Mason's Line Winder

- Winder can be driven into the ground to allow for hands free use
- Made of durable high-density polyethylene
- Can be refilled with any length or type of mason's line that is wound onto a 6" (152mm) core
- **SLW66FO** comes with 500' (152M) #18 twisted mason's line
- **SLW66FY** comes with 500' (152M) #18 braided mason's line
- Sold 10 per inner pack/10 per outer pack, 18 per inner pack/18 per outer pack where noted with *

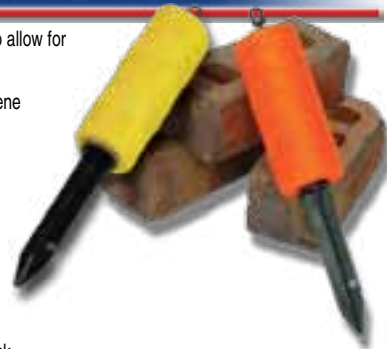

MADE IN U.S.A

MARSHALLTOWN The Premier Line

| EDI | Part# | Description |
|-------|---------|---|
| 16066 | SLW66* | Stake Line Winder |
| 16067 | SLW66FO | Stake Line Winder w/Mason's line Orange |
| 16060 | SLW66FY | Stake Line Winder w/Mason's line Yellow |

Mason's Line Winder

- Plastic winder
- #18 braided orange mason's line
- Handle is tapered
- Sold 6 per inner pack/6 per outer pack



MADE IN U.S.A

MARSHALLTOWN The Premier Line

| EDI | Part# | Description |
|-------|-------|-------------------|
| 16584 | 634 | 250' (76M) Orange |

Mason's Line Winder with Handle

- Contains 250' (76M) of 100% braided orange nylon
- Line is size #18 and 150 lb. (68kg) test
- Special plastic winder comes with a metal cut-off blade
- Sold 1 per inner pack/36 per outer pack



MADE IN U.S.A

MARSHALLTOWN The Premier Line

| EDI | Part# | Description |
|-------|-------|-------------------|
| 16132 | 921 | 250' (76M) Orange |

Line Stretchers

- Stretches mason's line between blocks
- Made from cast aluminum
- Sold 1 pair per inner pack/6 pairs per outer pack



MARSHALLTOWN The Premier Line

| EDI | Part# | Size-in. | Size-mm |
|-------|-------|----------|---------|
| 16499 | LS24 | 2-4 | 51-102 |
| 16500 | LS46 | 4-6 | 102-152 |
| 16501 | LS68 | 6-8 | 152-203 |
| 16502 | LS810 | 8-10 | 203-254 |
| 16503 | LS812 | 8-12 | 203-305 |

Adjustable Line Stretchers

- Stretches mason's line between key course blocks
- Fully adjustable from 4 to 12" (102 to 305mm)
- Made from cast aluminum
- 1 pair per bag
- Sold 6 bags per inner pack, 60 bags per outer pack



QLT^{BY} MARSHALLTOWN

| EDI | Part# | Size-in. | Size-mm |
|-------|--------|----------|---------|
| 16504 | ALS504 | 4-12 | 102-305 |

Rock Face Line Stretchers

- Stretches mason's line between blocks
- Made from cast aluminum
- 1 pair per bag
- Sold 6 bags per inner pack, 6 bags outer pack

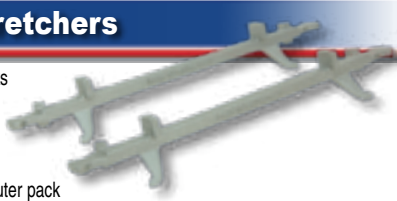

QLT^{BY} MARSHALLTOWN

| EDI | Part# | Size-in. | Size-mm |
|-------|-------|----------|---------|
| 16650 | 16650 | 8-12 | 203-305 |

Wood Line Blocks

- Shaped from poplar hardwood
- Sold 1 pair per inner pack/180 pair per outer pack



MADE IN
U.S.A.

MARSHALLTOWN The Premier Line

| EDI | Part# | Size-in. | Size-mm |
|-------|-------|----------|---------|
| 16506 | 86 | 3/4 | 95 |

Plastic Line Blocks

- Bright yellow plastic is highly visible and impervious to water
- Included are 4 plastic line twigs, 2 pair of blocks
- Twigs keep mason's line from sagging
- Sold 1 set per inner pack/170 sets per outer pack



MARSHALLTOWN The Premier Line

| EDI | Part# | Size-in. | Size-mm |
|-------|-------|-----------|----------|
| 16508 | 86P | 5 X 2 1/4 | 127 x 57 |

Corner Line Blocks

- Made of cast aluminum for strength
- Will not rust
- Long stem allows blocks to be moved easily
- Slot in fork guides mason's line
- Large square and sturdy surface holds to wall
- Sold 1 pair per inner pack/6 pairs per outer pack



QLT^{BY} MARSHALLTOWN

| EDI | Part# | Size-in. | Size-mm |
|-------|-------|----------|---------|
| 16507 | CB507 | N/A | N/A |

Line Twigs

- Used to hold line and maintain straightness during brick/block laying
- Made of steel
- 14 twigs per bag, 1 per inner pack/200 bags per outer pack



MADE IN
U.S.A.

MARSHALLTOWN The Premier Line

| EDI | Part# | Size-in. | Size-mm |
|-------|-------|----------|---------|
| 16509 | 16509 | N/A | N/A |

Line Pins

- Made of tempered zinc plated steel for increased durability
- Tapered ends allow easier insertion
- 4 line pins per bag
- 4 1/4" (108mm) long
- Sold 1 per inner pack/1 per outer pack



MADE IN
U.S.A.

MARSHALLTOWN The Premier Line

| EDI | Part# | Size-in. | Size-mm |
|-------|-------|----------|---------|
| 11735 | 11735 | 4 1/4 | 108 |

Rhino Rulers®

- Made of washable fiberglass with easy-to-close folding joint design
- Permanent scales are weather resistant
- Available in 4 different scales: brick spacing, oversized brick spacing, modular spacing and engineer's scale
- Sold 6 per inner pack/72 per outer pack



MARSHALLTOWN The Premier Line

| EDI | Part# | Description | Size-in. |
|-------|-------|-------------------------|----------|
| 16645 | 6645 | Engineer's Scale | 72 |
| 16646 | 6646 | Brick Spacing | 72 |
| 16647 | 6647 | Oversized Brick Spacing | 72 |
| 16648 | 6648 | Mason's Modular Spacing | 72 |

Tape Measures

- Soft feel grip
- Self retracting
- Wide belt clip
- Auto locking mechanism
- Push button to retract tape
- Sold 1 per inner pack/1 per outer pack



QLTSM MARSHALLTOWN

| EDI | Part# | Description | Length |
|-------|-------|-----------------------|--------|
| 10516 | 10516 | Standard Tape Measure | 25' |
| 12986 | BST16 | Brick Spacing | 16' |
| 12987 | MST16 | Modular Spacing | 16' |
| 15096 | 15096 | Canadian Spacing | 16' |

Plastic Bristle Stucco Dash Brush

- Wood block with 8" (203mm) long handle
- Yellow plastic bristles are 5½" (140mm) long
- 10 rows of bristles, 5 rows deep
- Sold 1 per inner pack/12 per outer pack



MADE IN U.S.A.

MARSHALLTOWN The Premier Line

| EDI | Part# | Size-in. | Size-mm |
|-------|-------|----------|----------|
| 16556 | 6556 | 5½ X 3 | 146 X 76 |

Bassine Bristle Stucco Dash Brush

- Wood block with 8" (254mm) long handle
- Brown bassine bristles are 4" (102mm) long
- 10 rows of bristles, 5 rows deep
- Sold 1 per inner pack/12 per outer pack



MADE IN U.S.A.

MARSHALLTOWN The Premier Line

| EDI | Part# | Size-in. | Size-mm |
|-------|-------|----------|----------|
| 16555 | 6555 | 6 X 3¾ | 152 X 86 |

Mason's Acid Brush

- Has 1¼" (32mm) long white Tampico fiber bristles set in a wax tumbled hardwood block
- Very densely filled to hold large amounts of acid solution
- Used with acid solutions for cleaning mortar from bricks
- Has a hole for any standard tapered broom handle
- Sold 1 per inner pack/12 per outer pack



MADE IN U.S.A.

MARSHALLTOWN The Premier Line

| EDI | Part# | Size-in. | Size-mm |
|-------|-------|----------|----------|
| 16526 | 6526 | 8¼ X 3 | 210 X 76 |

Deck Scrub Brush

- White Tampico fiber or polypropylene bristles set in smooth tumbled hardwood block
- Has one tapered and one threaded handle hole
- Can be used with acid solution to scrub mortar off newly laid brick and block
- Sold 1 per inner pack/12 per outer pack

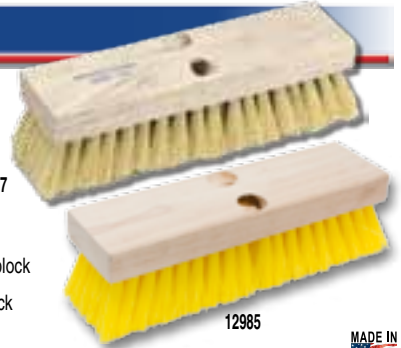

MADE IN U.S.A.

MARSHALLTOWN The Premier Line

| EDI | Part# | Description | Size-in. | Size-mm |
|-------|-------|------------------------|----------|----------|
| 16527 | 6527 | Tampico Fiber Bristles | 10 X 2¾ | 254 X 73 |
| 12985 | 12985 | Polypropylene Bristles | 10 X 3¼ | 254 X 79 |

Heavy Gauge White Plastic Brush

- Durable long lasting plastic outlasts natural fiber
- For wet or dry sweeping requiring a rugged broom
- Will not absorb odors, mildew, rot, or discolor.
- Will not absorb water and rinses clean
- Wide flare on ends allow for close sweeping
- Sold 1 per inner pack/1 per outer pack



MADE IN U.S.A.

MARSHALLTOWN The Premier Line

| EDI | Part# | Size-in. | Size-mm |
|-------|-------|----------|----------|
| 12162 | 2162 | 16 X 3½ | 406 X 89 |

Standard Tapered Handle

- Made of #1 straight-grained hardwood that is sanded smooth
- Has one rounded end and one tapered end
- Recommended for use with any of our brushes requiring push-in handles
- Sold 1 per inner pack/12 per outer pack



MADE IN U.S.A.

MARSHALLTOWN The Premier Line

| EDI | Part# | Size-in. | Size-mm | Diameter |
|-------|-------|----------|---------|-----------|
| 14844 | 4844 | 60 | 1524 | 1½ (29mm) |

Utility Scrub Brushes

- White Tampico bristles set in high-tensile strength foam plastic block
- Will not absorb water
- Sold 1 per inner pack/12 per outer pack



MADE IN
U.S.A.

MARSHALLTOWN The Premier Line

| EDI | Part# | Size-in. | Size-mm |
|-------|-------|----------|---------|
| 16522 | 6522 | 8 | 203 |
| 16525 | 6525 | 20 | 508 |

Acid Brushes

- Bristles made with Tampafil plastic set in high-tensile strength foam plastic block
- Recommended for use in acid solutions to clean mortar from bricks and concrete from wood or metal forms and tools
- Sold 1 per inner pack/12 per outer pack



MADE IN
U.S.A.

MARSHALLTOWN The Premier Line

| EDI | Part# | Size-in. | Size-mm |
|-------|-------|----------|---------|
| 16523 | 6523 | 8 | 203 |
| 16524 | 6524 | 20 | 508 |

Extra Heavy Duty Acid Brush

- Has 3" (76mm) long Tampico and stiff Palmyra fibers cemented and bound into hardwood block
- 15" (381mm) tapered hardwood handle sold separately
- #4844 handle will also fit (see page 28, sold separately)
- Sold 1 per inner pack/12 per outer pack



MADE IN
U.S.A.

MARSHALLTOWN The Premier Line

| EDI | Part# | Description | Size-in. | Size-mm |
|-------|-------|-------------|----------|-----------|
| 16528 | 6528 | Brush | 8 X 6 | 203 X 152 |
| 16529 | 6529 | Handle | 15 | 381 |

Masonry Brush

- Bristles made of white Tampico fiber
- 3 1/2" (89mm) bristles are set securely in hardwood block
- Sold 1 per inner pack/12 per outer pack



MADE IN
U.S.A.

MARSHALLTOWN The Premier Line

| EDI | Part# | Size-in. | Size-mm |
|-------|-------|---------------|----------|
| 16520 | 829 | 6 1/2 X 1 3/4 | 165 X 44 |

Bucket Brush

- The 521 is made of four rows of 3 1/2" (89mm) long white Tampico bristles, the 521P is made of four rows of 3 1/2" (89mm) long almond colored polypropylene bristles
- 6" (152mm) plastic handle with hang clip to hook on side of bucket
- Plastic block is 6 X 3 3/4" (152 x 19mm)
- Sold 12 per inner pack/12 per outer pack



MADE IN
U.S.A.

MARSHALLTOWN The Premier Line

| EDI | Part# | Size-in. | Size-mm |
|-------|-------|----------|----------|
| 16521 | 521 | 6 X 3/4 | 152 X 19 |
| 10498 | 521P | 6 X 3/4 | 152 X 19 |

Beavertail Brush

- 2 5/8" (67mm) bristles staple set in clear lacquered hardwood block
- 6519 has long black Tampico fibers, 6517 has black horsehair fibers
- Ideal for finishing concrete curbs
- Sold 1 per inner pack/12 per outer pack



MADE IN
U.S.A.

MARSHALLTOWN The Premier Line

| EDI | Part# | Size-in. | Size-mm |
|-------|-------|----------|---------|
| 16519 | 6519 | 13 1/2 | 343 |
| 16517 | 6517 | 13 1/2 | 343 |

Steel Wire Whisk

- Round carbon steel wire
- Staple set in a smooth hardwood block
- 2 5/8" (67mm) trim
- Bristles set - 4 rows x 8 rows
- Sold 1 per inner pack/12 per outer pack



MADE IN
U.S.A.

MARSHALLTOWN The Premier Line

| EDI | Part# | Size-in. | Size-mm |
|-------|-------|-----------|----------|
| 12984 | 2984 | 9 5/8 X 3 | 244 X 76 |

Brooms & Dust Pans

- For details and size options **see pages 99-100**



Floor Scrapers

- 60 X 1 1/8" (1524 X 28mm) steel handle securely welded to heavy angle iron bracket
- Blade is heavy gauge spring steel
- Plastic grip on handle to protect hands
- This durable scraper is the perfect clean-up tool
- Replacement blades available
- Sold 6 per inner pack/6 per outer pack

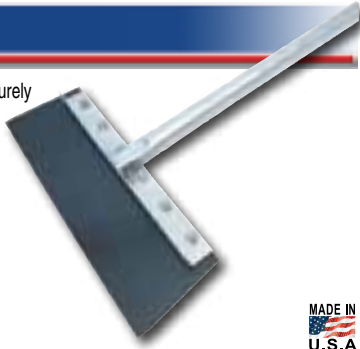

MADE IN
U.S.A

MARSHALLTOWN The Premier Line

| EDI | Part# | Description | Size-in. | Size-mm |
|-------|-------|---------------|------------|-----------|
| 12127 | 420 | Floor Scraper | 9 X 4 1/2 | 229 X 114 |
| 12129 | 420B | Repl. Blade | 9 X 4 1/2 | 229 X 114 |
| 16453 | 720 | Floor Scraper | 14 X 4 1/2 | 356 X 114 |
| 16454 | 720B | Repl. Blade | 14 X 4 1/2 | 356 X 114 |
| 16398 | 820 | Floor Scraper | 20 X 4 1/2 | 508 X 114 |
| 16399 | 820B | Repl. Blade | 20 X 4 1/2 | 508 X 114 |

Turtle Back Sponge

- Great general purpose cellulose sponge
- Shape conforms to hand
- Sold 24 per inner pack/24 per outer pack



MADE IN
U.S.A

MARSHALLTOWN The Premier Line

| EDI | Part# | Size-in. | Size-mm |
|-------|-------|----------|---------|
| 16587 | 16587 | N/A | N/A |

Safety Gear

- For our complete line safety products
see pages 249-250



Bricklayer's Apprentice Tool Kit

- Tools included:
831 - Canvas Tool Bag
33 11FG - 11" (279mm) Brick Trowel, London Pattern
45 6D - 6 X 2 3/4" (152 X 70mm) Pointing Trowel
52D - 5 X 2" (127 x 51) Margin Trowel
80 - 1/2" & 5/8" (13 X 16mm) Brick Jointer
86 - Wood Line Blocks
921 - Mason's Line Winder with 250' (76M) braided line
6519 - Masonry Brush
93 - Joint Raker

- Sold 1 per inner pack/1 per outer pack



MADE IN
U.S.A

MARSHALLTOWN The Premier Line

| EDI | Part# | Size-in. | Size-mm |
|-------|-------|----------|---------|
| 15901 | BTK1 | N/A | N/A |

Bricklayer's Apprentice Tool Kit

- Tools included:
NB202 - Nylon Tool Bag
33 11FG - 11" (279mm) Brick Trowel, London Pattern
45 6D - 6 X 2 3/4" (152 X 70mm) Pointing Trowel
52D - 5 X 2" (127 x 51) Margin Trowel
80 - 1/2" & 5/8" (13 X 16mm) Brick Jointer
86 - Wood Line Blocks
921 - Mason's Line Winder with 250' (76M) braided line
6519 - Masonry Brush
93 - Joint Raker

- Sold 1 per inner pack/1 per outer pack



MADE IN
U.S.A

MARSHALLTOWN The Premier Line

| EDI | Part# | Size-in. | Size-mm |
|-------|-------|----------|---------|
| 16204 | BTK2 | N/A | N/A |



Few companies can state they have been a trusted name in the construction industry for over **100 years**. Since 1911, Gilson Mixers have been serving brick masons, concrete contractors, as well as a variety of industrial customers with a reputation of unmatched quality and design. From our Quad-Mixing System to our 6/2 paddle design, every Gilson Mixer we make has the engineering, power and performance to produce a “Batch a Minute”.

Purchased by the Marshalltown Company in 2010, another manufacturer with well over **100 years** of experience in the construction field, Gilson is one of the last remaining lines of mixers that is **Made in the USA**. Manufactured completely by MARSHALLTOWN in Fayetteville, Arkansas, Gilson Mixers are as tough and rugged as the people that use them. Using a combination of thick walled drums, a structural steel design, and heavy-duty gears and pulleys, Gilson Mixers will hold up to the daily use and abuse of one of the harshest places in the world – the jobsite.

With Gilson’s legacy, backed by MARSHALLTOWN’s leadership position in the industry, you can expect nothing but the finest, longest lasting, **best built** mixer to show up at your jobsite. Competitively priced and over built, your Gilson Mixer is something to be proud of – we are.

BATCH A MINUTE

A heavy duty mixer isn’t worth much if it can’t perform. Gilson Mixers are not only built like a tank, they have the speed and performance of a fighter jet. We combine unique blade and paddle designs, along with precise drum and paddle speeds to produce “Batch a Minute” results.

BATCH DESCRIPTIONS:

- 2 Bag Batch: 2 bags of mortar mix, 6 cubic feet* of sand, and 10-12 gallons of water
- 3 Bag Batch: 3 bags of mortar mix, 9 cubic feet* of sand, and 15-18 gallons of water
- 4 Bag Batch: 4 bags of mortar mix, 12 cubic feet* of sand, and 20-24 gallons of water

*Note: 3 cubic feet of sand equals four 5-gallon pails filled to the top with sand

| | # of Bags | Size of Mixer | Model |
|----------------|-------------|---------------|---------|
| Concrete | Quarter Bag | 3 cu ft | 300UT |
| | Half Bag | 6 cu ft | 600CM |
| Mortar/Plaster | 2 Bags | 8 cu ft | 800MP |
| | 4 Bags | 12 cu ft | 1200 MP |
| | 4 Bags | 12 cu ft | 1220 MP |
| | 5 Bags | 16 cu ft | 1620 MP |



**UNMATCHED PERFORMANCE
AND JOBSITE PROVEN.**

Steel Drum Utility Mixer

- Quality Utility Mixer perfect for batching concrete, mixing seed and feed, as well as numerous industrial applications
- Convenient drum lock secures the drum in one-of-five positions
- Well-balanced tilt handle
- Welded steel frame and heavy bushings for long, dependable life
- Precision cast, one-piece ring gear
- Sold with 1/3 HP or 1/2 HP electric motors, 3.5 HP Honda engine, or without power
- Quad-Mixing System utilizes a four-piece, replaceable paddle and blade combination that creates four different mixing patterns for a more consistent mix
- Hand or high-speed tow kits available (See page 38)
- All mixers produce 1 batch per minute
- Drum opening of 15 1/4" (381mm)
- Discharge height of 20" (508mm)
- 25 RPM drum rotation



PROUDLY MADE
IN THE U.S.A.

300UT Series

| EDI | Part# | Description | Power | Weight |
|-------|-----------|---|-------------|--------|
| 23647 | MIX59015C | Stationary, No Power | N/A | 171 |
| 27248 | MIX62002 | Stationary w/ Power, Motor NOT Assembled | 1/3 HP Elec | 184 |
| 27240 | MIX61110 | Stationary, Motor Assembled | 1/3 HP Elec | 184 |
| 27100 | MIX59980 | Stationary, w/ On/Off Switch, Motor Assembled | 1/3 HP Elec | 185 |
| 27070 | MIX27070 | Hand Tow Kit, w/ Power, Fully Assembled | 1/3 HP Elec | 218 |
| 27246 | MIX62000 | Stationary w/ Power, Motor NOT Assembled | 1/2 HP Elec | 185 |
| 27242 | MIX61112 | Stationary, Motor Assembled | 1/2 HP Elec | 185 |
| 27101 | MIX59981 | Stationary, w/ On/Off Switch, Motor Assembled | 1/2 HP Elec | 186 |
| 27241 | MIX61111 | Hand Tow Kit, Fully Assembled | 1/2 HP Elec | 219 |
| 27247 | MIX62001 | Stationary, Gasoline Engine Assembled | 3.5 HP | 254 |

Motor Options - Steel & Poly Drum Utility Mixers

| EDI | Part# | Description |
|-------|----------|---------------------------------------|
| 23572 | MIX69002 | 1/3 HP Electric Motor Kit |
| 23579 | MIX69125 | 1/2 HP Electric Motor Kit |
| 27254 | MIX27254 | 3.5 HP Honda® Gasoline Engine w/ Hood |

Tow Kit Options - Steel & Poly Drum Utility Mixers

| EDI | Part# | Description |
|-------|----------|--|
| 23570 | MIX69000 | 2.75" W X 10" ID - Semi-Pneumatic Hand Tow Kit |
| 23581 | MIX69204 | 4.8" W X 12" ID - High Speed Tow Kit w/ Hitch |

| | 300UT |
|-----------------------------|--|
| Batch Size Dry Cubic Foot | 3 |
| Drum Volume Cubic Foot | 5.5 |
| Drum Dimensions | 24" dia. 15-1/4" opening 24.75" depth |
| Drum Drive | V-belt |
| Tilt Mechanism | Tilt handle |
| Frame Description | 1 1/2" Welded steel angle |
| Tow Pole | 1 1/4" Hand tow 2 3/8" High-speed |
| Hitch Description | Large grip hand tow 2" Ball coupler High-speed |
| Wheels & Tires | 4.8" X 8" Wheels 20" O.D. Tires |
| Overall Dimension L X W X H | 46" X 30" X 48" |
| Discharge Height | 20" |
| Power Options | 3.5 hp Honda 1/3 hp Electric 60 Hz 1/2 hp Electric 60 Hz |

Poly Drum Utility Mixer

- Quality Utility Mixer perfect for batching concrete, mixing seed and feed, as well as numerous industrial applications
- FDA / NSF / USDA approved non-stick polyethylene drum
- Convenient drum lock secures the drum in one-of-five positions
- Well-balanced tilt handle
- Welded steel frame and heavy bushings for long, dependable life
- Precision cast, one-piece ring gear
- Sold with 1/3 HP or 1/2 HP electric motors, 3.5 HP Honda engine, or without power
- Sturdy, in-mold mixing blades
- Hand or high-speed tow kits available (See page 38)
- All mixers produce 1 batch per minute
- Drum opening of 15 1/4" (381mm)
- Discharge height of 20" (508mm)
- 25 RPM drum rotation



MIX59016A
w/Hand Tow Kit



300UT-PL Series

| EDI | Part# | Description | Power | Weight |
|-------|-----------|---|-------------|--------|
| 23648 | MIX59016A | Stationary, No Power | N/A | 165 |
| 27249 | MIX62011 | Stationary w/ Power, Motor NOT Assembled | 1/3 HP Elec | 178 |
| 27071 | MIX27071 | Stationary, Motor Assembled | 1/3 HP Elec | 178 |
| 27110 | MIX59990 | Stationary, w/ On/Off Switch, Motor Assembled | 1/3 HP Elec | 179 |
| 27243 | MIX61113 | Hand Tow Kit, w/ Power, Fully Assembled | 1/3 HP Elec | 212 |
| 27250 | MIX62003 | Stationary w/ Power, Motor NOT Assembled | 1/2 HP Elec | 179 |
| 27245 | MIX61115 | Stationary, Motor Assembled | 1/2 HP Elec | 179 |
| 27251 | MIX62004 | Stationary, w/ On/Off Switch, Motor Assembled | 1/2 HP Elec | 180 |
| 27244 | MIX61114 | Hand Tow Kit, Fully Assembled | 1/2 HP Elec | 213 |
| 27252 | MIX62005 | Stationary, Gasoline Engine Assembled | 3.5 HP | 248 |

Other Options

| EDI | Part# | Description |
|-------|--------------|----------------------------------|
| 23684 | MIX771-40257 | 3 cu. ft. Replacement Poly Liner |
| 21684 | MIX245007 | Disposable Lid |

| | 300UT-PL |
|-----------------------------|--|
| Batch Size Dry Cubic Foot | 3 |
| Drum Volume Cubic Foot | 5.5 |
| Drum Dimensions | 24" dia. 15-1/4" opening 28" depth |
| Drum Drive | V-belt |
| Tilt Mechanism | Tilt handle |
| Frame Description | 1 1/2" Welded steel angle |
| Tow Pole | 1 1/4" Hand tow 2 3/8" High-speed |
| Hitch Description | Large grip hand tow 2" Ball coupler High-speed |
| Wheels & Tires | 4.8" X 8" Wheels 20" O.D. Tires |
| Overall Dimension L X W X H | 46" X 30" X 48" |
| Discharge Height | 20" |
| Power Options | 3.5 hp Honda 1/3 hp Electric 60 Hz 1/2 hp Electric 60 Hz |

Steel Drum Concrete Mixers

- 6 Cubic foot mixing capacity
- Reinforced square tubular frame with a welded steel yoke
- Wheel and hand brake tilting mechanism
- Drum tilt wheel rotates the drum in infinite mixing positions – moves in the same direction as the drum
- Frictional hand brake locks the drum in place at any position
- Cast iron ring gear and tapered roller bearings for smooth performance
- Quad-Mixing System utilizes a four-piece, replaceable paddle and blade combination that creates four different mixing patterns for a more consistent mix
- High-speed tow kit standard with 13" (330mm) wheels and 25" (635mm) O.D. tires
- Discharge height of 25" (635mm)
- Drum opening of 18" (457mm)
- 25 RPM drum rotation
- Steel "U" spring suspension
- Choose between 2" ball or pintle-style hitch



PROUDLY MADE
IN THE U.S.A.

QUAD MIXING SYSTEM



600CM Series with 2" Ball Hitch

| EDI | Part# | Description | Power | Weight |
|-------|-----------|--|-------------|--------|
| 27256 | MIX59289B | Concrete Mixer Fully Assembled | 8 HP | 980 |
| 27257 | MIX59292B | Concrete Mixer Fully Assembled | 1.5 HP Elec | 861 |
| 27273 | MIX62006B | Concrete Mixer Fully Assembled With On/Off Switch | 1.5 HP Elec | 861 |

600CM Series with Pintle Style Hitch

| EDI | Part# | Description | Power | Weight |
|-------|----------|--|-------------|--------|
| 21488 | MIX59289 | Concrete Mixer Fully Assembled | 8 HP | 980 |
| 21491 | MIX59292 | Concrete Mixer Fully Assembled | 1.5 HP Elec | 861 |
| 27253 | MIX62006 | Concrete Mixer Fully Assembled With On/Off Switch | 1.5 HP Elec | 861 |

| | 600CM |
|--------------------------------|---|
| Batch Size Dry Cubic Foot | 6 |
| Drum Volume Cubic Foot | 9.7 |
| Drum Dimensions | 30" dia., 18" opening 28 ³ / ₄ " depth |
| Steel Drum Gauge | 8 bottom, 10 side, 12 cone |
| Drum Drive | Gas-chain Electric-belt & chain |
| Tilt Mechanism | Tilt wheel and hand brake |
| Frame Description | Square tubing & structural channel |
| Tow Pole | 2 ³ / ₈ " tube |
| Wheels & Tires | 25" O.D. tires |
| Suspension | U spring |
| Overall Dimension L X W X H | 79" X 48" X 62" |
| Discharge Height | 25" |
| Power Options | 8 HP Honda 1.5 HP Electric |

Poly Drum Concrete Mixer

- 6 Cubic foot mixing capacity
- Steel drum encases the poly liner for added durability and can be quickly disassembled for replacement
- FDA / NSF / USDA approved non-stick polyethylene drum
- Sturdy in-mold mixing blades
- Reinforced square tubular frame with a welded steel yoke
- Wheel and hand brake tilting mechanism
- Drum tilt wheel rotates the drum to infinite mixing positions – moves in the same direction as the drum
- Frictional hand brake locks the drum in place at any position
- Cast iron ring gear and tapered roller bearings for smooth performance
- High-speed tow kit standard with 13" (330mm) wheels and 25" (635mm) O.D. tires
- Discharge height of 25" (635mm)
- Drum opening of 18" (457mm)
- 25 RPM drum rotation
- Steel "U" spring suspension
- Choose between 2" ball or pintle-style hitch



PROUDLY MADE
IN THE U.S.A.

WHEEL AND HAND BRAKE TILTING MECHANISM



600CM-PL Series with 2" Ball Hitch

| EDI | Part# | Description | Power | Weight |
|-------|-----------|---|-------------|--------|
| 27258 | MIX59402B | Concrete Mixer Fully Assembled | 8 HP | 1140 |
| 27259 | MIX59405B | Concrete Mixer Fully Assembled | 1.5 HP Elec | 1021 |
| 27274 | MIX59398B | Concrete Mixer Fully Assembled with On/Off Switch | 1.5 HP Elec | 1021 |

600CM-PL Series Pintle Style Hitch

| EDI | Part# | Description | Power | Weight |
|-------|----------|---|-------------|--------|
| 21497 | MIX59402 | Concrete Mixer Fully Assembled | 8 HP | 1140 |
| 21500 | MIX59405 | Concrete Mixer Fully Assembled | 1.5 HP Elec | 1021 |
| 22281 | MIX59398 | Concrete Mixer Fully Assembled with On/Off Switch | 1.5 HP Elec | 1021 |

Other Options

| EDI | Part# | Description |
|-------|-----------|----------------------------------|
| 21576 | MIX245881 | 6 Cu. Ft. Replacement Poly Liner |

| | 600CM-PL |
|-----------------------------|--|
| Batch Size Dry Cubic Foot | 6 |
| Drum Volume Cubic Foot | 8.8 |
| Drum Dimensions | 30" dia., 17 ¹ / ₂ " opening 28 ³ / ₄ " depth |
| Steel Drum Gauge | 8 bottom, 10 side |
| Drum Drive | Gas-chain Electric-belt & chain |
| Tilt Mechanism | Tilt wheel and hand brake |
| Frame Description | Square tubing & structural channel |
| Tow Pole | 2 ³ / ₈ " tube |
| Wheels & Tires | 25" O.D. tires |
| Suspension | U spring |
| Overall Dimension L X W X H | 79" X 48" X 62" |
| Discharge Height | 25" |
| Power Options | 8 HP Honda 1.5 HP Electric |

GILSON MIXERS

Mortar/Plaster Mixers

- 8 or 12 Cubic foot batch capacity
- 4/2 Paddle system – includes 4 drum scrapers and 2 end scrapers on opposed mixing arms for thorough mixing and less drum clean-up
- Aggressive mixing system with adjustable steel and rubber blades for a smooth, even mix
- Square shaft paddle design for less slipping and better efficiency
- Heavy steel drum grill with bag splitter
- Double belt drive with machined, cast iron pulleys
- Structural steel design
- Large drum capacity – perfect for any sized job
- High-speed tow kit comes standard
- "U" Spring suspension on 1200MP
- Discharge height of 23" (584mm)
- 30 RPM drum rotation
- Choose between 2" ball or pintle style hitch



U-Spring Suspension



See Video

4/2 PADDLE DESIGN



800MP Series with 2" Ball Hitch

| EDI | Part# | Description | Power | Weight |
|-------|------------|---------------------------|-----------|--------|
| 27272 | MIX59312AB | Fully Assembled w/Tow Kit | 3 HP Elec | 939 |
| 27271 | MIX59309AB | Fully Assembled w/Tow Kit | 8 HP | 986 |

800MP Series with Pintle Style Hitch

| EDI | Part# | Description | Power | Weight |
|-------|-----------|---------------------------|-----------|--------|
| 22930 | MIX59312A | Fully Assembled w/Tow Kit | 3 HP Elec | 939 |
| 22927 | MIX59309A | Fully Assembled w/Tow Kit | 8 HP | 986 |

1200MP Series with 2" Ball Hitch

| EDI | Part# | Description | Power | Weight |
|-------|-----------|---------------------------|-----------|--------|
| 27261 | MIX59334B | Fully Assembled w/Tow Kit | 3 HP Elec | 1050 |
| 27260 | MIX59328B | Fully Assembled w/Tow Kit | 8 HP | 1101 |

1200MP Series with Pintle Style Hitch

| EDI | Part# | Description | Power | Weight |
|-------|----------|---------------------------|-----------|--------|
| 22251 | MIX59334 | Fully Assembled w/Tow Kit | 3 HP Elec | 1103 |
| 22247 | MIX59328 | Fully Assembled w/Tow Kit | 8 HP | 1150 |

| | 800MP | 1200MP |
|-----------------------------|-------------------------------------|--|
| Batch Size Dry Cubic Foot | 8 | 12 |
| Drum Volume Cubic Foot | 9.8 | 15.3 |
| Batch Capacity (Bags) | 2 | 4 |
| Drum Dimensions | 34" X 24" | 36" X 30" |
| Drum Thickness | 12 ga. Wrap 3/16" Ends | 10 ga. Wrap 1/4" Ends |
| Bearing/Seal | Roller bearings w/ triple seal | Roller bearings w/ drum & shaft seals |
| Clutch Mechanism | Idler pulley | Pivoting engine mount |
| Power Reduction | 6:1 Reduction; belt to gears | 6:1 Reduction; belt to gears |
| Tow Pole | 2 3/8" Tube | 2 7/8" Tube |
| Suspension | N/A | "U" Spring |
| Wheels & Tires | 6.5" X 13" Wheels 25" O.D. Tires | 6.5" X 13" Wheels 25" O.D. Tires |
| Overall Dimension L X W X H | 79" X 50" X 56" | 83" X 54" X 59" |
| Discharge Height | 23" | 23" |
| Power Options | 8HP Honda 3HP Electric | 8HP Honda 3HP Electric |

Mortar/Plaster Mixer - Hydraulic Drive

- 12 or 16 Cubic foot batch capacity
- 4/2 Paddle system – includes 4 drum scrapers and 2 end scrapers on opposed mixing arms for thorough mixing and less drum clean-up
- 1620MP has 6/2 paddle system - 6 drum scrapers and 2 end scrapers
- Aggressive mixing system with adjustable steel and rubber blades for a smooth, even mix
- Square shaft paddle design for less slipping and better efficiency
- Heavy steel drum grill with bag splitter
- Structural steel design
- Hydraulic direct drive featuring hydraulic controls on the front of the mixer
- Large drum capacity – perfect for any sized job
- High-speed tow kit comes standard
- “U” Spring suspension
- Ram dump mechanism hydraulically tilts drum for effortless batch dumping
- For convenience and safety, the reversible paddle direction allows the paddles to rotate in the opposite direction to help break free from a jam
- Discharge height of 23" (584mm)
- 30 RPM drum rotation
- Choose between 2" ball or pintle style hitch



Hydraulic Direct Drive

PROUDLY MADE
IN THE U.S.A.

1220MP Series with 2" Ball Hitch

| EDI | Part# | Description | Power | Weight |
|-------|-----------|--|-----------|--------|
| 27263 | MIX59358B | Hydraulic Drive, 1 Phase Electric | 5 HP Elec | 1165 |
| 27264 | MIX59359B | Hydraulic Drive, 3 Phase Electric | 5 HP Elec | 1165 |
| 27262 | MIX59353B | Hydraulic Drive, Fully Assembled | 13 HP | 1210 |
| 27265 | MIX59362B | Hydraulic Drive and RAM Dump, Honda® Motor | 13 HP | 1225 |

1220MP Series with Pintle Style Hitch

| EDI | Part# | Description | Power | Weight |
|-------|----------|--|-----------|--------|
| 22260 | MIX59358 | Hydraulic Drive, 1 Phase Electric | 5 HP Elec | 1165 |
| 22261 | MIX59359 | Hydraulic Drive, 3 Phase Electric | 5 HP Elec | 1165 |
| 22256 | MIX59353 | Hydraulic Drive, Fully Assembled | 13 HP | 1210 |
| 22263 | MIX59362 | Hydraulic Drive and RAM Dump, Honda® Motor | 13 HP | 1225 |

1620MP Series with 2" Ball Hitch

| EDI | Part# | Description | Power | Weight |
|-------|-----------|--|-----------|--------|
| 27267 | MIX59387B | Hydraulic Drive, 1 Phase Electric | 5 HP Elec | 1350 |
| 27269 | MIX59389B | Hydraulic Drive, 3 Phase Electric | 5 HP Elec | 1350 |
| 27268 | MIX59388B | Hydraulic Drive, Fully Assembled | 13 HP | 1405 |
| 27270 | MIX59390B | Hydraulic Drive and RAM Dump, Honda® Motor | 13 HP | 1420 |

1620MP Series with Pintle Style Hitch

| EDI | Part# | Description | Power | Weight |
|-------|----------|--|-----------|--------|
| 22275 | MIX59387 | Hydraulic Drive, 1 Phase Electric | 5 HP Elec | 1350 |
| 22277 | MIX59389 | Hydraulic Drive, 3 Phase Electric | 5 HP Elec | 1350 |
| 22276 | MIX59388 | Hydraulic Drive, Fully Assembled | 13 HP | 1405 |
| 22278 | MIX59390 | Hydraulic Drive and RAM Dump, Honda® Motor | 13 HP | 1420 |

| | 1220MP | 1620MP |
|-----------------------------|--|---|
| Batch Size Dry Cubic Foot | 12 | 16 |
| Drum Volume Cubic Foot | 15.3 | 17.7 |
| Batch Capacity (Bags) | 4 | 5 |
| Drum Dimensions | 36" X 30" | 42" X 30" |
| Drum Thickness | 10 ga. Wrap 1/4" Ends | 7 ga. Wrap 1/4" Ends |
| Bearing/Seal | Roller bearings w/ drum & shaft seals | Roller bearings w/ drum & shaft seals |
| Clutch Mechanism | Hydraulic | Hydraulic |
| Power Reduction | Hydraulic | Hydraulic |
| Tow Pole | 2 7/8" Tube | 2 7/8" Tube |
| Suspension | "U" Spring | "U" Spring |
| Wheels & Tires | 6.5" X 13" Wheels 25" O.D. Tires | 6.5" X 13" Wheels 25" O.D. Tires |
| Overall Dimension L X W X H | 83" X 54" X 59" | 89" X 54" X 59" |
| Discharge Height | 23" | 23" |
| Power Options | 13HP Honda 5HP Electric | 13HP Honda 5HP Electric |

300UT & 300UT-PL Accessories

HAND TOW KIT

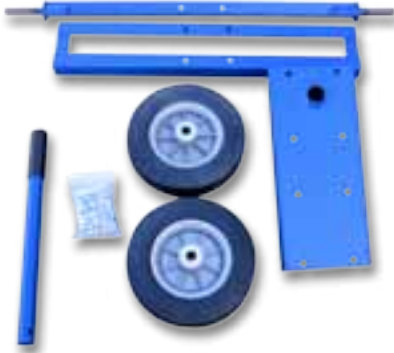

HIGH-SPEED TOW KIT



POLY LINER



300UT & 300UT-PL Tow Kit Options

| EDI | Part# | Description |
|-------|----------|--|
| 23570 | MIX69000 | 2.75" W X 10" ID - Semi-Pneumatic Hand Tow Kit |
| 23581 | MIX69204 | 4.8" W X 12" ID - High Speed Tow Kit w/ Hitch |

300UT-PL Options

| EDI | Part# | Description |
|-------|--------------|----------------------------------|
| 23684 | MIX771-40257 | 3 cu. ft. Replacement Poly Liner |
| 21684 | MIX245007 | Disposable Lid |

Wheelbarrow Mixer

- Lightweight portable mixer only weighs 125 lbs.
- 3 cubic foot drum
- Capable of mixing 1.5 - 80lb bags of concrete
- High torque 1/2 HP electric motor with ON/OFF switch
- Strong polyurethane drum will not crack or rust and is easy to clean
- Ring gear is enclosed for safe operation
- Handles adjust for easy storage
- Can clear a 30" (762mm) door opening
- Ships unassembled in one box



Wheelbarrow Mixer

Mixer w/Motor Attached

| EDI | Part# | Description |
|-------|-----------|--|
| 21737 | MIX59000D | 3.5 cu. ft. Load Capacity w/ Poly Liner, 1/2 HP Electric Motor & On/Off Switch |



See Video

When a better trowel is made...
MARSHALLTOWN will make it.

From 1890 through today, we have made that claim.

Today, the best finishing trowel made is **MARSHALLTOWN's** PermaShape®. Patent protected, PermaShape® is our guarantee that a finishing trowel blade will never change its shape*.

Each PermaShape® blade is shaped to help eliminate trowel marks. The working edges of the blade are beveled to prevent aggregate popping.

PermaShape comes in two styles- Broken-in and Flat. Experienced finishers will no longer have the common break-in period of a trowel if they use **MARSHALLTOWN's** Broken-in PermaShape®. The trowel will work perfectly right out of the box! That also means inexperienced finishers will be more productive sooner.

However, we have found that some finishers, especially in the EIFS and plastering trade, prefer a blade that is not as curved as our Broken-in, so we also offer the Flat PermaShape®. See pages 149, 150 and 230 for Flat PermaShape® trowels.

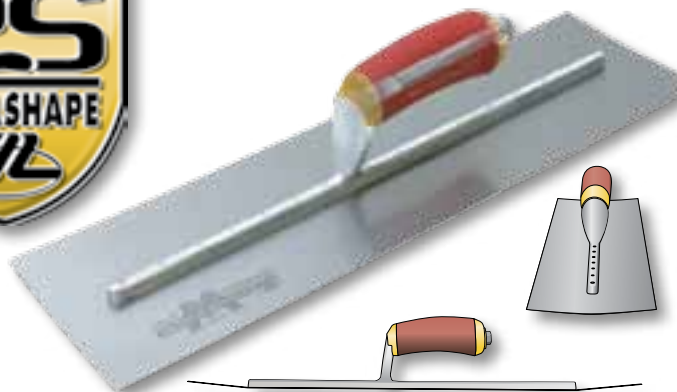

All our PermaShape® trowels come with our popular Xtralite® mounting and we top it all off with our DuraSoft® handle, the first and the best soft grip handle in the masonry industry.

PermaShape® Finishing Trowels

- Beginning finishers can do a better job and be more productive sooner
- Broken-in shape eliminates line and ripple marks right from the start
- Beveled work edges prevent surface aggregate popping
- PermaShape® guarantees trowel will maintain original broken-in shape
- Highest grade hardened and tempered golden stainless or spring steel blade; properly shaped and fastened with stainless steel rivets
- Aluminum alloy Xtralite® mounting is lightweight but very strong
- Resilient DuraSoft® handle provides a soft feel, reduces fatigue and offers excellent durability
- Sold 1 per inner pack/12 per outer pack, 6 per outer pack where noted with *

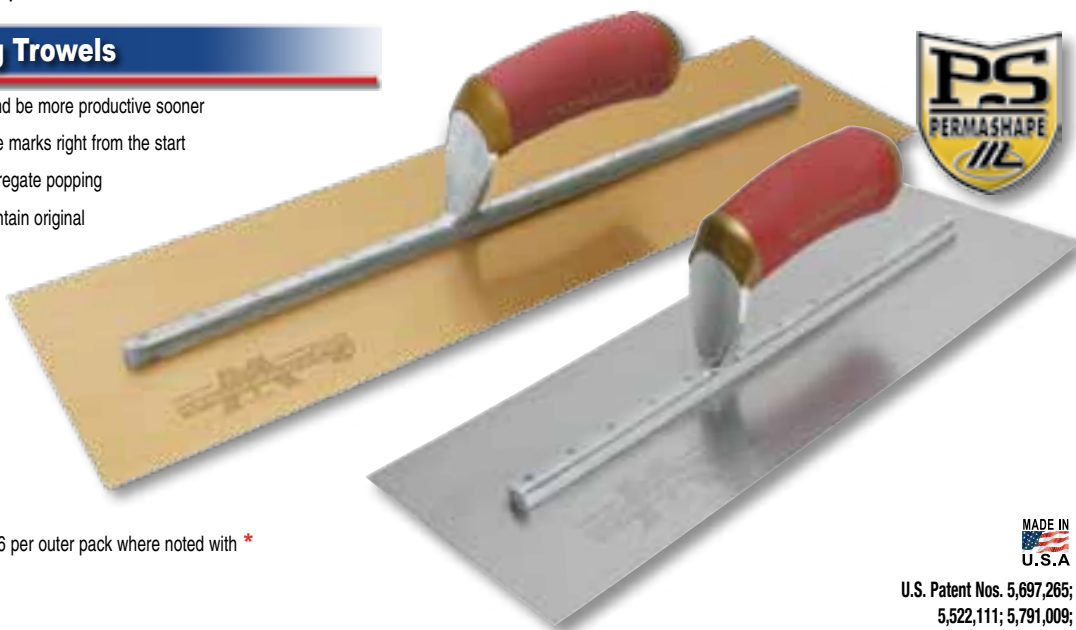

CONCRETE TOOLS

MADE IN
 U.S.A

U.S. Patent Nos. 5,697,265;
 5,522,111; 5,791,009;

MARSHALLTOWN The Premier Line

Carbon Steel

| EDI | Part# | Size-in. | Size-mm |
|-------|---------|----------|-----------|
| 13203 | PB56D | 12 X 3 | 305 X 76 |
| 13210 | PB62D | 12 X 4 | 305 X 102 |
| 13221 | PB57D | 14 X 3 | 356 X 76 |
| 13230 | PB64D | 14 X 4 | 356 X 102 |
| 13236 | PB145D | 14 X 5 | 356 X 127 |
| 13247 | PB66D | 16 X 4 | 406 X 102 |
| 13252 | PB165D* | 16 X 5 | 406 X 127 |
| 13265 | PB81D* | 18 X 4 | 457 X 102 |
| 13280 | PB815D* | 18 X 5 | 457 X 127 |
| 13271 | PB20D* | 20 X 4 | 508 X 102 |
| 13275 | PB205D* | 20 X 5 | 508 X 127 |

MARSHALLTOWN The Premier Line

Golden Stainless Steel

| EDI | Part# | Size-in. | Size-mm |
|-------|-----------|----------|-----------|
| 13463 | PB1GSD | 11 X 4½ | 279 X 114 |
| 12159 | PB4GSD | 11½ X 4¾ | 292 X 121 |
| 13436 | PB7GSD | 12 X 5 | 305 X 127 |
| 13438 | PB13GSD | 13 X 5 | 330 X 127 |
| 13413 | PB145GSD | 14 X 5 | 356 X 127 |
| 13439 | PB165GSD* | 16 X 5 | 406 X 127 |

* **MARSHALLTOWN** knows that the blade will wear away. But assuming the blade is used to smooth cementitious material and is not harmed in any other way, **MARSHALLTOWN** also knows the blade will maintain its shape throughout its life.



MARSHALLTOWN

Like us on

facebook®

What happens when you “Like”
MARSHALLTOWN Company on Facebook?

- Become a Facebook Fan of **MARSHALLTOWN**
- Keep up with cool things happening in your industry
- Win by participating in contests and quizzes
- View photos submitted by Facebook Fans like you
- Connect with other fans of **MARSHALLTOWN** product
- Find out the latest product information and innovations by **MARSHALLTOWN**

**Scan Here to
Like Us Today!**



www.facebook.com/MarshalltownCompany



To order: Phone: 800-888-0127 • Fax: 800-477-6341 • Visit our Website at www.MARSHALLTOWN.com

High Carbon Steel - DuraSoft® Handle

- Highest grade hardened and tempered spring steel blade, properly shaped
- Aluminum alloy Xtralite® mounting is lightweight but very strong
- Beveled work edges prevent surface aggregate popping
- Resilient DuraSoft® handle provides a soft feel, reduces fatigue and offers excellent durability
- Handle icons in table indicate straight or curved handle
- Sold 1 per inner pack/12 per outer pack, 6 per outer pack where noted with *



MADE IN
U.S.A

U.S. Patent No. 5,522,111

MARSHALLTOWN The Premier Line

| EDI | Part# | Size-in. | Size-mm | Handle |
|-------|---------|----------|-----------|--------|
| 15265 | MXS54D | 10 X 3 | 254 X 76 | |
| 13201 | MXS55D | 10 X 4 | 254 X 102 | |
| 12123 | MXS91D | 10½ X 4½ | 267 X 114 | |
| 13893 | MXS114D | 11 X 4 | 279 X 102 | |
| 12105 | MX1D | 11 X 4½ | 279 X 114 | |
| 12125 | MXS1D | 11 X 4½ | 279 X 114 | |
| 13459 | MXS3D | 11 X 4¾ | 279 X 121 | |
| 13458 | MXS2D | 11½ X 4½ | 292 X 114 | |
| 12131 | MXS4D | 11½ X 4¾ | 292 X 121 | |
| 13205 | MXS56D | 12 X 3 | 305 X 76 | |
| 13207 | MX62D | 12 X 4 | 305 X 102 | |
| 13209 | MXS62D | 12 X 4 | 305 X 102 | |
| 12133 | MXS7D | 12 X 5 | 305 X 127 | |
| 12135 | MXS13D | 13 X 5 | 330 X 127 | |
| 13223 | MX57D | 14 X 3 | 356 X 76 | |
| 13225 | MXS57D | 14 X 3 | 356 X 76 | |
| 15272 | MXS58D | 14 X 3½ | 356 X 89 | |
| 13227 | MX64D | 14 X 4 | 356 X 102 | |
| 13229 | MXS64D | 14 X 4 | 356 X 102 | |
| 15275 | MXS65D | 14 X 4½ | 356 X 114 | |

MARSHALLTOWN The Premier Line

| EDI | Part# | Size-in. | Size-mm | Handle |
|-------|----------|----------|-----------|--------|
| 13233 | MXS73D | 14 X 4¾ | 356 X 121 | |
| 13235 | MXS145D | 14 X 5 | 356 X 127 | |
| 13245 | MXS60D | 16 X 3 | 406 X 76 | |
| 15279 | MXS61D | 16 X 3½ | 406 X 89 | |
| 13282 | MX66D | 16 X 4 | 406 X 102 | |
| 13249 | MXS66D | 16 X 4 | 406 X 102 | |
| 15283 | MXS67D* | 16 X 4½ | 406 X 114 | |
| 15347 | MXS68D* | 16 X 4¾ | 406 X 121 | |
| 13251 | MXS165D* | 16 X 5 | 406 X 127 | |
| 15290 | MXS75D* | 18 X 3 | 457 X 76 | |
| 15287 | MXS76D* | 18 X 3½ | 457 X 89 | |
| 13267 | MX81D* | 18 X 4 | 457 X 102 | |
| 13269 | MXS81D* | 18 X 4 | 457 X 102 | |
| 13263 | MXS77D* | 18 X 4½ | 457 X 114 | |
| 15345 | MXS82D* | 18 X 4¾ | 457 X 121 | |
| 13279 | MXS815D* | 18 X 5 | 457 X 127 | |
| 13273 | MXS20D* | 20 X 4 | 508 X 102 | |
| 13277 | MXS205D* | 20 X 5 | 508 X 127 | |
| 13895 | MXS225D* | 22 X 5 | 559 X 127 | |
| 13197 | MXS24D* | 24 X 4 | 610 X 102 | |
| 13199 | MXS245D* | 24 X 5 | 610 X 127 | |

CONCRETE TOOLS



High Carbon Steel - Wood Handle

- Highest grade hardened and tempered spring steel blade, properly shaped
- Aluminum alloy Xtralite® mounting is lightweight but very strong
- Beveled work edges prevent surface aggregate popping
- Handle icons in table indicate straight or curved handle
- Sold 1 per inner pack/12 per outer pack, 6 per outer pack where noted with *

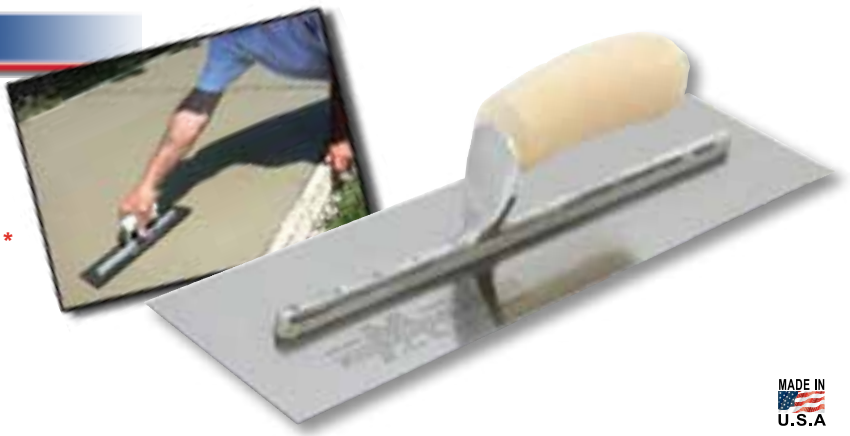

MADE IN
U.S.A.

MARSHALLTOWN The Premier Line

| EDI | Part# | Size-in. | Size-mm | Handle |
|-------|--------|----------|-----------|--------|
| 15263 | MX54 | 10 X 3 | 254 X 76 | |
| 15264 | MXS54 | 10 X 3 | 254 X 76 | |
| 15266 | MX55 | 10 X 4 | 254 X 102 | |
| 13200 | MXS55 | 10 X 4 | 254 X 102 | |
| 12122 | MXS91 | 10½ X 4½ | 267 X 114 | |
| 13889 | MX114 | 11 X 4 | 279 X 102 | |
| 13891 | MXS114 | 11 X 4 | 279 X 102 | |
| 12104 | MX1 | 11 X 4½ | 279 X 114 | |
| 12124 | MXS1 | 11 X 4½ | 279 X 114 | |
| 12128 | MXS3 | 11 X 4¾ | 279 X 121 | |
| 12106 | MX2 | 11½ X 4½ | 292 X 114 | |
| 12126 | MXS2 | 11½ X 4½ | 292 X 114 | |
| 12110 | MX4 | 11½ X 4¾ | 292 X 121 | |
| 12130 | MXS4 | 11½ X 4¾ | 292 X 121 | |
| 15269 | MX56 | 12 X 3 | 305 X 76 | |
| 13204 | MXS56 | 12 X 3 | 305 X 76 | |
| 13206 | MX62 | 12 X 4 | 305 X 102 | |
| 13208 | MXS62 | 12 X 4 | 305 X 102 | |
| 12132 | MXS7 | 12 X 5 | 305 X 127 | |
| 12134 | MXS13 | 13 X 5 | 330 X 127 | |
| 13222 | MX57 | 14 X 3 | 356 X 76 | |
| 13224 | MXS57 | 14 X 3 | 356 X 76 | |
| 15270 | MX58 | 14 X 3½ | 356 X 89 | |
| 15271 | MXS58 | 14 X 3½ | 356 X 89 | |
| 13226 | MX64 | 14 X 4 | 356 X 102 | |
| 13228 | MXS64 | 14 X 4 | 356 X 102 | |
| 15273 | MX65 | 14 X 4½ | 356 X 114 | |
| 15274 | MXS65 | 14 X 4½ | 356 X 114 | |
| 15276 | MX73 | 14 X 4¾ | 356 X 121 | |
| 13232 | MXS73 | 14 X 4¾ | 356 X 121 | |
| 13234 | MXS145 | 14 X 5 | 356 X 127 | |

MARSHALLTOWN The Premier Line

| EDI | Part# | Size-in. | Size-mm | Handle |
|-------|---------|----------|-----------|--------|
| 15280 | MX60 | 16 X 3 | 406 X 76 | |
| 13244 | MXS60 | 16 X 3 | 406 X 76 | |
| 15277 | MX61 | 16 X 3½ | 406 X 89 | |
| 15278 | MXS61 | 16 X 3½ | 406 X 89 | |
| 13246 | MX66 | 16 X 4 | 406 X 102 | |
| 13248 | MXS66 | 16 X 4 | 406 X 102 | |
| 15281 | MX67* | 16 X 4½ | 406 X 114 | |
| 15282 | MXS67* | 16 X 4½ | 406 X 114 | |
| 15284 | MX68* | 16 X 4¾ | 406 X 121 | |
| 15346 | MXS68* | 16 X 4¾ | 406 X 121 | |
| 13250 | MXS165* | 16 X 5 | 406 X 127 | |
| 15288 | MX75* | 18 X 3 | 457 X 76 | |
| 15289 | MXS75* | 18 X 3 | 457 X 76 | |
| 15285 | MX76* | 18 X 3½ | 457 X 89 | |
| 15286 | MXS76* | 18 X 3½ | 457 X 89 | |
| 13266 | MX81* | 18 X 4 | 457 X 102 | |
| 13268 | MXS81* | 18 X 4 | 457 X 102 | |
| 15291 | MX77* | 18 X 4½ | 457 X 114 | |
| 13262 | MXS77* | 18 X 4½ | 457 X 114 | |
| 15292 | MX82* | 18 X 4¾ | 457 X 121 | |
| 15344 | MXS82* | 18 X 4¾ | 457 X 121 | |
| 13278 | MXS815* | 18 X 5 | 457 X 127 | |
| 13270 | MX20* | 20 X 4 | 508 X 102 | |
| 13272 | MXS20* | 20 X 4 | 508 X 102 | |
| 13274 | MX205* | 20 X 5 | 508 X 127 | |
| 13276 | MXS205* | 20 X 5 | 508 X 127 | |
| 13194 | MXS22* | 22 X 4 | 559 X 102 | |
| 13195 | MXS225* | 22 X 5 | 559 X 127 | |
| 13196 | MXS24* | 24 X 4 | 610 X 102 | |
| 13198 | MXS245* | 24 X 5 | 610 X 127 | |

Stainless Steel

- Highest grade hardened and tempered bright or golden stainless steel blade, properly shaped
- Aluminum alloy Xtralite® mounting is lightweight but very strong
- Choice of resilient DuraSoft® handle or smooth, natural finish hardwood handle
- Sold 1 per inner pack/12 per outer pack, 6 per outer pack where noted with *

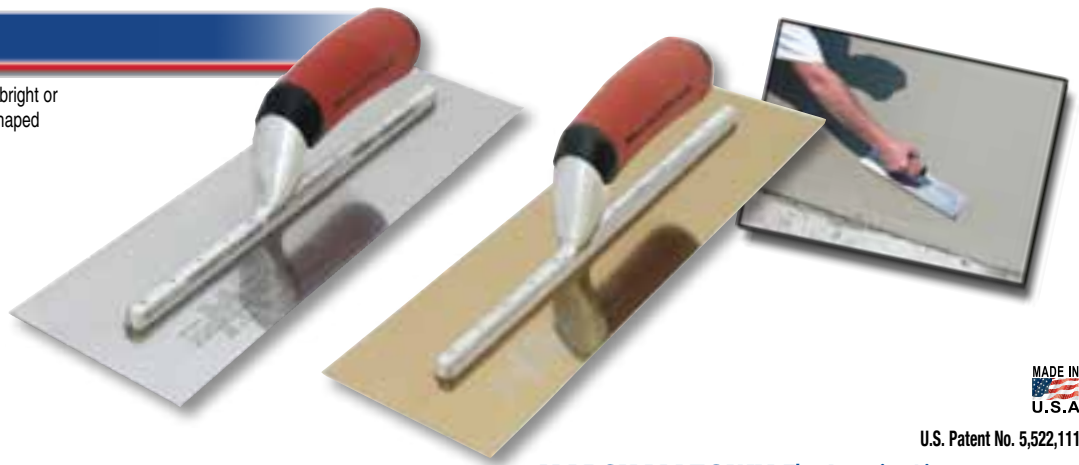

MADE IN
U.S.A

U.S. Patent No. 5,522,111

MARSHALLTOWN The Premier Line

Bright Stainless Steel

| EDI | Part# | Size-in. | Size-mm | Handle |
|-------|------------|----------|-----------|--------|
| 15321 | MXS91SS | 10½ X 4½ | 267 X 114 | |
| 15322 | MXS91SSD | 10½ X 4½ | 267 X 114 | |
| 12143 | MXS1SS | 11 X 4½ | 279 X 114 | |
| 13460 | MXS1SSD | 11 X 4½ | 279 X 114 | |
| 13464 | MXS3SS | 11 X 4¾ | 279 X 121 | |
| 13465 | MXS3SSD | 11 X 4¾ | 279 X 121 | |
| 15332 | MXS2SS | 11½ X 4½ | 292 X 114 | |
| 15333 | MXS2SSD | 11½ X 4½ | 292 X 114 | |
| 12145 | MXS4SS | 11½ X 4¾ | 292 X 121 | |
| 13461 | MXS4SSD | 11½ X 4¾ | 292 X 121 | |
| 12149 | MXS13SS | 13 X 5 | 330 X 127 | |
| 12151 | MXS13SSD | 13 X 5 | 330 X 127 | |
| 13405 | MXS73SS | 14 X 4¾ | 356 X 121 | |
| 13444 | MXS73SSD | 14 X 4¾ | 356 X 121 | |
| 13395 | MXS62SS | 12 X 4 | 305 X 102 | |
| 13396 | MXS62SSD | 12 X 4 | 305 X 102 | |
| 13398 | MXS64SS | 14 X 4 | 356 X 102 | |
| 13399 | MXS64SSD | 14 X 4 | 356 X 102 | |
| 15309 | MXS66SS | 16 X 4 | 406 X 102 | |
| 15310 | MXS66SSD | 16 X 4 | 406 X 102 | |
| 13426 | MXS165SD * | 16 X 5 | 406 X 102 | |
| 13410 | MXS205SS * | 20 X 5 | 508 X 127 | |
| 13409 | MXS25SSD * | 20 X 5 | 508 X 127 | |

MARSHALLTOWN The Premier Line

Golden Stainless Steel

| EDI | Part# | Size-in. | Size-mm | Handle |
|-------|------------|----------|-----------|--------|
| 15329 | MXS91GS | 10½ X 4½ | 267 X 114 | |
| 15331 | MXS91GSD | 10½ X 4½ | 267 X 114 | |
| 13901 | MXS3GS | 11 X 4¾ | 279 X 102 | |
| 13903 | MXS3GSD | 11 X 4¾ | 279 X 102 | |
| 12144 | MXS1GS | 11 X 4½ | 279 X 114 | |
| 13462 | MXS1GSD | 11 X 4½ | 279 X 114 | |
| 15334 | MXS2GS | 11½ X 4½ | 292 X 114 | |
| 15335 | MXS2GSD | 11½ X 4½ | 292 X 114 | |
| 12146 | MXS4GS | 11½ X 4¾ | 292 X 121 | |
| 12147 | MXS4GSD | 11½ X 4¾ | 292 X 121 | |
| 13401 | MXS62GS | 12 X 4 | 305 X 102 | |
| 13445 | MXS62GSD | 12 X 4 | 305 X 102 | |
| 12148 | MXS7GS | 12 X 5 | 305 X 127 | |
| 13446 | MXS7GSD | 12 X 5 | 305 X 127 | |
| 12150 | MXS13GS | 13 X 5 | 330 X 127 | |
| 13447 | MXS13GSD | 13 X 5 | 330 X 127 | |
| 13402 | MXS64GS | 14 X 4 | 356 X 102 | |
| 13448 | MXS64GSD | 14 X 4 | 356 X 102 | |
| 13403 | MXS73GS | 14 X 4¾ | 356 X 121 | |
| 13449 | MXS73GSD | 14 X 4¾ | 356 X 121 | |
| 13422 | MXS145GS | 14 X 5 | 356 X 127 | |
| 13423 | MXS145GD | 14 X 5 | 356 X 127 | |
| 13404 | MXS66GS | 16 X 4 | 406 X 102 | |
| 13450 | MXS66GSD | 16 X 4 | 406 X 102 | |
| 15311 | MXS67GS * | 16 X 4½ | 406 X 114 | |
| 15312 | MXS67GSD * | 16 X 4½ | 406 X 114 | |
| 13424 | MXS165GS * | 16 X 5 | 406 X 127 | |
| 13425 | MXS165GD * | 16 X 5 | 406 X 127 | |
| 13905 | MXS81GS * | 18 X 4 | 457 X 102 | |
| 13907 | MXS81GSD * | 18 X 4 | 457 X 102 | |
| 13406 | MXS815GS * | 18 X 5 | 457 X 127 | |
| 13451 | MXS815GD * | 18 X 5 | 457 X 127 | |
| 13408 | MXS205GS * | 20 X 5 | 508 X 127 | |
| 13452 | MXS205GD * | 20 X 5 | 508 X 127 | |

CONCRETE TOOLS

Blue Steel

- Highest grade hardened, tempered and blued spring steel blade, properly shaped
- Aluminum alloy Xtralite® mounting is lightweight but very strong
- Choice of resilient DuraSoft® handle or smooth, natural finish hardwood handle
- Sold 1 per inner pack/12 per outer pack, 6 per outer pack where noted with *

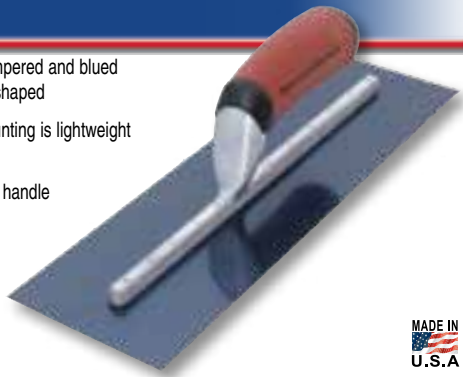

MADE IN
U.S.A

U.S. Patent No. 5,522,111

Rounded Front High Carbon Steel

- Highest grade hardened and tempered spring steel blade, properly shaped
- Aluminum alloy Xtralite® mounting is lightweight but very strong
- Choice of resilient DuraSoft® handle or smooth, natural finish hardwood handle
- Sold 1 per inner pack/12 per outer pack, 6 per outer pack where noted with *



MADE IN
U.S.A

U.S. Patent No. 5,522,111

MARSHALLTOWN The Premier Line

| EDI | Part# | Size-in. | Size-mm | Handle |
|-------|-----------|----------|-----------|--------|
| 13238 | MXS56B | 12 X 3 | 305 X 76 | |
| 13239 | MXS56BD | 12 X 3 | 305 X 76 | |
| 13211 | MXS62B | 12 X 4 | 305 X 102 | |
| 13212 | MXS62BD | 12 X 4 | 305 X 102 | |
| 13240 | MXS57B | 14 X 3 | 356 X 76 | |
| 13241 | MXS57BD | 14 X 3 | 356 X 76 | |
| 13414 | MXS64B | 14 X 4 | 356 X 102 | |
| 13440 | MXS64BD | 14 X 4 | 356 X 102 | |
| 13415 | MXS145B | 14 X 5 | 356 X 127 | |
| 13441 | MXS145BD | 14 X 5 | 356 X 127 | |
| 13416 | MXS66B | 16 X 4 | 406 X 102 | |
| 13442 | MXS66BD | 16 X 4 | 406 X 102 | |
| 13417 | MXS165B* | 16 X 5 | 406 X 127 | |
| 13443 | MXS165BD* | 16 X 5 | 406 X 127 | |
| 13285 | MXS81B* | 18 X 4 | 457 X 102 | |
| 13286 | MXS81BD* | 18 X 4 | 457 X 102 | |
| 13418 | MXS815B* | 18 X 5 | 457 X 127 | |
| 13419 | MXS815BD* | 18 X 5 | 457 X 127 | |
| 13288 | MXS20B* | 20 X 4 | 508 X 102 | |
| 13289 | MXS20BD* | 20 X 4 | 508 X 102 | |
| 13420 | MXS205B* | 20 X 5 | 508 X 127 | |
| 13421 | MXS205BD* | 20 X 5 | 508 X 127 | |
| 12240 | MXS224B* | 22 X 4 | 559 X 102 | |
| 12241 | MXS224BD* | 22 X 4 | 559 X 102 | |
| 12242 | MXS244B* | 24 X 4 | 610 X 102 | |
| 12243 | MXS244BD* | 24 X 4 | 610 X 102 | |
| 13292 | MXS245B* | 24 X 5 | 610 X 127 | |
| 13293 | MXS245BD* | 24 X 5 | 610 X 127 | |

MARSHALLTOWN The Premier Line

| EDI | Part# | Size-in. | Size-mm | Handle |
|-------|-----------|----------|-----------|--------|
| 13897 | MXS64RE | 14 X 4 | 356 X 102 | |
| 13899 | MXS64RED | 14 X 4 | 356 X 102 | |
| 13510 | MXS66RE | 16 X 4 | 406 X 102 | |
| 13511 | MXS66RED | 16 X 4 | 406 X 102 | |
| 13512 | MXS81RE* | 18 X 4 | 457 X 102 | |
| 13513 | MXS81RED* | 18 X 4 | 457 X 102 | |
| 13514 | MXS20RE* | 20 X 4 | 508 X 102 | |
| 13515 | MXS20RED* | 20 X 4 | 508 X 102 | |
| 13516 | MXS205RE* | 20 X 5 | 508 X 127 | |
| 13517 | MXS205RD* | 20 X 5 | 508 X 127 | |
| 12216 | MXS224RE* | 22 X 4 | 559 X 102 | |
| 12217 | MXS224RD* | 22 X 4 | 559 X 102 | |
| 12220 | MXS225RE* | 22 X 5 | 559 X 127 | |
| 12221 | MXS225RD* | 22 X 5 | 559 X 127 | |
| 12218 | MXS244RE* | 24 X 4 | 610 X 102 | |
| 12219 | MXS244RD* | 24 X 4 | 610 X 102 | |
| 12222 | MXS245RE* | 24 X 5 | 610 X 127 | |
| 12223 | MXS245RD* | 24 X 5 | 610 X 127 | |

Fully Rounded High Carbon Steel

- Highest grade hardened and tempered spring steel blade, properly shaped
- Aluminum alloy Xtralite® mounting is lightweight but very strong
- Choice of resilient DuraSoft® handle or smooth, natural finish hardwood handle
- Sold 1 per inner pack/12 per outer pack, 6 per outer pack where noted with *



MADE IN
U.S.A

U.S. Patent No. 5,522,111

Fully Rounded Blue Steel

- Highest grade hardened and tempered spring steel blade, properly shaped
- Aluminum alloy Xtralite® mounting is lightweight but very strong
- Choice of resilient DuraSoft® handle or smooth, natural finish hardwood handle
- Sold 1 per inner pack/12 per outer pack, 6 per outer pack where noted with *



MADE IN
U.S.A

U.S. Patent No. 5,522,111

MARSHALLTOWN The Premier Line

| EDI | Part# | Size-in. | Size-mm | Handle |
|-------|-----------|----------|-----------|--------|
| 13520 | MXS64FR | 14 X 4 | 356 X 102 | |
| 13521 | MXS64FRD | 14 X 4 | 356 X 102 | |
| 13522 | MXS66FR | 16 X 4 | 406 X 102 | |
| 13523 | MXS66FRD | 16 X 4 | 406 X 102 | |
| 16872 | MXS75FR* | 18 X 3 | 457 X 76 | |
| 16873 | MXS75FRD* | 18 X 3 | 457 X 76 | |
| 13524 | MXS81FR* | 18 X 4 | 457 X 102 | |
| 13525 | MXS81FRD* | 18 X 4 | 457 X 102 | |
| 13937 | MXS815FR | 18 X 5 | 457 X 127 | |
| 13939 | MXS815FRD | 18 X 5 | 457 X 127 | |
| 13526 | MXS20FR* | 20 X 4 | 508 X 102 | |
| 13527 | MXS20FRD* | 20 X 4 | 508 X 102 | |
| 13528 | MXS205FR* | 20 X 5 | 508 X 127 | |
| 13529 | MXS205FD* | 20 X 5 | 508 X 127 | |
| 12224 | MXS224FR* | 22 X 4 | 559 X 102 | |
| 12225 | MXS224FD* | 22 X 4 | 559 X 102 | |
| 12232 | MXS225FR* | 22 X 5 | 559 X 127 | |
| 12233 | MXS225FD* | 22 X 5 | 559 X 127 | |
| 12228 | MXS244FR* | 24 X 4 | 610 X 102 | |
| 12229 | MXS244FD* | 24 X 4 | 610 X 102 | |
| 12236 | MXS245FR* | 24 X 5 | 610 X 127 | |
| 12237 | MXS245FD* | 24 X 5 | 610 X 127 | |

MARSHALLTOWN The Premier Line

| EDI | Part# | Size-in. | Size-mm | Handle |
|-------|------------|----------|-----------|--------|
| 13530 | MXS64BFR | 14 X 4 | 356 X 102 | |
| 13531 | MXS64BRD | 14 X 4 | 356 X 102 | |
| 13532 | MXS66BFR | 16 X 4 | 406 X 102 | |
| 13533 | MXS66BRD | 16 X 4 | 406 X 102 | |
| 16874 | MXS75BFR* | 18 X 3 | 457 X 76 | |
| 16875 | MXS75BFRD* | 18 X 3 | 457 X 76 | |
| 13534 | MXS81BFR* | 18 X 4 | 457 X 102 | |
| 13535 | MXS81BRD* | 18 X 4 | 457 X 102 | |
| 13536 | MXS20BFR* | 20 X 4 | 508 X 102 | |
| 13537 | MXS20BRD* | 20 X 4 | 508 X 102 | |
| 13538 | MXS205BR* | 20 X 5 | 508 X 127 | |
| 13539 | MXS25BRD* | 20 X 5 | 508 X 127 | |
| 12226 | MXS224BR* | 22 X 4 | 559 X 102 | |
| 12227 | MXS22BRD* | 22 X 4 | 559 X 102 | |
| 12234 | MXS225BR* | 22 X 5 | 559 X 127 | |
| 12235 | MS225BRD* | 22 X 5 | 559 X 127 | |
| 12230 | MXS244BR* | 24 X 4 | 610 X 102 | |
| 12231 | MXS24BRD* | 24 X 4 | 610 X 102 | |
| 12238 | MXS245BR* | 24 X 5 | 610 X 127 | |
| 12239 | MS245BRD* | 24 X 5 | 610 X 127 | |

CONCRETE TOOLS

High Carbon Steel Pipe Trowel

- Ideal for finishing around pipes and in tight areas
- Highest grade hardened and tempered spring steel blade
- Aluminum alloy Xtralite® mounting is lightweight but very strong
- Sold 1 per inner pack/12 per outer pack



MADE IN
U.S.A

U.S. Patent No. 5,522,111

MARSHALLTOWN The Premier Line

| EDI | Part# | Size-in. | Size-mm | Handle |
|-------|---------|----------|----------|--------|
| 10358 | MPT105D | 10½ X 3 | 267 X 76 | |

Silo Trowels

- ½" (13mm) radius corners reduce gouging of round slabs
- Resilient DuraSoft® handle provides a soft feel, reduces fatigue and offers excellent durability
- Ideal for finishing swimming pools and silos
- Sold 1 per inner pack/12 per outer pack

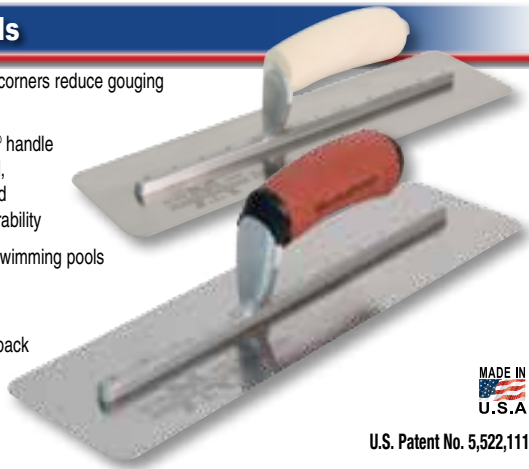

MADE IN U.S.A.

U.S. Patent No. 5,522,111

MARSHALLTOWN The Premier Line

| EDI | Part# | Size-in. | Size-mm | Handle |
|-------|-------|----------|-----------|--------|
| 12139 | ST14 | 14 X 4 | 356 X 102 | |
| 12140 | ST14D | 14 X 4 | 356 X 102 | |
| 12152 | ST16 | 16 X 4 | 406 X 102 | |
| 12153 | ST16D | 16 X 4 | 406 X 102 | |

Gunite

- Aluminum alloy Xtralite® mounting is lightweight but very strong
- Rivets are left headed on working surface for extra strength
- Choice of resilient DuraSoft® handle or smooth, natural finish hardwood handle
- Sold 1 per inner pack/12 per outer pack



MADE IN U.S.A.

U.S. Patent No. 5,522,111

MARSHALLTOWN The Premier Line

| EDI | Part# | Size-in. | Size-mm | Handle |
|-------|-------|----------|-----------|--------|
| 15267 | 3138 | 12 X 4 | 305 X 102 | |
| 15268 | 3138D | 12 X 4 | 305 X 102 | |
| 13140 | 3140 | 14 X 4 | 356 X 102 | |
| 13139 | 3140D | 14 X 4 | 356 X 102 | |

Midget Trowels

- Aluminum alloy Xtralite® mounting is lightweight but very strong
- "SS" indicates a stainless steel blade
- Choice of resilient DuraSoft® handle or smooth, natural finish hardwood handle
- Sold 3 per inner pack/3 per outer pack



MADE IN U.S.A.

U.S. Patent No. 5,522,111

MARSHALLTOWN The Premier Line

| EDI | Part# | Size-in. | Size-mm | Handle |
|-------|-------|----------|----------|--------|
| 13104 | 11D | 8 X 3 | 203 X 76 | |
| 13105 | 11 | 8 X 3 | 203 X 76 | |
| 13106 | 11SSD | 8 X 3 | 203 X 76 | |

Wall Form Trowels

- Ideal for finishing foundation walls that are poured below the top of the form
- MXS754FR and MXS754FD are fully rounded
- Choice of resilient DuraSoft® handle or smooth, natural finish hardwood handle
- Sold 4 per inner pack/24 per outer pack



MADE IN U.S.A.

U.S. Patent No. 5,522,111

MARSHALLTOWN The Premier Line

| EDI | Part# | Size-in. | Size-mm | Handle |
|-------|----------|----------|-----------|--------|
| 14247 | MXS754 | 7½ X 4 | 191 X 102 | |
| 14248 | MXS754D | 7½ X 4 | 191 X 102 | |
| 14249 | MXS754FR | 7½ X 4 | 191 X 102 | |
| 14250 | MXS754FD | 7½ X 4 | 191 X 102 | |

High Carbon Steel

- Cast aluminum mounting securely riveted to tempered, polished steel blade
- Mounting has a square shank to prevent handle from turning
- Choice of comfort grip or wood handle
- Sold 4 per inner pack/12 per outer pack, sold 6 per inner pack/6 per outer pack where noted with *

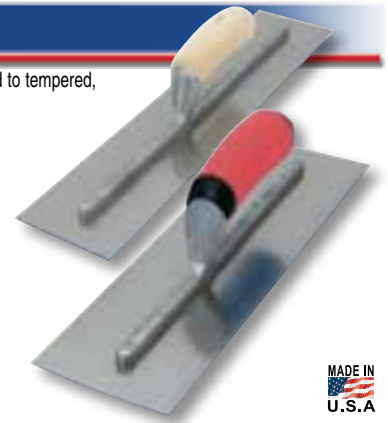

MADE IN U.S.A.

QLT[™] MARSHALLTOWN

| EDI | Part# | Size-in. | Size-mm | Handle |
|-------|---------|----------|-----------|--------|
| 13801 | FT362 | 12 X 4 | 305 X 102 | |
| 13817 | FT372R | 12 X 4 | 305 X 102 | |
| 13802 | FT363 | 14 X 4 | 356 X 102 | |
| 13818 | FT373R | 14 X 4 | 356 X 102 | |
| 13803 | FT364 | 16 X 4 | 406 X 102 | |
| 13819 | FT374R | 16 X 4 | 406 X 102 | |
| 13804 | FT365* | 18 X 4 | 457 X 102 | |
| 13837 | FT375R* | 18 X 4 | 457 X 102 | |
| 13947 | FT376R* | 20 X 4 | 508 X 102 | |

Stainless Steel

- Cast aluminum mounting securely riveted to tempered, polished steel blade
- Mounting has a square shank to prevent handle from turning
- Soft grip handle for increased comfort
- Sold 1 per inner pack/6 per outer pack

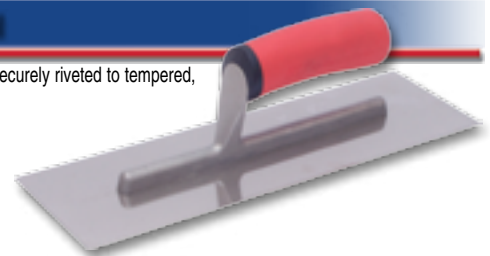

QLT[™] MARSHALLTOWN

| EDI | Part# | Size-in. | Size-mm | Handle |
|-------|---------|----------|-----------|--------|
| 11101 | FT124SS | 12 X 4 | 305 X 102 | |

High Carbon Steel

- Cast aluminum mounting securely riveted to tempered, polished steel blade
- Mounting has a square shank to prevent handle from turning
- Soft grip handle for increased comfort
- Sold 1 per inner pack/6 per outer pack

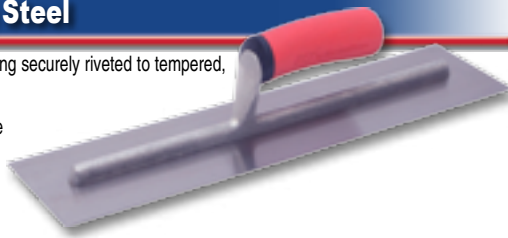

QLT BY MARSHALLTOWN

| EDI | Part# | Size-in. | Size-mm | Handle |
|-------|-------|----------|-----------|--------|
| 11103 | FT144 | 14 X 4 | 356 X 102 | |
| 11104 | FT164 | 16 X 4 | 406 X 102 | |

High Carbon Steel

- Cast aluminum mounting securely riveted to tempered, polished steel blade
- Mounting has a square shank to prevent handle from turning
- Plastic handle
- Sold 1 per inner pack/6 per outer pack

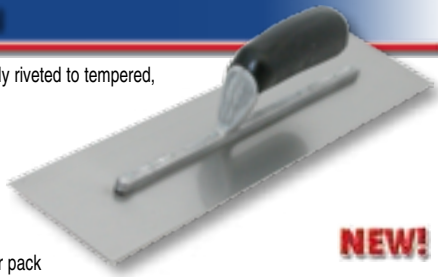

NEW!

QLT BY MARSHALLTOWN

| EDI | Part# | Size-in. | Size-mm |
|-------|--------|----------|-----------|
| 18342 | FT114P | 11 X 4½ | 279 X 115 |
| 18343 | FT144P | 14 X 4 | 356 X 102 |
| 18344 | FT164P | 16 X 4 | 406 X 102 |

Finishing Trowels Fully Rounded

- Cast aluminum mounting securely riveted to tempered, polished steel blade
- Mounting has a square shank to prevent handle from turning
- Choice of comfort grip or wood handle
- Sold 4 per inner pack/12 per outer pack

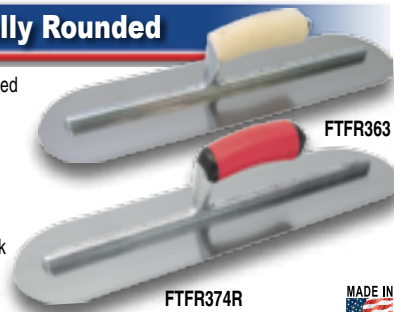

MADE IN U.S.A.

QLT BY MARSHALLTOWN

| EDI | Part# | Size-in. | Size-mm | Handle |
|-------|----------|----------|-----------|--------|
| 11217 | FTFR362 | 12 X 4 | 305 X 102 | |
| 11218 | FTFR372R | 12 X 4 | 305 X 102 | |
| 11219 | FTFR363 | 14 x 4 | 356 X 102 | |
| 11220 | FTFR373R | 14 X 4 | 356 X 102 | |
| 11221 | FTFR364 | 16 X 4 | 406 X 102 | |
| 11222 | FTFR374R | 16 X 4 | 406 X 102 | |
| 11223 | FTFR365 | 18 X 4 | 457 X 102 | |
| 11224 | FTFR375R | 18 X 4 | 457 X 102 | |
| 11225 | FTFR369 | 18 X 5 | 457 X 127 | |
| 11226 | FTFR379R | 18 X 5 | 457 X 127 | |
| 11227 | FTFR360 | 20 X 5 | 508 X 127 | |
| 11228 | FTFR370R | 20 X 5 | 508 X 127 | |

Bright Stainless Steel

- Cast aluminum mounting securely riveted to stainless steel blade
- Mounting has a square shank to prevent handle from turning
- Curved handle gives extra knuckle room
- Sold 2 per inner pack/6 per outer pack

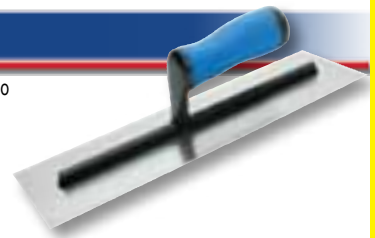

QLT BY MARSHALLTOWN

| EDI | Part# | Size-in. | Size-mm |
|-------|---------|----------|-----------|
| 13799 | FT799SS | 14 X 4 | 356 X 102 |

Economy Trowel

- Aluminum mounting
- Polished steel blade
- Comfortable, curved wood handle
- Sold 12 per inner pack/36 per outer pack

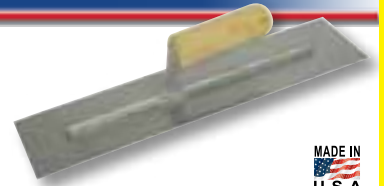

MADE IN U.S.A.

QLT BY MARSHALLTOWN

| EDI | Part# | Size-in. | Size-mm |
|-------|-------|----------|-----------|
| 12194 | 990S | 11 X 4½ | 279 X 115 |
| 13296 | 994S | 14 X 4 | 356 X 102 |
| 13300 | 999S | 16 X 4 | 406 X 102 |

Economy Trowel

- Steel blade
- Structural foam handle
- Sold 12 per inner pack/12 per outer pack



MADE IN U.S.A.

QLT BY MARSHALLTOWN

| EDI | Part# | Size-in. | Size-mm |
|-------|-------|----------|-----------|
| 16253 | 209 | 9 X 4 | 229 X 102 |
| 16245 | 227 | 11 X 4½ | 279 X 115 |

Economy Trowel

- All plastic blade and handle
- Intended to be disposed of after use
- For smoothing concrete base
- Sold 36 per inner pack/36 per outer pack



MADE IN U.S.A.

QLT BY MARSHALLTOWN

| EDI | Part# | Size-in. | Size-mm |
|-------|-------|----------|-----------|
| 16265 | 6265 | 10 X 4¼ | 254 X 108 |

Plastic Finishing Trowels

- High quality GE Lexan® blades are tough, wear resistant, and provide the right flex
- Aluminum alloy mounting to hold up to the toughest jobs
- Ideal for finishing surfaces that can't be blackened by standard steel blades like: swimming pools, white portland cement projects, interior plaster and stucco
- Sold 1 per inner pack/12 per outer pack



MADE IN
U.S.A

U.S. Patent No. 5,522,111

MARSHALLTOWN The Premier Line

| EDI | Part# | Size-in. | Size-mm | Handle |
|-------|--------|----------|-----------|--------|
| 16836 | PMXS1 | 11 X 4 ½ | 279 X 114 | |
| 16837 | PMXS1D | 11 X 4 ½ | 279 X 114 | |

Plastic Pool Trowels

- High quality GE Lexan® blades are tough, wear resistant, and provide the right flex
- Aluminum alloy mounting to hold up to the toughest jobs
- Ideal for finishing surfaces that can't be blackened by standard steel blades like: swimming pools, white portland cement projects, interior plaster and stucco
- Sold 1 per inner pack/12 per outer pack, 1 per inner pack/6 per outer where noted with *



MADE IN
U.S.A

U.S. Patent No. 5,522,111

MARSHALLTOWN The Premier Line

| EDI | Part# | Rivets | Size-in. | Size-mm | Handle |
|-------|----------|--------|----------|-----------|--------|
| 16826 | PSP10 | 3 | 10 X 3 | 254 X 76 | |
| 16827 | PSP10SD | 3 | 10 X 3 | 254 X 76 | |
| 16828 | PSP12 | 5 | 12 X 3 ½ | 305 X 89 | |
| 16829 | PSP12SD | 5 | 12 X 3 ½ | 305 X 89 | |
| 16830 | PSP14 | 6 | 14 X 4 | 356 X 102 | |
| 16831 | PSP14SD | 6 | 14 X 4 | 356 X 102 | |
| 16832 | PSP164 | 8 | 16 X 4 | 406 X 102 | |
| 16833 | PSP164SD | 8 | 16 X 4 | 406 X 102 | |
| 16834 | PSP81* | 10 | 18 X 4 | 457 X 102 | |
| 16835 | PSP81SD* | 10 | 18 X 4 | 457 X 102 | |

Exposed Rivet Blue Steel Trowels

- Highest grade hardened, tempered and blued steel
- Extra short mounting is lightweight but very strong allowing user to flex blade to almost any radius
- Rivets left unground for longer trowel life while flexing blade at very large radii
- Sold 1 per inner pack/6 per outer pack, 1 per inner pack/12 per outer pack where noted with *

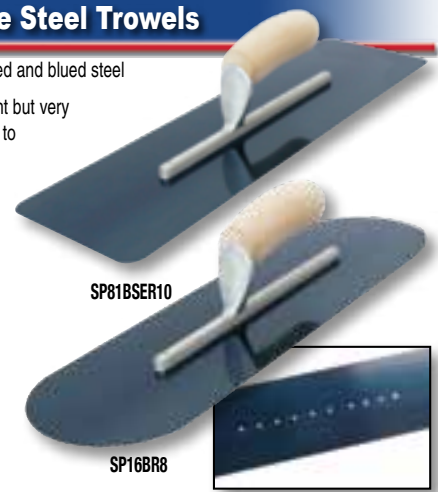

MADE IN
U.S.A

MARSHALLTOWN The Premier Line

Flat End Exposed Rivet Blue Steel Trowels

| EDI | Part# | Rivets | Mount Size-in. | Size-in. | Size-mm |
|-------|-------------|--------|----------------|----------|-----------|
| 13599 | SP124BSER8* | 8 | 8 | 12 X 4 | 305 X 102 |
| 13598 | SP81BSER10 | 10 | 9¾ | 18 X 4 | 457 X 102 |
| 13163 | SP20BSER12 | 12 | 11¼ | 20 X 4 | 508 X 102 |

Fully Rounded Exposed Rivet Blue Steel Trowels

| EDI | Part# | Rivets | Mount Size-in. | Size-in. | Size-mm |
|-------|------------|--------|----------------|----------|-----------|
| 13577 | SP83BR3* | 3 | ¾ | 8 X 3 | 203 X 76 |
| 13578 | SP10BR3* | 3 | ¾ | 10 X 3 | 254 X 76 |
| 13579 | SP104BR3* | 3 | ¾ | 10 X 4 | 254 X 102 |
| 13580 | SP12BR3* | 3 | ¾ | 12 X 3½ | 305 X 89 |
| 13581 | SP14BR3* | 3 | ¾ | 14 X 4 | 356 X 102 |
| 13582 | SP14BR5* | 5 | 5 | 14 X 4 | 356 X 102 |
| 13583 | SP1635BR8* | 8 | 8 | 16 X 3½ | 406 X 89 |
| 13585 | SP164BR3* | 3 | ¾ | 16 X 4 | 406 X 102 |
| 13584 | SP164BR6* | 6 | 6 | 16 X 4 | 406 X 102 |
| 13586 | SP16BR8 | 8 | 8 | 16 X 4.5 | 406 X 115 |
| 13589 | SP81BR5 | 5 | 5 | 18 X 4 | 457 X 102 |
| 13588 | SP81BR6 | 6 | 6 | 18 X 4 | 457 X 102 |
| 13587 | SP81BR8 | 8 | 8 | 18 X 4 | 457 X 102 |
| 13590 | SP81BR10 | 10 | 9¾ | 18 X 4 | 457 X 102 |
| 13591 | SP815BR10 | 10 | 9¾ | 18 X 5 | 457 X 127 |
| 13592 | SP20BR8 | 8 | 8 | 20 X 4 | 508 X 102 |
| 13593 | SP205BR12 | 12 | 11¼ | 20 X 5 | 457 X 127 |
| 13594 | SP22BR8 | 8 | 8 | 22 X 4 | 559 X 102 |
| 13595 | SP2245BR10 | 10 | 9¾ | 22 X 4½ | 559 X 114 |
| 13596 | SP2245BR14 | 14 | 13¾ | 22 X 4½ | 559 X 114 |
| 13597 | SP24BR8 | 8 | 8 | 24 X 4 | 610 X 127 |

Stainless Steel Exposed Rivet Pool Trowels

- Hardened and tempered bright stainless steel blade
- Extra short mounting is lightweight but very strong allowing user to flex blade to almost any radius
- Rivets left unground for longer trowel life while flexing blade at very large radii
- Sold 1 per inner pack/12 per outer pack, 1 per inner pack/6 per outer where noted with *

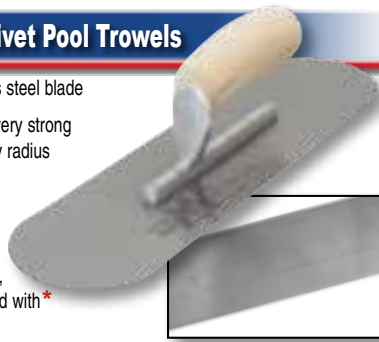

MADE IN
U.S.A

MARSHALLTOWN The Premier Line

| EDI | Part# | Rivets | Size-in. | Size-mm | Handle |
|-------|--------------|--------|----------|-----------|--------|
| 13103 | SP83SSR3 | 3 | 8 X 3 | 203 X 76 | |
| 13107 | SP10SSR3 | 3 | 10 X 3 | 254 X 76 | |
| 13108 | SP12SSR3 | 3 | 12 X 3½ | 305 X 89 | |
| 13134 | SP14SSR5 | 5 | 14 X 4 | 356 X 102 | |
| 13136 | SP164SSR8* | 8 | 16 X 4 | 406 X 102 | |
| 13141 | SP815SSR10* | 10 | 18 X 5 | 457 X 127 | |
| 13153 | SP205SSR12* | 12 | 20 X 5 | 508 X 127 | |
| 13154 | SP2245SSR14* | 14 | 22 X 4½ | 559 X 115 | |
| 13156 | SP245SSR16* | 16 | 24 X 5 | 610 X 127 | |

Exposed Rivet PoolSaver™ Trowels

- Hard chrome plating reduces plaster burn
- Short aluminum alloy Xtralite® mounting is lightweight but very strong
- Exposed rivets on working surface for added strength
- Proprietary manufacturing process allows same flexibility as our other pool trowels
- Sold 1 per inner pack/12 per outer pack, 1 per inner pack/6 per outer where noted with *



MADE IN
U.S.A

MARSHALLTOWN The Premier Line

| EDI | Part# | Rivets | Size-in. | Size-mm | Handle |
|-------|-----------|--------|----------|-----------|--------|
| 13157 | SP10PR3 | 3 | 10 X 3 | 254 X 76 | |
| 13158 | SP12PR5 | 5 | 12 X 3½ | 305 X 89 | |
| 13159 | SP143PR6 | 6 | 14 X 3 | 356 X 76 | |
| 13160 | SP14PR8 | 8 | 14 X 4 | 356 X 102 | |
| 13161 | SP163PR8* | 8 | 16 X 3 | 406 X 76 | |
| 13162 | SP164PR8* | 8 | 16 X 4 | 406 X 102 | |

PoolSaver™ Trowels

- Hard chrome plating reduces plaster burn
- Short aluminum alloy Xtralite® mounting is lightweight but very strong
- Proprietary manufacturing process allows same flexibility as our other pool trowels
- Sold 1 per inner pack/12 per outer pack, 6 per outer pack where noted with *



MADE IN
U.S.A

U.S. Patent No. 5,522,111

MARSHALLTOWN The Premier Line

| EDI | Part# | Rivets | Size-in. | Size-mm | Handle |
|-------|----------|--------|----------|-----------|--------|
| 13143 | SP10P | 3 | 10 X 3 | 254 X 76 | |
| 13144 | SP10PD | 3 | 10 X 3 | 254 X 76 | |
| 13145 | SP12P | 5 | 12 X 3½ | 305 X 89 | |
| 13146 | SP12PD | 5 | 12 X 3½ | 305 X 89 | |
| 15303 | SP143P | 6 | 14 X 3 | 356 X 76 | |
| 15304 | SP143PD | 6 | 14 X 3 | 356 X 76 | |
| 13147 | SP14P | 6 | 14 X 4 | 356 X 102 | |
| 13148 | SP14PD | 6 | 14 X 4 | 356 X 102 | |
| 15305 | SP163P* | 8 | 16 X 3 | 406 X 76 | |
| 15306 | SP163PD* | 8 | 16 X 3 | 406 X 76 | |
| 15307 | SP164P* | 8 | 16 X 4 | 406 X 102 | |
| 15308 | SP164PD* | 8 | 16 X 4 | 406 X 102 | |

High Carbon Steel Pool Trowels

- Highest grade hardened and tempered spring steel blade, properly shaped
- Short aluminum alloy Xtralite® mounting is lightweight but very strong
- Blade is flexible enough to conform to almost any radius
- Choice of resilient DuraSoft® handle or smooth, natural finish hardwood handle
- Sold 1 per inner pack/12 per outer pack, 6 per outer pack where noted with *



MADE IN
U.S.A

U.S. Patent No. 5,522,111

MARSHALLTOWN The Premier Line

| EDI | Part# | Rivets | Size-in. | Size-mm | Handle |
|-------|-------------|--------|----------|-----------|--------|
| 13164 | SP83 | 3 | 8 X 3 | 203 X 76 | |
| 13166 | SP83SD | 3 | 8 X 3 | 203 X 76 | |
| 13110 | SP10 | 3 | 10 X 3 | 254 X 76 | |
| 13109 | SP10SD | 3 | 10 X 3 | 254 X 76 | |
| 13167 | SP12S3 | 3 | 12 X 3½ | 305 X 89 | |
| 13168 | SP12SDS3 | 3 | 12 X 3½ | 305 X 89 | |
| 13112 | SP12 | 5 | 12 X 3½ | 305 X 89 | |
| 13111 | SP12SD | 5 | 12 X 3½ | 305 X 89 | |
| 13169 | SP14S5 | 5 | 14 X 4 | 356 X 102 | |
| 13174 | SP14SDS5 | 5 | 14 X 4 | 356 X 89 | |
| 13114 | SP14 | 6 | 14 X 4 | 356 X 102 | |
| 13113 | SP14SD | 6 | 14 X 4 | 356 X 102 | |
| 13135 | SP14D | 6 | 14 X 4 | 356 X 102 | |
| 13116 | SP16* | 8 | 16 X 4½ | 406 X 114 | |
| 13117 | SP16SD* | 8 | 16 X 4½ | 406 X 114 | |
| 13137 | SP16D* | 8 | 16 X 4½ | 406 X 114 | |
| 13118 | SP815* | 10 | 18 X 5 | 457 X 127 | |
| 13119 | SP815SD* | 10 | 18 X 5 | 457 X 127 | |
| 13175 | SP164S12* | 12 | 16 X 4 | 406 X 102 | |
| 13176 | SP164SDS12* | 12 | 16 X 4 | 406 X 102 | |
| 13138 | SP164 | 12 | 16 X 4 | 406 X 102 | |
| 13120 | SP205* | 12 | 20 X 5 | 508 X 127 | |
| 13121 | SP205SD* | 12 | 20 X 5 | 508 X 127 | |
| 13925 | SP22 | 14 | 22 X 4 | 559 X 102 | |
| 13927 | SP22D | 14 | 22 X 4 | 559 X 102 | |
| 13941 | SP225 | 14 | 22 X 5 | 559 X 127 | |
| 13943 | SP225D | 14 | 22 X 5 | 559 X 127 | |
| 13929 | SP24 | 14 | 24 X 4 | 610 X 102 | |
| 13931 | SP24D | 14 | 24 X 4 | 610 X 102 | |
| 13933 | SP245 | 14 | 24 X 5 | 610 X 127 | |
| 13935 | SP245D | 14 | 24 X 5 | 610 X 127 | |

Blue Steel Pool Trowels

- Highest grade hardened and tempered and blued spring steel blade, properly shaped
- Short aluminum alloy Xtralite® mounting is lightweight but very strong
- Blade is flexible enough to conform to almost any radius
- Sold 1 per inner pack/12 per outer pack, 6 per outer pack where noted with *



MADE IN
U.S.A

U.S. Patent No. 5,522,111

MARSHALLTOWN The Premier Line

| EDI | Part# | Rivets | Size-in. | Size-mm | Handle |
|-------|----------|--------|----------|-----------|--------|
| 15297 | SP10B | 3 | 10 X 3 | 254 X 76 | |
| 15298 | SP10BD | 3 | 10 X 3 | 254 X 76 | |
| 13909 | SP123B | 5 | 12 X 3 | 254 X 102 | |
| 13911 | SP123BD | 5 | 12 X 3 | 254 X 102 | |
| 13125 | SP12B | 5 | 12 X 3½ | 305 X 89 | |
| 13453 | SP12BD | 5 | 12 X 3½ | 305 X 89 | |
| 15293 | SP143B | 6 | 14 X 3 | 356 X 76 | |
| 15294 | SP143BD | 6 | 14 X 3 | 356 X 76 | |
| 13130 | SP14B | 6 | 14 X 4 | 356 X 102 | |
| 13454 | SP14BD | 6 | 14 X 4 | 356 X 102 | |
| 15295 | SP163B* | 8 | 16 X 3 | 406 X 76 | |
| 15296 | SP163BD* | 8 | 16 X 3 | 406 X 76 | |
| 13126 | SP16B* | 8 | 16 X 4½ | 406 X 114 | |
| 13455 | SP16BD* | 8 | 16 X 4½ | 406 X 114 | |
| 15533 | SP164B | 8 | 16 X 4 | 406 X 102 | |
| 15534 | SP164BD | 8 | 16 X 4 | 406 X 102 | |
| 13128 | SP815B* | 10 | 18 X 5 | 457 X 127 | |
| 13456 | SP815BD* | 10 | 18 X 5 | 457 X 127 | |
| 13132 | SP205B* | 12 | 20 X 5 | 508 X 127 | |
| 13131 | SP205BD* | 12 | 20 X 5 | 508 X 127 | |
| 13913 | SP225B* | 14 | 22 X 5 | 559 X 127 | |
| 13915 | SP225BD* | 14 | 22 X 5 | 559 X 127 | |
| 13917 | SP245B* | 14 | 24 X 5 | 610 X 127 | |
| 13919 | SP245BD* | 16 | 24 X 5 | 610 X 127 | |

Bright Stainless Steel Pool Trowels

- Highest grade hardened and tempered bright stainless steel blade, properly shaped and fastened with stainless steel rivets
- Short aluminum alloy Xtralite® mounting is lightweight but very strong
- Blade is flexible enough to bend to almost any radius
- Choice of resilient DuraSoft® handle or smooth, natural finish hardwood handle
- Sold 1 per inner pack/12 per outer pack, 6 per outer pack where noted with *



MADE IN
U.S.A.

U.S. Patent No. 5,522,111

MARSHALLTOWN The Premier Line

| EDI | Part# | Rivets | Size-in. | Size-mm | Handle |
|-------|----------|--------|----------|-----------|--------|
| 15336 | SP10SS | 3 | 10 X 3 | 254 X 76 | |
| 15337 | SP10SSD | 3 | 10 X 3 | 254 X 76 | |
| 13921 | SP12SS | 5 | 12 X 3½ | 305 X 89 | |
| 13923 | SP12SSD | 5 | 12 X 3½ | 305 X 89 | |
| 15299 | SP143SS | 6 | 14 X 3 | 356 X 76 | |
| 15300 | SP143SSD | 6 | 14 X 3 | 356 X 76 | |
| 15338 | SP14SS | 6 | 14 X 4 | 356 X 102 | |
| 15339 | SP14SSD | 6 | 14 X 4 | 356 X 102 | |
| 15301 | SP163SS | 8 | 16 X 3 | 406 X 76 | |
| 15302 | SP163SSD | 8 | 16 X 3 | 406 X 76 | |
| 15340 | SP164SS | 8 | 16 X 4 | 406 X 102 | |
| 15341 | SP164SSD | 8 | 16 X 4 | 406 X 102 | |

Golden Stainless Steel Pool Trowels

- Highest grade hardened and tempered golden stainless steel blade, properly shaped and fastened with stainless steel rivets
- Short aluminum alloy Xtralite® mounting is lightweight but very strong
- Blade is flexible enough to bend to almost any radius
- Sold 1 per inner pack/12 per outer pack, 6 per outer pack where noted with *



MADE IN
U.S.A.

U.S. Patent No. 5,522,111

MARSHALLTOWN The Premier Line

| EDI | Part# | Rivets | Size-in. | Size-mm | Handle |
|-------|----------|--------|----------|-----------|--------|
| 13149 | SP10GS | 3 | 10 X 3 | 254 X 76 | |
| 13150 | SP10GSD | 3 | 10 X 3 | 254 X 76 | |
| 13151 | SP12GS | 5 | 12 X 3½ | 305 X 89 | |
| 13152 | SP12GSD | 5 | 12 X 3½ | 305 X 89 | |
| 13122 | SP14GS | 6 | 14 X 4 | 356 X 102 | |
| 13123 | SP14GSD | 6 | 14 X 4 | 356 X 102 | |
| 15342 | SP164GS | 8 | 16 X 4 | 406 X 102 | |
| 15343 | SP164GSD | 8 | 16 X 4 | 406 X 102 | |
| 13124 | SP16GS* | 8 | 16 X 4½ | 406 X 114 | |
| 13457 | SP16GSD* | 8 | 16 X 4½ | 406 X 114 | |

Blue Steel Pool Trowels

- Short aluminum alloy mounting
- Blade is flexible enough to conform to almost any radius
- Comfort grip or hardwood handle
- Sold 4 per inner pack/12 per outer pack, 4 per outer pack where noted with *



MADE IN
U.S.A.

U.S. Patent No. 5,522,111

QLT[™] MARSHALLTOWN

| EDI | Part# | Rivets | Size-in. | Size-mm | Handle |
|-------|----------|--------|----------|-----------|--------|
| 13115 | PT144B | 6 | 14 X 4 | 356 X 102 | |
| 13155 | PT144BR | 6 | 14 X 4 | 356 X 102 | |
| 13127 | PT164B | 8 | 16 X 4½ | 406 X 114 | |
| 11750 | PT164BR | 8 | 16 X 4½ | 406 X 114 | |
| 13129 | PT185B* | 10 | 18 X 5 | 457 X 127 | |
| 11751 | PT185BR* | 10 | 18 X 5 | 457 X 127 | |
| 13133 | PT205B* | 12 | 20 X 5 | 508 X 127 | |
| 11752 | PT205BR* | 12 | 20 X 5 | 508 X 127 | |

Finishing Trowel Handles

- Will fit all our **MARSHALLTOWN** finishing trowels
- 401 & 402 sold 1 per inner pack/12 per outer pack, 401D & 402D sold 6 per inner pack/6 per outer pack



MADE IN
U.S.A.

U.S. Patent No. 5,522,111

MARSHALLTOWN The Premier Line

| EDI | Part# | Description | Dia.-in. | Dia.-mm |
|-------|-------|--------------------|----------|---------|
| 19114 | 401 | Straight Wood | 1½ | 41 |
| 19116 | 402 | Curved Wood | 1¼ | 39 |
| 19115 | 401D | Straight DuraSoft® | 1½ | 41 |
| 19117 | 402D | Curved DuraSoft® | 1¼ | 39 |

Tool Hooks

- Clean, easy way to carry your hand tool when not in use
- Small but sturdy cross section holds almost any tool
- Sold 12 per inner pack/12 per outer pack



MADE IN
U.S.A.

MARSHALLTOWN The Premier Line

| EDI | Part# | Size-in. | Size-mm |
|-------|-------|----------|---------|
| 14289 | 14289 | N/A | N/A |

Heavy Duty Zinc Hand Edgers

- Made from high quality, long wearing zinc
- Resilient DuraSoft® handle provides a soft feel, reduces fatigue, and offers excellent durability
- Smooth finish allows for easier clean-up
- Longer lasting and heavier than steel edgers
- 4002D sold 1 per inner pack/1 per outer pack, 4154D sold 6 per inner pack/6 per outer pack



MADE IN
U.S.A.

MARSHALLTOWN The Premier Line

| EDI | Part# | Size-in. | Size-mm | Radius | Lip |
|-------|-------|----------|-----------|----------|-----------|
| 14002 | 4002D | 9 X 4 | 229 X 102 | ¼" (6mm) | ⅝" (16mm) |
| 14154 | 4154D | 6 X 2⅝ | 152 X 56 | ¼" (6mm) | ⅝" (16mm) |

Bronze Hand Edgers

- Made from high quality, long wearing bronze
- Comfortable soft grip with finger guard
- Finely finished to make smooth clean edges
- Sold 1 per inner pack/12 per outer pack



QLT[®] BY MARSHALLTOWN

| EDI | Part# | Size-in. | Size-mm | Radius | Lip |
|-------|-------|----------|-----------|-----------|-----------|
| 17588 | 7588 | 6 X 2¾ | 152 X 70 | ¼" (6mm) | ⅝" (16mm) |
| 17589 | 7589 | 6 X 4 | 152 X 102 | ¼" (6mm) | ⅝" (16mm) |
| 17590 | 7590 | 6 X 3 | 152 X 76 | ⅜" (10mm) | ⅝" (16mm) |
| 17591 | 7591 | 9 X 4 | 229 X 102 | ¼" (6mm) | ¾" (19mm) |

Bronze Chamfer Tube Edgers

- Made from high quality, long wearing bronze
- Comfortable soft grip with finger guard
- Has a 45° chamfer; ¾" (19mm) lip
- Finely finished to make smooth clean edges
- Used to put a beveled edge on round supports
- Sold 1 per inner pack/12 per outer pack

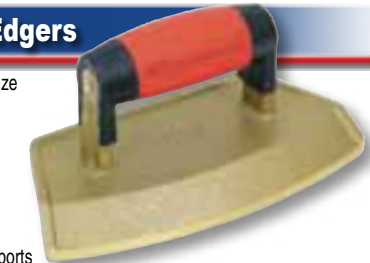

QLT[®] BY MARSHALLTOWN

| EDI | Part# | Tube Diam.-in. | Tube Diam.-mm |
|-------|-------|----------------|---------------|
| 17594 | 7594 | 12 | 305 |
| 17595 | 7595 | 16 | 406 |
| 17596 | 7596 | 18 | 457 |
| 17597 | 7597 | 24 | 607 |
| 17598 | 7598 | 30 | 762 |
| 17599 | 7599 | 36 | 914 |
| 17600 | 7600 | 48 | 1219 |

Straight End Hand Edgers

- Available in carbon steel, stainless steel or blue steel with a sturdy mounting welded to the blade
- Resilient DuraSoft® handle provides a soft feel, reduces fatigue and offers excellent durability
- Used to produce a radius at the edge of a concrete slab to help prevent the edge from chipping
- Sold 6 per inner pack/6 per outer pack

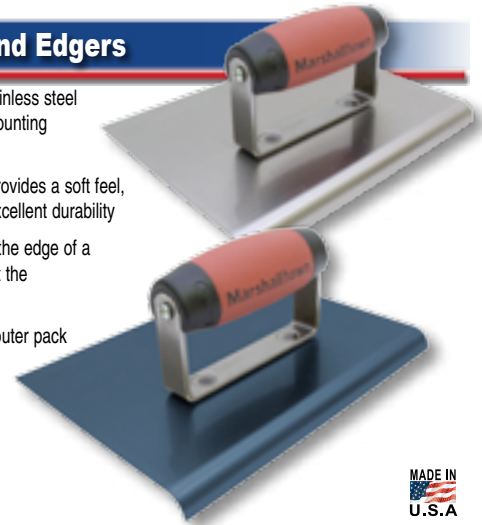

MADE IN
U.S.A.

MARSHALLTOWN The Premier Line

Carbon Steel

| EDI | Part# | Size-in. | Size-mm | Radius | Lip |
|-------|-------|----------|-----------|-----------|-----------|
| 14142 | 36D | 6 X 3 | 152 X 76 | ⅜" (10mm) | ½" (13mm) |
| 14152 | 120D | 8 X 6 | 203 X 152 | ⅜" (10mm) | ½" (13mm) |

Stainless Steel

| EDI | Part# | Size-in. | Size-mm | Radius | Lip |
|-------|--------|----------|-----------|-----------|------------|
| 14226 | 160SSD | 6 X 4 | 152 X 102 | ⅛" (3mm) | ¼" (6mm) |
| 14221 | 164SSD | 6 X 4¼ | 152 X 108 | ¼" (6mm) | ⅝" (10mm) |
| 14227 | 165SSD | 6 X 4½ | 152 X 115 | ⅜" (10mm) | ½" (13mm) |
| 14229 | 166SSD | 6 X 4⅝ | 152 X 110 | ½" (13mm) | ⅝" (16mm) |
| 14228 | 161SSD | 6 X 6 | 152 X 152 | ⅛" (3mm) | ¼" (6mm) |
| 14186 | 162SSD | 6 X 6 | 152 X 152 | ⅜" (10mm) | ½" (13mm) |
| 14188 | 163SSD | 6 X 6 | 152 X 152 | ½" (13mm) | ⅝" (16mm) |
| 14284 | 184SSD | 8 X 6 | 203 X 152 | ¼" (6mm) | ⅝" (10mm) |
| 14286 | 185SSD | 8 X 6 | 203 X 152 | ⅜" (10mm) | ½" (13mm) |
| 14288 | 188SSD | 8 X 6 | 203 X 152 | ½" (13mm) | ⅝" (16mm) |
| 14290 | 190SSD | 10 X 4 | 254 X 102 | ⅜" (10mm) | ½" (13mm) |
| 14292 | 192SSD | 10 X 4 | 254 X 102 | ½" (13mm) | ⅝" (16mm) |
| 14294 | 194SSD | 10 X 4 | 254 X 102 | ¾" (19mm) | 1" (25mm) |
| 14296 | 196SSD | 10 X 4 | 254 X 102 | 1" (25mm) | 1⅝" (29mm) |

Blue Steel

| EDI | Part# | Size-in. | Size-mm | Radius | Lip |
|-------|-------|----------|-----------|-----------|-----------|
| 14223 | 158BD | 6 X 4 | 152 X 102 | ⅜" (10mm) | ½" (13mm) |
| 14225 | 159BD | 6 X 4 | 152 X 102 | ½" (13mm) | ⅝" (16mm) |
| 14222 | 160BD | 6 X 4 | 152 X 102 | ⅛" (3mm) | ¼" (6mm) |
| 14224 | 161BD | 6 X 6 | 152 X 152 | ⅛" (3mm) | ¼" (6mm) |
| 14170 | 162BD | 6 X 6 | 152 X 152 | ⅜" (10mm) | ½" (13mm) |
| 14172 | 163BD | 6 X 6 | 152 X 152 | ½" (13mm) | ⅝" (16mm) |
| 14160 | 164BD | 9 X 6 | 229 X 152 | ⅜" (10mm) | ½" (13mm) |
| 14161 | 166BD | 9 X 6 | 229 X 152 | ½" (13mm) | ⅝" (16mm) |
| 14162 | 167BD | 9 X 6 | 229 X 152 | ¾" (19mm) | ⅞" (22mm) |

Narrow Stainless Steel Hand Edgers

- Blade is made of heavy gauge stainless steel
- Resilient DuraSoft® handle provides a soft feel, reduces fatigue and offers excellent durability
- Used to produce a radius at the edge of a concrete slab to help prevent the edge from chipping
- Narrow design allows for edging tight or curved areas
- Sold 1 per inner pack/6 per outer pack



MARSHALLTOWN The Premier Line

| EDI | Part# | Size-in. | Size-mm | Radius | Lip |
|-------|-------|----------|----------|-----------|-----------|
| 14489 | 489N | 1 X 6 | 25 X 152 | ¼" (6mm) | ¾" (10mm) |
| 14490 | 490N | 1 X 6 | 25 X 152 | ⅜" (10mm) | ½" (13mm) |
| 14491 | 491N | 1 X 6 | 25 X 152 | ½" (13mm) | ⅝" (16mm) |
| 14508 | 508N | 1 X 6 | 25 X 152 | ¾" (19mm) | ⅞" (22mm) |
| 14513 | 513N | 2 X 6 | 51 X 152 | ⅜" (10mm) | ½" (13mm) |

Curved End Hand Edgers

- Available in carbon steel, stainless steel or blue steel with a sturdy mounting welded to the blade
- Both ends are curved up for use in either direction
- Resilient DuraSoft® handle provides a soft feel, reduces fatigue and offers excellent durability
- Used to produce a radius at the edge of a concrete slab to help prevent the edge from chipping
- Curved ends help prevent edger from digging into wet concrete
- Sold 6 per inner pack/6 per outer pack

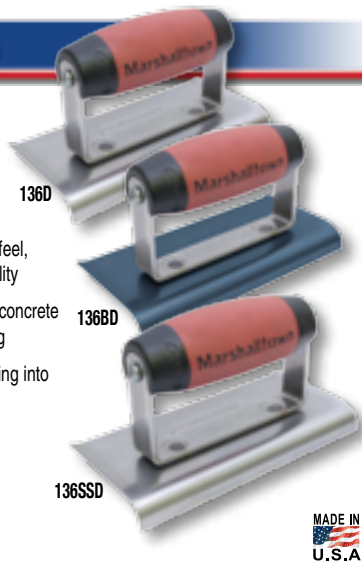

MARSHALLTOWN The Premier Line

Carbon Steel

| EDI | Part# | Size-in. | Size-mm | Radius | Lip |
|-------|-------|----------|-----------|-----------|-----------|
| 14146 | 136D | 6 X 3 | 152 X 76 | ⅜" (10mm) | ½" (13mm) |
| 14156 | 156D | 6 X 4 | 152 X 102 | ⅜" (10mm) | ½" (13mm) |
| 14149 | 138D | 6 X 4 | 152 X 102 | ½" (13mm) | ⅝" (16mm) |

Stainless Steel

| EDI | Part# | Size-in. | Size-mm | Radius | Lip |
|-------|--------|----------|-----------|-----------|-----------|
| 14190 | 136SSD | 6 X 3 | 152 X 76 | ⅜" (10mm) | ½" (13mm) |
| 14192 | 121SSD | 6 X 3 | 152 X 76 | ½" (13mm) | ⅝" (16mm) |
| 14180 | 155SSD | 6 X 4 | 152 X 102 | ¼" (6mm) | ⅜" (10mm) |
| 14182 | 156SSD | 6 X 4 | 152 X 102 | ⅜" (10mm) | ½" (13mm) |
| 14184 | 138SSD | 6 X 4 | 152 X 102 | ½" (13mm) | ⅝" (16mm) |

Blue Steel

| EDI | Part# | Size-in. | Size-mm | Radius | Lip |
|-------|-------|----------|-----------|-----------|-----------|
| 14174 | 136BD | 6 X 3 | 152 X 76 | ⅜" (10mm) | ½" (13mm) |
| 14176 | 121BD | 6 X 3 | 152 X 76 | ½" (13mm) | ⅝" (16mm) |
| 14164 | 155BD | 6 X 4 | 152 X 102 | ¼" (6mm) | ⅜" (10mm) |
| 14166 | 156BD | 6 X 4 | 152 X 102 | ⅜" (10mm) | ½" (13mm) |
| 14168 | 138BD | 6 X 4 | 152 X 102 | ½" (13mm) | ⅝" (16mm) |

Curved/Straight End Steel Hand Edger

- Made from carbon steel, with a sturdy mounting welded to the blade
- Resilient DuraSoft® handle provides a soft feel, reduces fatigue and offers excellent durability
- Used to produce a radius at the edge of a concrete slab to help prevent the edge from chipping
- Sold 6 per inner pack/6 per outer pack

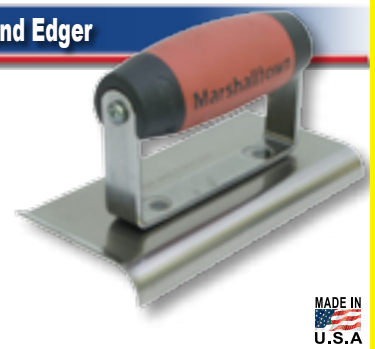

MARSHALLTOWN The Premier Line

| EDI | Part# | Size-in. | Size-mm | Radius | Lip |
|-------|-------|----------|----------|-----------|-----------|
| 14150 | 176D | 6 X 3 | 152 X 76 | ⅜" (10mm) | ½" (13mm) |

Chamfer Stainless Steel Hand Edgers

- Blade is made of heavy gauge stainless steel
- "N" in part number indicates a narrow blade
- Resilient DuraSoft® handle provides a soft feel, reduces fatigue and offers excellent durability
- Used to produce a bevel at the edge of a concrete slab to help prevent the edge from chipping
- Sold 1 per inner pack/6 per outer pack



MARSHALLTOWN The Premier Line

| EDI | Part# | Size-in. | Size-mm | Lip |
|-------|--------|----------|-----------|-----------|
| 14487 | 487NCH | 1 X 6 | 25 X 152 | ½" (13mm) |
| 14488 | 488NCH | 1 X 6 | 25 X 152 | ¾" (19mm) |
| 14479 | 479CH | 6 X 6 | 152 X 152 | ½" (13mm) |
| 14480 | 480CH | 6 X 8 | 152 X 203 | ½" (13mm) |
| 14481 | 481CH | 6 X 10 | 152 X 254 | ½" (13mm) |
| 14482 | 482CH | 6 X 12 | 152 X 305 | ½" (13mm) |
| 14483 | 483CH | 6 X 6 | 152 X 152 | ¾" (19mm) |
| 14484 | 484CH | 6 X 8 | 152 X 203 | ¾" (19mm) |
| 14485 | 485CH | 6 X 10 | 152 X 254 | ¾" (19mm) |
| 14486 | 486CH | 6 X 12 | 152 X 305 | ¾" (19mm) |

Big "I" Edgers

- Blade of heavy gauge stainless steel
- Heavy duty edgers fitted with a comfortable DuraSoft® float handle for easy handling and better control
- Sold 4 per inner pack/4 per outer pack



MADE IN
U.S.A.

MARSHALLTOWN The Premier Line

| EDI | Part# | Size-in. | Size-mm | Radius | Lip |
|-------|--------|----------|-----------|-------------|-------------|
| 14200 | 130SSD | 10 X 6 | 254 X 152 | 3/8" (10mm) | 1/2" (13mm) |
| 14202 | 132SSD | 10 X 6 | 254 X 152 | 1/2" (13mm) | 5/8" (16mm) |
| 14204 | 134SSD | 10 X 6 | 254 X 152 | 5/8" (16mm) | 7/8" (22mm) |
| 14206 | 135SSD | 10 X 6 | 254 X 152 | 3/4" (19mm) | 1" (25mm) |

Curved End Steel Hand Edger

- Both ends are curved up for use in either direction
- Used to produce a radius at the edge of a concrete slab to help prevent the end from chipping
- Sold 6 per inner pack/36 per outer pack



QLT^{BY} MARSHALLTOWN

| EDI | Part# | Size-in. | Size-mm | Radius | Lip |
|-------|-------|----------|----------|-------------|-------------|
| 13824 | CE384 | 6 X 3 | 152 X 76 | 3/8" (10mm) | 1/2" (13mm) |

Stainless Steel Hand Edgers

- Used to produce a radius at the edge of a concrete slab to help prevent the end from chipping
- Straight ends
- CE535S has curved ends*
- Sold 1 per inner pack/6 per outer pack



MADE IN
U.S.A.

QLT^{BY} MARSHALLTOWN

| EDI | Part# | Size-in. | Size-mm | Radius | Lip |
|-------|---------|-----------|-----------|-------------|-------------|
| 13880 | CE500S | 6 X 1 1/2 | 152 X 38 | 1/4" (6mm) | 3/8" (10mm) |
| 13882 | CE501S | 6 X 2 | 152 X 51 | 3/8" (10mm) | 1/2" (13mm) |
| 13884 | CE502S | 6 X 2 1/2 | 152 X 64 | 1/4" (6mm) | 3/8" (10mm) |
| 13886 | CE503S | 6 X 3 | 152 X 76 | 1/8" (3mm) | 1/4" (6mm) |
| 13888 | CE504S | 6 X 3 | 152 X 76 | 1/4" (6mm) | 3/8" (10mm) |
| 13950 | CE535S* | 6 X 3 | 152 X 76 | 1/4" (6mm) | 3/8" (10mm) |
| 13890 | CE505S | 6 X 3 1/2 | 152 X 89 | 3/8" (10mm) | 1/2" (13mm) |
| 13892 | CE506S | 6 X 4 | 152 X 102 | 1/8" (3mm) | 1/4" (6mm) |
| 13894 | CE507S | 6 X 4 | 152 X 102 | 1/4" (6mm) | 3/8" (10mm) |
| 13896 | CE508S | 6 X 4 | 152 X 102 | 3/8" (10mm) | 1/2" (13mm) |
| 13898 | CE509S | 6 X 4 | 152 X 102 | 1/2" (13mm) | 5/8" (16mm) |
| 13900 | CE510S | 6 X 4 | 152 X 102 | 3/4" (19mm) | 7/8" (22mm) |
| 13902 | CE511S | 6 X 6 | 152 X 152 | 1/8" (3mm) | 1/4" (6mm) |
| 13904 | CE512S | 6 X 6 | 152 X 152 | 1/4" (6mm) | 3/8" (10mm) |
| 13906 | CE513S | 6 X 6 | 152 X 152 | 3/8" (10mm) | 1/2" (13mm) |
| 13908 | CE514S | 6 X 6 | 152 X 152 | 1/2" (13mm) | 5/8" (16mm) |
| 13910 | CE515S | 6 X 6 | 152 X 152 | 3/4" (19mm) | 7/8" (22mm) |
| 13912 | CE516S | 8 X 4 | 203 X 102 | 1/8" (3mm) | 1/4" (6mm) |
| 13914 | CE517S | 8 X 4 | 203 X 102 | 1/4" (6mm) | 3/8" (10mm) |
| 13916 | CE518S | 8 X 4 | 203 X 102 | 3/8" (10mm) | 1/2" (13mm) |
| 13918 | CE519S | 8 X 4 | 203 X 102 | 1/2" (13mm) | 5/8" (16mm) |
| 13920 | CE520S | 8 X 4 | 203 X 102 | 3/4" (19mm) | 7/8" (22mm) |

QLT^{BY} MARSHALLTOWN

| EDI | Part# | Size-in. | Size-mm | Radius | Lip |
|-------|--------|-----------|-----------|-------------|---------------|
| 13922 | CE521S | 8 X 6 | 203 X 152 | 1/8" (3mm) | 1/4" (6mm) |
| 13924 | CE522S | 8 X 6 | 203 X 152 | 1/4" (6mm) | 3/8" (10mm) |
| 13926 | CE523S | 8 X 6 | 203 X 152 | 3/8" (10mm) | 1/2" (13mm) |
| 13928 | CE524S | 8 X 6 | 203 X 152 | 1/2" (13mm) | 5/8" (16mm) |
| 13930 | CE525S | 8 X 6 | 203 X 152 | 3/4" (19mm) | 7/8" (22mm) |
| 13932 | CE526S | 8 X 8 | 203 X 203 | 1/8" (3mm) | 1/4" (6mm) |
| 13934 | CE527S | 8 X 8 | 203 X 203 | 1/4" (6mm) | 3/8" (10mm) |
| 13936 | CE528S | 8 X 8 | 203 X 203 | 3/8" (10mm) | 1/2" (13mm) |
| 13938 | CE529S | 8 X 8 | 203 X 203 | 1/2" (13mm) | 5/8" (16mm) |
| 13940 | CE530S | 8 X 8 | 203 X 203 | 3/4" (19mm) | 7/8" (22mm) |
| 13963 | CE564S | 9 X 2 1/2 | 229 X 64 | 1/2" (13mm) | 5/8" (16mm) |
| 13965 | CE565S | 9 X 3 | 229 X 76 | 1/2" (13mm) | 5/8" (16mm) |
| 13967 | CE566S | 9 X 4 | 229 X 102 | 1/2" (13mm) | 5/8" (16mm) |
| 13969 | CE567S | 9 X 4 | 229 X 102 | 3/4" (19mm) | 3/4" (19mm) |
| 13975 | CE570S | 9 X 4 | 229 X 102 | 3/4" (19mm) | 1" (25mm) |
| 13971 | CE568S | 9 X 5 | 229 X 127 | 3/8" (10mm) | 1/2" (13mm) |
| 13973 | CE569S | 9 X 5 | 229 X 127 | 1/2" (13mm) | 5/8" (16mm) |
| 13942 | CE531S | 10 X 6 | 254 X 152 | 3/8" (10mm) | 1/2" (13mm) |
| 13944 | CE532S | 10 X 6 | 254 X 152 | 1/2" (13mm) | 5/8" (16mm) |
| 13946 | CE533S | 10 X 6 | 254 X 152 | 3/4" (19mm) | 7/8" (22mm) |
| 13948 | CE534S | 10 X 6 | 254 X 152 | 1" (25mm) | 1 1/8" (29mm) |

Stainless Steel Hand Edgers - Plastic Handle

- Black plastic handle does not slip or crack
- Used to produce a radius at the edge of a concrete slab to help prevent the edge from chipping
- **CE535SP** has curved ends*
- Sold 1 per inner pack/6 per outer pack



MADE IN
U.S.A

QLT BY MARSHALLTOWN

| EDI | Part# | Size-in. | Size-mm | Radius | Lip |
|-------|----------|----------|-----------|-----------|-----------|
| 10954 | CE500SP | 6 X 1½ | 152 X 38 | ¼" (6mm) | ⅜" (10mm) |
| 10955 | CE501SP | 6 X 2 | 152 X 51 | ⅜" (10mm) | ½" (13mm) |
| 10956 | CE502SP | 6 X 2½ | 152 X 64 | ¼" (6mm) | ⅜" (10mm) |
| 10957 | CE503SP | 6 X 3 | 152 X 76 | ½" (3mm) | ¼" (6mm) |
| 10958 | CE504SP | 6 X 3 | 152 X 76 | ¼" (6mm) | ⅜" (10mm) |
| 10989 | CE535SP* | 6 X 3 | 152 X 76 | ¼" (6mm) | ⅜" (10mm) |
| 10959 | CE505SP | 6 X 3½ | 152 X 89 | ⅜" (10mm) | ½" (13mm) |
| 10960 | CE506SP | 6 X 4 | 152 X 102 | ½" (3mm) | ¼" (6mm) |
| 10961 | CE507SP | 6 X 4 | 152 X 102 | ¼" (6mm) | ⅜" (10mm) |
| 10962 | CE508SP | 6 X 4 | 152 X 102 | ⅜" (10mm) | ½" (13mm) |
| 10963 | CE509SP | 6 X 4 | 152 X 102 | ½" (13mm) | ⅝" (16mm) |
| 10964 | CE510SP | 6 X 4 | 152 X 102 | ¾" (19mm) | ⅞" (22mm) |
| 10965 | CE511SP | 6 X 6 | 152 X 152 | ½" (3mm) | ¼" (6mm) |
| 10966 | CE512SP | 6 X 6 | 152 X 152 | ¼" (6mm) | ⅜" (10mm) |
| 10967 | CE513SP | 6 X 6 | 152 X 152 | ⅜" (10mm) | ½" (13mm) |
| 10968 | CE514SP | 6 X 6 | 152 X 152 | ½" (13mm) | ⅝" (16mm) |
| 10969 | CE515SP | 6 X 6 | 152 X 152 | ¾" (19mm) | ⅞" (22mm) |
| 10970 | CE516SP | 8 X 4 | 203 X 102 | ½" (3mm) | ¼" (6mm) |
| 10971 | CE517SP | 8 X 4 | 203 X 102 | ¼" (6mm) | ⅜" (10mm) |
| 10972 | CE518SP | 8 X 4 | 203 X 102 | ⅜" (10mm) | ½" (13mm) |
| 10973 | CE519SP | 8 X 4 | 203 X 102 | ½" (13mm) | ⅝" (16mm) |
| 10974 | CE520SP | 8 X 4 | 203 X 102 | ¾" (19mm) | ⅞" (22mm) |

QLT BY MARSHALLTOWN

| EDI | Part# | Size-in. | Size-mm | Radius | Lip |
|-------|---------|----------|-----------|-----------|------------|
| 10975 | CE521SP | 8 X 6 | 203 X 152 | ½" (3mm) | ¼" (6mm) |
| 10976 | CE522SP | 8 X 6 | 203 X 152 | ¼" (6mm) | ⅜" (10mm) |
| 10977 | CE523SP | 8 X 6 | 203 X 152 | ⅜" (10mm) | ½" (13mm) |
| 10978 | CE524SP | 8 X 6 | 203 X 152 | ½" (13mm) | ⅝" (16mm) |
| 10979 | CE525SP | 8 X 6 | 203 X 152 | ¾" (19mm) | ⅞" (22mm) |
| 10980 | CE526SP | 8 X 8 | 203 X 203 | ½" (3mm) | ¼" (6mm) |
| 10981 | CE527SP | 8 X 8 | 203 X 203 | ¼" (6mm) | ⅜" (10mm) |
| 10982 | CE528SP | 8 X 8 | 203 X 203 | ⅜" (10mm) | ½" (13mm) |
| 10983 | CE529SP | 8 X 8 | 203 X 203 | ½" (13mm) | ⅝" (16mm) |
| 10984 | CE530SP | 8 X 8 | 203 X 203 | ¾" (19mm) | ⅞" (22mm) |
| 10985 | CE531SP | 10 X 6 | 254 X 152 | ⅜" (10mm) | ½" (13mm) |
| 10986 | CE532SP | 10 X 6 | 254 X 152 | ½" (13mm) | ⅝" (16mm) |
| 10987 | CE533SP | 10 X 6 | 254 X 152 | ¾" (19mm) | ⅞" (22mm) |
| 10988 | CE534SP | 10 X 6 | 254 X 152 | 1" (25mm) | 1⅛" (28mm) |
| 10990 | CE564SP | 9 X 2½ | 229 X 64 | ½" (13mm) | ⅝" (16mm) |
| 10991 | CE565SP | 9 X 3 | 229 X 76 | ½" (13mm) | ⅝" (16mm) |
| 10992 | CE566SP | 9 X 4 | 229 X 102 | ½" (13mm) | ⅝" (16mm) |
| 10993 | CE567SP | 9 X 4 | 229 X 102 | ¾" (19mm) | ⅞" (22mm) |
| 10994 | CE568SP | 9 X 5 | 229 X 127 | ⅜" (10mm) | ½" (13mm) |
| 10995 | CE569SP | 9 X 5 | 229 X 127 | ½" (13mm) | ⅝" (16mm) |
| 10996 | CE570SP | 9 X 4 | 229 X 102 | ¾" (19mm) | 1" (25mm) |

Curved End Steel Hand Edger - Plastic Handle

- Black plastic handle does not slip or crack
- Both ends are curved up for use in either direction
- Sold 6 per inner pack/36 per outer pack



QLT BY MARSHALLTOWN

| EDI | Part# | Size-in. | Size-mm | Radius | Lip |
|-------|---------|----------|----------|-----------|-----------|
| 10929 | CE384P | 6 X 3 | 152 X 76 | ⅜" (10mm) | ½" (13mm) |
| 10989 | CE535SP | 6 X 3 | 152 X 76 | ¼" (6mm) | ⅜" (10mm) |

Blue Steel Hand Edgers

- High grade blue steel blade with sturdy steel mounting
- Straight ends
- Sold 1 per inner pack/12 per outer pack



QLT BY MARSHALLTOWN

| EDI | Part# | Size-in. | Size-mm | Radius | Lip |
|-------|--------|----------|-----------|-------------|---------------|
| 13960 | CE550B | 6 X 3 | 152 X 76 | 1/8" (3mm) | 3/8" (10mm) |
| 13962 | CE551B | 6 X 3 | 152 X 76 | 1/4" (6mm) | 3/8" (10mm) |
| 13964 | CE552B | 6 X 3 | 152 X 76 | 3/8" (10mm) | 1/2" (13mm) |
| 13966 | CE553B | 6 X 3 | 152 X 76 | 1/2" (13mm) | 5/8" (16mm) |
| 13951 | CE540B | 6 X 3 | 152 X 76 | 3/4" (19mm) | 7/8" (22mm) |
| 13968 | CE554B | 6 X 4 | 152 X 102 | 1/8" (3mm) | 3/8" (10mm) |
| 13970 | CE555B | 6 X 4 | 152 X 102 | 1/4" (6mm) | 3/8" (10mm) |
| 13972 | CE556B | 6 X 4 | 152 X 102 | 3/8" (10mm) | 1/2" (13mm) |
| 13974 | CE557B | 6 X 4 | 152 X 102 | 1/2" (13mm) | 5/8" (16mm) |
| 13952 | CE541B | 6 X 4 | 152 X 102 | 5/8" (16mm) | 7/8" (22mm) |
| 13976 | CE558B | 6 X 4 | 152 X 102 | 3/4" (19mm) | 7/8" (22mm) |
| 13953 | CE542B | 6 X 4 | 152 X 102 | 1" (25mm) | 1 1/8" (29mm) |
| 13978 | CE559B | 6 X 6 | 152 X 152 | 1/8" (3mm) | 3/8" (10mm) |
| 13980 | CE560B | 6 X 6 | 152 X 152 | 1/4" (6mm) | 3/8" (10mm) |
| 13982 | CE561B | 6 X 6 | 152 X 152 | 3/8" (10mm) | 1/2" (13mm) |
| 13984 | CE562B | 6 X 6 | 152 X 152 | 1/2" (13mm) | 5/8" (16mm) |
| 13954 | CE543B | 6 X 6 | 152 X 152 | 5/8" (16mm) | 7/8" (22mm) |
| 13986 | CE563B | 6 X 6 | 152 X 152 | 3/4" (19mm) | 7/8" (22mm) |
| 13955 | CE544B | 6 X 6 | 152 X 152 | 1" (25mm) | 1 1/8" (29mm) |
| 13956 | CE545B | 9 X 6 | 229 X 152 | 1/4" (6mm) | 3/8" (10mm) |
| 13957 | CE546B | 9 X 6 | 229 X 152 | 3/8" (10mm) | 1/2" (13mm) |
| 13958 | CE547B | 9 X 6 | 229 X 152 | 1/2" (13mm) | 5/8" (16mm) |
| 13961 | CE548B | 9 X 6 | 229 X 152 | 3/4" (19mm) | 7/8" (22mm) |

Curved End Steel Hand Edger

- Has a steel blade, steel mounting and wood handle
- Both ends are curved up for use in either direction
- Used to produce a radius at the edge of a concrete slab to help prevent the end from chipping
- Sold 12 per inner pack/60 per outer pack



QLT BY MARSHALLTOWN

| EDI | Part# | Size-in. | Size-mm | Radius | Lip |
|-------|-------|-----------|----------|-------------|-------------|
| 16492 | 92 | 6 X 2 3/4 | 152 X 70 | 3/8" (10mm) | 1/2" (13mm) |

Blue Steel Hand Edgers - Plastic Handle

- Black plastic handle does not slip or crack
- Used to produce a radius at the edge of a concrete slab to help prevent the edge from chipping
- Sold 1 per inner pack/12 per outer pack



QLT BY MARSHALLTOWN

| EDI | Part# | Size-in. | Size-mm | Radius | Lip |
|-------|---------|----------|-----------|-------------|---------------|
| 10940 | CE551BP | 6 X 3 | 152 X 76 | 1/4" (6mm) | 3/8" (10mm) |
| 10941 | CE552BP | 6 X 3 | 152 X 76 | 3/8" (10mm) | 1/2" (13mm) |
| 10942 | CE553BP | 6 X 3 | 152 X 76 | 1/2" (13mm) | 5/8" (16mm) |
| 10930 | CE540BP | 6 X 3 | 152 X 76 | 3/4" (19mm) | 7/8" (22mm) |
| 10943 | CE554BP | 6 X 4 | 152 X 102 | 1/8" (3mm) | 3/8" (10mm) |
| 10944 | CE555BP | 6 X 4 | 152 X 102 | 1/4" (6mm) | 3/8" (10mm) |
| 10945 | CE556BP | 6 X 4 | 152 X 102 | 3/8" (10mm) | 1/2" (13mm) |
| 10931 | CE541BP | 6 X 4 | 152 X 102 | 5/8" (16mm) | 7/8" (22mm) |
| 10947 | CE558BP | 6 X 4 | 152 X 102 | 3/4" (19mm) | 7/8" (22mm) |
| 10948 | CE559BP | 6 X 6 | 152 X 152 | 1/8" (3mm) | 3/8" (10mm) |
| 10933 | CE543BP | 6 X 6 | 152 X 152 | 5/8" (16mm) | 7/8" (22mm) |
| 10934 | CE544BP | 6 X 6 | 152 X 152 | 1" (25mm) | 1 1/8" (29mm) |
| 10935 | CE545BP | 9 X 6 | 229 X 152 | 1/4" (6mm) | 3/8" (10mm) |
| 10936 | CE546BP | 9 X 6 | 229 X 152 | 3/8" (10mm) | 1/2" (13mm) |
| 10937 | CE547BP | 9 X 6 | 229 X 152 | 1/2" (13mm) | 5/8" (16mm) |
| 10938 | CE548BP | 9 X 6 | 229 X 152 | 3/4" (19mm) | 7/8" (22mm) |

Heavy Duty Zinc Walking Edgers

- Made from high quality, long wearing zinc
- Curved up at both ends for easy push/pull motion
- Longer lasting and heavier than steel edgers
- Helps eliminate bending when edging large areas of concrete
- Use with our 9 or 10 handle (sold separately) see page 88 for details
- Sold 1 per inner pack/1 per outer pack



MADE IN
U.S.A

MARSHALLTOWN The Premier Line

| EDI | Part# | Size-in. | Size-mm | Radius | Lip |
|-------|-------|------------|-----------|------------|-------------|
| 14012 | 4012 | 9 X 4 | 229 X 102 | 1/4" (6mm) | 5/8" (16mm) |
| 14101 | 4013 | 9 X 2 3/16 | 229 X 55 | 1/4" (6mm) | 5/8" (16mm) |

Bronze Walking Edgers

- Made from high quality, long wearing bronze
- Finely finished to make smooth clean edges
- Curved up at both ends for easy push/pull motion
- Longer lasting and heavier than steel edgers
- Helps eliminate bending when edging large areas of concrete
- Use with our 9 or 10 handle (sold separately) see page 88 for details
- Sold 1 per inner pack/12 per outer pack



QLT BY MARSHALLTOWN

| EDI | Part# | Size-in. | Size-mm | Radius | Lip |
|-------|-------|----------|-----------|----------|-----------|
| 17593 | 7593 | 6 X 4 | 152 X 102 | ¼" (6mm) | ⅝" (16mm) |
| 17592 | 7592 | 9 X 4 | 229 X 102 | ¼" (6mm) | ¾" (19mm) |

Combo Adjust Stainless Steel Walking Edgers

- Made of heavy 16 gauge stainless steel
- Abrasion tests show these edgers will wear twice as long as other stainless steel edgers
- Cast aluminum combo adjust bracket riveted to a welded steel plate
- Use with 4822 or A3001 brackets
- Sold 1 per inner pack/1 per outer pack



MADE IN U.S.A.

MARSHALLTOWN The Premier Line

| EDI | Part# | Size-in. | Size-mm | Radius | Lip |
|-------|-------|----------|-----------|-----------|-----------|
| 13629 | 3629 | 8 X 4 | 203 X 102 | ⅜" (10mm) | ½" (13mm) |
| 13631 | 3631 | 10 X 6 | 254 X 152 | ⅜" (10mm) | ½" (13mm) |
| 13632 | 3632 | 10 X 6 | 254 X 152 | ½" (13mm) | ⅝" (16mm) |

Stainless Steel 2-Way Walking Edgers

- Made of heavy 16 gauge stainless steel
- Cast aluminum 2-way bracket riveted to a welded steel plate
- Use with our 9 or 10 handle (sold separately) see page 88 for details
- Sold 1 per inner pack/1 per outer pack

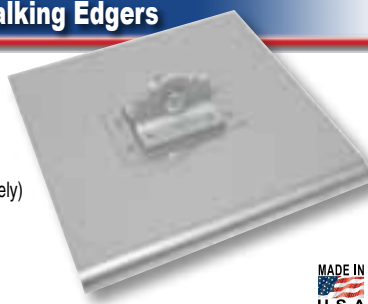

MADE IN U.S.A.

MARSHALLTOWN The Premier Line

| EDI | Part# | Size-in. | Size-mm | Radius | Lip |
|-------|-------|----------|-----------|-----------|-----------|
| 13620 | 3620 | 8 X 4 | 203 X 102 | ½" (13mm) | ⅝" (16mm) |
| 13621 | 3621 | 8 X 6 | 203 X 152 | ⅜" (10mm) | ½" (13mm) |
| 13625 | 3625 | 10 X 6 | 254 X 152 | ⅜" (10mm) | ½" (13mm) |
| 13626 | 3626 | 10 X 6 | 254 X 152 | ½" (13mm) | ⅝" (16mm) |
| 13627 | 3627 | 10 X 10 | 254 X 254 | ½" (13mm) | ⅝" (16mm) |
| 13628 | 3628 | 10 X 10 | 254 X 254 | ⅛" (3mm) | ½" (13mm) |

All-Angle Stainless Steel Walking Edgers

- Made of heavy 16 gauge stainless steel
- Abrasion tests show these edgers will wear twice as long as other stainless steel edgers
- Cast aluminum all angle bracket riveted to a welded steel plate
- Use with our 9 or 10 handle (sold separately) see page 88 for details
- Sold 1 per inner pack/1 per outer pack



MADE IN U.S.A.

MARSHALLTOWN The Premier Line

| EDI | Part# | Size-in. | Size-mm | Radius | Lip |
|-------|-------|----------|-----------|-----------|-----------|
| 13600 | 3600 | 8 X 4 | 203 X 102 | ¼" (6mm) | ⅜" (10mm) |
| 13601 | 3601 | 8 X 4 | 203 X 102 | ⅜" (10mm) | ½" (13mm) |
| 13602 | 3602 | 8 X 4 | 203 X 102 | ½" (13mm) | ⅝" (16mm) |
| 13603 | 3603 | 8 X 4 | 203 X 102 | ¾" (19mm) | ⅞" (22mm) |
| 13604 | 3604 | 8 X 6 | 203 X 152 | ¼" (6mm) | ⅜" (10mm) |
| 13605 | 3605 | 8 X 6 | 203 X 152 | ⅜" (10mm) | ½" (13mm) |
| 13606 | 3606 | 8 X 6 | 203 X 152 | ½" (13mm) | ⅝" (16mm) |
| 13607 | 3607 | 8 X 6 | 203 X 152 | ¾" (19mm) | ⅞" (22mm) |
| 13608 | 3608 | 8 X 8 | 203 X 203 | ¼" (6mm) | ⅜" (10mm) |
| 13609 | 3609 | 8 X 8 | 203 X 203 | ⅜" (10mm) | ½" (13mm) |
| 13610 | 3610 | 8 X 8 | 203 X 203 | ½" (13mm) | ⅝" (16mm) |
| 13611 | 3611 | 8 X 8 | 203 X 203 | ¾" (19mm) | ⅞" (22mm) |
| 13612 | 3612 | 10 X 6 | 254 X 152 | ⅜" (10mm) | ½" (13mm) |
| 13613 | 3613 | 10 X 6 | 254 X 152 | ⅜" (10mm) | ¾" (19mm) |
| 13614 | 3614 | 10 X 6 | 254 X 152 | ½" (13mm) | ⅝" (16mm) |
| 13615 | 3615 | 10 X 6 | 254 X 152 | ¾" (19mm) | ⅞" (22mm) |
| 13616 | 3616 | 10 X 10 | 254 X 254 | ⅛" (3mm) | ¾" (19mm) |
| 13617 | 3617 | 10 X 10 | 254 X 254 | ⅜" (10mm) | ½" (13mm) |
| 13618 | 3618 | 10 X 10 | 254 X 254 | ½" (13mm) | ⅝" (16mm) |
| 13619 | 3619 | 10 X 10 | 254 X 254 | ¾" (19mm) | ⅞" (22mm) |

Chamfer Stainless Steel Walking Edgers

- Made of heavy 16 gauge stainless steel
- Abrasion tests show these edgers will wear twice as long as other stainless steel edgers
- Used to produce a bevel at the edge of a concrete slab to help prevent the edge from chipping
- Cast aluminum 2-way bracket riveted to a welded steel plate
- Use with our 9 or 10 handle (sold separately) see page 88 for details
- Sold 1 per inner pack/1 per outer pack



MADE IN U.S.A.

MARSHALLTOWN The Premier Line

| EDI | Part# | Size-in. | Size-mm | Radius | Lip |
|-------|-------|----------|-----------|-----------|-----------|
| 13622 | 3622 | 10 X 6 | 254 X 152 | ½" (13mm) | ⅝" (16mm) |
| 13623 | 3623 | 10 X 6 | 254 X 152 | ¾" (19mm) | ½" (13mm) |
| 13624 | 3624 | 10 X 6 | 254 X 152 | 1" (25mm) | ½" (13mm) |

Stainless Steel Safety Step Walking Edger/Groover

- Forms a 3/4" (19mm) radius and a 1/4" (6mm) groove in one pass
- Groove is 7" (178mm) from outside edge
- All-angle bracket included
- Use with our 9 or 10 handle (sold separately) see page 88 for details
- Sold 1 per inner pack/1 per outer pack



MADE IN
U.S.A

MARSHALLTOWN The Premier Line

| EDI | Part# | Size-in. | Size-mm | Radius | Lip |
|-------|-------|----------|-----------|--------------|-------------|
| 13887 | 3887S | 6 X 8 | 152 X 203 | 3/4" (19 mm) | 5/8" (16mm) |

Walking Edgers

- Made of 16 gauge stainless steel or heavy gauge blue steel
- "B" after part number indicates a blue steel blade
- Slightly convex blade to prevent gouging
- Durable materials and construction mean these edgers will last
- All-angle swivel attachment included
- Helps eliminate bending when edging large areas of concrete
- Use with our 9 or 10 handle (sold separately) see page 88 for details
- Sold 1 per inner pack/1 per outer pack

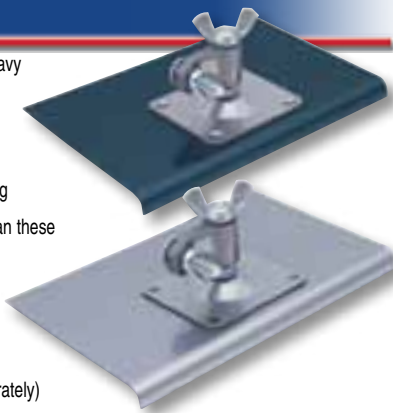

MADE IN
U.S.A

MARSHALLTOWN The Premier Line

| EDI | Part# | Size-in. | Size-mm | Radius | Lip |
|-------|-------|----------|-----------|-------------|-------------|
| 14112 | 122 | 9 X 4 | 229 X 102 | 3/8" (10mm) | 1/2" (13mm) |
| 14130 | 122B | 9 X 4 | 229 X 102 | 3/8" (10mm) | 1/2" (13mm) |
| 14114 | 123 | 9 X 4 | 229 X 102 | 1/2" (13mm) | 5/8" (16mm) |
| 14132 | 123B | 9 X 4 | 229 X 102 | 1/2" (13mm) | 5/8" (16mm) |
| 14134 | 126B | 9 X 6 | 229 X 152 | 1/4" (6mm) | 3/8" (10mm) |
| 14116 | 124 | 9 X 6 | 229 X 152 | 3/8" (10mm) | 1/2" (13mm) |
| 14136 | 124B | 9 X 6 | 229 X 152 | 3/8" (10mm) | 1/2" (13mm) |
| 14118 | 125 | 9 X 6 | 229 X 152 | 1/2" (13mm) | 5/8" (16mm) |

2-Way Walking Edgers

- Made of heavy 16 gauge stainless steel or heavy gauge blue steel
- Abrasion tests show these edgers will wear twice as long as other stainless steel edgers
- Slightly convex blade prevents gouging
- Two-way handle attachment included
- Helps eliminate bending when edging large areas of concrete
- Use with our 9 or 10 handle (sold separately) see page 88 for details
- Blue steel edgers sold 6 per inner pack/6 per outer pack
- Sold 1 per inner pack/1 per outer pack, 2 per inner pack/2 per outer pack where noted with *

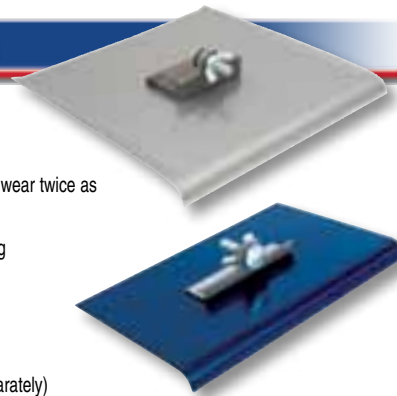

MADE IN
U.S.A

MARSHALLTOWN The Premier Line Stainless Steel

| EDI | Part# | Size-in. | Size-mm | Radius | Lip |
|-------|-------|----------|-----------|-------------|-------------|
| 14119 | 4119 | 10 X 10 | 254 X 254 | 1/2" (13mm) | 5/8" (16mm) |
| 14120 | 4120* | 10 X 6 | 254 X 152 | 3/8" (10mm) | 1/2" (13mm) |
| 14121 | 4121* | 8 X 4 | 203 X 102 | 3/8" (10mm) | 1/2" (13mm) |

Blue Steel

| EDI | Part# | Size-in. | Size-mm | Radius | Lip |
|-------|-------|----------|-----------|-------------|-------------|
| 14129 | 4129 | 9 X 4 | 229 X 102 | 3/8" (10mm) | 1/2" (13mm) |
| 14131 | 4131 | 9 X 4 | 229 X 102 | 1/2" (13mm) | 5/8" (16mm) |
| 14133 | 4133 | 9 X 6 | 229 X 152 | 1/4" (6mm) | 3/8" (10mm) |
| 14135 | 4135 | 9 X 6 | 229 X 152 | 3/8" (10mm) | 1/2" (13mm) |
| 14137 | 4137 | 9 X 6 | 229 X 152 | 1/2" (13mm) | 5/8" (16mm) |
| 14139 | 4139 | 9 X 8 | 229 X 203 | 1/2" (13mm) | 5/8" (16mm) |
| 14140 | 4140 | 9 X 10 | 229 X 254 | 1/2" (13mm) | 5/8" (16mm) |

Blue Steel 2-Way Walking Edgers

- Made of heavy gauge blue steel
- Mounting allows for 180° swivel
- 2-way handle attachment included
- Use with our 9 or 10 handle (sold separately) see page 88 for details
- Sold 1 per inner pack/6 per outer pack



QLT BY MARSHALLTOWN

| EDI | Part# | Size-in. | Size-mm. | Radius | Lip |
|-------|-------|----------|-----------|-----------|-----------|
| 13753 | 3753 | 9 X 4 | 229 X 102 | ¼" (6mm) | ⅜" (10mm) |
| 13759 | 3759 | 9 X 4 | 229 X 102 | ⅜" (10mm) | ½" (13mm) |
| 13765 | 3765 | 9 X 4 | 229 X 102 | ½" (13mm) | ⅝" (16mm) |
| 13772 | 3772 | 9 X 4 | 229 X 102 | ¾" (19mm) | ⅞" (22mm) |
| 13751 | 3751 | 9 X 6 | 229 X 152 | ⅛" (3mm) | ¼" (6mm) |
| 13754 | 3754 | 9 X 6 | 229 X 152 | ¼" (6mm) | ⅜" (10mm) |
| 13760 | 3760 | 9 X 6 | 229 X 152 | ⅜" (10mm) | ½" (13mm) |
| 13766 | 3766 | 9 X 6 | 229 X 152 | ½" (13mm) | ⅝" (16mm) |
| 13773 | 3773 | 9 X 6 | 229 X 152 | ¾" (19mm) | ⅞" (22mm) |
| 13752 | 3752 | 9 X 8 | 229 X 203 | ⅛" (3mm) | ¼" (6mm) |
| 13755 | 3755 | 9 X 8 | 229 X 203 | ¼" (6mm) | ⅜" (10mm) |
| 13761 | 3761 | 9 X 8 | 229 X 203 | ⅜" (10mm) | ½" (13mm) |
| 13767 | 3767 | 9 X 8 | 229 X 203 | ½" (13mm) | ⅝" (16mm) |
| 13774 | 3774 | 9 X 8 | 229 X 203 | ¾" (19mm) | ⅞" (22mm) |
| 13756 | 3756 | 9 X 10 | 229 X 254 | ¼" (6mm) | ⅜" (10mm) |
| 13762 | 3762 | 9 X 10 | 229 X 254 | ⅜" (10mm) | ½" (13mm) |
| 13768 | 3768 | 9 X 10 | 229 X 254 | ½" (13mm) | ⅝" (16mm) |
| 13775 | 3775 | 9 X 10 | 229 X 254 | ¾" (19mm) | ⅞" (22mm) |
| 13757 | 3757 | 9 X 12 | 229 X 305 | ¼" (6mm) | ⅜" (10mm) |
| 13763 | 3763 | 9 X 12 | 229 X 305 | ⅜" (10mm) | ½" (13mm) |
| 13769 | 3769 | 9 X 12 | 229 X 305 | ½" (13mm) | ⅝" (16mm) |
| 13771 | 3771 | 9 X 12 | 229 X 305 | ⅝" (16mm) | ¾" (19mm) |
| 13776 | 3776 | 9 X 12 | 229 X 305 | ¾" (19mm) | ⅞" (22mm) |
| 13758 | 3758 | 9 X 14 | 229 X 356 | ¼" (6mm) | ⅜" (10mm) |
| 13764 | 3764 | 9 X 14 | 229 X 356 | ⅜" (10mm) | ½" (13mm) |
| 13770 | 3770 | 9 X 14 | 229 X 356 | ½" (13mm) | ⅝" (16mm) |
| 13777 | 3777 | 9 X 14 | 229 X 356 | ¾" (19mm) | ⅞" (22mm) |

Curb/Nose & Cove/Base Tools

- Made of blue steel
- 4260D and 4262D are Curb/Nose tools
- 4260D-4266D are angled 104°, 4143D-4145D are angled 90°
- Sold 2 per inner pack/2 per outer pack, 6 per inner pack/6 per outer pack where noted with * , and 4 per inner pack/4 per outer pack where noted with **

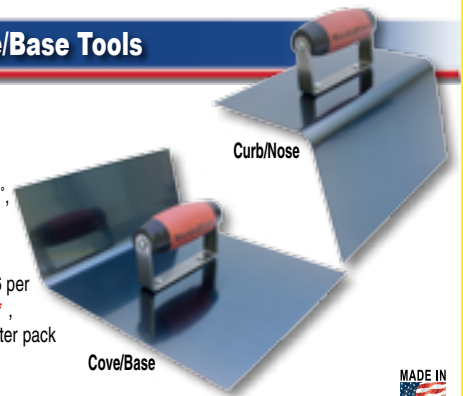

MADE IN
U.S.A

MARSHALLTOWN The Premier Line

| EDI | Part# | Size-in. | Size-mm. | Radius |
|-------|---------|-----------|-----------------|-----------|
| 14260 | 4260D | 9 X 5 X 5 | 229 X 127 X 127 | ½" (13mm) |
| 14262 | 4262D | 9 X 5 X 5 | 229 X 127 X 127 | ¾" (19mm) |
| 14264 | 4264D | 9 X 9 X 4 | 229 X 229 X 102 | ½" (13mm) |
| 14266 | 4266D | 9 X 9 X 4 | 229 X 229 X 102 | ¾" (19mm) |
| 14143 | 4143D* | 6 X 4 X 3 | 152 X 102 X 76 | 1" (25mm) |
| 14144 | 4144D* | 6 X 6 X 3 | 152 X 152 X 76 | 1" (25mm) |
| 14145 | 4145D** | 6 X 8 X 3 | 152 X 203 X 76 | 1" (25mm) |

Curb and Gutter Tools

- Made of heavy gauge stainless steel
- Resilient DuraSoft® handle provides a soft feel, reduces fatigue and offers excellent durability
- 104° blade angle
- All blades measure 6"(152mm) wide
- Sold 4 per inner pack/4 per outer pack

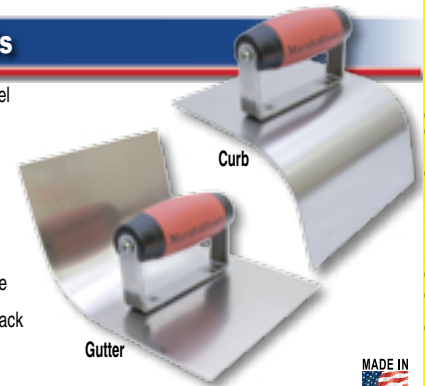

CONCRETE TOOLS

MADE IN
U.S.A

MARSHALLTOWN The Premier Line

Curb Hand Tools

| EDI | Part# | Top X Face-in. | Top X Face-mm | Radius |
|-------|----------|----------------|---------------|-------------|
| 15143 | CT197SSD | 5 X 3½ | 127 X 89 | 1½" (38 mm) |
| 14270 | 4270D | 5 X 3½ | 127 X 89 | 2" (51mm) |
| 14272 | 4272D | 5 X 3½ | 127 X 89 | 3" (76mm) |
| 15140 | CG514SSD | 4 X 6 | 102 X 152 | 2" (51 mm) |

Gutter Hand Tools

| EDI | Part# | Face X Bottom-in. | Face X Bottom-mm | Radius |
|-------|----------|-------------------|------------------|-------------|
| 15144 | GT198SSD | 4½ X 6 | 114 X 152 | 1½" (38 mm) |
| 14274 | 4274D | 4½ X 6 | 114 X 152 | 2" (51mm) |
| 14276 | 4276D | 4½ X 6 | 114 X 152 | 3" (76mm) |

Curb & Gutter Tools

- 6 in. (152mm) wide
- Made of heavy gauge stainless steel
- Resilient DuraSoft® handle provides a soft feel, reduces fatigue and offers excellent durability
- Ideal tool for finishing curbs and gutters
- Single piece design saves time and effort
- Walking versions use all-angle clevis bracket
- Sold 1 per inner pack/1 per outer pack

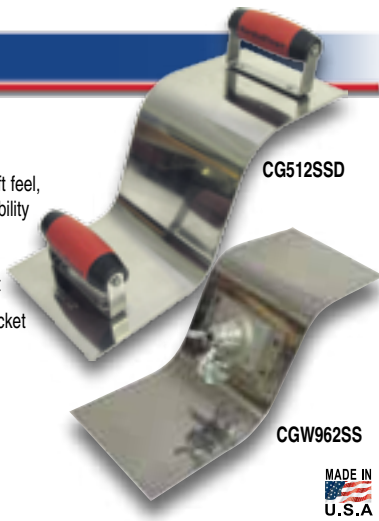

MADE IN
U.S.A

MARSHALLTOWN The Premier Line

Curb & Gutter Hand Tools

| EDI | Part# | Top X Face X Bottom | Curb Radius | Gutter Radius |
|-------|----------|--|----------------|----------------|
| 15137 | CG511SSD | 6 X 6 X 6" (152 X 152 X 152mm) | 2" (51 mm) | 3" (76 mm) |
| 15138 | CG512SSD | 6 X 6 X 6" (152 X 152 X 152mm) | 3" (76 mm) | 2" (51 mm) |
| 15139 | CG513SSD | 4 X 6 X 3" (102 X 152 X 76mm) | 2" (51 mm) | 90° |
| 15141 | CG650SSD | 4 1/4 X 6 X 4" (108 X 152 X 102 mm) | 1 1/2" (38 mm) | 1 1/2" (38 mm) |
| 15142 | CG651SSD | 4 X 8 X 2 3/4" (102 X 203 X 70mm) | 3/4" (19 mm) | 3/4" (19 mm) |

Walking Curb & Gutter Tools

| EDI | Part# | Top X Face X Bottom | Curb Radius | Gutter Radius |
|-------|----------|--|----------------|----------------|
| 15152 | CGW961SS | 4 1/4 X 6 X 4" (108 X 152 X 102 mm) | 1 1/2" (38 mm) | 1 1/2" (38 mm) |
| 15153 | CGW962SS | 6 X 6 X 4" (152 X 152 X 102 mm) | 2" (51 mm) | 3" (76 mm) |

Driveway Approach Tools

- 6 in. (152mm) wide
- Made of heavy gauge stainless steel
- Resilient DuraSoft® handle provides a soft feel, reduces fatigue and offers excellent durability
- Ideal tool for finishing driveway approaches
- Single piece design saves time and effort
- Walking versions use all-angle clevis bracket
- Walking version not compatible with hand version
- Sold 1 per inner pack/1 per outer pack



MADE IN
U.S.A

MARSHALLTOWN The Premier Line

Driveway Approach Hand Tools

| EDI | Part# | Top X Drop X Bottom | Radius |
|-------|----------|-----------------------------------|--------------|
| 15145 | DA097SSD | 5 X 1 X 4" (127 X 25 X 102 mm) | 3/4" (19 mm) |
| 15146 | DA098SSD | 5 X 1 X 4" (127 X 25 X 102 mm) | 1/2" (13 mm) |
| 15147 | DA099SSD | 5 X 1 X 4" (127 X 25 X 102 mm) | 1" (25mm) |

Walking Driveway Approach Tools

| EDI | Part# | Top X Drop X Bottom | Radius |
|-------|----------|-----------------------------------|--------------|
| 15148 | DAW360SS | 6 X 1 X 4" (152 X 25 X 102 mm) | 1/2" (13 mm) |
| 15149 | DAW361SS | 6 X 1 X 6" (152 X 25 X 152 mm) | 1/2" (13 mm) |
| 15150 | DAW362SS | 6 X 1 X 4" (152 X 25 X 102 mm) | 3/4" (19 mm) |
| 15151 | DAW363SS | 6 X 1 X 6" (152 X 25 X 152 mm) | 3/4" (19 mm) |

Curb/Sidewalk Tools

- Made of stainless steel
- Resilient DuraSoft® handle provides a soft feel, reduces fatigue and offers excellent durability
- Blades measure 6 X 4" (152 X 102 mm) with a 1 1/2" (38mm) lip and 3/4" (19mm) radius.
- Sold 4 per inner pack/4 per outer pack

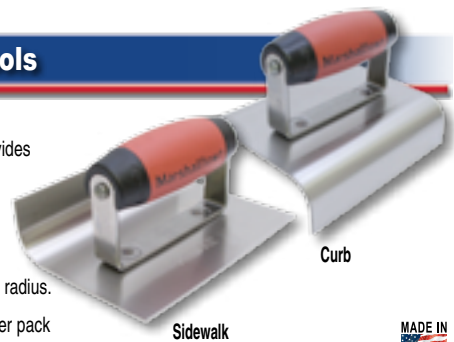

MADE IN
U.S.A

MARSHALLTOWN The Premier Line

| EDI | Part# | Type |
|-------|-------|-------------|
| 14268 | 4268D | Curb OS |
| 14269 | 4269D | Sidewalk IS |

Acrylic Step Tools

- Made of acrylic
- Resilient DuraSoft® handle provides a soft feel, reduces fatigue and offers excellent durability
- Helps prevent the concrete edge from chipping off.
- 90° blade angle
- Sold 4 per inner pack/4 per outer pack

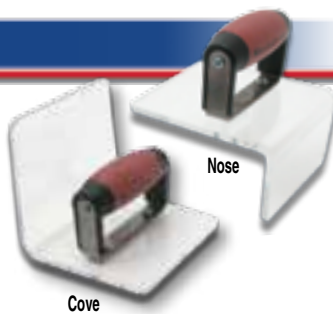

MADE IN
U.S.A.

Stainless Steel Corner Trowels

- Sturdy steel mounting
- Resilient DuraSoft® handle provides a soft feel, reduces fatigue and offers excellent durability
- Used to form inside and outside corners
- Ideal for steps or anywhere requiring a square or rounded corner
- Sold 6 per inner pack/6 per outer pack.

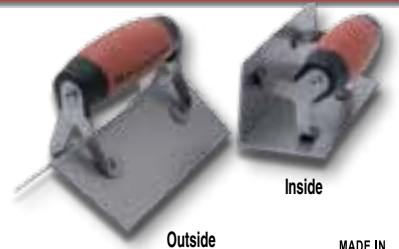

MADE IN
U.S.A.

MARSHALLTOWN The Premier Line

| EDI | Part# | Size-in. | Size-mm | Radius | Type |
|-------|-------|-----------------------|-----------------|-------------|------|
| 14261 | 4261D | 5 5/8 X 5 1/4 X 2 3/4 | 143 X 133 X 70 | 1/2" (13mm) | Nose |
| 14263 | 4263D | 5 5/8 X 5 1/4 X 2 3/4 | 143 X 133 X 70 | 3/4" (19mm) | Nose |
| 14265 | 4265D | 5 5/8 X 5 X 5 | 143 X 127 X 127 | 1/2" (13mm) | Cove |
| 14267 | 4267D | 5 5/8 X 5 X 5 | 143 X 127 X 127 | 3/4" (19mm) | Cove |

MARSHALLTOWN The Premier Line

| EDI | Part# | Size-in. | Size-mm | Radius | Type |
|-------|-------|-----------|----------|--------------|---------|
| 14122 | 65SSD | 6 X 2 1/2 | 152 X 64 | Sq. | Inside |
| 14124 | 66SSD | 6 X 2 1/2 | 152 X 64 | 1/2" (13 mm) | Inside |
| 14126 | 67SSD | 6 X 2 1/2 | 152 X 64 | Sq. | Outside |
| 14128 | 68SSD | 6 X 2 1/2 | 152 X 64 | 1/2" (13 mm) | Outside |

Stainless Steel Step Tools

- Made of heavy gauge stainless steel with sturdy steel mountings
- Resilient DuraSoft® handle provides a soft feel, reduces fatigue and offers excellent durability
- 1/2" (13mm) radius and 4" (102mm) lip
- Sold 4 per inner pack/4 per outer pack, sold as a set where noted with * (1 cove and 1 nose)

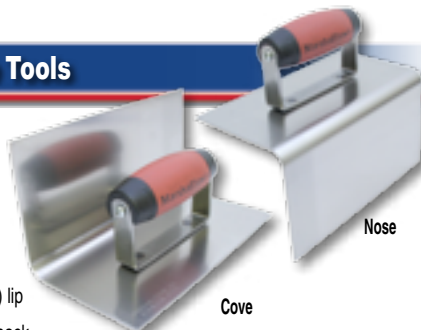

MADE IN
U.S.A.

Corner Trowels

- Steel blade and mounting
- Mortised wood handle
- Used to form inside and outside corners
- Sold 6 per inner pack/60 per outer pack

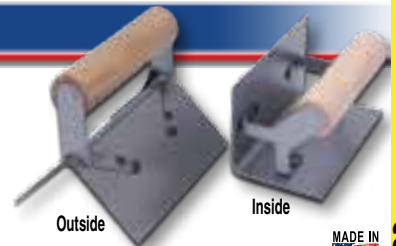

MADE IN
U.S.A.

MARSHALLTOWN The Premier Line

| EDI | Part# | Size-in. | Size-mm | Angle | Type |
|-------|---------|----------|-----------|-------|------|
| 14210 | 170SSD | 8 X 4 | 203 X 102 | 90° | Cove |
| 14218 | 177SSD | 8 X 4 | 203 X 102 | 82° | Cove |
| 14212 | 171SSD | 8 X 4 | 203 X 102 | 90° | Nose |
| 14220 | 178SSD | 8 X 4 | 203 X 102 | 82° | Nose |
| 14230 | 172SSD* | 8 X 4 | 203 X 102 | 90° | Set |
| 14232 | 179SSD* | 8 X 4 | 203 X 102 | 82° | Set |

QLT[™] MARSHALLTOWN

| EDI | Part# | Size-in. | Size-mm | Type |
|-------|-------|--------------|----------|---------|
| 16141 | 941 | 5 X 2 1/2 IS | 127 X 64 | Inside |
| 16142 | 942 | 5 X 2 1/2 OS | 127 X 64 | Outside |

Blue Steel Step Tools

- Made of blue steel
- Resilient DuraSoft® handle provides a soft feel, reduces fatigue and offers excellent durability
- 174BD and 186BD are cove tools, 175BD and 187BD are nose tools
- 90° blade angle
- Sold 4 per inner pack/4 per outer pack

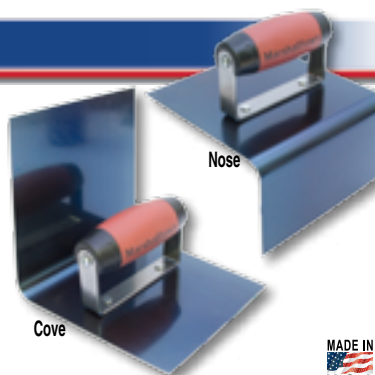

MADE IN
U.S.A.

Stainless Steel Safety Step Edger/Groover

- 4280D is used to cut four grooves, 3/4" (19mm) apart and 1/4" (6mm) deep and an edge radius of 1/2" (13mm)
- Creates a safety tread effect on steps
- Forms a 1/2" (13mm) or 3/4" (19mm) radius and a 1/4" (6mm) groove in one pass
- Groove is 7" (178mm) from outside edge where marked with a *
- Sold 6 per inner pack/6 per outer pack



MADE IN
U.S.A.

MARSHALLTOWN The Premier Line

| EDI | Part# | Size-in. | Size-mm | Radius |
|-------|-------|-----------|-----------------|-------------|
| 14214 | 174BD | 6 X 6 X 6 | 152 X 152 X 152 | 1/2" (13mm) |
| 14240 | 186BD | 6 X 6 X 6 | 152 X 152 X 152 | 3/8" (10mm) |
| 14216 | 175BD | 6 X 6 X 3 | 152 X 152 X 76 | 1/2" (13mm) |
| 14242 | 187BD | 6 X 6 X 3 | 152 X 152 X 76 | 3/8" (10mm) |

| EDI | Part# | Size-in. | Size-mm | Radius | Lip |
|-------|---------|----------|-----------|--------------|-------------|
| 14280 | 4280D | 6 X 5 | 152 X 127 | 1/2" (13mm) | 5/8" (16mm) |
| 13885 | 3885SD* | 6 X 8 | 152 X 152 | 1/2" (12 mm) | 5/8" (16mm) |
| 14283 | 4283D* | 6 X 8 | 152 X 152 | 3/4" (19 mm) | 7/8" (22mm) |
| 13881 | 3881SD* | 6 X 10 | 152 X 254 | 3/4" (19 mm) | 7/8" (22mm) |
| 13883 | 3883SD* | 6 X 12 | 152 X 305 | 3/4" (19 mm) | 7/8" (22mm) |

Stainless Steel Safety Step Groover

- Used to cut six grooves, 3/4" (19mm) apart, 3/16" (5mm) deep
- Creates a safety tread effect on steps
- Sold 6 per inner pack/6 per outer pack

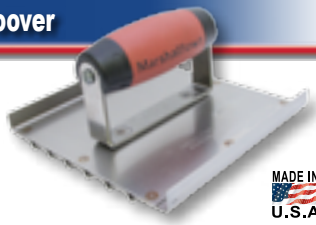

MADE IN
U.S.A.

MARSHALLTOWN The Premier Line

| EDI | Part# | Size-in. | Size-mm | Radius | Depth |
|-------|-------|----------|-----------|------------|-------------|
| 14282 | 4282D | 6 X 6 | 152 X 152 | 1/8" (3mm) | 3/16" (5mm) |

Wheel Chair Groovers

- Creates grooves 1/4" (6mm) wide, 1/4" (6mm) deep with 2 1/4" (57mm) spacing
- Intended for grooving safety ramps, etc.
- WCG093W comes with the all-angle adjustable bracket with a threaded handle socket
- Sold 1 per inner pack/1 per outer pack

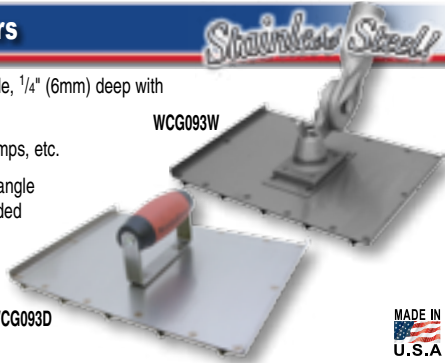

MADE IN
U.S.A.

MARSHALLTOWN The Premier Line

| EDI | Part# | Size-in. | Size-mm | Radius | Depth |
|-------|---------|----------|-----------|------------|------------|
| 13633 | WCG093D | 8 X 10 | 203 X 254 | 1/4" (6mm) | 1/4" (6mm) |
| 13634 | WCG093W | 8 X 10 | 203 X 254 | 1/4" (6mm) | 1/4" (6mm) |

Stainless Steel Hand Edgers w/Adjustable Groover

- Made of heavy 16 gauge stainless steel
- Blade size is 14 X 5" (356 X 127mm)
- Ideal for creating decorative borders in fresh concrete
- Designed to accept all fresno groover attachments, see page 67 for dimensions
- Bronze groover is adjustable and tightens with two thumbscrews
- Sold 1 per inner pack/1 per outer pack



MADE IN
U.S.A.

MARSHALLTOWN The Premier Line

| EDI | Part# | Edger Radius | Bit Depth | Groover # |
|-------|-------|--------------|-------------|-----------|
| 13485 | 3485D | 3/8" (10mm) | 1/4" (6mm) | 7545 |
| 13486 | 3486D | 1/2" (13mm) | 1/4" (6mm) | 7545 |
| 13487 | 3487D | 3/4" (19mm) | 1/4" (6mm) | 7545 |
| 13488 | 3488D | 3/8" (10mm) | 1/2" (13mm) | 7554 |
| 13489 | 3489D | 1/2" (13mm) | 1/2" (13mm) | 7554 |
| 13490 | 3490D | 3/4" (19mm) | 1/2" (13mm) | 7554 |
| 13491 | 3491D | 3/8" (10mm) | 3/4" (19mm) | 7555 |
| 13492 | 3492D | 1/2" (13mm) | 3/4" (19mm) | 7555 |
| 13493 | 3493D | 3/4" (19mm) | 3/4" (19mm) | 7555 |
| 13494 | 3494D | 3/8" (10mm) | 1" (25mm) | 7556 |
| 13495 | 3495D | 1/2" (13mm) | 1" (25mm) | 7556 |
| 13496 | 3496D | 3/4" (19mm) | 1" (25mm) | 7556 |

Stainless Steel Texas Groovers

- Edges angled up for use with guide, allowing for straighter grooves
- Resilient DuraSoft® handle provides a soft feel, reduces fatigue and offers excellent durability
- Used to cut grooves 1/4" (6mm) deep and 3/4" (19mm) wide
- TG640D, TWG640, TWG644 and TG644D meet Texas Accessibility specifications for detectable ramp warning
- All 6" groovers have 3 grooves, all 8" groovers have 4 grooves
- Sold 1 per inner pack/1 per outer pack



MADE IN
U.S.A.

MARSHALLTOWN The Premier Line

| EDI | Part# | Size-in. | Size-mm | Centers |
|-------|--------|------------|-----------|---------------|
| 10642 | TG642D | 6 X 6 | 152 X 152 | 2" (51mm) |
| 10640 | TG640D | 7 5/8 X 6 | 194 X 152 | 2 3/4" (70mm) |
| 10646 | TG646D | 8 X 8 | 203 X 203 | 2" (51mm) |
| 10644 | TG644D | 10 5/8 X 8 | 264 X 203 | 2 3/4" (70mm) |

Walking Groovers

| EDI | Part# | Size-in. | Size-mm | Centers |
|-------|--------|------------|-----------|---------------|
| 10643 | TWG642 | 6 X 6 | 152 X 152 | 2" (51mm) |
| 10641 | TWG640 | 7 5/8 X 6 | 194 X 152 | 2 3/4" (70mm) |
| 10647 | TWG646 | 8 X 8 | 203 X 203 | 2" (51mm) |
| 10645 | TWG644 | 10 5/8 X 8 | 264 X 203 | 2 3/4" (70mm) |

Stainless Steel Walking Edgers w/Adjustable Groover

- Made of heavy 16 gauge stainless steel
- Blade size is 14 X 5" (356 X 127mm)
- Ideal for creating decorative borders in fresh concrete
- Designed to accept all fresno groover attachments, see page 67 for dimensions
- Bronze groover is adjustable and tightens with two thumbscrews
- Use with our 9 or 10 handle (sold separately) see page 88 for details
- Sold 1 per inner pack/1 per outer pack



MADE IN
U.S.A.

MARSHALLTOWN The Premier Line

| EDI | Part# | Edger Radius | Bit Depth | Groover # |
|-------|-------|--------------|-------------|-----------|
| 13497 | 3485W | 3/8" (10mm) | 1/4" (6mm) | 7545 |
| 13498 | 3486W | 1/2" (13mm) | 1/4" (6mm) | 7545 |
| 13499 | 3487W | 3/4" (19mm) | 1/4" (6mm) | 7545 |
| 13500 | 3488W | 3/8" (10mm) | 1/2" (13mm) | 7554 |
| 13501 | 3489W | 1/2" (13mm) | 1/2" (13mm) | 7554 |
| 13502 | 3490W | 3/4" (19mm) | 1/2" (13mm) | 7554 |
| 13503 | 3491W | 3/8" (10mm) | 3/4" (19mm) | 7555 |
| 13504 | 3492W | 1/2" (13mm) | 3/4" (19mm) | 7555 |
| 13505 | 3493W | 3/4" (19mm) | 3/4" (19mm) | 7555 |
| 13506 | 3494W | 3/8" (10mm) | 1" 25mm | 7556 |
| 13507 | 3495W | 1/2" (13mm) | 1" (25mm) | 7556 |
| 13508 | 3496W | 3/4" (19mm) | 1" (25mm) | 7556 |

Heavy Duty Zinc Hand Groover

- Made from high quality, long wearing zinc
- Resilient DuraSoft® handle provides a soft feel, reduces fatigue and offers excellent durability
- Smooth finish allows for easier cleanup
- Finely finished to cut sharp clean grooves
- Sold 1 per inner pack/6 per outer pack, sold 12 per outer pack where noted with*



MADE IN
U.S.A.

MARSHALLTOWN The Premier Line

| EDI | Part# | Size-in. | Size-mm | Radius | Width | Depth |
|-------|-------|---------------------|-----------|----------------------|------------------------|-------------------------|
| 14105 | 833D | 6 X 4 $\frac{3}{8}$ | 152 X 111 | $\frac{1}{4}$ " 6mm | $\frac{3}{8}$ " (10mm) | $\frac{1}{2}$ " (13mm) |
| 14106 | 834D | 6 X 4 $\frac{3}{8}$ | 152 X 111 | $\frac{1}{4}$ " 6mm | $\frac{3}{8}$ " (10mm) | $\frac{3}{4}$ " (19mm) |
| 14107 | 835D | 6 X 4 $\frac{3}{8}$ | 152 X 111 | $\frac{1}{4}$ " 6mm | $\frac{3}{8}$ " (10mm) | 1" (25mm) |
| 14103 | 864D | 6 X 4 $\frac{3}{8}$ | 152 X 111 | $\frac{5}{16}$ " 8mm | $\frac{5}{8}$ " (16mm) | $\frac{3}{4}$ " (19mm) |
| 14104 | 865D* | 6 X 4 $\frac{3}{8}$ | 152 X 111 | $\frac{1}{8}$ " 3mm | $\frac{1}{4}$ " (6mm) | $\frac{3}{4}$ " (19mm) |
| 14109 | 866D* | 6 X 4 $\frac{3}{8}$ | 152 X 111 | $\frac{1}{8}$ " 3mm | $\frac{5}{16}$ " (8mm) | $\frac{3}{8}$ " (10mm) |
| 14110 | 867D* | 6 X 4 $\frac{3}{8}$ | 152 X 111 | $\frac{3}{16}$ " 5mm | $\frac{1}{2}$ " (13mm) | $1\frac{1}{4}$ " (32mm) |
| 14111 | 868D* | 6 X 4 $\frac{3}{8}$ | 152 X 111 | $\frac{1}{8}$ " 3mm | $\frac{3}{4}$ " (19mm) | $1\frac{1}{2}$ " (38mm) |

All Steel Groovers

- High-strength, hard alloyed steel for exceptional blade durability
- Edges are turned up for use with a straightedge guide
- Gusseted mounting post for added rigidity
- Wide Bit Groovers feature a one piece blade which produces a wider grooving bit
- Powder coated finish
- Reversible DuraSoft® handle can be positioned two ways (pictured at right)
- Sold 1 per inner pack/2 per outer pack

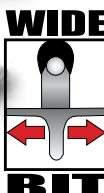

MADE IN
U.S.A.

MARSHALLTOWN The Premier Line

| EDI | Part# | Size-in. | Size-mm | Radius | Depth |
|-------|-------|----------|-----------|------------------------|------------------------|
| 14038 | 4038D | 6 X 6 | 152 X 152 | $\frac{1}{4}$ " (6mm) | $\frac{1}{2}$ " (13mm) |
| 14039 | 4039D | 6 X 6 | 152 X 152 | $\frac{1}{2}$ " (13mm) | $\frac{1}{2}$ " (13mm) |
| 14040 | 4040D | 6 X 6 | 152 X 152 | $\frac{3}{4}$ " (19mm) | $\frac{1}{2}$ " (13mm) |
| 14041 | 4041D | 6 X 6 | 152 X 152 | $\frac{1}{4}$ " (6mm) | $\frac{3}{4}$ " (19mm) |
| 14042 | 4042D | 6 X 6 | 152 X 152 | $\frac{1}{2}$ " (13mm) | $\frac{3}{4}$ " (19mm) |
| 14043 | 4043D | 6 X 6 | 152 X 152 | $\frac{3}{4}$ " (19mm) | $\frac{3}{4}$ " (19mm) |
| 14044 | 4044D | 6 X 6 | 152 X 152 | $\frac{1}{4}$ " (6mm) | 1" (25mm) |
| 14045 | 4045D | 6 X 6 | 152 X 152 | $\frac{1}{2}$ " (13mm) | 1" (25mm) |
| 14046 | 4046D | 6 X 6 | 152 X 152 | $\frac{3}{4}$ " (19mm) | 1" (25mm) |

Wide Bit All Steel Groovers

| EDI | Part# | Size-in. | Size-mm | Radius | Depth |
|-------|-------|----------|-----------|------------------------|-----------|
| 13100 | 13100 | 6 X 6 | 152 X 152 | $\frac{1}{4}$ " (6mm) | 1" (25mm) |
| 13101 | 13101 | 6 X 6 | 152 X 152 | $\frac{1}{2}$ " (13mm) | 1" (25mm) |
| 13102 | 13102 | 6 X 6 | 152 X 152 | $\frac{3}{4}$ " (19mm) | 1" (25mm) |

Bronze Hand Groovers

- Made from high quality, long wearing bronze
- Comfortable soft grip or wood handle
- Finely finished to make smooth clean grooves
- "W" indicates a wood handle
- Sold 1 per inner pack/12 per outer pack

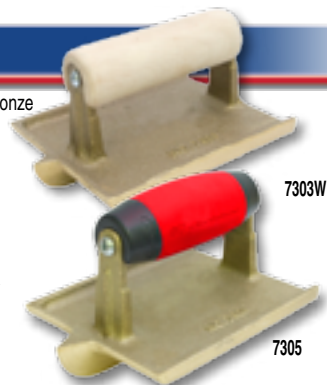

7303W

7305

MARSHALLTOWN

| EDI | Part# | Size-in. | Size-mm | Radius | Width | Depth |
|-------|-------|-----------------------------------|-----------|------------------------|------------------------|-------------------------|
| 10424 | 7260W | 5 $\frac{1}{2}$ X 3 | 140 X 76 | $\frac{1}{4}$ " (6mm) | $\frac{5}{16}$ " (8mm) | $\frac{3}{8}$ " (10mm) |
| 10425 | 7301W | 6 X 2 | 152 X 51 | $\frac{1}{4}$ " (6mm) | $\frac{3}{16}$ " (5mm) | $\frac{3}{16}$ " (5mm) |
| 10423 | 7380W | 6 $\frac{1}{2}$ X 3 | 165 X 76 | $\frac{1}{8}$ " (6mm) | $\frac{3}{8}$ " (10mm) | $\frac{3}{4}$ " (19mm) |
| 10419 | 7303W | 6 X 4 $\frac{1}{2}$ | 152 X 114 | $\frac{1}{4}$ " (6mm) | $\frac{3}{8}$ " (10mm) | $\frac{1}{2}$ " (13mm) |
| 10422 | 7408W | 6 X 4 $\frac{1}{2}$ | 152 X 114 | $\frac{1}{4}$ " (6mm) | $\frac{5}{8}$ " (16mm) | $\frac{5}{8}$ " (16mm) |
| 10416 | 7304W | 6 X 4 $\frac{1}{2}$ | 152 X 114 | $\frac{3}{8}$ " (10mm) | $\frac{7}{8}$ " (22mm) | $\frac{3}{4}$ " (19mm) |
| 10418 | 7305W | 6 X 4 $\frac{1}{2}$ | 152 X 114 | $\frac{1}{4}$ " (6mm) | $\frac{3}{8}$ " (10mm) | $\frac{3}{4}$ " (19mm) |
| 10417 | 7314W | 6 X 4 $\frac{1}{2}$ | 152 X 114 | $\frac{1}{4}$ " (6mm) | $\frac{1}{2}$ " (13mm) | 1" (25mm) |
| 10426 | 7316W | 6 X 4 $\frac{1}{2}$ | 152 X 114 | $\frac{1}{2}$ " (13mm) | 1" (25mm) | $1\frac{1}{4}$ " (32mm) |
| 10421 | 7315W | 6 X 4 $\frac{1}{2}$ | 152 X 114 | $\frac{1}{4}$ " (6mm) | $\frac{1}{2}$ " (13mm) | $1\frac{1}{2}$ " (38mm) |
| 10428 | 7319W | 6 X 6 | 152 X 152 | $\frac{3}{8}$ " (10mm) | $\frac{5}{8}$ " (16mm) | $\frac{3}{4}$ " (19mm) |
| 10420 | 7317W | 7 $\frac{1}{2}$ X 4 $\frac{1}{2}$ | 191 X 114 | $\frac{1}{4}$ " (6mm) | $\frac{1}{2}$ " (13mm) | $1\frac{1}{2}$ " (38mm) |
| 10427 | 7374W | 8 X 4 $\frac{1}{2}$ | 203 X 152 | $\frac{1}{4}$ " (6mm) | $\frac{1}{2}$ " (13mm) | 1" (25mm) |
| 10436 | 7260 | 5 $\frac{1}{2}$ X 3 | 140 X 76 | $\frac{1}{4}$ " (6mm) | $\frac{5}{16}$ " (8mm) | $\frac{3}{8}$ " (10mm) |
| 10437 | 7301 | 6 X 2 | 152 X 51 | $\frac{1}{4}$ " (6mm) | $\frac{3}{16}$ " (5mm) | $\frac{3}{16}$ " (5mm) |
| 10435 | 7380 | 6 $\frac{1}{2}$ X 3 | 165 X 76 | $\frac{1}{8}$ " (6mm) | $\frac{3}{8}$ " (10mm) | $\frac{3}{4}$ " (19mm) |
| 10431 | 7303 | 6 X 4 $\frac{1}{2}$ | 152 X 114 | $\frac{1}{4}$ " (6mm) | $\frac{3}{8}$ " (10mm) | $\frac{1}{2}$ " (13mm) |
| 10434 | 7408 | 6 X 4 $\frac{1}{2}$ | 152 X 114 | $\frac{1}{4}$ " (6mm) | $\frac{5}{8}$ " (16mm) | $\frac{5}{8}$ " (16mm) |
| 17304 | 7304 | 6 X 4 $\frac{1}{2}$ | 152 X 114 | $\frac{3}{8}$ " (10mm) | $\frac{7}{8}$ " (22mm) | $\frac{3}{4}$ " (19mm) |
| 10430 | 7305 | 6 X 4 $\frac{1}{2}$ | 152 X 114 | $\frac{1}{4}$ " (6mm) | $\frac{3}{8}$ " (10mm) | $\frac{3}{4}$ " (19mm) |
| 10429 | 7314 | 6 X 4 $\frac{1}{2}$ | 191 X 114 | $\frac{1}{4}$ " (6mm) | $\frac{1}{2}$ " (13mm) | 1" (25mm) |
| 10438 | 7316 | 6 X 4 $\frac{1}{2}$ | 152 X 114 | $\frac{1}{2}$ " (13mm) | 1" (25mm) | $1\frac{1}{4}$ " (32mm) |
| 10433 | 7315 | 6 X 4 $\frac{1}{2}$ | 152 X 114 | $\frac{1}{4}$ " (6mm) | $\frac{1}{2}$ " (13mm) | $1\frac{1}{2}$ " (29mm) |
| 10440 | 7319 | 6 X 6 | 152 X 152 | $\frac{3}{8}$ " (10mm) | $\frac{5}{8}$ " (16mm) | $\frac{3}{4}$ " (19mm) |
| 10432 | 7317 | 7 $\frac{1}{2}$ X 4 $\frac{1}{2}$ | 191 X 114 | $\frac{1}{4}$ " (6mm) | $\frac{1}{2}$ " (13mm) | $1\frac{1}{2}$ " (38mm) |
| 10439 | 7374 | 8 X 4 $\frac{1}{2}$ | 203 X 152 | $\frac{1}{4}$ " (6mm) | $\frac{1}{2}$ " (13mm) | 1" (25mm) |

Control Joint Hand Groover

- Lightweight aluminum construction
- Perfect for cutting long straight joints with ease
- Ideal for use in decorative concrete
- Sold 2 per inner pack/2 per outer pack
- Available in inner pack quantities only



Control Joint
Walking Groovers
see page 65

MADE IN
U.S.A.

MARSHALLTOWN The Premier Line

| EDI | Part# | Size-in. | Size-mm | Radius | Depth |
|-------|-------|----------|---------|-----------------------|-------------------------|
| 15549 | 15549 | 12 | 305 | $\frac{1}{4}$ " (6mm) | $1\frac{1}{2}$ " (13mm) |

Stainless Steel Rocker Groover

- Groover blade has a slight bow which gives this tool a "rocker" effect
- Made of heavy gauge stainless steel and strengthened by a stiffening strip
- Powder coat finish
- Sold 6 per inner pack/6 per outer pack
- Available in inner pack quantities only



MADE IN
U.S.A

MARSHALLTOWN The Premier Line

| EDI | Part# | Size-in. | Size-mm | Radius | Depth |
|-------|-------|----------|----------|----------|-----------|
| 11790 | 1790D | 6 X 3½ | 150 X 90 | ¼" (6mm) | ½" (13mm) |

Stainless Steel Western Groover

- Stainless steel blade measures 2" (51mm) wide and 3" (76mm) long
- Cuts ⅜ X ⅜" (4.8 X 4.8mm) groove
- Sold 1 per inner pack/4 per outer pack



MADE IN
U.S.A

MARSHALLTOWN The Premier Line

| EDI | Part# | Size-in. | Size-mm | Width | Depth |
|-------|-------|----------|---------|------------|------------|
| 14113 | 4113D | 2 X 3 | 51 X 76 | ⅜" (4.8mm) | ⅜" (4.8mm) |

Stainless Steel Hand Groover

- Blade made of stainless steel with sturdy steel mounting
- Properly shaped bit and leading edge cut a sharp groove
- Sold 6 per inner pack/6 per outer pack



MADE IN
U.S.A

MARSHALLTOWN The Premier Line

| EDI | Part# | Size-in. | Size-mm | Radius | Width | Depth |
|-------|-------|----------|----------|----------|-----------|-----------|
| 14102 | 180D | 6 X 3 | 152 X 76 | ¼" (6mm) | ½" (13mm) | ½" (13mm) |

Steel Hand Groover

- Sturdy steel mounting and blade
- Properly shaped bit and leading edge cut a sharp groove and finishes clean
- Sold 6 per inner pack/36 per outer pack



QLT-MARSHALLTOWN

| EDI | Part# | Size-in. | Size-mm | Radius | Width | Depth |
|-------|-------|----------|----------|----------|-----------|-----------|
| 13836 | CG396 | 6 X 3 | 152 X 76 | ¼" (6mm) | ½" (13mm) | ½" (13mm) |

Steel Hand Groover

- Black plastic handle does not slip or crack
- Properly shaped bit and leading edge cut a sharp groove and finishes clean
- Sold 6 per inner pack/36 per outer pack



QLT-MARSHALLTOWN

| EDI | Part# | Size-in. | Size-mm | Radius | Width | Depth |
|-------|--------|----------|----------|----------|-----------|-----------|
| 10953 | CG396P | 6 X 3 | 152 X 76 | ¼" (6mm) | ½" (13mm) | ½" (13mm) |

Steel Hand Groover

- Sturdy steel mounting and blade
- Properly shaped bit and leading edge cut a sharp groove and finishes clean
- Sold 6 per inner pack/36 per outer pack



QLT-MARSHALLTOWN

| EDI | Part# | Size-in. | Size-mm | Radius | Width | Depth |
|-------|-------|----------|----------|----------|-----------|-----------|
| 16491 | 91 | 6 X 2¾ | 152 X 70 | ¼" (6mm) | ½" (13mm) | ½" (13mm) |

Edger/Groover Handle

- Made of smooth hardwood
- This straight handle easily attaches to the mounting on most **MARSHALLTOWN** edgers and groovers
- Sold 1 per inner pack/12 per outer pack



MARSHALLTOWN The Premier Line

| EDI | Part# | Diameter-in. | Diameter-mm |
|-------|-------|--------------|-------------|
| 19118 | 403 | 1⅝ | 35 |

Zinc Double End Walking Groovers

- Made from high quality, long wearing zinc
- Has the weight and finish to cut quickly and cleanly
- Double end bit permits use in either direction
- Helps eliminate bending when working large areas
- Use with our 9 or 10 handle (sold separately) see page 88 for details
- Sold 1 per inner pack/12 per outer pack



MADE IN
U.S.A

MARSHALLTOWN The Premier Line

| EDI | Part# | Size-in. | Size-mm | Radius | Width | Depth |
|-------|-------|----------|-----------|----------|-----------|-----------|
| 14108 | 836 | 8 X 4¾ | 203 X 111 | ¼" (6mm) | ⅝" (10mm) | 1" (25mm) |
| 14100 | 869 | 8 X 4¾ | 203 X 111 | ¼" (6mm) | ½" (13mm) | 1" (25mm) |

Bronze Walking Groovers

- Made from high quality, long wearing bronze
- Finely finished to make smooth clean grooves
- **8275** has a double ended bit (pictured above) *
- Helps eliminate bending when working large areas
- Use with our 9 or 10 handle (sold separately) see page 88 for details
- Sold 1 per inner pack/12 per outer pack

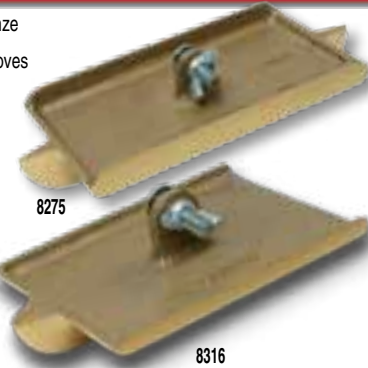

QLT BY MARSHALLTOWN

| EDI | Part# | Size-in. | Size-mm | Radius | Width | Depth |
|-------|-------|----------|-----------|-----------|-----------|------------|
| 10443 | 8303 | 6 X 4½ | 152 X 114 | ¼" (6mm) | ⅝" (10mm) | ½" (13mm) |
| 10445 | 8308 | 6 X 4½ | 152 X 114 | ¼" (6mm) | ⅝" (16mm) | ⅝" (16mm) |
| 18304 | 8304 | 6 X 4½ | 152 X 114 | ⅜" (10mm) | ⅞" (16mm) | ¾" (19mm) |
| 10442 | 8305 | 6 X 4½ | 152 X 114 | ¼" (6mm) | ⅝" (10mm) | ¾" (19mm) |
| 10441 | 8314 | 6 X 4½ | 152 X 114 | ¼" (6mm) | ½" (13mm) | 1" (25mm) |
| 10446 | 8316 | 6 X 4½ | 152 X 114 | ½" (13mm) | 1" (25mm) | 1¼" (32mm) |
| 10444 | 8317 | 7½ X 4½ | 191 X 114 | ¼" (6mm) | ½" (13mm) | 1½" (38mm) |
| 10449 | 8374 | 8 X 4½ | 203 X 114 | ¼" (6mm) | ½" (13mm) | 1" (25mm) |
| 10451 | 8277 | 8 X 8 | 203 X 203 | ⅛" (6mm) | ¼" (6mm) | ¾" (19mm) |
| 10450 | 8276 | 8 X 8 | 203 X 203 | ¼" (6mm) | ⅝" (10mm) | ¾" (19mm) |
| 10447 | 8278 | 8 X 8 | 203 X 203 | ¼" (6mm) | ⅝" (10mm) | 1" (25mm) |
| 10448 | 8279 | 8 X 8 | 203 X 203 | ¼" (6mm) | ⅝" (16mm) | 1½" (38mm) |
| 10452 | 8275* | 8 X 4½ | 203 X 203 | ¼" (6mm) | ½" (13mm) | 1" (25mm) |

All-Angle Stainless Steel Walking Groovers

- Stainless steel blade
- Properly shaped bit and leading edge to cut sharp groove
- Great for working in tight spaces
- Use with our 9 or 10 handle (sold separately) see page 88 for details
- **180W** sold 1 per inner pack/2 per outer pack, **180A** sold 2 per inner pack/2 per outer pack

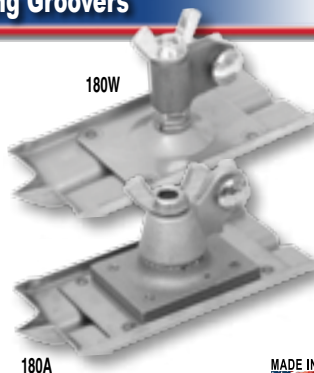

MADE IN U.S.A

MARSHALLTOWN The Premier Line

| EDI | Part# | Size-in. | Size-mm | Radius | Width | Depth |
|-------|-------|----------|----------|----------|-----------|-----------|
| 14155 | 180A | 6 X 3 | 152 X 76 | ¼" (6mm) | ½" (13mm) | ½" (13mm) |
| 14117 | 180W | 6 X 3 | 152 X 76 | ¼" (6mm) | ½" (13mm) | ½" (13mm) |

Chicago Groovers

- Heavy gauge stainless steel construction with welded capped ends
- Walking version comes with removable bull float bracket that can be replaced with other brackets such as the Rock-It™ or RL6 (sold separately)
- Hand groovers features a DuraSoft® handle for increased grip and less fatigue
- Sold 1 per inner pack/1 per outer pack



MADE IN U.S.A

MARSHALLTOWN The Premier Line

Chicago Hand Groovers

| EDI | Part# | Size-in. | Size-mm | Radius | Depth |
|-------|-----------|----------|-----------|-----------|-----------|
| 11581 | CG81814D | 8 X 8 | 203 X 203 | ⅛" (3mm) | ¼" (6mm) |
| 11582 | CG81412D | 8 X 8 | 203 X 203 | ¼" (6mm) | ½" (13mm) |
| 11583 | CG83812D | 8 X 8 | 203 X 203 | ⅜" (10mm) | ½" (13mm) |
| 11584 | CG81234D | 8 X 8 | 203 X 203 | ½" (13mm) | ¾" (19mm) |
| 11585 | CG83478D | 8 X 8 | 203 X 203 | ¾" (19mm) | ⅞" (22mm) |
| 11590 | CG101814D | 10 X 10 | 254 X 254 | ⅛" (3mm) | ¼" (6mm) |
| 11591 | CG101412D | 10 X 10 | 254 X 254 | ¼" (6mm) | ½" (13mm) |
| 11592 | CG103812D | 10 X 10 | 254 X 254 | ⅜" (10mm) | ½" (13mm) |
| 11593 | CG101234D | 10 X 10 | 254 X 254 | ½" (13mm) | ¾" (19mm) |
| 11594 | CG103478D | 10 X 10 | 254 X 254 | ¾" (19mm) | ⅞" (22mm) |

Chicago Walking Groovers

| EDI | Part# | Size-in. | Size-mm | Radius | Depth |
|-------|-----------|----------|-----------|-----------|-----------|
| 11586 | CG81412W | 8 X 8 | 203 X 203 | ¼" (6mm) | ½" (13mm) |
| 11587 | CG83812W | 8 X 8 | 203 X 203 | ⅜" (10mm) | ½" (13mm) |
| 11588 | CG81234W | 8 X 8 | 203 X 203 | ½" (13mm) | ¾" (19mm) |
| 11589 | CG83478W | 8 X 8 | 203 X 203 | ¾" (19mm) | ⅞" (22mm) |
| 11595 | CG101412W | 10 X 10 | 254 X 254 | ¼" (6mm) | ½" (13mm) |
| 11596 | CG103812W | 10 X 10 | 254 X 254 | ⅜" (10mm) | ½" (13mm) |
| 11597 | CG101234W | 10 X 10 | 254 X 254 | ½" (13mm) | ¾" (19mm) |
| 11598 | CG103478W | 10 X 10 | 254 X 254 | ¾" (19mm) | ⅞" (22mm) |

Control Joint Walking Groover

- Lightweight aluminum construction
- Perfect for cutting long straight joints with ease
- Ideal for use in decorative concrete
- Red tipped sight allows for more accurate grooving
- Use with our 9 or 10 handle (sold separately) see page 88 for details
- Sold 2 per inner pack/2 per outer pack

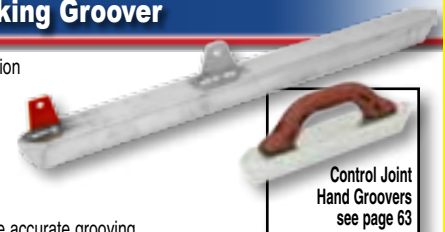

Control Joint Hand Groovers see page 63

MADE IN U.S.A

MARSHALLTOWN The Premier Line

| EDI | Part# | Size-in. | Size-mm | Radius | Depth |
|-------|-------|----------|---------|----------|------------|
| 15551 | 15551 | 24 | 610 | ¼" (6mm) | 1½" (48mm) |
| 15553 | 15553 | 36 | 914 | ¼" (6mm) | 1½" (48mm) |
| 15555 | 15555 | 48 | 1245 | ¼" (6mm) | 1½" (48mm) |
| 15557 | 15557 | 60 | 1524 | ¼" (6mm) | 1½" (48mm) |
| 15559 | 15559 | 72 | 1829 | ¼" (6mm) | 1½" (48mm) |

Cast Aluminum Groovers

- Made from hard aluminum
- Oversized wrap-around bit serves as a sight for making straight grooves
- Round ends help eliminate finishing marks
- Smooth surfaces for easy clean up
- 4098 comes with clevis bracket*
- 4099 comes with RL6 RotaLeveler®**
- Sold 1 per inner pack/1 per outer pack

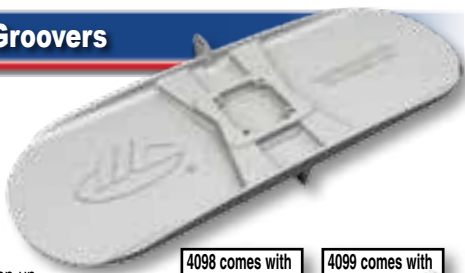

MADE IN
U.S.A

MARSHALLTOWN The Premier Line

| EDI | Part# | Size-in. | Size-mm | Radius | Width | Depth |
|-------|--------|-------------|-----------|------------|-------------|---------------|
| 14097 | 4097 | 24 X 8 3/4" | 610 X 222 | 1/4" (6mm) | 1/2" (13mm) | 1 1/4" (32mm) |
| 14098 | 4098* | 24 X 8 3/4" | 610 X 222 | 1/4" (6mm) | 1/2" (13mm) | 1 1/4" (32mm) |
| 14099 | 4099** | 24 X 8 3/4" | 610 X 222 | 1/4" (6mm) | 1/2" (13mm) | 1 1/4" (32mm) |

All Steel Stealth Groovers

- Cuts grooves into and away from corners and other tight areas
- High strength, hard alloyed steel for exceptional durability
- Powder coat finish
- Large, easy to see sight for straight grooves
- Sold 1 per inner pack/1 per outer pack

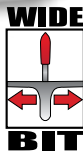

MADE IN
U.S.A

MARSHALLTOWN The Premier Line

| EDI | Part# | Size-in. | Size-mm | Radius | Depth |
|-------|---------|----------|-----------|-------------|-------------|
| 16957 | SG14090 | 8 X 10 | 203 X 254 | 1/2" (13mm) | 1" (25mm) |
| 16959 | SG14088 | 8 X 10 | 203 X 254 | 3/4" (19mm) | 3/4" (19mm) |
| 16960 | SG14091 | 8 X 10 | 203 X 254 | 3/4" (19mm) | 1" (25mm) |

Wide Bit All Steel Walking Groovers

| EDI | Part# | Size-in. | Size-mm | Radius | Depth |
|-------|---------|----------|-----------|-------------|-----------|
| 16958 | SG13072 | 8 X 10 | 203 X 254 | 1/2" (13mm) | 1" (25mm) |
| 16961 | SG13073 | 8 X 10 | 203 X 254 | 3/4" (19mm) | 1" (25mm) |

Bull Float Brackets & 2-Post Clevis Brackets

- For more details and size options see pages 85-88

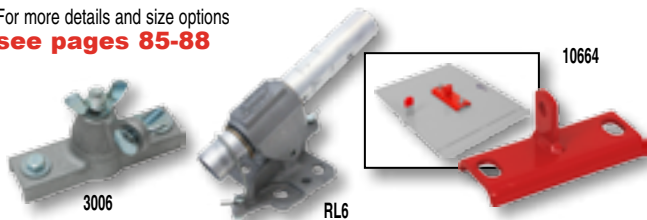

3006

RL6

10664

All Steel Walking Groovers

- High strength, hard alloyed steel for exceptional durability
- 8 X 10" (203 X 254mm) features a clevis attachment; 12 X 14" (305 X 356mm) has a dual post attachment
- Wide Bit Groovers feature a one piece blade which produces a wider grooving bit
- Powder coat finish
- Large easy to see sight for straight grooves
- Sold 1 per inner pack/1 per outer pack

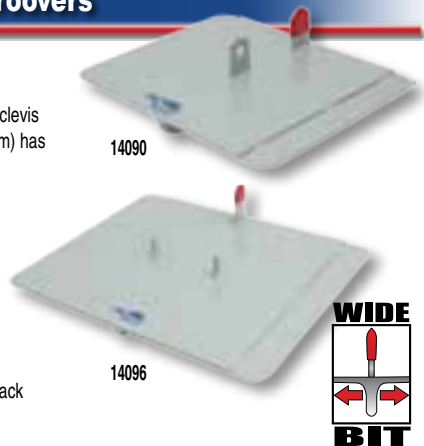

14090

14096



MADE IN
U.S.A

MARSHALLTOWN The Premier Line

| EDI | Part# | Size-in. | Size-mm | Radius | Depth |
|-------|-------|----------|-----------|-------------|-------------|
| 14047 | 14047 | 8 X 10 | 203 X 254 | 1/4" (6mm) | 1/2" (13mm) |
| 14048 | 14048 | 8 X 10 | 203 X 254 | 1/2" (13mm) | 1/2" (13mm) |
| 14049 | 14049 | 8 X 10 | 203 X 254 | 3/4" (19mm) | 1/2" (13mm) |
| 14055 | 14055 | 8 X 10 | 203 X 254 | 1/4" (6mm) | 3/4" (19mm) |
| 14082 | 14082 | 8 X 10 | 203 X 254 | 1/2" (13mm) | 3/4" (19mm) |
| 14088 | 14088 | 8 X 10 | 203 X 254 | 3/4" (19mm) | 3/4" (19mm) |
| 14089 | 14089 | 8 X 10 | 203 X 254 | 1/4" (6mm) | 1" (25mm) |
| 14090 | 14090 | 8 X 10 | 203 X 254 | 1/2" (13mm) | 1" (25mm) |
| 14091 | 14091 | 8 X 10 | 203 X 254 | 3/4" (19mm) | 1" (25mm) |
| 14092 | 14092 | 12 X 14 | 305 X 356 | 1/4" (6mm) | 1/2" (13mm) |
| 14093 | 14093 | 12 X 14 | 305 X 356 | 1/2" (13mm) | 1/2" (13mm) |
| 14094 | 14094 | 12 X 14 | 305 X 356 | 3/4" (19mm) | 1/2" (13mm) |
| 14095 | 14095 | 12 X 14 | 305 X 356 | 1/4" (6mm) | 3/4" (19mm) |
| 14096 | 14096 | 12 X 14 | 305 X 356 | 1/2" (13mm) | 3/4" (19mm) |
| 14141 | 14141 | 12 X 14 | 305 X 356 | 3/4" (19mm) | 3/4" (19mm) |
| 14148 | 14148 | 12 X 14 | 305 X 356 | 1/4" (6mm) | 1" (25mm) |
| 14151 | 14151 | 12 X 14 | 305 X 356 | 1/2" (13mm) | 1" (25mm) |
| 14153 | 14153 | 12 X 14 | 305 X 356 | 3/4" (19mm) | 1" (25mm) |

Wide Bit All Steel Walking Groovers

| EDI | Part# | Size-in. | Size-mm | Radius | Depth |
|-------|-------|----------|-----------|-------------|-----------|
| 13071 | 13071 | 8 X 10 | 203 X 254 | 1/4" (6mm) | 1" (25mm) |
| 13072 | 13072 | 8 X 10 | 203 X 254 | 1/2" (13mm) | 1" (25mm) |
| 13073 | 13073 | 8 X 10 | 203 X 254 | 3/4" (19mm) | 1" (25mm) |
| 13074 | 13074 | 12 X 14 | 305 X 356 | 1/4" (6mm) | 1" (25mm) |
| 13075 | 13075 | 12 X 14 | 305 X 356 | 1/2" (13mm) | 1" (25mm) |
| 13076 | 13076 | 12 X 14 | 305 X 356 | 3/4" (19mm) | 1" (25mm) |

Bull Float Groover Attachments

- Made from durable hardened aluminum
- Two thumbscrews are used to tighten the attachment to the bull float
- Slide easily over any 8" (203mm) magnesium bull float to give the ability to form grooves or expansion joints
- Sold 1 per inner pack/1 per outer pack

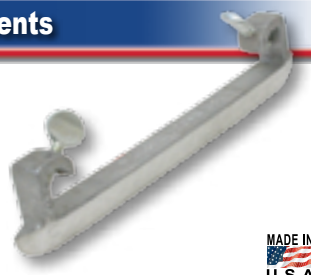

MADE IN
U.S.A.

MARSHALLTOWN The Premier Line

| EDI | Part# | Radius | Width | Depth |
|-------|-------|----------|-----------|------------|
| 14710 | 4710 | ¼" (6mm) | ¾" (19mm) | ¾" (19mm) |
| 14712 | 4712 | ¼" (6mm) | ¾" (19mm) | 1" (25mm) |
| 14714 | 4714 | ¼" (6mm) | ¾" (19mm) | 1½" (38mm) |

Bronze Bull Float Groover Attachments

- Made from high quality, long wearing bronze
- Finely finished to make smooth clean grooves
- Two thumbscrews are used to tighten the attachment to the bull float
- Slide easily over any magnesium bull float to give the ability to form grooves or expansion joints
- Sold 1 per inner pack/12 per outer pack



QLT-MARSHALLTOWN

| EDI | Part# | Radius | Width | Depth |
|-------|-------|----------|--------------|------------|
| 17550 | 7550 | ¼" (6mm) | ¾" (10mm) | ¾" (19mm) |
| 17551 | 7551 | ¼" (6mm) | ¾" (10mm) | 1" (25mm) |
| 17552 | 7552 | ¼" (6mm) | ¾" (10mm) | 1½" (38mm) |
| 17553 | 7553 | ¼" (6mm) | ¾" (10mm) | 2" (51mm) |
| 17546 | 7546 | ¼" (6mm) | 7/16" (11mm) | 1½" (38mm) |
| 17547 | 7547 | ¼" (6mm) | 9/16" (14mm) | 2" (51mm) |

Fresno Groover Attachments

- Made from durable hardened aluminum
- Thumbscrews tighten groover attachment to the trowel blade
- Designed to slip easily over a fresno
- Gives the user a tool similar to a walking groover
- Sold 2 per inner pack/2 per outer pack

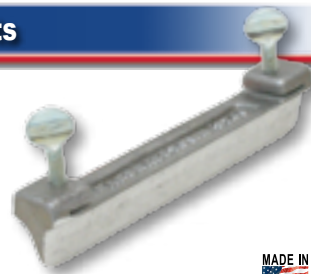

MADE IN
U.S.A.

MARSHALLTOWN The Premier Line

| EDI | Part# | Radius | Width | Depth |
|-------|-------|----------|---------------|-----------|
| 13740 | 3740 | ¼" (6mm) | 13/16" (21mm) | ¾" (19mm) |
| 13742 | 3742 | ¼" (6mm) | 13/16" (21mm) | 1" (25mm) |

Bronze Fresno Groover Attachments

- Made from high quality, long wearing bronze
- Finely finished to make smooth clean grooves
- Two thumbscrews are used to tighten the attachment to the fresno
- Slide easily over any fresno to give the ability to form grooves or expansion joints
- Sold 1 per inner pack/12 per outer pack

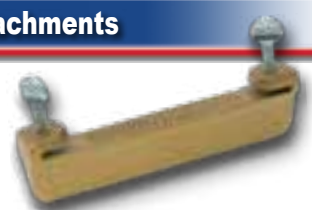

QLT-MARSHALLTOWN

| EDI | Part# | Radius | Width | Depth |
|-------|-------|----------|-----------|-----------|
| 17545 | 7545 | ¼" (6mm) | ¾" (10mm) | ¼" (6mm) |
| 17554 | 7554 | ¼" (6mm) | ¾" (10mm) | ½" (13mm) |
| 17555 | 7555 | ¼" (6mm) | ¾" (10mm) | ¾" (19mm) |
| 17556 | 7556 | ¼" (6mm) | ¾" (10mm) | 1" (25mm) |

Bull Floats

- For more details and size options see pages 75-78



Fresnos

- For more details and size options see pages 79-82



"Broken-In" Magnesium Hand Floats

- Pre-shaped across length and width of blade
- Front and back of blade won't dig in, while sides glide over surface
- Extruded from very hard, durable, lightweight magnesium
- Assists the user in preparing the surface for troweling
- Recommended for use with air entrained concrete
- Magnesium floats produce a smoother finish than wood
- DuraSoft® handle provides a soft feel, reduces fatigue and offers excellent durability
- Sold 6 per inner pack/6 per outer pack



MADE IN
U.S.A.

MARSHALLTOWN The Premier Line

| EDI | Part# | Size-in. | Size-mm | Handle |
|-------|--------|----------|----------|--------|
| 14618 | BI142D | 12 X 3½" | 305 X 79 | |
| 14617 | BI145D | 16 X 3½" | 406 X 79 | |
| 14619 | BI146D | 20 X 3½" | 508 X 79 | |
| 14217 | BI153D | 24 X 3½" | 610 X 79 | |

"The Hog" Magnesium Hand Floats

- Extruded from very hard, durable, lightweight magnesium
- Wide blade covers more surface area and wears longer
- Handle is secured with torque pad screws that will not back out
- Recommended for use with air entrained concrete
- Comfortable handle is positioned to give the tool perfect balance
- Sold 6 per inner pack/6 per outer pack



MARSHALLTOWN The Premier Line

| EDI | Part# | Size-in. | Size-mm | Handle |
|-------|--------|----------|----------|--------|
| 14634 | 734D | 12 X 3/4 | 305 X 95 | |
| 14635 | 734 | 12 X 3/4 | 305 X 95 | |
| 14515 | 734RW | 12 X 3/4 | 305 X 95 | |
| 14231 | 734LRW | 12 X 3/4 | 305 X 95 | |
| 14179 | 734RD | 12 X 3/4 | 305 X 95 | |
| 14636 | 736D | 14 X 3/4 | 356 X 95 | |
| 14637 | 736 | 14 X 3/4 | 356 X 95 | |
| 14517 | 736RW | 14 X 3/4 | 356 X 95 | |
| 14233 | 736LRW | 14 X 3/4 | 356 X 95 | |
| 14181 | 736RD | 14 X 3/4 | 356 X 95 | |
| 14638 | 738D | 16 X 3/4 | 406 X 95 | |
| 14639 | 738 | 16 X 3/4 | 406 X 95 | |
| 14519 | 738RW | 16 X 3/4 | 406 X 95 | |
| 14234 | 738LRW | 16 X 3/4 | 406 X 95 | |
| 14183 | 738RD | 16 X 3/4 | 406 X 95 | |
| 14640 | 740D | 20 X 3/4 | 508 X 95 | |
| 14641 | 740 | 20 X 3/4 | 508 X 95 | |
| 14555 | 740RW | 20 X 3/4 | 508 X 95 | |
| 14235 | 740LRW | 20 X 3/4 | 508 X 95 | |
| 14185 | 740RD | 20 X 3/4 | 508 X 95 | |
| 14642 | 742D | 24 X 3/4 | 610 X 95 | |
| 14643 | 742 | 24 X 3/4 | 610 X 95 | |
| 14559 | 742RW | 24 X 3/4 | 610 X 95 | |
| 14236 | 742LRW | 24 X 3/4 | 610 X 95 | |
| 14187 | 742RD | 24 X 3/4 | 610 X 95 | |

Beveled Cast Magnesium Hand Floats

- Cast from the finest magnesium
- Designed with just the right broken-in shape
- Cast construction allows more knuckle clearance
- Placement of the handle gives the float perfect balance
- Sold 6 per inner pack/6 per outer pack



MARSHALLTOWN The Premier Line

| EDI | Part# | Size-in. | Size-mm | Handle |
|-------|----------|----------|----------|--------|
| 10926 | 06150LRW | 16 X 3/2 | 406 X 89 | |
| 10927 | 06150D | 16 X 3/2 | 406 X 89 | |
| 10928 | 06150RD | 16 X 3/2 | 406 X 89 | |

Cast Magnesium Hand Floats

- Cast from the finest magnesium
- Designed with just the right broken-in shape
- Cast construction allows more knuckle clearance
- Placement of the handle gives the float perfect balance
- Sold 6 per inner pack/6 per outer pack



MARSHALLTOWN The Premier Line

| EDI | Part# | Size-in. | Size-mm | Handle |
|-------|--------|----------|----------|--------|
| 14607 | 148 | 16 X 3/2 | 406 X 79 | |
| 14613 | 148D | 16 X 3/2 | 406 X 79 | |
| 14628 | 148RW | 16 X 3/2 | 406 X 79 | |
| 14244 | 148LRW | 16 X 3/2 | 406 X 79 | |
| 14195 | 148RD | 16 X 3/2 | 406 X 79 | |

Beveled End Magnesium Hand Floats

- Extruded from very hard, durable, lightweight magnesium
- Our most popular float design
- Comfortable handle is positioned to give the tool perfect balance
- Recommended for use with air entrained concrete
- Magnesium floats produce a smoother finish than wood
- Sold 6 per inner pack/6 per outer pack



MARSHALLTOWN The Premier Line

| EDI | Part# | Size-in. | Size-mm | Handle |
|-------|--------|----------|----------|--------|
| 14606 | 142 | 12 X 3/2 | 305 X 79 | |
| 14609 | 142D | 12 X 3/2 | 305 X 79 | |
| 14622 | 142RW | 12 X 3/2 | 305 X 79 | |
| 14237 | 142LRW | 12 X 3/2 | 305 X 79 | |
| 14189 | 142RD | 12 X 3/2 | 305 X 79 | |
| 14604 | 145 | 16 X 3/2 | 406 X 79 | |
| 14610 | 145D | 16 X 3/2 | 406 X 79 | |
| 14624 | 145RW | 16 X 3/2 | 406 X 79 | |
| 14238 | 145LRW | 16 X 3/2 | 406 X 79 | |
| 14605 | 145SH | 16 X 3/2 | 406 X 79 | |
| 14191 | 145RD | 16 X 3/2 | 406 X 79 | |
| 14602 | 146 | 20 X 3/2 | 508 X 79 | |
| 14611 | 146D | 20 X 3/2 | 508 X 79 | |
| 14625 | 146RW | 20 X 3/2 | 508 X 79 | |
| 14239 | 146LRW | 20 X 3/2 | 508 X 79 | |
| 14717 | 146SH | 20 X 3/2 | 508 X 79 | |
| 14193 | 146RD | 20 X 3/2 | 508 X 79 | |
| 14211 | 153 | 24 X 3/2 | 610 X 79 | |
| 14213 | 153D | 24 X 3/2 | 610 X 79 | |
| 14215 | 153LRW | 24 X 3/2 | 610 X 79 | |

Wall Form Magnesium Float

- Extruded from very hard, durable, lightweight magnesium
- Ideal for finishing foundation walls poured below the top of the form
- Non-rounded corners allow access to tight places
- Sold 6 per inner pack/6 per outer pack

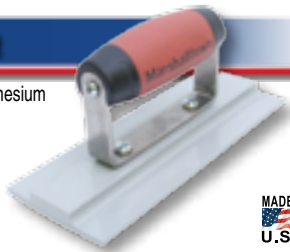

MADE IN
U.S.A.

MARSHALLTOWN The Premier Line

| EDI | Part# | Size-in. | Size-mm |
|-------|--------|----------|----------|
| 14569 | WF569D | 7½ X 3½ | 191 X 79 |

Aluminum Hand Float

- Made of extruded high strength alloy
- DuraSoft® handle provides a soft feel, reduces fatigue and offers excellent durability
- Sold 6 per inner pack/6 per outer pack



MADE IN
U.S.A.

MARSHALLTOWN The Premier Line

| EDI | Part# | Size-in. | Size-mm |
|-------|--------|----------|----------|
| 13822 | MF380R | 15½ X 3½ | 394 X 79 |

Round End Magnesium Hand Floats

- Extruded from very hard, durable, lightweight magnesium
- Fully rounded ends help prevent float marks
- Comfortable handle is positioned to give the tool perfect balance
- Magnesium floats produce a smoother finish than wood
- Handles are secured with torque pad screws that will not back out
- Sold 6 per inner pack/6 per outer pack



MADE IN
U.S.A.

MARSHALLTOWN The Premier Line

| EDI | Part# | Size-in. | Size-mm | Handle |
|-------|--------|----------|----------|--------|
| 14197 | 141 | 12 X 3½ | 305 X 79 | |
| 14198 | 141D | 12 X 3½ | 305 X 79 | |
| 14199 | 141LRW | 12 X 3½ | 305 X 79 | |
| 14603 | 143 | 16 X 3½ | 406 X 79 | |
| 14612 | 143D | 16 X 3½ | 406 X 79 | |
| 14627 | 143RW | 16 X 3½ | 406 X 79 | |
| 14241 | 143LRW | 16 X 3½ | 406 X 79 | |
| 14194 | 143RD | 16 X 3½ | 406 X 79 | |
| 14201 | 154 | 20 X 3½ | 508 X 79 | |
| 14203 | 154D | 20 X 3½ | 508 X 79 | |
| 14205 | 154LRW | 20 X 3½ | 508 X 79 | |
| 14207 | 155 | 24 X 3½ | 610 X 79 | |
| 14208 | 155D | 24 X 3½ | 610 X 79 | |
| 14209 | 155LRW | 24 X 3½ | 610 X 79 | |

Float Handles

- Fit all of our magnesium hand floats
- Pictures in order of table description
- Sold 12 per inner pack/12 per outer pack



MADE IN
U.S.A.

MARSHALLTOWN The Premier Line

| EDI | Part# | Description | Size-in. | Size-mm |
|-------|-------|-----------------------|----------|----------|
| 19111 | 16SF | Structural Foam | 9 X 1¼ | 229 X 31 |
| 19112 | 16M | Wood | 9 X 1¼ | 229 X 31 |
| 19130 | 16D | DuraSoft® | 9 X 1¼ | 229 X 31 |
| 14616 | 16RW | Round Wood | 9 X 1¼ | 229 X 31 |
| 14245 | 16LRW | Large Round Wood | 9 X 1¼ | 229 X 31 |
| 14196 | 16RD | Large Round DuraSoft® | 9 X 1¼ | 229 X 31 |

Sides Up Floats

- Long-wearing stainless steel blade
- DuraSoft® handle provides a soft feel, reduces fatigue and offers excellent durability
- Intended for hand-floating concrete pads
- Great for working in color hardeners
- Sold 6 per inner case/6 per outer case



6746

MADE IN
U.S.A.

MARSHALLTOWN The Premier Line

| EDI | Part# | Size-in. | Size-mm |
|-------|-------|----------|-----------|
| 16746 | 6746 | 5¾ X 10 | 150 X 255 |
| 16747 | 6747 | 5¾ X 11¼ | 130 X 285 |

Wood Hand Floats

- Made from clear, seasoned redwood, ¾" (19mm) thick
- Primarily used for leveling and smoothing concrete prior to final finish
- Also ideal when a slightly rougher concrete finish is desired
- The 144, 144D and 244 float have a beveled front edge
- Sold 6 per inner pack/6 per outer pack, sold 6 per inner pack/18 per outer pack where noted with*



144

44D

MADE IN
U.S.A.

MARSHALLTOWN The Premier Line

| EDI | Part# | Size-in. | Size-mm | Handle |
|-------|-------|----------|-----------|--------|
| 14502 | 44 | 12 X 5 | 305 X 127 | |
| 14503 | 44D | 12 X 5 | 305 X 127 | |
| 14504 | 144* | 16 X 3½ | 406 X 89 | |
| 14505 | 144D* | 16 X 3½ | 406 X 89 | |
| 14813 | 244 | 18 X 3½ | 457 X 89 | |

Xtra-Hard Wood Hand Floats

- Made from imported Jarrah hardwood, which is harder than teak
- Outlasts many ordinary wood floats and won't "fuzz up"
- Sold 6 per inner pack/18 per outer pack, 6 per inner pack/6 per outer pack where noted with*



147D



MARSHALLTOWN The Premier Line

| EDI | Part# | Size-in. | Size-mm | Handle |
|-------|-------|----------|----------|--------|
| 14506 | 147 | 16 X 3/4 | 406 X 83 | |
| 14507 | 147D | 16 X 3/4 | 406 X 83 | |
| 10311 | 247* | 18 X 3/2 | 457 X 89 | |
| 10313 | 247D* | 18 X 3/2 | 457 X 89 | |

Resin Hand Floats

- Made from 3/8" (10mm) thick laminated canvas resin
- Extremely dense
- Works the slab like a wood float but it lasts many times longer
- Great for working color hardeners into concrete
- Available with either DuraSoft® handle or structural foam handle
- Sold 1 per inner pack/6 per outer pack



4500RP

4500D



MARSHALLTOWN The Premier Line

Square End

| EDI | Part# | Size-in. | Size-mm | Handle |
|-------|-------|------------|----------|--------|
| 14501 | 4501D | 12 X 3 1/2 | 305 X 89 | |
| 14298 | 4501P | 12 X 3 1/2 | 305 X 89 | |
| 14500 | 4500D | 14 X 3 1/2 | 356 X 89 | |
| 14307 | 4500P | 14 X 3 1/2 | 356 X 89 | |
| 14526 | 4526D | 16 X 3 1/2 | 406 X 89 | |
| 14331 | 4526P | 16 X 3 1/2 | 406 X 89 | |
| 14528 | 4528D | 18 X 3 1/2 | 457 X 89 | |
| 14358 | 4528P | 18 X 3 1/2 | 457 X 89 | |
| 14492 | 4497D | 20 X 3 1/2 | 508 X 89 | |
| 14377 | 4497P | 20 X 3 1/2 | 508 X 89 | |

Round End

| EDI | Part# | Size-in. | Size-mm | Handle |
|-------|--------|------------|----------|--------|
| 14293 | 4501RD | 12 X 3 1/2 | 305 X 89 | |
| 14299 | 4501RP | 12 X 3 1/2 | 305 X 89 | |
| 14295 | 4500RD | 14 X 3 1/2 | 356 X 89 | |
| 14315 | 4500RP | 14 X 3 1/2 | 356 X 89 | |
| 14499 | 4499RD | 16 X 3 1/2 | 406 X 89 | |
| 14333 | 4526RP | 16 X 3 1/2 | 406 X 89 | |
| 14493 | 4498RD | 18 X 3 1/2 | 457 X 89 | |
| 14374 | 4528RP | 18 X 3 1/2 | 457 X 89 | |
| 14297 | 4497RD | 20 X 3 1/2 | 508 X 89 | |
| 14378 | 4497RP | 20 X 3 1/2 | 508 X 89 | |

Wood Hand Floats

- Made from 1/2" (13mm) thick seasoned mahogany
- Has a very smooth finish
- Sold 1 per inner pack/24 per outer pack



MARSHALLTOWN

| EDI | Part# | Size-in. | Size-mm |
|-------|-------|------------|----------|
| 14512 | WF943 | 12 X 3 1/2 | 305 X 89 |
| 14514 | WF944 | 14 X 3 1/2 | 356 X 89 |
| 14516 | WF946 | 16 X 3 1/2 | 406 X 89 |
| 14518 | WF947 | 18 X 3 1/2 | 457 X 89 |
| 14520 | WF948 | 20 X 3 1/2 | 508 X 89 |

T-Slot Darbies

- T-Slot design allows for virtually limitless handle orientations
- Same lightweight, durable extrusion as our magnesium floats
- Replacement handles available
- Darby with bull float bracket is ideal for lightweight concrete or floating in tight places
- Multiple handle configurations available
- Sold 2 per inner pack/ 2 per outer pack



16818

16807



MARSHALLTOWN The Premier Line

| EDI | Part# | Size-in. | Size-mm | Handle |
|-------|--------|------------|-----------|----------|
| 16801 | 16801 | 30 X 3 1/8 | 762 X 79 | |
| 16803 | 16803 | 30 X 3 1/8 | 762 X 79 | |
| 16806 | 16806 | 36 X 3 1/8 | 914 X 79 | |
| 16807 | 16807 | 36 X 3 1/8 | 914 X 79 | |
| 16809 | 16809 | 36 X 3 1/8 | 914 X 79 | |
| 16811 | 16811* | 36 X 3 1/8 | 914 X 79 | & TSBKRT |
| 16813 | 16813 | 42 X 3 1/8 | 1067 X 79 | |
| 16815 | 16815 | 48 X 3 1/8 | 1219 X 79 | |
| 16817 | 16817 | 60 X 3 1/8 | 1524 X 79 | & TSBKRT |

* 16811 has rounded ends

Walking Float

| EDI | Part# | Description | Size-in. | Size-mm |
|-------|-------|-----------------------------------|------------|----------|
| 16818 | 16818 | Rounded Ends w/ All-Angle Bracket | 24 X 3 1/8 | 610 X 79 |
| 16819 | 16819 | Square Ends w/ All-Angle Bracket | 24 X 3 1/8 | 610 X 79 |

T-Slot Darbies Replacement Handles

- Sold 6 per inner pack/6 per outer pack



MARSHALLTOWN The Premier Line

| EDI | Part# | Size-in. | Size-mm | Handle |
|-------|-------|----------|---------|--------|
| 16821 | TSDSH | N/A | N/A | |
| 16823 | TSDSK | N/A | N/A | |

T-Slot Darbies Replacement Brackets

- Sold 6 per inner pack/6 per outer pack

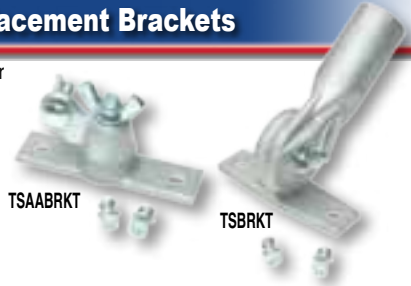

MARSHALLTOWN The Premier Line

| EDI | Part# | Size-in. | Size-mm |
|-------|----------|----------|---------|
| 16824 | TSBRKT | N/A | N/A |
| 16825 | TSAABRKT | N/A | N/A |

Magnesium Darbies

- The same lightweight, durable extrusion as our magnesium floats
- 4615D** is tapered from 3" (76mm) at the heel to 2" (51mm) at the toe
- 4626D** has a knob for extra control
- Premium DuraSoft® handle
- Sold 2 per inner pack/2 per outer pack, 1 per inner pack/1 per outer pack where noted with *

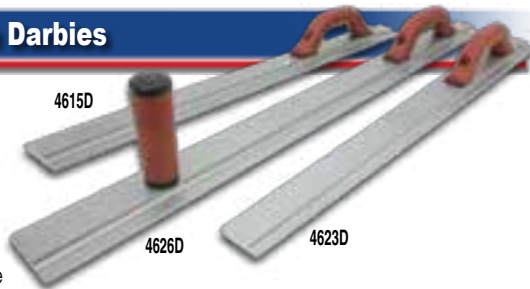

MARSHALLTOWN The Premier Line

| EDI | Part# | Size-in. | Size-mm | Handle |
|-------|--------|------------|----------|--------|
| 14615 | 4615D | 30 | 762 | |
| 14623 | 4623D | 30 X 3 3/8 | 762 X 79 | |
| 14626 | 4626D* | 36 X 3 3/8 | 914 X 79 | |

Resin Darbies

- Made from 3/8" (10mm) thick laminated canvas resin
- Finishes like wood but lasts like magnesium
- Ideal for use with color hardeners
- Tapered blades go from 3 1/2" (89mm) down to 2" (51mm)
- Sold 2 per inner pack/2 per outer pack

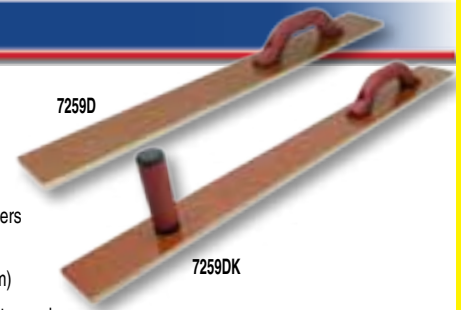

MARSHALLTOWN The Premier Line

| EDI | Part# | Size-in. | Size-mm | Handle |
|-------|--------|------------|----------|--------|
| 17259 | 7259 | 36 X 3 1/2 | 914 X 89 | |
| 17266 | 7259D | 36 X 3 1/2 | 914 X 89 | |
| 17265 | 7259DK | 36 X 3 1/2 | 914 X 89 | |

Tapered Resin Darby

| EDI | Part# | Size-in. | Size-mm | Handle |
|-------|---------|----------|---------|--------|
| 17258 | 7258 | 30 | 762 | |
| 17264 | 7258D | 30 | 762 | |
| 17260 | 7260RDW | 36 | 914 | |

Mahogany Darbies

- Made from straight grain mahogany
- Unique two-way tapered blade 152
- Designed with thicker blades for longer blade life and a larger handle for increased knuckle room 151 150
- 3 1/2" (89mm) wide by 3/4" (19mm) thick at the heel, 2" (51mm) wide by 3/4" (19mm) thick at the toe
- Sold 1 per inner pack/6 per outer pack, sold 1 per inner pack/5 per outer pack where noted with *

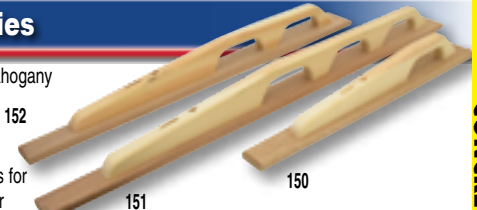

MARSHALLTOWN The Premier Line

| EDI | Part# | Size-in. | Size-mm | Handle |
|-------|-------|----------|---------|--------|
| 18706 | 140 | 24 | 610 | |
| 14510 | 150 | 28 | 711 | |
| 14509 | 152 | 36 | 914 | |
| 14511 | 151 | 45 | 1143 | |
| 14997 | 149* | 48 | 1219 | |

Sidewalk Slicker Float

- The same lightweight, durable extrusion as our magnesium floats
- Moves easily around obstacles and easily accesses hard to reach places
- Comes with 360° EZ Twist Bracket
- Requires threaded or snap adapter see page 87 (sold separately)
- Sold 1 per inner pack/1 per outer pack

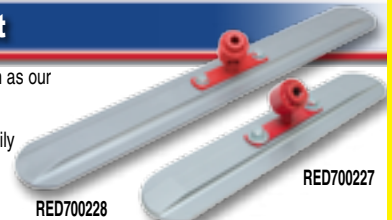

QLT BY MARSHALLTOWN

| EDI | Part# | Size-in. | Size-mm |
|-------|-----------|------------|----------|
| 24642 | RED700227 | 16 X 3 1/2 | 406 X 89 |
| 24643 | RED700228 | 24 X 3 1/2 | 610 X 89 |
| 24644 | RED700229 | 36 X 3 1/2 | 914 X 89 |

Check Rod Kits

- Available with either aluminum or magnesium blades
- Sharp 90° corners for cutting and filling
- Great for use on highways or industrial slabs where tight flatness tolerances are required
- H Style design provides more structural strength and straightness (aluminum blades only)
- Feature quick disconnecting outriggers on blades 8' (2.4M) and longer
- Square end check rods measure 4" X 2" (102 X 51mm)
- Round end check rods measure 5" X 2" (127 X 51mm)
- Kits include check rod, outriggers on 8' (2.4M) and longer, three 1¼" X 6' (44mm X 1.8M) handles, and bracket
- 10' and longer ship LTL
- Sold 1 per inner pack/1 per outer pack

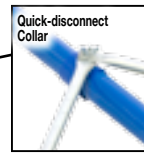

MADE IN
U.S.A

MARSHALLTOWN The Premier Line

Magnesium 4 x 2" Square End Check Rod Kits

| EDI | Part# | Description | Size-in. | Size-mm |
|-------|----------|----------------|----------|---------|
| 14961 | CR6ST91 | Kit w/Twister™ | 6' | 1.8M |
| 14962 | CR8ST91 | Kit w/Twister™ | 8' | 2.4M |
| 14963 | CR10ST91 | Kit w/Twister™ | 10' | 3.0M |
| 14964 | CR12ST91 | Kit w/Twister™ | 12' | 3.7M |
| 14969 | CR6SRB | Repl. Blade | 6' | 1.8M |
| 14970 | CR8SRB | Repl. Blade | 8' | 2.4M |
| 14971 | CR10SRB | Repl. Blade | 10' | 3.0M |
| 14972 | CR12SRB | Repl. Blade | 12' | 3.7M |

Magnesium 5 x 2" Round End Check Rod Kits

| EDI | Part# | Description | Size-in. | Size-mm |
|-------|----------|----------------|----------|---------|
| 14976 | CR6RT91 | Kit w/Twister™ | 6' | 1.8M |
| 14977 | CR8RT91 | Kit w/Twister™ | 8' | 2.4M |
| 14978 | CR10RT91 | Kit w/Twister™ | 10' | 3.0M |
| 14979 | CR12RT91 | Kit w/Twister™ | 12' | 3.7M |
| 14984 | CR4RRB | Repl. Blade | 4' | 1.2M |
| 14985 | CR5RRB | Repl. Blade | 5' | 1.5M |
| 14986 | CR6RRB | Repl. Blade | 6' | 1.8M |
| 14987 | CR8RRB | Repl. Blade | 8' | 2.4M |
| 14988 | CR10RRB | Repl. Blade | 10' | 3.0M |
| 14989 | CR12RRB | Repl. Blade | 12' | 3.7M |

Replacement Parts

| EDI | Part# | Description |
|-------|---------|---|
| 14973 | CRPACK1 | Outriggers Assy. (Includes CRPACK2 & CRPACK3) |
| 14974 | CRPACK2 | Outrigger Clevis Assy. |
| 14975 | CRPACK3 | Handle Collar Assy. |

MARSHALLTOWN The Premier Line

Aluminum 4 x 2" Square End Check Rod Kits

| EDI | Part# | Description | Size-in. | Size-mm |
|-------|------------|----------------|----------|---------|
| 20776 | RED701190K | Kit w/Twister™ | 6' | 1.8M |
| 20766 | RED701182K | Kit w/Twister™ | 8' | 2.4M |
| 20769 | RED701183K | Kit w/Twister™ | 10' | 3.0M |
| 20773 | RED701184K | Kit w/Twister™ | 12' | 3.7M |
| 20746 | RED701190 | Repl. Blade | 6' | 1.8M |
| 20743 | RED701182 | Repl. Blade | 8' | 2.4M |
| 20744 | RED701183 | Repl. Blade | 10' | 3.0M |
| 20745 | RED701184 | Repl. Blade | 12' | 3.7M |

Aluminum 5 x 2" Round End Check Rod Kits

| EDI | Part# | Description | Size-in. | Size-mm |
|-------|------------|----------------|----------|---------|
| 20754 | RED701172K | Kit w/Twister™ | 6' | 1.8M |
| 20757 | RED701173K | Kit w/Twister™ | 8' | 2.4M |
| 20760 | RED701174K | Kit w/Twister™ | 10' | 3.0M |
| 20763 | RED701175K | Kit w/Twister™ | 12' | 3.7M |
| 20731 | RED701170 | Repl. Blade | 4' | 1.2M |
| 20733 | RED701172 | Repl. Blade | 6' | 1.8M |
| 20734 | RED701173 | Repl. Blade | 8' | 2.4M |
| 20735 | RED701174 | Repl. Blade | 10' | 3.0M |
| 20736 | RED701175 | Repl. Blade | 12' | 3.7M |

Magnesium Bump Cutter Kits

- Long-lasting magnesium alloy
- Cuts high spots and fills low spots
- Great tool for use in highway paving and on floors requiring high "F" numbers
- Sturdy bracket mount and strut mount with quick-disconnect outriggers
- Kits include bump cutter, three 1 3/4" X 6' (44mm X 1.8M) poles, bracket, and outriggers on 8' (2.4M) and longer blades
- Quick and easy to assemble
- 10' and longer ship LTL
- Sold 1 per inner pack/1 per outer pack

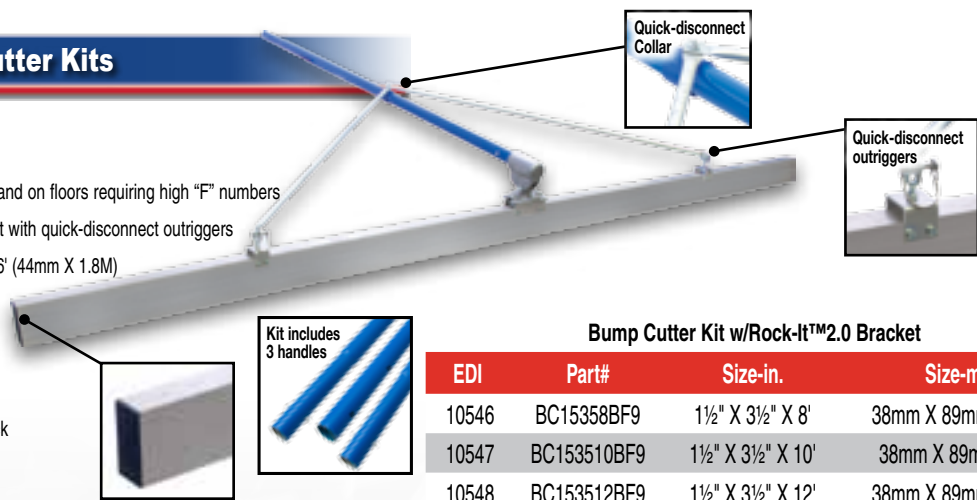

MADE IN
U.S.A.

MARSHALLTOWN The Premier Line

Bump Cutter Kit w/Twister™ Bracket

| EDI | Part# | Size-in. | Size-mm |
|-------|-------------|-----------------------|---------------------|
| 10527 | BC15358T91 | 1 1/2" X 3 1/2" X 8' | 38mm X 89mm X 2.4M |
| 10528 | BC153510T91 | 1 1/2" X 3 1/2" X 10' | 38mm X 89mm X 3M |
| 10529 | BC153512T91 | 1 1/2" X 3 1/2" X 12' | 38mm X 89mm X 3.7M |
| 10530 | BC153514T91 | 1 1/2" X 3 1/2" X 14' | 38mm X 89mm X 4.3M |
| 10531 | BC153516T91 | 1 1/2" X 3 1/2" X 16' | 38mm X 89mm X 4.9M |
| 10532 | BC153520T91 | 1 1/2" X 3 1/2" X 20' | 38mm X 89mm X 6.1M |
| 10533 | BC153524T91 | 1 1/2" X 3 1/2" X 24' | 38mm X 89mm X 7.3M |
| 10534 | BC246T91 | 2" X 4" X 6' | 51mm X 102mm X 1.8M |
| 10535 | BC248T91 | 2" X 4" X 8' | 51mm X 102mm X 2.4M |
| 10536 | BC2410T91 | 2" X 4" X 10' | 51mm X 102mm X 3M |
| 10537 | BC2412T91 | 2" X 4" X 12' | 51mm X 102mm X 3.7M |
| 10538 | BC2414T91 | 2" X 4" X 14' | 51mm X 102mm X 4.3M |
| 10539 | BC2416T91 | 2" X 4" X 16' | 51mm X 102mm X 4.9M |
| 10540 | BC2418T91 | 2" X 4" X 18' | 51mm X 102mm X 5.5M |
| 10541 | BC2420T91 | 2" X 4" X 20' | 51mm X 102mm X 6.1M |
| 10542 | BC2424T91 | 2" X 4" X 24' | 51mm X 102mm X 7.3M |
| 10543 | BC2516T91 | 2" X 5" X 16' | 51mm X 127mm X 4.9M |
| 10544 | BC2520T91 | 2" X 5" X 20' | 51mm X 127mm X 6.1M |
| 10545 | BC2524T91 | 2" X 5" X 24' | 51mm X 127mm X 7.3M |

Replacement Parts

| EDI | Part# | Description |
|-------|---------|---|
| 14973 | CRPACK1 | Outriggers Assy. (Includes CRPACK2 & CRPACK3) |
| 14974 | CRPACK2 | Outrigger Clevis Assy. |
| 14975 | CRPACK3 | Handle Collar Assy. |

Bump Cutter Kit w/Rock-It™2.0 Bracket

| EDI | Part# | Size-in. | Size-mm |
|-------|-------------|-----------------------|---------------------|
| 10546 | BC15358BF9 | 1 1/2" X 3 1/2" X 8' | 38mm X 89mm X 2.4M |
| 10547 | BC153510BF9 | 1 1/2" X 3 1/2" X 10' | 38mm X 89mm X 3M |
| 10548 | BC153512BF9 | 1 1/2" X 3 1/2" X 12' | 38mm X 89mm X 3.7M |
| 10549 | BC153514BF9 | 1 1/2" X 3 1/2" X 14' | 38mm X 89mm X 4.3M |
| 10550 | BC153516BF9 | 1 1/2" X 3 1/2" X 16' | 38mm X 89mm X 4.9M |
| 10551 | BC153520BF9 | 1 1/2" X 3 1/2" X 20' | 38mm X 89mm X 6.1M |
| 10552 | BC153524BF9 | 1 1/2" X 3 1/2" X 24' | 38mm X 89mm X 7.3M |
| 10553 | BC246BF9 | 2" X 4" X 6' | 51mm X 102mm X 1.8M |
| 10554 | BC248BF9 | 2" X 4" X 8' | 51mm X 102mm X 2.4M |
| 10555 | BC2410BF9 | 2" X 4" X 10' | 51mm X 102mm X 3M |
| 10556 | BC2412BF9 | 2" X 4" X 12' | 51mm X 102mm X 3.7M |
| 10557 | BC2414BF9 | 2" X 4" X 14' | 51mm X 102mm X 4.3M |
| 10558 | BC2416BF9 | 2" X 4" X 16' | 51mm X 102mm X 4.9M |
| 10559 | BC2418BF9 | 2" X 4" X 18' | 51mm X 102mm X 5.5M |
| 10560 | BC2420BF9 | 2" X 4" X 20' | 51mm X 102mm X 6.1M |
| 10561 | BC2424BF9 | 2" X 4" X 24' | 51mm X 102mm X 7.3M |
| 10562 | BC2516BF9 | 2" X 5" X 16' | 51mm X 127mm X 4.9M |
| 10563 | BC2520BF9 | 2" X 5" X 20' | 51mm X 127mm X 6.1M |
| 10564 | BC2524BF9 | 2" X 5" X 24' | 51mm X 127mm X 7.3M |

Bump Cutter Replacement Blades

| EDI | Part# | Size-in. | Size-mm |
|-------|------------|-----------------------|---------------------|
| 10565 | BC15358RB | 1 1/2" X 3 1/2" X 8' | 38mm X 89mm X 2.4M |
| 10566 | BC153510RB | 1 1/2" X 3 1/2" X 10' | 38mm X 89mm X 3M |
| 10567 | BC153512RB | 1 1/2" X 3 1/2" X 12' | 38mm X 89mm X 3.7M |
| 10568 | BC153514RB | 1 1/2" X 3 1/2" X 14' | 38mm X 89mm X 4.3M |
| 10569 | BC153516RB | 1 1/2" X 3 1/2" X 16' | 38mm X 89mm X 4.9M |
| 10570 | BC153520RB | 1 1/2" X 3 1/2" X 20' | 38mm X 89mm X 6.1M |
| 10571 | BC153524RB | 1 1/2" X 3 1/2" X 24' | 38mm X 89mm X 7.3M |
| 10572 | BC246RB | 2" X 4" X 6' | 51mm X 102mm X 1.8M |
| 10573 | BC248RB | 2" X 4" X 8' | 51mm X 102mm X 2.4M |
| 10574 | BC2410RB | 2" X 4" X 10' | 51mm X 102mm X 3M |
| 10575 | BC2412RB | 2" X 4" X 12' | 51mm X 102mm X 3.7M |
| 10576 | BC2414RB | 2" X 4" X 14' | 51mm X 102mm X 4.3M |
| 10577 | BC2416RB | 2" X 4" X 16' | 51mm X 102mm X 4.9M |
| 10578 | BC2418RB | 2" X 4" X 18' | 51mm X 102mm X 5.5M |
| 10579 | BC2420RB | 2" X 4" X 20' | 51mm X 102mm X 6.1M |
| 10580 | BC2424RB | 2" X 4" X 24' | 51mm X 102mm X 7.3M |
| 10581 | BC2516RB | 2" X 5" X 16' | 51mm X 127mm X 4.9M |
| 10582 | BC2520RB | 2" X 5" X 20' | 51mm X 127mm X 6.1M |
| 10583 | BC2524RB | 2" X 5" X 24' | 51mm X 127mm X 7.3M |

Aluminum Bump Cutter Kits

- Long-lasting aluminum alloy
- Cuts high spots and fills low spots
- Great tool for use in highway paving and on floors requiring high "F" numbers
- Sturdy bracket mount and strut mount with quick-disconnect outriggers
- Kits include bump cutter, three 1 1/2" X 6' (44mm X 1.8M) poles, bracket, and outriggers on 8' (2.4M) and longer blades
- Quick and easy to assemble
- 10' and longer ship LTL
- Sold 1 per inner pack/1 per outer pack

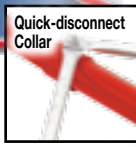

MARSHALLTOWN The Premier Line

MADE IN U.S.A

Bump Cutter Kit w/Twister™ Bracket

Replacement Blades

| EDI | Part# | Size-in. | Size-mm |
|-------|------------|-----------------------|---------------------|
| 20189 | RED701160K | 1 1/2" X 3 1/2" X 8' | 38mm X 89mm X 2.4M |
| 20192 | RED701161K | 1 1/2" X 3 1/2" X 10' | 38mm X 89mm X 3M |
| 20195 | RED701162K | 1 1/2" X 3 1/2" X 12' | 38mm X 89mm X 3.7M |
| 20198 | RED701163K | 1 1/2" X 3 1/2" X 14' | 38mm X 89mm X 4.3M |
| 20202 | RED701164K | 1 1/2" X 3 1/2" X 16' | 38mm X 89mm X 4.9M |
| 20205 | RED701165K | 1 1/2" X 3 1/2" X 20' | 38mm X 89mm X 6.1M |
| 20208 | RED701166K | 1 1/2" X 3 1/2" X 24' | 38mm X 89mm X 7.3M |
| 20160 | RED701151K | 2" X 4" X 6' | 51mm X 102mm X 1.8M |
| 20163 | RED701152K | 2" X 4" X 8' | 51mm X 102mm X 2.4M |
| 20166 | RED701153K | 2" X 4" X 10' | 51mm X 102mm X 3M |
| 20169 | RED701154K | 2" X 4" X 12' | 51mm X 102mm X 3.7M |
| 20174 | RED701155K | 2" X 4" X 14' | 51mm X 102mm X 4.3M |
| 20177 | RED701156K | 2" X 4" X 16' | 51mm X 102mm X 4.9M |
| 20180 | RED701157K | 2" X 4" X 18' | 51mm X 102mm X 5.5M |
| 20183 | RED701158K | 2" X 4" X 20' | 51mm X 102mm X 6.1M |
| 20186 | RED701159K | 2" X 4" X 24' | 51mm X 102mm X 7.3M |
| 20211 | RED701167K | 2" X 5" X 16' | 51mm X 127mm X 4.9M |
| 20214 | RED701168K | 2" X 5" X 20' | 51mm X 127mm X 6.1M |
| 20217 | RED701169K | 2" X 5" X 24' | 51mm X 127mm X 7.3M |

| EDI | Part# | Size-in. | Size-mm |
|-------|-----------|-----------------------|---------------------|
| 20139 | RED701160 | 1 1/2" X 3 1/2" X 8' | 38mm X 89mm X 2.4M |
| 20140 | RED701161 | 1 1/2" X 3 1/2" X 10' | 38mm X 89mm X 3M |
| 20141 | RED701162 | 1 1/2" X 3 1/2" X 12' | 38mm X 89mm X 3.7M |
| 20142 | RED701163 | 1 1/2" X 3 1/2" X 14' | 38mm X 89mm X 4.3M |
| 20143 | RED701164 | 1 1/2" X 3 1/2" X 16' | 38mm X 89mm X 4.9M |
| 20144 | RED701165 | 1 1/2" X 3 1/2" X 20' | 38mm X 89mm X 6.1M |
| 20145 | RED701166 | 1 1/2" X 3 1/2" X 24' | 38mm X 89mm X 7.3M |
| 20130 | RED701151 | 2" X 4" X 6' | 51mm X 102mm X 1.8M |
| 20131 | RED701152 | 2" X 4" X 8' | 51mm X 102mm X 2.4M |
| 20132 | RED701153 | 2" X 4" X 10' | 51mm X 102mm X 3M |
| 20133 | RED701154 | 2" X 4" X 12' | 51mm X 102mm X 3.7M |
| 20134 | RED701155 | 2" X 4" X 14' | 51mm X 102mm X 4.3M |
| 20135 | RED701156 | 2" X 4" X 16' | 51mm X 102mm X 4.9M |
| 20136 | RED701157 | 2" X 4" X 18' | 51mm X 102mm X 5.5M |
| 20137 | RED701158 | 2" X 4" X 20' | 51mm X 102mm X 6.1M |
| 20138 | RED701159 | 2" X 4" X 24' | 51mm X 102mm X 7.3M |
| 20146 | RED701167 | 2" X 5" X 16' | 51mm X 127mm X 4.9M |
| 20147 | RED701168 | 2" X 5" X 20' | 51mm X 127mm X 6.1M |
| 20148 | RED701169 | 2" X 5" X 24' | 51mm X 127mm X 7.3M |

Replacement Parts

| EDI | Part# | Description |
|-------|---------|---|
| 14973 | CRPACK1 | Outriggers Assy. (Includes CRPACK2 & CRPACK3) |
| 14974 | CRPACK2 | Outrigger Clevis Assy. |
| 14975 | CRPACK3 | Handle Collar Assy. |

Paver's Straight Edge Kits

- Strong single-piece 12' and 16' (3.7M and 4.9M) handles bend less than multiple handles attached together
- Kit includes blade, bracket, outriggers, pole and hardware
- Can be used as a checking tool or for leveling work while the concrete is still plastic
- Straight edges measure 1 X 2" (25 X 51mm)
- 10' and longer ship LTL
- Sold 1 per inner pack/1 per outer pack

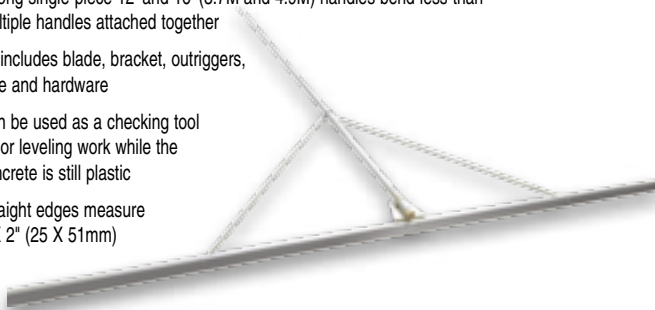

MADE IN
U.S.A.

MARSHALLTOWN The Premier Line

Aluminum Straight Edge

| EDI | Part# | Description | Blade Size | Handle Size |
|-------|-----------|------------------------|------------|-------------|
| 25512 | RED700012 | Kit w/Non-Adj. Bracket | 10' (3.0M) | 12' (3.7M) |
| 25517 | RED700064 | Kit w/Non-Adj. Bracket | 10' (3.0M) | 16' (4.9M) |
| 25513 | RED700013 | Kit w/Non-Adj. Bracket | 12' (3.7M) | 12' (3.7M) |
| 25518 | RED700065 | Kit w/Non-Adj. Bracket | 12' (3.7M) | 16' (4.9M) |
| 25514 | RED700014 | Kit w/Non-Adj. Bracket | 16' (4.9M) | 12' (3.7M) |
| 25519 | RED700066 | Kit w/Non-Adj. Bracket | 16' (4.9M) | 16' (4.9M) |
| 25541 | RED701037 | Repl. Blade | 10' (3.0M) | N/A |
| 25542 | RED701038 | Repl. Blade | 12' (3.7M) | N/A |
| 25543 | RED701039 | Repl. Blade | 16' (4.9M) | N/A |

Replacement Parts

| EDI | Part# | Description | Blade Size | Handle Size |
|-------|-----------|---------------------------|------------|-------------|
| 25577 | RED704532 | Base Connector | N/A | N/A |
| 20353 | RED704204 | Handle Connector-Threaded | N/A | N/A |
| 25544 | RED701040 | Repl. Handle | N/A | 12' (3.7M) |
| 25545 | RED701041 | Repl. Handle | N/A | 16' (4.9M) |
| 15164 | SENBKKT | Repl. Bracket | N/A | N/A |
| 15167 | SEPACK1 | Repl. Outriggers Assy. | N/A | N/A |

Finisher's Tote™

- Open ended with bracket window to fit any length pole, bull float, or fresno
- Made of double layer durable water resistant nylon with a rigid reinforced base and stiffened side panels
- Specially designed reinforced nylon pole retainers will accept any 1³/₈" (35mm) or 1³/₄" (44mm) bullfloat handles
- Outside cinching straps are perfect for holding 4-ft levels, darbies, long trowels, and brooms
- Multiple pockets hold a variety of finishing tools
- Sold 1 per inner pack/1 per outer pack



TOTE



BFKIT7
Shown with additional tools
(sold separately)



Watch Video

MARSHALLTOWN The Premier Line

| EDI | Part# | Description | Bull Float Size | Pole Diameter |
|-------|--------|------------------|-----------------|--|
| 17390 | BFKIT1 | Round End w/RL6 | 48" (1219mm) | 1 ³ / ₄ " (44mm) |
| 17391 | BFKIT2 | Round End w/RL6 | 48" (1219mm) | 1 ³ / ₈ " (35mm) |
| 17392 | BFKIT3 | Square End w/RL6 | 48" (1219mm) | 1 ³ / ₄ " (44mm) |
| 17393 | BFKIT4 | Square End w/RL6 | 48" (1219mm) | 1 ³ / ₈ " (35mm) |
| 17302 | TOTE | Tote Bag Only | N/A | N/A |

• KIT INCLUDES:

- Round or square end **MARSHALLTOWN** bull float with **RL6** bull float bracket
- Four 1³/₈" (35mm) or 1³/₄" (44mm) **MARSHALLTOWN** handles
- Tote bag

MARSHALLTOWN The Premier Line

| EDI | Part# | Description | Bull Float Size | Pole Diameter |
|-------|--------|-----------------------|-----------------|--|
| 17394 | BFKIT5 | Round End w/16-RKT-N | 48" (1219mm) | 1 ³ / ₄ " (44mm) |
| 17395 | BFKIT6 | Round End w/16-RKT-N | 48" (1219mm) | 1 ³ / ₈ " (35mm) |
| 17396 | BFKIT7 | Square End w/16-RKT-N | 48" (1219mm) | 1 ³ / ₄ " (44mm) |
| 17397 | BFKIT8 | Square End w/16-RKT-N | 48" (1219mm) | 1 ³ / ₈ " (35mm) |

• KIT INCLUDES:

- Round or square end **MARSHALLTOWN** bull float with **16-RKT-N** bull float bracket
- Four 1³/₈" (35mm) or 1³/₄" (44mm) QLT handles
- Tote bag

QLT™-MARSHALLTOWN

| EDI | Part# | Description | Bull Float Size | Pole Diameter |
|-------|---------|------------------|-----------------|--|
| 17398 | BFKIT9 | Round End w/BF9 | 48" (1219mm) | 1 ³ / ₄ " (44mm) |
| 17399 | BFKIT10 | Round End w/BF9 | 48" (1219mm) | 1 ³ / ₈ " (35mm) |
| 17300 | BFKIT11 | Square End w/BF9 | 48" (1219mm) | 1 ³ / ₄ " (44mm) |
| 17301 | BFKIT12 | Square End w/BF9 | 48" (1219mm) | 1 ³ / ₈ " (35mm) |

• KIT INCLUDES:

- Round or square end QLT bull float with **BF9** bull float bracket
- Four 1³/₈" (35mm) or 1³/₄" (44mm) QLT handles
- Tote bag



Double Edge Channel Bull Floats

- Made from the finest extruded magnesium available
- Stiffer and more resistant to warping than standard bull floats
- Sharp edge used for cutting down high spots, rounded edge used for floating
- Outriggers included with **CB96DE** & **CB120DE** to help keep float square with working surface
- Perfect tool to use when high "F" numbers are required
- **CB120DE** ships LTL
- Sold 1 per inner pack/1 per outer pack

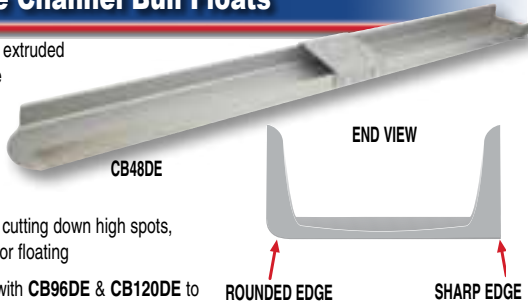

MADE IN
U.S.A

MARSHALLTOWN The Premier Line

| EDI | Part# | Size-in. | Size-mm |
|-------|---------|----------|------------|
| 13793 | CB48DE | 48 X 6 | 1219 X 152 |
| 13794 | CB60DE | 60 X 6 | 1524 X 152 |
| 13795 | CB72DE | 72 X 6 | 1829 X 152 |
| 13796 | CB96DE | 96 X 6 | 2438 X 152 |
| 13797 | CB120DE | 120 X 6 | 3048 X 152 |

Channel Bull Floats

- Made from the finest extruded magnesium available
- Stiffer and more resistant to warping than standard bull floats
- Two rounded edges for floating
- Outriggers included to help keep float square with working surface where noted with*
- Perfect tool to use when high "F" numbers are required
- **CB120**, **CB144**, **CB168** and **CB192** ship LTL
- Sold 1 per inner pack/1 per outer pack



MADE IN
U.S.A

MARSHALLTOWN The Premier Line

Round End Channel Floats

| EDI | Part# | Size-in. | Size-mm |
|-------|--------|----------|------------|
| 14755 | CB48 | 48 X 6 | 1219 X 152 |
| 14729 | CB60 | 60 X 6 | 1524 X 152 |
| 14707 | CB72 | 72 X 6 | 1829 X 152 |
| 14728 | CB96* | 96 X 6 | 2438 X 152 |
| 14742 | CB120* | 120 X 6 | 3048 X 152 |
| 11753 | CB144* | 144 X 6 | 3658 X 152 |
| 11754 | CB168* | 168 X 6 | 4267 X 152 |
| 11755 | CB192* | 192 X 6 | 4877 X 152 |

Square End Channel Floats

| EDI | Part# | Size-in. | Size-mm |
|-------|-----------|----------|------------|
| 20644 | RED700658 | 48 X 6 | 1219 X 152 |
| 20645 | RED700659 | 60 X 6 | 1524 X 152 |
| 20646 | RED700660 | 72 X 6 | 1829 X 152 |
| 20647 | RED700661 | 120 X 6 | 3048 X 152 |

Replacement Channel Bull Float Mounting Plate

| EDI | Part# | Size-in. | Size-mm |
|-------|-------|----------|---------|
| 18566 | 18566 | N/A | N/A |

PermaStraight® Bull Floats

- Made from the finest extruded magnesium available
- Smooth steel stiffener makes cleanup easier
- Ten times more resistant to warping than standard bull floats
- Comes with complete bracket assembly
- Sealed ends prevent concrete buildup
- "FR" indicates rounded ends
- Sold 1 per inner pack/1 per outer pack



MADE IN
U.S.A

MARSHALLTOWN The Premier Line

| EDI | Part# | Size-in. | Size-mm |
|-------|---------|----------|------------|
| 14695 | PSB48 | 48 X 8 | 1219 X 203 |
| 14698 | PSB48FR | 48 X 8 | 1219 X 203 |

"Broken-In" Magnesium Bull Floats

- Extruded magnesium blade is "broken-in" right out of the box
- Each end is slightly turned up to help prevent the visible lines generated when bull floating
- Comes with complete bracket assembly
- Using several handle sections, the finisher can float a slab well beyond normal reach
- Sold 1 per inner pack/1 per outer pack

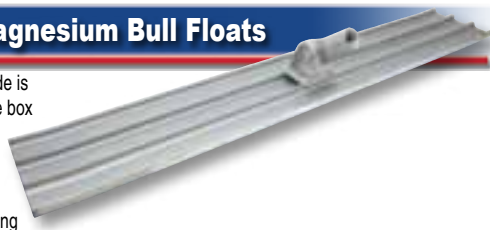

MADE IN
U.S.A

MARSHALLTOWN The Premier Line

| EDI | Part# | Size-in. | Size-mm |
|-------|-------|----------|------------|
| 14684 | B30BI | 30 X 8 | 762 X 203 |
| 14685 | B42BI | 42 X 8 | 1067 X 203 |
| 14687 | B48BI | 48 X 8 | 1219 X 203 |
| 14688 | B60BI | 60 X 8 | 1524 X 203 |

Magnesium Bull Floats

- Made from the finest extruded magnesium available
- Lightweight, long wearing and properly balanced to provide the finish you want
- No other heavy duty bull float outlasts this one
- Bull floats with bracket sold 1 per inner pack/1 per outer pack, blade only sold 3 per inner pack/3 per outer pack



B45RA, B46RA & B48FRRA come with RL6 RotaLeveler®

MADE IN U.S.A.

MARSHALLTOWN The Premier Line

| EDI | Part# | Description | Size-in. | Size-mm |
|-------|---------|-------------------|----------|------------|
| 14697 | B36 | Square End | 36 X 8 | 914 X 203 |
| 14699 | B36FR | Round End | 36 X 8 | 914 X 203 |
| 14700 | B42 | Square End | 42 X 8 | 1067 X 203 |
| 16878 | B42FR | Round End | 42 X 8 | 1067 X 203 |
| 14702 | B45 | Square End | 45 X 8 | 1143 X 203 |
| 14701 | B45RA | Square End w/ RL6 | 45 X 8 | 1143 X 203 |
| 16879 | B45FR | Round End | 45 X 8 | 1143 X 203 |
| 14704 | B48 | Square End | 48 X 8 | 1219 X 203 |
| 14715 | B48RA | Square End w/ RL6 | 48 X 8 | 1219 X 203 |
| 14720 | B48FR | Round End | 48 X 8 | 1219 X 203 |
| 14719 | B48FRRA | Round End w/RL6 | 48 X 8 | 1219 X 203 |
| 14708 | B60 | Square End | 60 X 8 | 1524 X 203 |
| 14740 | B60FR | Round End | 60 X 8 | 1524 X 203 |
| 16876 | B72 | Square End | 72 X 8 | 1829 X 203 |
| 14741 | B72FR | Round End | 72 X 8 | 1829 X 203 |

Bull Float Blades Only

| EDI | Part# | Description | Size-in. | Size-mm |
|-------|--------|-------------|----------|------------|
| 14032 | B36B | Square End | 36 X 8 | 914 X 203 |
| 14028 | B36FRB | Round End | 36 X 8 | 914 X 203 |
| 14033 | B42B | Square End | 42 X 8 | 1067 X 203 |
| 14029 | B42FRB | Round End | 42 X 8 | 1067 X 203 |
| 14703 | B45B | Square End | 45 X 8 | 1143 X 203 |
| 16880 | B45FRB | Round End | 45 X 8 | 1143 X 203 |
| 14706 | B48B | Square End | 48 X 8 | 1219 X 203 |
| 14721 | B48FRB | Round End | 48 X 8 | 1219 X 203 |
| 14035 | B60B | Square End | 60 X 8 | 1524 X 203 |
| 14030 | B60FRB | Round End | 60 X 8 | 1524 X 203 |
| 16877 | B72B | Square End | 72 X 8 | 1829 X 203 |
| 14031 | B72FRB | Round End | 72 X 8 | 1829 X 203 |

Magnesium Bull Floats

- Extruded from magnesium alloy
- Lightweight, long wearing
- "R" indicates round ends
- Bull floats with bracket sold 1 per inner pack/1 per outer pack, blade only sold 3 per inner pack/3 per outer pack

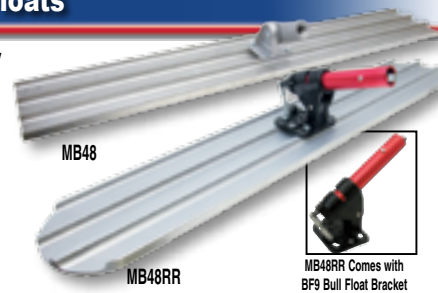

MB48RR Comes with BF9 Bull Float Bracket

MADE IN U.S.A.

QLTTM MARSHALLTOWN

| EDI | Part# | Description | Size-in. | Size-mm |
|-------|--------|------------------|----------|------------|
| 16883 | MB36 | Square End | 36 X 8 | 914 X 203 |
| 16885 | MB36R | Round End | 36 X 8 | 914 X 203 |
| 13865 | MB42 | Square End | 42 X 8 | 1067 X 203 |
| 16887 | MB42R | Round End | 42 X 8 | 1067 X 203 |
| 16889 | MB45 | Square End | 45 X 8 | 1143 X 203 |
| 16891 | MB45R | Round End | 45 X 8 | 1143 X 203 |
| 13874 | MB48 | Square End | 48 X 8 | 1219 X 203 |
| 13875 | MB48R | Round End | 48 X 8 | 1219 X 203 |
| 13866 | MB48RR | Round End w/ BF9 | 48 X 8 | 1219 X 203 |
| 16893 | MB54 | Square End | 54 X 8 | 1372 X 203 |
| 16895 | MB54R | Round End | 54 X 8 | 1372 X 203 |
| 16897 | MB60 | Square End | 60 X 8 | 1524 X 203 |
| 16899 | MB60R | Round End | 60 X 8 | 1524 X 203 |
| 16901 | MB72 | Square End | 72 X 8 | 1829 X 203 |
| 16903 | MB72R | Round End | 72 X 8 | 1829 X 203 |

Bull Float Blades Only

| EDI | Part# | Description | Size-in. | Size-mm |
|-------|--------|-------------|----------|------------|
| 16884 | MB36B | Square End | 36 X 8 | 914 X 203 |
| 16886 | MB36RB | Round End | 36 X 8 | 914 X 203 |
| 16888 | MB42RB | Round End | 42 X 8 | 1067 X 203 |
| 16890 | MB45B | Square End | 45 X 8 | 1143 X 203 |
| 16892 | MB45RB | Round End | 45 X 8 | 1143 X 203 |
| 13873 | MB48B | Square End | 48 X 8 | 1219 X 203 |
| 13872 | MB48RB | Round End | 48 X 8 | 1219 X 203 |
| 16894 | MB54B | Square End | 54 X 8 | 1372 X 203 |
| 16896 | MB54RB | Round End | 54 X 8 | 1372 X 203 |
| 16898 | MB60B | Square End | 60 X 8 | 1524 X 203 |
| 16900 | MB60RB | Round End | 60 X 8 | 1524 X 203 |
| 16902 | MB72B | Square End | 72 X 8 | 1829 X 203 |
| 16904 | MB72RB | Round End | 72 X 8 | 1829 X 203 |

Aluminum Bull Floats

- Aluminum blade with a double rib construction for added strength
- Long wearing and properly balanced
- Complete bracket assembly included that will accept any standard threaded handle section
- Sold 1 per inner pack/1 per outer pack; **BF428B** blade only sold 3 per inner pack/3 per outer pack

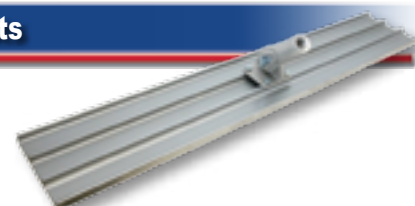

MADE IN U.S.A.

QLTTM MARSHALLTOWN

| EDI | Part# | Size-in. | Size-mm |
|-------|--------|----------|------------|
| 13862 | BF422 | 42 X 7¼ | 1067 X 184 |
| 13864 | BF428 | 48 X 7¼ | 1219 X 184 |
| 13000 | BF428B | 48 X 7¼ | 1219 X 184 |

West Coast Remodeler Bull Floats

- Extruded from magnesium alloy
- Lightweight, long wearing
- Comes with clevis style bracket
- Use with our 9 or 10 handle (sold separately) see page 88 for details
- Sold 1 per inner pack/1 per outer pack



MADE IN
U.S.A.

QLT BY MARSHALLTOWN

| EDI | Part# | Description | Size-in. | Size-mm |
|-------|--------|----------------|----------|------------|
| 13876 | WCB48 | Square End | 48 X 8 | 1219 X 203 |
| 13863 | WCB48R | Round End | 48 X 8 | 1219 X 203 |
| 13750 | 3750 | Clevis Bracket | N/A | N/A |

Multigroove Bull Floats

- Made from the finest extruded magnesium available
- Grooves are 1/4" (6mm) wide and 1/4" (6mm) deep
- Brackets sold separately
- Excellent tool for applications where uniform grooves are necessary (water drainage)
- **New items indicated in Red**
- Sold 1 per inner pack/1 per outer pack

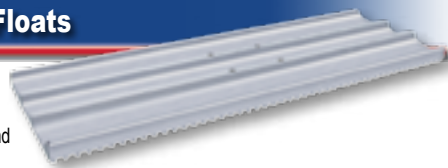

MADE IN
U.S.A.

MARSHALLTOWN The Premier Line

| EDI | Part# | Spacing | Size-in. | Size-mm |
|-------|----------------|---------------|----------|------------|
| 12988 | B245MT | 1/2" (13mm) | 24 X 8 | 610 X 203 |
| 12991 | B2475MT | 3/4" (19mm) | 24 X 8 | 610 X 203 |
| 12994 | B241MT | 1" (25mm) | 24 X 8 | 610 X 203 |
| 18795 | B2415MT | 1 1/2" (38mm) | 24 X 8 | 610 X 203 |
| 12997 | B24225MT | 2 1/4" (57mm) | 24 X 8 | 610 X 203 |
| 12989 | B365MT | 1/2" (13mm) | 36 X 8 | 914 X 203 |
| 12992 | B3675MT | 3/4" (19mm) | 36 X 8 | 914 X 203 |
| 12995 | B361MT | 1" (25mm) | 36 X 8 | 914 X 203 |
| 18796 | B3615MT | 1 1/2" (38mm) | 36 X 8 | 914 X 203 |
| 12998 | B36225MT | 2 1/4" (57mm) | 36 X 8 | 914 X 203 |
| 12990 | B485MT | 1/2" (13mm) | 48 X 8 | 1219 X 203 |
| 12993 | B4875MT | 3/4" (19mm) | 48 X 8 | 1219 X 203 |
| 12996 | B481MT | 1" (25mm) | 48 X 8 | 1219 X 203 |
| 18797 | B4815MT | 1 1/2" (38mm) | 48 X 8 | 1219 X 203 |
| 12999 | B48225MT | 2 1/4" (57mm) | 48 X 8 | 1219 X 203 |

Resin Bull Floats

- Works the slab like a wood float but it lasts many times longer
- Great for working color hardeners into concrete
- 6-hole mounting plate to fit the widest variety of mounting configurations
- Angle steel backbone for decreased blade twist
- Broken-in, beveled edges on ends of worksurface
- Sold 2 per inner pack/2 per outer pack

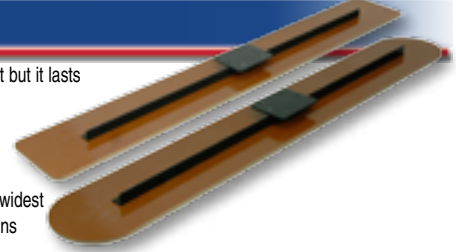

MARSHALLTOWN The Premier Line

| EDI | Part# | Description | Size-in. | Size-mm |
|-------|-------|-------------|----------|------------|
| 15624 | RB24R | Round End | 24 X 5 | 610 X 127 |
| 15601 | RB24 | Square End | 24 X 5 | 610 X 127 |
| 15626 | RB36R | Round End | 36 X 7 | 914 X 178 |
| 15625 | RB36 | Square End | 36 X 7 | 914 X 178 |
| 15628 | RB42R | Round End | 42 X 7 | 1067 X 178 |
| 15627 | RB42 | Square End | 42 X 7 | 1067 X 178 |
| 15648 | RB48R | Round End | 48 X 7 | 1219 X 178 |
| 15629 | RB48 | Square End | 48 X 7 | 1219 X 178 |

Wood Bull Floats

- Made of laminated poplar
- Tapered from 1 1/4" (32mm) thick at the center to 1 1/16" (18mm) thick at the ends
- Used to open the pores in setting concrete and to draw any excess water to the surface
- Comes with complete bracket assembly
- Sold 1 per inner pack/1 per outer pack



MADE IN
U.S.A.

MARSHALLTOWN The Premier Line

| EDI | Part# | Size-in. | Size-mm |
|-------|-------|----------|------------|
| 14696 | LB36 | 36 X 8 | 914 X 203 |
| 14705 | LB48 | 48 X 8 | 1219 X 203 |
| 14709 | LB60 | 60 X 8 | 1524 X 203 |

Laminated Wood Bull Floats

- Using several handle sections, the finisher can float a slab well beyond normal reach
- Used to open the pores in setting concrete and to draw any excess water to the surface
- Comes with complete bracket assembly
- Sold 1 per inner pack/1 per outer pack



MADE IN
U.S.A.

QLT BY MARSHALLTOWN

| EDI | Part# | Size-in. | Size-mm |
|-------|-------|----------|------------|
| 13860 | LF48 | 48 X 8 | 1219 X 203 |

Check us out on



YouTube

Find out great information about **MARSHALLTOWN** products and assembly instructions from your computer or mobile device



<http://www.youtube.com/MarshalltownCompany>

Gunite Fresno Trowels

- Exposed rivets on the underside for added strength
- Comes with an all-angle swivel attachment
- Use with our 9 or 10 series handle or 3749 bull float bracket adapter (sold separately)
- For use when working with gunite or "shotcrete"
- **M3142** comes with multi-mount bracket*
- Sold 1 per inner pack/1 per outer pack

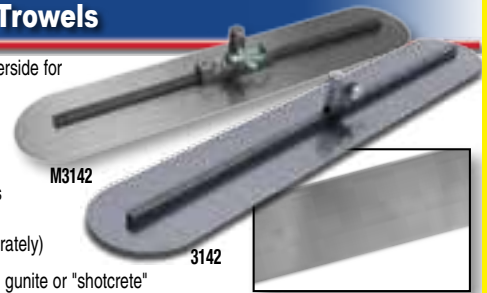

MADE IN U.S.A.

MARSHALLTOWN The Premier Line

| EDI | Part# | Size-in. | Size-mm |
|-------|--------|----------|-----------|
| 13142 | 3142 | 24 X 5 | 610 X 127 |
| 13005 | M3142* | 24 X 5 | 610 X 127 |

Fresno Trowels

- Superior quality high carbon steel blade
- Round ends leave less drag marks
- Use with our 9 or 10 series handle or 3749 bull float bracket adapter (sold separately)
- All-angle swivel attachment included
- Sold 1 per inner pack/1 per outer pack
- Available in inner pack quantities only

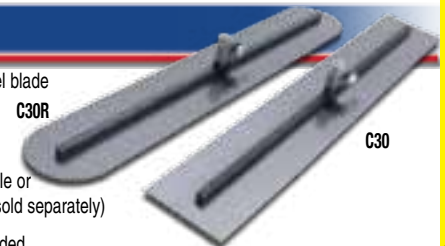

MADE IN U.S.A.

MARSHALLTOWN The Premier Line

| EDI | Part# | Description | Size-in. | Size-mm |
|-------|-------|-------------|----------|------------|
| 13724 | C24R | Round | 24 X 5 | 610 X 127 |
| 13630 | C30 | Square | 30 X 5 | 762 X 127 |
| 13730 | C30R | Round | 30 X 5 | 762 X 127 |
| 13736 | C36R | Round | 36 X 5 | 914 X 127 |
| 13779 | C48R | Round | 48 X 5 | 1219 X 127 |
| 13781 | C48 | Square | 48 X 5 | 1219 X 127 |

CONCRETE TOOLS

Multi-Mount Fresnos

- Superior quality high carbon steel blade
- Mounting block has center hole for swivel type bracket and end holes for two-hole brackets
- Can be used with all **MARSHALLTOWN** bull float brackets with two-hole mounting options
- Sold 1 per inner pack/1 per outer pack

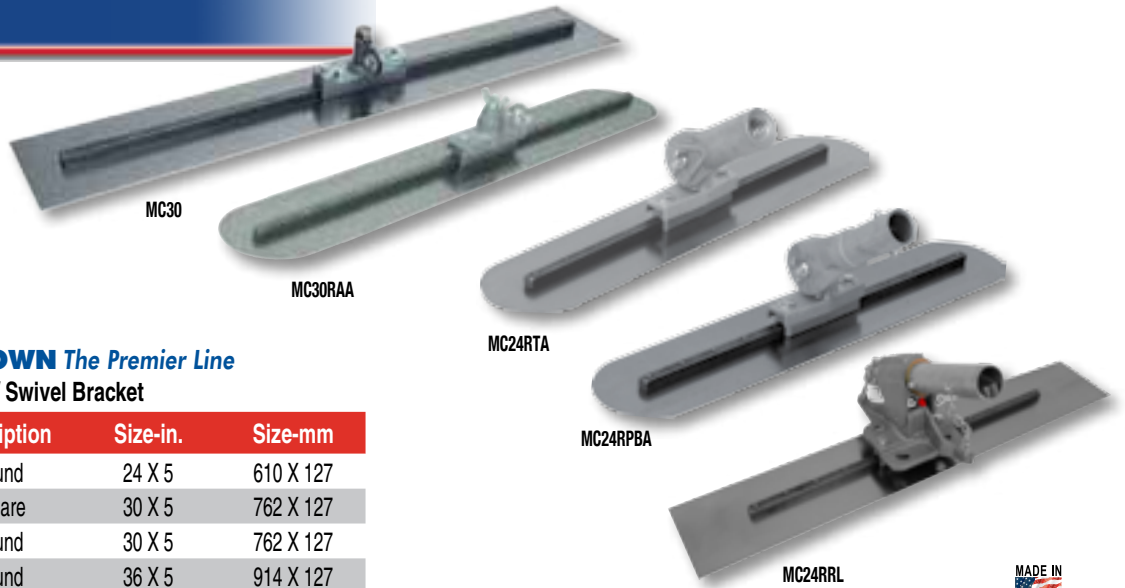

MARSHALLTOWN The Premier Line Fresno w/ Swivel Bracket

| EDI | Part# | Description | Size-in. | Size-mm |
|-------|-------|-------------|----------|------------|
| 13001 | MC24R | Round | 24 X 5 | 610 X 127 |
| 13002 | MC30 | Square | 30 X 5 | 762 X 127 |
| 13003 | MC30R | Round | 30 X 5 | 762 X 127 |
| 13004 | MC36R | Round | 36 X 5 | 914 X 127 |
| 13782 | MC48R | Round | 48 X 5 | 1219 X 127 |
| 13787 | MC48 | Square | 48 X 5 | 1219 X 127 |

Fresno w/ All-Angle Bracket

| EDI | Part# | Description | Size-in. | Size-mm |
|-------|---------|-------------|----------|------------|
| 10648 | MC24RAA | Round | 24 X 5 | 610 X 127 |
| 10652 | MC30AA | Square | 30 X 5 | 762 X 127 |
| 10656 | MC30RAA | Round | 30 X 5 | 762 X 127 |
| 10660 | MC36RAA | Round | 36 X 5 | 914 X 127 |
| 13783 | MC48RAA | Round | 48 X 5 | 1219 X 127 |
| 13788 | MC48AA | Square | 48 X 5 | 1219 X 127 |

Fresno w/ Adjustable Threaded Bracket

| EDI | Part# | Description | Size-in. | Size-mm |
|-------|---------|-------------|----------|------------|
| 10649 | MC24RTA | Round | 24 X 5 | 610 X 127 |
| 10653 | MC30TA | Square | 30 X 5 | 762 X 127 |
| 10657 | MC30RTA | Round | 30 X 5 | 762 X 127 |
| 10661 | MC36RTA | Round | 36 X 5 | 914 X 127 |
| 13784 | MC48RTA | Round | 48 X 5 | 1219 X 127 |
| 13789 | MC48TA | Square | 48 X 5 | 1219 X 127 |

MARSHALLTOWN The Premier Line Fresno w/ Adjustable Push Button Bracket

| EDI | Part# | Description | Size-in. | Size-mm |
|-------|----------|-------------|----------|------------|
| 10650 | MC24RPBA | Round | 24 X 5 | 610 X 127 |
| 10654 | MC30PBA | Square | 30 X 5 | 762 X 127 |
| 10658 | MC30RPBA | Round | 30 X 5 | 762 X 127 |
| 10662 | MC36RPBA | Round | 36 X 5 | 914 X 127 |
| 13785 | MC48RPBA | Round | 48 X 5 | 1219 X 127 |
| 13790 | MC48PBA | Square | 48 X 5 | 1219 X 127 |

Fresno w/ RotaLeveler® Bracket

| EDI | Part# | Description | Size-in. | Size-mm |
|-------|---------|-------------|----------|------------|
| 10651 | MC24RRL | Round | 24 X 5 | 610 X 127 |
| 10655 | MC30RL | Square | 30 X 5 | 762 X 127 |
| 10659 | MC30RRL | Round | 30 X 5 | 762 X 127 |
| 10663 | MC36RRL | Round | 36 X 5 | 914 X 127 |
| 13786 | MC48RRL | Round | 48 X 5 | 1219 X 127 |
| 13791 | MC48RL | Square | 48 X 5 | 1219 X 127 |



Multi-Mount Fresnos

- Constructed of either durable high-carbon steel, or blue steel
- Available with either adjustable brackets or all-angle brackets
- Can be used with all **MARSHALLTOWN** bull float brackets with two-hole mounting options
- Available in round or square end
- Round ends leave less drag marks
- Sold 1 per inner pack/1 per outer pack



Carbon Steel Fresno w/ All-Angle Bracket

| EDI | Part# | Description | Size-in. | Size-mm |
|-------|---------|-------------|----------|------------|
| 13509 | FR24AA | Square End | 24 X 5 | 610 X 127 |
| 13518 | FR24RAA | Round End | 24 X 5 | 610 X 127 |
| 13519 | FR30AA | Square End | 30 X 5 | 762 X 127 |
| 13540 | FR30RAA | Round End | 30 X 5 | 762 X 127 |
| 13541 | FR36AA | Square End | 36 X 5 | 914 X 127 |
| 13542 | FR36RAA | Round End | 36 X 5 | 914 X 127 |
| 13543 | FR42AA | Square End | 42 X 5 | 1067 X 127 |
| 13544 | FR42RAA | Round End | 42 X 5 | 1067 X 127 |
| 13545 | FR48AA | Square End | 48 X 5 | 1219 X 127 |
| 13546 | FR48RAA | Round End | 48 X 5 | 1219 X 127 |

Blue Steel Fresno w/ All-Angle Bracket

| EDI | Part# | Description | Size-in. | Size-mm |
|-------|----------|-------------|----------|------------|
| 13547 | FRB24AA | Square End | 24 X 5 | 610 X 127 |
| 13548 | FRB24RAA | Round End | 24 X 5 | 610 X 127 |
| 13549 | FRB30AA | Square End | 30 X 5 | 762 X 127 |
| 13550 | FRB30RAA | Round End | 30 X 5 | 762 X 127 |
| 13551 | FRB36AA | Square End | 36 X 5 | 914 X 127 |
| 13552 | FRB36RAA | Round End | 36 X 5 | 914 X 127 |
| 13553 | FRB42AA | Square End | 42 X 5 | 1067 X 127 |
| 13554 | FRB42RAA | Round End | 42 X 5 | 1067 X 127 |
| 13555 | FRB48AA | Square End | 48 X 5 | 1219 X 127 |
| 13556 | FRB48RAA | Round End | 48 X 5 | 1219 X 127 |

Carbon Steel Fresno w/ Adjustable Threaded Bracket

| EDI | Part# | Description | Size-in. | Size-mm |
|-------|---------|-------------|----------|------------|
| 13557 | FR24TA | Square End | 24 X 5 | 610 X 127 |
| 13558 | FR24RTA | Round End | 24 X 5 | 610 X 127 |
| 13559 | FR30TA | Square End | 30 X 5 | 762 X 127 |
| 13560 | FR30RTA | Round End | 30 X 5 | 762 X 127 |
| 13561 | FR36TA | Square End | 36 X 5 | 914 X 127 |
| 13562 | FR36RTA | Round End | 36 X 5 | 914 X 127 |
| 13563 | FR42TA | Square End | 42 X 5 | 1067 X 127 |
| 13564 | FR42RTA | Round End | 42 X 5 | 1067 X 127 |
| 13565 | FR48TA | Square End | 48 X 5 | 1219 X 127 |
| 13566 | FR48RTA | Round End | 48 X 5 | 1219 X 127 |

Blue Steel Fresno w/ Adjustable Threaded Bracket

| EDI | Part# | Description | Size-in. | Size-mm |
|-------|----------|-------------|----------|------------|
| 13567 | FRB24TA | Square End | 24 X 5 | 610 X 127 |
| 13568 | FRB24RTA | Round End | 24 X 5 | 610 X 127 |
| 13569 | FRB30TA | Square End | 30 X 5 | 762 X 127 |
| 13570 | FRB30RTA | Round End | 30 X 5 | 762 X 127 |
| 13571 | FRB36TA | Square End | 36 X 5 | 914 X 127 |
| 13572 | FRB36RTA | Round End | 36 X 5 | 914 X 127 |
| 13573 | FRB42TA | Square End | 42 X 5 | 1067 X 127 |
| 13574 | FRB42RTA | Round End | 42 X 5 | 1067 X 127 |
| 13575 | FRB48TA | Square End | 48 X 5 | 1219 X 127 |
| 13576 | FRB48RTA | Round End | 48 X 5 | 1219 X 127 |

Carbon Steel Fresno w/ BF9 Bracket

| EDI | Part# | Description | Size-in. | Size-mm |
|-------|----------|-------------|----------|-----------|
| 16216 | FR36BF9 | Square End | 36 X 5 | 914 X 127 |
| 16217 | FR36RBF9 | Round End | 36 X 5 | 914 X 127 |

Blue Steel Fresno w/ BF9 Bracket

| EDI | Part# | Description | Size-in. | Size-mm |
|-------|-----------|-------------|----------|-----------|
| 16218 | FRB36BF9 | Square End | 36 X 5 | 914 X 127 |
| 16219 | FRB36RBF9 | Round End | 36 X 5 | 914 X 127 |

Blue Gliders

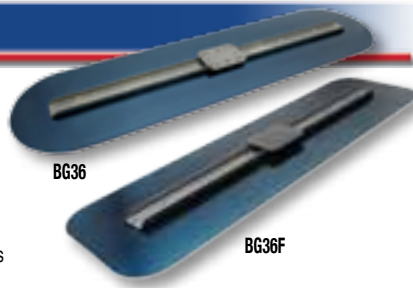

- Made of blue spring steel
- A C-channel runs the length of the gliders to help strengthen the blade
- Included with the gliders is a hardware package that contains two bolts, two nuts, two lock washers and two flat washers
- "F" denotes flat end with 3" (76mm) radius corners
- Can be used with any Adjustable Tilt Brackets See pages 85-86 for details
- **New item indicated in Red**
- Sold 1 per inner pack/1 per outer pack



MARSHALLTOWN The Premier Line

| EDI | Part# | Size-in. | Size-mm |
|-------|--------------|--------------------------|------------|
| 13977 | BG36 | 36 X 12 $\frac{3}{8}$ " | 914 X 314 |
| 13979 | BG36F | 36 X 12 $\frac{3}{8}$ " | 914 X 314 |
| 13981 | BG42 | 42 X 12 $\frac{3}{8}$ " | 1067 X 314 |
| 13983 | BG42F | 42 X 12 $\frac{3}{8}$ " | 1067 X 314 |
| 13987 | BG48 | 48 X 12 $\frac{3}{8}$ " | 1219 X 314 |
| 13988 | BG60 | 60 X 12 $\frac{3}{8}$ " | 1524 X 314 |
| 13989 | BG72 | 72 X 12 $\frac{3}{8}$ " | 1829 X 314 |
| 18563 | BG120 | 120 X 12 $\frac{3}{8}$ " | 3048 X 314 |

Multigroove Fresnos



- Stainless steel, welded and riveted construction
- 2-in-1 bracket mounting allows for either single bolt or two bolt brackets to be used
- Ships with adjustable, two-bolt bull float bracket
- Can mount all standard brackets from swivel to Rock-It® or "Twister"
- Creates grooves 1/4" (6mm) wide, 1/4" (6mm) deep with three different spacings
- Intended for grooving safety ramps, etc
- Sold 1 per inner pack/1 per outer pack



MARSHALLTOWN The Premier Line

| EDI | Part# | Size-in. | Size-mm | Spacing |
|-------|---------|----------|------------|---------------|
| 16207 | MGF2475 | 24 X 5 | 610 X 127 | 3/4" (19mm) |
| 16208 | MGF241 | 24 X 5 | 610 X 127 | 1" (25mm) |
| 16209 | MGF2415 | 24 X 5 | 610 X 127 | 1 1/2" (38mm) |
| 16210 | MGF3675 | 36 X 5 | 914 X 127 | 3/4" (19mm) |
| 16211 | MGF361 | 36 X 5 | 914 X 127 | 1" (25mm) |
| 16212 | MGF3615 | 36 X 5 | 914 X 127 | 1 1/2" (38mm) |
| 16213 | MGF4875 | 48 X 5 | 1219 X 127 | 3/4" (19mm) |
| 16214 | MGF481 | 48 X 5 | 1219 X 127 | 1" (25mm) |
| 16215 | MGF4815 | 48 X 5 | 1219 X 127 | 1 1/2" (38mm) |

Fresno Trowels

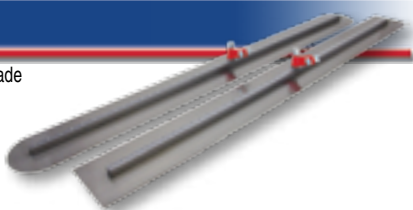

- Superior quality high carbon steel blade
- Come with an all-angle swivel attachment
- "R" at the end of part number indicates rounded ends
- Use with our 9 or 10 series handle, a clevis adapter or 3749 bull float bracket adapter (sold separately) see page 88 for details
- Sold 1 per inner pack/6 per outer pack



| EDI | Part# | Size-in. | Size-mm |
|-------|-------|----------|------------|
| 13999 | FR18R | 18 X 5 | 457 X 127 |
| 13990 | FR24 | 24 X 5 | 610 X 127 |
| 13991 | FR24R | 24 X 5 | 610 X 127 |
| 13992 | FR30 | 30 X 5 | 762 X 127 |
| 13993 | FR30R | 30 X 5 | 762 X 127 |
| 13870 | FR36 | 36 X 5 | 914 X 127 |
| 13871 | FR36R | 36 X 5 | 914 X 127 |
| 13994 | FR42 | 42 X 5 | 1067 X 127 |
| 13995 | FR42R | 42 X 5 | 1067 X 127 |
| 13996 | FR48 | 48 X 5 | 1219 X 127 |
| 13997 | FR48R | 48 X 5 | 1219 X 127 |

Threaded Handle Sections

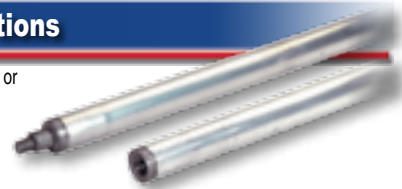

- Available in either lightweight aluminum or magnesium construction
- The large threads can be combined with similar handles
- **WARNING:** When using handle extensions, always avoid contact with electrical power lines or any electrical source
- Sold 6 per inner pack/6 per outer pack, sold 3 per inner pack/3 per outer pack where noted with *
- Available in inner pack quantities only



MARSHALLTOWN The Premier Line

Magnesium Handle Sections

| EDI | Part# | Size-in. | Size-mm | Diameter |
|-------|--------|----------|---------|---------------|
| 14835 | B5 60M | 60 | 1524 | 1 3/4" (44mm) |
| 14837 | B5 72M | 72 | 1829 | 1 3/4" (44mm) |

Aluminum Handle Sections

| EDI | Part# | Size-in. | Size-mm | Diameter |
|-------|---------|----------|---------|---------------|
| 15511 | B5 48 | 48 | 1219 | 1 3/4" (44mm) |
| 14802 | B5 60 | 60 | 1524 | 1 3/4" (44mm) |
| 14804 | B5 72 | 72 | 1829 | 1 3/4" (44mm) |
| 15512 | B5 96 | 96 | 2438 | 1 3/4" (44mm) |
| 15513 | B5 120* | 120 | 3048 | 1 3/4" (44mm) |
| 15514 | B5 144* | 144 | 3655 | 1 3/4" (44mm) |

Fiberglass Extension Handle

- Made of lightweight and strong fiberglass
- Handle sections are non-conductive and are safer to use around electrical sources, although care should be taken not to come in contact with power lines
- Sections can easily be threaded together
- Sold 6 per inner pack/6 per outer pack



MARSHALLTOWN The Premier Line

| EDI | Part# | Size-in. | Size-mm | Diameter |
|-------|---------|----------|---------|---------------|
| 11169 | B5 72TF | 72 | 1829 | 1 1/2" (38mm) |

Push Button Handle Sections

- Anodized spring loaded button-type aluminum sections snap together quickly and will not loosen during use
- **WARNING:** When using handle extensions, always avoid contact with electrical power lines or any electrical source
- Sold 6 per inner pack/6 per outer pack
- Available in inner pack quantities only

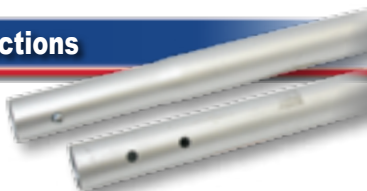

MADE IN
U.S.A

MARSHALLTOWN The Premier Line

| EDI | Part# | Size-in. | Size-mm | Diameter |
|-------|-------|----------|---------|---------------|
| 14806 | PB72 | 72 | 1829 | 1 3/8" (35mm) |
| 14807 | PB72L | 72 | 1829 | 1 3/4" (44mm) |

Magnesium Push Button Handle Sections

- Ultra lightweight and extra strong thick wall magnesium tubing
- Red powder coated finish
- Designed to fit **MARSHALLTOWN** aluminum push button handle sections, brackets and adapters
- **WARNING:** When using handle extensions, always avoid contact with electrical power lines or any electrical source
- Sold 6 per inner pack/6 per outer pack



RED700344M

QLT^{BY} MARSHALLTOWN

| EDI | Part# | Description | Size-in. | Size-mm | Diameter |
|-------|------------|-------------|----------|---------|---------------|
| 25638 | RED700344M | Red Handle | 72 | 1829 | 1 3/8" (35mm) |
| 25642 | RED700524M | Red Handle | 72 | 1829 | 1 3/4" (44mm) |
| 18623 | 17-7ASUM | Red Handle | 84 | 2134 | 1 3/4" (44mm) |
| 18624 | 17-9ASUM | Red Handle | 108 | 2743 | 1 3/4" (44mm) |

Push Button Handle Sections

- Constructed of thick-walled aluminum tubing
- Heat-treated, lightweight
- Quick connect snap spring positively locks handles in place
- **WARNING:** When using handle extensions, always avoid contact with electrical power lines or any electrical source
- Sold 6 per inner pack/6 per outer pack, sold 3 per inner pack/3 per outer pack where noted with *
- Available in inner pack quantities only
- Poles 10' and longer ship LTL

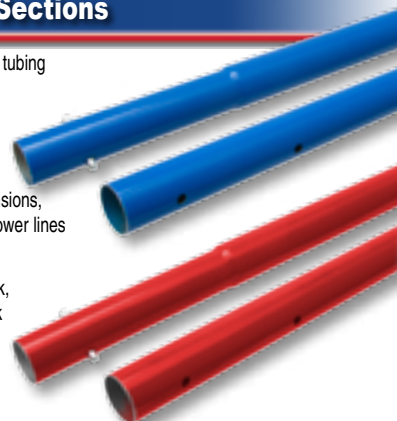

QLT^{BY} MARSHALLTOWN

| EDI | Part# | Description | Size-in. | Size-mm | Diameter |
|-------|-----------|----------------------|----------|---------|---------------|
| 14839 | PB48 | Powder Coated - Blue | 48 | 1219 | 1 3/8" (35mm) |
| 14258 | 17-6ASU | Powder Coated - Blue | 72 | 1829 | 1 3/8" (35mm) |
| 25605 | RED700344 | Powder Coated - Red | 72 | 1829 | 1 3/8" (35mm) |
| 14840 | PB96 * | Powder Coated - Blue | 96 | 2438 | 1 3/8" (35mm) |
| 25626 | RED704661 | Powder Coated - Red | 96 | 2438 | 1 3/8" (35mm) |
| 14843 | PB144 * | Anodized - Silver | 144 | 3655 | 1 3/8" (35mm) |
| 14845 | PB192 * | Anodized - Silver | 192 | 4877 | 1 3/8" (35mm) |
| 14846 | PB48L | Powder Coated - Blue | 48 | 1219 | 1 3/4" (44mm) |
| 14259 | 17-8ASU | Powder Coated - Blue | 72 | 1829 | 1 3/4" (44mm) |
| 25609 | RED700524 | Powder Coated - Red | 72 | 1829 | 1 3/4" (44mm) |
| 14847 | PB96L * | Powder Coated - Blue | 96 | 2438 | 1 3/4" (44mm) |
| 25631 | RED790276 | Powder Coated - Red | 96 | 2438 | 1 3/4" (44mm) |
| 14848 | PB120L * | Anodized - Silver | 120 | 3048 | 1 3/4" (44mm) |
| 25611 | RED700863 | Powder Coated - Red | 120 | 3048 | 1 3/4" (44mm) |
| 14849 | PB144L * | Anodized - Silver | 144 | 3655 | 1 3/4" (44mm) |
| 25608 | RED700522 | Powder Coated - Red | 144 | 3655 | 1 3/4" (44mm) |
| 14838 | PB192L * | Anodized - Silver | 192 | 4877 | 1 3/4" (44mm) |

Push Button Handles - Insert Style

- Constructed of blue powder coated, thick-walled aluminum tubing
- Insert style connector allows for damaged poles to be modified
- Insert style connector constructed of anodized - silver
- Compatible with 1 3/4" (44mm) push button handles and adapters
- **PBI120** and **PBI144** ship LTL only
- Sold 3 per inner pack/6 per outer pack
- **WARNING:** When using handle extensions, always avoid contact with electrical power lines or any electrical source



PBI

QLT^{BY} MARSHALLTOWN

| EDI | Part# | Description | Size-in. | Size-mm | Diameter |
|-------|--------|--------------|----------|---------|---------------|
| 15100 | PBI72 | Handle | 72 | 1829 | 1 3/4" (44mm) |
| 15101 | PBI96 | Handle | 96 | 2438 | 1 3/4" (44mm) |
| 15102 | PBI120 | Handle | 120 | 3655 | 1 3/4" (44mm) |
| 15103 | PBI144 | Handle | 144 | 4877 | 1 3/4" (44mm) |
| 15104 | PBI | Repl. Insert | N/A | N/A | N/A |

Adjustable Poles

- Fiberglass outer tube and broom threaded end
- Aluminum inner tube
- Heavy duty
- **WARNING:** When using handle extensions, always avoid contact with electrical power lines or any electrical source
- Sold 1 per inner pack/6 per outer pack



MADE IN
U.S.A

MARSHALLTOWN The Premier Line

| EDI | Part# | Size-in. | Size-mm | Diameter |
|-------|-------|----------|-----------|---------------|
| 14830 | FP48 | 51-96 | 1295-2438 | 1 1/4" (31mm) |
| 14831 | FP612 | 75-144 | 1905-3658 | 1 1/4" (31mm) |
| 14832 | FP832 | 78-213 | 1981-5401 | 1 1/4" (31mm) |

Threaded Handle Adapters

- Modifies threaded handle into a clevis end
- Designed for use with standard broom threaded magnesium handle sections
- Can be used with concrete trowels, walking edgers and groovers and other tools with "post" type connectors
- "N" after part number denotes a narrower clevis attachment for a tighter fit
- Sold 1 per inner pack/50 per outer pack

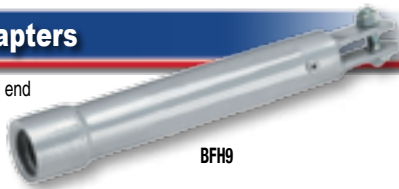

BFH9

MARSHALLTOWN The Premier Line

| EDI | Part# | Size-in. | Size-mm | Diameter |
|-------|-------|----------|---------|---------------|
| 14812 | BFH9 | 9 | 229 | 1 3/8" (35mm) |
| 14787 | BFH9N | 9 | 229 | 1 3/8" (35mm) |

Push Button Adapters

- Allows finisher to use threaded handles on adjustable bracket assemblies requiring a push button attachment
- 15538 features a male threaded end
- 15539 features a female threaded end
- Sold 6 per inner pack/6 per outer pack



15538

15539

MADE IN
U.S.A

MARSHALLTOWN The Premier Line

| EDI | Part# | Size-in. | Size-mm | Diameter |
|-------|-------|----------|---------|---------------|
| 15538 | 15538 | 10 1/2 | 267 | 1 3/4" (44mm) |
| 15539 | 15539 | 8 1/2 | 216 | 1 3/4" (44mm) |

Threaded Handle Adapter

- Converts push button handles to threaded extension handles
- For use with tools which require a threaded end; such as bull floats, concrete brooms and other tools
- Sold 1 per inner pack/6 per outer pack

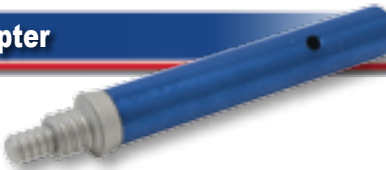

QLT[™] BY MARSHALLTOWN

| EDI | Part# | Size-in. | Size-mm | Diameter |
|-------|---------|----------|---------|---------------|
| 14255 | 17-12M7 | 12 | 305 | 1 3/8" (35mm) |

Push Button Adapters

- FT6 and FT6N feature a steel clevis end
- "N" after part number denotes a narrower clevis attachment for a tighter fit
- Modifies push button handle sections for use with tools which require a steel clevis end; such as concrete trowels, walking edgers and groovers, and other tools with "post" type connectors
- BF8 features a threaded male end that modifies push button handle sections for use with tools which require a threaded end; such as bull floats, concrete brooms and other tools
- Can be used with our PB72 handle and similar handles (sold separately)
- Inner and outer pack quantities are shown in table

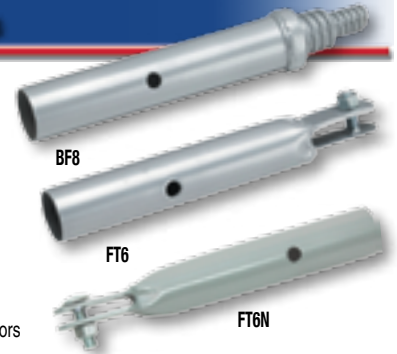

BF8

FT6

FT6N

MARSHALLTOWN The Premier Line

| EDI | Part# | Size-in. | Size-mm | Diameter | Inner/Outer |
|-------|-------|----------|---------|---------------|-------------|
| 14808 | FT6 | 9 | 229 | 1 3/8" (35mm) | 1/6 |
| 14774 | FT6N | 9 | 229 | 1 3/8" (35mm) | 1/50 |
| 14810 | BF8 | 9 | 229 | 1 3/8" (35mm) | 1/3 |

Push Button Adapters

- Modifies push button handle sections for use with tools which require a steel clevis end; such as concrete trowels, walking edgers and groovers and other tools with "post" type connectors
- Sold 1 per inner pack/6 per outer pack



17-8F

17-13F

QLT[™] BY MARSHALLTOWN

| EDI | Part# | Size-in. | Size-mm | Diameter |
|-------|--------|----------|---------|---------------|
| 14256 | 17-8F | 8 | 203 | 1 3/8" (35mm) |
| 14257 | 17-13F | 8 | 203 | 1 3/4" (44mm) |

Button Clips

- Single button clips for 1 3/8" (35mm) push button handles
- Double button clips for 1 3/4" (44mm) push button handles and adapters
- 1 box contains 12 clips
- Sold 1 box per inner pack/1 box per outer pack



MARSHALLTOWN The Premier Line

| EDI | Part# | Buttons | Size-in. | Size-mm |
|-------|-------|---------|----------|---------|
| 12196 | 12196 | Single | N/A | N/A |
| 12197 | 12197 | Double | N/A | N/A |

Push Button Adapters

- Fit 1³/₈" (35mm) and 1³/₄" (44mm) push button handles
- Use with bull floats, fresnos, brooms, etc.
- **AHK4948** box contains 12 assemblies
- Sold 1 per inner pack/6 per outer pack, 1 per outer pack where noted with *



MARSHALLTOWN The Premier Line

| EDI | Part# | Description | Origin |
|-------|----------|----------------------|----------------|
| 14818 | 4818 | Clevis End | MADE IN U.S.A. |
| 14819 | 4819 | Male Thread | - |
| 14820 | 4820 | Female Thread | MADE IN U.S.A. |
| 14821 | 4821 | Post Adapter | - |
| 14822 | 4822 | Bull Float Adapter | MADE IN U.S.A. |
| 14948 | AHK4948* | Adapter Hardware Kit | MADE IN U.S.A. |

Push Button Adapters

- Fit 1³/₈" (35mm) and 1³/₄" (44mm) push button handles
- Use with bull floats, fresnos, brooms, etc.
- Sold 1 per inner pack/1 per outer pack

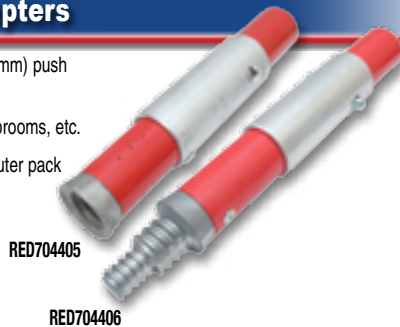

QLT^{BY} MARSHALLTOWN

| EDI | Part# | Description |
|-------|-----------|---------------|
| 20063 | RED704405 | Female Thread |
| 20064 | RED704406 | Male Thread |

Threaded Handle Adapter

- Modifies threaded handle into a clevis end
- Designed for use with standard broom threaded magnesium handle sections
- Can be used with concrete trowels, walking edgers and groovers and other tools with "post" type connectors
- Sold 1 per inner pack/1 per outer pack



QLT^{BY} MARSHALLTOWN

| EDI | Part# | Description |
|-------|-----------|-----------------------|
| 20066 | RED704408 | Threaded Post Adapter |

Auto-Just®

- This bracket changes pitch automatically by just pushing and pulling
- Eliminates twisting, turning, raising and lowering when floating concrete
- Either screw type or push button handles may be used
- Push button handle requires a threaded adapter
- Universal mounting plate is included-fits all two and four hole bull floats
- Sold 1 per inner pack/1 per outer pack



MADE IN U.S.A.

MARSHALLTOWN The Premier Line

| EDI | Part# | Size-in. | Size-mm |
|-------|-------|----------|---------|
| 14800 | AB4 | N/A | N/A |

RotaLeveler® & Adapter

- Fits all two and four hole bull floats without adapters
- **RL6** is chain driven, **RL6C** is cable driven
- Features easy control adjustment, smooth operation and a large protected grease reservoir
- Accepts most 1³/₄" (44mm) and 1³/₈" (35mm) push button handles without adapters
- Easier to keep clean than most competitors' units
- Sold 1 per inner pack/1 per outer pack

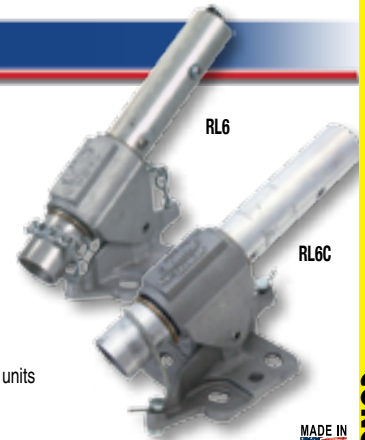

MADE IN U.S.A.

MARSHALLTOWN The Premier Line

| EDI | Part# | Size-in. | Size-mm |
|-------|-------|----------|---------|
| 14801 | RL6 | N/A | N/A |
| 14798 | RL6C | N/A | N/A |

Rock-It™

- Allows multi-angle floating
- Enables use with extension handles for extremely long ranges
- Full pitch controlled by half turn of handle
- Fits all magnesium bull floats without adapter plates
- Fits all push button handles -1³/₈" (35mm) and 1³/₄" (44mm) without additional adapters
- Sold 1 per inner pack/1 per outer pack



QLT^{BY} MARSHALLTOWN

| EDI | Part# | Size-in. | Size-mm |
|-------|----------|----------|---------|
| 14251 | 16-RKT-N | N/A | N/A |

Rock-It™ 2.0

- Allows multi-angle floating
- Enables use with extension handles for extremely long ranges
- Full pitch controlled by half turn of handle
- Fits all magnesium bull floats without adapter plates
- Fits all push button handles - 1³/₈" (35mm) and 1³/₄" (44mm) without any additional adapters
- Sold 1 per inner pack/1 per outer pack



QLT BY MARSHALLTOWN

| EDI | Part# | Size-in. | Size-mm |
|-------|-------|----------|---------|
| 14799 | BF9 | N/A | N/A |

"Twister" Bull Float Bracket

- Cast aluminum bracket
- Universal mounting that fits any two or four hole bull float without adapters
- Gear driven for continuous adjustment
- Gears maintain pitch of blade reducing stress on wrist and arms
- Fits 1³/₈" (35mm) and 1³/₄" (44mm) push button handles
- Sold 1 per inner pack/1 per outer pack



QLT BY MARSHALLTOWN

| EDI | Part# | Size-in. | Size-mm |
|-------|-------|----------|---------|
| 16191 | T91 | N/A | N/A |

Eliminator™ - Composite Adapter

- Fits all two and four hole bull floats without adapters
- Composite body is non-conductive
- **RED705050W** is cable driven
- Features easy control adjustment, smooth operation and a large protected grease reservoir
- Accepts most 1³/₄" (44mm) and 1³/₈" (35mm) push button handles without adapters
- Sold 1 per inner pack/1 per outer pack

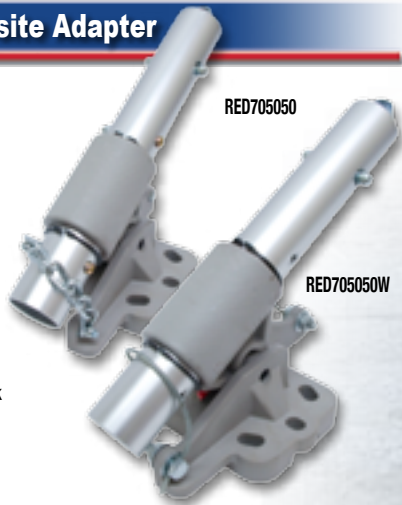

MARSHALLTOWN The Premier Line

| EDI | Part# | Size-in. | Size-mm |
|-------|------------|----------|---------|
| 20015 | RED705050 | N/A | N/A |
| 20030 | RED705050W | N/A | N/A |

K2 - Composite Adapter

- Fits all two and four hole bull floats without adapters
- 1-to-1 turning ratio for easier handling
- Composite body is non-conductive
- Features easy control adjustment, smooth operation and a large protected grease reservoir
- Accepts most 1³/₄" (44mm) and 1³/₈" (35mm) push button handles without adapters
- Sold 1 per inner pack/1 per outer pack



MARSHALLTOWN The Premier Line

| EDI | Part# | Size-in. | Size-mm |
|-------|-------|----------|---------|
| 20037 | REDK2 | N/A | N/A |

Mini Rock-It™

- Allows handle placement in any position within a 180° sweep
- Turn handle clockwise to lock in position; counter clockwise to unlock
- Connects push button handles to edgers, groovers, fresnos and bull floats
- Sold 1 per inner pack/6 per outer pack



QLT BY MARSHALLTOWN

| EDI | Part# | Diameter |
|-------|--------|--|
| 14252 | 16-MR | 1 ³ / ₈ " (35mm) |
| 14253 | 16-MRL | 1 ³ / ₄ " (44mm) |



360° Twist Brackets

- Compatible with bull floats, groovers, edgers, fresnos, brooms and more
- Allows quick, easy adjustments on the job
- 0° to 90° handle-angle adjustment and full 360° rotation of finishing tool
- Sold 1 per inner pack/6 per outer pack

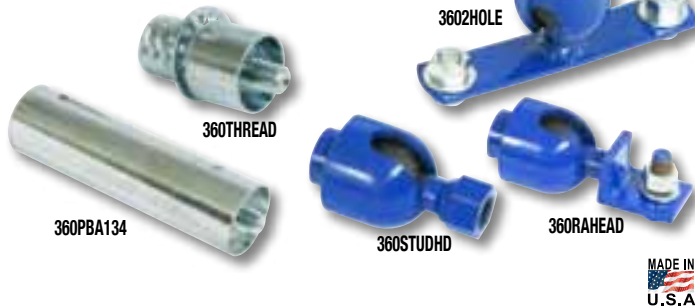

MADE IN
U.S.A.

MARSHALLTOWN The Premier Line

| EDI | Part# | Description | Size-in. | Size-mm |
|-------|-----------|--------------------------|-------------------------------|---------|
| 10098 | 360STUDHD | Stud Head | N/A | N/A |
| 10099 | 3602HOLE | 2-Hole Head | N/A | N/A |
| 10100 | 360UNIV6 | Universal 6-Hole Head | N/A | N/A |
| 10101 | 360RAHEAD | Right Angle Bracket Head | N/A | N/A |
| 10103 | 360PBA138 | Push Button Adapter | 1 ³ / ₈ | 35 |
| 10113 | 360PBA134 | Push Button Adapter | 1 ³ / ₄ | 44 |
| 10117 | 360THREAD | Threaded Handle Adapter | N/A | N/A |

EZ Twist Heads

- Compatible with bull floats, groovers, edgers, fresnos, brooms and more
- Allows quick, easy adjustments on the job
- 0° to 90° handle-angle adjustment and full 360° rotation of finishing tool
- Sold 1 per inner pack/6 per outer pack,

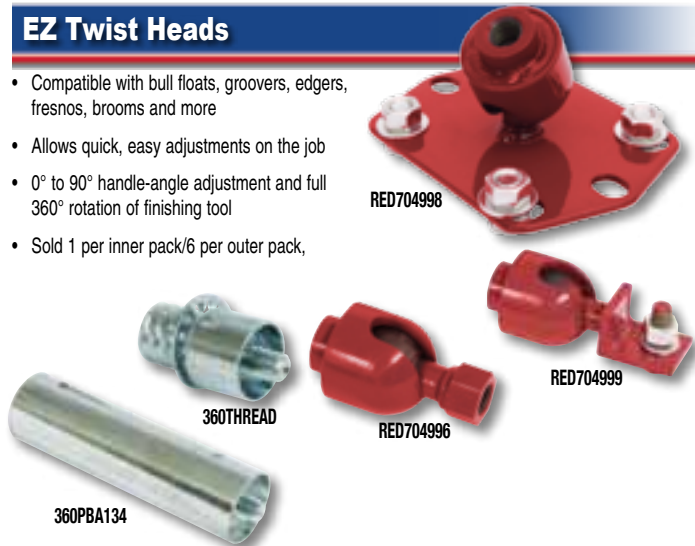

QLT BY MARSHALLTOWN

| EDI | Part# | Description | Size-in. | Size-mm |
|-------|-----------|-------------------------|-------------------------------|---------|
| 21012 | RED704995 | Tang Adapter | N/A | N/A |
| 21013 | RED704996 | Threaded Stud | N/A | N/A |
| 21015 | RED704998 | 6-Hole Plate | N/A | N/A |
| 21016 | RED704999 | Right Angle Bracket | N/A | N/A |
| 10103 | 360PBA138 | Push Button Adapter | 1 ³ / ₈ | 35 |
| 10113 | 360PBA134 | Push Button Adapter | 1 ³ / ₄ | 44 |
| 10117 | 360THREAD | Threaded Handle Adapter | N/A | N/A |

Bull Float Replacement Parts

- Fits most four hole bull floats
- Sold 1 per inner pack/1 per outer pack

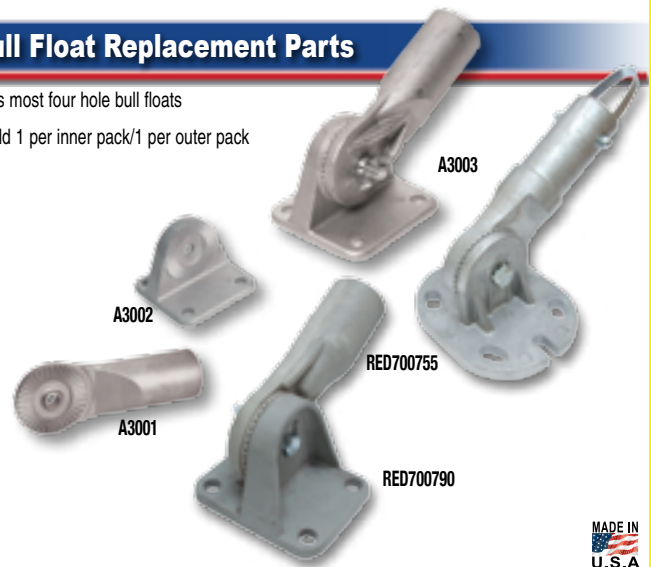

MADE IN
U.S.A.

MARSHALLTOWN The Premier Line

| EDI | Part# | Diameter |
|-------|-----------|-------------------------------|
| 19162 | A3001 | Handle Socket |
| 19164 | A3002 | Bracket Base |
| 19166 | A3003 | Threaded Complete Assembly |
| 20047 | RED700755 | Push Button Complete Assembly |

Universal Mounting Plate

- Adapts bull floats and brackets to a two or four hole mounting
- Can be used with the Auto-Just® bull float bracket and similar brackets made by others
- Sold 1 per inner pack/1 per outer pack



MADE IN
U.S.A.

MARSHALLTOWN The Premier Line

| EDI | Part# | Size-in. | Size-mm |
|-------|-------|----------|---------|
| 19176 | A3008 | N/A | N/A |

Fresno Bull Float Bracket Adapter

- Bracket will operate a fresno with a bull float bracket
- Sold 1 per inner pack/1 per outer pack



MADE IN
U.S.A.

QLT BY MARSHALLTOWN

| EDI | Part# | Size-in. | Size-mm |
|-------|-------|----------|---------|
| 13749 | 3749 | N/A | N/A |

Tool Weights

- Fits all **MARSHALLTOWN** and QLT bull floats, blue gliders and fresnos, as well as most other brands
- Sold in pairs, 1 per inner/outer pack



QLT BY MARSHALLTOWN

| EDI | Part# | Size-lbs. | Size-kgs |
|-------|-------|-----------|-----------|
| 13869 | 13869 | 5-each | 2.25-each |

Adapters for Multi-Mount Fresnos

- **3006** is an all-angle adapter and is used with a clevis end handle
- **3007** is the adjustable bracket and is used with a threaded bull float handle
- **3008** is the adjustable bracket and is used with a push button bull float handle
- Sold 1 per inner pack/1 per outer pack



QLT BY MARSHALLTOWN

| EDI | Part# | Description |
|-------|-------|------------------------|
| 13006 | 3006 | All-Angle |
| 13007 | 3007 | Adjustable Threaded |
| 13008 | 3008 | Adjustable Push Button |

2 Post Clevis Bracket

- Fits all 2-post style tools such as all-steel walking groovers
- Use with our narrow **9** or **10** series clevis-end handles (sold separately) see below for details
- **15255** features a swivel clevis bracket for all-angle applications
- Sold 6 per inner pack/30 per outer pack

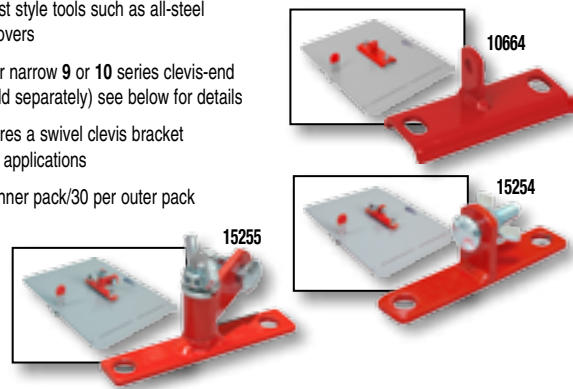

QLT BY MARSHALLTOWN

| EDI | Part# | Description |
|-------|-------|-------------|
| 10664 | 10664 | Clevis |
| 15254 | 15254 | Flat Clevis |
| 15255 | 15255 | All-angle |

Fresno Trowel Adapter

- **3748** has rugged aluminum casting
- Designed specifically to connect standard threaded handle sections to a fresno, walking edger or groover or any other tools that are equipped with similar attachment devices
- **3748** has unique "wrench-flats" feature for easy removal
- Sold 6 per inner pack/72 per outer pack



QLT BY MARSHALLTOWN

| EDI | Part# | Description |
|-------|-----------|------------------|
| 13748 | 3748 | Molded Aluminum |
| 20067 | RED704432 | Molded Composite |

Funny Trowel Handle Adapters

- Use with our clevis-end handles (sold separately) to turn a concrete finishing trowel into a small fresno
- **4826** includes a swivel clevis bracket for all-angle applications
- **4816** features two clevis handle mountings
- Sold 6 per inner pack/60 per outer pack, sold 6 per inner pack/30 per outer pack where noted with *



QLT BY MARSHALLTOWN

| EDI | Part# | Description |
|-------|-------|------------------------|
| 14816 | 4816 | Two Clevis Mountings |
| 14817 | 4817* | Single Clevis Mounting |
| 14826 | 4826 | Swivel Clevis Mounting |

Wood Handles

- Wood handles are fitted with a steel clevis
- For use with tools with a clevis-style bracket
- Two sizes to choose from
- "NW" and "NC" after part number denotes a narrow clevis end for a tighter fit
- **NW** is a narrow weld clevis - slightly bendable
- **NC** is a narrow cast clevis - stays rigid
- Sold 1 per inner pack/6 per outer pack

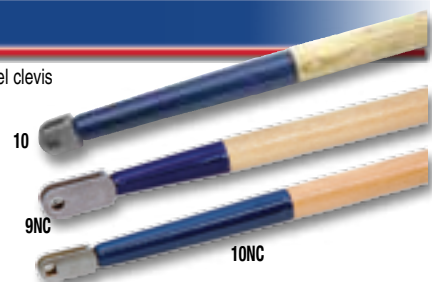

MADE IN U.S.A

MARSHALLTOWN The Premier Line

| EDI | Part# | Size-in. | Size-mm | Diameter | Width |
|-------|-------|----------|---------|---|------------|
| 14841 | 9 | 54 | 1372 | 1 ¹ / ₁₆ " (26mm) | .32" (8mm) |
| 14768 | 9NC | 54 | 1372 | 1 ¹ / ₁₆ " (26mm) | .25" (6mm) |
| 14769 | 9NW | 54 | 1372 | 1 ¹ / ₁₆ " (26mm) | .25" (6mm) |
| 14842 | 10 | 72 | 1829 | 1 ¹ / ₂ " (39mm) | .32" (8mm) |
| 14796 | 10NC | 72 | 1829 | 1 ¹ / ₂ " (39mm) | .25" (6mm) |
| 14797 | 10NW | 72 | 1829 | 1 ¹ / ₂ " (39mm) | .25" (6mm) |

Steel Spred-Kretes

- Choice of 12 or 14 gauge cold rolled steel blade
- Choice of 54" (1372mm) or 60" (1524mm) wood handle
- Sturdy steel ferrule is welded securely to the blade and holds the contoured handle firmly in place
- Superior to a jam type connector
- 826 and 827 ship unassembled
- Placer heads sold 6 per inner pack/6 per outer pack, handles sold 1 per inner pack/6 per outer pack
- H826-5 and H827-5 bulk packs of 32, preassembled with handles



MADE IN
U.S.A

MARSHALLTOWN The Premier Line

| EDI | Part# | Description | Size-in. | Size-mm |
|-------|-------|-----------------|------------|-----------|
| 14726 | 826 | Placer w/Hook | 20 X 4 | 508 X 102 |
| 14727 | 827 | Placer w/o Hook | 20 X 4 | 508 X 102 |
| 14828 | 828 | Wood Handle | 54 X 1 1/4 | 1372 X 32 |

Bulk Packs of 32 - 12-gauge Steel Blade w/54"(1372mm) Wood Handle

| EDI | Part# | Description | Blade Size-in. | Blade Size-mm |
|-------|--------|---------------------|----------------|---------------|
| 14401 | H826-5 | Bulk of 32 w/Hook | 20 X 4 | 508 X 102 |
| 14403 | H827-5 | Bulk of 32 w/o Hook | 20 X 4 | 508 X 102 |

Texas Placers

- Blade of 12-gauge powder coated steel
- Comes with 60 X 1 1/4" (1524 X 32mm) hardwood contoured handle
- Comes with 48 X 1 1/4" (1219 X 32mm) hardwood contoured handle where noted with *
- Heavy weighted handle is ideal for placing dense pervious concrete
- Ships assembled
- TP159, TP159H, TP648 and TP648H sold 5 per inner pack/5 per outer pack
- TP159-5, TP159H-5, TP648-5 and TP648H-5 are bulk packs of 32, preassembled with handle
- Available in inner pack quantities only



MARSHALLTOWN The Premier Line

| EDI | Part# | Description | Size-in. | Size-mm |
|-------|-----------|---------------------|----------|-----------|
| 12648 | TP648* | Placer w/o hook | 20 X 5 | 508 X 127 |
| 12649 | TP648-5* | Bulk of 32 w/o hook | 20 X 5 | 508 X 127 |
| 12682 | TP648H* | Placer w/ hook | 20 X 5 | 508 X 127 |
| 12683 | TP648H-5* | Bulk of 32 w/ hook | 20 X 5 | 508 X 127 |
| 14159 | TP159 | Placer w/o hook | 20 X 5 | 508 X 127 |
| 14163 | TP159-5 | Bulk of 32 w/o hook | 20 X 5 | 508 X 127 |
| 14165 | TP159H | Placer w/ hook | 20 X 5 | 508 X 127 |
| 14167 | TP159H-5 | Bulk of 32 w/ hook | 20 X 5 | 508 X 127 |

Concrete Spreader

- Lightweight steel placer with rib for extra stiffness
- Ships pre-assembled with 54" x 1 1/8" (1372 x 26 mm) wood handle
- Available with or without hook
- Sold 5 per inner pack/ 5 per outer pack
- CSHDL replacement handle sold 1 per inner pack/ 6 per outer pack

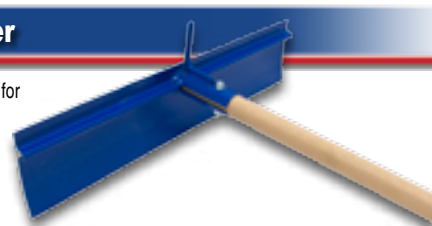

MADE IN
U.S.A

MARSHALLTOWN The Premier Line

| EDI | Part# | Description | Size-in. | Size-mm |
|-------|--------|-------------------|------------|-----------|
| 16247 | CS247 | Spreader w/o hook | 19 1/2 X 4 | 495 X 102 |
| 16248 | CS247H | Spreader w/ hook | 19 1/2 X 4 | 495 X 102 |
| 16249 | CSHDL | Repl. Handle | 54 X 1 1/8 | 1372 X 28 |

All Aluminum Push-N-Pull Placer

- Ideal tool for pushing and pulling concrete into place
- Lightweight aluminum construction
- Durable powder coated handle and rubberized grip
- Handle measures 60 X 1 3/8" (1524 X 35mm)
- Sold 5 per inner pack/5 per outer pack



MADE IN
U.S.A

MARSHALLTOWN The Premier Line

| EDI | Part# | Blade Size-in. | Blade Size-mm |
|-------|------------|----------------|---------------|
| 24915 | RED700200A | 20 X 4 | 508 X 102 |

Push-N-Pull Aluminum Placer

- Ideal tool for pushing and pulling concrete into place
- Sturdy, oversized 60" (1524mm) wood handle
- Lightweight aluminum head for less fatigue and more control
- Sold 5 per inner pack/5 per outer pack



MADE IN
U.S.A

MARSHALLTOWN The Premier Line

| EDI | Part# | Blade Size-in. | Blade Size-mm |
|-------|--------|----------------|---------------|
| 10325 | WAP120 | 20 | 508 |
| 10327 | WAP130 | 30 | 762 |
| 10329 | WAPHDL | N/A | N/A |

All Aluminum Placers

- Aluminum construction, powder coated with soft grip end-cap
- Braced for additional strength
- 60" (1524mm) long
- **AP753H** has a hook
- Sold 5 per inner pack/5 per outer pack
- Available in inner pack quantities only



MADE IN
U.S.A

MARSHALLTOWN The Premier Line

| EDI | Part# | Description | Blade Size-in. | Blade Size-mm |
|-------|--------|-----------------|----------------|---------------|
| 14753 | AP753 | Placer w/o Hook | 19½ X 4 | 495 X 102 |
| 13739 | AP753H | Placer w/ Hook | 19½ X 4 | 495 X 102 |

All Aluminum Open Angle Pull Crete

- Lightweight aluminum construction
- Braced for additional strength
- Durable powder coated handle and rubberized grip
- Handle measures 60 X 1 1/8" (1524 X 35mm)
- Sold 5 per inner pack/5 per outer pack

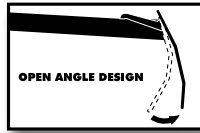

MADE IN
U.S.A

MARSHALLTOWN The Premier Line

| EDI | Part# | Description | Blade Size-in. | Blade Size-mm |
|-------|-----------|-----------------|----------------|---------------|
| 24837 | RED700158 | Placer w/o Hook | 20 X 3¾ | 508 X 95 |
| 24835 | RED700156 | Placer w/Hook | 20 X 3¾ | 508 X 95 |

Aluminum Pull Crete Fiberglass Handle

- Braced for additional strength
- Lightweight fiberglass handle
- Open angle profile
- Handle measures 54 X 1 1/8" (1372 X 26mm)
- Sold 5 per inner pack/5 per outer pack



MADE IN
U.S.A

MARSHALLTOWN The Premier Line

| EDI | Part# | Description | Blade Size-in. | Blade Size-mm |
|-------|-----------|-----------------------------|----------------|---------------|
| 24857 | RED700928 | Braced | 20 X 4 | 508 X 102 |
| 24860 | RED700990 | Braced w/Hook | 20 X 4 | 508 X 102 |
| 24537 | RED704842 | 54" Fiberglass Repl. Handle | N/A | N/A |

Aluminum Pull Crete

- Braced for additional strength
- Wood handle measures 54 X 1 1/8" (1372 X 35mm) or 60 X 1 1/8" (1524 X 35mm)
- Sold 5 per inner pack/5 per outer pack

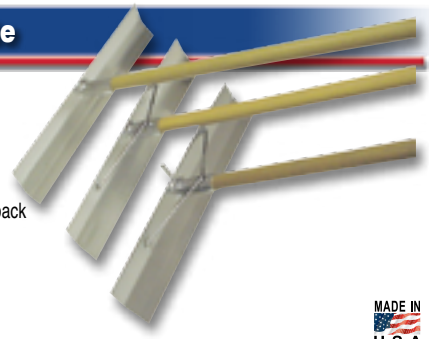

MADE IN
U.S.A

MARSHALLTOWN The Premier Line

Aluminum Placer w/54"(1372mm) Wood Handle

| EDI | Part# | Description | Blade Size-in. | Blade Size-mm |
|-------|-----------|----------------------|----------------|---------------|
| 24833 | RED700152 | Placer Braced | 20 X 4 | 508 X 102 |
| 24834 | RED700153 | Placer Braced w/Hook | 20 X 4 | 508 X 102 |

Aluminum Placer w/60"(1524mm) Wood Handle

| EDI | Part# | Description | Blade Size-in. | Blade Size-mm |
|-------|-----------|----------------------|----------------|---------------|
| 24849 | RED700567 | Placer Braced | 20 X 4 | 508 X 102 |
| 24836 | RED700157 | Placer Braced w/Hook | 20 X 4 | 508 X 102 |

Lightweight Aluminum Placers

- Strong, lightweight aluminum head
- Head is braced for additional strength
- All items come preassembled with a 54" (1372mm) wood handle
- Blade measures 19½ X 4" (495 X 102mm)
- **AP867** and **AP867H** sold 5 per inner pack/5 per outer pack
- **AP867-5** and **AP867H-5** bulk packs of 32



QLT[™] MARSHALLTOWN

| EDI | Part# | Description | Blade Size-in. | Blade Size-mm |
|-------|----------|-----------------|----------------|---------------|
| 16867 | AP867 | Placer w/o Hook | 19½ X 4 | 495 X 102 |
| 16869 | AP867H | Placer w/Hook | 19½ X 4 | 495 X 102 |
| 16868 | AP867-5 | Bulk of 32 | N/A | N/A |
| 16870 | AP867H-5 | Bulk of 32 | N/A | N/A |
| 16871 | AP867RH | Repl. Handle | N/A | N/A |

Aluminum Econo Crete

- Braced for additional strength
- Made of 10 gauge aluminum alloy
- Open angle profile
- Wood handle measures
54 X 1³/₈" (1372 X 35mm) or
60 X 1³/₈" (1524 X 35mm)
- Sold 5 per inner pack/5 per outer pack

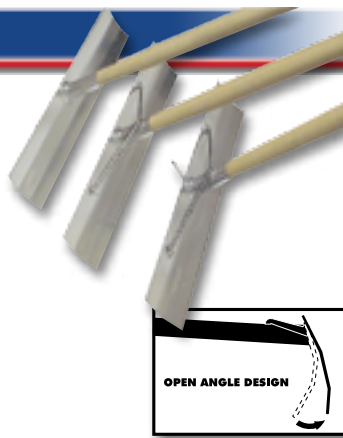

QLT BY MARSHALLTOWN



Aluminum Placer w/54" (1372mm) Wood Handle

| EDI | Part# | Description | Blade Size-in. | Blade Size-mm |
|-------|-----------|----------------------|----------------|---------------|
| 24843 | RED700505 | Placer Braced | 20 X 4 | 508 X 102 |
| 24844 | RED700520 | Placer Braced w/Hook | 20 X 4 | 508 X 102 |

Aluminum Placer w/60" (1524mm) Wood Handle

| EDI | Part# | Description | Blade Size-in. | Blade Size-mm |
|-------|-----------|----------------------|----------------|---------------|
| 24847 | RED700561 | Placer Braced | 20 X 4 | 508 X 102 |
| 24845 | RED700521 | Placer Braced w/Hook | 20 X 4 | 508 X 102 |

Replacement Handles

| EDI | Part# | Description | Size-in. | Size-mm |
|-------|-----------|-------------|--------------------------------------|-----------|
| 24993 | RED704335 | Wood Handle | 54 X 1 ¹ / ₈ " | 1372 X 26 |

Pul-Krete

- Blade is made of 12-gauge cold rolled steel
- Comes with 54 X 1¹/₈" (1372 X 26mm) hardwood handle
- **CM419** sold 2 per inner pack/2 per outer pack
- **CM419-5** bulk pack of 32, preassembled with handle
- Available in inner pack quantities only

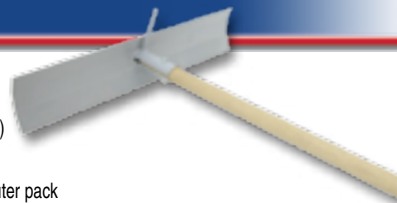

QLT BY MARSHALLTOWN

| EDI | Part# | Description | Blade Size-in. | Blade Size-mm |
|-------|---------|-------------|----------------|---------------|
| 13877 | CM419 | Pul-Krete | 19 X 4 | 483 X 102 |
| 14433 | CM419-5 | Bulk of 32 | N/A | N/A |

Open Angle Aluminum Placer Heads

- Strong, lightweight tool spreads and grades concrete
- Blade angle promotes a more upright stance
- Two metal braces for greater strength
- Use with 1³/₈" (35mm) push button poles (sold separately)
- Sold 1 per inner pack/6 per outer pack



QLT BY MARSHALLTOWN

| EDI | Part# | Description | Blade Size-in. | Blade Size-mm |
|-------|---------|---------------|------------------------------------|---------------|
| 16905 | APH195 | Head w/o Hook | 19 ¹ / ₂ X 4 | 495 X 102 |
| 16906 | APH195H | Head w/ Hook | 19 ¹ / ₂ X 4 | 495 X 102 |

Aluminum Placer Heads

- Strong, lightweight tool spreads and grades concrete
- Two metal braces for greater strength
- **APH24H** and **APH30H** have hooks
- Use with 1³/₈" (35mm) push button poles (sold separately)
- Sold 1 per inner pack/6 per outer pack

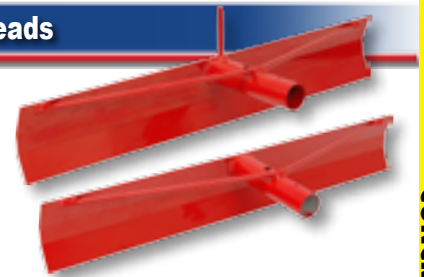

QLT BY MARSHALLTOWN

| EDI | Part# | Description | Blade Size-in. | Blade Size-mm |
|-------|--------|---------------|----------------|---------------|
| 13735 | APH24H | Head w/ Hook | 24 X 4 | 610 X 102 |
| 13737 | APH30 | Head w/o Hook | 30 X 4 | 762 X 102 |
| 13738 | APH30H | Head w/ Hook | 30 X 4 | 762 X 102 |

Shockwave™ Power Scream

- Excellent vibration dampening (little vibration passed on to operator)
- Fully adjustable handlebars and grips
- Power trowel style throttle lever - does not require constant contact
- Reliable 1.3hp GX35 Honda® 4-stroke engine
- Direct drive shaft for extended life
- On board tachometer/hour meter great for rental and scheduled maintenance
- Easy to adjust eccentric weights that are completely protected from concrete splatter
- Accessible handles for easy lifting and transport
- Unique frame provides superior engine protection
- Sold 1 per inner pack/1 per outer pack



Accessible handles for easy lifting



Adjustable handlebars and grips



SW100H
(Board sold separately)

Shockwave™ Screed Boards

- L-shaped board is ideal for wet screeding and works well for form-to-form screeding
- Curl edge keeps concrete rolling forward
- Constructed of aluminum alloy engineered to withstand prolonged vibration
- SWSBLADE16P2 has two sets of mounting holes and requires two power units
- **New items indicated in red in table**
- Boards 10' and longer ship LTL
- Sold 1 per inner pack/1 per outer pack

Vibration dampeners

Adjustable eccentric weights

Tachometer/hour meter



Assembly Video



In-use Video

**4.5' BLADE
PERFECT FOR
SCREEDING
SIDEWALKS!**

MADE IN
U.S.A

MARSHALLTOWN The Premier Line

| EDI | Part# | Description |
|-------|--------|-----------------------------------|
| 13261 | SW100H | Screed Power Unit - Honda® Engine |

MARSHALLTOWN The Premier Line

| EDI | Part# | Size-ft. | Size-M |
|-------|--------------------|----------|--------|
| 13336 | SWSBLADE4 | 4 | 1.2 |
| 19288 | SWSBLADE4.5 | 4.5 | 1.37 |
| 13281 | SWSBLADE6 | 6 | 1.8 |
| 13283 | SWSBLADE8 | 8 | 2.4 |
| 13284 | SWSBLADE10 | 10 | 3.0 |
| 13287 | SWSBLADE12 | 12 | 3.7 |
| 13290 | SWSBLADE14 | 14 | 4.3 |
| 13291 | SWSBLADE16 | 16 | 4.9 |
| 12950 | SWSBLADE16P2 | 16 | 4.9 |

Shockwave Replacement Parts

| EDI | Part# | Size-ft. |
|-------|-----------|--------------------------------|
| 13308 | 13308 | Handles with Grips |
| 13309 | 13309 | Grips |
| 13310 | ENG-HONDA | Honda Engine |
| 13312 | 13312 | Throttle Lever |
| 13313 | 13313 | Throttle Cable |
| 13314 | 13314 | Handle Bars |
| 13315 | 13315 | Handle Bar Clamp with Hardware |
| 13316 | 13316 | Handle Bar Clamp Hardware Only |
| 13317 | 13317 | On/Off Switch w/ Wires |
| 13318 | 13318 | On/Off Switch Wires |
| 13319 | 13319 | Tachometer |
| 13320 | 13320 | Eccentric Cover with Hardware |
| 13321 | 13321 | Kickstand |
| 13322 | 13322 | Kickstand Hardware |
| 13323 | 13323 | Drive Train |
| 13324 | 13324 | Clutch |
| 13325 | 13325 | Vibration Dampening Kit |
| 12951 | 12951 | Frame Only |
| 12952 | 12952 | Eccentric Cover Hardware Only |
| 13330 | 13330 | Eccentric Weight & Hardware |
| 13331 | 13331 | Eccentric Weight Hardware Only |
| 13332 | 13332 | Machine Base |
| 13333 | 13333 | Blade Locking Hardware |
| 13334 | 13334 | Drive Shaft |
| 13335 | 13335 | Drive Shaft Housing |

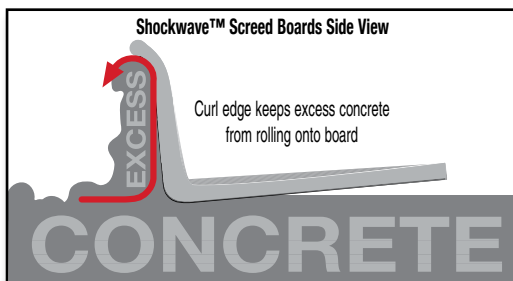

MARSHALLTOWN Truss Screed

- 10 gauge Heavy-Duty galvanized triangular shaped steel frame with vibration proof welds
- Bolt-On replaceable blades
- Eccentric Shaft Vibration System
- 9 HP or 11 HP Honda® engines available
- Capable of reaching greater floor flatness (Ff) and floor levelness (F) numbers than vibratory and hand screeds
- Maximum width of 65 feet
- Winch cables attach to form stakes near end of the pour
- Hydraulic winch available for effortless movement of the truss screed on forms
- Sold 1 per inner pack/1 per outer pack



Manual Winch Group Option (18379)
Requires end handle group (18378)



Power Winch Group Option
(Contains 2)



MARSHALLTOWN The Premier Line

| EDI | Part# | Description |
|-------|----------|-----------------------------------|
| 18371 | TS10S | Truss Screed, 10' Section, Steel |
| 18372 | TS75S | Truss Screed, 7.5' Section, Steel |
| 18373 | TS5S | Truss Screed, 5' Section, Steel |
| 18374 | TS25S | Truss Screed, 2.5' Section, Steel |
| 18375 | TS2S | Truss Screed, 2' Section, Steel |
| 18376 | TSLPEK9 | Low Profile Engine Kit, 9HP |
| 18377 | TSLPEK11 | Low Profile Engine Kit, 11HP |
| 18378 | TSEHG | End Handle Group (Contains 2) |
| 18379 | TSMWG | Manual Winch Group (Contains 2) |
| 18380 | TSPWG | Power Winch Group, HVY DUTY |

A complete screed must include:

- At least a 5' section of Truss Screed
- Choice of low profile engine kit
- Choice of winch group

End handle group:

- Comes standard with power winch group
- Must be purchased in addition to the manual winch group

Line Boss™

- LB14 accepts up to 14" (356mm) blade, up to 18" (457mm) blade for LB18
- Ergonomically designed adjustable handle bars and exclusive hip control bar
- Vibration reducing all steel box frame is precision welded to prevent twisting
- Perfect weight to maintain straight cuts
- Precision machined 1" (25mm) dual arbors allow left or right cutting
- Easy to remove blade guard is contoured to reduce slurry build up
- Max cutting depth of 4 5/8" (117mm) (LB14), 6 5/8" (168mm) (LB18)
- 11 hp Honda engine w/ Cyclone air filter (LB14)
- 13 hp Honda engine w/ Cyclone air filter (LB18)
- Water tanks available
- Sold 1 per inner pack/1 per outer pack



Water Inlet



Control Panel



Water Inlet



Control Panel



LB18



LB14

MADE IN
U.S.A

MARSHALLTOWN The Premier Line

| EDI | Part# | Description | Size-in. | Size-mm |
|-------|-------|--------------|----------|---------|
| 12638 | LB14 | Concrete Saw | 14 | 356 |
| 12639 | LB18 | Concrete Saw | 18 | 457 |

| EDI | Part# | Description | Size-Gal. | Size-L |
|-------|--------|---------------------|-----------|--------|
| 11820 | M23017 | Water Tank Kit LB18 | 5.0 | 19 |
| 11821 | M23043 | Water Tank Kit LB14 | 8.0 | 30 |
| 11822 | M23044 | Water Tank Kit LB18 | 8.0 | 30 |

Aluminum Alloy Screeds

- Premium high strength aluminum alloy won't rust or rot; more damage and warp resistant
- End capped to prevent concrete from getting inside
- Lightweight, long wearing and rigid
- H-style design for added strength
- Lengths available 6-24' (1.8- 7.3M)
- **WARNING:** When using screeds always avoid contact with electrical power lines or any electrical source
- Screeds 10' (3M) or longer ship LTL
- Sold 1 per inner pack/1 per outer pack, 2 per inner pack/2 per outer pack where noted with *
- Available in inner pack quantities only



MADE IN
U.S.A

MARSHALLTOWN The Premier Line

| EDI | Part# | Size-standard | Size-metric |
|-------|--------|-----------------|---------------------|
| 14778 | 14778* | 6' X 1" X 4" | 1.8M X 25mm X 102mm |
| 14779 | 14779* | 8' X 1" X 4" | 2.4M X 25mm X 102mm |
| 14780 | 14780* | 10' X 1" X 4" | 3M X 25mm X 102mm |
| 14781 | 14781* | 12' X 1" X 4" | 3.7M X 25mm X 102mm |
| 14782 | 14782* | 14' X 1" X 4" | 4.3M X 25mm X 102mm |
| 14783 | 14783* | 16' X 1" X 4" | 4.9M X 25mm X 102mm |
| 14833 | 14833 | 6' X 1½" X 3½" | 1.8M X 38mm X 89mm |
| 14770 | 14770 | 8' X 1½" X 3½" | 2.4M X 38mm X 89mm |
| 14771 | 14771 | 10' X 1½" X 3½" | 3M X 38mm X 89mm |
| 14772 | 14772 | 12' X 1½" X 3½" | 3.7M X 38mm X 89mm |
| 14773 | 14773 | 14' X 1½" X 3½" | 4.3M X 38mm X 89mm |
| 14775 | 14775 | 16' X 1½" X 3½" | 4.9M X 38mm X 89mm |
| 14776 | 14776 | 20' X 1½" X 3½" | 6.1M X 38mm X 89mm |
| 14777 | 14777 | 24' X 1½" X 3½" | 7.3M X 38mm X 89mm |
| 14784 | 14784 | 6' X 2" X 4" | 1.8M X 51mm X 102mm |
| 14785 | 14785 | 8' X 2" X 4" | 2.4M X 51mm X 102mm |
| 14786 | 14786 | 10' X 2" X 4" | 3M X 51mm X 102mm |
| 14788 | 14788 | 12' X 2" X 4" | 3.7M X 51mm X 102mm |
| 14789 | 14789 | 14' X 2" X 4" | 4.3M X 51mm X 102mm |
| 14790 | 14790 | 16' X 2" X 4" | 4.9M X 51mm X 102mm |
| 14791 | 14791 | 20' X 2" X 4" | 6.1M X 51mm X 102mm |
| 14792 | 14792 | 24' X 2" X 4" | 7.3M X 51mm X 102mm |
| 14793 | 14793 | 16' X 2" X 5" | 4.9M X 51mm X 127mm |
| 14794 | 14794 | 20' X 2" X 5" | 6.1M X 51mm X 127mm |
| 14795 | 14795 | 24' X 2" X 5" | 7.3M X 51mm X 127mm |

Magnesium Alloy Screeds

- Made from magnesium alloy, won't rust or rot
- End capped to prevent concrete from getting inside
- Lightweight, long wearing and rigid
- **WARNING:** When using screeds always avoid contact with electrical power lines or any electrical source
- Screeds 10' (3M) or longer ship LTL
- Sold 1 per inner pack/1 per outer pack, 2 per inner pack/2 per outer pack where noted with *
- Available in inner pack quantities only

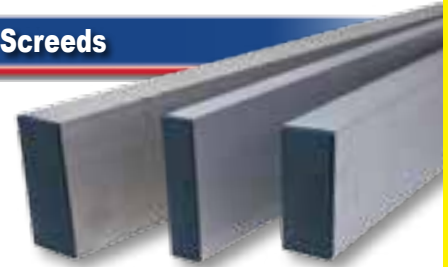

MADE IN
U.S.A

MARSHALLTOWN The Premier Line

| EDI | Part# | Size-standard | Size-metric |
|-------|-------|-----------------|---------------------|
| 14746 | 4746* | 6' X 1" X 4" | 1.8M X 25mm X 102mm |
| 14748 | 4748* | 8' X 1" X 4" | 2.4M X 25mm X 102mm |
| 14750 | 4750* | 10' X 1" X 4" | 3M X 25mm X 102mm |
| 10584 | 10584 | 8' X 1½" X 3½" | 3M X 38mm X 89mm |
| 10585 | 10585 | 10' X 1½" X 3½" | 2.4M X 38mm X 89mm |
| 14733 | 4733 | 12' X 1½" X 3½" | 3.7M X 38mm X 89mm |
| 14734 | 4734 | 14' X 1½" X 3½" | 4.3M X 38mm X 89mm |
| 14735 | 4735 | 16' X 1½" X 3½" | 4.9M X 38mm X 89mm |
| 10586 | 10586 | 20' X 1½" X 3½" | 6.1M X 38mm X 89mm |
| 10587 | 10587 | 24' X 1½" X 3½" | 7.3M X 38mm X 89mm |
| 10588 | 10588 | 6' X 2" X 4" | 1.8M X 51mm X 102mm |
| 14752 | 4752 | 8' X 2" X 4" | 2.4M X 51mm X 102mm |
| 14754 | 4754 | 10' X 2" X 4" | 3M X 51mm X 102mm |
| 14723 | 822 | 12' X 2" X 4" | 3.7M X 51mm X 102mm |
| 14724 | 824 | 14' X 2" X 4" | 4.3M X 51mm X 102mm |
| 14725 | 825 | 16' X 2" X 4" | 4.9M X 51mm X 102mm |
| 10589 | 10589 | 18' X 2" X 4" | 5.5M X 51mm X 102mm |
| 10590 | 10590 | 20' X 2" X 4" | 6.1M X 51mm X 102mm |
| 10591 | 10591 | 24' X 2" X 4" | 7.3M X 51mm X 102mm |
| 10593 | 10593 | 8' X 2" X 5" | 2.4M X 51mm X 127mm |
| 10594 | 10594 | 10' X 2" X 5" | 3M X 51mm X 127mm |
| 10595 | 10595 | 12' X 2" X 5" | 3.7M X 51mm X 127mm |
| 10596 | 10596 | 16' X 2" X 5" | 4.9M X 51mm X 127mm |
| 10597 | 10597 | 20' X 2" X 5" | 6.1M X 51mm X 127mm |
| 10598 | 10598 | 24' X 2" X 5" | 7.3M X 51mm X 127mm |

CONCRETE TOOLS

Screed Handles

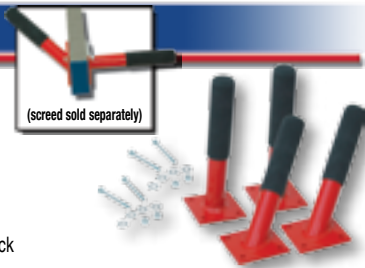

- Attach to each end of screed board for sawing applications
- Comfortable soft grip handles
- Sold as a set of 4 handles, with mounting hardware and template
- Sold 1 set per inner pack/1 set per outer pack

OLT BY MARSHALLTOWN

| EDI | Part# | Size-in. | Size-mm |
|-------|-------|----------|---------|
| 10665 | 10665 | N/A | N/A |

Combo Screed



- Lightweight aluminum construction
- Can be used as a screed, float or check rod
- Dual-edge design, sharp edge for cutting and round edge for floating concrete
- Attach handle to the bottom side of screed for double the life
- Handle adjusts to desired position for better comfort
- 13745 & 13746 ship LTL
- Sold 1 per inner pack/1 per outer pack



MADE IN U.S.A.

MARSHALLTOWN The Premier Line

| EDI | Part# | Size-in. | Size-metric |
|-------|-------|------------------|--------------------|
| 13741 | 13741 | 48 X 2 X 1 1/2" | 1.2M X 51mm X 41mm |
| 13743 | 13743 | 72 X 2 X 1 1/2" | 1.8M X 51mm X 41mm |
| 13744 | 13744 | 96 X 2 X 1 1/2" | 2.4M X 51mm X 41mm |
| 13745 | 13745 | 120 X 2 X 1 1/2" | 3.0M X 51mm X 41mm |
| 13746 | 13746 | 144 X 2 X 1 1/2" | 3.7M X 51mm X 41mm |

Screed Shaker™



- Attaches to wooden 2 X 6" board up to 16' (4.9M) long and metal screed boards up to 20' (6.1M)
- Adjusts to any screed board 2" (51mm) thick or less
- Levels concrete quickly and easily
- Allows a stiffer mix of concrete to be poured, resulting in a stronger slab
- Brings more cream to the surface making finishing easier
- Sold 1 set per inner pack/1 set per outer pack

MADE IN U.S.A.

MARSHALLTOWN The Premier Line

| EDI | Part# | Size-in. | Size-mm |
|-------|-------|----------|---------|
| 10459 | SV459 | N/A | N/A |

Flat Wire Brooms



- Machined aluminum tubing will not warp or crack
- Steel tines provide stiffness for grooving while flexing for durability
- Intended for providing a uniform groove in concrete roadways, bridges and ramps for drainage and traction
- Comes with threaded handle adapter installed; adapter can be removed for use with clevis end handle
- Tines are 5" (127mm) long and 1/8" (3mm) wide
- Replacement tines come 10 per bag
- Other spacings available by special order including random spacing to meet many state highway specifications; please call customer service for special order requirements
- **New items indicated in red in table**
- Sold 1 per inner pack/1 per outer pack

MADE IN U.S.A.

MARSHALLTOWN The Premier Line

| EDI | Part# | Spacing | Size-in. | Size-mm |
|-------|-------|-------------|----------|---------|
| 14850 | 14850 | 1/2" (13mm) | 24 | 610 |
| 14851 | 14851 | 5/8" (16mm) | 24 | 610 |
| 14852 | 14852 | 3/4" (19mm) | 24 | 610 |
| 14853 | 14853 | 7/8" (22mm) | 24 | 610 |
| 14854 | 14854 | 1" (25mm) | 24 | 610 |
| 14855 | 14855 | 1/2" (13mm) | 36 | 914 |
| 14856 | 14856 | 5/8" (16mm) | 36 | 914 |
| 14857 | 14857 | 3/4" (19mm) | 36 | 914 |
| 14858 | 14858 | 7/8" (22mm) | 36 | 914 |
| 14859 | 14859 | 1" (25mm) | 36 | 914 |
| 14860 | 14860 | 1/2" (13mm) | 48 | 1219 |
| 14861 | 14861 | 5/8" (16mm) | 48 | 1219 |
| 14862 | 14862 | 3/4" (19mm) | 48 | 1219 |
| 14863 | 14863 | 7/8" (22mm) | 48 | 1219 |
| 14864 | 14864 | 1" (25mm) | 48 | 1219 |
| 14865 | 14865 | 1/2" (13mm) | 60 | 1524 |
| 14866 | 14866 | 5/8" (16mm) | 60 | 1524 |
| 14867 | 14867 | 3/4" (19mm) | 60 | 1524 |
| 14868 | 14868 | 7/8" (22mm) | 60 | 1524 |
| 14869 | 14869 | 1" (25mm) | 60 | 1524 |
| 14870 | 14870 | Repl. Tines | N/A | N/A |

State Specific Spacing (all repeat)

| EDI | Part# | Spacing | Size-in. |
|-------|-----------|--|----------|
| 18730 | 18730 | Louisiana - 3/8", 5/8", 1/2", 3/4", 1 1/4" | 24 |
| 18731 | 18731 | Louisiana - 3/8", 5/8", 1/2", 3/4", 1 1/4" | 36 |
| 18732 | 18732 | Louisiana - 3/8", 5/8", 1/2", 3/4", 1 1/4" | 48 |
| 18733 | 18733 | Louisiana - 3/8", 5/8", 1/2", 3/4", 1 1/4" | 60 |
| 25931 | RED700448 | Indiana - 7/8", 3/4", 3/4", 1", 3/4", 3/4", 1 1/8" | 48 |
| 25982 | RED701437 | Indiana - 7/8", 1/2", 1", 5/8", 3/4", 1 1/8", 1/2", 5/8" | 48 |
| 26031 | RED750114 | South Dakota* | 36 |

*3/4", 1 3/8", 3/4", 3/4", 7/8", 5/8", 1 1/8", 1 5/8", 3/4", 1 3/8", 1 1/2", 7/8", 5/8", 1 1/4", 7/8", 1 1/8", 7/8", 1 1/4", 1 1/2", 1 5/8", 5/8", 1", 1 1/2", 1 1/8", 3/4", 1 1/2", 5/8", 3/4", 1 5/8", 3/4", 7/8", 1 3/8", 1", 5/8"

Broom-Float Adapter Bracket & Brooms

- Allows floating and brooming in one pass
- Eliminates reaching and lifting
- Brooms available from 36 to 72" (914 to 1829mm)
- Bracket can be used with flat wire brooms
- Bracket includes attachments for bull floats, blue gliders, and multi-mount fresnos
- For the best finish, broom or flat wire texture broom should extend beyond float on both sides
- Brooms can be used separately by using 6516 adapter (sold separately) see page 98
- Bracket sold 1 per inner pack/1 per outer pack, brooms sold 1 per inner pack/6 per outer pack

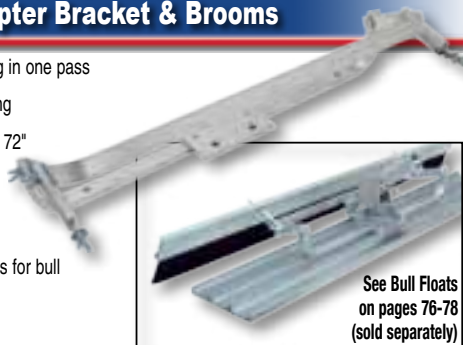

See Bull Floats on pages 76-78 (sold separately)



MARSHALLTOWN The Premier Line

| EDI | Part# | Description | Size-in. | Size-mm |
|-------|--------|-------------|----------|---------|
| 14013 | AB4013 | Bracket | N/A | 610 |
| 14014 | BFB36 | Broom | 36 | 914 |
| 14015 | BFB40 | Broom | 40 | 1016 |
| 14016 | BFB48 | Broom | 48 | 1219 |
| 14017 | BFB54 | Broom | 54 | 1372 |
| 14018 | BFB60 | Broom | 60 | 1524 |
| 14019 | BFB72 | Broom | 72 | 1829 |

Aluminum Backed Concrete Brooms

- 3" (76mm) poly or horsehair fibers set in a lightweight aluminum back
- Used to brush concrete after floating
- Clevis handle mounting bracket included
- Sold 1 per inner pack/6 per outer pack



MARSHALLTOWN The Premier Line

| EDI | Part# | Description | Size-in. | Size-mm |
|-------|-------|---------------|----------|---------|
| 16423 | 423 | Polypropylene | 24 | 610 |
| 16343 | 427 | Polypropylene | 36 | 914 |
| 16428 | 428 | Polypropylene | 48 | 1219 |
| 15173 | 429 | Polypropylene | 60 | 1524 |
| 15174 | 430 | Polypropylene | 72 | 1829 |

Horsehair Concrete Brooms

| EDI | Part# | Description | Size-in. | Size-mm |
|-------|-------|-----------------|----------|---------|
| 15175 | 423HH | Horsehair Blend | 24 | 610 |
| 15176 | 427HH | Horsehair Blend | 36 | 914 |
| 15177 | 428HH | Horsehair Blend | 48 | 1219 |
| 15178 | 429HH | Horsehair Blend | 60 | 1524 |
| 15179 | 430HH | Horsehair Blend | 72 | 1829 |

Extra Soft White Poly Fiber Concrete Brooms

| EDI | Part# | Description | Size-in. | Size-mm |
|-------|-----------|---------------------|----------|---------|
| 20411 | RED700513 | Polypropylene-White | 24 | 610 |
| 20412 | RED700514 | Polypropylene-White | 30 | 762 |
| 20413 | RED700515 | Polypropylene-White | 36 | 914 |
| 20414 | RED700516 | Polypropylene-White | 48 | 1219 |

Wood Backed Concrete Brooms

- Long wearing 3" (76mm) black polypropylene bristles set solidly into a natural lacquered hardwood block
- Threaded hole accepts any standard broom handle
- Ideal for applying non-slip finish to newly finished concrete surfaces
- Sold 1 per inner pack/6 per outer pack



MARSHALLTOWN The Premier Line

| EDI | Part# | Size-in. | Size-mm |
|-------|-------|----------|---------|
| 16600 | 799 | 18 | 457 |
| 16420 | 830 | 24 | 610 |
| 16424 | 847 | 36 | 914 |
| 16425 | 848 | 48 | 1219 |

Horsehair Brooms

- Long wearing 2 1/2" (64mm) 100% horsehair bristles set solidly into a natural lacquered hardwood block
- Threaded hole accepts any standard broom handle
- Ideal for applying non-slip finish to newly finished concrete surfaces
- Sold 1 per inner pack/6 per outer pack



6596



MARSHALLTOWN The Premier Line

| EDI | Part# | Size-in. | Size-mm |
|-------|-------|----------|---------|
| 16596 | 6596 | 18 | 457 |
| 16597 | 6597 | 24 | 610 |
| 16598 | 6598 | 36 | 914 |
| 16599 | 6599 | 48 | 1219 |

Broom Adapters

- 6515 has an all-angle center mount
- Cut out section of adapter fits over broom bracket and accepts broom thread handle
- 6516 mounts to most broom heads and accepts the 6515 allowing broom heads to be used with different handles
- RED704433 & RED704827 connect threaded handle sections to different broom adaptors or brooms
- Sold 6 per inner pack/36 per outer pack



6516

6515

RED704433

RED704827

MARSHALLTOWN The Premier Line

| EDI | Part# | Description |
|-------|-----------|---|
| 16515 | 6515 | Threaded Handle Clevis Adapter |
| 16516 | 6516 | Clevis Adapter Base Bracket |
| 20068 | RED704433 | Poly Threaded Adapter |
| 20079 | RED704827 | Cast Aluminum Threaded Adapter w/Wrench Flats |

Handle Brushes

- Offset hand grip gives a variety of gripping locations
- 3" (76mm) long bristles
- Excellent brush for texturing concrete in curbs, gutters, and other tight places
- Sold 1 per inner pack/6 per outer pack



MADE IN
U.S.A

MARSHALLTOWN The Premier Line

| EDI | Part# | Description | Size-in. | Size-mm |
|-------|---------|----------------------|----------|---------|
| 16984 | BP984M | Medium-Black Poly | 12 | 305 |
| 16985 | YP985M | Medium-Yellow Poly | 12 | 305 |
| 16986 | HHP986F | Fine-Horsehair/Poly | 12 | 305 |
| 16987 | HH987F | Extra Fine-Horsehair | 12 | 305 |

Curb Brush

- Long wearing 3 1/8" (79mm) soft black polypropylene bristles set solidly into a natural lacquered hardwood block
- Ideal for applying a light texture to newly finished concrete surfaces
- Sold 12 per inner pack/12 per outer pack



MADE IN
U.S.A

MARSHALLTOWN The Premier Line

| EDI | Part# | Bristles | Size-in. | Size-mm |
|-------|-------|---------------|----------|---------|
| 15871 | 5871 | Polypropylene | 12 | 305 |
| 16443 | 6443 | Horsehair | 12 | 305 |

Wide Block Horse Hair Brooms

- Threaded hole accepts any standard broom handle
- Ideal for applying non-slip finish to newly finished concrete surfaces
- Long wearing 2 1/2" (64mm) 100% horsehair bristles set solidly into a natural lacquered hardwood block
- 6982 and 6442 sold 1 per inner pack/12 per outer pack, 6983 sold 1 per inner pack/6 per inner pack



MADE IN
U.S.A

MARSHALLTOWN The Premier Line

| EDI | Part# | Size-in. | Size-mm |
|-------|-------|----------|---------|
| 16982 | 6982 | 12 | 305 |
| 16442 | 6442 | 24 | 610 |
| 16983 | 6983 | 36 | 914 |

Concrete Poly Brooms

- The 24" (610mm), 36" (914mm) and 48" (1219mm) medium-general purpose brooms have a solid row of 3" (76mm) black poly fiber bristles
- The 36" medium coarse broom has a solid row of 4 3/4" (121mm) white poly fiber bristles
- The 36" extra coarse broom has a solid row of 4 3/4" (121mm) black poly fiber bristles
- All bristles are mounted in solid hardwood lacquered blocks
- Used for brushing down new concrete after floating
- Sold 1 per inner pack/6 per outer pack



855



Clevis adapter included

MADE IN
U.S.A

MARSHALLTOWN The Premier Line

| EDI | Part# | Description | Size-in. | Size-mm |
|-------|-------|---------------|----------|---------|
| 16601 | 842 | Medium | 24 | 610 |
| 16623 | 843 | Medium | 36 | 914 |
| 16624 | 854 | Medium | 48 | 1219 |
| 16626 | 855 | Medium Coarse | 36 | 914 |
| 16627 | 856 | Extra Coarse | 36 | 914 |

Large Concrete Brooms

- Has three rows of 3" (76mm) long soft plastic bristles
- Equipped with strong, adjustable handle socket, bull float tip and standard handle tip
- Fits any 1 5/16" (24mm) diameter standard threaded handle
- Used for large concrete areas where grain finish needs to extend for long distances
- Sold 2 per inner pack/6 per outer pack



MADE IN
U.S.A

MARSHALLTOWN The Premier Line

| EDI | Part# | Size-in. | Size-mm |
|-------|-------|----------|---------|
| 16629 | 6629 | 24 | 609 |
| 16630 | 6630 | 30 | 762 |
| 16631 | 6631 | 36 | 914 |

Floor Brooms

- 3" (76mm) long select black Tampico fiber bristles set in clear lacquered half-round hardwood block
- Includes a 60 X 1⁵/₁₆" (1524 X 24mm) threaded handle
- Used for sweeping semi-smooth dry floors
- Can also be used as a concrete finishing brush that will give a sand finish
- **6423 & 6425** come with a metal brace (pictured above)
- Sold 1 per inner pack/1 per outer pack, 12 per outer pack where noted with *



MARSHALLTOWN The Premier Line

| EDI | Part# | Size-in. | Size-mm |
|-------|-------|----------|---------|
| 16512 | 6415 | 18 | 457 |
| 16417 | 6417* | 24 | 610 |
| 16513 | 6423 | 30 | 762 |
| 16514 | 6425 | 36 | 914 |

Smooth Surface Floor Broom

- 3" (76mm) long silver flag-tipped plastic bristles set in clear lacquered half-round hardwood block
- Includes a 60 X 1⁵/₁₆" (1524 X 24mm) threaded handle
- Used for sweeping smooth, highly polished floors
- Will sweep the finest dust or grit
- Not for use with oil based sweeping compound
- Sold 1 per inner pack/12 per outer pack



MARSHALLTOWN The Premier Line

| EDI | Part# | Size-in. | Size-mm |
|-------|-------|----------|---------|
| 16416 | 6416 | 24 | 610 |

Rough Surface Floor Broom

- 3" (76mm) long coarse brown styrene bristles mounted in clear lacquered hardwood block
- Includes a 60 X 1¹/₈" (1524 X 28mm) threaded handle
- Ideal for sweeping wet or dry accumulations of sand, dirt, etc. from rough concrete or asphalt surfaces
- Will not soften when exposed to water, oils or grease
- Sold 1 per inner pack/12 per outer pack



MARSHALLTOWN The Premier Line

| EDI | Part# | Size-in. | Size-mm |
|-------|-------|----------|---------|
| 16419 | 6419 | 24 | 610 |

Finish Strip Concrete Brooms

- Ideal for applying a light texture to newly finished concrete surfaces
- Sold 1 per inner pack/1 per outer pack

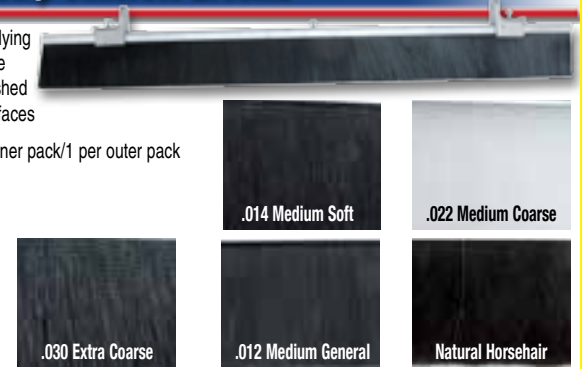

.014 Medium Soft Bristle Black

| EDI | Part# | Bristles | Size-in. | Size-mm |
|-------|-----------|------------------------|----------|------------|
| 20501 | RED704875 | .014 Medium Soft | 36 X 5 | 914 X 127 |
| 20502 | RED704876 | .014 Medium Soft | 48 X 5 | 1219 X 127 |
| 20519 | RED705102 | .014 Medium Soft | 60 X 5 | 1524 X 127 |
| 20527 | RED790175 | .014 Medium Soft Repl. | 36 X 5 | 914 X 127 |
| 20528 | RED790324 | .014 Medium Soft Repl. | 48 X 5 | 1219 X 127 |
| 20520 | RED705109 | .014 Medium Soft Repl. | 60 X 5 | 1524 X 127 |

.022 Medium Coarse White

| EDI | Part# | Bristles | Size-in. | Size-mm |
|-------|-----------|--------------------------|----------|------------|
| 20499 | RED704873 | .022 Medium Coarse | 36 X 5 | 914 X 127 |
| 20500 | RED704874 | .022 Medium Coarse | 48 X 5 | 1219 X 127 |
| 20518 | RED705101 | .022 Medium Coarse | 60 X 5 | 1524 X 127 |
| 20521 | RED705110 | .022 Medium Coarse Repl. | 36 X 5 | 914 X 127 |
| 20489 | RED704531 | .022 Medium Coarse Repl. | 48 X 5 | 1219 X 127 |
| 20483 | RED704262 | .022 Medium Coarse Repl. | 60 X 5 | 1524 X 127 |

.030 Extra Coarse Black

| EDI | Part# | Bristles | Size-in. | Size-mm |
|-------|-----------|-------------------------|----------|------------|
| 20516 | RED705003 | .030 Extra Coarse | 36 X 5 | 914 X 127 |
| 20515 | RED705002 | .030 Extra Coarse | 48 X 5 | 1219 X 127 |
| 20517 | RED705042 | .030 Extra Coarse | 60 X 5 | 1524 X 127 |
| 20530 | RED790326 | .030 Extra Coarse Repl. | 36 X 5 | 914 X 127 |
| 20529 | RED790325 | .030 Extra Coarse Repl. | 48 X 5 | 1219 X 127 |
| 20522 | RED705111 | .030 Extra Coarse Repl. | 60 X 5 | 1524 X 127 |

.012 Medium Black Poly General

| EDI | Part# | Bristles | Size-in. | Size-mm |
|-------|-----------|-------------------|------------------------------------|-----------|
| 20419 | RED700778 | .012 Medium | 24 X 3 ¹ / ₄ | 610 X 82 |
| 20420 | RED700779 | .012 Medium | 36 X 3 ¹ / ₄ | 914 X 82 |
| 20421 | RED700780 | .012 Medium | 48 X 3 ¹ / ₄ | 1219 X 82 |
| 20422 | RED700781 | .012 Medium Repl. | 24 X 3 ¹ / ₄ | 610 X 82 |
| 20423 | RED700782 | .012 Medium Repl. | 36 X 3 ¹ / ₄ | 914 X 82 |
| 20424 | RED700783 | .012 Medium Repl. | 48 X 3 ¹ / ₄ | 1219 X 82 |

Soft Natural Horsehair Fiber

| EDI | Part# | Bristles | Size-in. | Size-mm |
|-------|-----------|-------------------------|------------------------------------|-----------|
| 20425 | RED700784 | Natural Horsehair | 24 X 2 ¹ / ₂ | 610 X 64 |
| 20427 | RED700786 | Natural Horsehair | 48 X 2 ¹ / ₂ | 1219 X 64 |
| 20428 | RED700787 | Natural Horsehair Repl. | 24 X 2 ¹ / ₂ | 610 X 64 |
| 20429 | RED700788 | Natural Horsehair Repl. | 36 X 2 ¹ / ₂ | 914 X 64 |

Utility Broom

- Made of select broom corn and fiber on a heavy duty wood handle
- Sewn four times and reinforced with wire band
- Designed for sweeping smooth and rough surfaces with moderate to heavy debris
- Ideal for construction site cleanup
- Sold 1 per inner pack/1 per outer pack



MADE IN
U.S.A

MARSHALLTOWN The Premier Line

| EDI | Part# | Size-in. | Size-mm |
|-------|-------|----------|------------|
| 10372 | UB371 | 57 X 12 | 1448 X 305 |

Dust Pans

- Black baked enamel finish is durable with beveled edge
- Corrugated ribs add to strength
- Made of heavy 20-gauge steel
- Sold 1 per inner pack/12 per outer pack

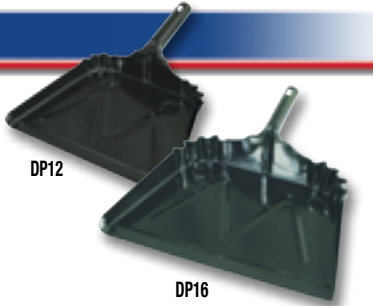

MARSHALLTOWN The Premier Line

| EDI | Part# | Size-in. | Size-mm |
|-------|-------|----------|---------|
| 10373 | DP12 | 12 | 305 |
| 10374 | DP16 | 16 | 406 |

Double Blade Floor Squeegee

- Moss foam rubber squeegees - soft, double foam rubber blade is designed for use on uneven, grouted and smooth surface floors
- Reinforced aluminum frame ensures long life
- Use with our 13718 wood handle (sold separately)
- Sold 10 per inner pack/10 per outer pack



QLT BY MARSHALLTOWN

| EDI | Part# | Description | Size-in. | Size-mm |
|-------|-------|------------------------------|---------------------------------|---------|
| 13717 | 13717 | Double Blade Rubber Squeegee | 30 | 762 |
| 13718 | 13718 | Wood Handle | 60 ³ / ₁₆ | 1548 |

Notched Squeegees

- Used to meter materials for epoxy floors
- Consistently accurate notches for better material management
- Use with our 14844 wood handle (sold separately) see page 28
- All notches are V-shaped
- Sold 1 per inner pack/6 per outer pack, Replacement blades sold 1 per inner pack/ 12 per outer pack

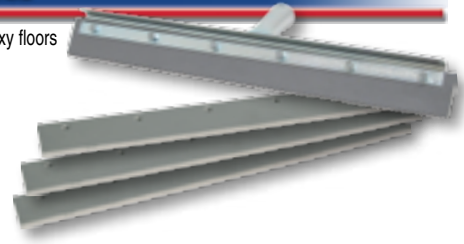

QLT BY MARSHALLTOWN

| EDI | Part# | Blade Size | Notch Size |
|-------|-------|-------------|---------------|
| 16838 | 16838 | 18" (457mm) | 1/8" (3mm) |
| 16839 | 16839 | 18" (457mm) | 3/16" (4.5mm) |
| 16840 | 16840 | 18" (457mm) | 1/4" (6mm) |
| 16841 | 16841 | 24" (610mm) | 1/8" (3mm) |
| 16842 | 16842 | 24" (610mm) | 3/16" (4.5mm) |
| 16843 | 16843 | 24" (610mm) | 1/4" (6mm) |
| 16844 | 16844 | 30" (762mm) | 1/8" (3mm) |
| 16845 | 16845 | 30" (762mm) | 3/16" (4.5mm) |
| 16846 | 16846 | 30" (762mm) | 1/4" (6mm) |
| 16847 | 16847 | 36" (914mm) | 1/8" (3mm) |
| 16848 | 16848 | 36" (914mm) | 3/16" (4.5mm) |
| 16849 | 16849 | 36" (914mm) | 1/4" (6mm) |

Notched Replacement Blades

| EDI | Part# | Blade Size | Notch Size |
|-------|---------|-------------|---------------|
| 16850 | 16838RB | 18" (457mm) | 1/8" (3mm) |
| 16851 | 16839RB | 18" (457mm) | 3/16" (4.5mm) |
| 16852 | 16840RB | 18" (457mm) | 1/4" (6mm) |
| 16853 | 16841RB | 24" (610mm) | 1/8" (3mm) |
| 16854 | 16842RB | 24" (610mm) | 3/16" (4.5mm) |
| 16855 | 16843RB | 24" (610mm) | 1/4" (6mm) |
| 16856 | 16844RB | 30" (762mm) | 1/8" (3mm) |
| 16857 | 16845RB | 30" (762mm) | 3/16" (4.5mm) |
| 16858 | 16846RB | 30" (762mm) | 1/4" (6mm) |
| 16859 | 16847RB | 36" (914mm) | 1/8" (3mm) |
| 16860 | 16848RB | 36" (914mm) | 3/16" (4.5mm) |
| 16861 | 16849RB | 36" (914mm) | 1/4" (6mm) |

Single Blade Floor Squeegees

- Curved end floor squeegees feature a single-blade design; curved end controls liquid better
- Straight floor squeegees feature a black rubber blade with metal frame for daily liquid clean up
- For more details and size options **see page 144-145**



Kneeler Board

- Extra large handle grips
- Offers extra-comfortable support for knees
- Black foam pad securely fastened to generously sized polypropylene tray
- Size of padded area*
- Sold 12 per inner pack/12 per outer pack



QLT BY MARSHALLTOWN

| EDI | Part# | Size-in. | Size-mm |
|-------|-------|-----------|------------|
| 16451 | KB451 | 19 X 13½* | 483 X 343* |

Stainless Steel Knee Boards w/Knee Pads

- Made of 18 gauge stainless steel
- Built in toe brackets for easy back and forth motion
- Durable and easy to use
- Replaceable knee pads come with straps and buckle; 1 pair per bag
- Knee boards sold 1 per inner pack/1 per outer pack, replaceable knee pads sold 1 per inner pack/20 per outer pack



QLT BY MARSHALLTOWN

| EDI | Part# | Description | Size-in. | Size-mm |
|-------|--------|-----------------|----------|-----------|
| 16230 | KB230 | Knee Boards | 28 X 8 | 711 X 203 |
| 16232 | RKP230 | Repl. Knee Pads | N/A | N/A |

Stainless Steel Knee Boards

- Made of 16 gauge stainless steel
- Easy to clean and durable
- Rounded corners and edges to eliminate gouging and cut down on finishing time
- Built-in toe brackets for easy forward and backward movement
- Sold 1 pair per inner pack/2 pair per outer pack



QLT BY MARSHALLTOWN

| EDI | Part# | Size-in. | Size-mm |
|-------|-------|----------|-----------|
| 16459 | KB459 | 27½ X 7¾ | 699 X 197 |

Plastic Knee Boards

- Made of plastic
- Easy to clean, lightweight and durable
- Includes two metal foot brackets and rubber knee pads
- Sold 1 pair per inner pack/1 pair per outer pack



QLT BY MARSHALLTOWN

| EDI | Part# | Size-in. | Size-mm |
|-------|-------|----------|-----------|
| 16455 | KB455 | 29½ X 10 | 737 X 254 |

Concrete Tampers

- Reinforced splash-way grill
- Built to take the pounding and stay flat
- Properly balanced handle with rubber grips to ensure easy, safe handling
- Sold 1 per inner pack/1 per outer pack

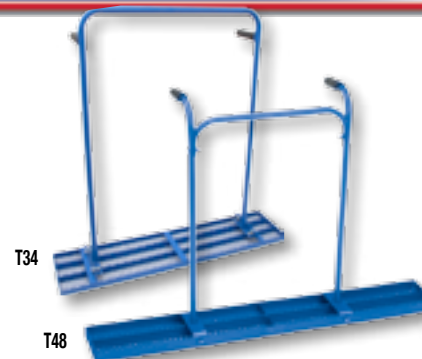

MARSHALLTOWN The Premier Line

| EDI | Part# | Description | Size-in. | Size-mm |
|-------|-------|-------------|----------|------------|
| 16422 | T34 | Big Diamond | 34 X 7½ | 864 X 191 |
| 14722 | T48 | Round Hole | 48 X 6½ | 1219 X 165 |

Roller Tampers

- Ideal tool for embedding exposed aggregate
- Quickly levels slab and prepares it for final finish
- Fully assembled
- Dual adapter (included) allows use with any of our push button or female threaded end handles (sold separately)
- T455 is a single roller and has a 10 degree offset handle for extra clearance against walls
- Sold 1 per inner pack/1 per outer pack

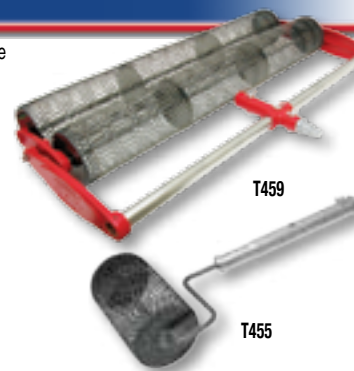

QLT BY MARSHALLTOWN

| EDI | Part# | Size-in. | Size-mm |
|-------|-------|----------|---------|
| 14455 | T455 | 8 | 203 |
| 14456 | T456 | 18 | 457 |
| 14457 | T457 | 24 | 610 |
| 14458 | T458 | 30 | 762 |
| 14459 | T459 | 36 | 914 |
| 14460 | T460 | 48 | 1219 |

Tamper

- Cast iron base
- 42" (1067mm) ash handle
- Used to flatten and smooth dirt, stone, asphalt and other materials
- Ideal for decorative concrete applications
- Sold 1 per inner pack/1 per outer pack



MADE IN
U.S.A

MARSHALLTOWN The Premier Line

| EDI | Part# | Size-in. | Size-mm |
|-------|-------|----------|-----------|
| 14732 | 14732 | 8 X 8 | 203 X 203 |

Tamper

- Cast iron base
- 48" (1219mm) steel handle
- 10" (254mm) rubber grip
- Used to flatten and smooth dirt, stone, asphalt and other materials
- Ideal for decorative concrete applications
- Sold 1 per inner pack/2 per outer pack



QLT BY MARSHALLTOWN

| EDI | Part# | Size-in. | Size-mm |
|-------|-------|----------|-----------|
| 10342 | HT8 | 8 X 8 | 203 X 203 |
| 10343 | HT10 | 10 X 10 | 254 X 254 |

Urethane Coated Tamper

- For information **see page 139**



NEW!

Rebar Lifter

- Use to position rebar or mesh while pouring concrete
- 32" (813mm) reach minimizes bending over
- Comfortable rubber dipped handle
- Sold 1 per inner pack/2 per outer pack

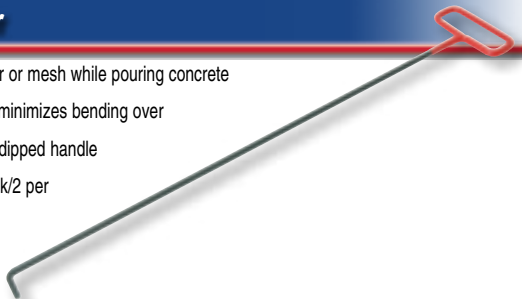

QLT BY MARSHALLTOWN

| EDI | Part# | Size-in. | Size-mm |
|-------|-------|----------|---------|
| 15349 | 15349 | 32 | 813 |

Monster Pry Bar

- All steel construction ensures long life
- Powder coated finish
- 56" (1422mm) length gives enough leverage for even the toughest jobs
- Ideal for prying forms and other embedded objects
- 1 per inner/1 per outer pack



MADE IN
U.S.A

MARSHALLTOWN The Premier Line

| EDI | Part# | Size-in. | Size-mm |
|-------|-------|----------|---------|
| 16595 | 16595 | 56 | 1422 |

Open Angle Monster Pry Bar

- All steel construction ensures long life
- Features a sharper pry bend to give end-user more leverage
- Powder coated finish
- 56" (1422mm) length gives enough leverage for even the toughest jobs
- Ideal for prying forms and other embedded objects
- 1 per inner/1 per outer pack

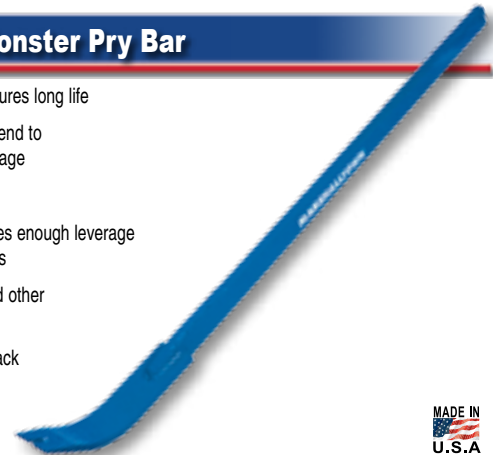

MADE IN
U.S.A

MARSHALLTOWN The Premier Line

| EDI | Part# | Size-in. | Size-mm |
|-------|-------|----------|---------|
| 10453 | 10453 | 56 | 1422 |

Little Monster Pry Bar

- All steel construction ensures long life
- Powder coated finish
- 46" length
- Ideal for prying forms and other embedded objects
- Sold 1 per inner pack/1 per outer pack

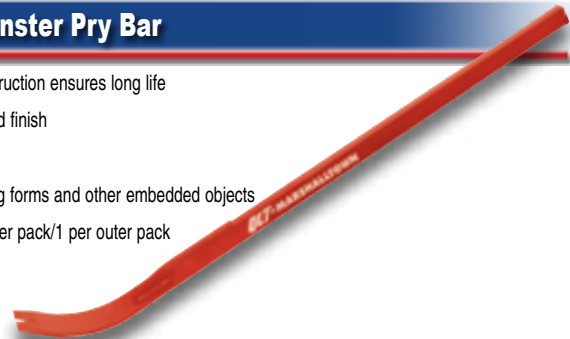

QLT BY MARSHALLTOWN

| EDI | Part# | Size-in. | Size-mm |
|-------|-------|----------|---------|
| 14956 | 14956 | 46 | 1168 |

Picks and Mattocks

- One-piece forged head for strength and durability
- Available with 36" (914mm) fiberglass handle or ash handle
- Used for cutting roots and breaking up soil
- For details and options **see page 243**

RED803421F

RED803521FG



Crow Bars

- Painted carbon steel
- San Angelo Pry Bar has a pencil point for easy soil penetration
- San Angelo Pry Bar has a hexagonal shape to strengthen grip
- Posthole digger bar for clearing roots and rocks from postholes and trenches
- Pinch and wedge point pry bars are used for demolition jobs
- 1 per inner/1 per outer pack

RED8043872

RED8043768

RED8043860

RED8043960



MARSHALLTOWN The Premier Line

| EDI | Part# | Description | Size |
|-------|------------|-----------------------------|------------------------------|
| 24390 | RED8043768 | San Angelo Pry Bar | 60" X 1" (1524mm X 25mm) |
| 24392 | RED8043860 | Pinchpoint Pry Bar | 60" X 1 1/4" (1524mm X 31mm) |
| 24393 | RED8043872 | Tamper/Post Hole Digger Bar | 60" X 1" (1524mm X 25mm) |
| 24394 | RED8043960 | Wedgepoint Pry Bar | 60" X 1 1/4" (1524mm X 31mm) |

Wizzer Bars

- Painted carbon steel
- Dual claw design allows for equal force pushing or pulling
- 1 per inner/1 per outer pack



MADE IN U.S.A.

MARSHALLTOWN The Premier Line

| EDI | Part# | Size |
|-------|-----------|--------------|
| 20127 | RED704857 | 36" (914mm) |
| 20128 | RED704858 | 48" (1219mm) |

HIT® Open Jaw Rebar Cutter/Bender

- Cuts and bends rebar up to #5 (5/8" rebar) grade 60
- Open jaw for easy rebar placement when cutting
- Jaws include two open cutting slots
- Built in ruler for easy measuring
- Includes wood board
- 52" (1321mm) handle
- Sold 1 per inner pack/1 per outer pack

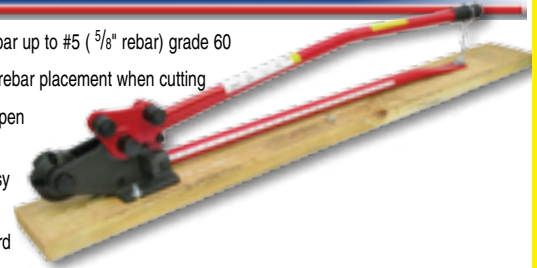

MARSHALLTOWN The Premier Line

| EDI | Part# | Description | Size-in. | Size-mm |
|-------|---------|---------------|----------|---------|
| 12863 | RCB63 | Cutter/Bender | 5/8" | 16 |
| 12939 | RCB63RH | Repl. Head | N/A | N/A |

Open Jaw Rebar Cutter/Bender

- Cuts and bends rebar up to #5 (5/8" rebar) grade 60
- Open jaw for easy rebar placement when cutting
- Jaws include two open cutting slots
- 52" (1321mm) handle
- Sold 1 per inner pack/1 per outer pack



QLTTM MARSHALLTOWN

| EDI | Part# | Description | Size-in. | Size-mm |
|-------|-----------|---------------|----------|---------|
| 25122 | RED704559 | Cutter/Bender | 5/8" | 16 |
| 25123 | RED704560 | Repl. Head | N/A | N/A |

Rebar Bender/Cutter

- Cuts and bends rebar up to #5 (5/8" rebar) grade 60
- Mounted on wood board
- Rugged cast iron construction
- 54" (1372mm) steel handle
- Replacement parts available
- Sold 1 per inner pack/1 per outer pack



MADE IN U.S.A.

MARSHALLTOWN The Premier Line

| EDI | Part# | Description |
|-------|-------|-----------------------------|
| 14730 | 14730 | Cutter Assembly |
| 14743 | 14743 | Split Washers (set of 2) |
| 14744 | 14744 | Base Casting |
| 14745 | 14745 | Bearing Set (46 pcs.) |
| 14747 | 14747 | Roller |
| 14749 | 14749 | Roller Pin |
| 14751 | 14751 | Cutter-Bushing Set (2 pcs.) |

Rebar Bender

- Bends rebar up to #5 (5/8" rebar) grade 60
- Sold 2 per inner pack/2 per outer pack



QLT BY MARSHALLTOWN

| EDI | Part# | Size-in. | Size-mm |
|-------|-------|----------|---------|
| 14739 | 14739 | 34 | 864 |

HIT® Heavy Duty Bolt Cutters

- For general cutting of medium steel and soft bolts, rods and chains
- Cuts metal with a hardness rating up to Brinell 400/Rockwell C42
- Heavy duty drop forged cutting jaws with precision cutting edges for long life
- Replacement heads available
- All items and replacement parts sold 1 per inner/1 per outer pack

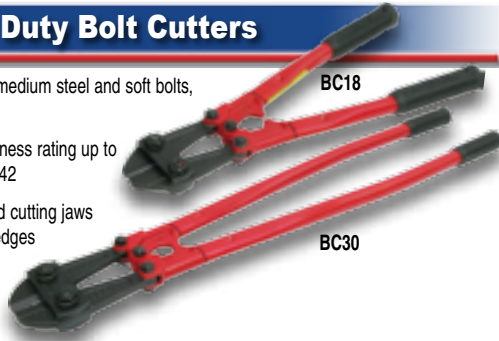

MARSHALLTOWN The Premier Line

| EDI | Part# | Description | Size-in. | Size-mm |
|-------|--------|---------------------------|----------|---------|
| 12782 | BC14 | Heavy-Duty Bolt Cutter | 14 | 356 |
| 12783 | BC18 | Heavy-Duty Bolt Cutter | 18 | 457 |
| 12784 | BC24 | Heavy-Duty Bolt Cutter | 24 | 610 |
| 12785 | BC30 | Heavy-Duty Bolt Cutter | 30 | 762 |
| 12786 | BC36 | Heavy-Duty Bolt Cutter | 36 | 914 |
| 12787 | BC42 | Heavy-Duty Bolt Cutter | 42 | 1,067 |
| 12788 | BC14RH | Repl. Head - 14" (356mm) | N/A | N/A |
| 12789 | BC18RH | Repl. Head - 18" (457mm) | N/A | N/A |
| 12790 | BC24RH | Repl. Head - 24" (610mm) | N/A | N/A |
| 12791 | BC30RH | Repl. Head - 30" (762mm) | N/A | N/A |
| 12792 | BC36RH | Repl. Head - 36" (914mm) | N/A | N/A |
| 12793 | BC42RH | Repl. Head - 42" (1067mm) | N/A | N/A |

Pull Tie Wire Twister

- Safely and easily twists looped wire bar ties
- Rubber grip handle
- Twists most ties with a single pull
- Sold 1 per inner pack/50 per outer pack

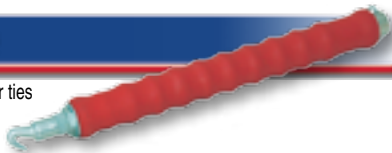

QLT BY MARSHALLTOWN

| EDI | Part# | Size-in. | Size-mm |
|-------|-------|----------|---------|
| 12637 | 12637 | 12 | 305 |

Tie Wire Twisters

- Compact size allows the tool to be used in tight spaces
- Safely and easily twists looped wire bar ties
- Durable design
- Sold 24 per inner pack/24 per outer pack

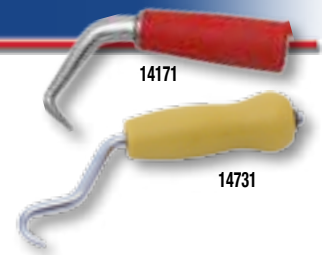

QLT BY MARSHALLTOWN

| EDI | Part# | Description |
|-------|-------|-------------|
| 14731 | 14731 | Standard |
| 14171 | 14171 | Heavy-Duty |

Looped Wire Ties

- Double looped for tying 2 or more pieces of rebar
- 16 gauge
- PVC coated wire for use with epoxy coated rebar or when rusting is a concern
- Black annealed to twist easy, but resist breaking
- Sold 5000 ties per bag, packed in sub-bundles of 1,000
- Use with Pull Type Twister (12637), Heavy Duty Twister (14171), or Standard Twister (14731)

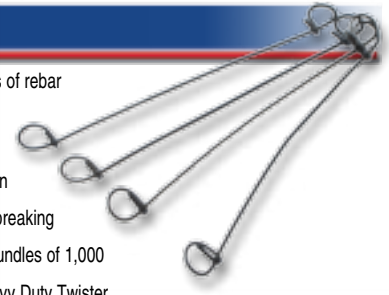

MARSHALLTOWN The Premier Line

| EDI | Part# | Description | Size-in. | Size-mm |
|-------|---------|----------------|----------|---------|
| 11801 | BART4 | Black Annealed | 4 | 102 |
| 11805 | BART7 | Black Annealed | 7 | 178 |
| 11806 | BART8 | Black Annealed | 8 | 203 |
| 11808 | BART9 | Black Annealed | 9 | 229 |
| 11809 | BART10 | Black Annealed | 10 | 254 |
| 11810 | BART12 | Black Annealed | 12 | 305 |
| 11811 | PVCRT4 | PVC Coated | 4 | 102 |
| 11812 | PVCRT5 | PVC Coated | 5 | 127 |
| 11814 | PVCRT7 | PVC Coated | 7 | 178 |
| 11816 | PVCRT9 | PVC Coated | 9 | 229 |
| 11817 | PVCRT10 | PVC Coated | 10 | 254 |
| 11818 | PVCRT12 | PVC Coated | 12 | 305 |

Tie Wire Reels

- **16026** is made of lightweight durable plastic, **16019** is constructed of lightweight aluminum
- Fits any standard size belt
- Accommodates all types of tie wire
- Sold 1 per inner pack/6 per outer pack

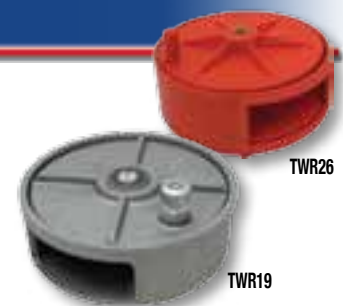

QLT BY MARSHALLTOWN

| EDI | Part# | Description |
|-------|-------|-------------|
| 16019 | TWR19 | Aluminum |
| 16026 | TWR26 | Plastic |

Estwing Mash Hammers

- Made of a single piece of forged steel with nylon-vinyl cushion grip
- Fully polished face
- For striking chisels, punches, star drills, spikes and nail pins
- Inner and outer pack quantities shown in table

MARSHALLTOWN The Premier Line

| EDI | Part# | Size | Weight-lb. | Inner/Outer |
|-------|--------|--------------|------------|-------------|
| 11567 | B32LB | 10½" (267mm) | 2 | 4/20 |
| 11568 | B33LB | 11" (279mm) | 3 | 4/12 |
| 11569 | B34LB | 11½" (292mm) | 4 | 4/12 |
| 11570 | B34LBL | 16" (406mm) | 4 | 4/8 |



Sledge Hammers

- Made of a single piece of forged steel with polished double face
- Fiberglass handle and lacquered hickory replacement handles available
- For striking chisels, punches, star drills, spikes and nail pins
- Sold 4 per inner pack/12 per outer pack



Fiberglass Handle

| EDI | Part# | Size-in. | Size-mm | Weight-lb. |
|-------|-------------|----------|---------|------------|
| 24355 | RED803006FG | 36 | 914 | 6 |
| 24356 | RED803008FG | 36 | 914 | 8 |
| 24358 | RED803012FG | 36 | 914 | 12 |
| 24359 | RED803016FG | 36 | 914 | 16 |
| 24360 | RED803020FG | 36 | 914 | 20 |

Replacement Heads

| EDI | Part# | Weight-lb. |
|-------|-----------|------------|
| 24324 | RED804108 | 12 |
| 24325 | RED804109 | 16 |
| 24318 | RED804092 | 20 |

Replacement Handles

| EDI | Part# | Description |
|-------|-----------|---|
| 24326 | RED804129 | 36" (914mm) Hickory Handle |
| 24328 | RED804139 | 36" (914mm) Hickory Handle - For 20lb Hammer |
| 24332 | RED804167 | 36" (914mm) Fiberglass Handle - For 20lb Hammer |

Shorty Sledge Hammer

- Made of a single piece of forged steel with polished double face
- Hickory handle
- For striking chisels, punches, star drills, spikes and nail pins
- Sold 4 per inner pack/12 per outer pack



MARSHALLTOWN The Premier Line

| EDI | Part# | Handle Type | Size-in. | Size-mm | Weight-lb. |
|-------|-----------|-------------|----------|---------|------------|
| 24347 | RED805706 | Hickory | 16 | 406 | 6 |

Mash Hammer

- Made of a single piece of forged steel with nylon-vinyl cushion grip
- Fully polished face
- For striking chisels, punches, star drills, spikes and nail pins
- Sold 4 per inner pack/12 per outer pack



MARSHALLTOWN The Premier Line

| EDI | Part# | Size-in. | Size-mm | Weight-lb. |
|-------|-------|----------|---------|------------|
| 11576 | MHM3 | 11 | 279 | 3 |

Mash Hammers

- Carbon steel head and body
- Beveled edge head, fully polished
- Anti-vibration softgrip handle
- Sold 4 per inner pack/12 per outer pack, 4 per inner pack/16 per outer pack where noted with *



QLTTM MARSHALLTOWN

| EDI | Part# | Size-in. | Size-mm | Weight-lb. |
|-------|---------|--------------------------------|---------|------------|
| 11574 | MHAV25* | 10 ⁷ / ₈ | 276 | 2½ |
| 11575 | MHAV4 | 10 ⁷ / ₈ | 276 | 4 |

Claw Framing Hammer

- For driving and removing nails
- Full polished, forged one-piece tool steel
- For more details and size options **see pages 237-238**



Drilling Hammers

- Made of a single piece of forged steel with polished double face
- Fiberglass handle, hickory replacements available
- For striking chisels, punches, star drills, spikes and nail pins
- Sold 4 per inner pack/12 per outer pack



MARSHALLTOWN The Premier Line

| EDI | Part# | Handle Type | Size-in. | Size-mm | Weight-lb. |
|-------|-----------|-------------|----------|---------|------------|
| 24341 | RED805503 | Hickory | 10 | 254 | 3 |
| 24342 | RED805504 | Hickory | 10 | 254 | 4 |

Replacement Heads

| EDI | Part# | Weight-lb. |
|-------|-----------|------------|
| 24316 | RED804056 | 3 |

Replacement Handles

| EDI | Part# | Description |
|-------|-----------|----------------------------|
| 24313 | RED804042 | 10" (254mm) Hickory Handle |

Engineer Hammers

- Made of a single piece of forged steel with polished double face
- Choice of lacquered hickory handle or fiberglass handle
- For striking chisels, punches, star drills, spikes and nail pins
- Sold 4 per inner pack/12 per outer pack



MARSHALLTOWN The Premier Line

| EDI | Part# | Handle Type | Size-in. | Size-mm | Weight-lb. |
|-------|-------------|-------------|----------|---------|------------|
| 24345 | RED805703 | Hickory | 16 | 406 | 3 |
| 24364 | RED805703FG | Fiberglass | 16 | 406 | 3 |

Replacement Handles

| EDI | Part# | Description |
|-------|-----------|----------------------------|
| 24314 | RED804043 | 16" (406mm) Hickory Handle |

Mash Hammers

- Carbon steel head and body
- Beveled edge head, fully polished
- Soft grip handle
- Sold 4 per inner pack/12 per outer pack, 4 per inner pack/16 per outer pack where noted with *



QLT BY MARSHALLTOWN

| EDI | Part# | Size-in. | Size-mm | Weight-lb. |
|-------|--------|--------------------------------|---------|-------------------------------|
| 11571 | MHF25* | 10 ³ / ₈ | 264 | 2 ¹ / ₂ |
| 11572 | MHF3 | 10 ³ / ₈ | 264 | 3 |
| 11573 | MHF4 | 10 ³ / ₈ | 264 | 4 |

Mash Hammers

- Forged high carbon steel double faced head, painted and polished
- 10¹/₄" (206mm) Hickory handle
- Excellent hammer for driving stakes or form building
- Sold 1 per inner pack/4 per outer pack



QLT BY MARSHALLTOWN

| EDI | Part# | Size-in. | Size-mm | Weight-lb. |
|-------|-------|--------------------------------|---------|------------|
| 10304 | MHW2 | 10 ¹ / ₂ | 267 | 2 |
| 10345 | MHW3 | 10 ¹ / ₂ | 267 | 3 |
| 10347 | MHW4 | 10 ¹ / ₂ | 267 | 4 |



Stake Jimmy

- Models available for use with either $\frac{3}{4}$ " or $\frac{7}{8}$ " (19mm or 22mm) stakes
- Makes pulling stakes a quick and easy task
- Use guide pins to grip stake, twist and lift to remove stake
- No more bent or lost stakes
- Removes stakes flush with form
- Comfortable foam grips
- Sold 1 per inner pack/1 per outer pack



MSP34

MSNP34

Stake Jimmy w/Nail Puller

- Combines benefits of a Stake Puller and Nail Puller in one tool
- Slide nail puller down stake to engage nail. Push forward on handles to remove nail
- Nail pulls out straight for re-use

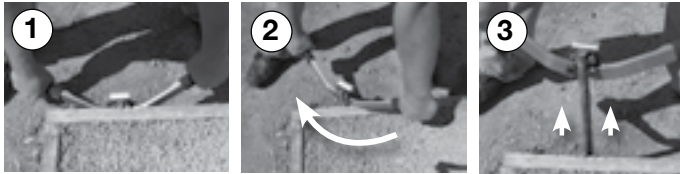

MADE IN U.S.A.

MARSHALLTOWN The Premier Line

| EDI | Part# | Description |
|-------|--------|--|
| 12508 | MSP34 | $\frac{3}{4}$ " (19mm) Stake Puller |
| 12509 | MSP78 | $\frac{7}{8}$ " (22mm) Stake Puller |
| 12513 | MSNP34 | $\frac{3}{4}$ " (19mm) Stake & Nail Puller |
| 12515 | MSNP78 | $\frac{7}{8}$ " (22mm) Stake & Nail Puller |

Stake Holder

- 18" long aluminum alloy handle with spring loaded jaw
- Grips stake tightly for safe hammering
- Easily picks up loose stakes off the ground
- Works with $\frac{3}{4}$ " (19mm) round stakes
- Comfortable foam grip
- Sold 1 per inner pack/1 per outer pack



MADE IN U.S.A.

MARSHALLTOWN The Premier Line

| EDI | Part# | Description |
|-------|-------|--------------|
| 12519 | MSH34 | Stake Holder |

Nail Puller

- Removes nails from either $\frac{3}{4}$ " or $\frac{7}{8}$ " (19mm or 22mm) stakes
- Saddle design supports tool, keeping it from slipping off stake
- Mechanical advantage of handle allows nail to be removed in one easy motion
- Pulls nails straight out for re-use
- Sold 1 per inner pack/1 per outer pack



MADE IN U.S.A.

MARSHALLTOWN The Premier Line

| EDI | Part# | Description |
|-------|-------|-------------|
| 12517 | MNP09 | Nail Puller |

Stake Jack™

- Makes it easy to pull concrete form pins and stakes without bending them
- Heavy gauge steel and tubing to withstand everyday jobsite use
- Will remove $\frac{7}{8}$ " (22mm) and smaller stakes and form pins
- Two holes in the plate at the base allow attachment to a board for an even wider base for working in softer conditions
- The 29" (737mm) stake puller minimizes the need to bend over to pull out stakes
- Provides a 9:1 mechanical lifting advantage
- Sold 1 per inner pack/1 per outer pack



JAWSET

MADE IN U.S.A.

MARSHALLTOWN The Premier Line

| EDI | Part# | Description | Size-in. | Size-mm |
|-------|--------|-----------------------------|----------|---------|
| 17377 | STP14 | Stake Puller | 14 | 356 |
| 17379 | JAWSET | Repl. Jaws & Hardware (4pk) | N/A | N/A |

Stake Puller

- Pulls wood or steel stakes with ease
- Made of heavy duty ductile iron
- Maximum pulling capacity for round stakes $\frac{7}{8}$ " (22mm)
- Maximum pulling capacity for flat stakes $1\frac{1}{2}$ " (38mm)
- Tool weighs 10lbs (4.5kg)
- Sold 1 per inner pack/2 per outer pack

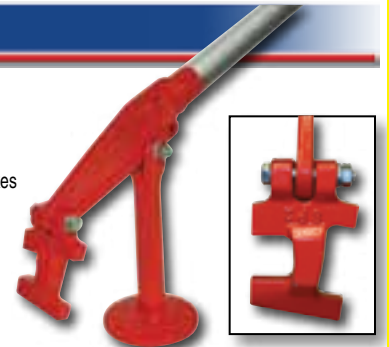

QLT BY MARSHALLTOWN

| EDI | Part# | Size-in. | Size-mm |
|-------|-------|----------|---------|
| 16988 | HSP88 | 56 | 1,422 |

Cyclone™ Power Trowel



- Infinite blade pitch control adjusts from 0°-28°
- Dependable gearbox design provides maximum torque transfer
- Responsive clutch and pulley system for smooth speed transitions
- Integrated lift hook allows for safe multi-level transportation on all models except 46E9NH
- Honda® engines on all models
- Lift bar included on all models
- Edger Pro gets within 3/4" of walls and obstructions with blades and 5/16" with float pan
- Four blade design with maximum rotor speed of 118 RPM
- Sold 1 per inner pack/1 per outer pack

Edger Pro Includes:



Padded hip bar



Adjustable handle design



Rotating guard ring



MARSHALLTOWN The Premier Line

| EDI | Part# | Description | Rotor Dia. | Weight-lb. (kilo) | Size (L X H) |
|-------|--------|----------------|--------------|----------------------|-----------------|
| 10917 | 36E55 | 5.5 HP | 36" (914mm) | 205(93) | 70 X 38 |
| 10918 | 36PE9 | 9 HP Edger Pro | 36" (914mm) | 226(102) | 84 X 38 |
| 10760 | 46E9NH | 9 HP | 46" (1168mm) | 262(119) | 89 X 38 |
| 10919 | 46E11 | 11 HP | 46" (1168mm) | 262(119) | 89 X 38 |

Replacement Blades Chart

| Part# | Blade Part# | Blade Type |
|--------|-------------|---------------------------|
| 36E55 | M6093 | Finish |
| | M7341 | Flat Finish |
| | M6092 | Combination |
| | A4172 | Float |
| | PAN36-4C | Float Pan |
| 36PE9 | M7345 | Edger |
| | M7346 | Edger |
| | PAN36-4CE | Float Pan |
| 46E9NH | M6095 | Finish |
| | M7343 | Flat Finish Round Corners |
| | M6094 | Combination |
| | A4171 | Float |
| | PAN46-4C | Float Pan |
| 46E11 | M6095 | Finish |
| | M7343 | Flat Finish Round Corners |
| | M6094 | Combination |
| | A4171 | Float |
| | PAN46-4C | Float Pan |

Z Clip Power Trowel Pans

- Edge is beveled to prevent the pan from digging into the concrete
- Has a 1/8" (3mm) rise from center of pan to edge of pan
- Made from rugged 10 gauge steel for optimal life
- Blade attachments are dual-directional (except for 24" pans)
- Powder coated pans provide rust protection prior to use
- 36 and 42 inch pans can be used on "Walk-Behind" and non-overlapping "Ride-On" power trowels
- 44, 45, 46, 48, 60 and 62 inch pans are intended for non-overlapping "Ride-On" power trowels only
- 44-inch and 46-inch pans are available in either 4-blade or 5-blade configurations.
- 59 1/4-inch pans are 6 blade only
- 62-inch pans are 5 or 6 blade configurations
- Edger pan with 90 degree lip
- Edger pans are noted with an "E" in the part number
- **New items indicated in red**
- Sold 1 per inner pack/1 per outer pack



MARSHALLTOWN The Premier Line

Un-Painted Z Clip Power Trowel Pans

| EDI | Part# | Size | Inside Dia. | Outside Dia. | # Blades |
|-------|-----------------|------------------|--------------------|--------------------|----------|
| 11107 | PAN24-4CE | 24" (610mm) | 23 3/4" (603mm) | 23 7/8" (606mm) | 4 |
| 11108 | PAN36-4CE | 36" (914mm) | 36 3/8" (924mm) | 36 1/2" (927mm) | 4 |
| 14920 | PAN36-4C | 36" (914mm) | 36 1/4" (921mm) | 37 5/16" (948mm) | 4 |
| 11109 | PAN42-4C | 42" (1067mm) | 43 1/4" (1099mm) | 43 1/2" (1105mm) | 4 |
| 10095 | PAN44-4C | 44" (1118mm) | 44 11/16" (1135mm) | 45 3/4" (1162mm) | 4 |
| 10096 | PAN44-5C | 44" (1118mm) | 44 11/16" (1135mm) | 45 3/4" (1162mm) | 5 |
| 18349 | PAN45-5C | 45" (1143mm) | 45 3/8" (1152mm) | 46 7/16" (1180mm) | 5 |
| 14921 | PAN46-4C | 46" (1168mm) | 45 7/8" (1165mm) | 46 15/16" (1192mm) | 4 |
| 14922 | PAN46-5C | 46" (1168mm) | 45 7/8" (1165mm) | 46 15/16" (1192mm) | 5 |
| 14923 | PAN48-4C | 48" (1219mm) | 46 1/4" (1175mm) | 47 5/16" (1202mm) | 4 |
| 14924 | PAN48-5C | 48" (1219mm) | 46 1/4" (1175mm) | 47 5/16" (1202mm) | 5 |
| 11112 | PAN60-6C | 59 1/4" (1505mm) | 58 5/8" (1489mm) | 59 11/16" (1516mm) | 6 |
| 11139 | PAN62-5C | 62" (1575mm) | 60 5/8" (1540mm) | 61 11/16" (1567mm) | 5 |
| 11140 | PAN62-6C | 62" (1575mm) | 60 5/8" (1540mm) | 61 11/16" (1567mm) | 6 |

Painted Z Clip Power Trowel Pans

| EDI | Part# | Size | Inside Dia. | Outside Dia. | # Blades |
|-------|-------------------|------------------|--------------------|--------------------|----------|
| 18387 | PAN24-4CE-P | 24" (610mm) | 23 3/4" (603mm) | 23 7/8" (606mm) | 4 |
| 18388 | PAN36-4CE-P | 36" (914mm) | 36 3/8" (924mm) | 36 1/2" (927mm) | 4 |
| 18389 | PAN36-4C-P | 36" (914mm) | 36 1/4" (921mm) | 37 5/16" (948mm) | 4 |
| 18390 | PAN42-4C-P | 42" (1067mm) | 43 1/4" (1099mm) | 43 1/2" (1105mm) | 4 |
| 18391 | PAN44-4C-P | 44" (1118mm) | 44 11/16" (1135mm) | 45 3/4" (1162mm) | 4 |
| 18392 | PAN44-5C-P | 44" (1118mm) | 44 11/16" (1135mm) | 45 3/4" (1162mm) | 5 |
| 18350 | PAN45-5C-P | 45" (1143mm) | 45 3/8" (1152mm) | 46 7/16" (1180mm) | 5 |
| 18393 | PAN46-4C-P | 46" (1168mm) | 45 7/8" (1165mm) | 46 15/16" (1192mm) | 4 |
| 18394 | PAN46-5C-P | 46" (1168mm) | 45 7/8" (1165mm) | 46 15/16" (1192mm) | 5 |
| 18395 | PAN48-4C-P | 48" (1219mm) | 46 1/4" (1175mm) | 47 5/16" (1202mm) | 4 |
| 18396 | PAN48-5C-P | 48" (1219mm) | 46 1/4" (1175mm) | 47 5/16" (1202mm) | 5 |
| 18397 | PAN60-6C-P | 59 1/4" (1505mm) | 58 5/8" (1489mm) | 59 11/16" (1516mm) | 6 |
| 18398 | PAN62-5C-P | 62" (1575mm) | 60 5/8" (1540mm) | 61 11/16" (1567mm) | 5 |
| 18399 | PAN62-6C-P | 62" (1575mm) | 60 5/8" (1540mm) | 61 11/16" (1567mm) | 6 |

MADE IN U.S.A.

CONCRETE TOOLS

Safety Clip Power Trowel Pans

- Edge is beveled to prevent the pan from digging into the concrete
- Safety clip pans keep pans secured to power trowel as it's being lifted or moved
- Safety clips included with pan
- Has a 1/8" (3mm) rise from center of pan to edge of pan
- Made from rugged 10 gauge steel for optimal life
- Blade attachments are dual-directional
- Powder coated pans provide rust protection prior to use
- 36 and 42 inch pans can be used on "Walk-Behind" and non-overlapping "Ride-On" power trowels
- 44, 45, 46, 48, 60 and 62 inch pans are intended for non-overlapping "Ride-On" power trowels only
- 44, 46 and 48 inch pans are available in either 4-blade or 5-blade configurations.
- 59 1/4-inch pans are 6 clip only
- 62-inch pans are 5 or 6 clip configurations
- Edger pan with 90 degree lip
- **New items indicated in red**
- Sold 1 per inner pack/1 per outer pack



PAN36SC-4CE

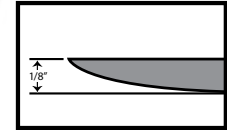

1/8" rise for super flat floors

MARSHALLTOWN The Premier Line



Un-Painted Safety Clip Power Trowel Pans

| EDI | Part# | Size | Inside Dia. | Outside Dia. | # Blades |
|-------|-------------------|------------------|-------------------|--------------------|----------|
| 18650 | PAN36SC-4CE | 36" (914mm) | 36 3/8" (924mm) | 36 1/2" (927mm) | 4 |
| 11271 | PAN36SC-4C | 36" (914mm) | 36 1/4" (921mm) | 37 5/16" (948mm) | 4 |
| 18653 | PAN42SC-4C | 42" (1067mm) | 43 1/4" (1099mm) | 43 1/2" (1105mm) | 4 |
| 18655 | PAN44SC-4C | 44" (1118mm) | 44 1/16" (1135mm) | 45 3/4" (1162mm) | 4 |
| 18657 | PAN44SC-5C | 44" (1118mm) | 44 1/16" (1135mm) | 45 3/4" (1162mm) | 5 |
| 18347 | PAN45SC-5C | 45" (1143mm) | 45 3/8" (1152mm) | 46 7/16" (1180mm) | 5 |
| 11272 | PAN46SC-4C | 46" (1168mm) | 45 7/8" (1165mm) | 46 15/16" (1192mm) | 4 |
| 11273 | PAN46SC-5C | 46" (1168mm) | 45 7/8" (1165mm) | 46 15/16" (1192mm) | 5 |
| 11274 | PAN48SC-4C | 48" (1219mm) | 46 1/4" (1175mm) | 47 5/16" (1202mm) | 4 |
| 11275 | PAN48SC-5C | 48" (1219mm) | 46 1/4" (1175mm) | 47 5/16" (1202mm) | 5 |
| 18661 | PAN60SC-6C | 59 1/4" (1505mm) | 58 5/8" (1489mm) | 59 11/16" (1516mm) | 6 |
| 18663 | PAN62SC-5C | 62" (1575mm) | 60 5/8" (1540mm) | 61 11/16" (1567mm) | 5 |
| 18665 | PAN62SC-6C | 62" (1575mm) | 60 5/8" (1540mm) | 61 11/16" (1567mm) | 6 |

Painted Safety Clip Power Trowel Pans

| EDI | Part# | Size | Inside Dia. | Outside Dia. | # Blades |
|-------|---------------------|------------------|--------------------|--------------------|----------|
| 18651 | PAN36SC-4CE-P | 36" (914mm) | 36 3/8" (924mm) | 36 1/2" (927mm) | 4 |
| 18652 | PAN36SC-4C-P | 36" (914mm) | 36 1/4" (921mm) | 37 5/16" (948mm) | 4 |
| 18654 | PAN42SC-4C-P | 42" (1067mm) | 43 1/4" (1099mm) | 43 1/2" (1105mm) | 4 |
| 18656 | PAN44SC-4C-P | 44" (1118mm) | 44 11/16" (1135mm) | 45 3/4" (1162mm) | 4 |
| 18658 | PAN44SC-5C-P | 44" (1118mm) | 44 11/16" (1135mm) | 45 3/4" (1162mm) | 5 |
| 18348 | PAN45SC-5C-P | 45" (1143mm) | 45 3/8" (1152mm) | 46 7/16" (1180mm) | 5 |
| 18659 | PAN46SC-4C-P | 46" (1168mm) | 45 7/8" (1165mm) | 46 15/16" (1192mm) | 4 |
| 18660 | PAN46SC-5C-P | 46" (1168mm) | 45 7/8" (1165mm) | 46 15/16" (1192mm) | 5 |
| 18662 | PAN60SC-6C-P | 59 1/4" (1505mm) | 58 5/8" (1489mm) | 59 11/16" (1516mm) | 6 |
| 18664 | PAN62SC-5C-P | 62" (1575mm) | 60 5/8" (1540mm) | 61 11/16" (1567mm) | 5 |
| 18666 | PAN62SC-6C-P | 62" (1575mm) | 60 5/8" (1540mm) | 61 11/16" (1567mm) | 6 |

Plastic Power Trowel Blades



- Provides a hard, polished finish
- Intended to float and finish any application where burnish marks are a concern
- "W" indicates UHMW blades, "R" indicates high density blades
- UHMW blades are intended for use on walk-behind power trowels
- High Density blades can be used on ride-on or walk-behind power trowels
- Fit same power trowels as M6092 & M6094 blades
- **Not for use on float pans**
- Sold 4 per inner pack/4 per outer pack



MARSHALLTOWN The Premier Line

| EDI | Part# | Description | Size-in. | Size-mm | Machine Size |
|-------|---------|-------------|----------|-----------|--------------|
| 14957 | PM6092W | Combination | 8 X 14 | 203 X 356 | 34, 36 |
| 14958 | PM6094W | Combination | 8 X 18 | 203 X 457 | 44, 46, 48 |
| 14959 | PM6092R | Combination | 8 X 14 | 203 X 356 | 34, 36 |
| 14960 | PM6094R | Combination | 8 X 18 | 203 X 457 | 44, 46, 48 |

Power Trowel Edger Blades

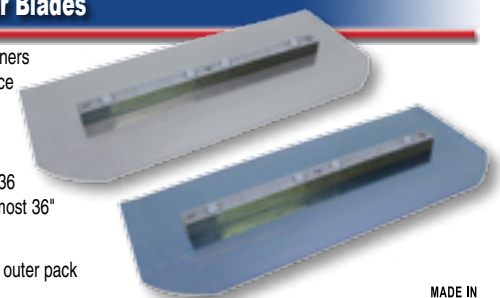

- Bent ends and rounded corners provide obstruction clearance
- Available in standard or extended life blue
- Intended for use on Allen 436 Edging Walker trowel and most 36" power trowels
- Sold 4 per inner pack/4 per outer pack
- Available in inner pack quantities only



MARSHALLTOWN The Premier Line

| EDI | Part# | Description | Size-in. | Size-mm |
|-------|-------|-------------------------------|----------|-----------|
| 17345 | M7345 | Edger Blade | 6 X 14 | 152 X 356 |
| 17346 | M7346 | Extrnd. Life Edger Blade-Blue | 6 X 14 | 152 X 356 |

Power Trowel Pan Conversion Chart

| Mfg. | Model# | Rotor Dia. | Blades | Standard Pan | Safety Clip Pan | Painted Standard Pan | Painted Safety Clip Pan |
|---|---|------------|---------------------|-------------------------|-------------------------|-----------------------------|-----------------------------|
| Allen | Walk Behind | | | | | | |
| | 436 Edger | 36" | 4 | PAN36-4CE | PAN36SC-4CE | PAN36-4CE-P | PAN36SC-4CE-P |
| | 436 / VP436 | 36" | 4 | PAN36-4C | PAN36SC-4C | PAN36-4C-P | PAN36SC-4C-P |
| | 442 | 42" | 4 | PAN42-4C | PAN42SC-4C | PAN42-4C-P | PAN42SC-4C-P |
| | 446 Series / VP446 | 46" | 4 | PAN46-4C | PAN46SC-4C | PAN46-4C-P | PAN46SC-4C-P |
| | Ride On | | | | | | |
| | Pro 900 Edger | 36" | 4 | PAN36-4CE | PAN36SC-4CE | PAN36-4CE-P | PAN36SC-4CE-P |
| | Pro 900 / MP205 | 36" | 4 | PAN36-4C | PAN36SC-4C | PAN36-4C-P | PAN36SC-4C-P |
| | Pro 1050 | 42" | 4 | PAN42-4C | PAN42SC-4C | PAN42-4C-P | PAN42SC-4C-P |
| | HP100 / HP200 / MP305 / Pro1200 / SP400 / SP450 | 46" | 4 | PAN46-4C / PAN48-4C | PAN46SC-4C / PAN48SC-4C | PAN46-4C-P / PAN48-4C-P | PAN46SC-4C-P / PAN48SC-4C-P |
| HD530 / PRO1200 / MSP425 / MSP430 / MSP435 / MSP440 / MSP460 / SP440B / SP425 | 46" | 5 | PAN46-5C / PAN48-5C | PAN46SC-5C / PAN48SC-5C | PAN46-5C-P / PAN48-5C-P | PAN46SC-5C-P / PAN48SC-5C-P | |
| Super Pro 500 / 550 / HDX 600 / 740 / 750 | 60" | 5 | PAN62-5C | PAN62SC-5C | PAN62-5C-P | PAN62SC-5C-P | |
| HD 560 | 60" | 6 | PAN62-6C* | PAN62SC-5C* | PAN62-6C-P* | PAN62SC-6C-P* | |
| Bartell | Walk Behind | | | | | | |
| | B436 | 36" | 4 | PAN36-4C | PAN36SC-4C | PAN36-4C-P | PAN36SC-4C-P |
| | B440 | 36" | 4 | PAN36-4C | PAN36SC-4C | PAN36-4C-P | PAN36SC-4C-P |
| | Ride On | | | | | | |
| | TS78 | 36 1/2" | 4 | PAN36-4C | PAN36SC-4C | PAN36-4C-P | PAN36SC-4C-P |
| | BTR88 | 38 1/2" | 4 | PAN36-4C | PAN36SC-4C | PAN36-4C-P | PAN36SC-4C-P |
| | TS96 | 45 3/4" | 4 | PAN44-4C | PAN44SC-4C | PAN44-4C-P | PAN44SC-4C-P |
| | TS100 | 48" | 4 | PAN46-4C / PAN48-4C | PAN46SC-4C / PAN48SC-4C | PAN46-4C-P / PAN48-4C-P | PAN46SC-4C-P / PAN48SC-4C-P |
| TS100 | 48" | 5 | PAN46-5C / PAN48-5C | PAN46SC-5C / PAN48SC-5C | PAN46-5C-P / PAN48-5C-P | PAN46SC-5C-P / PAN48SC-5C-P | |
| Boren | Ride On | | | | | | |
| | TS78 | 44" | 4 | PAN46-4C | PAN46SC-4C | PAN46-4C-P | PAN46SC-4C-P |
| | BTR88 / TS88 | 44" | 5 | PAN46-5C | PAN46SC-5C | PAN46-5C-P | PAN46SC-5C-P |
| EDCO | Walk Behind | | | | | | |
| T 364 | 36" | 4 | PAN36-4C | PAN36SC-4C | PAN36-4C-P | PAN36SC-4C-P | |
| Marshalltown | Walk Behind | | | | | | |
| | 36PE9 Edger Pro | 36" | 4 | PAN36-4CE | PAN36SC-4CE | PAN36-4CE-P | PAN36SC-4CE-P |
| | 36E55 | 36" | 4 | PAN36-4C | PAN36SC-4C | PAN36-4C-P | PAN36SC-4C-P |
| Master | Walk Behind | | | | | | |
| | F36 | 36" | 4 | PAN36-4C | PAN36SC-4C | PAN36-4C-P | PAN36SC-4C-P |
| MBW | Walk Behind | | | | | | |
| | F24/4 Edging Walker | 24" | 4 | PAN24-4CE | | PAN24-4CE-P | |
| | F36/4 | 36" | 4 | PAN36-4C | PAN36SC-4C | PAN36-4C-P | PAN36SC-4C-P |
| | Ride On | | | | | | |
| | F-78 / MK8 90 | 36 1/2" | 4 | PAN36-4C | PAN36SC-4C | PAN36-4C-P | PAN36SC-4C-P |
| | F-88 | 38 1/2" | 4 | PAN36-4C | PAN36SC-4C | PAN36-4C-P | PAN36SC-4C-P |
| F-96 | 45 3/4" | 4 | PAN44-4C | PAN44SC-4C | PAN44-4C-P | PAN44SC-4C-P | |
| Stow | Walk Behind | | | | | | |
| | SCT36 | 36" | 4 | PAN36-4C | PAN36SC-4C | PAN36-4C-P | PAN36SC-4C-P |
| Wacker Neuson | Walk Behind | | | | | | |
| | CT 36 Models | 36" | 4 | PAN36-4C | PAN36SC-4C | PAN36-4C-P | PAN36SC-4C-P |
| | Ride On | | | | | | |
| | CRT 36 | 36" | 4 | PAN36-4C | PAN36SC-4C | PAN36-4C-P | PAN36SC-4C-P |
| | CRT 46-KHN | 46" | 4 | PAN46-4C / PAN48-4C | PAN46SC-4C / PAN48SC-4C | PAN46-4C-P / PAN48-4C-P | PAN46SC-4C-P / PAN48SC-4C-P |
| | CRT 48-25K | 48" | 4 | PAN46-4C / PAN48-4C | PAN46SC-4C / PAN48SC-4C | PAN46-4C-P / PAN48-4C-P | PAN46SC-4C-P / PAN48SC-4C-P |
| CRT 48-31V-H / ES | 48" | 5 | PAN46-5C / PAN48-5C | - | PAN46-5C-P / PAN48-5C-P | - | |
| Multiquip Whiteman | Walk Behind | | | | | | |
| | C Series Edger | 24" | 4 | PAN24-4CE | - | PAN24-4CE-P | - |
| | J Series / HP Series | 36" | 4 | PAN36-4C | PAN36SC-4C | PAN36-4C-P | PAN36SC-4C-P |
| | Ride On | | | | | | |
| | HTN | 48" | 4 | PAN44-4C / PAN46-4C | PAN44SC-4C / PAN46SC-4C | PAN44-4C-P / PAN46-4C-P | PAN44SC-4C-P / PAN46SC-4C-P |
| HTH / HTX / HHN | 48" | 5 | PAN45-5C | PAN45SC-5C | PAN45-5C-P | PAN45SC-5C-P | |
| STH / STX | 60" | 6 | PAN60-6C | PAN60SC-6C | PAN60-6C-P | PAN60SC-6C-P | |

CONCRETE TOOLS

Superior® Power Trowel Blades

- Fits Superior® and Boren® power trowels
- A4176 is a float shoe for M7414
- Sold 4 per inner pack/4 per outer pack



M7416



A4176



M7417



MARSHALLTOWN The Premier Line

| EDI | Part# | Description | Size-in. | Size-mm |
|-------|-------|-----------------------------|-----------|-----------|
| 17413 | M7413 | Combination Blade | 8 X 14 | 203 X 356 |
| 17414 | M7414 | Combination Blade | 8 X 16 | 203 X 406 |
| 17415 | A4176 | Float Blade | 10½ X 17½ | 267 X 445 |
| 17416 | M7416 | Flat Finish - Round Corners | 8 X 16 | 203 X 406 |
| 17417 | M7417 | Combination Blade | 8 X 18 | 203 X 457 |

EDCO® Power Trowel Blades

- Fits EDCO® brand power trowels
- Fits trowels equipped with EDCO® adapters
- Quick change blades require no bolt removal
- Sold 4 per inner pack/4 per outer pack



M7407



M7408



A4174



MARSHALLTOWN The Premier Line

| EDI | Part# | Description | Size-in. | Size-mm |
|-------|-------|-------------------|----------|-----------|
| 17407 | M7407 | Finish Blade | 6 X 14 | 152 X 356 |
| 17408 | M7408 | Combination Blade | 8 X 14 | 203 X 356 |
| 17409 | A4174 | Float Blade | 10 X 14 | 254 X 356 |
| 17410 | M7410 | Finish Blade | 6 X 18 | 152 X 457 |
| 17411 | M7411 | Combination Blade | 8 X 18 | 203 X 457 |
| 17412 | A4175 | Float Blade | 10 X 18 | 254 X 457 |

Extended Life Gold Power Trowel Blades

- **MARSHALLTOWN's** longest lasting power trowel blades
- Lasts up to 50% longer than standard power trowel blades
- Recommended for use with "Ride-On" power trowels
- M7363 has a 1" wide bar
- Sold 4 per inner pack/4 per outer pack
- Available in inner pack quantities only



MARSHALLTOWN The Premier Line

| EDI | Part# | Size-in. | Size-mm | Blade Type | Machine Size |
|-------|----------|----------|-----------|--------------------|--------------|
| 14000 | M6093ELG | 6 X 14 | 152 X 356 | Finish | 34, 36 |
| 14001 | M6095ELG | 6 X 18 | 152 X 457 | Finish | 44, 46, 48 |
| 17351 | M7349ELG | 6 X 23 | 152 X 584 | Finish | 60 |
| 17359 | M7342ELG | 8 X 14 | 203 X 356 | Fl. Finish Rd. Cr. | 34, 36 |
| 14008 | M6092ELG | 8 X 14 | 203 X 356 | Combination | 34, 36 |
| 17362 | M7343ELG | 8 X 18 | 203 X 457 | Fl. Finish Rd. Cr. | 44, 46, 48 |
| 14003 | M6094ELG | 8 X 18 | 203 X 457 | Combination | 44, 46, 48 |
| 17354 | M7352ELG | 8 X 23 | 203 X 584 | Combination | 60 |
| 17363 | M7363ELG | 8 X 23 | 203 X 584 | Fl. Finish Rd. Cr. | 60 |

Extended Life Blue Power Trowel Blades

- Lasts up to 25% longer than standard power trowel blades
- Recommended for both "Ride-On" and "Walk-Behind" power trowels
- Sold 4 per inner pack/4 per outer pack
- Available in inner pack quantities only



MARSHALLTOWN The Premier Line

| EDI | Part# | Size-in. | Size-mm | Blade Type | Machine Size |
|-------|-----------|----------|-----------|--------------------|--------------|
| 17376 | M7373RELB | 6 X 10½ | 152 X 267 | Edger | 30 |
| 14004 | M6093ELB | 6 X 14 | 152 X 356 | Finish | 34, 36 |
| 14005 | M6095ELB | 6 X 18 | 152 X 457 | Finish | 44, 46, 48 |
| 17350 | M7349ELB | 6 X 23 | 152 X 584 | Finish | 60 |
| 17358 | M7342ELB | 8 X 14 | 203 X 356 | Fl. Finish Rd. Cr. | 34, 36 |
| 14006 | M6092ELB | 8 X 14 | 203 X 356 | Combination | 34, 36 |
| 17361 | M7343ELB | 8 X 18 | 203 X 457 | Fl. Finish Rd. Cr. | 44, 46, 48 |
| 14007 | M6094ELB | 8 X 18 | 203 X 457 | Combination | 44, 46, 48 |
| 17353 | M7352ELB | 8 X 23 | 203 X 584 | Combination | 60 |

Power Trowel Blades

- Used in conjunction with power trowels for finishing large areas of concrete or concrete that is too stiff to handle
- Available in five styles: finish, flat finish, combination, float or abrasive
- All blades are sold 4 per inner pack/4 per outer pack
- Power trowel stones are sold 1 per inner pack/4 per outer pack
- Trowel stone holders are sold 1 per inner pack/2 per outer pack
- Available in inner pack quantities only



MARSHALLTOWN The Premier Line

| EDI | Part# | Size-in. | Size-mm | Type | Machine Size |
|-------|----------|-----------|---------------|----------------------------------|--------------|
| 17371 | M7371 | 6 X 10½ | 152 X 267 | Finish | 30 |
| 18351 | M7371R | 6 X 10½ | 152 X 267 | Finish (4" Corners on same side) | 30 |
| 17330 | M6096 | 6 X 11 | 152 X 279 | Finish | 30 |
| 17336 | M6093 | 6 X 14 | 152 X 356 | Finish | 34, 36 |
| 17636 | M7636 | 6 X 14 | 152 X 356 | Channel Finish | 34, 36 |
| 17340 | M7340 | 6 X 14 | 152 X 356 | Flat Finish | 34, 36 |
| 17367 | M7367 | 6 X 16 | 152 X 406 | Finish | 42 |
| 17344 | M6095 | 6 X 18 | 152 X 457 | Finish | 44, 46, 48 |
| 17644 | M7644 | 6 X 18 | 152 X 457 | Channel Finish | 44, 46, 48 |
| 17341 | M7341 | 6 X 18 | 152 X 457 | Flat Finish | 44, 46, 48 |
| 17349 | M7349 | 6 X 23 | 152 X 584 | Finish | 60 |
| 17372 | M7372 | 8 X 10½ | 203 X 267 | Combination | 30 |
| 17230 | M6219 | 8 X 11 | 203 X 279 | Combination | 30 |
| 17236 | M6092 | 8 X 14 | 203 X 356 | Combination | 34, 36 |
| 17536 | M7536 | 8 X 14 | 203 X 356 | Channel Combination | 34, 36 |
| 17342 | M7342 | 8 X 14 | 203 X 356 | Flat Finish Round Corners | 34, 36 |
| 17368 | M7368 | 8 X 16 | 203 X 406 | Combination | 42 |
| 17360 | M7360ELG | 8 X 17¼ | 203 X 451 | Flat Finish Round Corners | 44, 46, 48 |
| 17244 | M6094 | 8 X 18 | 203 X 457 | Combination | 44, 46, 48 |
| 17544 | M7544 | 8 X 18 | 203 X 457 | Channel Combination | 44, 46, 48 |
| 17343 | M7343 | 8 X 18 | 203 X 457 | Flat Finish Round Corners | 44, 46, 48 |
| 17352 | M7352 | 8 X 23 | 203 X 584 | Combination | 60 |
| 17363 | M7363ELG | 8 X 23 | 203 X 584 | Flat Finish Round Corners | 60 |
| 17430 | A4173 | 10 X 11 | 254 X 279 | Float | 30 |
| 17436 | A4172 | 10 X 14 | 254 X 356 | Float | 34, 36 |
| 11040 | A4172LH | 10 X 14 | 254 X 356 | Left-Handed Float | 34, 36 |
| 17444 | A4171 | 10 X 18 | 254 X 457 | Float | 44, 46, 48 |
| 11041 | A4171LH | 10 X 18 | 254 X 457 | Left-Handed Float | 44, 46, 48 |
| 17445 | 17445 | 4 X 2 X 2 | 102 X 51 X 51 | 6 Grit Stone | N/A |

QLT by MARSHALLTOWN

| EDI | Part# | Size-in. | Size-mm | Type | Machine Size |
|-------|-------|----------|---------|--------------|--------------|
| 17446 | 17446 | N/A | N/A | Stone Holder | ≤ 36 |
| 17447 | 17447 | N/A | N/A | Stone Holder | > 36 |

2 stones needed per holder

To order: Phone: 800-888-0127 • Fax: 800-477-6341 • Visit our Website at www.MARSHALLTOWN.com

MADE IN
U.S.A.

CONCRETE TOOLS

Power Trowel Conversion Chart

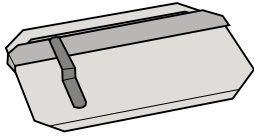

Float

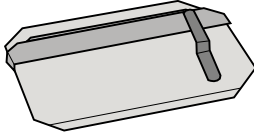

Float Left Handed (Riders Only)

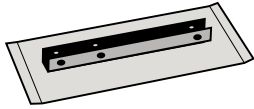

Channel Finish

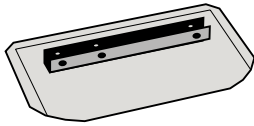

Channel Combination

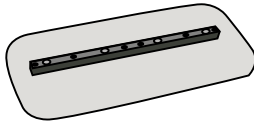

Flat Finish Rounded Corners

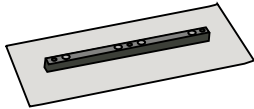

Flat Finish

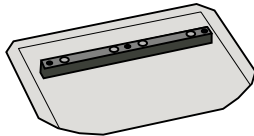

Combination

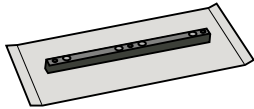

Finish

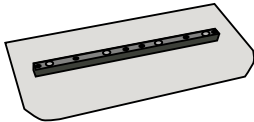

Edger

| Model# | Blade Size | Blade Type | Marshalltown# | Mfr. Part# | Blade Type |
|---|-----------------|-------------|---------------|-----------------|------------|
| ALLEN RAZORBACK | | | | | |
| 436 Edging Walker, Pro 900 Edger | 6 X 14 | Finish | M7345 | 041695 | |
| 436, Pro900, VP436 | 6 X 14 | Finish | M6093 | 015890 | |
| | 8 X 14 | Flat Finish | M7342 | 028779 | |
| | 8 X 14 | Combination | M6092 | 016095 | |
| | 10 X 14 | Float | A4172 | 2822614 | |
| | 10 X 14 | Float-LH | A4172LH | 02822314 | |
| 446, Pro1200, HP100, Super Pro 400, Super Pro 450, HD530, VP446 | 6 X 18 | Finish | M6095 | 015695 | |
| | 8 X 18 | Flat Finish | M7343 | 028489 | |
| | 8 X 18 | Combination | M6094 | 016094 | |
| | 10 X 18 | Float | A4171 | 2822618 | |
| | 10 X 18 | Float-LH | A4171LH | 0822318 | |
| HD550, HD560, Super Pro 500, Super Pro 550 | 6 X 23 | Finish | M7349 | 039831, 039831A | |
| | 8 X 23 | Combination | M7352 | 039846, 039846A | |
| | 8 X 23 | Flat Finish | M7363 | 047973 | |
| 430, 442, Pro 1050, Pro 1059 | 6 X 10 1/2 | Finish | M7371 | 028387 | |
| | 6 X 10 1/2 | Finish | M7373 | - | |
| | 6 X 16 | Finish | M7367 | 034421 | |
| | 10 X 11 | Float | A4173 | - | |
| | 8 X 10 1/2 | Combination | M7372 | 028388 | |
| 8 X 16 | Combination | M7368 | 034422 | | |
| BARTELL | | | | | |
| B430 | 6 X 10 1/2 | Finish | M7371 | 10400 | |
| | 6 X 10 1/2 | Finish | M7373 | - | |
| | 8 X 10 1/2 | Combination | M7372 | 20419 | |
| | 10 X 11 | Float | A4173 | 20406 | |
| B336, B436, B436, B436SD, TS65, TS74, TS78 | 6 X 14 | Finish | M6093 | 20414 | |
| | 6 X 14 | Flat Finish | M7340 | - | |
| | 8 X 14 | Flat Finish | M7342 | - | |
| | 8 X 14 | Combination | M6092 | 20479 | |
| | 10 X 14 | Float | A4172 | 20415 | |
| 10 X 14 | Float-LH | A4172LH | - | | |
| B446, B346, TS88, TS96, TS100, BTR88 | 6 X 18 | Finish | M6095 | 20410 | |
| | 6 X 18 | Flat Finish | M7341 | - | |
| | 8 X 18 | Flat Finish | M7343 | - | |
| | 8 X 18 | Combination | M6094 | 20480 | |
| | 10 X 18 | Float | A4171 | 20411 | |
| 10 X 18 | Float-LH | A4171LH | - | | |
| BOREN | | | | | |
| 36 | 8 X 14 | Combination | M7413 | 1422 | |
| 44 | 8 X 16 | Flat Finish | M7416 | 1418 | |
| | 8 X 16 | Combination | M7414 | 1423 | |
| | 10 1/2 X 17 1/2 | Float | A4176 | 1427 | |
| 48 | 8 X 18 | Combination | M7417 | 1429 | |
| 40hp HD | 8 X 16 | Flat Finish | M7416 | 1418 | |
| | 8 X 16 | Combination | M7414 | 1423 | |
| CEMENTCO-WESTERN | | | | | |
| 3CT-34G3-G4, 3CT-34E3-E4 | 6 X 14 | Finish | M6093 | 3CT-146F | |
| | 6 X 14 | Flat Finish | M7340 | - | |
| | 8 X 14 | Combination | M6092 | 3CT-148C | |
| | 10 X 14 | Float | A4172 | 3CT-148C | |
| 3CT-46G4 | 6 X 18 | Finish | M6095 | 3CT-186F | |
| | 6 X 18 | Flat Finish | M7341 | - | |
| | 8 X 18 | Combination | M6094 | 3CT-188C | |
| | 10 X 18 | Float | A4171 | 3CT-188C | |

| Model# | Blade Size | Blade Type | Marshalltown# | Mfr. Part# | Blade Type |
|--|------------|-------------|---------------|------------|------------|
| CHALLENGE-CLIPPER, EVEREADY-BRIKSAW | | | | | |
| F-34-3-4 | 6 X 14 | Finish | M6093 | 5530065 | |
| | 8 X 14 | Combination | M6092 | 5530064 | |
| | 10 X 14 | Float | A4172 | 5530066 | |
| F-44-3-4 | 6 X 18 | Finish | M6095 | 5530068 | |
| | 8 X 18 | Combination | M6094 | 5530067 | |
| | 10 X 18 | Float | A4171 | 5530069 | |
| CHAMPION DESA, CORBIT NORTHUP | | | | | |
| 360-370-G-G4 | 6 X 14 | Finish | M6093 | 441140 | |
| | 6 X 14 | Finish | M7340 | - | |
| | 8 X 14 | Combination | M6092 | 441128 | |
| | 10 X 14 | Float | A4172 | 441143 | |
| 430-440-G-G4 | 6 X 18 | Finish | M6095 | 441141 | |
| | 6 X 18 | Flat Finish | M7341 | - | |
| | 8 X 18 | Combination | M6094 | 441129 | |
| | 10 X 18 | Float | A4171 | 441144 | |
| DART | | | | | |
| DTF-36 | 6 X 14 | Finish | M6093 | DT-7082 | |
| | 6 X 14 | Finish | M7636 | DT-7083 | |
| | 8 X 14 | Combination | M6092 | DT-7080 | |
| | 8 X 14 | Combination | M7536 | DT-7081 | |
| DTF-46 | 6 X 18 | Finish | M6095 | DT-7087 | |
| | 6 X 18 | Finish | M7644 | DT-7088 | |
| | 8 X 18 | Combination | M6094 | DT-7086 | |
| | 8 X 18 | Combination | M7544 | DT-7085 | |
| 10 X 18 | Float | A4171 | DT-7089 | | |
| EDCO | | | | | |
| WT36 34"-42" | 6 X 14 | Finish | M7407 | F-1 | |
| | 8 X 14 | Combination | M7408 | C-1 | |
| | 10 X 14 | Float | A4174 | M-1 | |
| WT46 44"-48" | 6 X 18 | Finish | M7410 | F-3 | |
| | 8 X 18 | Combination | M7411 | C-3 | |
| | 10 X 18 | Float | A4175 | WED-1018 | |
| ESSICK | | | | | |
| LB34-3-4 | 6 X 14 | Finish | M6093 | LB34-120 | |
| | 6 X 14 | Flat Finish | M7340 | LB34-120 | |
| | 8 X 14 | Combination | M6092 | LB34-107 | |
| | 10 X 14 | Float | A4172 | LB34-121 | |
| LB-46-3-4, HB-46-3 | 6 X 18 | Finish | M6095 | LB46-120 | |
| | 6 X 18 | Flat Finish | M7341 | LB46-120 | |
| | 8 X 18 | Combination | M6094 | LB46-107 | |
| | 10 X 18 | Float | A4171 | LB46-121 | |
| KELLY | | | | | |
| 36OT New | 6 X 14 | Finish | M6093 | 23674 | |
| | 8 X 14 | Combination | M6092 | 23673 | |
| | 10 X 14 | Float | A4172 | 23675 | |
| 46OT | 6 X 18 | Finish | M6095 | 23597 | |
| | 8 X 18 | Combination | M6094 | 23548 | |
| | 10 X 18 | Float | A4171 | 23596 | |

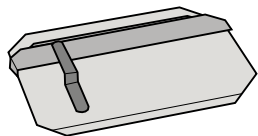

Float

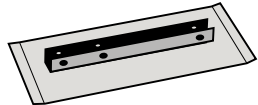

Channel Finish

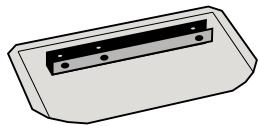

Channel Combination

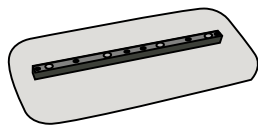

Flat Finish Rounded Corners

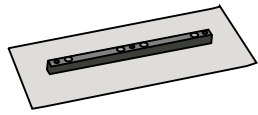

Flat Finish

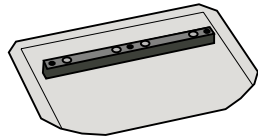

Combination

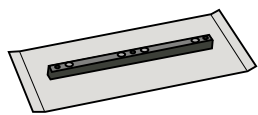

Finish

| Model# | Blade Size | Blade Type | Marshalltown# | Mfr. Part# | Blade Type |
|---|------------|-------------|---------------|------------|------------|
| KRAFT | | | | | |
| 36" | 6 X 14 | Finish | M6093 | SK100 | |
| | 8 X 14 | Combination | M6092 | SK101 | |
| | 10 X 14 | Float | A4172 | SK102 | |
| | 6 X 14 | Finish | M6093ELB | SK100B | |
| | 8 X 14 | Combination | M6092ELB | SK101B | |
| | 6 X 14 | Float | M6093ELG | SK100G | |
| | 8 X 14 | Finish | M6092ELG | SK101G | |
| 44" | 6 X 18 | Finish | M6095 | SK214 | |
| | 8 X 18 | Combination | M6094 | SK215 | |
| | 10 X 18 | Float | A4171 | SK105 | |
| | 6 X 18 | Blue Finish | M6095ELB | SK214B | |
| | 8 X 18 | Blue Comb. | M6094ELB | SK215B | |
| | 6 X 18 | Gold Finish | M6095ELG | SK214G | |
| | 8 X 18 | Gold Comb. | M6094ELG | SK215G | |
| MARSHALLTOWN | | | | | |
| 36E55 | 6 X 14 | Finish | M6093 | - | |
| | 6 X 14 | Flat Finish | M7340 | - | |
| | 8 X 14 | Flat Finish | M7342 | - | |
| | 8 X 14 | Combination | M6092 | - | |
| | 10 X 14 | Float | A4172 | - | |
| 36PE9 | 6 X 14 | Finish | M7345 | - | |
| 46E11, 46E9NH | 6 X 18 | Finish | M6095 | - | |
| | 6 X 18 | Flat Finish | M7341 | - | |
| | 8 X 18 | Flat Finish | M7343 | - | |
| | 8 X 18 | Combination | M6094 | - | |
| 10 X 18 | Float | A4171 | - | | |
| MASTER | | | | | |
| F30, F36B-3, F36B-4 | 10 X 11 | Float | A4173 | - | |
| | 6 X 14 | Finish | M7636 | RT36 | |
| | 8 X 14 | Combination | M7536 | RC36 | |
| F46B-3, F46B-4 | 6 X 18 | Finish | M7644 | 3RT46 | |
| | 8 X 18 | Combination | M7544 | 3RC46 | |
| | 10 X 18 | Float | A4171 | 3FF46 | |
| UT-4 | 6 X 14 | Finish | M7636 | RT36 | |
| | 8 X 14 | Combination | M7536 | RC36 | |
| | 10 X 11 | Float | A4173 | - | |
| MBW | | | | | |
| F36/4, F-78, MK8 90 | 6 X 14 | Finish | M6093 | 5347 | |
| | 6 X 14 | Flat Finish | M7340 | - | |
| | 8 X 14 | Flat Finish | M7342 | - | |
| | 8 X 14 | Combination | M6092 | 5402 | |
| | 10 X 14 | Float | A4172 | 5403 | |
| F46/4, F88, F96, MK8 120, MK8 121 | 6 X 18 | Finish | M6095 | 5383 | |
| | 6 X 18 | Flat Finish | M7341 | - | |
| | 8 X 18 | Flat Finish | M7343 | - | |
| | 8 X 18 | Combination | M6094 | 5412 | |
| | 10 X 18 | Float | A4171 | 5413 | |

| Model# | Blade Size | Blade Type | Marshalltown# | Mfr. Part# | Blade Type |
|-------------------------------|------------|-------------|---------------|------------|------------|
| MORRISON | | | | | |
| 36" Walk-behind | 6 X 14 | Finish | M6093 | - | |
| | 6 X 14 | Flat Finish | M7340 | - | |
| | 8 X 14 | Flat Finish | M7342 | - | |
| | 8 X 14 | Combination | M6092 | - | |
| | 10 X 14 | Float | A4172 | - | |
| 46" Walk-behind | 6 X 18 | Finish | M6095 | - | |
| | 6 X 18 | Flat Finish | M7341 | - | |
| | 8 X 18 | Flat Finish | M7343 | - | |
| | 10 X 18 | Float | A4171 | - | |
| MULLER | | | | | |
| 36-3-G-4 & E | 8 X 14 | Combination | M6092 | G1951 | |
| 46-3-G-4 & E | 10 X 18 | Float | A4171 | G722B | |
| REMINGTON MALL | | | | | |
| T-34, T434, T-334A, T-434A | 10 X 14 | Float | A4172 | G722B | |
| RHIN-O-TUFF | | | | | |
| RE35H5 | 6 X 14 | Finish | M7345 | - | |
| R36H5, R36H8 | 6 X 14 | Finish | M6093 | - | |
| | 6 X 14 | Flat Finish | M7340 | - | |
| | 8 X 14 | Flat Finish | M7342 | - | |
| | 8 X 14 | Combination | M6092 | - | |
| | 10 X 14 | Float | A4172 | - | |
| R46H9 | 6 X 18 | Finish | M6095 | - | |
| | 6 X 18 | Flat Finish | M7341 | - | |
| | 8 X 18 | Flat Finish | M7343 | - | |
| | 8 X 18 | Combination | M6094 | - | |
| | 10 X 18 | Float | A4171 | - | |
| SKIL POWER TROWELS | | | | | |
| PT4-48 | 6 X 18 | Finish | M6095 | 58177 | |
| | 8 X 18 | Combination | M6094 | 58176 | |
| STONE | | | | | |
| 30-3-1, E-4 | 6 X 11 | Finish | M6096 | 34576 | |
| | 8 X 11 | Combination | M6219 | 34581 | |
| | 10 X 11 | Float | A4173 | 34591 | |
| CF364, T-36 | 6 X 14 | Finish | M6093 | 34578 | |
| | 6 X 14 | Flat Finish | M7340 | 34578 | |
| | 8 X 14 | Combination | M6092 | 34583 | |
| | 10 X 14 | Float | A4172 | 34586 | |
| CF464, T-46, HDP484 | 6 X 18 | Finish | M6095 | 34580 | |
| | 6 X 18 | Flat Finish | M7341 | 34580 | |
| | 8 X 18 | Combination | M6094 | 34585 | |

Continued on next page.

CONCRETE TOOLS

Power Trowel Conversion Chart

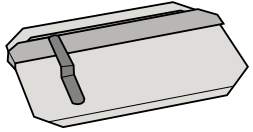

Float

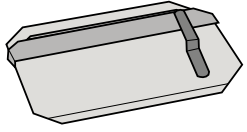

Float Left Handed (Riders Only)

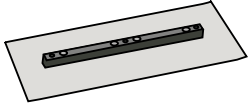

Flat Finish

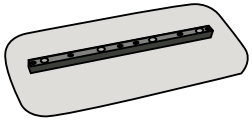

Flat Finish Rounded Corners

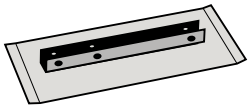

Channel Finish

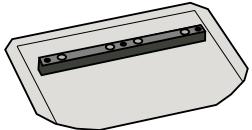

Combination

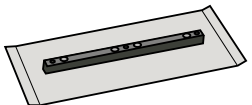

Finish

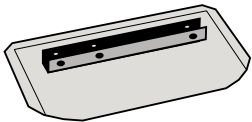

Channel Combination

| Model# | Blade Size | Blade Type | Marshalltown# | Mfr. Part# | Blade Type |
|--|-----------------|-------------|---------------|------------|------------|
| STOW | | | | | |
| SCT30 | 6 X 11 | Finish | M6096 | - | |
| | 8 X 11 | Combination | M6219 | - | |
| | 10 X 11 | Float | A4173 | - | |
| SCT36 | 6 X 14 | Finish | M6093 | 22027-501 | |
| | 6 X 14 | Flat Finish | M7340 | - | |
| | 8 X 14 | Flat Finish | M7342 | - | |
| | 8 X 14 | Combination | M6092 | 22029-501 | |
| | 10 X 14 | Float | A4172 | 22028-501 | |
| SCT46 | 6 X 18 | Finish | M6095 | 21637-501 | |
| | 6 X 18 | Flat Finish | M7341 | - | |
| | 8 X 18 | Flat Finish | M7343 | - | |
| | 8 X 18 | Combination | M6094 | 21989-501 | |
| | 10 X 18 | Float | A4171 | 21989-501 | |
| SUPERIOR, SOFF-CUT, HUSQVARNA | | | | | |
| T-36 | 8 X 14 | Combination | M6092 | - | |
| | 8 X 14 | Combination | M7413 | 2836FL | |
| EX-36, GH-36, DGH-36, CR-36 | 8 X 14 | Combination | M7413 | 2836FL | |
| | 8 X 18 | Combination | M6094 | - | |
| TR-48 | 8 X 18 | Combination | M7417 | 2848FL | |
| | 8 X 18 | Combination | M7417 | 2848FL | |
| GH-44, DGH-44, CR-44 | 8 X 16 | Flat Finish | M7416 | 2844C | |
| | 8 X 16 | Combination | M7414 | 2844FL | |
| | 10 1/2 X 17 1/2 | Float | A4176 | - | |
| GH-48, DGH-48, CR-48 | 8 X 18 | Combination | M7417 | 2848FL | |
| | 8 X 16 | Finish | M7416 | 2844C | |
| Rocket Rider, RTR100 | 8 X 16 | Combination | M7414 | 2844FL | |
| WACKER | | | | | |
| CT30, CT36, CRT36ASO, CRT36ASN, CRT36-23K-H, CRT36-24A-H | 10 X 11 | Float | A4173 | 110574 | |
| | 6 X 14 | Finish | M6093 | 79638 | |
| | 6 X 14 | Flat Finish | M7340 | - | |
| | 8 X 14 | Flat Finish | M7342 | - | |
| | 8 X 14 | Combination | M6092 | 79637 | |
| | 10 X 14 | Float | A4172 | 75061 | |
| | 10 X 14 | Float-LH | A4172LH | - | |
| | 6 X 18 | Finish | M6095 | 79642 | |
| CT48, CRT46ASO, CRT46KHO, CRT46KHN, CRT48-25K-H8L, CRT48-31V-H | 6 X 18 | Flat Finish | M7341 | - | |
| | 8 X 18 | Flat Finish | M7343 | - | |
| | 8 X 18 | Combination | M6094 | 79641 | |
| | 10 X 18 | Float | A4171 | 112000 | |
| | 10 X 18 | Float-LH | A4171LH | - | |

| Model# | Blade Size | Blade Type | Marshalltown# | Mfr. Part# | Blade Type | |
|--|------------|-------------|---------------|--------------|--------------|--|
| WAGMAN | | | | | | |
| 30" | 6 X 11 | Finish | M6096 | WX-611F | | |
| | 8 X 11 | Combination | M6219 | WX-8110 | | |
| | 9 X 11 | Float | A4173 | WX-911FO | | |
| 36" | 6 X 14 | Finish | M6093 | WX-614F | | |
| | 6 X 14 | Flat Finish | M7340 | WX-614F FLAT | | |
| | 6 X 13 | Finish | M7636 | WM-61325CH | | |
| | 8 X 14 | Flat Finish | M7342 | WX-814F | | |
| | 8 X 14 | Combination | M6092 | WX-8140 | | |
| | 8 X 14 | Combination | M7536 | WX-8140CH | | |
| | 10 X 14 | Float | A4172 | WX-1014FO | | |
| | 10 X 14 | Float-LH | A4172LH | WX-1014LH | | |
| | 48" | 6 X 18 | Finish | M6095 | WX-618F | |
| | | 6 X 18 | Flat Finish | M7341 | WX-618F FLAT | |
| 6 X 18 | | Finish | M7644 | WM-618CH | | |
| 8 X 18 | | Flat Finish | M7343 | WX-818F | | |
| 8 X 18 | | Combination | M6094 | WX-8180 | | |
| 8 X 18 | | Combination | M7544 | WX-8180CH | | |
| 10 X 18 | | Float | A4171 | WX-1018HD | | |
| 10 X 18 | | Float-LH | A4171LH | WX-1018LHHD | | |
| WHITEMAN | | | | | | |
| M Series 30" | 10 X 11 | Float | A4173 | - | | |
| J Series 34" J Series 36" HP Series 36" JTN 36" JWN 36" JTO 36" | 6 X 14 | Finish | M6093 | F-900 | | |
| | 6 X 14 | Flat Finish | M7340 | F-901 | | |
| | 8 X 14 | Flat Finish | M7342 | - | | |
| | 8 X 14 | Combination | M6092 | C-844 | | |
| | 10 X 14 | Float | A4172 | CL-954F | | |
| | 10 X 14 | Float-LH | A4172LH | - | | |
| B Series 46" HP Series 46" HD Series 48" BTO 46" H Series 46" | 6 X 18 | Finish | M6095 | F-400 | | |
| | 6 X 18 | Flat Finish | M7341 | F-0401 | | |
| | 8 X 18 | Flat Finish | M7343 | RC818 | | |
| | 8 X 18 | Combination | M6094 | C-464 | | |
| | 10 X 18 | Float | A4171 | CL-444F | | |
| | 10 X 18 | Float-LH | A4171LH | - | | |
| STX | 6 X 23 | Finish | M7349 | F11990 | | |
| | 8 X 23 | Flat Finish | M7363ELG | - | | |
| | 8 X 23 | Combination | M7352 | C11997 | | |
| Channel Mount Blades | 6 X 14 | Finish | M7636 | 1872 | | |
| | 8 X 14 | Combination | M7536 | 1871 | | |
| | 6 X 18 | Finish | M7644 | 1874 | | |
| | 8 X 18 | Combination | M7544 | 1873 | | |

Power Trowel Blade Pins

- For channel type mounting blades
- Sold 1 pair per inner pack/1 pair per outer pack



MADE IN
U.S.A.

MARSHALLTOWN The Premier Line

| EDI | Part# | Size-in. | Size-mm |
|-------|-------|----------|---------|
| 17710 | M7710 | 3½ | 89 |

Rub Bricks

- Fluted silicon carbide stone 20-grit
- Ideal for dressing down and removing form marks from concrete
- Sold 1 per inner pack/5 per outer pack



MADE IN
U.S.A.

MARSHALLTOWN The Premier Line

| EDI | Part# | Size-in. | Size-mm |
|-------|-------|-------------|---------------|
| 16440 | 840 | 6 X 3 X 1 | 152 X 76 X 25 |
| 16441 | 841 | 8 X 3½ X 1½ | 203 X 89 X 38 |

Rub Bricks

- Fluted 20-grit silicon carbide surface
- Ideal for dressing down and removing marks from concrete or cleaning brick
- Sold 1 per inner pack/5 per outer pack



QLT^{BY} MARSHALLTOWN

| EDI | Part# | Size-in. | Size-mm |
|-------|-------|-------------|---------------|
| 16192 | RB192 | 6 X 3 X 1 | 152 X 76 X 25 |
| 16194 | RB194 | 8 X 3½ X 1½ | 203 X 89 X 38 |

Concrete Chisels

- Forged from tool steel, then tempered to correct final hardness
- Blade is formed to start easier, cut faster and last longer
- Used for cutting and breaking up concrete
- **WARNING:** Always wear eye protection when using this tool
- Sold 10 per inner pack/10 per outer pack

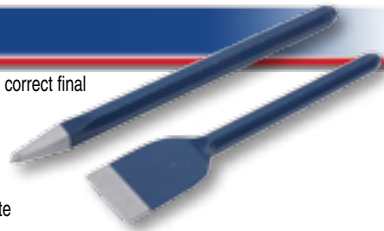

MARSHALLTOWN The Premier Line

| EDI | Part# | Description | Size-in. | Size-mm |
|-------|-------|-------------------|----------|----------|
| 16611 | 651 | Bull Point Chisel | 12 X ¾ | 305 X 19 |
| 16620 | 660 | Concrete Chisel | 10 X 2 | 254 X 51 |
| 16621 | 661 | Concrete Chisel | 10 X 2½ | 254 X 64 |

Floor Scrapers

- Blade is made of heavy gauge spring steel
- Plastic grip on handle to protect hands
- For more details and size options see pages 221-223

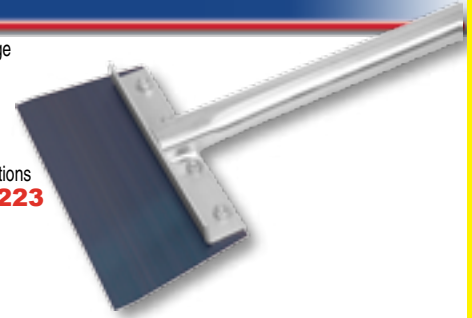

Concrete Apprentice Tool Kit

- Tools included:
NB202 - Nylon Tool Bag
MXS64D - 14 X 4" (356 x 102mm) Finishing Trowel
145D - 16 X 3½" (406 X 79mm) Magnesium Hand Float
180D - 6 X 3" (152 X 76mm) SS Concrete Groover, ½" (13mm) Groove
136D - 6 X 3" (152 X 76mm) Curved End Edger, ¾" (10mm) Radius
44D - 12 X 5" (305 X 127mm) Wood Float
52D - 5 X 2" (127 X 51mm) Margin Trowel
 Sold 1 per inner pack/1 per outer pack



MADE IN
U.S.A.

MARSHALLTOWN The Premier Line

| EDI | Part# | Size-in. | Size-mm |
|-------|-------|----------|---------|
| 16205 | CTK3 | N/A | N/A |

Concrete Apprentice Tool Kit

- Tools included:
831 - Canvas Tool Bag **MXS64D** - 14 X 4" (356 x 102mm) Finishing Trowel
145D - 16 X 3½" (406 X 79mm) Magnesium Hand Float
180D - 6 X 3" (152 X 76mm) SS Concrete Groover, ½" (13mm) Groove
136D - 6 X 3" (152 X 76mm) Curved End Edger, ¾" (10mm) Radius
44D - 12 X 5" (305 X 127mm) Wood Float
52D - 5 X 2" (127 X 51mm) Margin Trowel
 Sold 1 per inner pack/1 per outer pack



MADE IN
U.S.A.

MARSHALLTOWN The Premier Line

| EDI | Part# | Size-in. | Size-mm |
|-------|-------|----------|---------|
| 15902 | CTK2 | N/A | N/A |



Decorative CONCRETE

*Welcome to a world of
sophistication
and
creativity.*

At **MARSHALLTOWN** we pride ourselves on offering the largest selection of innovative products with the highest standard of quality.

MARSHALLTOWN decorative concrete products continue that tradition.

The decorative concrete offering includes all the essentials for your next masterpiece. Let your imagination be your guide and an endless sea of concrete be your canvas. Step off the beaten path and embark on an adventure with **MARSHALLTOWN** into the world of decorative concrete. With **MARSHALLTOWN** at your side, your next creation is right around the bend.



MARSHALLTOWN
The Premier Line

Ashlar Slate

- Simple, yet sophisticated, nice in a variety of settings
- Grout lines are 1/2" (13mm) deep
- Sold 1 per inner pack/1 per outer pack

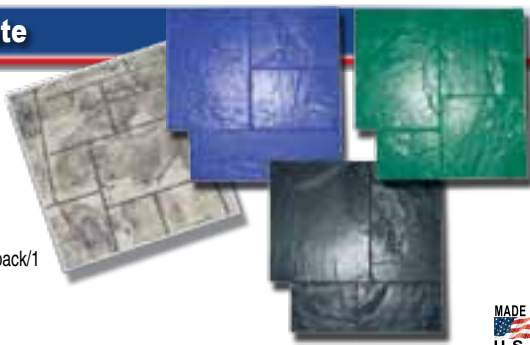

MADE IN
U.S.A

MARSHALLTOWN The Premier Line

| EDI | Part# | Description | Size-in. | Size-mm |
|-------|----------|-------------|----------|-----------|
| 18090 | ASBLUE | Blue | 24 X 24 | 610 X 610 |
| 18091 | ASBLUEF | Blue Flex | 24 X 24 | 610 X 610 |
| 18092 | ASGREEN | Green | 24 X 24 | 610 X 610 |
| 18093 | ASGREENF | Green Flex | 24 X 24 | 610 X 610 |
| 18094 | ASBLACK | Black | 24 X 24 | 610 X 610 |
| 18095 | ASBLACKF | Black Flex | 24 X 24 | 610 X 610 |

Cottage Slate

- Mix and match mats for desired look
- Grout lines are 1/4" (6mm) deep
- Sold 1 per inner pack/1 per outer pack

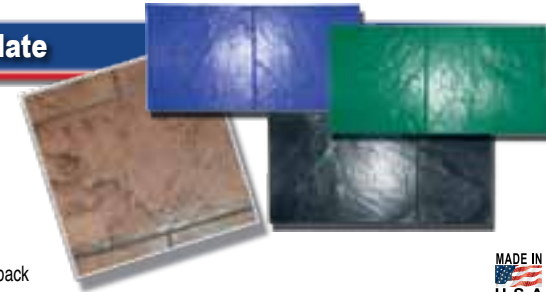

MADE IN
U.S.A

MARSHALLTOWN The Premier Line

| EDI | Part# | Description | Size-in. | Size-mm |
|-------|----------|-------------|----------|-----------|
| 18285 | CSBLUE | Blue | 18 X 36 | 457 X 914 |
| 18286 | CSBLUEF | Blue Flex | 18 X 36 | 457 X 914 |
| 18287 | CSGREEN | Green | 18 X 36 | 457 X 914 |
| 18288 | CSGREENF | Green Flex | 18 X 36 | 457 X 914 |
| 18289 | CSBLACK | Black | 18 X 36 | 457 X 914 |
| 18290 | CSBLACKF | Black Flex | 18 X 36 | 457 X 914 |

Slate 12 X 12

- Accurately reproduces the look of natural slate
- Grout lines are 1/4" (6mm) deep
- Sold 1 per inner pack/1 per outer pack



MADE IN
U.S.A

MARSHALLTOWN The Premier Line

| EDI | Part# | Description | Size-in. | Size-mm |
|-------|----------|-------------|----------|-----------|
| 18102 | SLATE12 | Standard | 24 X 24 | 610 X 610 |
| 18103 | SLATE12F | Flex | 24 X 24 | 610 X 610 |

Majestic Ashlar

- Similar to Ashlar Slate pattern, with larger stones
- Grout lines are 1/2" (13mm) deep
- Sold 1 per inner pack/1 per outer pack

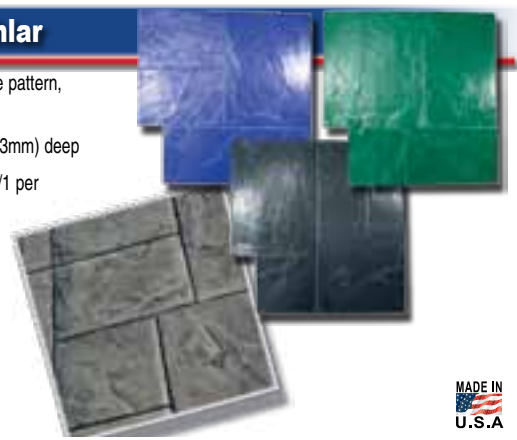

MADE IN
U.S.A

MARSHALLTOWN The Premier Line

| EDI | Part# | Description | Size-in. | Size-mm |
|-------|----------|-------------|----------|-----------|
| 18096 | MABBLUE | Blue | 36 X 36 | 914 X 914 |
| 18097 | MABBLUEF | Blue Flex | 36 X 36 | 914 X 914 |
| 18098 | MAGREEN | Green | 36 X 36 | 914 X 914 |
| 18099 | MAGREENF | Green Flex | 36 X 36 | 914 X 914 |
| 18100 | MABLACK | Black | 36 X 36 | 914 X 914 |
| 18101 | MABLACKF | Black Flex | 36 X 36 | 914 X 914 |

Slate 6 X 6

- Accurately reproduces the look of natural slate
- Grout lines are 1/8"-1/4" (3mm-6mm) deep
- Sold 1 per inner pack/1 per outer pack



MADE IN
U.S.A

MARSHALLTOWN The Premier Line

| EDI | Part# | Description | Size-in. | Size-mm |
|-------|---------|-------------|----------|-----------|
| 18104 | SLATE6 | Standard | 24 X 36 | 610 X 914 |
| 18105 | SLATE6F | Flex | 24 X 36 | 610 X 914 |

Cobblestone

- Gives an "Old World" look to your hardscapes
- Grout lines are 1/2" (13mm) deep
- Sold 1 per inner pack/1 per outer pack

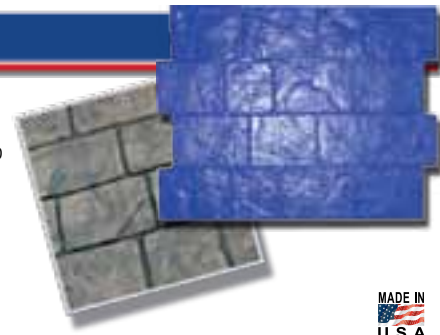

MADE IN
U.S.A

MARSHALLTOWN The Premier Line

| EDI | Part# | Description | Size-in. | Size-mm |
|-------|---------|-------------|-----------------|-----------|
| 18106 | COBBLE | Standard | 22 3/4 X 29 3/4 | 578 X 756 |
| 18107 | COBBLEF | Flex | 22 3/4 X 29 3/4 | 578 X 756 |

Mayan Cobblestone

- Molded using select stones for a beautiful, natural look
- Grout lines are 1/2" (13mm) deep
- Sold 1 per inner pack/1 per outer pack

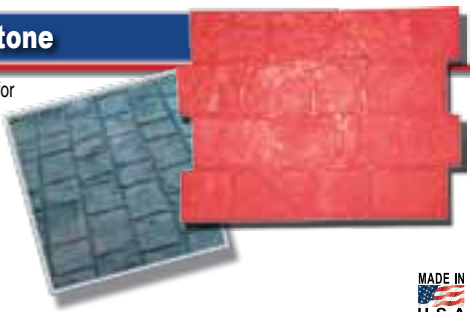

MADE IN
U.S.A

MARSHALLTOWN The Premier Line

| EDI | Part# | Description | Size-in. | Size-mm |
|-------|---------|-------------|----------|-----------|
| 18108 | MACOBB | Standard | 32 X 24 | 813 X 610 |
| 18109 | MACOBBF | Flex | 32 X 24 | 813 X 610 |

Verona Cobblestone

- Accurately reproduces the look of cobblestone
- Grout lines are 1/4" (6mm) deep
- Sold 1 per inner pack/1 per outer pack



MADE IN
U.S.A

MARSHALLTOWN The Premier Line

| EDI | Part# | Description | Size-in. | Size-mm |
|-------|----------|-------------|----------|-------------|
| 17989 | VERCOBB | Standard | 45 X 45 | 1143 X 1143 |
| 17990 | VERCOBBF | Flex | 45 X 45 | 1143 X 1143 |

Large Stone Fan

- Grout lines are 1/2" (13mm) deep
- Sold 1 per inner pack/1 per outer pack

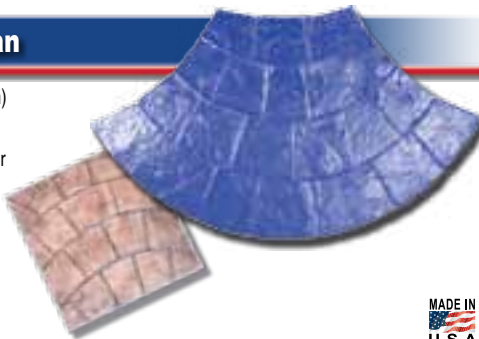

MADE IN
U.S.A

MARSHALLTOWN The Premier Line

| EDI | Part# | Description | Size-in. | Size-mm |
|-------|----------|-------------|----------|------------|
| 18110 | LGSTFAN | Standard | 46 X 26 | 1168 X 660 |
| 18111 | LGSTFANF | Flex | 46 X 26 | 1168 X 660 |

Mayan Circle

- Produces cobblestone in a circle formation
- 15' diameter circles require MACIR5, MACIR10 and MACIR15
- 10' diameter circles require MACIR15 and MARCIR10
- 5' diameter circles only require MACIR5
- Grout lines are 1/4"-3/8" (6mm-10mm) deep
- Sold 1 per inner pack/1 per outer pack



NEW!

MADE IN
U.S.A

MARSHALLTOWN The Premier Line

| EDI | Part# | Description | Dia.-ft. | Dia.-M |
|-------|---------|-------------|----------|--------|
| 18958 | MACIR5 | Black | 5 | 1.52 |
| 18959 | MACIR10 | Green | 10 | 3.04 |
| 18960 | MACIR15 | Blue | 15 | 4.57 |

Tetra Stone

- Accurately reproduces the look of tetra stone
- Grout lines are 1/4" (6mm) deep
- Sold 1 per inner pack/1 per outer pack



MADE IN
U.S.A

MARSHALLTOWN The Premier Line

| EDI | Part# | Description | Size-in. | Size-mm |
|-------|--------|-------------|-------------|------------|
| 17987 | TETRA | Standard | 29 1/2 X 59 | 750 X 1499 |
| 17988 | TETRAF | Flex | 29 1/2 X 59 | 750 X 1499 |

Fieldstone

- Natural look and randomness gives the feel of fieldstones carefully arranged together
- Grout lines are 1/4"-1/2" (6mm-13mm) deep
- Sold 1 per inner pack/1 per outer pack



MADE IN
U.S.A

MARSHALLTOWN The Premier Line

| EDI | Part# | Description | Size-in. | Size-mm |
|-------|----------|-------------|----------|---------|
| 18078 | FSBLUE | Blue | 32 X 32 | 813 |
| 18079 | FSBLUEF | Blue Flex | 32 X 32 | 813 |
| 18080 | FSGREEN | Green | 32 X 32 | 813 |
| 18081 | FSGREENF | Green Flex | 32 X 32 | 813 |
| 18082 | FSBLACK | Black | 32 X 32 | 813 |
| 18083 | FSBLACKF | Black Flex | 32 X 32 | 813 |

Orchard Stone

- Random cut design with large stones
- Grout lines are 1/4"-1/2" (6mm-13mm) deep
- Sold 1 per inner pack/1 per outer pack

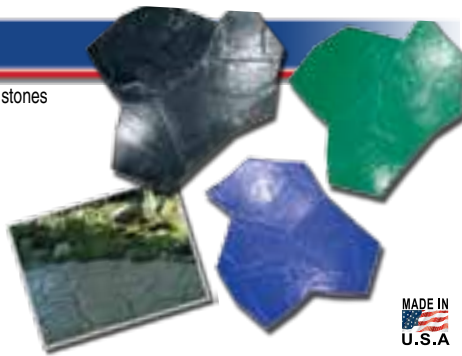

MADE IN U.S.A.

MARSHALLTOWN The Premier Line

| EDI | Part# | Description | Size-in. | Size-mm |
|-------|----------|-------------|----------|-------------|
| 18084 | OSBLUE | Blue | 46 X 50 | 1168 X 1270 |
| 18085 | OSBLUEF | Blue Flex | 46 X 50 | 1168 X 1270 |
| 18086 | OSGREEN | Green | 46 X 50 | 1168 X 1270 |
| 18087 | OSGREENF | Green Flex | 46 X 50 | 1168 X 1270 |
| 18088 | OSBLACK | Black | 46 X 50 | 1168 X 1270 |
| 18089 | OSBLACKF | Black Flex | 46 X 50 | 1168 X 1270 |

Colorado Flagstone

- Achieve the look of Colorado Flagstone
- Grout lines are 1/2" (13mm) deep
- Sold 1 per inner pack/1 per outer pack



MADE IN U.S.A.

MARSHALLTOWN The Premier Line

| EDI | Part# | Description | Size-in. | Size-mm |
|-------|---------|-------------|-------------|------------|
| 17985 | COFLAG | Standard | 24 X 59 1/2 | 610 X 1512 |
| 17986 | COFLAGF | Flex | 24 X 59 1/2 | 610 X 1512 |

Bluestone

- Replicates natural Bluestone
- Can be arranged in a running bond, stacked bond or basketweave pattern
- Grout lines are 1/8" (3mm) deep
- Sold 1 per inner pack/1 per outer pack

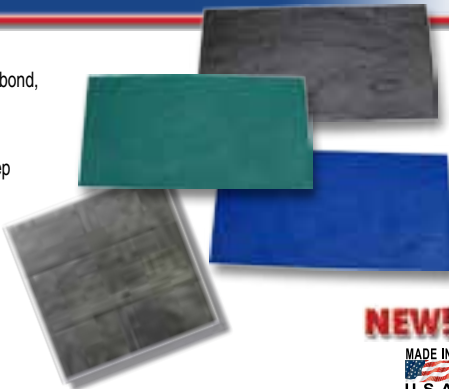

NEW!

MADE IN U.S.A.

MARSHALLTOWN The Premier Line

| EDI | Part# | Description | Size-in. | Size-mm |
|-------|----------|-------------|----------|-----------|
| 18982 | BSBLACK | Black | 18 X 36 | 457 X 914 |
| 18983 | BSBLACKF | Black Flex | 18 X 36 | 457 X 914 |
| 18984 | BSBLUE | Blue | 18 X 36 | 457 X 914 |
| 18985 | BSBLUEF | Blue Flex | 18 X 36 | 457 X 914 |
| 18986 | BSGREEN | Green | 18 X 36 | 457 X 914 |
| 18987 | BSGREENF | Green Flex | 18 X 36 | 457 X 914 |

New Basketweave Brick

- A stylish update of the traditional brick pattern
- Grout lines are 1/2" (13mm) deep
- Sold 1 per inner pack/1 per outer pack

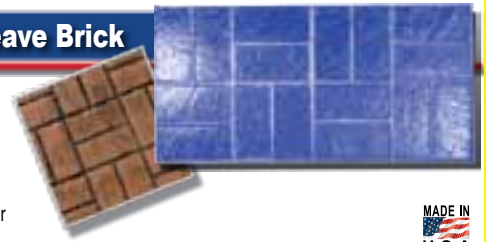

MADE IN U.S.A.

MARSHALLTOWN The Premier Line

| EDI | Part# | Description | Size-in. | Size-mm |
|-------|----------|-------------|-----------------|-----------|
| 18114 | BWBRICK | Standard | 30 1/2 X 15 1/2 | 775 X 394 |
| 18115 | BWBRICKF | Flex | 30 1/2 X 15 1/2 | 775 X 394 |

New Herringbone Brick

- Sleek, sophisticated style interlocks bricks at a 90° angle for a tight, compact look
- Grout lines are 1/4"-1/2" (6mm-13mm)
- Sold 1 per inner pack/1 per outer pack

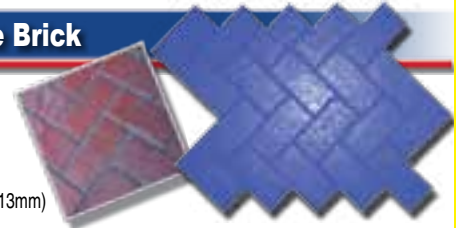

MADE IN U.S.A.

MARSHALLTOWN The Premier Line

| EDI | Part# | Description | Size-in. | Size-mm |
|-------|----------|-------------|-------------|-----------|
| 18112 | HERRBRK | Standard | 37 X 25 1/2 | 940 X 648 |
| 18113 | HERRBRKF | Flex | 37 X 25 1/2 | 940 X 648 |

Soldier Course Brick

- Produces a border to the edge of concrete slabs
- Old Chicago has a grout depth of 1/2" (13mm), New Brick 3/8"-1/2" (10mm-12mm), and Pennsylvania 1/2" (13mm)
- Sold 1 per inner pack/1 per outer pack



MADE IN U.S.A.

MARSHALLTOWN The Premier Line

| EDI | Part# | Description | Size-in. | Size-mm |
|-------|---------|-------------------------------|---------------|-----------|
| 18122 | CHSCB | Old Chicago | 31 X 9 1/2 | 787 X 241 |
| 18123 | CHSCBF | Old Chicago Flex | 31 X 9 1/2 | 787 X 241 |
| 17983 | OSCCOR | Old Chicago Finishing Corner | 9 1/2 X 9 1/2 | 241 X 241 |
| 18229 | NBSC | New Brick | 29 X 8 1/2 | 737 X 216 |
| 18231 | NBSCF | New Brick Flex | 29 X 8 1/2 | 737 X 216 |
| 17982 | NBSCCOR | New Brick Finishing Corner | 8 1/2 X 8 1/2 | 216 X 216 |
| 18237 | PABSC | Pennsylvania | 28 X 8 1/2 | 711 X 216 |
| 18240 | PABSCF | Pennsylvania Flex | 28 X 8 1/2 | 711 X 216 |
| 17984 | PASCCOR | Pennsylvania Finishing Corner | 8 1/2 X 8 1/2 | 216 X 216 |

Old Chicago Running Bond Brick

- Replicated to take on the look of worn brick pavers
- Grout lines are 1/2" (6mm-13mm) deep
- Sold 1 per inner pack/1 per outer pack



MADE IN
U.S.A

MARSHALLTOWN The Premier Line

| EDI | Part# | Description | Size-in. | Size-mm |
|-------|--------|-------------|----------------|-----------|
| 18116 | CHRBB | Standard | 30 3/4 X 2 1/2 | 781 X 546 |
| 18117 | CHRBBF | Flex | 30 3/4 X 2 1/2 | 781 X 546 |

Pennsylvania Avenue Brick

- Ideal for sidewalks, driveways and patios
- Grout lines are 1/4" (6mm) deep
- Sold 1 per inner pack/1 per outer pack



MADE IN
U.S.A

MARSHALLTOWN The Premier Line

| EDI | Part# | Description | Size-in. | Size-mm |
|-------|--------|-------------|-----------------|-----------|
| 18118 | PABRK | Standard | 34 1/2 X 20 1/2 | 876 X 521 |
| 18119 | PABRKF | Flex | 34 1/2 X 20 1/2 | 876 X 521 |

Pennsylvania Herringbone Brick

- Made with the same brick as our Old Chicago design with narrower grout lines
- Grout lines are 1/4"-3/8" (6mm-10mm) deep
- Sold 1 per inner pack/1 per outer pack

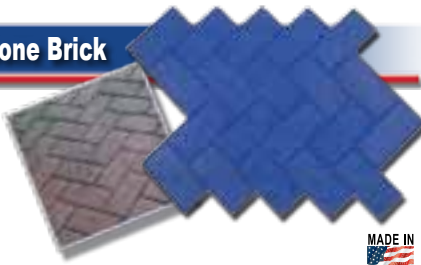

MADE IN
U.S.A

MARSHALLTOWN The Premier Line

| EDI | Part# | Description | Size-in. | Size-mm |
|-------|---------|-------------|-------------|-----------|
| 18120 | PAHBRK | Standard | 39 X 26 1/4 | 991 X 667 |
| 18121 | PAHBRKF | Flex | 39 X 26 1/4 | 991 X 667 |

New Brick Texture Skin

- Used with the New Herringbone and New Basketweave brick pattern stamps
- Sold 1 per inner pack/1 per outer pack



MADE IN
U.S.A

MARSHALLTOWN The Premier Line

| EDI | Part# | Size-in. | Size-mm |
|-------|--------|----------|-----------|
| 18228 | NBRT18 | 18 X 18 | 457 X 457 |

12" Wood Plank

- Achieve the look of finished wood with the durability of concrete
- Grout lines are 1/8"-1/4" (3-6mm) deep
- New items shown in table in red
- Sold 1 per inner pack/1 per outer pack



MADE IN
U.S.A

MARSHALLTOWN The Premier Line

| EDI | Part# | Description | Size-in. | Size-mm |
|-------|-------|---------------|----------|------------|
| 18128 | WP16 | Standard | 12 X 16 | 305 X 406 |
| 18129 | WP16F | Flex | 12 X 16 | 305 X 406 |
| 18130 | WP32 | Standard | 12 X 32 | 305 X 813 |
| 18131 | WP32F | Flex | 12 X 32 | 305 X 813 |
| 18132 | WP48 | Standard | 12 X 48 | 305 X 1219 |
| 18133 | WP48F | Flex | 12 X 48 | 305 X 1219 |
| 18134 | WP64 | Standard | 12 X 64 | 305 X 1626 |
| 18135 | WP64F | Flex | 12 X 64 | 305 X 1626 |
| 18136 | WP80 | Standard | 12 X 80 | 305 X 2032 |
| 18137 | WP80F | Flex | 12 X 80 | 305 X 2032 |
| 18138 | WP96 | Standard | 12 X 96 | 305 X 2438 |
| 18139 | WP96F | Flex | 12 X 96 | 305 X 2438 |
| 18990 | WP12T | Touch Up Skin | 11 X 47 | 279 X 1194 |

6" Wood Plank

- Achieve the look of finished wood with the durability of concrete
- Grout lines are 1/8" (3mm) deep
- Sold 1 per inner pack/1 per outer pack



NEW!

MADE IN
U.S.A

MARSHALLTOWN The Premier Line

| EDI | Part# | Description | Size-in. | Size-mm |
|-------|----------|-------------------|------------|------------|
| 18934 | 6WPBLACK | Black | 18 X 72 | 457 X 1829 |
| 18935 | 6WPBLUE | Blue | 18 X 72 | 457 X 1829 |
| 18936 | 6WPFLEXY | Y Flex | 18 X 18 | 457 X 457 |
| 18937 | 6WPFLEXX | X Flex | 18 X 18 | 457 X 457 |
| 18938 | 6WPSGL | Single Plank Flex | 23 X 6 | 584 X 152 |
| 18939 | 6WPSKIN | Touch Up Skin | 6 X 22 1/2 | 152 X 572 |

Hardwood Planks

- Accurately reproduces the look of hardwood
- Grout lines are 1/8" (3mm) deep
- Sold 1 per inner pack/1 per outer pack

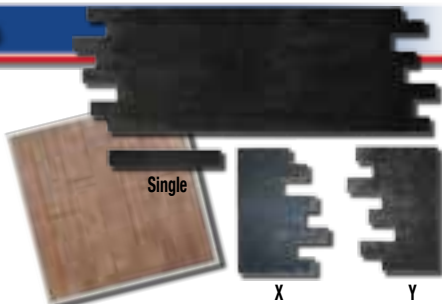

MADE IN
U.S.A

MARSHALLTOWN The Premier Line

| EDI | Part# | Description | Size-in. | Size-mm |
|-------|------------|-------------|----------------|------------|
| 17991 | HWPLANK | Standard | 72 X 28 | 1829 X 711 |
| 17992 | HWPLANKSGL | Single Flex | 3 1/4 X 23 1/2 | 82 X 590 |
| 17993 | HWPLANKX | "X" Flex | 21 X 28 | 533 X 711 |
| 17994 | HWPLANKY | "Y" Flex | 21 X 28 | 533 X 711 |

Chiseled Slate

- Easily create the look of a large slab of slate
- **CHSLT48** comes with handles for easier stamping
- Sold 1 per inner pack/1 per outer pack

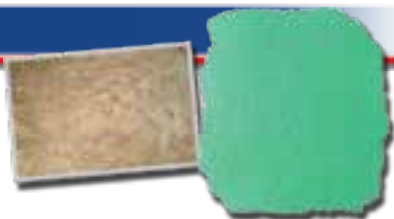

MADE IN
U.S.A

MARSHALLTOWN The Premier Line

| EDI | Part# | Size-in. | Size-mm |
|-------|---------|----------|-------------|
| 18140 | CHSLT18 | 18 X 18 | 457 X 457 |
| 18141 | CHSLT48 | 48 X 48 | 1219 X 1219 |

Heavy Stone

- Used as stamping mats to create the look of large stone slabs
- **HVYSTN48** comes with handles for easier stamping
- Sold 1 per inner pack/1 per outer pack



MADE IN
U.S.A

MARSHALLTOWN The Premier Line

| EDI | Part# | Size-in. | Size-mm |
|-------|----------|----------|-------------|
| 18124 | HVYSTN18 | 18 X 18 | 457 X 457 |
| 18125 | HVYSTN48 | 48 X 48 | 1219 X 1219 |

Bluestone

- Replicates natural Bluestone
- **18989** comes with handles for easier stamping
- Sold 1 per inner pack/1 per outer pack



NEW!

MADE IN
U.S.A

MARSHALLTOWN The Premier Line

| EDI | Part# | Description | Size-in. | Size-mm |
|-------|-------|------------------|----------|-------------|
| 18988 | 18988 | Touch Up Skin | 18 X 18 | 457 X 457 |
| 18989 | 18989 | Seamless Texture | 48 X 48 | 1219 X 1219 |

Italian Slate

- Used as stamping mats to create the look of large stone slabs
- **ITSLAT48** comes with handles for easier stamping
- Sold 1 per inner pack/1 per outer pack



MADE IN
U.S.A

MARSHALLTOWN The Premier Line

| EDI | Part# | Size-in. | Size-mm |
|-------|----------|----------|-------------|
| 18126 | ITSLAT18 | 18 X 18 | 457 X 457 |
| 18127 | ITSLAT48 | 48 X 48 | 1219 X 1219 |

Rock Salt Texture

- Get the look of a rock salt finish
- **SALTEX48** comes with handles for easier stamping
- Sold 1 per inner pack/1 per outer pack

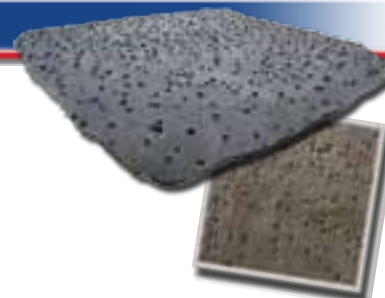

MADE IN
U.S.A

MARSHALLTOWN The Premier Line

| EDI | Part# | Size-in. | Size-mm |
|-------|----------|----------|-------------|
| 17999 | SALTEX18 | 18 X 18 | 457 X 457 |
| 18000 | SALTEX48 | 48 X 48 | 1219 X 1219 |

Pennsylvania/Chicago Brick Texture Skin

- Used with the Pennsylvania and Chicago brick pattern stamps
- Sold 1 per inner pack/1 per outer pack



MADE IN
U.S.A

MARSHALLTOWN The Premier Line

| EDI | Part# | Size-in. | Size-mm |
|-------|---------|----------|-----------|
| 18227 | CHPAT18 | 18 X 18 | 457 X 457 |

Pebblestone Texture

- Get the look of randomly laid pebbles
- **PEBBLE36** and **PEBBLE48** come with handles for easier stamping
- Sold 1 per inner pack/1 per outer pack



PEBBLE18

NEW!

MADE IN
U.S.A

MARSHALLTOWN The Premier Line

| EDI | Part# | Size-in. | Size-mm |
|-------|----------|----------|-------------|
| 18940 | PEBBLE18 | 18 X 18 | 457 X 457 |
| 18941 | PEBBLE24 | 24 X 24 | 610 X 610 |
| 18942 | PEBBLE36 | 36 X 36 | 914 X 914 |
| 18943 | PEBBLE48 | 48 X 48 | 1219 X 1219 |

Specialty Leaf Stamps

- Use individual or clusters of leaves to accent your slab
- Sold 1 per inner pack/1 per outer pack

NEW!

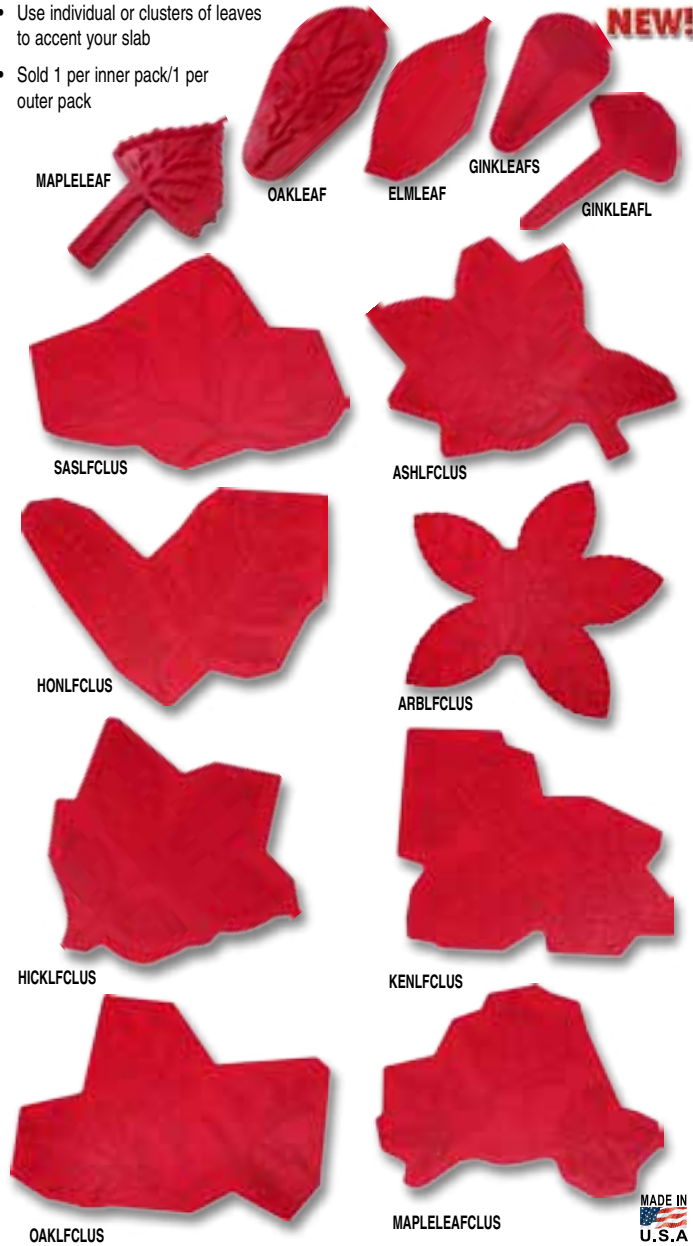

MAPLELEAF

OAKLEAF

ELMLEAF

GINKLEAFS

GINKLEAFL

SASLFCLUS

ASHLFCLUS

HONLFCLUS

ARBLFCLUS

HICKLFCLUS

KENLFCLUS

OAKLFCLUS

MAPLEAFCLUS

MADE IN
U.S.A

MARSHALLTOWN The Premier Line

| EDI | Part# | Description | Size-in. | Size-mm |
|-------|------------|----------------------------------|-----------|-----------|
| 18944 | ARBLFCLUS | Arbor Leaf Cluster | 28½ X 31½ | 724 X 800 |
| 18948 | ARBORLEAF | Arbor Leaf | 16⅞ X 8⅞ | 429 X 213 |
| 18945 | GINKLEAFS | Ginkgo Leaf Small | 26½ X 15 | 673 X 381 |
| 18951 | GINKLEAFL | Ginkgo Leaf Large | 12 X 7 | 305 X 178 |
| 18946 | OAKLEAF | Oak Leaf | 12 X 6⅞ | 305 X 156 |
| 18956 | OAKLFCLUS | Oak Leaf Cluster | 26⅞ X 18 | 679 X 457 |
| 18947 | MAPLELEAF | Maple Leaf | 9½ X 6 | 241 X 152 |
| 18955 | MAPLFCLUS | Maple Leaf Cluster | 23½ X 17 | 597 X 432 |
| 18949 | ASHLFCLUS | Ash Leaf Cluster | 23½ X 17¼ | 597 X 438 |
| 18950 | ELMLEAF | Elm Leaf | 30½ X 14 | 775 X 356 |
| 18952 | HICKLFCLUS | Hickory Leaf Cluster | 20 X 20 | 508 X 508 |
| 18953 | HONLFCLUS | Honey Locust Leaf Cluster | 24 X 17 | 610 X 432 |
| 18954 | KENLFCLUS | Kentucky Coffeetree Leaf Cluster | 28¼ X 20 | 718 X 508 |
| 18957 | SASLFCLUS | Sassafras Leaf Cluster | 25½ X 19 | 648 X 483 |

Cantilevered Cut Stone Step Liner

- Effortless transfer of rough cut stone texture to tread edges
- Dimensions shown are cast
- Sold 1 per inner pack/1 per outer pack

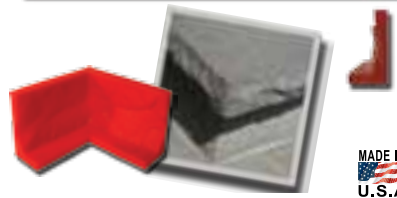

MARSHALLTOWN The Premier Line

| EDI | Part# | Size-in. | Size-mm |
|-------|-------------|------------|-----------|
| 17996 | CANTILEEDGE | 96 X 2 1/4 | 2438 X 57 |
| 17995 | CANTILCOR | 2 1/4 | 57 |

Cut Stone Riser Form

- Used to add rough cut stone texture to step risers
- Sold 1 per inner pack/1 per outer pack



MARSHALLTOWN The Premier Line

| EDI | Part# | Size-in. | Size-mm |
|-------|----------|------------|------------|
| 17998 | RISERSTN | 96 X 9 1/4 | 2438 X 235 |

Compatibility Chart

- Use this chart to find the correct combination of stamp, texture skin, chisel or roller
- See page 127 for touch up wheels

| Stamp | Texture Skin | Rollers | |
|--------------------------------|------------------|------------------------|---------------------|
| | | Size-in. | Size-mm |
| Ashlar Slate | Italian Slate | 1/4 Round | 6 Round |
| Bluestone | Bluestone 18988 | 1/4 Round | 6 Round |
| Cobblestone | Chiseled Slate | 1/4 Round | 6 Round |
| Colorado Flagstone | Chiseled Slate | 1/4 Flat or 3/8 Sanded | 6 Flat or 10 Sanded |
| Cottage Slate | Italian Slate | 1/4 Flat | 6 Flat |
| Fieldstone | Chiseled Slate | 1/4 Flat or 3/8 Sanded | 6 Flat or 10 Sanded |
| Hardwood Plank | N/A | N/A | N/A |
| Large Stone Fan | Chiseled Slate | 1/4 Round | 6 Round |
| Majestic Ashlar | Italian Slate | 1/4 Round | 6 Round |
| Mayan Circle | Heavy Stone | 1/4 Flat or 3/8 V | 6 Flat or 10 V |
| Mayan Cobblestone | Heavy Stone | 1/4 Flat or 3/8 V | 6 Flat or 10 V |
| New Basketweave Brick | New Brick | 3/8 Sanded | 10 Sanded |
| New Herringbone Brick | New Brick | 1/4 Flat or 3/8 V | 6 Flat or 10 V |
| Old Chicago Running Bond Brick | Penn/Old Chicago | 3/8 Sanded | 10 Sanded |
| Orchard Stone | Chiseled Slate | 3/8 V | 10 V |
| Pennsylvania Avenue Brick | Penn/Old Chicago | 1/4 Flat | 6 Flat |
| Pennsylvania Herringbone Brick | Penn/Old Chicago | 1/4 Flat | 6 Flat |
| Slate 6 X 6 | Italian Slate | 1/4 Round | 6 Round |
| Slate 12 X 12 | Italian Slate | 1/4 Round | 6 Round |
| Terta Stone | Heavy Stone | 1/4 Flat or 3/8 V | 6 Flat or 10 V |
| Verona Cobblestone | Chiseled Slate | 3/8 Sanded | 10 Sanded |
| 6" Wood Plank | 6WPSKIN | N/A | N/A |
| 12" Wood Plank | WP12T | N/A | N/A |

Cut Stone Form Liner

- Used to line forms for a cut stone look to the edge of your concrete
- Sold 1 per inner pack/1 per outer pack

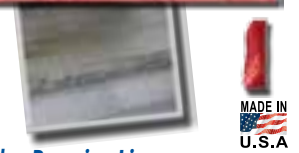

MARSHALLTOWN The Premier Line

| EDI | Part# | Size-in. | Size-mm |
|-------|------------|------------|-----------|
| 17997 | CUTSTNEDGE | 96 X 2 1/4 | 2438 X 57 |

ADA Stamps

- Detectable warning system used at curbs and cross walks in compliance with the Americans with Disabilities Act
- DOT RED is an integral mix specifically designed for ADA stamps
- Sold 1 per inner pack/1 per outer pack



| EDI | Part# |
|-------|---------|
| 18294 | DOT RED |

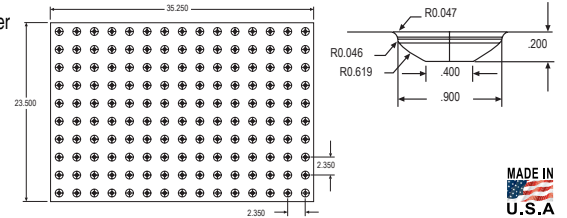

MARSHALLTOWN The Premier Line

| EDI | Part# | Size-in. | Size-mm |
|-------|-------|----------|------------|
| 18291 | ADA22 | 24 X 24 | 610 X 610 |
| 18292 | ADA23 | 24 X 36 | 610 X 914 |
| 18293 | ADA24 | 24 X 48 | 610 X 1219 |

Rock 'N' Roller

- Five times faster than traditional stamping methods
- Easy push and pull pattern imprint
- Unique leverage weight system is adaptable to different concrete sets
- No special setup needed for borders
- Start rolling imprints long before stamps could be applied
- **Kit includes:**
Roller
Frame with weight poles
Weights (2)
1 3/4" Push Button Adapter
- Sold 1 per inner pack/1 per outer pack

**5x
FASTER**



U.S. Patent Nos. 7,140,804 & 7,080,955



Your job is complete and the concrete is still wet!

SCAN HERE TO SEE IT IN ACTION!



MADE IN U.S.A.

Running Bond Brick



| EDI | Part# | Description |
|-------|----------|--------------------------|
| 25216 | REDRR100 | 35 1/8" (892mm) Roller |
| 25220 | REDRR105 | 11 13/16" (300mm) Roller |

Cobblestone



| EDI | Part# | Description |
|-------|----------|-------------------------|
| 25223 | REDRR120 | 33 7/16" (849mm) Roller |
| 25226 | REDRR125 | 11 5/16" (287mm) Roller |

Ashlar Slate



| EDI | Part# | Description |
|-------|----------|--------------------------|
| 25227 | REDRR130 | 35 15/16" (913mm) Roller |
| 25230 | REDRR135 | 14" (356mm) Roller |

Royal Slate



| EDI | Part# | Description |
|-------|----------|-------------------------|
| 25231 | REDRR140 | 35 7/16" (900mm) Roller |
| 25234 | REDRR145 | 12 1/4" (311mm) Roller |

Pathway Slate



| EDI | Part# | Description |
|-------|----------|------------------------|
| 25235 | REDRR150 | 35 1/2" (902mm) Roller |
| 25238 | REDRR155 | 12" (305mm) Roller |

Random Stone



| EDI | Part# | Description |
|-------|----------|------------------------|
| 25241 | REDRR165 | 14 1/2" (369mm) Roller |

NOTE: 14" and smaller rollers recommended for touch ups or borders only. Not recommended for large jobs.

To order: Phone: 800-888-0127 • Fax: 800-477-6341 • Visit our Website at www.MARSHALLTOWN.com

Rock 'N' Roller continued

Coarse Stone Texture



NEW!

| EDI | Part# | Description |
|-------|------------|--------------------|
| 27219 | REDRR305TX | 9" (229mm) Roller |
| 27220 | REDRR180TX | 24" (610mm) Roller |

Heavy Slate Texture



| EDI | Part# | Description |
|-------|------------|------------------------|
| 25221 | REDRR110 | 23 1/2" (597mm) Roller |
| 25249 | REDRR300TX | 9" (229mm) Roller |

Heavy Stone Texture



| EDI | Part# | Description |
|-------|------------|------------------------|
| 25222 | REDRR115 | 23 5/8" (600mm) Roller |
| 25250 | REDRR301TX | 9" (229mm) Roller |

Rock Salt Texture



| EDI | Part# | Description |
|-------|------------|--------------------|
| 25239 | REDRR160 | 24" (610mm) Roller |
| 25240 | REDRR160RS | 9" (229mm) Roller |

Wide Non Slip Diamond - Provides non-slip surface in livestock areas.



| EDI | Part# | Description |
|-------|----------|------------------------|
| 27005 | REDRR170 | 35 3/4" (908mm) Roller |

Texture Rollers

- Used to create texture next to buildings or other hard to reach areas
- All texture rollers have a feather edge to allow rolling in any direction while avoiding edge lines
- Accepts standard threaded handle
- To attach a push button pole use **4819** push button adapter
- New items indicated in red**
- Sold 1 per inner pack/1 per outer pack



MADE IN
U.S.A.

MARSHALLTOWN The Premier Line

| EDI | Part# | Description | Size |
|-------|------------|--------------|------------|
| 25249 | REDRR300TX | Heavy Slate | 9" (229mm) |
| 25250 | REDRR301TX | Heavy Stone | 9" (229mm) |
| 25251 | REDRR302TX | Light Slate | 9" (229mm) |
| 25240 | REDRR160RS | Rock Salt | 9" (229mm) |
| 27219 | REDRR305TX | Coarse Stone | 9" (229mm) |

Touch Up Wheels

- Used to touch up grout lines
- Accepts standard threaded handle
- To attach a push button pole use **4819** push button adapter
- Sold 1 per inner pack/1 per outer pack



MADE IN
U.S.A.

MARSHALLTOWN The Premier Line

| EDI | Part# | Description |
|-------|----------|--------------------|
| 25252 | REDRR565 | 1/4" (6mm) Round |
| 25253 | REDRR566 | 1/4" (6mm) Flat |
| 25254 | REDRR567 | 3/8" (10mm) Sanded |
| 25256 | REDRR569 | 3/8" (10mm) V |

Rock 'N' Roller Compatibility Chart

| Large Roller | Texture Roller | Touch Up Wheel |
|-----------------------|----------------|--------------------|
| Running Bond Brick | N/A | 3/8" (10mm) Sanded |
| Ashlar Slate | Heavy Slate | 1/4" (6mm) Round |
| Pathway Slate | Light Slate | 1/4" (6mm) Flat |
| Cobblestone | Heavy Slate | 1/4" (6mm) Round |
| Royal Slate | Light Slate | 1/4" (6mm) Flat |
| Heavy Slate | Heavy Slate | N/A |
| Heavy Stone | Heavy Stone | N/A |
| Rock Salt | Rock Salt | N/A |
| Wide Non Slip Diamond | N/A | 3/8" (10mm) V |
| Random Stone | Heavy Stone | 3/8" (10mm) V |

Rock 'N' Roller Weight

- Used with Rock 'N' Roller to help adapt to changing concrete conditions
- Sold 1 per inner pack/1 per outer pack



MADE IN
U.S.A.

MARSHALLTOWN The Premier Line

| EDI | Part# | Weight |
|-------|-----------|----------------|
| 25219 | REDRR100W | 4 lb. (1.8 kg) |

Interchangeable Border Rollers

- Add a border along the edges or through your slab
- One frame fits all rollers
- Buy a complete roller with frame and swap out individual rollers as needed
- Includes 1 3/4" push button adapter
- Sold 1 per inner pack/1 per outer pack

MADE IN
U.S.A

Tile Slate



| EDI | Part# | Description |
|-------|-----------|---------------------------|
| 25213 | REDRR02TS | 8" (203mm) Roller w/Frame |
| 25266 | REDRRX2TS | 8" (203mm) Roller only |

Diamond Slate



| EDI | Part# | Description |
|-------|-----------|---------------------------|
| 25214 | REDRR03DS | 8" (203mm) Roller w/Frame |
| 25267 | REDRRX3DS | 8" (203mm) Roller only |

Deco Scroll



| EDI | Part# | Description |
|-------|-----------|---------------------------|
| 25215 | REDRR04DC | 8" (203mm) Roller w/Frame |
| 25268 | REDRRX4DC | 8" (203mm) Roller only |

Soldier Course



| EDI | Part# | Description |
|-------|-----------|---------------------------|
| 25212 | REDRR01SC | 8" (203mm) Roller w/Frame |
| 25265 | REDRRX1SC | 8" (203mm) Roller only |

Mini Border Hand Tools

- Adds decorative pattern to edge of concrete
- Sold 1 per inner pack/1 per outer pack

REDRR194



REDRR196

Rope Border



Greek Key



Sm. Greek Key



Leaf Border



Floral Border



MADE IN
U.S.A

MARSHALLTOWN The Premier Line

| EDI | Part# | Description | Size |
|-------|----------|----------------------|---------------|
| 25242 | REDRR194 | Rope Border | 2 1/2" (57mm) |
| 25243 | REDRR195 | Greek Key Border | 3" (76mm) |
| 25244 | REDRR196 | Sm. Greek Key Border | 3" (76mm) |
| 25245 | REDRR197 | Leaf Border | 3" (76mm) |
| 25247 | REDRR199 | Floral Border | 4" (102mm) |

Perma-Cast® Sierra Stain

Concrete stains are a penetrating, reactive stain that chemically combines with cured concrete to produce permanent variegated coloring effects. Because there are so many variables involved in the chemical reaction process Perma-Cast® Sierra Stain produces unique results. Wide color variations, mottling, and unevenness of the color are normal and usually desired. If these coloring effects are not desired, Sierra Stain should not be used.

- Stains are only available as a case of 4-1 gallon (3.8 L) bottles.
- No broken cases will be processed.
- Coverage is approximately 300 sq. ft. per gallon. Stains ship LTL hazardous.
- Sold 1 per inner pack/1 per outer pack.



MADE IN
U.S.A



Tannin

| EDI | Part # |
|-------|----------|
| 18243 | SSTANNIN |



Caribbean Sea

| EDI | Part # |
|-------|--------|
| 18248 | SSCSEA |



Verdigris

| EDI | Part # |
|-------|----------|
| 18245 | SSVERDIG |



Balkin Amber

| EDI | Part # |
|-------|----------|
| 18244 | SSBAMBER |



Cordovan Leather

| EDI | Part # |
|-------|----------|
| 18246 | SSCORLTH |



Weathered Bronze

| EDI | Part # |
|-------|---------|
| 18054 | SSWBRNZ |

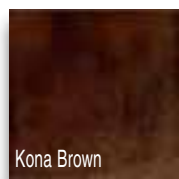

Kona Brown

| EDI | Part # |
|-------|--------|
| 18055 | SSKONA |

Warranty Disclaimer/Limitation of Liability: Marshalltown Company makes no warranties regarding this product, express or implied, including warranties of fitness for a particular purpose or merchantability. Marshalltown Company, its directors, officers and employees shall not be liable for indirect, special or consequential damages or personal injury arising out of the use or handling of this product whether or not it has been advised of the possibility of such a loss or damage. Purchaser assumes all liability for the use and handling of this product including any injury to third parties. Marshalltown Company maximum liability shall be the price of the product.

Color chart may vary from actual color due to printing, lighting, application and/or usage.

Elements™ Concrete Stains

Butterfield Color® Elements™ Transparent Concrete Stain represents the latest in nanopigment technology. It is formulated to readily permeate the concrete surface and create translucent color variations similar to reactive acid stain. It is a penetrating, non-film forming stain for existing concrete surfaces. It is resistant to fading from sunlight. It can be used on interior concrete floors and exterior concrete hardscapes. It may also be applied to concrete blocks, pavers, and cementitious overlays. Elements™ is a low odor, water-based staining system which contains no acid. **This product requires specific surface preparation including the use of CHO Concrete Cleaner** (page 137). The cleaner is a highly concentrated citric acid base which is used to open the pores on the surface of the concrete in order to allow the Elements stain to penetrate properly.

- Stains are available in 32oz. or 4oz. (1L or 118ml) bottles.
- Approximate coverage for 32oz. (1L) bottle is 200-400 sq. ft.
- Approximate coverage for 4oz. (118ml) is 25-50 sq. ft.
- Sold 1 per inner pack/1 per outer pack.



MADE IN
U.S.A



Tannin

| EDI | Part # |
|-------|------------|
| 18020 | ESTANNIN32 |
| 18036 | ESTANNIN4 |

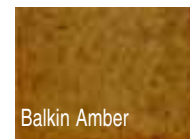

Balkin Amber

| EDI | Part # |
|-------|------------|
| 18021 | ESBAMBER32 |
| 18037 | ESBAMBER4 |



Verdigris

| EDI | Part # |
|-------|------------|
| 18022 | ESVERDIG32 |
| 18038 | ESVERDIG4 |



Stygian

| EDI | Part # |
|-------|-----------|
| 18024 | ESSTYGN32 |
| 18040 | ESSTYGN4 |



Caribbean Sea

| EDI | Part # |
|-------|----------|
| 18025 | ESCSEA32 |
| 18041 | ESCSEA4 |



Lichen

| EDI | Part # |
|-------|------------|
| 18026 | ESLICHEN32 |
| 18042 | ESLICHEN4 |

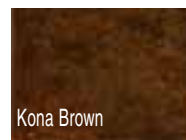

Kona Brown

| EDI | Part # |
|-------|----------|
| 18028 | ESKONA32 |
| 18044 | ESKONA4 |

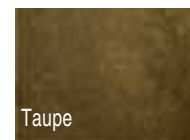

Taupe

| EDI | Part # |
|-------|-----------|
| 18029 | ESTAUPE32 |
| 18045 | ESTAUPE4 |



Yellow

| EDI | Part # |
|-------|------------|
| 18030 | ESYELLOW32 |
| 18046 | ESYELLOW4 |



Blue

| EDI | Part # |
|-------|----------|
| 18032 | ESBLUE32 |
| 18048 | ESBLUE4 |

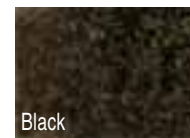

Black

| EDI | Part # |
|-------|-----------|
| 18033 | ESBLACK32 |
| 18049 | ESBLACK4 |



Purple

| EDI | Part # |
|-------|------------|
| 18034 | ESPURPLE32 |
| 18050 | ESPURPLE4 |



Cordovan Leather

| EDI | Part # |
|-------|------------|
| 18023 | ESCORLTH32 |
| 18039 | ESCORLTH4 |



Weathered Bronze

| EDI | Part # |
|-------|-----------|
| 18027 | ESWBRNZ32 |
| 18043 | ESWBRNZ4 |

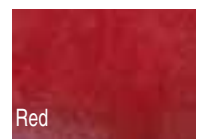

Red

| EDI | Part # |
|-------|---------|
| 18031 | ESRED32 |
| 18047 | ESRED4 |



Gray

| EDI | Part # |
|-------|----------|
| 18035 | ESGRAY32 |
| 18051 | ESGRAY4 |

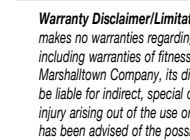

Weathered Bronze

| EDI | Part # |
|-------|-----------|
| 18027 | ESWBRNZ32 |
| 18043 | ESWBRNZ4 |

Warranty Disclaimer/Limitation of Liability: Marshalltown Company makes no warranties regarding this product, express or implied, including warranties of fitness for a particular purpose or merchantability. Marshalltown Company, its directors, officers and employees shall not be liable for indirect, special or consequential damages or personal injury arising out of the use or handling of this product whether or not it has been advised of the possibility of such a loss or damage. Purchaser assumes all liability for the use and handling of this product including any injury to third parties. Marshalltown Company maximum liability shall be the price of the product.

Color chart may vary from actual color due to printing, lighting, application and/or usage.

Cantera™ Vertical Wall Mix

- Replicates natural stone on vertical applications
- The overlay provides a durable surface suitable for stamping
- Packaged in 35 lbs (15.9 kg) bag
- Coverage is 33.5 sq. ft. at 1/4" (6mm) thick, 11 sq. ft. at 3/4" (19mm) or 8.5 sq. ft. at 1" (25mm) thick per 35 lb (19.5 kg) bag
- Additional products needed for completion of this project: T1000 Sprayable Fine Overlay (page 134), T1000 Primer (page 138)
- Sold 1 per inner pack/1 per outer pack



MARSHALLTOWN The Premier Line

| EDI | Part# | Description |
|-------|-------------|-------------------|
| 18003 | CANTERVVMIX | Vertical Wall Mix |

Step 1: Surface Prep

- Proper surface preparation is critical to the application of the Cantera™ Vertical Wall Mix. Vertical Wall Mix can be applied over a variety of surfaces. Ensuring a good bond will require a combination of grinding, patching, taping, and fastening of wire mesh. A base scratch coat of T1000 Sprayable Fine Overlay is recommended prior to applying the vertical wall mix. See our website to read the complete technical data guide to determine the necessary preparations.



Step 2: Priming the Surface

- Mix one gallon (3.8L) of water with one gallon of T1000™ Primer. Apply an even coat to the surface using a paint roller, soft broom, or sprayer. Once the primer has dried to a tack-free state, installation should begin.



Step 3: Mixing

- Add 2 gallons (8.5L) of water to a 5 gallon (18.9L) bucket and then mix in the 35 lb (15.9kg) bag of vertical wall mix. Continue to mix for approximately 3 minutes or until a lump free mixture has been achieved.



Step 4: Installation

- Apply the material to the wall using a pool trowel and hawk working with a vertical, bottom to top, stroke. Do not overwork the surface or hard trowel vertical wall mix. Material should not be applied thicker than 1" (25.4mm) in a single application. If material sags, reduce water content of the mix.



Step 5: Stamping

- The working time of the vertical wall mix is up to 1 hour depending on conditions. Once the material will take a clean impression, apply liquid release to the wall using a sprayer. Position and apply pressure to the stamp. Take care to ensure the stamp does not slide. Remove any blemishes using a texture roller or hand carving tool.



Step 6: Wrapping Up

- Control joints should be saw cut within 14 hours of application. Once the Cantera™ Vertical Wall Mix has cured for 7 days Elements™ or Perma-Cast® Sierra Stain can be applied to achieve the desired color variations. Sealer is not required for Cantera™ Vertical wall mix.



Can be colored using Uni-Mix® color packs see page 132

Weathered Edge Wall Stamps

- Create the elegant look and feel of your dreams
- Replicate the look of natural stone over existing walls
- Grout line depth 1/2" to 1" (13mm to 25mm)
- Mix and match stamps to achieve the natural, random look as desired
- Sold 1 per inner pack/1 per outer pack

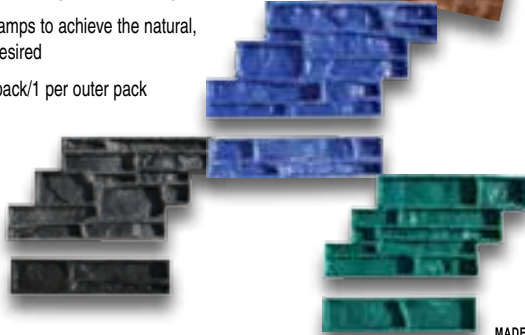

MADE IN
U.S.A

MARSHALLTOWN The Premier Line

| EDI | Part# | Description | Size-in. | Size-mm |
|-------|--------------|-------------------|----------|-----------|
| 18004 | WEWGREEN | Green | 12 X 24 | 305 X 610 |
| 18005 | WEWBLUE | Blue | 12 X 24 | 305 X 610 |
| 18006 | WEWBLACK | Black | 12 X 24 | 305 X 610 |
| 18007 | WEWTOOLGREEN | Green Finish Tool | 4 X 18 | 102 X 457 |
| 18008 | WEWTOOLBLUE | Blue Finish Tool | 4 X 18 | 102 X 457 |
| 18009 | WEWTOOLBLACK | Black Finish Tool | 4 X 18 | 102 X 457 |

Top Stone Wall Stamps

- Go for a rustic cottage atmosphere
- Replicate the look of natural stone over existing walls
- Mix and match stamps to achieve the natural, random look as desired
- Grout line depth 1/4" to 3/4" (6mm to 19mm)
- Sold 1 per inner pack/1 per outer pack



MADE IN
U.S.A

MARSHALLTOWN The Premier Line

| EDI | Part# | Description | Size-in. | Size-mm |
|-------|--------------|-------------------|----------|-----------|
| 18010 | TSWGREEN | Green | 17 X 28 | 432 X 711 |
| 18011 | TSWBLUE | Blue | 17 X 28 | 432 X 711 |
| 18012 | TSWBLACK | Black | 17 X 28 | 432 X 711 |
| 18013 | TSWTOOLBLACK | Black Finish Tool | 15 X 14 | 381 X 356 |

Platteville Limestone (Small) Wall Stamps

- The Platteville Limestone small and large tools are interchangeable and can be used together or separately to achieve a random, natural appearance
- Replicate the look of natural stone over existing walls
- Mix and match stamps to achieve the natural, random look as desired
- Grout line depth 1/2" to 1" (13mm to 25mm)
- Sold 1 per inner pack/1 per outer pack



MADE IN
U.S.A

MARSHALLTOWN The Premier Line

| EDI | Part# | Description | Size-in. | Size-mm |
|-------|-----------|-------------|------------|-----------|
| 18014 | PLBLACKSM | Black | 17 X 28 | 432 X 711 |
| 18015 | PLBLUESM | Blue | 17 X 28 | 432 X 711 |
| 18016 | PLBLUEGL | Blue | 8 1/2 X 24 | 215 X 610 |
| 18058 | PLGREENSM | Green | 17 X 28 | 432 X 711 |

Platteville Limestone (Large) Wall Stamps

- The Platteville Limestone small and large tools are interchangeable and can be used together or separately to achieve a random, natural appearance
- Replicate the look of natural stone over existing walls
- Mix and match stamps to achieve a natural, random look as desired
- Grout line depth 1/2" to 1" (13mm to 25mm)
- Sold 1 per inner pack/1 per outer pack



MADE IN
U.S.A

MARSHALLTOWN The Premier Line

| EDI | Part# | Description | Size-in. | Size-mm |
|-------|-----------|-------------|------------|-----------|
| 18017 | PLGREENLG | Green | 8 1/2 X 24 | 215 X 610 |
| 18018 | PLREDLG | Red | 8 1/2 X 24 | 215 X 610 |
| 18019 | PLBLACKLG | Black | 8 1/2 X 24 | 215 X 610 |

T1000™ Stampable Overlay



- Designed for resurfacing structurally sound, non-moving concrete floors and exterior hardscapes
- The overlay provides a durable surface suitable for stamping
- Ideal for restoring worn or color blemished concrete, out of level surfaces or correcting construction errors.
- Packaged in 55 lbs (24.9 kg) bag
- Coverage is 24 sq. ft. at 1/4" (6mm) thick, 16 sq. ft. at 3/8" (10mm) or 12 sq. ft. at 1/2" (13mm) thick per 55 lb (24.9 kg) bag
- **WARNING:** White overlay products will produce more vibrant variations of the colors shown on the color charts. Produce an on-site sample to ensure the desired look.
- Color with Uni-Mix® color packs (sold separately)
- Additional products needed for completion of this project: T1000 Primer (page 138), Perma-Cast® Antiquing and Liquid Release (page 137)
- Sold 1 per inner pack/1 per outer pack



MARSHALLTOWN The Premier Line

| EDI | Part# | Description |
|-------|--------------|------------------------------------|
| 18257 | STAMPOVERLAY | Stampable Overlay |
| 18002 | T1MSTAMPOLW | T1000 Stampable Fine Overlay-White |

Step 1: Surface Prep

- Proper surface preparation is critical to the application of all overlay products. Ensure that the surface is free of all potential bond breakers and mechanically scar the surface if materials can't be removed with ease. Patch all cracks using T1000™ overlay mixture using a maximum of 1/2" (13mm) lifts.



Step 2: Priming the Surface

- Mix one gallon (3.8L) of water with one gallon of T1000™ Primer. Apply an even coat to the surface of the concrete using a paint roller, soft push broom, squeegee, or sprayer. Once the primer has dried to a tack-free state, installation should begin.



Step 3: Mixing

- Add 3.7 (3.5L) quarts of water to a 5 gallon (18.9L) bucket, slowly mix in color pack, and then add the entire 55-pound (25kg) bag of T1000™ Stampable Overlay. Continue to mix for approximately 3 minutes or until a lump-free, streak-free consistency is achieved.



Step 4: Installation

- Using a trowel or gauge rake, apply material with an even thickness that is equal to the depth of the grout lines of the stamp you've selected. Ensure that you keep a wet edge to prevent cold joints. After approximately 20-60 minutes, depending on conditions, the overlay should be ready to stamp. Mix powder release with liquid release (1/4 cup to 1 gallon, 237ml to 3.785L). Apply an even coat of clear liquid release prior to stamping.



Step 5: Wrapping Up

- Following stamping the overlay should be allowed to cure for at least 24 hours. Apply a thin coat of Clear Guard™ Cure and Seal. Apply a final coat of sealer to ensure a long lasting surface.



Uni-Mix® Color Packs

- Simply add 1 color pack per bag
- Call or visit our website for more information
- Sold 1 per inner pack/12 per outer pack



| | | |
|----------------------|------------------------------|------------------------|
| Sonoran Tan | Autumn Oak | Lanon Stone |
| EDI Part# | EDI Part# | EDI Part# |
| 18261 CPSTAN | 18262 CPAOK | 18275 CPLANST |
| Smoke | Sandstone | Sunset Beige |
| EDI Part# | EDI Part# | EDI Part# |
| 18269 CPSMOKE | 18270 CPSANDST | 18263 CPSBEIGE |
| Millstone | Weathered Terra Cotta | Salt Marsh Gray |
| EDI Part# | EDI Part# | EDI Part# |
| 18264 CPMILLST | 18278 CPTCOTTA | 18271 CPSMGRAY |
| Dusty Rose | Shadow Slate | Clary Sage |
| EDI Part# | EDI Part# | EDI Part# |
| 18272 CPDROSE | 18281 CPSPLATE | 18284 CPCSAGE |
| Georgia Clay | Coral Buff | Harvest Wheat |
| EDI Part# | EDI Part# | EDI Part# |
| 18273 CPGCLAY | 18266 CPCBUFF | 18267 CPHWHEAT |
| Sienna | Mocha Brown | Santa Fe Buff |
| EDI Part# | EDI Part# | EDI Part# |
| 18282 CPSIENNA | 18276 CPMBROWN | 18274 CPSFBUFF |
| Hampshire Red | Brick Red | Pewter |
| EDI Part# | EDI Part# | EDI Part# |
| 18279 CPHRED | 18280 CPBRKRD | 18265 CPPEWTER |
| Gull Gray | Charcoal | Deep Charcoal |
| EDI Part# | EDI Part# | EDI Part# |
| 18268 CPGGRAY | 18277 CPCCHAR | 18283 CPDCHAR |

Color chart may vary from actual color due to printing, lighting, application and/or usage.

Flat Out Countertop Mix

NEW!

- Designed for quick production and pre-casting of countertops, concrete panels, and other architectural precast shapes and pieces
- Fast, quick setting, 2 component mix
- Can be de-molded in as little as 3 hours and polished within 8 hours of pouring
- 28 day compressive strength of 11,000 psi
- Can be colored by adding Uni-Mix® Color Packs to mix
- Dry mix is packaged in 55 pound bags and liquid polymer is packaged in 5 gallon pails. One pail of polymer yields enough material for approximately 6 bags of countertop mix.
- One bag of countertop mix requires 3.25 quarts of polymer to yield 0.42 cubic feet or approximately 5 square feet at 1" thick



MARSHALLTOWN The Premier Line

| EDI | Part# | Description |
|-------|---------|--------------------------|
| 18903 | FOCM | Flat Out Countertop Mix |
| 18904 | FOPOLY5 | Flat Out Polymer (5 gal) |



Step 1:

Level casting table. Flat Out® is a self-consolidating mix. If the casting table is not uniformly level in all directions the Flat Out® will flow to one direction and out of your mold.



Step 2:

Flat Out® will pick up and transpose any imperfections on your casting table and mold. Use a combination of dish soap and water to clean the surface and make sure there are no scratches or cuts in the surface of the casting table or mold.



Step 3:

The mixing ratio is 3.25 quarts of Flat Out® Polymer to one 55lb bag of Flat Out® Countertop Mix. First add 2.75 quarts of Flat Out® Polymer to a clean 5 gallon bucket, retaining the additional ½ quart of polymer for later addition. If color is to be added, a Uni-Mix® Color Pack should be added to the 2.75 quarts of Polymer at this time and mixed with a 600 rpm drill. After the Polymer and Color Pack have been thoroughly mixed, slowly add the 55 lb bag of Flat Out® Countertop Mix. Mix for two minutes then add the additional ½ quart of polymer and mix for an additional one minute.



Step 4:

Pour Flat Out® mixture into mold. Flat Out® is self-consolidating and requires no troweling or finishing. The surface of the casting table is the finished side. Wear latex gloves and use finger tips to move material into place and help consolidate and level the mix. If the countertop requires more than 1 bag of material, have all components pre-measured. All batches must be placed within 5 minutes of each other to ensure material bonds properly. Once the mold is full and consolidated, cover with a piece of foam insulation. This will help keep the heat inside the mold and allow for a better cure.



Step 5

Piece may be demolded after 3 hours of cure time at 70° Fahrenheit. At lower temperatures, the demolding time is extended. Gloves should be worn when handling any finished pieces as the edges may be sharp and to avoid oil from your skin discoloring the finish before sealing. See Flat Out® Countertop Mix Tech Data for Finishing and Maintenance Instructions



Decorative CONCRETE TOOLS

Warranty Disclaimer/Limitation of Liability: Marshalltown Company makes no warranties regarding this product, express or implied, including warranties of fitness for a particular purpose or merchantability. Marshalltown Company, its directors, officers and employees shall not be liable for indirect, special or consequential damages or personal injury arising out of the use or handling of this product whether or not it has been advised of the possibility of such a loss or damage. Purchaser assumes all liability for the use and handling of this product including any injury to third parties. Marshalltown Company maximum liability shall be the price of the product.

T1000™ Sprayable Fine Overlay

- Designed for resurfacing structurally sound, non-moving concrete floors, walls and exterior hardscapes
- Can be smooth troweled, broom finished or applied using a splatter brush or hopper gun for a knockdown finish
- Packaged in 55 lbs (24.9 kg) bag
- Coverage is 96 sq. ft. at 1/16" (1.6mm) thick or 32 sq. ft. at 3/16" (4mm) thick per 55 lb (24.9 kg) bag
- **WARNING:** White overlay products will produce more vibrant variations of the colors shown on the color charts. Produce an on-site sample to ensure the desired look.
- Color with T1000™ color packs (sold separately, see page 132)
- Sold 1 per inner pack/1 per outer pack



MARSHALLTOWN The Premier Line

| EDI | Part# | Description |
|-------|---------------|------------------------------------|
| 18260 | SPRAYOVERLAYF | Sprayable Fine Overlay |
| 18001 | T1MSPRAYOLW | T1000 Sprayable Fine Overlay-White |

Step 1: Surface Prep

- Proper surface preparation is critical to the application of all overlay products. Ensure that the surface is free of all potential bond breakers and mechanically scar the surface if materials can't be removed with ease. Patch all cracks using T1000™ overlay mixture using a maximum of 3/16" (4mm) lifts.



Step 2: Mixing

- Add 4.4 quarts (4.7L) of water to a 5 gallon (18.9L) bucket, slowly mix in color pack, and then add the T1000™ Sprayable Fine Overlay. Continue to mix for approximately 3 minutes or until a lump-free, streak-free consistency is achieved.



Step 3: Base Coat

- If stencils are used and a contrasting grout line is desired, skim coat a 1/16" (1.6mm) thick layer of T1000™ Sprayable Fine Overlay prior to placing stencils. Allow adequate drying time after application prior to placing stencils (approximately 2-8 hours).



Step 4: Laying Out Stencils

- Lay out the entire project prior to sticking the stencils in place. This will ensure that your layout is correct. Once final positioning has been determined apply the stencil to the surface.



Step 5: Applying the Material

- T1000™ Sprayable Fine Overlay is applied using a hopper gun. Simply spray the material on and create the desired finish using a knockdown knife, trowel, or texture skin. Allow enough set time to prevent chipping. The final step is to remove stencils. Allow to dry thoroughly and then seal.



Integral Color Patch Mix™

- One component, easy to use repair mortar for use on concrete colored with Uni-Mix® Integral Concrete Colorant
- Suitable for patching pop-outs, chips, and minor concrete defects
- Great for plastering the risers of steps prior to texturing, after removing forms
- Each pail is 5 pounds
- Sold 6 per inner pack / 6 per outer pack



| <p>Sonoran Tan</p> <table border="1"> <tr><th>EDI</th><th>Part#</th></tr> <tr><td>18910</td><td>PMSTAN</td></tr> </table> | EDI | Part# | 18910 | PMSTAN | <p>Autumn Oak</p> <table border="1"> <tr><th>EDI</th><th>Part#</th></tr> <tr><td>18911</td><td>PMAOAK</td></tr> </table> | EDI | Part# | 18911 | PMAOAK | <p>Lanon Stone</p> <table border="1"> <tr><th>EDI</th><th>Part#</th></tr> <tr><td>18924</td><td>PMLANST</td></tr> </table> | EDI | Part# | 18924 | PMLANST |
|--|----------|-------|-------|----------|--|-----|-------|-------|----------|--|-----|-------|-------|----------|
| EDI | Part# | | | | | | | | | | | | | |
| 18910 | PMSTAN | | | | | | | | | | | | | |
| EDI | Part# | | | | | | | | | | | | | |
| 18911 | PMAOAK | | | | | | | | | | | | | |
| EDI | Part# | | | | | | | | | | | | | |
| 18924 | PMLANST | | | | | | | | | | | | | |
| <p>Smoke</p> <table border="1"> <tr><th>EDI</th><th>Part#</th></tr> <tr><td>18918</td><td>PMSMOKE</td></tr> </table> | EDI | Part# | 18918 | PMSMOKE | <p>Sandstone</p> <table border="1"> <tr><th>EDI</th><th>Part#</th></tr> <tr><td>18919</td><td>PMSANDST</td></tr> </table> | EDI | Part# | 18919 | PMSANDST | <p>Sunset Beige</p> <table border="1"> <tr><th>EDI</th><th>Part#</th></tr> <tr><td>18912</td><td>PMSBEIGE</td></tr> </table> | EDI | Part# | 18912 | PMSBEIGE |
| EDI | Part# | | | | | | | | | | | | | |
| 18918 | PMSMOKE | | | | | | | | | | | | | |
| EDI | Part# | | | | | | | | | | | | | |
| 18919 | PMSANDST | | | | | | | | | | | | | |
| EDI | Part# | | | | | | | | | | | | | |
| 18912 | PMSBEIGE | | | | | | | | | | | | | |
| <p>Millstone</p> <table border="1"> <tr><th>EDI</th><th>Part#</th></tr> <tr><td>18913</td><td>PMMILLST</td></tr> </table> | EDI | Part# | 18913 | PMMILLST | <p>Weathered Terra Cotta</p> <table border="1"> <tr><th>EDI</th><th>Part#</th></tr> <tr><td>18927</td><td>PMTCOTTA</td></tr> </table> | EDI | Part# | 18927 | PMTCOTTA | <p>Salt Marsh Gray</p> <table border="1"> <tr><th>EDI</th><th>Part#</th></tr> <tr><td>18920</td><td>PMSMGRAY</td></tr> </table> | EDI | Part# | 18920 | PMSMGRAY |
| EDI | Part# | | | | | | | | | | | | | |
| 18913 | PMMILLST | | | | | | | | | | | | | |
| EDI | Part# | | | | | | | | | | | | | |
| 18927 | PMTCOTTA | | | | | | | | | | | | | |
| EDI | Part# | | | | | | | | | | | | | |
| 18920 | PMSMGRAY | | | | | | | | | | | | | |
| <p>Dusty Rose</p> <table border="1"> <tr><th>EDI</th><th>Part#</th></tr> <tr><td>18921</td><td>PMDROSE</td></tr> </table> | EDI | Part# | 18921 | PMDROSE | <p>Shadow Slate</p> <table border="1"> <tr><th>EDI</th><th>Part#</th></tr> <tr><td>18930</td><td>PMSSLATE</td></tr> </table> | EDI | Part# | 18930 | PMSSLATE | <p>Clary Sage</p> <table border="1"> <tr><th>EDI</th><th>Part#</th></tr> <tr><td>18933</td><td>PMCSAGE</td></tr> </table> | EDI | Part# | 18933 | PMCSAGE |
| EDI | Part# | | | | | | | | | | | | | |
| 18921 | PMDROSE | | | | | | | | | | | | | |
| EDI | Part# | | | | | | | | | | | | | |
| 18930 | PMSSLATE | | | | | | | | | | | | | |
| EDI | Part# | | | | | | | | | | | | | |
| 18933 | PMCSAGE | | | | | | | | | | | | | |
| <p>Georgia Clay</p> <table border="1"> <tr><th>EDI</th><th>Part#</th></tr> <tr><td>18922</td><td>PMGCLAY</td></tr> </table> | EDI | Part# | 18922 | PMGCLAY | <p>Coral Buff</p> <table border="1"> <tr><th>EDI</th><th>Part#</th></tr> <tr><td>18915</td><td>PMCORB</td></tr> </table> | EDI | Part# | 18915 | PMCORB | <p>Harvest Wheat</p> <table border="1"> <tr><th>EDI</th><th>Part#</th></tr> <tr><td>18916</td><td>PMHWHEAT</td></tr> </table> | EDI | Part# | 18916 | PMHWHEAT |
| EDI | Part# | | | | | | | | | | | | | |
| 18922 | PMGCLAY | | | | | | | | | | | | | |
| EDI | Part# | | | | | | | | | | | | | |
| 18915 | PMCORB | | | | | | | | | | | | | |
| EDI | Part# | | | | | | | | | | | | | |
| 18916 | PMHWHEAT | | | | | | | | | | | | | |
| <p>Sienna</p> <table border="1"> <tr><th>EDI</th><th>Part#</th></tr> <tr><td>18931</td><td>PMSIENNA</td></tr> </table> | EDI | Part# | 18931 | PMSIENNA | <p>Mocha Brown</p> <table border="1"> <tr><th>EDI</th><th>Part#</th></tr> <tr><td>18925</td><td>PMMBROWN</td></tr> </table> | EDI | Part# | 18925 | PMMBROWN | <p>Santa Fe Buff</p> <table border="1"> <tr><th>EDI</th><th>Part#</th></tr> <tr><td>18923</td><td>PMSFBUFF</td></tr> </table> | EDI | Part# | 18923 | PMSFBUFF |
| EDI | Part# | | | | | | | | | | | | | |
| 18931 | PMSIENNA | | | | | | | | | | | | | |
| EDI | Part# | | | | | | | | | | | | | |
| 18925 | PMMBROWN | | | | | | | | | | | | | |
| EDI | Part# | | | | | | | | | | | | | |
| 18923 | PMSFBUFF | | | | | | | | | | | | | |
| <p>Hampshire Red</p> <table border="1"> <tr><th>EDI</th><th>Part#</th></tr> <tr><td>18928</td><td>PMHRED</td></tr> </table> | EDI | Part# | 18928 | PMHRED | <p>Brick Red</p> <table border="1"> <tr><th>EDI</th><th>Part#</th></tr> <tr><td>18929</td><td>PMBRKRD</td></tr> </table> | EDI | Part# | 18929 | PMBRKRD | <p>Pewter</p> <table border="1"> <tr><th>EDI</th><th>Part#</th></tr> <tr><td>18914</td><td>PMPWTER</td></tr> </table> | EDI | Part# | 18914 | PMPWTER |
| EDI | Part# | | | | | | | | | | | | | |
| 18928 | PMHRED | | | | | | | | | | | | | |
| EDI | Part# | | | | | | | | | | | | | |
| 18929 | PMBRKRD | | | | | | | | | | | | | |
| EDI | Part# | | | | | | | | | | | | | |
| 18914 | PMPWTER | | | | | | | | | | | | | |
| <p>Gull Gray</p> <table border="1"> <tr><th>EDI</th><th>Part#</th></tr> <tr><td>18917</td><td>PMGGRAY</td></tr> </table> | EDI | Part# | 18917 | PMGGRAY | <p>Charcoal</p> <table border="1"> <tr><th>EDI</th><th>Part#</th></tr> <tr><td>18926</td><td>PMCHAR</td></tr> </table> | EDI | Part# | 18926 | PMCHAR | <p>Deep Charcoal</p> <table border="1"> <tr><th>EDI</th><th>Part#</th></tr> <tr><td>18932</td><td>PMDCHAR</td></tr> </table> | EDI | Part# | 18932 | PMDCHAR |
| EDI | Part# | | | | | | | | | | | | | |
| 18917 | PMGGRAY | | | | | | | | | | | | | |
| EDI | Part# | | | | | | | | | | | | | |
| 18926 | PMCHAR | | | | | | | | | | | | | |
| EDI | Part# | | | | | | | | | | | | | |
| 18932 | PMDCHAR | | | | | | | | | | | | | |

Color chart may vary from actual color due to printing, lighting, application and/or usage.

Warranty Disclaimer/Limitation of Liability: Marshalltown Company makes no warranties regarding this product, express or implied, including warranties of fitness for a particular purpose or merchantability. Marshalltown Company, its directors, officers and employees shall not be liable for indirect, special or consequential damages or personal injury arising out of the use or handling of this product whether or not it has been advised of the possibility of such a loss or damage. Purchaser assumes all liability for the use and handling of this product including any injury to third parties. Marshalltown Company maximum liability shall be the price of the product.

Uni-Mix® Integral Concrete Colorant

Integral colorant is added directly to the truck while the concrete is mixing. In the event that cracks or chipping occur this ensures that there is a consistent color throughout the slab. Select 5 or 6 sack mix based on the cement content of your concrete. 6 sack = 564 lbs (256kg) of cement per cubic yard (4,000 psi mix). 5 sack = 470 lbs (213kg) of cement per cubic yard (3,500 psi mix). You should always consult with your concrete provider to become familiar with their policies and any additional fees before proceeding with this method.



Simply add 1 bag per yard of concrete
The cement content of your concrete will dictate whether a 5 or 6 sack mix is appropriate. Sold 1 per inner pack/1 per outer pack.

Step 1: Coloring the Concrete

- The integral colorant is added directly to the load while it is mixing in the truck. Our integral products come in dissolvable pre-measured bags ensuring consistency and reducing the hassle and the mess. Simply roll the concrete to the top of the truck, add one bag per yard of concrete into the mixer, packaging and all, and mix for 110 revolutions (approx. 5 minutes).



Step 2: Working the Concrete

- The initial leveling is performed using a screed. A concrete tamper is then used to push the larger aggregate down while working the cream to the surface, allowing smoother finishing and stamping. At this point the slab should be bull floated and initial edging can start. Using a fresno is the final stage before using release and beginning stamping.
- Note: The use of a fresno should be avoided if freeze-thaw is an issue. Instead, the final finish should be performed with a wood or magnesium bull float.



Step 3: Release

- The release agent should be evenly cast onto the surface. Stamps should also be coated with release powder to increase effectiveness. The release serves dual purposes; it reduces the bonding that would occur between the concrete and the stamp, and it adds the contrast that creates the depth and texture of natural stone.



Step 4: Stamping

- Set the first mat and make sure every other mat is set tight, preventing extra wide grout lines and reducing touch up work. Use a hand tamper to ensure the complete transfer of the pattern. Flex mats and skins are used to transfer patterns in the areas that require less than a full stamp. It may be necessary to touch up some of the joints using a chisel or roller before the concrete has dried.



Step 5: Finishing Up

- After the concrete has cured sufficiently, typically 1-2 days, the surface should be pressure washed to remove excess release powder. The goal is to leave enough release to give you the desired color and contrast for the project. The look of wet concrete will closely resemble the finished product. The concrete should be allowed to dry thoroughly and then be sealed.



Important Notice: This information should only be used as a general overview. **MARSHALLTOWN** cannot address every installation's circumstances and requirements. Always consult and follow all local, state and federal guidelines.

Warranty Disclaimer/Limitation of Liability: Marshalltown Company makes no warranties regarding this product, express or implied, including warranties of fitness for a particular purpose or merchantability. Marshalltown Company, its directors, officers and employees shall not be liable for indirect, special or consequential damages or personal injury arising out of the use or handling of this product whether or not it has been advised of the possibility of such a loss or damage. Purchaser assumes all liability for the use and handling of this product including any injury to third parties. Marshalltown Company maximum liability shall be the price of the product.

Color chart may vary from actual color due to printing, lighting, application and/or usage.

| | | |
|----------------------|------------------------------|------------------------|
| Sonoran Tan | Autumn Oak | Lanon Stone |
| EDI Part# | EDI Part# | EDI Part# |
| 18148 INTAN5 | 18149 INAOAK5 | 18162 INLSTN5 |
| 18172 INTAN6 | 18173 INAOAK6 | 18186 INLSTN6 |
| Smoke | Sandstone | Sunset Beige |
| EDI Part# | EDI Part# | EDI Part# |
| 18156 INSMOKE5 | 18157 INSDST5 | 18150 INSBEIG5 |
| 18180 INSMOKE6 | 18181 INSDST6 | 18174 INSBEIG6 |
| Millstone | Weathered Terra Cotta | Salt Marsh Gray |
| EDI Part# | EDI Part# | EDI Part# |
| 18151 INMILL5 | 18165 INWTC5 | 18158 INMGRY5 |
| 18175 INMILL6 | 18189 INWTC6 | 18182 INMGRY6 |
| Dusty Rose | Shadow Slate | Clary Sage |
| EDI Part# | EDI Part# | EDI Part# |
| 18159 INDRSE5 | 18168 INSSLT5 | 18171 INCSAGE5 |
| 18183 INDRSE6 | 18192 INSSLT6 | 18195 INCSAGE6 |
| Georgia Clay | Coral Buff | Harvest Wheat |
| EDI Part# | EDI Part# | EDI Part# |
| 18160 INGCLAY5 | 18153 INCBLF5 | 18154 INHWHT5 |
| 18184 INGCLAY6 | 18177 INCBLF6 | 18178 INHWHT6 |
| Sienna | Mocha Brown | Santa Fe Buff |
| EDI Part# | EDI Part# | EDI Part# |
| 18169 INSIEN5 | 18163 INMBRN5 | 18161 INSFBUF5 |
| 18193 INSIEN6 | 18187 INMBRN6 | 18185 INSFBUF6 |
| Hampshire Red | Brick Red | Pewter |
| EDI Part# | EDI Part# | EDI Part# |
| 18166 INHRED5 | 18167 INBRED5 | 18152 INPEWT5 |
| 18190 INHRED6 | 18191 INBRED6 | 18176 INPEWT6 |
| Gull Gray | Charcoal | Deep Charcoal |
| EDI Part# | EDI Part# | EDI Part# |
| 18155 INGGRY5 | 18164 INCHAR5 | 18170 INDCHAR5 |
| 18179 INGGRY6 | 18188 INCHAR6 | 18194 INDCHAR6 |

Perma-Cast® Shake-On Color Hardener

Coverage is approximately 100 sq. ft. (9.29m2) per 50 lb. (22.6 kg) pail
 Perma-Cast® Shake-On Color Hardener is packaged in a 50 lb (22.6 kg)
 plastic pail. Sold 1 per inner pack/1 per outer pack.

Color hardener is a powder that is applied to the surface of the concrete. As the name indicates it serves two purposes; it colors the concrete but also hardens the surface. This application is best used in high traffic areas and areas where freeze-thaw issues might arise and is ideal for smaller applications.



Step 1: Working the Concrete

- The initial leveling is performed using a screed. A concrete tamper is then used to push the larger aggregate down while working the cream to the surface, allowing smoother finishing and stamping. At this point the slab should be bull floated and initial edging can start.



Step 2: Coloring the Concrete

- After letting most additional bleed water evaporate, the color hardener is applied. This consists of simply casting 75-80% of the colorant powder onto the surface. Once the surface is completely covered, troweling and final edging should be done. Repeat the process of using the remaining 20-25% of colorant powder. Using a fresno is the final stage before using release and beginning stamping.
- Note: The use of a fresno should be avoided if freeze-thaw is an issue. Instead, the final finish should be performed with a wood or magnesium bull float.



Step 3: Release

- The release agent should be evenly cast onto the surface. Stamps should also be coated with release powder to increase effectiveness. The release serves dual purposes; it reduces the bonding that would occur between the concrete and the stamp, and it adds the contrast that creates the depth and texture of natural stone.



Step 4: Stamping

- Set the first mat and make sure every other mat is set tight, preventing extra wide grout lines and reducing touch up work. Use a hand tamper to ensure the complete transfer of the pattern. Flex mats and skins are used to transfer patterns in the areas that require less than a full stamp. It may be necessary to touch up some of the joints using a chisel or roller before the concrete has dried.



Step 5: Finishing Up

- After the concrete has cured sufficiently, typically 1-2 days, the surface should be pressure washed to remove excess release powder. The goal is to leave enough release to give you the desired color and contrast for the project. The look of wet concrete will closely resemble the finished product. The concrete should be allowed to dry thoroughly and then be sealed.



Important Notice: This information should only be used as a general overview. **MARSHALLTOWN** cannot address every installation's circumstances and requirements. Always consult and follow all local, state and federal guidelines.

Warranty Disclaimer/Limitation of Liability: Marshalltown Company makes no warranties regarding this product, express or implied, including warranties of fitness for a particular purpose or merchantability. Marshalltown Company, its directors, officers and employees shall not be liable for indirect, special or consequential damages or personal injury arising out of the use or handling of this product whether or not it has been advised of the possibility of such a loss or damage. Purchaser assumes all liability for the use and handling of this product including any injury to third parties. Marshalltown Company maximum liability shall be the price of the product.

Color chart may vary from actual color due to printing, lighting, application and/or usage.





| | | |
|--|---|--|
| Blue Stone EDI Part# 18220 HDBLUST | Nantucket White EDI Part# 18219 HDNANWHT | Ginkgo EDI Part# 18205 HDGINKGO |
| Travertine EDI Part# 18206 HDTRAVER | Gray Plum EDI Part# 18196 HDGRPLM | Coral Gables Pink EDI Part# 18207 HDCGPNK |
| Gray Linen EDI Part# 18216 HDGRLIN | Bone EDI Part# 18217 HDBONE | Wheat EDI Part# 18215 HDWHEAT |
| French Cream EDI Part# 18210 HDFRCRM | Arena Buff EDI Part# 18208 HDARBUFF | Smoke EDI Part# 18209 HDSMOKE |
| Slate Gray EDI Part# 18214 HDSLTGRY | Cape Cod Gray EDI Part# 18212 HDCCGRAY | Storm Gray EDI Part# 18197 HGSTGRY |
| Deep Charcoal EDI Part# 18198 HDDCHAR | Colina Tan EDI Part# 18211 HDCTAN | Walnut EDI Part# 18199 HDWALNUT |
| Brick Red EDI Part# 18200 HDBRKRD | Dark Red EDI Part# 18201 HDDRKRD | Juniper EDI Part# 18218 HDJUNIP |
| Terra Cotta EDI Part# 18202 HDTCOTTA | Chestnut EDI Part# 18203 HDCHSTNT | Russet EDI Part# 18204 HDRUSSET |

Perma-Cast® Antiquing Release Colors

Release is dusted over the surface of freshly colored concrete flatwork before using a pattern-stamping tool. The release agent prevents the tool from sticking to newly colored, freshly stamped concrete. As the tool is pulled from the concrete the colored release powder is layered into the textured surfaces of the concrete. Upon washing and sealing, the difference in color between the underlying concrete and the release creates a visually attractive, antiqued look to the concrete.

Perma-Cast® Antiquing Release is packaged in a 30 lb. (13.6 kg) plastic pail. Coverage is approximately 1000 sq. ft. per 30 lb. (13.6 kg) pail. Sold 1 per inner pack/1 per outer pack.



| | | |
|---|---|---|
|  |  |  |
| Bone | White/Clear | Smoke |
| EDI Part# | EDI Part# | EDI Part# |
| 18241 RBONE | 18221 RCLEAR | 18233 RSMOKE |
|  |  |  |
| Colina Tan | Storm Gray | Deep Charcoal |
| EDI Part# | EDI Part# | EDI Part# |
| 18235 RCTAN | 18223 RSTGRAY | 18224 RDCHAR |
|  |  |  |
| Gray Plum | Slate Gray | Cape Cod Gray |
| EDI Part# | EDI Part# | EDI Part# |
| 18222 RGRPLUM | 18238 RSLTGRY | 18236 RCCGRAY |
|  |  |  |
| French Cream | Wheat | Arena Buff |
| EDI Part# | EDI Part# | EDI Part# |
| 18234 RFRCRM | 18239 RWHEAT | 18232 RABUFF |
|  |  |  |
| Walnut | Russet | Brick Red |
| EDI Part# | EDI Part# | EDI Part# |
| 18225 RWALNUT | 18230 RRUSSET | 18226 RBRKRD |

Warranty Disclaimer/Limitation of Liability: Marshalltown Company makes no warranties regarding this product, express or implied, including warranties of fitness for a particular purpose or merchantability. Marshalltown Company, its directors, officers and employees shall not be liable for indirect, special or consequential damages or personal injury arising out of the use or handling of this product whether or not it has been advised of the possibility of such a loss or damage. Purchaser assumes all liability for the use and handling of this product including any injury to third parties. Marshalltown Company maximum liability shall be the price of the product.

Color chart may vary from actual color due to printing, lighting, application and/or usage.

CHO™ Cleaner



- CHO™ Cleaner removes efflorescence effortlessly
- Ideal for cleaning and preparing concrete, before staining, sealing or overlaying
- Leaves an etched surface which allows for improved penetration of topically applied coloring materials and sealers, and better adhesion of overlays
- Mix 1 lb (.45kg) of CHO™ Cleaner with 1 gal. (3.8L) of water
- 1 gal. (3.8L) of solution will clean approx. 100-150 sq. ft.
- Read the technical data sheet before using
- Sold 1 per inner pack/1 per inner pack.



MARSHALLTOWN The Premier Line

| EDI | Part# | Size lbs | Size kg. |
|-------|----------|----------|----------|
| 18052 | CHOCLNR1 | 1 | .45 |
| 18053 | CHOCLNR5 | 5 | 2.27 |

Clear Guard Cure & Seal



- Clear Guard™ Cure & Seal is a solvent based, non-yellowing, architectural grade, Methyl Methacrylate Acrylic copolymer. The product is formulated for curing and sealing any concrete, but it is specifically designed for concrete that is colored with Uni-Mix® or Perma-Cast® coloring systems.
- Clear Guard™ Cure & Seal should be applied using solvent resistant short nap rollers, hand held pump sprayers or airless sprayers.
- 5 gallons (18.9 L) of Clear Guard™ Cure and Seal covers approximately 1000 sq ft (93 sq m) for curing or 1000-1600 sq ft (93-149 sq m) for sealing
- Clear Guard™ V.O.C. ships LTL hazardous
- SEALER is V.O.C. compliant
- **Note:** SLRCLEAR not available in the following states/locations: CA, CT, DE, District of Columbia, ME, MD, MA, NH, NJ, NY, PA, RI, VT, VA (consult and follow Consumer Product VOC Regulation for specific counties).
- Sold 1 per inner pack/1 per outer pack



MARSHALLTOWN The Premier Line

| EDI | Part# | Description | Size-gal. | Size-liter |
|-------|----------|--------------------|-----------|------------|
| 18249 | SLRCLEAR | Clear Guard Gloss | 5 | 19 |
| 18250 | SEALER | Clear Guard V.O.C. | 5 | 19 |

V.O.C. Clear Liquid Release

- Use where a colored release is not desired or where dust control from a powdered release is an issue
- 5 Gallons (18.9 L) of V.O.C. Clear Liquid Release covers approximately 800 sq. ft. (74 sq M)
- Sold 1 per inner pack/1 per outer pack



MARSHALLTOWN The Premier Line

| EDI | Part# | Description | Size-gal. | Size-liter |
|-------|---------|----------------------|-----------|------------|
| 18242 | CLR REL | Clear Release V.O.C. | 5 | 19 |

H2O Sealer

- Specifically designed for sealing decorative concrete projects to protect the beauty and enhance the coloring effects
- V.O.C. compliant water-based sealers are ideal for indoor use or on projects in poorly ventilated areas
- H2O sealers should be applied using short nap rollers, hand held pump sprayers or airless sprayers.
- 5 gallons (18.9 L) of Clear Guard™ Cure and Seal covers approximately 1000 sq ft (93 sq m) for curing or 1000-1600 sq ft (93-149 sq m) for sealing
- Sold 1 per inner pack/1 per outer pack



MADE IN
U.S.A

MARSHALLTOWN The Premier Line

| EDI | Part# | Description | Size-gal. | Size-liter |
|-------|--------|---------------|-----------|------------|
| 13371 | H2OWL1 | Wet Look | 1 | 3.8 |
| 13372 | H2OWL5 | Wet Look | 5 | 19 |
| 13373 | H2OCS1 | Cure and Seal | 1 | 3.8 |
| 13374 | H2OCS5 | Cure and Seal | 5 | 19 |

SurfEtch™

- Water based, biodegradable, low odor surface top retarder
- Applied to fresh concrete, chemically delays the set of the surface mortar, while allowing the underlying concrete to harden
- Produces an "exposed aggregate" look, with varying degrees of texture and color
- Coverage is 175-300 sq ft/gallon
- WARNING:** Do not allow product to freeze
- SE41G is sold 4 per inner pack/4 per outer pack; SE5G is sold 1 per inner pack/ 1 per outer pack

NEW!



MADE IN
U.S.A

MARSHALLTOWN The Premier Line

| EDI | Part# | Size-gal. | Size-liter |
|-------|-------|-----------|------------|
| 18901 | SE41G | 1 | 3.8 |
| 18902 | SE5G | 5 | 19 |

T1000™ Primer

- For use as a bonding agent with T1000™ Stampable Overlay
- Can also be used with T1000™ Fine Overlay
- For interior or exterior and horizontal or vertical use.
- Mix 1:1 with water, coverage is approximately 400 sq. ft. per gal (3.8 L)
- WARNING:** Do not allow to freeze
- Sold 1 per inner pack/1 per outer pack



MADE IN
U.S.A

MARSHALLTOWN The Premier Line

| EDI | Part# | Size-gal. | Size-liter |
|-------|-----------|-----------|------------|
| 18258 | T1MPRIMER | 1 | 3.8 |

Flattening Paste

- Color flattening paste is added to the clear guard to reduce the shine
- Gives the natural look of stone
- Add 1 container per 5 gallons (18.9 L) of sealer
- Sold 1 per inner pack/1 per outer pack



MADE IN
U.S.A

MARSHALLTOWN The Premier Line

| EDI | Part# | Description | Size-gal. | Size-liter |
|-------|----------|------------------------|-----------|------------|
| 18254 | FLAT PST | Color Flattening Paste | N/A | N/A |

Non-Skid Additive

- Non-skid additive is combined with the sealing process to reduce slipping and sliding
- Add 1 container per 5 gallons (18.9 L) of sealer
- Not recommended for use with chemical sprayers
- Sold 1 per inner pack/6 per outer pack



MADE IN
U.S.A

MARSHALLTOWN The Premier Line

| EDI | Part# | Description | Size-gal. | Size-liter |
|-------|---------|-------------------|-----------|------------|
| 18255 | NONSKID | Non-Skid Additive | N/A | N/A |

Micro-Cem

- Use to restore worn or color blemished concrete, or correcting construction errors when a smooth hard trowel finish is desired
- Engineered for ultra-thin applications
- To be used in conjunction with Micro-Cem™ Polymer and T-1000 Primer
- One 55 pound bag of Micro-Cem™ requires 5 quarts of polymer and yields 96 sq ft at 1/16" thick
- Sold 1 per inner pack / 1 per outer pack



NEW!
MADE IN
U.S.A

MARSHALLTOWN The Premier Line

| EDI | Part# | Description | Size | Size |
|-------|------------|--------------|-------|----------|
| 18905 | MICROCGRAY | Coarse Gray | 55 lb | 25 Kg |
| 18906 | MICROCWHT | Coarse White | 55 lb | 25 Kg |
| 18909 | MICROPOLY5 | Polymer | 5 Gal | 19 Liter |

Gauge Rakes

- Made of lightweight, powder-coated aluminum
- Adjusts up to 2" (51mm) for uniform coating of surfaces
- Comes with 60" (1524mm) tapered ash handle
- GRH** sold with bracket; bolts not included
- Sold 1 per inner pack/1 per outer pack, 6 per inner pack/6 per outer pack where noted with *

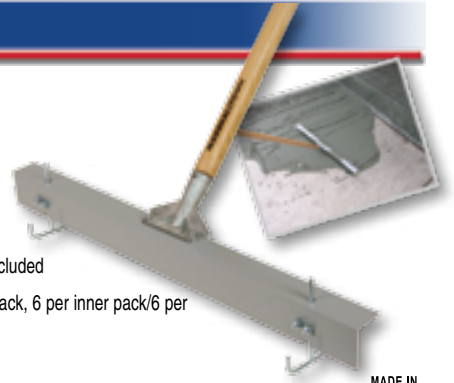

MADE IN
U.S.A

MARSHALLTOWN The Premier Line

| EDI | Part# | Description | Size-in. | Size-mm |
|-------|-------|---------------------|----------|---------|
| 16047 | GR24 | Gauge Rake | 24 | 610 |
| 16048 | GR36 | Gauge Rake | 36 | 914 |
| 16046 | GRH | Replacement Handle* | 60 | 1524 |

Quik-Mix Mixers

- Blade is securely welded to $\frac{3}{8}$ " (10mm) hex shaft
- Saves time and energy
- Ideal for stirring concrete overlays
- For more details and size options **see page 163**

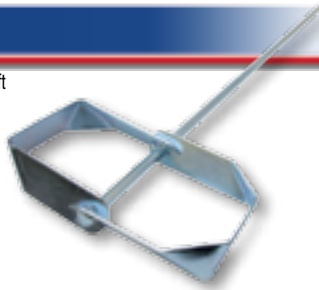

Urethane Coated Tamper

- Shock-absorbing urethane coated head
- Hardwood handle
- Sold 1 per inner pack/1 per outer pack



MADE IN
U.S.A.

MARSHALLTOWN The Premier Line

| EDI | Part# | Size-in. | Size-mm |
|-------|-------|----------|-----------|
| 18963 | HT9R | 9 X 9 | 229 X 229 |

Adjustable Squeegee Trowels

- Adjust the pitch 35° in either direction
- Used with overlays to remove lines
- For more details and size options **see page 186**



Masonry Brush

- Bristles made of white Tampico fiber
- $3\frac{1}{2}$ " (89mm) bristles are set securely in hardwood block
- Ideal for broadcasting release for decorative concrete applications
- For more details and size options **see page 29**



Get On It Shoes

- Wide sole helps distribute weight evenly
- Allows for earlier access on texture skins
- Ratcheting foot straps are quick to attach and adjust
- Sold 1 pair per inner pack/1 pair per outer pack



MADE IN
U.S.A.

MARSHALLTOWN The Premier Line

| EDI | Part# | Size-in. | Size-mm |
|-------|----------|-----------------------------------|-----------|
| 18961 | GOISHOES | 8 $\frac{1}{2}$ X 6 $\frac{1}{2}$ | 216 X 165 |

Dust Masks

- Lightweight, disposable paper filter mask
- Use while applying color hardener, or powdered release
- For more details **see page 183**



SharpShooter® I Hopper Gun

- Specifically formulated nylon gun
- Seven orifice sizes
- Tight sealing flow shutoff prevents leakage
- Easy pull swing trigger for greater control and less fatigue
- Used for spraying T1000™ Sprayable Fine Overlay
- For more details **see page 190**



Gunite Shoes

- Used for installing overlays
- 1" (25mm) plated steel spikes are pre-installed and recessed into a flexible black plastic sole
- Cinching buckle clips
- Sold 1 per inner pack/10 per outer pack



MARSHALLTOWN The Premier Line

| EDI | Part# | Size-in. | Size-mm |
|-------|-------|----------|---------|
| 16186 | 6186 | 12 | 305 |

Direct Fire Melting Kettles

- Comes complete with hand agitator, temp gauge, torch head, hose, regulator, propane bottle holder, hinge fill lid, lifting handles and gravity pour spout
- 14 gauge double wall steel construction with vent holes
- Will provide hot material in just minutes
- Propane bottle not included
- Available in 10 gallon (27" x 16" x 24"- 85lbs.) and 30 gallon (49" x 23" x 37"- 190lbs.) sizes
- Replacement parts available
- Will fit in the back of most trucks, or can be trailer mounted
- **RED704984** features a propane bottle holder
- Sold 1 per inner pack/1 per outer pack
- These items ship LTL



RED704985



RED704984

MARSHALLTOWN The Premier Line

| EDI | Part# | Description | Capacity |
|-------|-----------|--------------------|------------------|
| 20102 | RED704984 | Direct Fire Melter | 10 gal. (37.8L) |
| 20103 | RED704985 | Direct Fire Melter | 30 gal. (113.6L) |

REPLACEMENT PARTS

| EDI | Part# | Description |
|-------|-----------|---------------------------------------|
| 26590 | RED704980 | Molasses Valve |
| 20092 | RED704973 | Complete Torch Assembly Kit |
| 20100 | RED704982 | Torch Head |
| 20099 | RED704981 | LPG Regulator only (no gauge or hose) |
| 20097 | RED704978 | Gauge for LPG Regulator |
| 20101 | RED704983 | 6' (1.8M) LPG Hose |
| 20098 | RED704979 | Temp. Gauge |

Portable Asphalt Melter/Applicator

- Comes complete with hand agitator, temp gauge, torch head, hose, regulator, propane bottle holder and hinge fill lid
- 14 gauge double wall steel construction with vent holes
- Will provide hot material in just minutes
- Melts blocks of hot asphalt crack filler
- Does the work of both a melter and a pour pot all in one machine
- 1/8" thick by 11" rear steel wheels for easy maneuvering
- Dual levers allow the operator to control the shoe and flow valve with one hand
- 10 gallon capacity
- Replacement parts available
- Propane bottle not included
- Collapsible handle and levers allow for UPS delivery
- Sold 1 per inner pack/1 per outer pack



PROPANE REGULATOR VALVE



EASY TO READ TEMP GAUGE



SCAN HERE TO SEE IT IN ACTION!

MADE IN U.S.A.

MARSHALLTOWN The Premier Line

| EDI | Part# | Description | Capacity |
|-------|--------|-------------------------------|----------------|
| 27223 | AT10MA | Direct Fire Melter/Applicator | 10 gal (37.8L) |

REPLACEMENT PARTS

| EDI | Part# | Description |
|-------|-----------|---------------------------------------|
| 20092 | RED704973 | Complete Torch Assembly Kit |
| 20100 | RED704982 | Torch Head |
| 20099 | RED704981 | LPG Regulator Only (No Gauge or Hose) |
| 20097 | RED704978 | Gauge for LPG Regulator |
| 20101 | RED704983 | 6' (1.8M) LPG Hose |

REPLACEMENT PARTS

| EDI | Part# | Description |
|-------|-----------|--------------------------------|
| 20098 | RED704979 | Temp. Gauge |
| 20095 | RED704976 | Inner Control Valve |
| 20094 | RED704975 | Steel Back Wheels - Set of Two |
| 20093 | RED704974 | Front Swivel Wheel |
| 20096 | RED704977 | 3" (76mm) Melter Shoe |

Asphalt Banding Machine

- Dispenses a uniform 3" (76mm) banded finish up to 1/8" (3mm) thick over cracks
- Made of durable 14 gauge steel
- Machine is pulled backwards, using guide to follow cracks
- Wear shoe is reversible, extending its life by at least three times before replacing
- Use with hot or cold crack sealants
- 4 gallon capacity hopper
- 6" (152mm) diameter steel disk wheels
- Sold 1 per inner pack/1 per outer pack



MARSHALLTOWN The Premier Line

| EDI | Part# | Description | Capacity |
|-------|-----------|-------------------------|---------------|
| 20104 | RED704986 | Asphalt Banding Machine | 4 gal (15.1L) |
| 26591 | RED714197 | Bander Wear Plate Repl. | N/A |

Pour Pots

- Durable, 14 gauge steel welded steel construction
- Fingertip nozzle control
- Adjustable pouring nozzle from 1/2" (13mm) down to 3/8" (10mm)
- Used to apply cold crack sealants
- Sold 1 per inner pack/1 per outer pack



MARSHALLTOWN The Premier Line

| EDI | Part# | Description | Capacity |
|-------|------------|-----------------------|-----------------|
| 20106 | RED704988 | Pour Pot w/Legs | 2.6 gal. (9.8L) |
| 20110 | RED704988W | Pour Pot w/Wheels | 2.6 gal. (9.8L) |
| 20107 | RED704989 | Pour Pot w/ Long Hndl | 2.6 gal. (9.8L) |

Lute Blade Styles

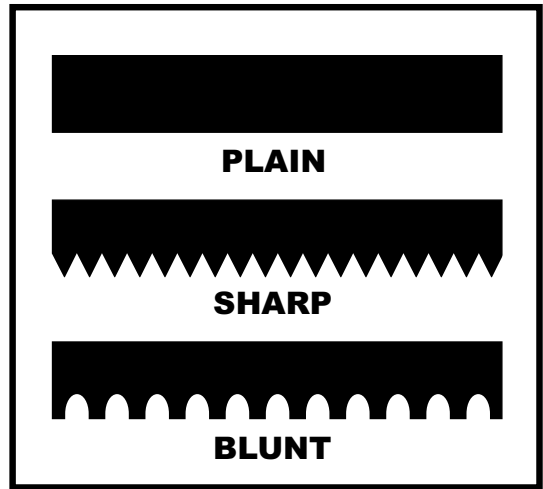

Magnesium Lutes

- Durable, lightweight magnesium head
- Square to round wood handle for better grip
- Used for smoothing and leveling fresh asphalt prior to compacting
- Easily replaceable blade, connector and handle
- Sold 1 per inner pack/1 per outer pack, sold 1 per inner pack/12 per outer pack where noted with *

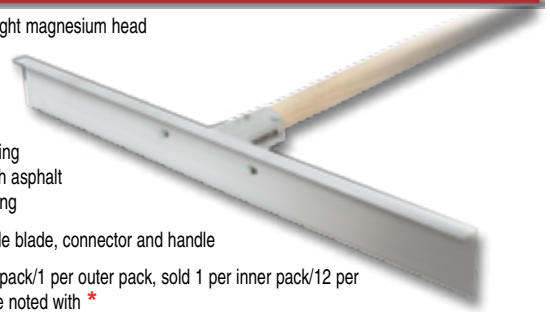

MARSHALLTOWN The Premier Line

| EDI | Part# | Description | Size-in. | Size-mm |
|-------|--------------|-----------------------------|----------|----------|
| 24442 | RED700232 | Lute w/66" Wood Handle | 3 x 30 | 76 x 762 |
| 24569 | RED700232-84 | Lute w/84" Wood Handle | 3 x 30 | 76 x 762 |
| 24521 | RED702366 * | Blade Only | 3 x 30 | 76 x 762 |
| 24485 | RED701048 | Connector | N/A | N/A |
| 26457 | RED804136 | Square to Round Wood Handle | 60 | 1524 |
| 26458 | RED804137 | Square to Round Wood Handle | 84 | 2,134 |

Magnesium Asphalt Rake

- Lightweight "T" section blade has blunt teeth which are designed to allow material to pass through without catching
- Rugged formed steel pole connector prevents breakage and ensures rigidity
- 839 72 X 1 1/4" (1829 X 31mm) handle sold separately
- Sold 1 per inner pack/12 per outer pack

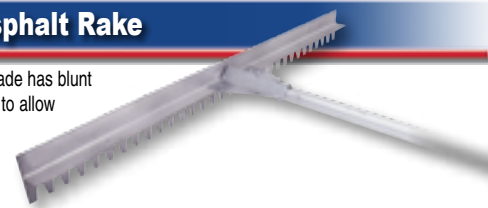

MARSHALLTOWN The Premier Line

| EDI | Part# | Description | Size-in. | Size-mm |
|-------|-------|-------------|----------|---------|
| 16438 | 838 | Lute Head | 36 | 914 |
| 16439 | 839 | Handle Only | 72 | 1829 |

MADE IN
U.S.A.

ASPHALT TOOLS

Magnesium Lute Rakes with T-Connector & Snap Handle

- Durable construction
- Includes magnesium snap handle
- Available with 1 3/8" (35mm) or 1 3/4" (44mm) diameter handle
- All parts are easily replaceable
- All handles are 6' 7" or 9' long with rubber end grip
- **New items are in table in red**
- Sold 1 per inner pack/1 per outer pack

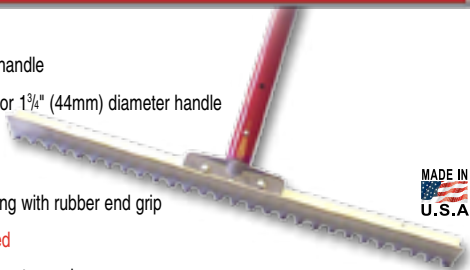

MADE IN
U.S.A

MARSHALLTOWN The Premier Line

| EDI | Part# | Description | Size-in. | Size-mm | Blade Type |
|-------|-----------|---------------------------|----------|----------|------------|
| 24461 | RED700289 | Lute w/6' X 1 3/8" handle | 3 x 32 | 76 x 813 | Blunt |
| 26991 | RED700290 | Lute w/6' X 1 3/8" handle | 3 x 32 | 76 x 813 | Sharp |
| 26992 | RED700291 | Lute w/6' X 1 3/8" handle | 3 x 32 | 76 x 813 | Plain |
| 26993 | RED700292 | Lute w/6' X 1 3/8" handle | 3 x 36 | 76 x 914 | Blunt |
| 26994 | RED700293 | Lute w/6' X 1 3/8" handle | 3 x 36 | 76 x 914 | Sharp |
| 26995 | RED700294 | Lute w/6' X 1 3/8" handle | 3 x 36 | 76 x 914 | Plain |
| 26996 | RED700983 | Lute w/6' X 1 3/4" handle | 3 x 32 | 76 x 813 | Blunt |
| 26997 | RED700984 | Lute w/6' X 1 3/4" handle | 3 x 32 | 76 x 813 | Sharp |
| 26998 | RED700985 | Lute w/6' X 1 3/4" handle | 3 x 32 | 76 x 813 | Plain |
| 26999 | RED700986 | Lute w/6' X 1 3/4" handle | 3 x 36 | 76 x 914 | Blunt |
| 27000 | RED700987 | Lute w/6' X 1 3/4" handle | 3 x 36 | 76 x 914 | Sharp |
| 27001 | RED700989 | Lute w/6' X 1 3/4" handle | 3 x 36 | 76 x 914 | Plain |
| 27224 | RED901000 | Lute w/7' X 1 3/4" handle | 3 x 32 | 76 x 813 | Blunt |
| 27225 | RED901001 | Lute w/7' X 1 3/4" handle | 3 x 32 | 76 x 813 | Sharp |
| 27226 | RED901002 | Lute w/7' X 1 3/4" handle | 3 x 32 | 76 x 813 | Plain |
| 27227 | RED901003 | Lute w/7' X 1 3/4" handle | 3 x 36 | 76 x 914 | Blunt |
| 27228 | RED901004 | Lute w/7' X 1 3/4" handle | 3 x 36 | 76 x 914 | Sharp |
| 27229 | RED901005 | Lute w/7' X 1 3/4" handle | 3 x 36 | 76 x 914 | Plain |
| 27230 | RED901006 | Lute w/9' X 1 3/4" handle | 3 x 32 | 76 x 813 | Blunt |
| 27231 | RED901007 | Lute w/9' X 1 3/4" handle | 3 x 32 | 76 x 813 | Sharp |
| 27232 | RED901008 | Lute w/9' X 1 3/4" handle | 3 x 32 | 76 x 813 | Plain |
| 27233 | RED901009 | Lute w/9' X 1 3/4" handle | 3 x 36 | 76 x 914 | Blunt |
| 27234 | RED901010 | Lute w/9' X 1 3/4" handle | 3 x 36 | 76 x 914 | Sharp |
| 27235 | RED901011 | Lute w/9' X 1 3/4" handle | 3 x 36 | 76 x 914 | Plain |

REPLACEMENT BLADES

| EDI | Part# | Description | Size-in. | Size-mm | Blade Type |
|-------|-----------|------------------|----------|----------|------------|
| 24503 | RED702032 | Repl. Blade Only | 3 x 32 | 76 x 813 | Blunt |
| 24504 | RED702033 | Repl. Blade Only | 3 x 32 | 76 x 813 | Sharp |
| 24507 | RED702036 | Repl. Blade Only | 3 x 32 | 76 x 813 | Plain |
| 24505 | RED702034 | Repl. Blade Only | 3 x 36 | 76 x 914 | Blunt |
| 24506 | RED702035 | Repl. Blade Only | 3 x 36 | 76 x 914 | Sharp |
| 24508 | RED702037 | Repl. Blade Only | 3 x 36 | 76 x 914 | Plain |

REPLACEMENT PARTS

| EDI | Part# | Description | Size-in. | Size-mm |
|-------|-----------|----------------|-------------|-----------|
| 27238 | RED901014 | Repl Handle | 6' X 1 3/8" | 1828 X 35 |
| 27239 | RED901015 | Repl Handle | 6' X 1 3/4" | 1828 X 44 |
| 27236 | RED901012 | Repl Handle | 7' X 1 3/4" | 2133 X 44 |
| 27237 | RED901013 | Repl Handle | 9' X 1 3/4" | 2743 X 44 |
| 24484 | RED701047 | Connector Only | N/A | N/A |

Magnesium Lute Rakes with T-Connector

- Durable lightweight magnesium head
- Includes 1 3/8" (35mm) aluminum handle available in three different lengths
- All parts are easily replaceable
- Sold 1 per inner pack/1 per outer pack



MADE IN
U.S.A

MARSHALLTOWN The Premier Line

| EDI | Part# | Description | Size-in. | Size-mm | Blade Type |
|-------|------------|------------------|----------|----------|------------|
| 24544 | RED700026C | Lute w/6' handle | 3 x 32 | 76 x 813 | Blunt |
| 24547 | RED700028C | Lute w/6' handle | 3 x 32 | 76 x 813 | Sharp |
| 24549 | RED700030C | Lute w/6' handle | 3 x 32 | 76 x 813 | Plain |
| 24545 | RED700027C | Lute w/6' handle | 3 x 36 | 76 x 914 | Blunt |
| 24548 | RED700029C | Lute w/6' handle | 3 x 36 | 76 x 914 | Sharp |
| 24550 | RED700031C | Lute w/6' handle | 3 x 36 | 76 x 914 | Plain |
| 24551 | RED700081C | Lute w/7' handle | 3 x 32 | 76 x 813 | Blunt |
| 24557 | RED700094C | Lute w/7' handle | 3 x 32 | 76 x 813 | Sharp |
| 24561 | RED700104C | Lute w/7' handle | 3 x 32 | 76 x 813 | Plain |
| 24553 | RED700083C | Lute w/7' handle | 3 x 36 | 76 x 914 | Blunt |
| 24559 | RED700096C | Lute w/7' handle | 3 x 36 | 76 x 914 | Sharp |
| 24563 | RED700106C | Lute w/7' handle | 3 x 36 | 76 x 914 | Plain |
| 24552 | RED700082C | Lute w/8' handle | 3 x 32 | 76 x 813 | Blunt |
| 24558 | RED700095C | Lute w/8' handle | 3 x 32 | 76 x 813 | Sharp |
| 24562 | RED700105C | Lute w/8' handle | 3 x 32 | 76 x 813 | Plain |
| 24554 | RED700084C | Lute w/8' handle | 3 x 36 | 76 x 914 | Blunt |
| 24560 | RED700097C | Lute w/8' handle | 3 x 36 | 76 x 914 | Sharp |
| 24564 | RED700107C | Lute w/8' handle | 3 x 36 | 76 x 914 | Plain |

REPLACEMENT PARTS

| EDI | Part# | Description | Size-in. | Size-mm | Blade Type |
|-------|-----------|-------------------|----------|----------|------------|
| 24503 | RED702032 | Repl. Blade Only | 3 x 32 | 76 x 813 | Blunt |
| 24504 | RED702033 | Repl. Blade Only | 3 x 32 | 76 x 813 | Sharp |
| 24507 | RED702036 | Repl. Blade Only | 3 x 32 | 76 x 813 | Plain |
| 24505 | RED702034 | Repl. Blade Only | 3 x 36 | 76 x 914 | Blunt |
| 24506 | RED702035 | Repl. Blade Only | 3 x 36 | 76 x 914 | Sharp |
| 24508 | RED702037 | Repl. Blade Only | 3 x 36 | 76 x 914 | Plain |
| 24496 | RED701079 | Repl. Handle Only | 72 | 1829 | N/A |
| 24497 | RED701080 | Repl. Handle Only | 84 | 2134 | N/A |
| 24498 | RED701081 | Repl. Handle Only | 96 | 2438 | N/A |
| 24484 | RED701047 | Connector Only | N/A | N/A | N/A |

Braced Magnesium Lute Rakes

- Durable lightweight magnesium head
- Combination lute rake
- Aluminum handle
- Metal brace with collar
- All parts are easily replaceable
- Sold 1 per inner pack/1 per outer pack

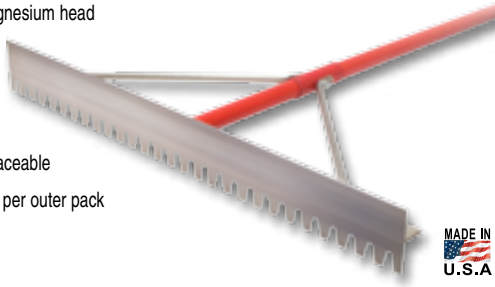

MADE IN
U.S.A

MARSHALLTOWN The Premier Line

| EDI | Part# | Description | Size-in. | Size-mm | Blade Type |
|-------|-----------|-----------------------------|----------|----------|------------|
| 24414 | RED700088 | Braced Lute Rake w/6' Hndl. | 3 x 32 | 76 x 813 | Blunt |
| 24424 | RED700098 | Braced Lute Rake w/6' Hndl. | 3 x 32 | 76 x 813 | Sharp |
| 24434 | RED700108 | Braced Lute Rake w/6' Hndl. | 3 x 32 | 76 x 813 | Plain |
| 24417 | RED700091 | Braced Lute Rake w/6' Hndl. | 3 x 36 | 76 x 914 | Blunt |
| 24427 | RED700101 | Braced Lute Rake w/6' Hndl. | 3 x 36 | 76 x 914 | Sharp |
| 24437 | RED700111 | Braced Lute Rake w/6' Hndl. | 3 x 36 | 76 x 914 | Plain |
| 24415 | RED700089 | Braced Lute Rake w/7' Hndl. | 3 x 32 | 76 x 813 | Blunt |
| 24425 | RED700099 | Braced Lute Rake w/7' Hndl. | 3 x 32 | 76 x 813 | Sharp |
| 24435 | RED700109 | Braced Lute Rake w/7' Hndl. | 3 x 32 | 76 x 813 | Plain |
| 24418 | RED700092 | Braced Lute Rake w/7' Hndl. | 3 x 36 | 76 x 914 | Blunt |
| 24428 | RED700102 | Braced Lute Rake w/7' Hndl. | 3 x 36 | 76 x 914 | Sharp |
| 24438 | RED700112 | Braced Lute Rake w/7' Hndl. | 3 x 36 | 76 x 914 | Plain |
| 24416 | RED700090 | Braced Lute Rake w/8' Hndl. | 3 x 32 | 76 x 813 | Blunt |
| 24426 | RED700100 | Braced Lute Rake w/8' Hndl. | 3 x 32 | 76 x 813 | Sharp |
| 24436 | RED700110 | Braced Lute Rake w/8' Hndl. | 3 x 32 | 76 x 813 | Plain |
| 24419 | RED700093 | Braced Lute Rake w/8' Hndl. | 3 x 36 | 76 x 914 | Blunt |
| 24429 | RED700103 | Braced Lute Rake w/8' Hndl. | 3 x 36 | 76 x 914 | Sharp |
| 24439 | RED700113 | Braced Lute Rake w/8' Hndl. | 3 x 36 | 76 x 914 | Plain |

REPLACEMENT PARTS

| EDI | Part# | Description | Size-ft. | Size-M |
|-------|-----------|--------------------------|----------|--------|
| 24490 | RED701068 | Braced Repl. Handle Only | 6 | 1.8 |
| 24491 | RED701069 | Braced Repl. Handle Only | 7 | 2.1 |
| 24492 | RED701070 | Braced Repl. Handle Only | 8 | 2.4 |
| 24501 | RED701144 | Single Brace for Lute | N/A | N/A |

REPLACEMENT BLADES

| EDI | Part# | Description | Size-in. | Size-mm | Blade Type |
|-------|-----------|------------------|----------|----------|------------|
| 24503 | RED702032 | Repl. Blade Only | 3 x 32 | 76 x 813 | Blunt |
| 24504 | RED702033 | Repl. Blade Only | 3 x 32 | 76 x 813 | Sharp |
| 24507 | RED702036 | Repl. Blade Only | 3 x 32 | 76 x 813 | Plain |
| 24505 | RED702034 | Repl. Blade Only | 3 x 36 | 76 x 914 | Blunt |
| 24506 | RED702035 | Repl. Blade Only | 3 x 36 | 76 x 914 | Sharp |
| 24508 | RED702037 | Repl. Blade Only | 3 x 36 | 76 x 914 | Plain |

Unbraced Magnesium Lute Rakes

- Durable lightweight magnesium head
- Combination lute rake
- Aluminum handle
- All parts are easily replaceable
- Sold 1 per inner pack/1 per outer pack



MADE IN
U.S.A

MARSHALLTOWN The Premier Line

| EDI | Part# | Description | Size-in. | Size-mm | Blade Type |
|-------|-----------|-------------------------|----------|----------|------------|
| 24398 | RED700026 | Unbraced Lute w/6' Hndl | 3 x 32 | 76 x 813 | Blunt |
| 24400 | RED700028 | Unbraced Lute w/6' Hndl | 3 x 32 | 76 x 813 | Sharp |
| 24402 | RED700030 | Unbraced Lute w/6' Hndl | 3 x 32 | 76 x 813 | Plain |
| 24399 | RED700027 | Unbraced Lute w/6' Hndl | 3 x 36 | 76 x 914 | Blunt |
| 24401 | RED700029 | Unbraced Lute w/6' Hndl | 3 x 36 | 76 x 914 | Sharp |
| 24403 | RED700031 | Unbraced Lute w/6' Hndl | 3 x 36 | 76 x 914 | Plain |
| 24410 | RED700081 | Unbraced Lute w/7' Hndl | 3 x 32 | 76 x 813 | Blunt |
| 24420 | RED700094 | Unbraced Lute w/7' Hndl | 3 x 32 | 76 x 813 | Sharp |
| 24430 | RED700104 | Unbraced Lute w/7' Hndl | 3 x 32 | 76 x 813 | Plain |
| 24412 | RED700083 | Unbraced Lute w/7' Hndl | 3 x 36 | 76 x 914 | Blunt |
| 24422 | RED700096 | Unbraced Lute w/7' Hndl | 3 x 36 | 76 x 914 | Sharp |
| 24431 | RED700105 | Unbraced Lute w/8' Hndl | 3 x 32 | 76 x 813 | Plain |
| 24413 | RED700084 | Unbraced Lute w/8' Hndl | 3 x 36 | 76 x 914 | Blunt |

REPLACEMENT PARTS

| EDI | Part# | Description | Size-ft. | Size-M |
|-------|-----------|----------------------------|----------|--------|
| 24487 | RED701065 | Unbraced Repl. Handle Only | 6 | 1.8 |
| 24488 | RED701066 | Unbraced Repl. Handle Only | 7 | 2.1 |

REPLACEMENT BLADES

| EDI | Part# | Description | Size-in. | Size-mm | Blade Type |
|-------|-----------|------------------|----------|----------|------------|
| 24503 | RED702032 | Repl. Blade Only | 3 x 32 | 76 x 813 | Blunt |
| 24504 | RED702033 | Repl. Blade Only | 3 x 32 | 76 x 813 | Sharp |
| 24507 | RED702036 | Repl. Blade Only | 3 x 32 | 76 x 813 | Plain |
| 24505 | RED702034 | Repl. Blade Only | 3 x 36 | 76 x 914 | Blunt |
| 24506 | RED702035 | Repl. Blade Only | 3 x 36 | 76 x 914 | Sharp |
| 24508 | RED702037 | Repl. Blade Only | 3 x 36 | 76 x 914 | Plain |

ASPHALT TOOLS

Lute Rakes with Wood or Fiberglass Handle

- Durable lightweight magnesium head
- Combination lute rake
- Metal brace for more durability
- All parts are easily replaceable
- Wood or fiberglass handles available
- Sold 1 per inner pack/1 per outer pack



MADE IN
U.S.A

MARSHALLTOWN The Premier Line

| EDI | Part# | Description | Size-in. | Size-mm | Blade Type |
|-------|-----------|---------------------------|----------|----------|------------|
| 24463 | RED700547 | Lute Rake w/60" Wood Hndl | 3 x 32 | 76 x 813 | Blunt |
| 24464 | RED700548 | Lute Rake w/60" Wood Hndl | 3 x 32 | 76 x 813 | Sharp |
| 24462 | RED700546 | Lute Rake w/60" Wood Hndl | 3 x 32 | 76 x 813 | Plain |
| 24466 | RED700550 | Lute Rake w/60" Wood Hndl | 3 x 36 | 76 x 914 | Blunt |
| 24467 | RED700551 | Lute Rake w/60" Wood Hndl | 3 x 36 | 76 x 914 | Sharp |
| 24465 | RED700549 | Lute Rake w/60" Wood Hndl | 3 x 36 | 76 x 914 | Plain |

Lute Rakes w/Fiberglass Handle

| EDI | Part# | Description | Size-in. | Size-mm | Blade Type |
|-------|------------|---|----------|----------|------------|
| 24474 | RED700916 | Braced Lute Rake w/60" Fiberglass Hndl. | 3 x 36 | 76 x 914 | Blunt |
| 24570 | RED700916S | Braced Lute Rake w/60" Fiberglass Hndl. | 3 x 36 | 76 x 914 | Sharp |

REPLACEMENT PARTS

| EDI | Part# | Description | Size-in. | Size-mm | Blade Type |
|-------|-----------|-----------------------|----------|----------|------------|
| 24503 | RED702032 | Repl. Blade Only | 3 x 32 | 76 x 813 | Blunt |
| 24504 | RED702033 | Repl. Blade Only | 3 x 32 | 76 x 813 | Sharp |
| 24507 | RED702036 | Repl. Blade Only | 3 x 32 | 76 x 813 | Plain |
| 24505 | RED702034 | Repl. Blade Only | 3 x 36 | 76 x 914 | Blunt |
| 24506 | RED702035 | Repl. Blade Only | 3 x 36 | 76 x 914 | Sharp |
| 24508 | RED702037 | Repl. Blade Only | 3 x 36 | 76 x 914 | Plain |
| 24992 | RED704240 | Repl. 60" Wood Hndl | 60 | 1524 | N/A |
| 24483 | RED701043 | Handle Connector | N/A | N/A | N/A |
| 24501 | RED701144 | Single Brace for Lute | N/A | N/A | N/A |

Asphalt Squeegees

- Aluminum & steel construction for strength and durability
- Black neoprene blade has a durometer of 72 and a temperature rating of 338° F/170° C
- Comes complete with a 60" (1524mm) wood handle
- Replaceable wood handle and reversible blade
- Available with straight or curved blades
- Used for spreading sealers over existing asphalt surfaces
- Sold 2 per inner pack/6 per outer pack
- Sold 1 per inner pack/1 per outer pack where noted with *
- Sold 12 per inner pack/12 per outer pack where noted with **



MARSHALLTOWN The Premier Line

| EDI | Part# | Description | Size-in. | Size-mm |
|-------|------------|-------------------|----------|---------|
| 25697 | RED700244* | Straight w/Handle | 24 | 610 |
| 13712 | 13712* | Straight w/Handle | 30 | 762 |
| 25698 | RED700245* | Straight w/Handle | 36 | 914 |
| 25699 | RED700246* | Straight w/Handle | 48 | 1219 |
| 25700 | RED700247* | Curved w/Handle | 24 | 610 |
| 13715 | 13715* | Curved w/Handle | 30 | 762 |
| 25701 | RED700248* | Curved w/Handle | 36 | 914 |
| 25702 | RED700249* | Curved w/Handle | 48 | 1219 |

SQUEEGEE HEAD & BLADE w/o HANDLE

| EDI | Part# | Description | Size-in. | Size-mm |
|-------|-------|-------------|----------|---------|
| 13702 | 13702 | Straight | 24 | 610 |
| 13703 | 13703 | Straight | 30 | 762 |
| 13704 | 13704 | Straight | 36 | 914 |
| 18644 | 18644 | Straight | 48 | 1219 |
| 13708 | 13708 | Curved | 24 | 610 |
| 13709 | 13709 | Curved | 30 | 762 |
| 13710 | 13710 | Curved | 36 | 914 |
| 18645 | 18645 | Curved | 48 | 1219 |

REPLACEMENT BLADES & HANDLE

| EDI | Part# | Description | Size-in. | Size-mm |
|-------|-----------|----------------|------------|-----------|
| 25729 | RED704926 | Straight Blade | 24 | 610 |
| 13706 | 13706** | Straight Blade | 30 | 762 |
| 25730 | RED704927 | Straight Blade | 36 | 914 |
| 25731 | RED704928 | Straight Blade | 48 | 1219 |
| 25735 | RED704932 | Curved Blade | 24 | 610 |
| 25736 | RED704933 | Curved Blade | 36 | 914 |
| 25737 | RED704934 | Curved Blade | 48 | 1219 |
| 14844 | 4844 | Tapered Handle | 1 1/8 X 60 | 28 X 1524 |

Slant Edge Blade Squeegees

- Aluminum & steel construction for strength and durability
- White neoprene blade has a durometer of 38
- 3" (76mm) slant blade
- Comes complete with a 60" (1524mm) wood handle
- Pull style blade applies precise and consistent layer of many applied fluids
- Replaceable wood handle and reversible blade
- Spreads and smooths at the same time
- Sold 1 per inner pack/1 per outer pack

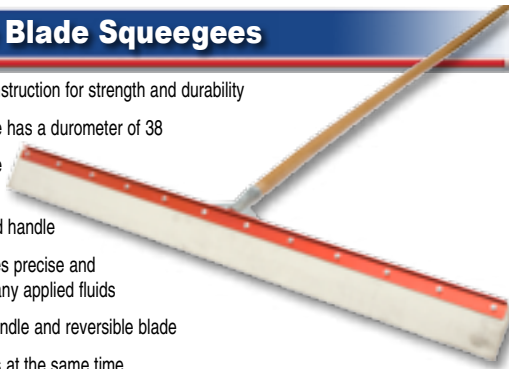

MARSHALLTOWN The Premier Line

| EDI | Part# | Description | Size-in. | Size-mm |
|-------|-----------|---------------------------|----------|---------|
| 25707 | RED700254 | Squeegee w/60" Wood Hndl. | 24 | 610 |
| 25708 | RED700255 | Squeegee w/60" Wood Hndl. | 30 | 762 |
| 25709 | RED700256 | Squeegee w/60" Wood Hndl. | 36 | 914 |
| 25710 | RED700257 | Squeegee w/60" Wood Hndl. | 48 | 1219 |

REPLACEMENT BLADES & HANDLE

| EDI | Part# | Description | Size-in. | Size-mm |
|-------|-----------|------------------|------------|-----------|
| 25754 | RED704953 | Slant Edge Blade | 24 | 610 |
| 25755 | RED704954 | Slant Edge Blade | 30 | 762 |
| 25756 | RED704955 | Slant Edge Blade | 36 | 914 |
| 25757 | RED704956 | Slant Edge Blade | 48 | 1219 |
| 14844 | 4844 | Tapered Handle | 1 1/8 X 60 | 28 X 1524 |

Heavy Duty Floor Squeegees

- Rugged all-steel construction for added strength and durability
- White gum rubber blade has a durometer of 65 and a temperature rating of 392° F/200° C
- Comes complete with a 60" (1524mm) wood handle
- Replaceable wood handle and reversible blade
- Sold 1 per inner pack/1 per outer pack

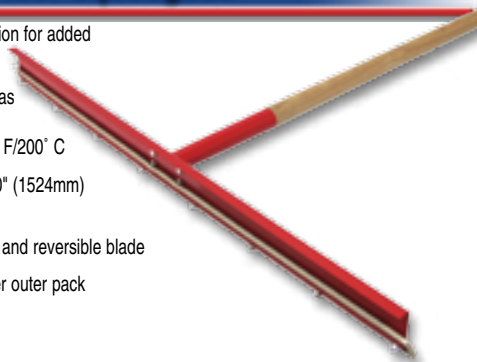

MARSHALLTOWN The Premier Line

| EDI | Part# | Description | Size-in. | Size-mm |
|-------|-----------|---------------------|----------|---------|
| 25738 | RED704935 | Heavy Duty Squeegee | 24 | 610 |
| 25739 | RED704936 | Heavy Duty Squeegee | 36 | 914 |
| 25740 | RED704937 | Heavy Duty Squeegee | 48 | 1219 |

REPLACEMENT BLADES

| EDI | Part# | Description | Size-in. | Size-mm |
|-------|-----------|----------------|----------|---------|
| 25741 | RED704938 | Straight Blade | 24 | 610 |
| 25742 | RED704939 | Straight Blade | 36 | 914 |
| 25743 | RED704940 | Straight Blade | 48 | 1219 |

Push and Pull V Squeegee

- Comes complete with a 54" (1372mm) wood handle
- Forces sealant down into crack while pushing excess material forward
- Use with crack pour pot
- Blades are 1/4" X 2" X 12" (6mm X 51mm X 305mm)
- Sold 1 per inner pack/1 per outer pack



MARSHALLTOWN The Premier Line

| EDI | Part# | Description | Blade |
|-------|------------|--------------------------------|----------------|
| 25713 | RED700993 | Push Squeegee w/54" Wood Hndl. | Black Neoprene |
| 27041 | RED700993R | Push Squeegee w/54" Wood Hndl. | Red Silicone |
| 25714 | RED700994 | Pull Squeegee w/54" Wood Hndl. | Black Neoprene |
| 27042 | RED700994R | Pull Squeegee w/54" Wood Hndl. | Red Silicone |

REPLACEMENT BLADES

| EDI | Part# | Description | Temp-F | Temp-C |
|-------|-----------|----------------------|--------|--------|
| 25725 | RED704916 | Black Neoprene Blade | 338° | 170° |
| 27039 | RED714195 | Red Silicone Blade | 392° | 200° |
| 27040 | RED714196 | White Silicone Blade | 392° | 200° |

Crack Squeegees

- Used for crack repairs on asphalt and concrete
- Durable metal frame
- Handles not included
- Use with our 14844 wood handle (sold separately)
- Sold 1 per inner pack/12 per outer pack



MARSHALLTOWN The Premier Line

| EDI | Part# | Description | Size-in. | Size-mm |
|-------|---------|-----------------------|----------------|-----------|
| 10147 | 10147 | Heavy Duty U Squeegee | 4 1/4 X 10 1/2 | 108 X 267 |
| 10149 | 10147RB | Repl. Blade for 10147 | 20 3/4 X 2 | 527 X 51 |
| 10156 | 10156 | V Shaped Squeegee | 9 X 9 | 229 X 229 |
| 10157 | 10156RB | Repl. Blade for 10156 | 18 X 2 | 457 X 51 |
| 14844 | 4844 | Tapered Handle | 1 1/8 X 60 | 28 X 1524 |

MADE IN
U.S.A

U Shaped Push Crack Squeegee

- Comes complete with a 54" (1372mm) wood handle
- Black neoprene blade
- U shaped cavity leaves a wider path of sealant
- Use with crack pour pot
- Sold 1 per inner pack/1 per outer pack

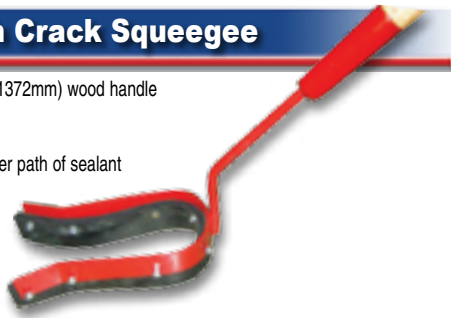

MARSHALLTOWN The Premier Line

| EDI | Part# | Description | Blade |
|-------|-----------|------------------------------------|----------------|
| 27036 | RED700996 | U Shaped Squeegee w/54" Wood Hndl. | Black Neoprene |

REPLACEMENT BLADES

| EDI | Part# | Description | Temp-F | Temp-C |
|-------|-----------|------------------------------|--------|--------|
| 27038 | RED714193 | U Shape Black Neoprene Blade | 338° | 170° |

V Shaped Crack Squeegees

- Unique V shape design allows you to push or pull material into cracks
- Forces sealant down into crack while pushing excess material forward
- Comes complete with a 54" (1372mm) clevis style wood handle
- Use with crack pour pot
- Sold 1 per inner pack/1 per outer pack



MARSHALLTOWN The Premier Line

| EDI | Part# | Description | Blade |
|-------|--------------|------------------------------------|----------------|
| 25744 | RED704942 | V Shaped Squeegee w/54" Wood Hndl. | Black Neoprene |
| 25760 | RED704942-01 | V Shaped Squeegee w/o Wood Hndl | Black Neoprene |

REPLACEMENT BLADE & HANDLE

| EDI | Part# | Description | Temp-F | Temp-C |
|-------|-----------|------------------------------|--------------|--------------|
| 25745 | RED704943 | V Shape Black Neoprene Blade | 338°-F | 170°-C |
| 14844 | 4844 | Tapered Handle | 1 1/8" X 60" | 28 X 1524 mm |

V Shaped Crack Squeegees w/Snap Handle Connector

- Unique V shape design allows you to push or pull material into cracks
- Forces sealant down into crack while pushing excess material forward
- Comes complete with aluminum snap handle adapter for use with standard bull float handles
- Fits 1 1/8" or 1 3/4" bull float snap style handles (snap handles sold separately)
- Use with crack pour pot
- Sold 1 per inner pack/1 per outer pack



MARSHALLTOWN The Premier Line

| EDI | Part# | Description | Blade |
|-------|--------------|---|----------------|
| 25759 | RED704959 | V Shaped Squeegee w/Snap Handle Connector | Black Neoprene |
| 25760 | RED704942-01 | V Shaped Squeegee w/o Connector | Black Neoprene |

Heavy Duty Seal Coating Applicator Brooms

- Complete broom consists of broom with adapter and 1 1/8" X 72" (28mm X 1829mm) wood handle
- Heavy duty synthetic brush strip has 2 1/2" (64mm) trim
- All parts are easily replaceable
- Sold 1 per inner pack/1 per outer pack



MARSHALLTOWN The Premier Line

| EDI | Part# | Description | Size-in. | Size-mm |
|-------|-----------|----------------------------|------------|------------|
| 20403 | RED700372 | Complete Broom | 24 X 72 | 610 X 1829 |
| 20404 | RED700373 | Complete Broom | 36 X 72 | 914 X 1829 |
| 20510 | RED704965 | Repl. Strip | 2 1/4 X 24 | 57 X 610 |
| 20511 | RED704966 | Repl. Strip | 2 1/4 X 36 | 57 X 914 |
| 26595 | RED700376 | Repl. Handle Kit | 1 1/8 X 72 | 28 x 1829 |
| 20509 | RED704964 | Repl. Broom Holder Bracket | N/A | N/A |
| 20468 | RED704123 | Repl. Handle | 1 1/8 X 72 | 28 x 1829 |
| 20514 | RED704969 | Repl. Handle Bracket | N/A | N/A |

Wire Street Broom

- Coated steel wire
- Built strong to withstand heavy duty cleaning of driveways and parking lots
- 3/4" (95mm) bristles
- 1 1/8" X 60" (28mm X 1524mm) tapered wood handle sold separately
- Sold 1 per inner pack/1 per outer pack



MADE IN U.S.A

MARSHALLTOWN The Premier Line

| EDI | Part# | Description | Length-in. | Length-mm |
|-------|-----------|----------------|------------|-----------|
| 20478 | RED704152 | Broom Head | 16 | 406 |
| 14844 | 4844 | Tapered Handle | 1 1/8 X 60 | 28 X 1524 |

Wire Broom

- Ideal for cleaning oil or grease spots
- Built strong to withstand heavy duty cleaning of driveways and parking lots
- 5" (127mm) bristles
- 1 1/8" X 60" (28mm X 1524mm) tapered wood handle sold separately
- Sold 1 per inner pack/1 per outer pack



MADE IN U.S.A

MARSHALLTOWN The Premier Line

| EDI | Part# | Description | Size-in. | Size-mm |
|-------|-----------|----------------|------------|-----------|
| 20547 | RED704133 | Broom Head | 2 3/8 X 12 | 61 X 305 |
| 14844 | 4844 | Tapered Handle | 1 1/8 X 60 | 28 X 1524 |

Wire Scraper Brush

- Oil spot brush with scraper for hard to reach stubborn stains
- 2" (51mm) bristles
- 1 1/8" X 60" (28mm X 1524mm) tapered wood handle sold separately
- Sold 1 per inner pack/1 per outer pack

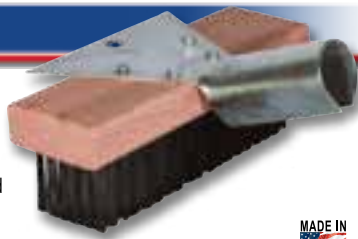

MADE IN
U.S.A

MARSHALLTOWN The Premier Line

| EDI | Part# | Description | Size-in. | Size-mm |
|-------|-----------|----------------|---------------|-----------|
| 20548 | RED704210 | Brush Head | 2 1/4 X 7 1/8 | 57 X 181 |
| 14844 | 4844 | Tapered Handle | 1 1/8 X 60 | 28 X 1524 |

Street or Asphalt Brooms

- For general sweeping prior to resurfacing
- 1 1/8" (28mm) diameter tapered wood handles sold separately
- Sold 1 per inner pack/1 per outer pack



MADE IN
U.S.A

MARSHALLTOWN The Premier Line

| EDI | Part# | Description | Size-in. | Size-mm |
|-------|-----------|------------------|------------|-----------|
| 20471 | RED704126 | Polybase Plastic | 16 | 406 |
| 20472 | RED704127 | Polybase Plastic | 18 | 457 |
| 20473 | RED704128 | Polybase Plastic | 24 | 610 |
| 20475 | RED704130 | Palmyra Stalks | 16 | 406 |
| 14844 | 4844 | Tapered Handle | 1 1/8 X 60 | 28 X 1524 |
| 20468 | RED704123 | Handle | 1 1/8 X 72 | 28 X 1829 |
| 20469 | RED704124 | Handle | 1 1/8 X 96 | 28 X 2438 |

Coarse Asphalt Broom

- Coarse 24" (610mm) brown plastic garage brush used for wet or dry sweeping of rough concrete or asphalt floors
- Will not soften when exposed to water or oils
- 1 1/8" X 60" (28mm X 1524mm) threaded handle included
- Sold 1 per inner pack/1 per outer pack

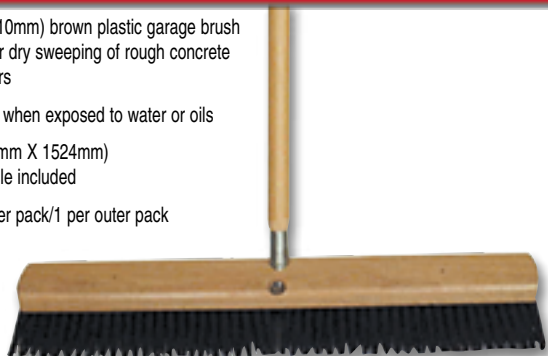

MADE IN
U.S.A

MARSHALLTOWN The Premier Line

| EDI | Part# | Description | Size-in. | Size-mm |
|-------|-----------|-----------------|------------|-----------|
| 20402 | RED700221 | Broom w/ Handle | 24 | 610 |
| 26456 | RED704241 | Repl. Handle | 1 1/8 X 60 | 28 X 1524 |

Asphalt Broom

- 24" (610mm) attached steel blade scrapes and removes ice, snow, construction clean-up and other compacted debris
- Conveniently turns over to convert to a heavy duty 24" (610mm) wide industrial sweeping broom
- Braces provide extra stability and strength
- Handle included
- Sold 1 per inner pack/1 per outer pack



MADE IN
U.S.A

MARSHALLTOWN The Premier Line

| EDI | Part# | Description | Size-in. | Size-mm |
|-------|-----------|-----------------|----------|---------|
| 20454 | RED704041 | Broom w/ Handle | 24 | 610 |

Crack Hoe

- Easily breaks up and dislodges particles of dirt, rock and debris from cracks prior to filling
- Tapered 54" (1371mm) wood handle
- Sold 1 per inner pack/1 per outer pack



MARSHALLTOWN The Premier Line

| EDI | Part# | Size-in. | Size-mm |
|-------|-----------|----------|---------|
| 24268 | RED802900 | 2 1/2 | 64 |

Asphalt Rake

- 14 teeth 3 3/4" (95mm) long
- 15 1/2" (394mm) level head
- 60" (1524mm) lacquered ash handle
- Sold 1 per inner pack/1 per outer pack



MARSHALLTOWN The Premier Line

| EDI | Part# | Size-in. | Size-mm |
|-------|-----------|-------------|------------|
| 24271 | RED802921 | 15 1/2 X 66 | 394 X 1676 |

Cast Iron Tamper

- Heavy duty construction
- Cast iron head
- 48" (1219mm) hardwood handle
- Sold 1 per inner pack/1 per outer pack



MARSHALLTOWN The Premier Line

| EDI | Part# | Size-in. | Size-mm |
|-------|-----------|----------|-----------|
| 25883 | RED804KR2 | 10 X 10 | 254 X 254 |

Welded Dirt Tamper

- Steel pipe construction with welded gussets for increased strength
- 48" (1219mm) steel pipe handle may be filled with sand for added weight
- Sold 1 per inner pack/1 per outer pack

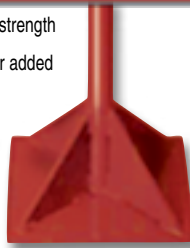

MADE IN
U.S.A

MARSHALLTOWN The Premier Line

| EDI | Part# | Size-in. | Size-mm |
|-------|-----------|----------|-----------|
| 25854 | RED700346 | 8 X 8 | 203 X 203 |
| 25855 | RED700347 | 10 X 10 | 254 X 254 |

Tamper

- Cast iron base
- 42" (1067mm) ash handle
- Used to flatten and smooth dirt, stone, asphalt and other materials
- Sold 1 per inner pack/1 per outer pack



MARSHALLTOWN The Premier Line

| EDI | Part# | Size-in. | Size-mm |
|-------|-------|----------|-----------|
| 14732 | 14732 | 8 X 8 | 203 X 203 |

Tamper

- Cast iron base
- 48" (1219mm) steel handle
- 10" (254mm) rubber grip
- Used to flatten and smooth dirt, stone, asphalt and other materials
- Sold 1 per inner pack/2 per outer pack



QLT^{BY} MARSHALLTOWN

| EDI | Part# | Size-in. | Size-mm |
|-------|-------|----------|-----------|
| 10342 | HT8 | 8 X 8 | 203 X 203 |
| 10343 | HT10 | 10 X 10 | 254 X 254 |

Asphalt Shoes

- Choose from heavy gauge galvanized steel with felt soles or 3/4" (19mm) AC plywood with quick click buckles
- One size fits most
- Allows you to walk on asphalt without compromising the surface
- Tamp and compact hard to reach places
- Plywood shoes act as a thermal barrier and protect your feet from excessive heat
- No hassle quick release adjustable straps
- Sold 1 per inner pack/1 per outer pack



RED704139



RED704138

MADE IN
U.S.A

MARSHALLTOWN The Premier Line

| EDI | Part# | Description | Size-in. | Size-mm |
|-------|-----------|------------------|----------|---------|
| 20086 | RED704138 | Galvanized Steel | N/A | N/A |
| 20087 | RED704139 | AC Plywood | N/A | N/A |

DuraFlex Trowels

Golden Stainless!

- PermaShape® guarantees trowel will maintain original flat shape
- Flat, yet flexible thinner blade makes applications easier with more consistent finish. Great for EIFS applications
- Available with a long or short mounting which allows for more flexibility
- Highest grade, hardened and tempered, golden stainless steel blade, properly shaped and fastened with stainless steel rivets
- Withstands pressure of hard-troweling
- Sold 1 per inner pack/12 per outer pack, 6 per outer pack where noted with *



MOST FLEXIBLE TROWEL AVAILABLE



MADE IN U.S.A.

U.S. Patent Nos. 5,697,265; 5,522,111; 5,791,009

MARSHALLTOWN The Premier Line

| EDI | Part# | Mounting | Blade-in. | Blade-mm | Handle |
|-------|-----------|-----------------|-----------|-----------|--------|
| 14468 | 4468DF | 7 3/4" (197mm) | 12 X 5 | 305 X 127 | |
| 14467 | 4467DFD | 7 3/4" (197mm) | 12 X 5 | 305 X 127 | |
| 14658 | 4658DFL | 9 3/4" (248mm) | 12 X 5 | 305 X 127 | |
| 14663 | 4663DFDL | 9 3/4" (248mm) | 12 X 5 | 305 X 127 | |
| 14470 | 4470DF | 7 3/4" (197mm) | 13 X 5 | 330 X 127 | |
| 14469 | 4469DFD | 7 3/4" (197mm) | 13 X 5 | 330 X 127 | |
| 14665 | 4665DFL | 9 3/4" (248mm) | 13 X 5 | 330 X 127 | |
| 14681 | 4681DFDL | 9 3/4" (248mm) | 13 X 5 | 330 X 127 | |
| 14472 | 4472DF | 9 3/4" (248mm) | 14 X 5 | 356 X 127 | |
| 14471 | 4471DFD | 9 3/4" (248mm) | 14 X 5 | 356 X 127 | |
| 14682 | 4682DFL | 11 5/8" (295mm) | 14 X 5 | 356 X 127 | |
| 14683 | 4683DFDL | 11 5/8" (295mm) | 14 X 5 | 356 X 127 | |
| 14474 | 4474DF* | 11 5/8" (295mm) | 16 X 5 | 406 X 127 | |
| 14473 | 4473DFD* | 11 5/8" (295mm) | 16 X 5 | 406 X 127 | |
| 14694 | 4694DFL* | 13 5/8" (346mm) | 16 X 5 | 406 X 127 | |
| 14713 | 4713DFDL* | 13 5/8" (346mm) | 16 X 5 | 406 X 127 | |

PermaShape® "Flat"

Golden Stainless!

- Guaranteed to stay flat use after use
- Made from highest grade stainless steel
- Properly shaped and tempered to a golden finish
- Withstands pressure of hard-troweling
- Flat blade makes applications easier with more consistent finish
- Choice of resilient DuraSoft® handle or smooth, natural finish hardwood handle
- Sold 1 per inner pack/12 per outer pack, 6 per outer pack where noted with *



MADE IN U.S.A.

U.S. Patent Nos. 5,522,111; 5,697,265; and 5,791,009

MARSHALLTOWN The Premier Line

| EDI | Part# | Size-in. | Size-mm | Handle |
|-------|-----------|----------------|-----------|--------|
| 12173 | 1GSFP | 11 X 4 1/2 | 279 X 114 | |
| 12174 | 1GSFPD | 11 X 4 1/2 | 279 X 114 | |
| 12171 | 4GSFP | 11 1/2 X 4 3/4 | 292 X 121 | |
| 12172 | 4GSFPD | 11 1/2 X 4 3/4 | 292 X 121 | |
| 12177 | 62GSFP | 12 X 4 | 305 X 102 | |
| 12178 | 62GSFPD | 12 X 4 | 305 X 102 | |
| 12167 | 7GSFP | 12 X 5 | 305 X 127 | |
| 12168 | 7GSFPD | 12 X 5 | 305 X 127 | |
| 12165 | 13GSFP | 13 X 5 | 330 X 127 | |
| 12166 | 13GSFPD | 13 X 5 | 330 X 127 | |
| 12169 | 145GSFP | 14 X 5 | 356 X 127 | |
| 12170 | 145GSFPD | 14 X 5 | 356 X 127 | |
| 12175 | 165GSFP* | 16 X 5 | 406 X 127 | |
| 12176 | 165GSFPD* | 16 X 5 | 406 X 127 | |

PermaShape® "Broken-In"

Golden Stainless!

- Broken-in shape eliminates line and ripple marks right from the start
- Guaranteed to maintain original broken-in shape
- For more details and size options **see page 39**



PermaShape® "Flat"

Stainless Steel!

- Guaranteed to stay flat use after use
- Made from highest grade stainless steel
- Properly shaped and tempered
- Withstands pressure of hard-troweling
- Flat blade makes applications easier with more consistent finish
- Choice of resilient DuraSoft® handle or smooth, natural finish hardwood handle
- Sold 1 per inner pack/12 per outer pack



MADE IN U.S.A

U.S. Patent Nos. 5,522,111; 5,697,265; and 5,791,009

MARSHALLTOWN The Premier Line

| EDI | Part# | Size-in. | Size-mm | Handle |
|-------|---------|----------|-----------|--------|
| 12179 | 1SSFP | 11 X 4½ | 279 X 114 | |
| 12180 | 1SSFPD | 11 X 4½ | 279 X 114 | |
| 12181 | 4SSFP | 11½ X 4¾ | 292 X 121 | |
| 12182 | 4SSFPD | 11½ X 4¾ | 292 X 121 | |
| 12183 | 13SSFP | 13 X 5 | 330 X 127 | |
| 12184 | 13SSFPD | 13 X 5 | 330 X 127 | |

Bright Stainless Steel

Stainless Steel!

- Made from the highest grade stainless steel
- For more details and size options **see page 43**



Golden Stainless Steel

Golden Stainless!

- Made from the highest grade stainless steel
- For more details and size options **see page 43**



High Carbon Steel

- Highest grade high carbon spring steel blade
- For more details and size options **see pages 41-42**



Carbon Steel

- Pre-shaped across length and width of blade
- Sold 4 per inner pack/12 per outer pack



MADE IN U.S.A

U.S. Patent No.5,522,111

QLT BY MARSHALLTOWN

| EDI | Part# | Size-in. | Size-mm |
|-------|--------|----------|-----------|
| 13838 | FT377R | 13 X 5 | 330 X 127 |

Carbon Steel

- Cast aluminum mounting securely riveted to tempered, polished steel blade
- Mounting has a square shank to prevent handle from turning
- Sold 4 per inner pack/12 per outer pack

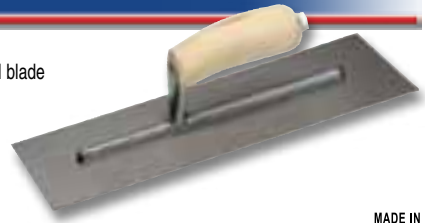

MADE IN U.S.A

QLT BY MARSHALLTOWN

| EDI | Part# | Size-in. | Size-mm |
|-------|-------|----------|-----------|
| 13805 | FT366 | 11 X 4½ | 279 X 114 |
| 13806 | FT367 | 13 X 5 | 330 X 127 |
| 13807 | FT368 | 12 X 5 | 305 X 127 |

Carbon Steel

- Aluminum mounting
- Comfortable, curved wood handle
- Polished steel blade
- Sold 12 per inner pack/60 per outer pack

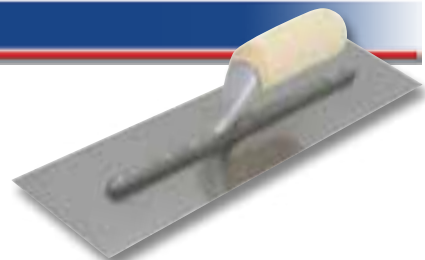

QLT BY MARSHALLTOWN

| EDI | Part# | Size-in. | Size-mm |
|-------|-------|----------|-----------|
| 12194 | 990S | 11 X 4½ | 279 X 114 |

Stainless Steel Drywall Trowels

- Premium stainless steel blade has a slight concave bow which helps the user feather the mud and make perfect drywall joints
- Aluminum alloy mounting is lightweight but very strong
- Flexible blade is tempered, ground and polished
- Blade fastened to the mounting with hardened stainless steel rivets
- "Diamond Shank" design keeps the handle from twisting
- Choice of resilient DuraSoft® handle or smooth, natural finish hardwood handle
- Sold 1 per inner pack/12 per outer pack



MADE IN
U.S.A

U.S. Patent No. 5,522,111

MARSHALLTOWN The Premier Line

| EDI | Part# | Size-in. | Size-mm | Handle |
|-------|--------|----------|-----------|--------|
| 12613 | 12SS | 11 X 4½ | 279 X 114 | |
| 12616 | 12SSD | 11 X 4½ | 279 X 114 | |
| 15319 | 12BSS | 12 X 4½ | 305 X 114 | |
| 15320 | 12BSSD | 12 X 4½ | 305 X 114 | |
| 12617 | 12ASS | 14 X 4½ | 356 X 114 | |
| 12619 | 12ASSD | 14 X 4½ | 356 X 114 | |
| 15315 | 12CSS | 16 X 4½ | 406 X 114 | |
| 15316 | 12CSSD | 16 X 4½ | 406 X 114 | |

High Carbon Steel Drywall Trowels

- High carbon steel blade has a slight concave bow which helps the user feather the mud and make perfect drywall joints
- Flexible blade is tempered, ground and polished
- Aluminum alloy mounting is lightweight but very strong
- Blade fastened to the mounting with hardened steel rivets
- "Diamond Shank" design keeps the handle from twisting
- Sold 1 per inner pack/12 per outer pack



MADE IN
U.S.A

U.S. Patent No. 5,522,111

MARSHALLTOWN The Premier Line

| EDI | Part# | Size-in. | Size-mm | Handle |
|-------|-------|----------|-----------|--------|
| 12612 | 12 | 11 X 4½ | 279 X 114 | |
| 12618 | 12D | 11 X 4½ | 279 X 114 | |
| 12611 | 12SD | 11 X 4½ | 279 X 114 | |
| 15317 | 12B | 12 X 4½ | 305 X 114 | |
| 15318 | 12BSD | 12 X 4½ | 305 X 114 | |
| 12614 | 12A | 14 X 4½ | 356 X 114 | |
| 12620 | 12AD | 14 X 4½ | 356 X 114 | |
| 12615 | 12ASD | 14 X 4½ | 356 X 114 | |
| 15313 | 12C | 16 X 4½ | 406 X 114 | |
| 15314 | 12CSD | 16 X 4½ | 406 X 114 | |

Carbon Steel Drywall Trowel

- Has a cast aluminum mounting with a tempered, fully polished steel blade
- Black plastic handle
- Concave shape of the blade helps build up the joint for final finish
- Sold 6 per inner pack/36 per outer pack



MADE IN
U.S.A

QLT[®] MARSHALLTOWN

| EDI | Part# | Size-in. | Size-mm |
|-------|-------|----------|-----------|
| 12622 | 912 | 11 X 4½ | 279 X 114 |

Venetian Plastering Trowels

- Stainless steel blade with beveled edges and radius corners
- Ideal for achieving the highly polished, burnished "Venetian" look
- Sold 1 per inner pack/12 per outer pack



MADE IN
U.S.A

MARSHALLTOWN The Premier Line

| EDI | Part# | Size-in. | Size-mm | Handle |
|-------|-----------|----------|----------|--------|
| 16062 | MXS875SS | 8¾ X 3¾ | 222 X 95 | |
| 16063 | MXS875SSD | 8¾ X 3¾ | 222 X 95 | |
| 16064 | MXS11SS | 11 X 3¾ | 279 X 95 | |
| 16065 | MXS11SSD | 11 X 3¾ | 279 X 95 | |

Direct Pressure Blue Steel Taping Knives

- Revolutionary ergonomic design reduces hand, wrist and forearm fatigue
- Allows for greater control and pressure with less effort
- Blade is tapered so you can run corners faster and easier
- Blue steel blade flexes just right for feathering but won't take a set
- Resilient DuraSoft® handle provides a soft feel, reduces fatigue and offers excellent durability
- Sold 6 per inner pack/6 per outer pack



Direct Pressure revolutionary ergonomic design makes it possible to be used two different ways



MADE IN U.S.A

MARSHALLTOWN The Premier Line

| EDI | Part# | Size-in. | Size-mm |
|-------|-------|----------|----------|
| 14758 | 12BST | 12 X 3 | 305 X 76 |
| 14759 | 14BST | 14 X 3 | 356 X 76 |
| 14760 | 16BST | 16 X 3 | 406 X 76 |

DuraSoft® II Stainless Steel Taping Knives

- Premium tempered stainless steel blade with rigid alloy backer
- Blade is tapered so you can run corners faster and easier
- Narrow profile DuraSoft® handle moves hand forward to help improve blade control
- Ergonomic contours for improved comfort
- One of the most lightweight knives on the market
- Sold 6 per inner pack/6 per outer pack



MADE IN U.S.A

U.S. Patent No. 5,615,445

MARSHALLTOWN The Premier Line

| EDI | Part# | Size-in. | Size-mm |
|-------|--------|----------|----------|
| 14592 | 4506SD | 6 X 3 | 152 X 76 |
| 14594 | 4508SD | 8 X 3 | 203 X 76 |
| 14596 | 4510SD | 10 X 3 | 254 X 76 |
| 14598 | 4512SD | 12 X 3 | 305 X 76 |
| 14601 | 4514SD | 14 X 3 | 356 X 76 |

DuraSoft® II Blue Steel Taping Knives

- Premium tempered blue steel blade with rigid alloy backer
- Blade is tapered so you can run corners faster and easier
- Narrow profile DuraSoft® handle moves hand forward to help improve blade control
- Ergonomic contours for improved comfort
- One of the most lightweight knives on the market
- Sold 6 per inner pack/6 per outer pack



MADE IN U.S.A

U.S. Patent No. 5,615,445

MARSHALLTOWN The Premier Line

| EDI | Part# | Size-in. | Size-mm |
|-------|-------|----------|----------|
| 14527 | 4506D | 6 X 3 | 152 X 76 |
| 14531 | 4508D | 8 X 3 | 203 X 76 |
| 14534 | 4510D | 10 X 3 | 254 X 76 |
| 14537 | 4512D | 12 X 3 | 305 X 76 |
| 14361 | 4514D | 14 X 3 | 356 X 76 |

DuraSoft® Stainless Steel Taping Knives

- Tempered premium stainless steel blade with aluminum backing plate
- Tapered blade flexes just right for feathering but won't take a set
- Resilient DuraSoft® handle provides a soft feel, reduces fatigue and offers excellent durability
- Sold 6 per inner pack/6 per outer pack



MADE IN U.S.A

U.S. Patent No. 5,615,445

MARSHALLTOWN The Premier Line

| EDI | Part# | Size-in. | Size-mm |
|-------|--------|----------|----------|
| 14343 | 3506SD | 6 X 3 | 152 X 76 |
| 14321 | 3508SD | 8 X 3 | 203 X 76 |
| 14323 | 3510SD | 10 X 3 | 254 X 76 |
| 14325 | 3512SD | 12 X 3 | 305 X 76 |
| 14327 | 3514SD | 14 X 3 | 356 X 76 |
| 14359 | 3516SD | 16 X 3 | 406 X 76 |
| 14360 | 3520SD | 20 X 3 | 508 X 76 |

DuraSoft® Blue Steel Taping Knives

- Premium tempered blue steel blade with aluminum backing plate
- Blade is tapered so you can run corners faster and easier
- Blade flexes just right for feathering but won't take a set
- Resilient DuraSoft® handle provides a soft feel, reduces fatigue and offers excellent durability
- Sold 6 per inner pack/6 per outer pack



MADE IN U.S.A.
U.S. Patent No. 5,615,445

MARSHALLTOWN The Premier Line

| EDI | Part# | Size-in. | Size-mm |
|-------|-------|----------|----------|
| 14345 | 3506D | 6 X 3 | 152 X 76 |
| 14337 | 3508D | 8 X 3 | 203 X 76 |
| 14338 | 3510D | 10 X 3 | 254 X 76 |
| 14339 | 3512D | 12 X 3 | 305 X 76 |
| 14341 | 3514D | 14 X 3 | 356 X 76 |

Narrow Blade Stainless Steel Taping Knives

- Premium stainless steel blade with aluminum backing plate
- Blade is tapered so you can run corners faster and easier
- Blade flexes just right for feathering but won't take a set
- Resilient DuraSoft® handle provides a soft feel, reduces fatigue and offers excellent durability
- Sold 6 per inner pack/6 per outer pack



MADE IN U.S.A.
U.S. Patent No. 5,615,445

MARSHALLTOWN The Premier Line

| EDI | Part# | Size-in. | Size-mm |
|-------|---------|----------|----------|
| 14363 | 3508SDN | 8 X 2¼ | 203 X 57 |
| 14364 | 3512SDN | 12 X 2¼ | 305 X 57 |
| 14365 | 3516SDN | 16 X 2¼ | 406 X 57 |
| 14366 | 3520SDN | 20 X 2¼ | 508 X 57 |

Stainless Steel Taping Knives

- Premium stainless steel blade and backing plate
- Temper weld construction improves holding power
- Blade flexes just right for feathering but won't take a set
- Structural foam, ergonomically designed, "Taper-Saver" handle provides maximum comfort
- Handle will not crack, splinter or break
- Sold 6 per inner pack/6 per outer pack



MADE IN U.S.A.

MARSHALLTOWN The Premier Line

| EDI | Part# | Size-in. | Size-mm |
|-------|--------|----------|----------|
| 14320 | 2508SS | 8 X 3 | 203 X 76 |
| 14322 | 2510SS | 10 X 3 | 254 X 76 |
| 14324 | 2512SS | 12 X 3 | 305 X 76 |
| 14326 | 2514SS | 14 X 3 | 356 X 76 |

Blue Steel Taping Knives

- Made of the highest grade blue spring steel
- Comfortable contoured wood handle
- Blade flexes just right for feathering but won't take a set
- Each blade and backing plate fully temper welded to improve holding ability
- Sold 6 per inner pack/6 per outer pack



MADE IN U.S.A.

MARSHALLTOWN The Premier Line

| EDI | Part# | Size-in. | Size-mm |
|-------|-------|----------|----------|
| 14308 | 2508 | 8 X 3 | 203 X 76 |
| 14310 | 2510 | 10 X 3 | 254 X 76 |
| 14312 | 2512 | 12 X 3 | 305 X 76 |
| 14314 | 2514 | 14 X 3 | 356 X 76 |

Pro-Style Stainless Steel Taping Knives

- Blade made of lightweight yet sturdy stainless steel
- Tapered blade lets you get close to the corner
- Plastic handle is securely molded to an aluminum backing plate
- Sold 6 per inner pack/6 per outer pack



MADE IN U.S.A.

QLT BY MARSHALLTOWN

| EDI | Part# | Size-in. | Size-mm |
|-------|-------|----------|----------|
| 16051 | 903SS | 6 X 3 | 152 X 76 |
| 16052 | 905SS | 8 X 3 | 203 X 76 |
| 16053 | 907SS | 10 X 3 | 254 X 76 |
| 16054 | 913SS | 12 X 3 | 305 X 76 |
| 16055 | 915SS | 14 X 3 | 356 X 76 |

Pro-Style Blue Steel Taping Knives

- Flexible blue spring steel blade
- Tapered blade lets you get close to the corner
- One of the most lightweight taping knives on the market
- Plastic handle is securely molded to an aluminum backing plate
- Equipped with a very lightweight yet durable contour handle
- Sold 1 per inner pack/12 per outer pack



QLT BY MARSHALLTOWN

| EDI | Part# | Size-in. | Size-mm |
|-------|---------|----------|----------|
| 18719 | BSTK6P | 6 X 3 | 152 X 76 |
| 18720 | BSTK8P | 8 X 3 | 203 X 76 |
| 18721 | BSTK10P | 10 X 3 | 254 X 76 |
| 18722 | BSTK12P | 12 X 3 | 305 X 76 |
| 16050 | 915M | 14 X 3 | 356 X 76 |

Soft Grip Stainless Steel Taping Knives

- Flexible stainless steel blade
- Tapered blade lets you get close to the corner
- One of the most lightweight taping knives on the market
- Comfortable soft grip handle is securely molded to an aluminum backing plate
- Sold 6 per inner pack/6 per outer pack



QLT BY MARSHALLTOWN

| EDI | Part# | Size-in. | Size-mm |
|-------|--------|----------|----------|
| 19035 | SSTK6 | 6 X 3 | 152 X 76 |
| 19036 | SSTK8 | 8 X 3 | 203 X 76 |
| 19037 | SSTK10 | 10 X 3 | 254 X 76 |
| 19038 | SSTK12 | 12 X 3 | 305 X 76 |
| 19039 | SSTK14 | 14 X 3 | 356 X 76 |

Soft Grip Blue Steel Taping Knives

- Flexible blue spring steel blade
- Tapered blade lets you get close to the corner
- One of the most lightweight taping knives on the market
- Comfortable soft grip handle is securely molded to an aluminum backing plate
- Sold 6 per inner pack/6 per outer pack

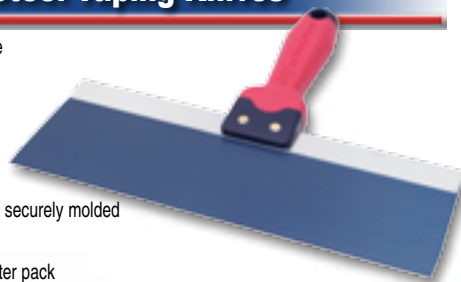

QLT BY MARSHALLTOWN

| EDI | Part# | Size-in. | Size-mm |
|-------|--------|----------|----------|
| 11432 | BSTK6 | 6 X 3 | 152 X 76 |
| 11433 | BSTK8 | 8 X 3 | 203 X 76 |
| 11434 | BSTK10 | 10 X 3 | 254 X 76 |
| 11435 | BSTK12 | 12 X 3 | 305 X 76 |
| 11436 | BSTK14 | 14 X 3 | 356 X 76 |

Plastic Taping Knives

- Reinforced handles and tapered flexible blades
- Intended to be disposed of after use
- Sold 24 per inner pack/24 per outer pack



MADE IN
U.S.A

QLT BY MARSHALLTOWN

| EDI | Part# | Size-in. | Size-mm |
|-------|-------|----------|----------|
| 16271 | 6271 | 6 X 3½ | 152 X 89 |
| 16272 | 6272 | 8 X 3¾ | 203 X 95 |
| 16273 | 6273 | 10 X 3⅞ | 254 X 79 |

Broad Knives

- Blue spring steel blade
- Lightweight aluminum handle
- Used for taping and seaming joints
- Rubber handle cap with hanger
- More flexible than a taping knife
- Sold 2 per inner pack/6 per outer pack



QLT BY MARSHALLTOWN

| EDI | Part# | Size-in. | Size-mm |
|-------|-------|----------|-----------|
| 14385 | BK385 | 7 X 17⅞ | 178 X 454 |
| 14386 | BK386 | 9 X 17⅞ | 229 X 454 |
| 14387 | BK387 | 7 X 31⅞ | 178 X 809 |
| 14388 | BK388 | 9 X 28 | 229 X 711 |

BLADE GUIDE

Blade Width

Bent Blade
< 3"
3" & 4"
5" & 6"

Blade Name

Glazier
Putty Knife
Scraper
Joint Knife

Blade Type

Flex & Full Flex

Stiff

Chisel

Tip



DuraSoft® Handle Putty and Joint Knives

- Next generation ergonomic design offers the most comfortable grip possible
- Solid handle construction ensures the strongest and longest lasting tool available
- Oversized EMPACT hammering head for quick, effective hammering
- Patent Pending handle design
- All 3" scraper blades have a 5° angle
- Sold 6 per inner pack/6 per outer pack, PIK125D sold 1 per inner pack/6 per outer pack



JK886D

SK867D

GT872D

PK866D

PK878D

U.S. Patent Nos.
D535,541, D527,244
D526,881, & D525,510

MARSHALLTOWN The Premier Line

Stainless Steel Putty Knives - DuraSoft® Handle

- Heavy duty stainless steel blade
- Heat treated, hardened and tempered; annealed for an even hardness throughout the blade
- Full tang through the handle
- Next generation ergonomic design offers the most comfortable grip possible
- Oversized EMPACT hammering head for quick, effective hammering
- Sold 6 per inner pack/24 per outer pack



U.S. Patent Nos.
D535,541 and D527,244

MARSHALLTOWN The Premier Line

| EDI | Part# | Description | Size-in. | Size-mm |
|-------|----------|-------------------|----------|---------|
| 10764 | PK764SSD | Flex Putty Knife | 2 | 51 |
| 10765 | PK866SSD | Stiff Putty Knife | 2 | 51 |
| 10766 | SK880SSD | Flex Scraper | 3 | 76 |
| 10767 | SK868SSD | Stiff Scraper | 3 | 76 |
| 10768 | SK882SSD | Flex Scraper | 4 | 102 |
| 10782 | JK886SSD | Joint Knife | 6 | 152 |

☛ symbol designates our EMPACT hammering head handle

| EDI | Part# | Description | Size-in. | Size-mm | Handle |
|-------|--------|-----------------------|----------|---------|--------|
| 10860 | PK860D | Stiff Putty Knife | 1¼ | 31 | A |
| 10861 | CK861D | Chisel Knife | 1¼ | 31 | A |
| 10863 | PK863D | Stiff Putty Knife | 1½ | 38 | A |
| 10876 | PK876D | Flex Putty Knife | 1½ | 38 | C |
| 10877 | PK877D | Flex Putty Knife | 1½ | 38 | D |
| 10888 | PK888D | Full Flex Putty Knife | 1½ | 38 | C |
| 10865 | PK865D | Stiff Putty Knife | 2 | 51 | A |
| 10866 | PK866D | Stiff Putty Knife | 2 | 51 | B |
| 10878 | PK878D | Flex Putty Knife | 2 | 51 | C |
| 10867 | SK867D | Stiff Scraper | 3 | 76 | A |
| 10879 | SK879D | Flex Scraper | 3 | 76 | C |
| 10880 | SK880D | Flex Scraper | 3 | 76 | D |
| 10890 | SK890D | Full Flex Scraper | 3 | 76 | C |
| 10881 | SK881D | Flex Scraper | 4 | 102 | C |
| 10882 | SK882D | Flex Scraper | 4 | 102 | D |
| 10883 | JK883D | Flex Joint Knife | 5 | 127 | C |
| 10884 | JK884D | Flex Joint Knife | 5 | 127 | D |
| 10885 | JK885D | Flex Joint Knife | 6 | 152 | C |
| 10886 | JK886D | Flex Joint Knife | 6 | 152 | D |
| 10896 | JK896D | Full Flex Joint Knife | 6 | 152 | C |
| 10871 | GT871D | 5-in-1 Tool | 6 | 152 | A |
| 10872 | GT872D | 6-in-1 Tool | 6 | 152 | B |

☛ symbol designates our EMPACT hammering head handle

Stainless Steel Putty Knives - Nylon Handle

- Heavy duty stainless steel blade
- Heat treated, hardened and tempered; annealed for an even hardness throughout the blade
- Full tang through the handle
- Smooth black polyethylene handles resistant to virtually all chemicals and solvents
- Sold 6 per inner pack/24 per outer pack



Nylon Handle Putty and Joint Knives

- Heat treated, hardened and tempered; annealed for an even hardness throughout the blade
- Full tang through the handle
- Smooth black polyethylene handle resistant to virtually all chemicals and solvents
- Weighted handle accommodates our heavier blades for perfect balance
- All 3" scraper blades have a 5° angle
- Sold 6 per inner pack/24 per outer pack, displays sold 12 inner pack/12 per outer pack



M5221DP

MARSHALLTOWN The Premier Line

| EDI | Part# | Description | Size-in. | Size-mm |
|-------|---------|-----------------------------|----------|---------|
| 11705 | M5124SS | Stiff Putty Knife | 1 ¼ | 32 |
| 11706 | M5122SS | Chisel Putty Knife | 1 ¼ | 32 |
| 11707 | M5203SS | Flex Putty Knife | 2 | 51 |
| 11709 | M5303SS | Flex Scraper | 3 | 76 |
| 11711 | M5403SS | Flex Scraper | 4 | 102 |
| 11712 | M5743SS | Flex Scraper | 4 | 102 |
| 11716 | M5753SS | Joint Knife | 5 | 127 |
| 11717 | M5763SS | Joint Knife | 6 | 152 |
| 15047 | M5863 | Stainless Flex Joint Knife | 6 | 152 |
| 15046 | M5864 | Stainless Stiff Joint Knife | 6 | 152 |
| 11719 | M5721SS | 6-in-1 Tool | N/A | N/A |

⬡ symbol designates our EMPACT hammering head handle

MARSHALLTOWN The Premier Line

| EDI | Part# | Description | Size-in. | Size-mm |
|-------|---------|----------------------------|----------|---------|
| 15015 | M5121 | 20° Bent Glazier | 1¼ | 31 |
| 15016 | M5123 | Flex Putty Knife | 1¼ | 31 |
| 15017 | M5124 | Stiff Putty Knife | 1¼ | 31 |
| 15019 | M5122 | Chisel Putty Knife | 1¼ | 33 |
| 15021 | M5153 | Flex Putty Knife | 1½ | 38 |
| 15022 | M5155 | Full Flex Putty Knife | 1½ | 38 |
| 15024 | M5154 | Stiff Putty Knife | 1½ | 38 |
| 15026 | M5203 | Flex Putty Knife | 2 | 51 |
| 15029 | M5204 | Stiff Putty Knife | 2 | 51 |
| 15030 | M5303 | Flex Scraper | 3 | 76 |
| 15032 | M5304 | Stiff Scraper | 3 | 76 |
| 15033 | M5734 | Stiff Scraper | 3 | 76 |
| 15039 | M5403 | Flex Scraper | 4 | 102 |
| 15087 | M5743 | Flex Scraper | 4 | 102 |
| 15038 | M5404 | Stiff Scraper | 4 | 102 |
| 15041 | M5503 | Flex Joint Knife | 5 | 127 |
| 15042 | M5753 | Flex Joint Knife | 5 | 127 |
| 15048 | M5603 | Flex Joint Knife | 6 | 152 |
| 15043 | M5763 | Flex Joint Knife | 6 | 152 |
| 15049 | M5221 | 5-in-1 Tool | N/A | N/A |
| 15050 | M5221DP | 5-in-1 Tool, Display of 12 | N/A | N/A |
| 15051 | M5721 | 6-in-1 Tool | N/A | N/A |
| 15052 | M5721DP | 6-in-1 Tool, Display of 12 | N/A | N/A |

⬡ symbol designates our EMPACT hammering head handle

Rosewood Handle Tools

- Heat treated, hardened and tempered; annealed for an even hardness throughout the blade
- Full tang through the handle
- Laminated rosewood handle, resin impregnated to protect against chemicals and solvents
- Weighted handle accommodates our heavier blades for perfect balance
- All 3" scraper blades have a 5° angle
- Sold 6 per inner pack/24 per outer pack, displays sold 12 per inner pack/12 per outer pack



MARSHALLTOWN The Premier Line

| EDI | Part# | Description | Size-in. | Size-mm |
|-------|-------|-----------------------|----------|---------|
| 15064 | M7081 | 20° Bent Glazier | ¾ | 19 |
| 15065 | M7071 | 35° Bent Glazier | ¾ | 19 |
| 15066 | M7073 | Flex Streamliner | ¾ | 19 |
| 15067 | M7123 | Flex Putty Knife | 1¼ | 31 |
| 15068 | M7124 | Stiff Putty Knife | 1¼ | 31 |
| 15070 | M7153 | Flex Putty Knife | 1½ | 38 |
| 15069 | M7155 | Full Flex Putty Knife | 1½ | 38 |
| 15071 | M7154 | Stiff Putty Knife | 1½ | 38 |
| 15072 | M7152 | Chisel Putty Knife | 1½ | 38 |
| 15074 | M7203 | Flex Putty Knife | 2 | 51 |
| 15073 | M7205 | Full Flex Putty Knife | 2 | 51 |
| 15075 | M7204 | Stiff Putty Knife | 2 | 51 |
| 15077 | M7303 | Flex Scraper | 3 | 76 |
| 15076 | M7305 | Full Flex Scraper | 3 | 76 |
| 15078 | M7304 | Stiff Scraper | 3 | 76 |
| 15080 | M7403 | Flex Scraper | 4 | 102 |
| 15079 | M7405 | Full Flex Scraper | 4 | 102 |
| 15082 | M7503 | Flex Joint Knife | 5 | 127 |
| 15081 | M7505 | Full Flex Joint Knife | 5 | 127 |
| 15083 | M7603 | Flex Joint Knife | 6 | 152 |
| 15084 | M7221 | 5-in-1 Tool | N/A | N/A |

Soft Grip Putty and Joint Knives

- Blade is available in high carbon steel or stainless steel
- Soft grip handle
- 5-in-1 tool can be used as a scraper, spreader, roller cleaner, putty remover and crack cleaner
- Sold 6 per inner pack/72 per outer pack

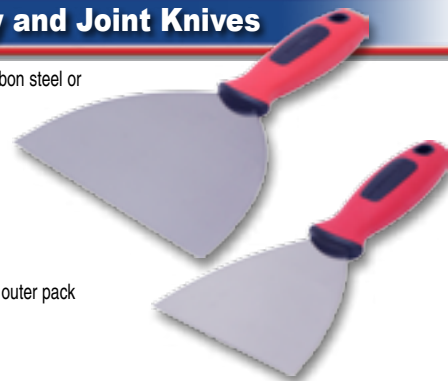

QLT BY MARSHALLTOWN

| EDI | Part# | Description | Size-in. | Size-mm |
|-------|-----------|-----------------------|----------|---------|
| 18481 | SCPK114 | Chisel Putty Knife | 1¼ | 31 |
| 18482 | SCPK114 | Stiff Putty Knife | 1¼ | 31 |
| 18482 | SCPK114HH | Stiff Putty Knife | 1¼ | 31 |
| 18483 | FPK114 | Flex Putty Knife | 1¼ | 31 |
| 18484 | FFPK114 | Full Flex Putty Knife | 1¼ | 31 |
| 18486 | SPK112HH | Stiff Putty Knife | 1½ | 38 |
| 18487 | FPK112 | Flex Putty Knife | 1½ | 38 |
| 18488 | FPK112HH | Flex Putty Knife | 1½ | 38 |
| 18489 | FFPK112 | Full Flex Putty Knife | 1½ | 38 |
| 18490 | SPK2 | Stiff Putty Knife | 2 | 51 |
| 18492 | FPK2 | Flex Putty Knife | 2 | 51 |
| 18493 | FPK2HH | Flex Putty Knife | 2 | 51 |
| 18494 | FFPK2 | Full Flex Putty Knife | 2 | 51 |
| 18496 | SC3HH | Stiff Scraper | 3 | 76 |
| 18498 | FPK3HH | Flex Putty Knife | 3 | 76 |
| 18500 | FJK4 | Flex Joint Knife | 4 | 102 |
| 18501 | FJK4HH | Flex Joint Knife | 4 | 102 |
| 18502 | FJK5 | Flex Joint Knife | 5 | 127 |
| 18503 | FJK5HH | Flex Joint Knife | 5 | 127 |
| 18505 | FJK6 | Flex Joint Knife | 6 | 152 |
| 18506 | FJK6HH | Flex Joint Knife | 6 | 152 |
| 18507 | FJK8 | Flex Joint Knife | 8 | 203 |
| 18509 | 6IN1212HH | 6-in-1 Tool | 2½ | 63 |

Stainless Steel Putty Knives

| EDI | Part# | Description | Size-in. | Size-mm |
|-------|------------|------------------|----------|---------|
| 18511 | FPK112SSHH | Flex Putty Knife | 1½ | 38 |
| 18515 | FJK4SSHH | Flex Joint Knife | 4 | 102 |
| 18517 | FJK5SSHH | Flex Joint Knife | 5 | 127 |
| 18518 | FJK6SSHH | Flex Joint Knife | 6 | 152 |



Symbol designates our EMPACT hammering head handle

Nylon Handle Putty and Joint Knives

- Blade made of high carbon steel, tempered then polished to a mirror finish
- Full length tang goes through the rugged solvent-resistant nylon handle
- 5-in-1 tool can be used as a scraper, spreader, roller cleaner, putty remover and crack cleaner
- Inner and outer pack quantities are shown in table



QLT BY MARSHALLTOWN

| EDI | Part# | Description | Size-in. | Size-mm | Inner/Outer |
|-------|--------|--|----------|---------|-------------|
| 14561 | PK741F | Flex Putty Knife | 1¼ | 31 | 24/288 |
| 14560 | PK740S | Stiff Putty Knife | 1¼ | 31 | 24/144 |
| 14563 | PK743F | Flex Scraper | 3 | 76 | 24/288 |
| 14562 | PK742S | Stiff Scraper | 3 | 76 | 24/144 |
| 14564 | JK744 | Flex Scraper  | 4 | 102 | 12/192 |
| 14565 | JK745 | Joint Knife  | 5 | 127 | 24/192 |
| 14566 | JK746 | Joint Knife  | 6 | 152 | 12/192 |
| 14567 | PT747 | 5-in-1 Tool | N/A | N/A | 24/240 |

 symbol designates our EMPACT hammering head handle

Putty and Joint Knives

- Flexible stainless steel blade
- Molded plastic handle
- Full tang through the handle
- Sold 12 per inner pack/120 per outer pack



QLT BY MARSHALLTOWN

| EDI | Part# | Description | Size-in. | Size-mm |
|-------|-------|--------------|----------|---------|
| 16102 | 902 | Putty Knife | 1½ | 38 |
| 16104 | 904 | Flex Scraper | 4 | 102 |
| 16105 | 905 | Joint Knife | 6 | 152 |

Plastic Handle Putty and Joint Knives

- Flexible stainless steel blade
- Molded plastic handle
- Sold 12 per inner pack/288 per outer pack



QLT BY MARSHALLTOWN

| EDI | Part# | Description | Size-in. | Size-mm |
|-------|--------|-------------------|----------|---------|
| 14440 | PK440F | Flex Putty Knife | 1½ | 38 |
| 14441 | PK441S | Stiff Putty Knife | 1½ | 38 |
| 14442 | WS442F | Flex Scraper | 3 | 76 |
| 14443 | WS443S | Stiff Scraper | 3 | 76 |
| 14444 | JK444F | Flex Scraper | 4 | 102 |
| 14445 | JK445F | Joint Knife | 6 | 152 |
| 14446 | PT446 | 5-in-1 Tool | N/A | N/A |

Plastic Putty Knives

- Tapered flexible blade with a comfortable grip that resists bending and breaking
- Inner/outer pack quantities are shown in table

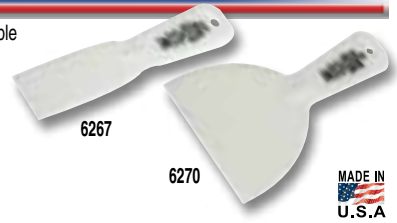

MADE IN U.S.A

QLT BY MARSHALLTOWN

| EDI | Part# | Size-in. | Size-mm | Inner/Outer |
|-------|-------|----------|---------|-------------|
| 16267 | 6267 | 1½ | 38 | 36/576 |
| 16268 | 6268 | 2 | 51 | 36/432 |
| 16269 | 6269 | 3 | 76 | 36/288 |
| 16270 | 6270 | 4 | 102 | 36/216 |

Exact Angle™ Inside Corner Trowel

- Easy to clean nylon blade will not mar walls
- Angle adjusts from 90° - 154°
- Resilient DuraSoft® handle provides a soft feel, reduces fatigue and offers excellent durability
- Sold 1 per inner pack/6 per outer pack



MADE IN U.S.A

MARSHALLTOWN The Premier Line

| EDI | Part# | Size-in. | Size-mm |
|-------|-------|----------|-----------|
| 14917 | EA917 | 4 X 4 | 102 X 102 |

Inside Corner Trowel

- Lightweight tool made from one piece of flexible stainless steel with aluminum mounting
- Blade set at a 103° angle that flexes to form a perfect 90° corner during use
- Resilient DuraSoft® handle with finger guard
- Used to embed tape and smooth out the final layer of mud to taped corners
- Sold 2 per inner pack/48 per outer pack



MADE IN U.S.A

U.S. Patent Nos.

5,327,612 and 5,446,941

MARSHALLTOWN The Premier Line

| EDI | Part# | Size-in. | Size-mm |
|-------|-------|----------|-----------|
| 15323 | 23D | 4 X 5 | 102 X 127 |

Thin Coat Inside Corner Trowel

- Lightweight tool made from one piece of flexible stainless steel
- Has a 90° angle between the blades
- Resilient DuraSoft® handle with integral finger guard
- Used to embed tape and smooth out the final layer of mud to taped corners
- Sold 6 per inner pack/6 per outer pack



MARSHALLTOWN The Premier Line

| EDI | Part# | Size-in. | Size-mm |
|-------|-------|----------|----------|
| 15324 | 24D | 5 X 3¾ | 127 X 95 |

Bullnose Inside Corner Trowel

- Inside corner has a 103° rounded angle that will flex to 90°, 5/8" (16mm) radius
- Can be used for either EIFS or drywall work
- Stainless steel blades
- Resilient DuraSoft® handle with finger guard
- For use when rounded corners are desired
- Sold 6 per inner pack/6 per outer pack



MARSHALLTOWN The Premier Line

| EDI | Part# | Size-in. | Size-mm |
|-------|-------|----------|----------|
| 15327 | 51D | 5 X 3½ | 127 X 89 |

Inside Corner Trowel

- Formed from one piece of flexible stainless steel
- Blade is set with 103° angle that flexes to 90° for finishing corners
- Used to embed tape and smooth out the final layer of mud to taped corners
- Sold 2 per inner pack/48 per outer pack



| EDI | Part# | Size-in. | Size-mm |
|-------|-------|----------|----------|
| 16111 | 911 | 3½ X 4½ | 89 X 115 |

Inside Corner Trowel

- Formed from a single piece of stainless steel
- Blade flexes to form a perfect 90 degree angle
- Used to embed tape and smooth out the final layer of mud to taped corners
- Comfortable soft grip handle
- Sold 1 per inner pack/6 per outer pack



| EDI | Part# | Size-in. | Size-mm |
|-------|-------|----------|-----------|
| 19285 | CT911 | 4 X 5 | 102 X 127 |

Outside Corner Trowel

- Lightweight tool made from one piece of flexible stainless steel
- Blade set at an 80° angle that flexes during use to 90° to form a clean square outside corner
- Resilient DuraSoft® handle with finger guard
- Used to embed tape and smooth out the final layer of mud to taped corners
- Sold 6 per inner pack/6 per outer pack



MARSHALLTOWN The Premier Line

| EDI | Part# | Size-in. | Size-mm |
|-------|-------|----------|----------|
| 15325 | 25D | 5 X 3¾ | 127 X 95 |

Outside Corner Trowel

- Lightweight tool made from one piece of flexible stainless steel
- Blade is set at an 80° angle that flexes during use to 90° to form a clean square outside corner
- Plastic handle
- Sold 12 per inner pack/12 per outer pack



| EDI | Part# | Size-in. | Size-mm |
|-------|-------|----------|----------|
| 14541 | OS751 | 5 X 3¾ | 127 X 95 |

Bullnose Outside Corner Trowel

- For use when rounded corners are desired
- Outside corner has an 80° rounded angle that flexes to 90°, 5/8" (16mm) radius
- Blade is made from flexible stainless steel
- Resilient DuraSoft® handle with integral finger guard
- Sold 6 per inner pack/6 per outer pack



MARSHALLTOWN The Premier Line

| EDI | Part# | Size-in. | Size-mm |
|-------|-------|----------|----------|
| 15326 | 50D | 5 X 3½ | 127 X 89 |

Corner Tool

- Flexes for 90° angles
- Made of durable plastic
- Finger rest to apply additional pressure
- Sold 24 per inner pack/24 per outer pack



| EDI | Part# | Size-in. | Size-mm |
|-------|-------|----------|-----------|
| 16292 | CT292 | 7½ X 4½ | 191 X 115 |

Stainless Steel Bullnose Corner Trowels

- Produces a rounded outside corner in stucco and plaster
- Stainless steel blade will not rust
- Smooth keyhole shaped wooden handle
- Sold 6 per inner pack/24 per outer pack

Stainless Steel!



QLT^{BY} MARSHALLTOWN

| EDI | Part# | Radius | Size-in. | Size-mm |
|-------|-------|-------------|----------|----------|
| 16040 | 6040 | 1/8" (3mm) | 4 X 2 | 102 X 51 |
| 16041 | 6041 | 1/4" (6mm) | 4 X 2 | 102 X 51 |
| 16042 | 6042 | 3/8" (10mm) | 4 X 2 | 102 X 51 |
| 16043 | 6043 | 1/2" (13mm) | 4 X 2 | 102 X 51 |
| 16044 | 6044 | 3/4" (19mm) | 4 X 2 | 102 X 51 |

Round-It Tool

- Rubber blade is easily adjustable to desired angle
- Used for smooth round corners and outside angles
- Can also be used flat as a wipe down knife
- Sold 1 per inner pack/6 per outer pack



QLT^{BY} MARSHALLTOWN

| EDI | Part# | Size-in. | Size-mm |
|-------|-------|----------|-----------|
| 14335 | RI335 | 5 X 10 | 127 X 254 |

Corner Rollers

- For use with all corner joint compound and drywall mud applications
- Replaceable acrylic cover with "lamb's wool" texture
- Use cover **CR3RP** for part **CR3** and **CR5RP** for part **CR5**
- 12" (305mm) threaded handle can be used with threaded extension poles (sold separately)
- Rollers are sold 1 per inner pack/6 per outer pack, replacement covers are sold 1 per inner pack/144 per outer pack

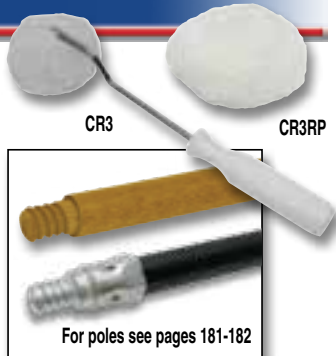

For poles see pages 181-182

QLT^{BY} MARSHALLTOWN

| EDI | Part# | Description | Size-in. | Size-mm |
|-------|-------|-------------|----------|---------|
| 19046 | CR3 | Roller | 3 | 76 |
| 19047 | CR3RP | Repl. Cover | 3 | 76 |
| 19048 | CR5 | Roller | 5 | 127 |
| 19049 | CR5RP | Repl. Cover | 5 | 127 |

Rubber Wipe Down Blade

- For taping and cleaning excess mud from joints wider than 90°
- Rubber blade is sturdy, yet flexible
- Can be used as a hand tool or with any 1" (25mm) diameter handle (sold separately)
- Sold 12 per inner pack/144 per outer pack



For poles see pages 181-182

MADE IN U.S.A.

MARSHALLTOWN The Premier Line

| EDI | Part# | Size-in. | Size-mm |
|-------|-------|---------------|-----------|
| 14336 | 30 | 6 3/4 X 9 7/8 | 171 X 251 |

Bullnose Cleaner

- Wet sands and cleans 1" (25mm) and 2" (50mm) corner bead
- Cleaning head has an abrasive surface that also holds water
- Threaded adapter accepts 1" (25mm) handle (sold separately)
- Sold 1 per inner pack/10 per outer pack

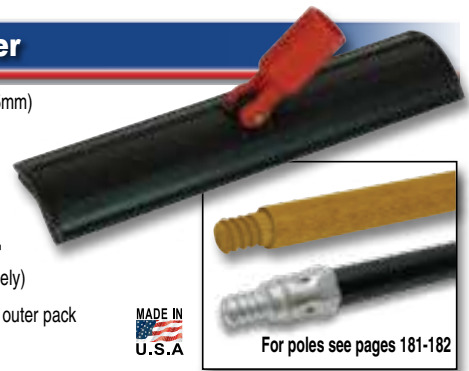

MADE IN U.S.A.

For poles see pages 181-182

QLT^{BY} MARSHALLTOWN

| EDI | Part# | Size-in. | Size-mm |
|-------|-------|----------------|----------|
| 13482 | BC82 | 9 1/4 X 2 3/16 | 235 X 56 |

Grabber Pans™

- Rounded bottom grip fits comfortably in hand
- Elevated pan for easy grabbing
- Rounded bottom makes it easy to apply mud to taping knife and leaves no place for mud to collect
- Stainless steel with durable plastic end caps - leak proof design
- Sold 5 per inner pack/20 per outer pack



MARSHALLTOWN The Premier Line

| EDI | Part# | Size-in. | Size-mm |
|-------|-------|----------|---------|
| 13478 | GP478 | 12 | 305 |
| 13479 | GP479 | 14 | 356 |

Heli-Arc Mud Pans

- Made from heavy gauge stainless steel
- Corners are heli-arc welded to form smooth, seamless inside corners that leave no place for the mud to collect
- Sides are sheared to clean knives easily
- **New item indicated in red**
- Sold 12 per inner pack/12 per outer pack



NEW SIZE!

MARSHALLTOWN The Premier Line

| EDI | Part# | Size-in. | Size-mm |
|-------|-------|----------|---------|
| 19034 | 6394 | 10 | 254 |
| 16395 | 6395 | 12 | 305 |
| 16396 | 6396 | 14 | 356 |
| 16397 | 6397 | 18 | 457 |

Metal Mud Pans

- Made from either stainless or galvanized steel
- Tapered ends and sides with mud-tight seams
- Sides are sheared to clean knives easily
- Sold 12 per inner pack/12 per outer pack

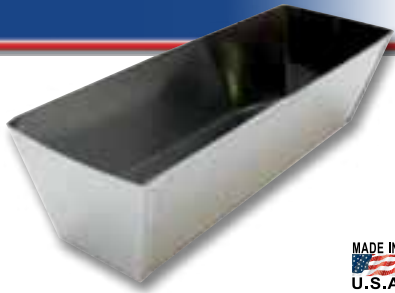

MADE IN
U.S.A

MARSHALLTOWN The Premier Line

| EDI | Part# | Description | Size-in. | Size-mm |
|-------|-------|-----------------|----------|---------|
| 16390 | 812 | Stainless Steel | 12 | 305 |
| 16393 | 813 | Galvanized | 12 | 305 |
| 16392 | 6392 | Galvanized | 14 | 356 |

Metal Mud Pans

- Made from either stainless or galvanized steel
- Tapered ends and sides with mud-tight seams
- Sides are sheared to clean knives easily
- Sold 12 per inner pack/60 per outer pack

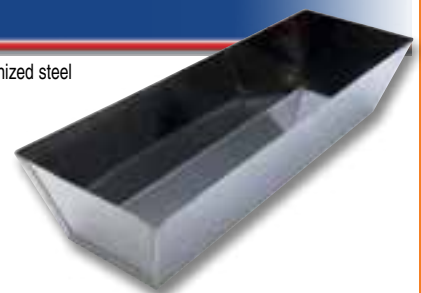

QLTSM MARSHALLTOWN

| EDI | Part# | Description | Size-in. | Size-mm |
|-------|-------|-----------------|----------|---------|
| 14657 | MP657 | Stainless Steel | 12 | 305 |
| 14656 | MP656 | Galvanized | 12 | 305 |

Plastic Mud Pan

- Made of long wearing plastic with hang-up tab
- Equipped with two metal wiping blades
- Resists chemicals and temperature changes
- Outside is slightly textured to provide a non-slip surface
- Sold 12 per inner pack/12 per outer pack

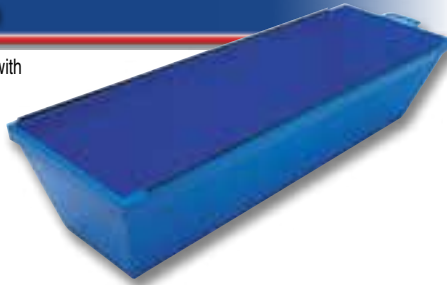

MADE IN
U.S.A

MARSHALLTOWN The Premier Line

| EDI | Part# | Size-in. | Size-mm |
|-------|-------|----------|---------|
| 16394 | 814 | 13 | 330 |

Plastic Mud Pan

- Made of durable plastic
- Resists chemicals and temperature changes
- Tapered ends and sides
- Features a metal scraping bar
- Sold 12 per inner pack/12 per outer pack



MADE IN
U.S.A

QLTSM MARSHALLTOWN

| EDI | Part# | Size-in. | Size-mm |
|-------|-------|----------|---------|
| 16114 | 914 | 12 | 305 |

Handipan[®] Mud Pans

- Multi-purpose utility pan
- Made of durable plastic
- Built in wipe blade
- Sold 12 per inner pack/12 per outer pack



MADE IN
U.S.A

QLTSM MARSHALLTOWN

| EDI | Part# | Size-in. | Size-mm |
|-------|-------|----------|---------|
| 16294 | MP294 | 12 | 305 |

Mud Pan Dimensions

| EDI | Part# | Top Length | Bottom Length | Top Width | Bottom Width | Height (Depth) |
|-------|-------|---|--|--|--|--|
| 19034 | 6394 | 11 ⁵ / ₈ " (295mm) | 10 ¹ / ₈ " (257mm) | 4 ¹ / ₄ " (108mm) | 2 ³ / ₄ " (70mm) | 3 ¹ / ₂ " (89mm) |
| 16390 | 812 | 14" (356mm) | 12 ¹ / ₂ " (318mm) | 4 ⁵ / ₈ " (118mm) | 3" (76mm) | 3 ⁵ / ₈ " (92mm) |
| 16393 | 813 | 14" (356mm) | 12 ¹ / ₂ " (318mm) | 4 ¹ / ₁₆ " (119mm) | 3" (76mm) | 3 ⁵ / ₈ " (92mm) |
| 16394 | 814 | 14 ⁷ / ₁₆ " (378mm) | 13 ³ / ₄ " (337mm) | 4 ³ / ₄ " (121mm) | 3" (76mm) | 3 ¹ / ₄ " (83mm) |
| 16114 | 914 | 13 ⁷ / ₈ " (352mm) | 12 ¹ / ₂ " (313mm) | 4 ³ / ₄ " (121mm) | 3" (76mm) | 3 ¹ / ₄ " (83mm) |
| 16392 | 6392 | 16" (406mm) | 14 ¹ / ₂ " (368mm) | 4 ⁵ / ₈ " (118mm) | 3" (76mm) | 3 ³ / ₈ " (86mm) |
| 16395 | 6395 | 14 ¹ / ₂ " (368mm) | 12 ⁵ / ₈ " (321mm) | 4" (102mm) | 2 ¹ / ₂ " (64mm) | 3 ³ / ₈ " (86mm) |
| 16396 | 6396 | 16 ¹ / ₈ " (402mm) | 14 ⁵ / ₈ " (365mm) | 4 ¹ / ₈ " (105mm) | 2 ⁵ / ₈ " (67mm) | 3 ³ / ₈ " (86mm) |
| 16397 | 6397 | 19 ³ / ₄ " (502mm) | 18 ¹ / ₄ " (464mm) | 4 ¹ / ₄ " (108mm) | 2 ³ / ₄ " (70mm) | 3 ¹ / ₂ " (89mm) |
| 13478 | GP478 | 15 ¹ / ₁₆ " (383mm) | 13 ³ / ₈ " (333mm) | 5 ¹ / ₈ " (130mm) | Rounded | 3 ⁷ / ₈ " (98mm) |
| 13479 | GP479 | 17 ¹ / ₁₆ " (433mm) | 15 ¹ / ₈ " (384mm) | 5 ¹ / ₈ " (130mm) | Rounded | 3 ⁷ / ₈ " (98mm) |
| 16294 | MP294 | 14 ¹ / ₄ " (362mm) | 12 ¹ / ₈ " (308mm) | 4 ³ / ₄ " (121mm) | 3 ¹ / ₈ " (79mm) | 3 ¹ / ₂ " (89mm) |
| 14656 | MP656 | 14 ⁷ / ₁₆ " (378mm) | 12 ⁷ / ₈ " (327mm) | 4 ¹ / ₂ " (114mm) | 3 ¹ / ₈ " (79mm) | 2 ¹³ / ₁₆ " (71mm) |
| 14657 | MP657 | 14 ⁷ / ₁₆ " (378mm) | 12 ⁷ / ₈ " (327mm) | 4 ¹ / ₂ " (114mm) | 3 ¹ / ₈ " (79mm) | 2 ¹³ / ₁₆ " (71mm) |

Adjustable Hawks

- Made of lightweight durable aluminum
- Unique adjustable handle allows for more forearm support
- Edges have been smoothed and corners rounded
- Handle and sponge callus preventer included
- Sold 1 per inner pack/12 per outer pack



MADE IN
U.S.A

MARSHALLTOWN The Premier Line

| EDI | Part# | Description | Size-in. | Size-mm |
|-------|--------|-------------|-----------|-----------|
| 15212 | AH212D | Aluminum | 15¼ X 19½ | 400 X 500 |

Aluminum Hawks

- Made of heavy gauge hard-rolled aluminum
- Edges have been smoothed and the corners rounded
- Has a threaded 3⁵/₈" (92mm) flange
- Handle and sponge rubber callus preventer included
- "W" indicates wood handle; "D" indicates DuraSoft® handle
- Sold 1 per inner pack/12 per outer pack, sold 1 per inner pack/18 per outer pack where noted with *



MADE IN
U.S.A

MARSHALLTOWN The Premier Line

| EDI | Part# | Size-in. | Size-mm | Handle |
|-------|-------|-----------|-----------|--------|
| 13833 | 8W* | 8 X 8 | 203 X 203 | |
| 13835 | 8D* | 8 X 8 | 203 X 203 | |
| 13850 | 7W* | 9 X 9 | 229 X 229 | |
| 13851 | 7D* | 9 X 9 | 229 X 229 | |
| 15203 | 3W* | 10 X 10 | 254 X 254 | |
| 15217 | 3D* | 10 X 10 | 254 X 254 | |
| 15205 | 5W | 12 X 12 | 305 X 305 | |
| 15218 | 5D | 12 X 12 | 305 X 305 | |
| 15200 | 1W | 13 X 13 | 330 X 330 | |
| 15215 | 1D | 13 X 13 | 330 X 330 | |
| 15202 | 2W | 13½ X 13½ | 343 X 343 | |
| 15216 | 2D | 13½ X 13½ | 343 X 343 | |
| 13853 | 6W | 14 X 14 | 356 X 356 | |
| 14400 | 6D | 14 X 14 | 356 X 356 | |

Magnesium Hawks

- Made of lightweight durable magnesium
- Score marks are machined to a uniform depth and specially shaped to help the blade remain flat
- Has a threaded 3⁵/₈" (92mm) flange
- Sponge rubber callus preventer and handle included
- Used for holding plaster during application
- "W" indicates wood handle; "D" indicates DuraSoft® handle
- Sold 1 per inner pack/12 per outer pack, sold 1 per inner pack/18 per outer pack where noted with *

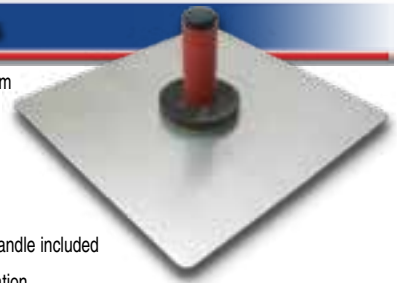

MADE IN
U.S.A

MARSHALLTOWN The Premier Line

| EDI | Part# | Size-in. | Size-mm | Handle |
|-------|--------|-----------|-----------|--------|
| 13808 | 5205W* | 8 X 8 | 203 X 203 | |
| 13809 | 5205D* | 8 X 8 | 203 X 203 | |
| 15207 | 5207W* | 10 X 10 | 254 X 254 | |
| 15220 | 5207D* | 10 X 10 | 254 X 254 | |
| 13814 | 5209W | 12 X 12 | 305 X 305 | |
| 13815 | 5209D | 12 X 12 | 305 X 305 | |
| 15209 | 5206W | 13 X 13 | 330 X 330 | |
| 15219 | 5206D | 13 X 13 | 330 X 330 | |
| 13816 | 5210W | 13½ X 13½ | 343 X 343 | |
| 13821 | 5210D | 13½ X 13½ | 343 X 343 | |
| 15208 | 5208W | 14 X 14 | 356 X 356 | |
| 15221 | 5208D | 14 X 14 | 356 X 356 | |
| 13825 | 5211W | 16 X 16 | 406 X 406 | |
| 13826 | 5211D | 16 X 16 | 406 X 406 | |

HAWKMATE™

- Holds joint knives, taping knives or trowels
- Easily attaches to most hawks
- Lightweight and durable aluminum construction
- Protects tools when not in use
- Sold 1 per inner pack/12 per outer pack

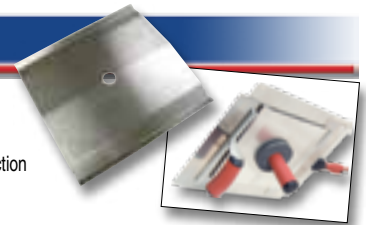

MADE IN
U.S.A

MARSHALLTOWN The Premier Line

| EDI | Part# | Size-in. | Size-mm |
|-------|--------|----------|-----------|
| 14949 | HM4949 | 9¼ X 9½ | 235 X 241 |

Composite Hawk

- Made of unique composite material
- Won't warp or react with caustic materials
- DuraSoft® handle and sponge rubber callus preventer
- Especially designed for the EIFS trade
- Sold 1 per inner pack/12 per outer pack

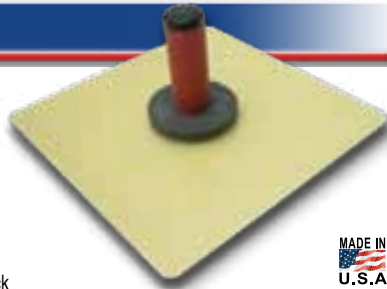

MADE IN
U.S.A

MARSHALLTOWN The Premier Line

| EDI | Part# | Size-in. | Size-mm |
|-------|-------|----------|-----------|
| 15222 | 2166D | 12 X 12 | 305 X 305 |

Aluminum Hawk

- Made of heavy gauge hard-rolled aluminum
- Lightweight but durable
- Edges have been smoothed and the corners rounded for convenience
- Has a threaded 3⁵/₈" (92mm) flange
- Wood handle and sponge callus preventer included
- Sold 6 per inner pack/24 per outer pack



QLT BY **MARSHALLTOWN**

| EDI | Part# | Size-in. | Size-mm |
|-------|-------|----------|-----------|
| 14659 | AH659 | 13 X 13 | 330 X 330 |

Hawk Handles

- Available in either wood or DuraSoft®
- Comes with a bolt for secure fastening
- Does not fit AH659
- Sold 1 per inner pack/12 per outer pack



MADE IN
U.S.A

MARSHALLTOWN The Premier Line

| EDI | Part# | Size-in. | Size-mm | Handle |
|-------|-------|----------|---------|--------|
| 19127 | 412W | N/A | N/A | |
| 19128 | 412D | N/A | N/A | |

Callus Preventer

- Made of sponge rubber
- Can be used with any of our hawks
- Sold 1 per inner pack/12 per outer pack



MADE IN
U.S.A

MARSHALLTOWN The Premier Line

| EDI | Part# | Size-in. | Size-mm |
|-------|-------|----------|---------|
| 19102 | 0 | N/A | N/A |

Left & Right Handed Bucket Trowels

- Forged from a single piece of high carbon steel
- For more details **see page 9**



MADE IN
U.S.A

Quick-Mix Mixers

- Blade is securely welded to 3/8" (10mm) hex shaft
- Ideal for stirring and blending paint, drywall mud and acoustic quickly and lump free
- Works with all 7/16" or larger and a limited number of 3/8" slow speed drills
- Blade measures 8 1/2 X 4 1/2" (216 X 115mm)
- Sold 6 per inner pack/6 per outer pack

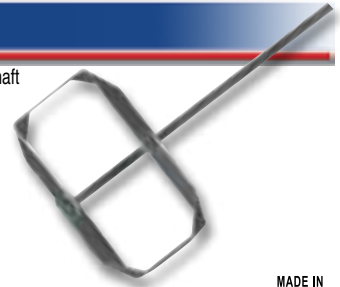

MADE IN
U.S.A

MARSHALLTOWN The Premier Line

| EDI | Part# | Size-in. | Size-mm |
|-------|-------|----------|---------|
| 16389 | 819 | 28 | 711 |
| 16371 | 819L | 36 | 914 |

Die-Cast Mud Mixers

- Ideal for stirring and blending paint, drywall mud and acoustic quickly and lump free
- Fits any 7/16" (11mm) or larger slow speed drill (500 rpm)
- Blade measures 8 1/2 X 4 1/2" (216 X 115mm)
- Sold 2 per inner pack/12 per outer pack

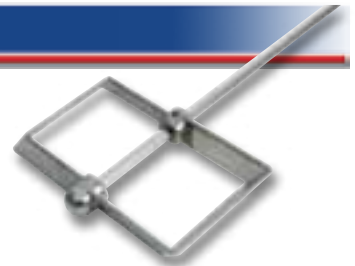

MARSHALLTOWN The Premier Line

| EDI | Part# | Size-in. | Size-mm |
|-------|-------|----------|---------|
| 14918 | DCM30 | 30 | 762 |
| 14919 | DCM36 | 36 | 914 |

Jiffler® Mixer

- Unique action disperses lumps fast as the lower wheel cuts upward and the upper wheel downward to create counter flow
- Plated carbon adjustable steel wheels
- Has a plated steel 3/8 X 16" (10 X 406mm) shaft that has been milled for a 1/4" (6mm) or larger chuck on portable or stationary power drill of at least 1000 rpm
- Sold 1 per inner pack/18 per outer pack

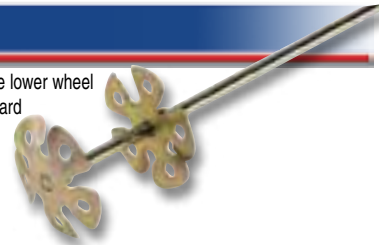

MADE IN
U.S.A

MARSHALLTOWN The Premier Line

| EDI | Part# | Size-in. | Size-mm |
|-------|-------|----------|---------|
| 16336 | 893 | 3/4 | 89 |

Fan Blade Mixers

- Plated shaft and adjustable blades resist corrosion
- Has a unique design that breaks up lumps faster as lower blade forces material upward while upper blade pushes downward to create counter flow
- The 2½" (64mm) mixer fits a ¾" (10mm) or larger variable speed drill
- The 5" (127mm) mixer fits ½" (13mm) chuck
- FM774 sold 6 per inner pack/48 per outer pack, FM661 sold 4 per inner pack/12 per outer pack

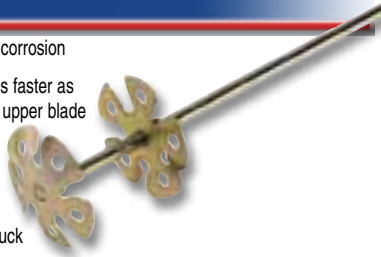

QLT BY MARSHALLTOWN

| EDI | Part# | Size-in. | Size-mm |
|-------|-------|----------|-----------|
| 14574 | FM774 | 2½ X 11 | 64 X 279 |
| 14661 | FM661 | 5 X 24 | 127 X 610 |

3 Blade Fan Mixer

- Three adjustable wheels to better mix compounds
- ¾" (10mm) diameter non-slip hex chuck shaft
- Plated shaft and blades resist corrosion
- 5" (127mm) fan wheels
- Sold 4 per inner pack/12 per outer pack

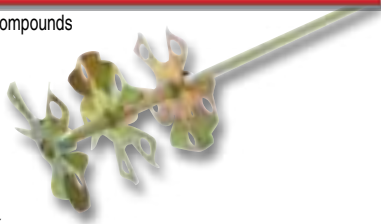

QLT BY MARSHALLTOWN

| EDI | Part# | Size-in. | Size-mm |
|-------|-------|----------|-----------|
| 14629 | FM629 | 5 X 24 | 127 X 610 |

Eggbeater Mixer

- Welded all-steel construction; fully plated
- 7/16" (11mm) steel hex shaft
- Sold 6 per inner pack/24 per outer pack



QLT BY MARSHALLTOWN

| EDI | Part# | Size-in. | Size-mm |
|-------|-------|----------|---------|
| 15445 | 897 | 30 | 762 |

Ribbon Mixers

- Made from high quality plated steel
- Ribbon design ensures even mix of all kinds of materials
- Ideal for mixing paint, drywall mud and EIFS adhesives and coatings
- Works best at 500-900 rpm
- The 2" (51mm) mixer fits a ¾" (10mm) or larger variable speed drill
- The 4" (102mm) and 5" (127mm) mixers fit a ½" (13mm) variable speed drill
- Inner/outer pack quantities are shown in table

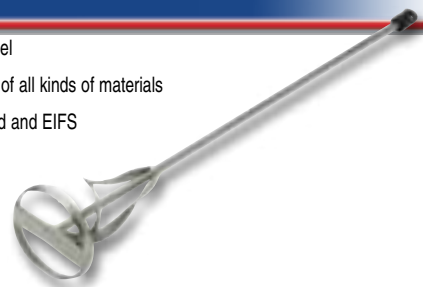

QLT BY MARSHALLTOWN

| EDI | Part# | Size-in. | Size-mm | Inner/Outer |
|-------|-------|----------|-----------|-------------|
| 14571 | RM771 | 2 X 16 | 51 X 406 | 12/48 |
| 14572 | RM772 | 4 X 24 | 102 X 610 | 6/24 |
| 14573 | RM773 | 5 X 30 | 127 X 762 | 4/24 |

Cyclone Paint Mixer

- Adjusts to mix liquids in gallon or quart cans
- Ideal for paints, adhesives, stains, and most viscous fluids
- Steel shaft fits ¾" (10 mm) or larger drill
- Bottom half of wheel should be removed to mix one quart containers
- Sold 6 per inner pack/72 per outer pack

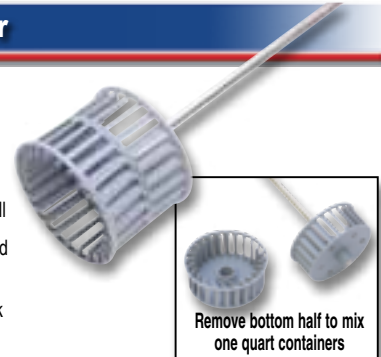

Remove bottom half to mix one quart containers

QLT BY MARSHALLTOWN

| EDI | Part# | Size-in. | Size-mm |
|-------|-------|----------|---------|
| 10798 | PM798 | N/A | N/A |

Square End Mud Mashers

- Heavy gauge steel 5 X 5½" (127 X 140mm) mixing head
- Plated to resist rust
- Metal ferrule is securely attached to the head
- Sturdy hardwood handle
- Sold 6 per inner pack/6 per outer pack



MADE IN U.S.A

MARSHALLTOWN The Premier Line

| EDI | Part# | Size-in. | Size-mm |
|-------|-------|----------|---------|
| 14834 | 891 | 25 | 635 |
| 16372 | 891L | 37 | 940 |

Semi-Round Mud Masher

- Heavy gauge plated steel mixing head
- Metal ferrule is securely attached
- 30" (762mm) hardwood handle
- Semi-round head measures 6 X 6 1/2" (152 X 165mm)
- Sold 6 per inner pack/6 per outer pack



MADE IN
U.S.A

MARSHALLTOWN The Premier Line

| EDI | Part# | Size-in. | Size-mm |
|-------|-------|----------|---------|
| 14836 | 892 | 37 | 940 |

Mud Masher

- Plated heavy gauge steel mixing head
- 14" (356mm) hardwood handle
- Square head
- Sold 6 per inner pack/6 per outer pack



QLT BY MARSHALLTOWN

| EDI | Part# | Size-in. | Size-mm |
|-------|-------|----------|---------|
| 14662 | MM662 | 24 1/2 | 623 |

Bucket Scoops

- Designed for effective mixing and scooping of thick materials
- Clip on handle allows scoop to hang from bucket
- Lightweight welded steel construction
- Curved shape for scraping inside walls of bucket
- Sold 6 per inner pack/6 per outer pack

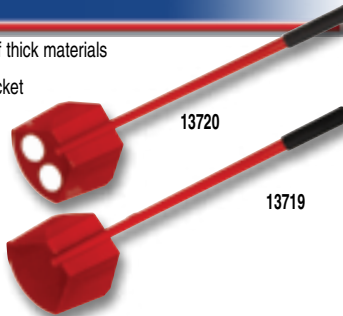

QLT BY MARSHALLTOWN

| EDI | Part# | Description | Size-in. | Size-mm |
|-------|-------|-------------|----------|---------|
| 13719 | 13719 | w/o holes | 25 1/4 | 641 |
| 13720 | 13720 | w/holes | 25 1/4 | 641 |

Bucket Dippers

- Galvanized steel construction
- Scoop mud directly on trowel or hawk
- Soft grip handle for increased grip and less fatigue
- Bucket hanging clip for less mess and easy storage
- Sold 1 per inner pack/6 per outer pack



QLT BY MARSHALLTOWN

| EDI | Part# | Size-in. | Size-mm | Size-oz. | Size-L |
|-------|-------|-----------------|-----------|----------|--------|
| 16862 | BD862 | 13 1/16 X 7 1/8 | 332 X 181 | 33.8 | 1 |
| 16863 | BD863 | 12 X 7 1/4 | 305 X 184 | 20.3 | 0.6 |

Automatic Taper

- Simultaneously applies joint tape and joint compound to drywall joints
- Designed to be the lightest, fastest, and smoothest running taper available
- Made of durable stainless steel and hard anodized aluminum parts
- Knurled sleeve for better grip
- Adjustable brake allows control of tension on main hub
- Grenade pin quick release taper cap
- Larger wheels on cutting system make cutting smoother
- Split clutch design reduces drag in corners
- Easy switch quick release tape spool keeper
- Sold 1 per inner pack/ 1 per outer pack



MARSHALLTOWN BY Columbia®

| EDI | Part# | Description | Size-in. | Size-mm |
|-------|--------|-----------------|----------|---------|
| 12263 | MTAPER | Automatic Taper | N/A | N/A |

Automatic Taper Repair Kits

Taper Wear Parts Kit (MCTRR1)

- 2 - Diamond Blades (MCT42A)
- 1 - Return Spring (MCT54)
- 2 - Needles (MCT63)
- 1 - Cable (MCT72)
- 1 - Clutch Return Spring (MCT81)

Taper Head Repair Kit (MCTR2)

- 2 - Insert Bushings (MCT2)
- 1 - Left Wafer Bushing (MCT4)
- 1 - Right Wafer Bushing (MCT5)
- 1 - Ratchet Rod (MCT15)
- 1 - Brake Dog (MCT16)
- 2 - Ratchet Gear (MCT67)
- 2 - Nylatron Washer (MCT76)

| EDI | Part# | Description | Size-in. | Size-mm |
|-------|--------|-----------------------|----------|---------|
| 12304 | MCTRR1 | Taper Wear Parts Kit | N/A | N/A |
| 12305 | MCTR2 | Taper Head Repair Kit | N/A | N/A |

Mastic Tube Syringe

- Quality built with high tolerance, hard anodized tube
- Works like a syringe by drawing up the mud as the handle is pulled back
- Designed to accommodate applicators as well as mechanical angle heads for second and third coats
- Push the handle to apply the mud through the use of mud heads, angle heads, corner finishers and flushers
- Sold 1 per inner pack/1 per outer pack



MARSHALLTOWN^{BY} Columbia®

| EDI | Part# | Description | Size-in. | Size-mm |
|-------|--------|----------------|----------|---------|
| 18567 | MCMT24 | Small Syringe | 24 | 610 |
| 18568 | MCMT36 | Medium Syringe | 36 | 914 |
| 18569 | MCMT42 | Large Syringe | 42 | 1067 |

Corner Roller

- Used after Automatic Taper on 90° internal angle joints on walls and ceilings
- Embeds paper tape into angles forcing out excess compound
- Split stainless steel/ Delrin wheel design lessens drag on tape
- Pivot head adjusts to angle
- Handles and corner roller are sold separately
- Aluminum handle is 10X stronger than fiberglass, won't break under pressure
- Extendible handles feature a smooth pin lock system and strong hexagonal design
- New drop down extension is easier to extend on the go
- Sold 1 per inner pack/1 per outer pack



MARSHALLTOWN^{BY} Columbia®

| EDI | Part# | Description | Size-in. | Size-mm |
|-------|---------|------------------------------|----------|-----------------|
| 12264 | MCR | Corner Roller | N/A | N/A |
| 12265 | MCRH | Corner Roller Handle | 48 | 1219 |
| 12266 | MCREXT | Corner Roller Handle (3-5ft) | 36 - 72 | 914.4 - 1828.8 |
| 12267 | MCREXTL | Corner Roller Handle (4-8ft) | 48 - 96 | 1219.2 - 2438.4 |

Corner Roller Repair Kit

- 1 - Roller (MCR2BLK)
- 1 - Roller (MCR2MTL)
- 1 - Bearing Sleeve (MCR3)
- 1 - Cut Washer (MCR4)
- 1 - Hex Bolt 1/4-20 x 1 1/2 (MFA299)

| EDI | Part# | Description | Size-in. | Size-mm |
|-------|-------|--------------------------|----------|---------|
| 12306 | MCRA2 | Corner Roller Repair Kit | N/A | N/A |

90° Applicators

- Designed to use with any Marshalltown by Columbia Compound Mud Tubes
- MCINT90 is used to apply joint compound to inside 90° corners prior to applying joint tape
- MCEXT90 evenly applies compound to outside corner bead quickly
- Sold 1 per inner pack/1 per outer pack



MARSHALLTOWN^{BY} Columbia®

| EDI | Part# | Description | Angle |
|-------|---------|---------------------|-------|
| 18570 | MCINT90 | Internal Applicator | 90° |
| 18571 | MCEXT90 | External Applicator | 90° |

Outside Corner Roller

- Squares up tape-on corner bead
- Applies even pressure as you roll bead in place
- Handle sold separately
- Sold 1 per inner pack/1 per outer pack



MARSHALLTOWN^{BY} Columbia®

| EDI | Part# | Description | Size-in. | Size-mm |
|-------|--------|------------------------|----------|---------|
| 18572 | MCOBCR | Corner Roller | N/A | N/A |
| 18573 | MCBNCR | Bullnose Corner Roller | N/A | N/A |



Angle Head Corner Finisher

- Used in 90° internal angle joints, after corner roller, to evenly feather compound
- Stainless steel wings and billet aluminum body for longer wear and performance
- "Fail Safe" locking mechanism locks angle head on the ball
- Wings are engraved for identification
- Handles and angle heads are sold separately
- Aluminum design is 10X stronger than fiberglass, won't break under pressure
- Extendible handles feature a smooth pin lock system and strong hexagonal design
- New handle drop down extension is easier to extend on the go
- Sold 1 per inner pack/1 per outer pack

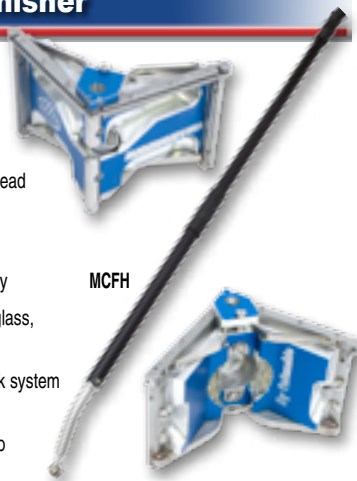

MCFH

MARSHALLTOWN^{BY} Columbia®

| EDI | Part# | Description | Size-in. | Size-mm |
|-------|---------|---------------------------------|----------|-----------------|
| 12268 | M2CF | 2" Angle Head Corner Finisher | 2 | 50.8 |
| 12269 | M25CF | 2.5" Angle Head Corner Finisher | 2.5 | 63.5 |
| 12270 | M3CF | 3" Angle Head Corner Finisher | 3 | 76.2 |
| 18574 | M3CFW | 3" Angle Head w/ Wheels | 3 | 76.2 |
| 12271 | M35CF | 3.5" Angle Head Corner Finisher | 3.5 | 88.9 |
| 12272 | MCFH | Angle Head Handle | 52 | 1320.8 |
| 12273 | MAHEXT | Angle Head Extendible Handle | 36 - 60 | 914.4 - 1524 |
| 12274 | MAHEXTL | Angle Head Extendible Handle | 48 - 96 | 1219.2 - 2438.4 |

Angle Head Corner Finisher Repair Kits

2" Repair Kit (MAHR12)

- 2 - 2" Top Blades (MAH32)
- 2 - Side Blades (MAH4)
- 16 - Set Screws $\frac{9}{32} \times \frac{1}{8}$ " (MFA235)
- 1 - Allen Key (MAH19)

3" Repair Kit (MAHR13)

- 2 - 3" Top Blades (MAH33)
- 2 - Side Blades (MAH4)
- 16 - Set Screws $\frac{9}{32} \times \frac{1}{8}$ " (MFA235)
- 1 - Allen Key (MAH19)

Spring Repair Kits (2" MAHR22, 2.5" MAHR225, 3" MAHR23 and 3.5" MAHR235)

- 1 - Funnel Retainer Spring (MAH6)
- 2 - Frame Tension Springs (MAH7)
- 1 - Top Retainer Clip (MAH8)
- 1 - Bottom Retainer Clip (MAH9)

2.5" Repair Kit (MAHR125)

- 2 - 2.5" Top Blades (MAH325)
- 2 - Side Blades (MAH4)
- 16 - Set Screws $\frac{9}{32} \times \frac{1}{8}$ " (MFA235)
- 1 - Allen Key (MAH19)

3.5" Repair Kit (MAHR135)

- 2 - 3.5" Top Blades (MAH335)
- 2 - Side Blades (MAH4)
- 16 - Set Screws $\frac{9}{32} \times \frac{1}{8}$ " (MFA235)
- 1 - Allen Key (MAH19)

| EDI | Part# | Description | Size-in. | Size-mm |
|-------|---------|-----------------------------------|----------|---------|
| 12307 | MAHR12 | 2" Angle Head Blade Repair Kit | 2 | 51 |
| 12308 | MAHR125 | 2.5" Angle Head Blade Repair Kit | 2.5 | 64 |
| 12309 | MAHR13 | 3" Angle Head Blade Repair Kit | 3 | 76 |
| 12310 | MAHR135 | 3.5" Angle Head Blade Repair Kit | 3.5 | 89 |
| 12311 | MAHR22 | 2" Angle Head Spring Repair Kit | 2 | 51 |
| 12312 | MAHR225 | 2.5" Angle Head Spring Repair Kit | 2.5 | 64 |
| 12313 | MAHR23 | 3" Angle Head Spring Repair Kit | 3 | 76 |
| 12314 | MAHR235 | 3.5" Angle Head Spring Repair Kit | 3.5 | 89 |

Flat Boxes

- "Crowns the Joint" distributes joint compound evenly in correct amounts over horizontal joints
- Adjustable stainless steel blade provides the right amount of compound to finish flat joints evenly
- No swell gaskets
- Rubber gasketed bar system stays flexible, and rubber roller wheels provide soft ride
- Hinged door for easy cleaning and use without springs
- Fat Boy Boxes are able to hold 40% more compound than standard boxes
- Grip box handles are sold separately
- Sold 1 per inner pack/1 per outer pack

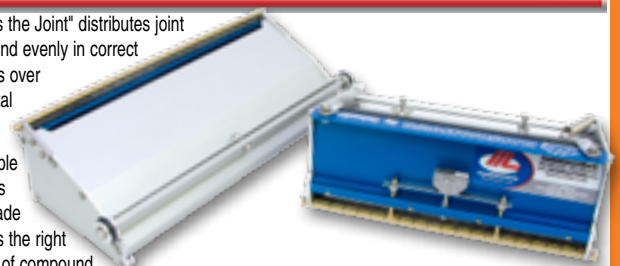

MARSHALLTOWN^{BY} Columbia®

| EDI | Part# | Description | Size-in. | Size-mm |
|-------|--------|-----------------------|----------|---------|
| 12285 | M7FFB | 7" Flat Finisher Box | 7 | 178 |
| 12286 | M8FFB | 8" Flat Finisher Box | 8 | 203 |
| 12287 | M10FFB | 10" Flat Finisher Box | 10 | 254 |
| 12288 | M12FFB | 12" Flat Finisher Box | 12 | 305 |
| 12289 | M8FBB | 8" Fat Boy Box | 8 | 203 |
| 12290 | M10FBB | 10" Fat Boy Box | 10 | 254 |
| 12291 | M12FBB | 12" Fat Boy Box | 12 | 305 |

Flat Box Repair Kits

7" Flat Box Blade Repair Kit (MFFBR17)

- 3 - 7" Box Blades (MFFB97)
- 3 - Right Box Shoes (MFFB7)
- 3 - Left Box Shoes (MFFB7A)

10" Flat & Fat Boy Box Blade Repair Kit (MFFBR110)

- 3 - 10" Box Blades (MFFB910)
- 3 - Right Box Shoes (MFFB7)
- 3 - Left Box Shoes (MFFB7A)

Flat & Fat Boy Box Blade Bar Repair Kit (7" MFFBR27, 8" MFFBR28, 10" MFFBR210 & 12" MFFBR212)

- 1 - Right Box Shoe (MFFB7)
- 1 - Left Box Shoe (MFFB7A)
- 2 - Bar Retainer Clips (MFFB8)
- 1 - Box Bar Assembly (MFFBA10)

8" Flat & Fat Boy Box Blade Repair Kit (MFFBR18)

- 3 - 8" Box Blades (MFFB98)
- 3 - Right Box Shoes (MFFB7)
- 3 - Left Box Shoes (MFFB7A)

12" Flat & Fat Boy Box Blade Repair Kit (MFFBR112)

- 3 - 12" Box Blades (MFFB912)
- 3 - Right Box Shoes (MFFB7)
- 3 - Left Box Shoes (MFFB7A)

Axle Roller Replacement Kit (Any size Flat or Fat Boy Box) MFFBA6

- 1 - New Style Box Wheel (MFFB36)
- 1 - New Style O-ring (MFFB37)
- 1 - Axle Wheel Bushing (MFFB38)
- 1 - Axle Wheel Screw (MFFB39)
- 1 - #10 Flat Washer (MFA268)

| EDI | Part# | Description | Size-in. | Size-mm |
|-------|----------|--------------------------------------|----------|---------|
| 12317 | MFFBR17 | Flat Blade Repair Kit | 7 | 178 |
| 12318 | MFFBR18 | Flat & Fat Boy Blade Repair Kit | 8 | 203 |
| 12319 | MFFBR110 | Flat & Fat Boy Blade Repair Kit | 10 | 254 |
| 12320 | MFFBR112 | Flat & Fat Boy Blade Repair Kit | 12 | 305 |
| 12321 | MFFBR27 | Flat 7" Blade Bar Repair Kit | 7 | 178 |
| 12322 | MFFBR28 | Flat & Fat Boy Blade Bar Repair Kit | 8 | 203 |
| 12323 | MFFBR210 | Flat & Fat Boy Blade Bar Repair Kit | 10 | 254 |
| 12324 | MFFBR212 | Flat & Fat Boy Blade Bar Repair Kit | 12 | 305 |
| 12316 | MFFBA6 | Axle Roller Repl. Kit (any size box) | N/A | N/A |

Grip Box Handles

- Used in conjunction with any flat box in coating flats and butt joints.
- Allows use of flat boxes at multiple lengths
- 180° Grip handle allows for continued braking over the entire range of motion
- Adjustable stabilizer ball helps you achieve perfect balance and desired pressure point
- Hydra-Reach features hydraulic power grip to achieve more pressure with less force
- Wide grip provides stronger design that is 25% more lightweight than previous design
- Hydra Reach only weighs 2.5lbs
- Sold 1 per inner pack/1 per outer pack



MARSHALLTOWN^{BY} Columbia®

| EDI | Part# | Description | Size-in. | Size-mm |
|-------|-------|---------------------------------|----------|-------------|
| 12292 | M3BH | 3' - 180 Grip Box Handle | 36 | 914 |
| 12293 | M42BH | 3.5' - 180 Grip Box Handle | 42 | 1067 |
| 12294 | M4BH | 4' - 180 Grip Box Handle | 48 | 1219 |
| 12295 | M5BH | 5' - 180 Grip Box Handle | 60 | 1524 |
| 12296 | M6BH | 6' - 180 Grip Box Handle | 72 | 1829 |
| 12297 | MEBH | Hydra-Reach Extendible Box Hndl | 42 - 63 | 1067 - 1600 |

180° Bent Grip Box Handle

- Used in conjunction with any flat box to assist in coating flats and butt joints
- Ergonomic design leverages the force on to the wall
- 180° Grip box handle allows for continued braking over entire range of motion
- Adjustable stabilizer balls helps you achieve perfect balance and desired pressure point
- Versatile design provides best possible braking at any angle
- Extra strong billet aluminum construction for years of rugged usage
- Flat boxes and handles sold separately
- Sold 1 per inner pack/1 per outer pack



MARSHALLTOWN^{BY} Columbia®

| EDI | Part# | Description | Size-in. | Size-mm |
|-------|--------|---------------------------------|----------|---------|
| 18576 | M3BBH | 3' - 180 Bent Grip Box Handle | 36 | 914 |
| 18577 | M42BBH | 3.5' - 180 Bent Grip Box Handle | 42 | 1067 |
| 18578 | M4BBH | 4' - 180 Bent Grip Box Handle | 48 | 1219 |
| 18579 | M5BBH | 5' - 180 Bent Grip Box Handle | 60 | 1524 |
| 18580 | M6BBH | 6' - 180 Bent Grip Box Handle | 72 | 1829 |

Corner Flusher Box

- Used along with an attached angle head to apply a second coat to corners for all 90° internal angles
- Stainless steel cone dispenses the proper amount of drywall compound smoothly and evenly
- No swell gaskets
- Hinged door with thumb release door stop allows for quick clean
- Handles and angle head corner finishers are sold separately
- Aluminum design is 10X stronger than fiberglass, won't break under pressure
- Extendible handle features a smooth pin lock system and strong hexagonal design
- New handle drop down extension is easier to extend on the go
- Sold 1 per inner pack/1 per outer pack

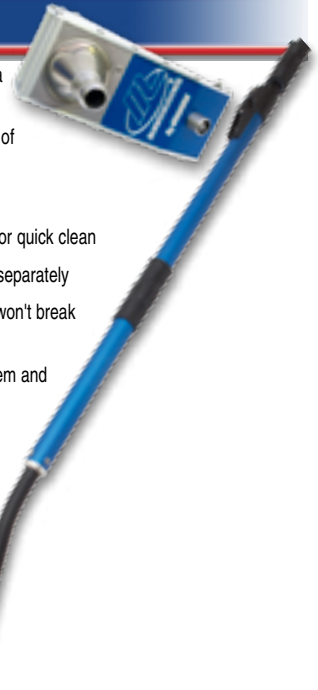

MARSHALLTOWN^{BY} Columbia®

| EDI | Part# | Description | Size-in. | Size-mm |
|-------|---------|----------------------------------|----------|--------------|
| 12275 | M7CFB | 7" Corner Flusher Box | 7 | 178 |
| 12276 | M8CFB | 8" Corner Flusher Box | 8 | 203 |
| 12277 | MCFBH | Cnrn Flusher Box Handle | 48 | 1219 |
| 12278 | MCFBEXT | Cnrn Flusher Box Extendible Hndl | 36 - 60 | 914.4 - 1524 |

Nail Spotters

- Smoothly and efficiently covers nail and screw head depressions
- Commercial grade aluminum construction
- Rugged skid plate rides easily on the wall
- Hinged door for easy access and cleaning
- Adjustable thumb tension screw allows for quick and easy adjustment of pivot tension
- Thumb release clip on door for quick access
- Handles and nail spotters are sold separately
- **MCRH** is a lightweight fiberglass handle
- Extendible handles feature a smooth pin lock system and strong hexagonal design
- Sold 1 per inner pack/1 per outer pack

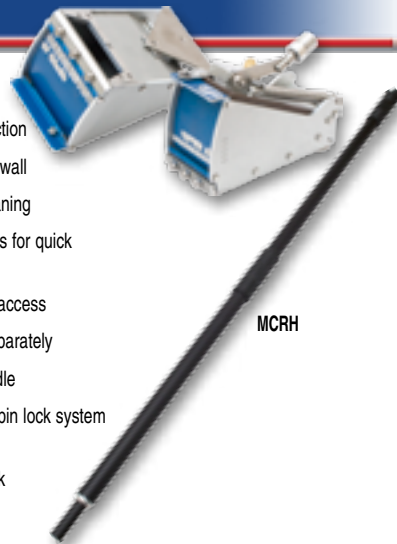

MARSHALLTOWN BY Columbia®

| EDI | Part# | Description | Size-in. | Size-mm |
|-------|---------|-----------------------------|----------|-----------------|
| 12298 | M2NS | 2" Nail Spotter | 2 | 51 |
| 12299 | M3NS | 3" Nail Spotter | 3 | 76 |
| 12265 | MCRH | Nail Spotter Handle | 48 | 1219 |
| 12266 | MCREXT | Nail Spotter Handle (3-6ft) | 36-72 | 914.4 - 1828.8 |
| 12267 | MCREXTL | Nail Spotter Handle (4-8ft) | 48-96 | 1219.2 - 2438.4 |

Nail Spotter Wheel Kits

- Allows for changing from skid plate to wheel assembly
- 2" and 3" Nail Spotter
- 1 - Axle 2"(MHNS52) or 3"(MHNS53)
- 2 - Wheels (MHNS6)
- 2 - Wheel O-Ring (MHNS6A)
- 2 - 6-32 3/8" Hex Bolt (MFA231)
- 2 - 3/8" Nyloc Nut (MFA254)
- Nail spotter boxes not included



MARSHALLTOWN BY Columbia®

| EDI | Part# | Description | Size-in. | Size-mm |
|-------|--------|---------------------------|----------|---------|
| 18448 | MHNSA2 | Nail Spotter Wheel Kit 2" | 2 | 51 |
| 18449 | MHNSA3 | Nail Spotter Wheel Kit 3" | 3 | 76 |

Visit us at:
www.MARSHALLTOWN.com/tapingtools
 for complete tool schematics.

Mud Pump

- Strong billet aluminum construction
- Used with **(MBF)** box filler and **(MGN)** gooseneck to keep your tools full of mud
- Quick Clean Mud Pump features a releasable tube for easy cleaning
- **Box filler and gooseneck are sold separately**
- Sold 1 per inner pack/1 per outer pack



MARSHALLTOWN BY Columbia®

| EDI | Part# | Description | Size-in. | Size-mm |
|-------|-------|----------------------|----------|---------|
| 12281 | MHMP | Quick Clean Mud Pump | N/A | N/A |
| 12283 | MBF | Box Filler | N/A | N/A |
| 12284 | MGN | Gooseneck | N/A | N/A |

Mud Pump Repair Kits (used for both MHMP and MMP)

- | | |
|-------------------------------|-----------------------------|
| 2 - Pump Flapper Valve (MMP3) | 1 - O-ring (MMP23A) |
| 1 - Piston Cup (MMP14) | 1 - Mud Pump Screen (MMP24) |
| 1 - Mud Pump Seal (MMP23) | 1 - Filler Gasket (MMP33) |

| EDI | Part# | Description | Size-in. | Size-mm |
|-------|-------|---------------------|----------|---------|
| 12315 | MMPR1 | Mud Pump Repair Kit | N/A | N/A |

Tool Display Stand

- Easy to assemble
- Made of fiber board with a smooth painted surface
- Holds a complete set of automatic taping tools
- Tools sold separately
- Sold 1 per inner pack/
1 per outer pack



MARSHALLTOWN BY Columbia®

| EDI | Part# | Description | Size-in. | Size-mm |
|-------|---------|---------------|----------|---------|
| 12335 | COLDISP | Display Stand | N/A | N/A |

Marshalltown by Columbia Repair Parts

- Wear parts on automatic taper including diamond blade and cable
- Flat and fat boy box parts including shoes and blades
- Angle head parts including blades and top and bottom corner clips
- Blades and door gaskets for nail spotters
- Filler gasket for mud pumps
- Sold 1 per inner pack/ 1 per outer back

MARSHALLTOWN by Columbia Automatic Taper Parts

| EDI | Part# | Description | Size-in. | Size-mm |
|-------|---------|----------------------------|----------|---------|
| 18400 | MCT2 | Nylatron Insert Bushing | N/A | N/A |
| 18401 | MCT4 | L-Nylatron Wafer Bushing | N/A | N/A |
| 18402 | MCT5 | R-Nylatron Wafer Bushing | N/A | N/A |
| 18403 | MCT15 | Ratchet Rod for Adj. Brake | N/A | N/A |
| 18404 | MCT16 | Brake Dog | N/A | N/A |
| 18405 | MCT28 | Roller Bushing | N/A | N/A |
| 18406 | MCT29 | R-Nylatron Chain Roller | N/A | N/A |
| 18407 | MCT29A | L-Nylatron Chain Roller | N/A | N/A |
| 18408 | MCT42A | Diamond Blade | N/A | N/A |
| 18409 | MCT54 | Return Spring | N/A | N/A |
| 18410 | MCT63 | Needle | N/A | N/A |
| 18411 | MCT67 | Ratchet Gear | N/A | N/A |
| 18412 | MCT72 | Cable | N/A | N/A |
| 18413 | MCTA41 | Cutter Block Assembly | N/A | N/A |
| 18414 | MCTA107 | Piston Assembly | N/A | N/A |

Flat & Fat Boy Box Parts

| EDI | Part# | Description | Size-in. | Size-mm |
|-------|---------|--------------|----------|---------|
| 18415 | MFFB7 | Shoe (right) | N/A | N/A |
| 18416 | MFFB7A | Shoe (left) | N/A | N/A |
| 18417 | MFFB97 | 7" Blade | 7 | 178 |
| 18418 | MFFB98 | 8" Blade | 8 | 203 |
| 18419 | MFFB910 | 10" Blade | 10 | 254 |
| 18420 | MFFB912 | 12" Blade | 12 | 305 |

Angle Head Parts

| EDI | Part# | Description | Size-in. | Size-mm |
|-------|--------|-----------------------------|----------|---------|
| 18421 | MAH32 | 2" Top Blade (carbide) | 2 | 51 |
| 18422 | MAH325 | 2.5" Top Blade (carbide) | 2.5 | 64 |
| 18423 | MAH33 | 3" Top Blade (carbide) | 3 | 76 |
| 18424 | MAH335 | 3.5" Top Blade (carbide) | 3.5 | 89 |
| 18425 | MAH4 | Side Blade | N/A | N/A |
| 18426 | MAH8 | Top Retainer Corner Clip | N/A | N/A |
| 18427 | MAH8A | Top Retainer Corner Clip | 3.5 | 89 |
| 18428 | MAH9 | Bottom Retainer Corner Clip | N/A | N/A |
| 18429 | MAH9A | Bottom Retainer Corner Clip | 3.5 | 89 |

Nail Spotter Parts

| EDI | Part# | Description | Size-in. | Size-mm |
|-------|--------|----------------|----------|---------|
| 18430 | MNS72 | 2" Blade | 2 | 51 |
| 18431 | MNS73 | 3" Blade | 3 | 76 |
| 18432 | MNS152 | 2" Door Gasket | 2 | 51 |
| 18433 | MNS153 | 3" Door Gasket | 3 | 76 |

Mud Pump Parts

| EDI | Part# | Description | Size-in. | Size-mm |
|-------|-------|---------------|----------|---------|
| 18434 | MMP33 | Filler Gasket | N/A | N/A |

TapeShooter® Drywall Tapers

- Precision mud flow control is easy to adjust
- Made from lightweight aluminum
- One-handed mud loading
- Latched door on tape spool holder
- Adjustable web side handle with thumb rest (see photo)
- Serrated cut-off blade
- Comfortable DuraSoft® handle
- Available as right-handed or left-handed
- Sold 1 per inner pack/1 per outer pack



MADE IN
U.S.A

MARSHALLTOWN The Premier Line

| EDI | Part# | Description | Size-in. | Size-mm |
|-------|-------|--------------------|----------|---------|
| 16375 | 798D | Right-Handed | N/A | N/A |
| 16376 | 799D | Left-Handed | N/A | N/A |
| 16457 | RB798 | Repl. Blade, Right | N/A | N/A |
| 16458 | RB799 | Repl. Blade, Left | N/A | N/A |

SeamSlammer™ Drywall Taper

- Apply drywall tape easily and quickly
- Holds 500 ft. (152M) roll of tape
- Bulkhead separates tape from mud, keeping the roll dry
- Adjustable thumbscrew applies just the right amount of mud on the tape
- Adjustable strap and wood handle included
- Sold 1 per inner pack/4 per outer pack, 1 per inner pack/1 per outer pack where noted with *

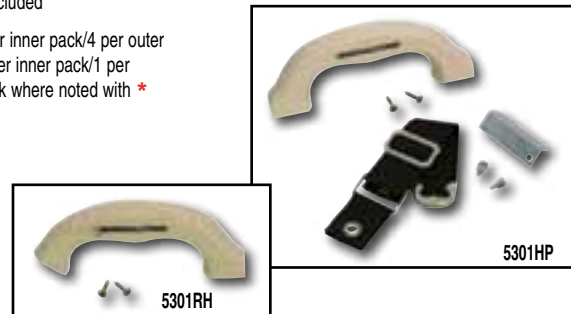

MARSHALLTOWN The Premier Line

| EDI | Part# | Description | Size-in. | Size-mm |
|-------|--------|--------------------|------------|-----------|
| 10997 | 5301 | SeamSlammer™ | 23 X 9 1/2 | 584 X 241 |
| 10998 | 5301HP | Taper Handle Pack* | N/A | N/A |
| 10999 | 5301RH | Repl. Handle* | 7 X 2 3/4 | 178 X 70 |
| 11000 | 5301SK | Taper Seal Kit* | N/A | N/A |
| 11001 | 5301BP | Repl. Blade* | 5 X 2 1/4 | 127 X 57 |

Drywall Taper

- Made from lightweight aluminum
- Precision mud flow control is easy to adjust
- Has soft grip and adjustable web side handle
- Latched door on tape spool holder
- One-handed mud loading
- Serrated cut-off blade
- Sold 1 per inner pack/1 per outer pack
- Replacement blades sold 12 per inner pack/144 per outer pack



QLT BY MARSHALLTOWN

| EDI | Part# | Description | Size-in. | Size-mm |
|-------|--------|-------------------|----------|---------|
| 16024 | 6024 | Drywall Taper | N/A | N/A |
| 16025 | RB6025 | Replacement Blade | N/A | N/A |

Mud Pan and Tape Holder

- Holder hooks to user's belt to hold mud pan where it can be easily accessed
- When assembled, unit will hold a 12" (305mm) mud pan and up to a 500 ft. (152M) roll of drywall tape
- Some assembly required
- Sold 1 per inner pack/6 per outer pack



QLT BY MARSHALLTOWN

| EDI | Part# | Size-in. | Size-mm |
|-------|-------|----------|---------|
| 16228 | MP228 | 12 | 305 |

The Paper Taper™

- Dispenses flat and folded tape
- Holds up to 500 ft. (152M) rolls of paper tape
- Includes belt clip and metal cutting blade
- Tension arm prevents tape backlash
- Sold 1 per inner pack/6 per outer pack



*Tape not included

MARSHALLTOWN The Premier Line

| EDI | Part# | Size-in. | Size-mm |
|-------|-------|----------|-----------|
| 13476 | PT76 | 8 X 6½ | 203 X 153 |

Drywall Tape Reel

- Made of steel and plated to prevent rust
- Holds all standard tape rolls up to 500 ft. (152M)
- Hangs on belt for easy dispensing
- Quick opening design makes changing tape easy
- Sold 6 per inner pack/6 per outer pack

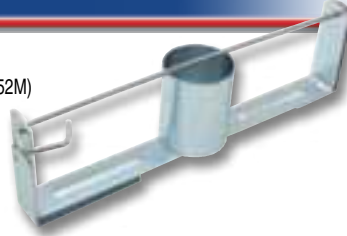

MARSHALLTOWN The Premier Line

| EDI | Part# | Size-in. | Size-mm |
|-------|-------|----------|----------|
| 16331 | 31 | 10¼ X 3 | 260 X 76 |

Mesh Taper

- Quickly applies mesh tape to flat seams
- Roller extends for easy application into corners
- Trigger operated blade cuts mesh
- For use with self-adhesive mesh tape
- Accepts mesh tape rolls with 2" (51mm) and 3" (76mm) cores
- Sold 1 per inner pack/6 per outer pack



MARSHALLTOWN The Premier Line

| EDI | Part# | Size-in. | Size-mm |
|-------|-------|----------|-----------|
| 13472 | MT72 | 12½ X 10 | 318 X 254 |

Drywall Mesh Tape

- Self-adhesive and requires no special preparation
- User can apply directly to joint without using compound
- Finish coats are then applied over the tape
- Joint is finished quickly and without all the mess
- Inner/outer pack quantities are shown in table



MARSHALLTOWN The Premier Line

| EDI | Part# | Standard | Metric | Inner/Outer |
|-------|-------|-----------|------------|-------------|
| 16404 | MT04 | 36' X 2" | 11M X 51mm | 1/36 |
| 16405 | MT05 | 75' X 2" | 23M X 51mm | 1/24 |
| 16406 | MT06 | 150' X 2" | 46M X 51mm | 1/24 |
| 16407 | MT07 | 300' X 2" | 91M X 51mm | 1/24 |

Cornerbead Tape

- Combines both the flexibility of tape with the strength of steel reinforcement
- Embed with metal side facing the wall and finish off in the regular manner
- Sold 1 per inner pack/10 per outer pack

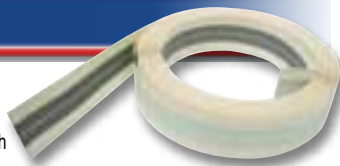

MADE IN
U.S.A

MARSHALLTOWN The Premier Line

| EDI | Part# | Standard | Metric |
|-------|-------|-----------|------------|
| 16403 | CT03 | 100' X 2" | 30M X 51mm |

Panel Lifter

- Non-slip checkered surface provides foot traction
- Self-righting feature makes it ready for use without fumbling
- Tapered front end slides easily under the board; then it lifts and holds it in place while nailing
- Sold 2 per inner pack/2 per outer pack



MARSHALLTOWN The Premier Line

| EDI | Part# | Size-in. | Size-mm |
|-------|-------|------------|-----------|
| 15330 | 790 | 12 X 5 1/4 | 305 X 133 |

Panel Lifter/Rasp/Bottle Opener

- Non-clogging rasp with protective guides
- Lifts all standard sizes of drywall sheets
- Lightweight, compact, fits in pocket
- Bottle opener integrated into lifter
- Sold 1 per inner pack/6 per outer pack, PL589-5 display sold 12 inner pack/12 per outer pack



QLT BY **MARSHALLTOWN**

| EDI | Part# | Description |
|-------|---------|-----------------------------|
| 14589 | PL589 | Panel Lifter |
| 14584 | PL589-5 | 12 Piece Countertop Display |

Roll Panel Lifter

- The rigid steel construction, ribbed back, weighted nose and roller-wheel all combine for moving ease
- Permits one-man handling and nailing
- Sold 2 per inner pack/10 per outer pack



QLT BY **MARSHALLTOWN**

| EDI | Part# | Size-in. | Size-mm |
|-------|-------|------------|----------|
| 14590 | RL801 | 15 X 2 1/4 | 381 X 57 |

Roll Panel Lifter

- The rigid steel construction, ribbed back, weighted nose and roller-wheel all combine for moving ease
- Permits one-man handling and nailing
- Sold 2 per inner pack/10 per outer pack



QLT BY **MARSHALLTOWN**

| EDI | Part# | Size-in. | Size-mm |
|-------|-------|------------|----------|
| 14591 | 4591 | 15 X 2 1/4 | 381 X 57 |

Drywall Panel Carriers

- Compact design
- Easily carry large sheet material
- Carry multiple sheets at once
- Easy two-person carrying
- Sold 6 per inner pack/36 per outer pack



QLT BY **MARSHALLTOWN**

| EDI | Part# | Size-in. | Size-mm |
|-------|--------|---------------|-----------|
| 14930 | DPC930 | 5 1/4 X 4 3/4 | 133 X 121 |

Drywall Cart

- 3/4" (19mm) Pipe tubing construction with rounded corners
- Bed is sloped to carry boards at correct angle
- Includes four rubber over steel casters: 2 swivel casters, and 2 locking swivel casters
- Fits through most doorways
- Ships unassembled in one box
- Can ship small parcel carrier
- Assembled weight: 89 lbs.
- CAUTION: HEAVY - 2 People Required to Lift
- DC344SC is a replacement swivel caster
- DC344LSC is a replacement locking swivel caster
- Sold 1 per inner pack/1 per outer pack



QLT BY **MARSHALLTOWN**

| EDI | Part # | Size-in. | Size-mm |
|-------|----------|--------------------|-------------------------|
| 10344 | DC344U | 48 W x 23 D x 48 H | 1219 W x 584 D x 1219 H |
| 10457 | DC344SC | 8 | 203 |
| 10458 | DC344LSC | 8 | 203 |

DuraSoft® Drywall Rasps

- Removes 45% more material per stroke than other popular rasps
- Will not clog or collect dust
- Works in both directions
- DR389** has guard rails that keep the rasp on edge to prevent injury
- Long-lasting premium stainless steel blade
- Contoured DuraSoft® handle ensures a good grip
- Ends of blade get into tight spaces
- Sharp blade has many other uses like backer board and vinyl tile
- Sold 1 per inner pack/4 per outer pack



MADE IN
U.S.A.
U.S. Patent Nos.
D493,340 and D494,832

MARSHALLTOWN The Premier Line

| EDI | Part# | Description | Size-in. | Size-mm |
|-------|-------|---------------------|----------|---------|
| 14389 | DR389 | With Guard Rails | 5½ | 140 |
| 14390 | DR390 | Without Guard Rails | 5½ | 140 |

Drywall Rasp

- Efficient design to smooth rough-cut drywall edges
- No-load slot prevents clogging
- Comfortable wood handle
- Sold 12 per inner pack/60 per outer pack



QLT BY MARSHALLTOWN

| EDI | Part# | Size-in. | Size-mm |
|-------|-------|----------|---------|
| 14381 | DR381 | 7½ | 191 |

Drywall Saw

- Hardened and tempered blade with five teeth per inch
- Cuts quickly through wallboard, gypsum, lath and thin coat backing board
- Comfortable soft grip handle securely attached to blade
- Sold 6 per inner pack/60 per outer pack



MARSHALLTOWN The Premier Line

| EDI | Part# | Description | Size-in. | Size-mm |
|-------|-------|------------------|----------|---------|
| 16579 | 79 | Soft Grip Handle | 15 | 381 |

Drywall Saws

- Cuts quickly through wallboard, gypsum, lath and thin coat backing board
- Hardened and tempered blade
- Five teeth per inch
- DS921 sold 6 per inner pack/60 per outer pack, SGDS32 sold 6 per inner pack/6 per outer pack



QLT BY MARSHALLTOWN

| EDI | Part# | Size-in. | Size-mm |
|-------|--------|----------|---------|
| 16128 | DS921 | 15 | 381 |
| 13732 | SGDS32 | 15 | 381 |

Drywall Utility Saws

- Heavy gauge blade with eight teeth per inch
- Sharp point to penetrate wallboard easily without drilling
- Contoured wood handles
- Cuts wallboard, masonite, plywood and wood
- 18 sold 12 per inner pack/12 per outer pack, 22 sold 6 per inner pack/144 per outer pack



MARSHALLTOWN The Premier Line

| EDI | Part# | Size-in. | Size-mm |
|-------|-------|----------|---------|
| 16324 | 18 | 6 | 152 |
| 16322 | 22 | 6 | 152 |

Drywall Utility Saw

- Rugged steel blade with eight teeth per inch
- Sharp point can penetrate wallboard without drilling
- Cuts wallboard, masonite, plywood and wood
- Sold 12 per inner pack/120 per outer pack



QLT BY MARSHALLTOWN

| EDI | Part# | Size-in. | Size-mm |
|-------|-------|----------|---------|
| 16120 | US920 | 6 | 152 |

RockWarrior® Utility Saw

- Tempered, high carbon steel blade with beveled point
- Blade cuts in both directions
- Intended for drywall; will cut almost any non-metallic material
- Sturdy, soft grip handle
- RW426-5 display includes 12 saws
- RW426 sold 1 per inner pack/12 per outer pack



QLT BY MARSHALLTOWN

| EDI | Part# | Size-in. | Size-mm |
|-------|---------|----------|---------|
| 16426 | RW426 | 6 | 152 |
| 16452 | RW426-5 | N/A | N/A |

Soft Grip Utility Saw

- Sharp point can penetrate wallboard without drilling
- Heavy gauge 6" (152mm) steel blade
- Cuts wallboard, masonite, plywood and wood
- Comfortable soft grip handle
- Sold 1 per inner pack/12 per outer pack



QLT by MARSHALLTOWN

| EDI | Part# | Size-in. | Size-mm |
|-------|-------|----------|---------|
| 10810 | US810 | 6 | 152 |

Folding Utility Knife

- One-step blade change
- One-hand opening and closing
- For more details **see page 235**



Utility Knives

- Many styles of knives to choose from
- For more details and size options **see page 235**



18mm Break-Off Blade Knives

- Many styles of knives to choose from
- For our complete line of knives **see page 236**



9mm Break-Off Blade Knives

- Several styles of knives to choose from
- For our complete line of knives **see page 236**



9mm Replacement Blades

- For knives 9051, 9065 and 9066
- For more details **see page 237**

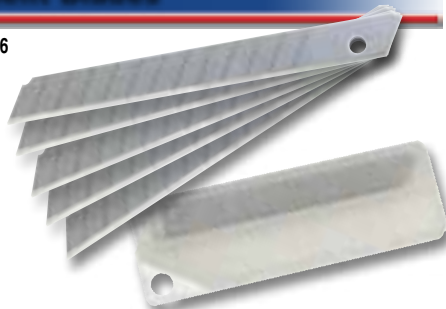

Tape Measure

- Soft feel grip
- Self retracting
- Wide belt clip
- Auto locking mechanism
- Push button to retract tape
- Sold 1 per inner pack/1 per outer pack



QLT by MARSHALLTOWN

| EDI | Part# | Description | Length |
|-------|-------|-----------------------|--------|
| 10516 | 10516 | Standard tape measure | 25' |

Chalk & Chalk Boxes

- For more details **see pages 238-239**



Carbide Scoring Cutter

- Score and cut cement backer board, linoleum, Plexiglas, and soft tile
- Excellent tool for degrouting work or removing caulk
- For more details **see page 218**



Heavy Duty Drywall Stripper

- Auxiliary handle allows more control and pressure while cutting
- Can be adjusted for right or left handed dominance
- Cuts strips up to 5" (127mm) wide
- Cuts 3/8, 1/2 and 5/8" (10, 13 and 16mm) drywall as well as ceiling tiles
- Sold 1 per inner pack/6 per outer pack



QLT BY MARSHALLTOWN

| EDI | Part# | Description | Size-in. | Size-mm |
|-------|-------|--------------|----------|---------|
| 16628 | DS628 | Stripper | N/A | N/A |
| 16493 | 16493 | Repl. blades | N/A | N/A |

Acoustical Tile Saw

- Quickly and accurately cuts holes in acoustic tile
- Blade is perfectly sized to cut holes for sprinkler heads
- Lightweight, compact design fits comfortably in tool belt
- Sold 1 per inner pack/6 per outer pack



MARSHALLTOWN The Premier Line

| EDI | Part# | Size-in. | Size-mm |
|-------|-------|----------|----------|
| 13481 | ATS81 | 2½ X 6¼ | 64 X 159 |

Easy Read Circle Cutter

- Quickly scribes a circle with one turn of the wrist
- Works well on drywall and other similar materials
- Cuts 4 to 8¼" (102 to 210mm) diameter holes with ease
- Hardened and tempered blade for extended life
- Sold 1 per inner pack/10 per outer pack



MARSHALLTOWN The Premier Line

| EDI | Part# | Size-in. | Size-mm |
|-------|-------|----------|----------|
| 13480 | CC480 | 9 X 2¾ | 229 X 70 |

Drywall Circle Cutter

- Hardened cutter wheel and center pin will remain sharp indefinitely
- Cuts sharp clean circles up to 16" (406mm) in diameter with only one hand
- Measure accurately on the calibrated steel shaft
- Sold 6 per inner pack/60 per outer pack



QLT BY MARSHALLTOWN

| EDI | Part# | Size-in. | Size-mm |
|-------|-------|----------|---------|
| 14556 | CC766 | 8½ | 216 |

Handi-Square Adjustable T-Square

- Made from durable extruded aluminum
- Adjusts from 0° to 360°
- Heavy duty blade
- Has one arm which measures 16" for finding studs
- Head is notched which enables cutting a 48" board in one pass while the board is standing on the floor
- Sold 2 per inner pack/2 per outer pack

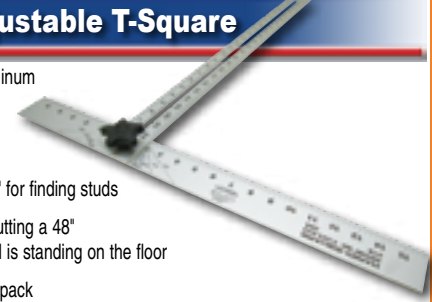

MADE IN U.S.A.

MARSHALLTOWN The Premier Line

| EDI | Part# | Description | Size-in. | Size-mm |
|-------|-------|----------------|----------|-----------|
| 16330 | 27A | ¼" Thick Blade | 48 X 22 | 191 X 165 |

Standard Drywall T-Square

- Silver anodized finish with black epoxy paint numerals for long wear and legibility
- Notched head, reverse rulings and stud markings allow for quick, accurate cuts
- Aircraft-style rivets secure blades for long term accuracy
- Head is notched which enables cutting a 48" board in one pass while the board is standing on the floor
- Inner/outer pack quantities are shown in table

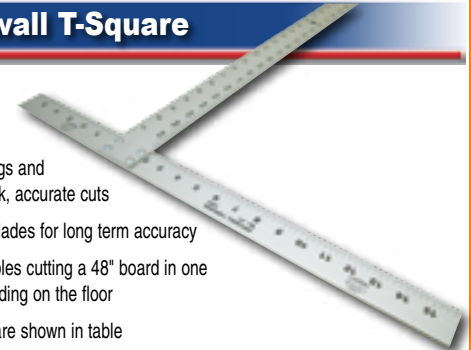

MADE IN U.S.A.

MARSHALLTOWN The Premier Line

| EDI | Part# | Description | Size-in. | Inner/Outer |
|-------|-------|----------------|----------|-------------|
| 16328 | 27 | ⅛" Thick Blade | 47½ X 22 | 1/10 |
| 16333 | 27HD | ⅜" Thick Blade | 47½ X 22 | 2/20 |
| 16327 | HT54 | ¾" Thick Blade | 54 X 22 | 2/10 |

Metric Drywall T-Square

- Silver anodized finish with black epoxy paint numerals for long wear and legibility
- Notched head, reverse rulings and stud markings allow for quick, accurate cuts
- Aircraft-style rivets secure blades for long term accuracy
- Head is notched which enables cutting a 1219mm board in one pass while the board is standing on the floor
- Inner/outer pack quantities are shown in table

MARSHALLTOWN The Premier Line

| EDI | Part# | Description | Size-mm | Inner/Outer |
|-------|-------|-----------------|------------|-------------|
| 16338 | 27XM | 3mm Thick Blade | 1219 X 559 | 2/20 |



Drywall Hammer

- Wedge shaped steel blade is notched for nail pulling
- Properly rounded and checkered head dimples drywall
- Hickory handle is offset to eliminate sore knuckles
- **WARNING:** Always wear safety goggles when using hammers
- Sold 4 per inner pack/24 per outer pack



MARSHALLTOWN The Premier Line

| EDI | Part# | Size-in. | Size-mm | Weight-oz. |
|-------|-------|----------|---------|------------|
| 16380 | 800 | 16 | 406 | 12 |

Drywall T-Square

- Silver anodized finish with black epoxy paint numerals
- Reverse ruled to read from either edge
- Head is notched to permit full length cut
- Stud location marks aid in nailing
- Sold 2 per inner pack/20 per outer pack



QLT BY MARSHALLTOWN

| EDI | Part# | Description | Size-in. |
|-------|-------|------------------|-------------|
| 16118 | TS917 | 1/8" Thick Blade | 47 7/8 X 22 |

Drywall Hammer with Anti-Vibration Handle

- Solid forged steel shaft
- Hachet end has a notch for pulling nails
- Ergonomic anti-vibration handle
- **WARNING:** Always wear safety goggles when using hammers
- Sold 6 per inner pack/36 per outer pack



QLT BY MARSHALLTOWN

| EDI | Part# | Size-in. | Size-mm | Weight-oz. |
|-------|-------|----------|---------|------------|
| 16694 | DH694 | 13 1/2 | 343 | 12 |

Folding Triangle-Square

- Collapses for easy storage
- Carrying bag included
- Square forms one 90° and two 45° angles
- Ruler for English and Metric measurements
- Sold 1 per inner pack/10 per outer pack

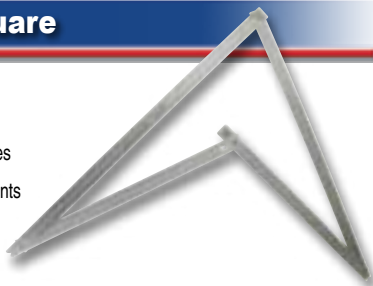

QLT BY MARSHALLTOWN

| EDI | Part# | Size-in. | Size-mm |
|-------|-------|----------|---------|
| 15240 | FTS24 | 24 | 610 |
| 15241 | FTS48 | 48 | 1219 |

Drywall Hammer

- Drop forged head with fully polished milled face
- Wedge shaped steel blade is notched for nail pulling
- Fired hickory handle
- Has a checkered head design to dimple drywall
- **WARNING:** Always wear safety goggles when using hammers
- **New item indicated in red**
- Sold 6 per inner pack/36 per outer pack



NEW SIZE!

QLT BY MARSHALLTOWN

| EDI | Part# | Size-in. | Size-mm | Weight-oz. |
|-------|-------|----------|---------|------------|
| 14570 | DH764 | 13 1/4 | 336 | 12 |
| 18970 | DH886 | 16 | 406 | 12 |

Drywall Hatchet

- Milled crowned face and fully polished head
- Wedge shaped steel blade is notched for nail pulling
- Select flame treated handle
- **WARNING:** Always wear safety goggles when using hammers
- Sold 2 per inner pack/12 per outer pack



MARSHALLTOWN The Premier Line

| EDI | Part# | Size-in. | Size-mm | Weight-oz. |
|-------|-------|----------|---------|------------|
| 14178 | DH178 | 15 1/2 | 394 | 16 |

Rubber Mallet

- 2 lb. black rubber head
- For use with cornerbead tools
- Sturdy wood handle
- Sold 2 per inner pack/12 per outer pack



QLT BY MARSHALLTOWN

| EDI | Part# | Size-in. | Size-mm |
|-------|-------|-----------|----------|
| 16435 | RM435 | 4 X 2 1/2 | 102 X 64 |

Cornerbead Tool

- One blow from a rubber mallet will crimp the cornerbead tightly and accurately in place
- Helps center the cornerbead for best mud distribution
- **WARNING:** Always wear safety goggles when using this tool
- Sold 4 per inner pack/4 per outer pack, 1 per inner pack/6 per outer pack where noted with *



QLT by MARSHALLTOWN

| EDI | Part# | Description | Size-in. | Size-mm |
|-------|---------|---------------------|----------|---------|
| 16433 | CB370 | Tool | 1¼ | 31 |
| 16429 | CB429 * | Tool w/16435 Mallet | N/A | N/A |

Magnetic Stud Finder

- Helps to locate wood or metal studs
- Compact size
- Stronger magnet than the competitors
- Sold 12 per inner pack/120 per outer pack



QLT by MARSHALLTOWN

| EDI | Part# | Size-in. | Size-mm |
|-------|-------|----------|---------|
| 11061 | MSF9 | 2¾ X 1¾ | 73 X 44 |

Drywall Pouch

- Heavy top grain saddle leather
- "U" loop hammer holder, rule pocket and wide tunnel belt loop
- Pouch is riveted at all stress points
- Gusseted sides give shape
- Sold 1 per inner pack/20 per outer pack



MADE IN U.S.A.

MARSHALLTOWN The Premier Line

| EDI | Part# | Size-in. | Size-mm |
|-------|-------|----------|---------|
| 16385 | 805 | N/A | N/A |

Felt Brush

- Used to apply or remove water during finishing
- Two 4 X 9 X ½" (337 X 229 X 13mm) thick white felt pads
- Aluminum channel and stiffener plate
- 8" (203mm) Hardwood handle
- FB865 sold 1 per inner pack/6 per outer pack
- FB865RP sold 1 per inner pack/12 per outer pack

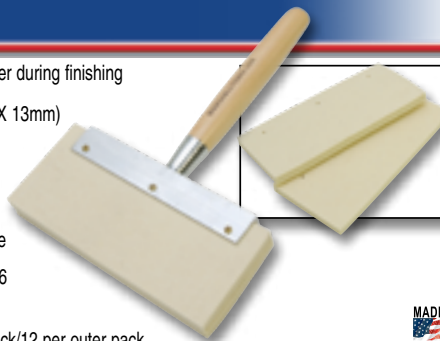

MADE IN U.S.A.

MARSHALLTOWN The Premier Line

| EDI | Part# | Description | Size-in. | Size-mm |
|-------|---------|-------------|----------|-----------|
| 16865 | FB865 | Felt Brush | 13¼ X 9 | 337 X 229 |
| 16866 | FB865RP | Repl. Pad | 4 X 9 | 102 X 229 |

Rubber Floats

- Has a 5/8" (16mm) thick red rubber pad specially bonded to the aluminum backing plate for long wear
- Frequently used by plasterers and other finishers for rough and/or textured finishes
- Available with a fine or coarse pad
- Sold 1 per inner pack/24 per outer pack, 12 per outer pack where noted with *



ASSEMBLED IN U.S.A.

MARSHALLTOWN The Premier Line

| EDI | Part# | Description | Size-in. | Size-mm |
|-------|-------|-------------|----------|-----------|
| 14404 | 38 | Fine | 9 X 4 | 229 X 102 |
| 14414 | 38L * | Fine | 12 X 4 | 305 X 102 |
| 14406 | 39 | Coarse | 9 X 4 | 229 X 102 |

Large Rubber Floats

- ¾" (19mm) thick rubber pad
- Longer and wider than our other rubber floats
- Used frequently by plasterers and other finishers for rough and/or textured finishes
- Available with a fine or coarse pad
- Sold 1 per inner pack/12 per outer pack
- Replacement pads are packed 6 pads per bag, 1 per inner pack/12 per outer pack



ASSEMBLED IN U.S.A.

MARSHALLTOWN The Premier Line

| EDI | Part# | Description | Size-in. | Size-mm |
|-------|-------|------------------|----------|-----------|
| 14413 | 41 | Fine | 11 X 5½ | 279 X 140 |
| 14415 | 42 | Coarse | 11 X 5½ | 279 X 140 |
| 14410 | 4413 | Repl. Pad for 41 | 11 X 5½ | 279 X 140 |
| 14411 | 4415 | Repl. Pad for 42 | 11 X 5½ | 279 X 140 |

Molded Rubber Float

- Molded black rubber pad is very compact and has a dense texture
- Float face is permanently cemented to the lightweight aluminum backing
- The ideal float for bringing sand to the surface
- Sold 1 per inner pack/24 per outer pack

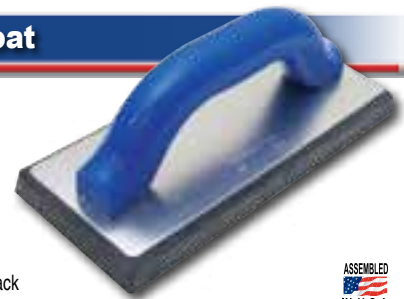

ASSEMBLED IN U.S.A.

MARSHALLTOWN The Premier Line

| EDI | Part# | Size-in. | Size-mm |
|-------|-------|----------|-----------|
| 14408 | 40 | 9 X 4 | 229 X 102 |

Molded Rubber Float

- Molded black rubber pad is very compact and dense
- Thick aluminum backing plate resists bending
- Rubber pad is 5/8" (16mm) thick
- Sold 6 per inner pack/60 per outer pack



QLT by MARSHALLTOWN

| EDI | Part # | Size-in. | Size-mm |
|-------|--------|----------|-----------|
| 10753 | MRF94 | 9 X 4 | 229 X 102 |

Rubber Floats



- Red rubber pad is durable and lightweight
- Has a stiff aluminum backing plate bonded to the pad
- Pad is 5/8" (16mm) thick
- Pads are available in either fine or coarse
- The ideal float for bringing sand to the surface
- Sold 1 per inner pack/24 per outer pack

QLT BY MARSHALLTOWN

| EDI | Part# | Description | Size-in. | Size-mm |
|-------|---------|-------------|----------|-----------|
| 10754 | RRF94C | Coarse | 9 X 4 | 229 X 102 |
| 10755 | RRF94F | Fine | 9 X 4 | 229 X 102 |
| 10756 | RRF124F | Fine | 12 X 4 | 305 X 102 |

Rubber Floats



- Red rubber pad is durable and lightweight
- Has a stiff aluminum backing plate bonded to the pad
- Wood handle
- Rubber pad is fine cell
- The ideal float for bringing sand to the surface
- Sold 1 per inner pack/24 per outer pack

QLT BY MARSHALLTOWN

| EDI | Part# | Size-in. | Size-mm |
|-------|-----------|-----------------|----------------|
| 25595 | RED704428 | 9 1/2 X 4 X 1/2 | 241 X 102 X 13 |
| 25597 | RED704431 | 9 1/2 X 4 X 3/4 | 241 X 102 X 19 |

MADE IN U.S.A.

Neoprene Floats



- Aluminum backing plate is permanently bonded to the non-porous black neoprene pad
- Works well for brown coat, quartz or marble finishes
- Pad is 1/4" (6mm) thick
- Sold 1 per inner pack/12 per outer pack

MARSHALLTOWN The Premier Line

| EDI | Part# | Size-in. | Size-mm |
|-------|-------|----------|-----------|
| 14424 | 49 | 12 X 4 | 305 X 102 |
| 14434 | 49L | 12 X 5 | 305 X 127 |

ASSEMBLED IN U.S.A.

Neoprene Float with Heavier Backing



- Aluminum backing plate is permanently bonded to the white neoprene pad
- Pad is 1/4" (6mm) thick and is the perfect hardness
- Heavier backing plate for extra stiffness
- Sold 1 per inner pack/12 per outer pack

MARSHALLTOWN The Premier Line

| EDI | Part# | Size-in. | Size-mm |
|-------|-------|----------|-----------|
| 14435 | 49XH | 12 X 5 | 305 X 127 |

ASSEMBLED IN U.S.A.

Fine Red Rubber Float



- Fine cell red rubber pad is durable and light weight
- Has a stiff aluminum backing plate bonded to the pad
- Wood handle
- The ideal float for bringing sand to the surface
- Sold 1 per inner pack/6 per outer pack

NEW!

QLT BY MARSHALLTOWN

| EDI | Part# | Description | Size-in. | Size-mm |
|-------|---------|-------------|----------|-----------|
| 18345 | RRFW94F | Fine | 9 X 4 | 229 X 102 |

Plastic Foam Floats

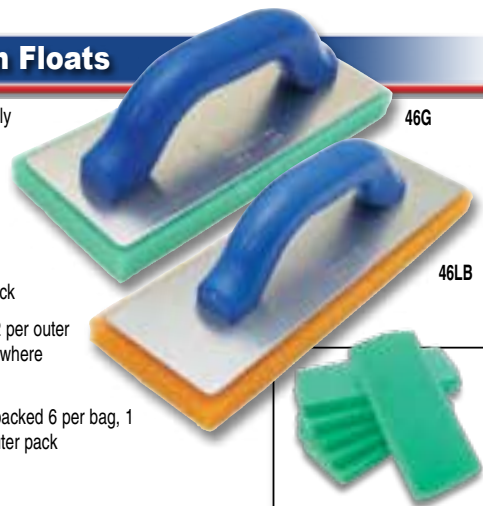

- Plastic foam pad specially bonded to an aluminum backing plate
- Wears well and does an excellent job on any sand surface
- Pads are 3/4" (19mm) thick
- Sold 1 per inner pack/12 per outer pack, 24 per outer pack where noted with *
- Replacement pads are packed 6 per bag, 1 per inner pack/12 per outer pack

46G

46LB

MADE IN U.S.A.

MARSHALLTOWN The Premier Line

| EDI | Part# | Description | Size-in. | Size-mm |
|-------|-------|--------------------|-----------|-----------|
| 14416 | 46G* | Green/Fine | 9 1/2 X 4 | 242 X 102 |
| 14418 | 46LG | Green/Fine | 12 X 4 | 305 X 102 |
| 14432 | 46BG | Green/Fine | 12 X 5 | 305 X 127 |
| 14420 | 46LB | Orange/Coarse | 12 X 4 | 305 X 102 |
| 14417 | 4417 | Repl. Pad for 46G | 9 1/2 X 4 | 242 X 102 |
| 14379 | 4379 | Repl. Pad for 46LG | 12 X 4 | 305 X 102 |
| 14382 | 4382 | Repl. Pad for 46BG | 12 X 5 | 305 X 127 |
| 14384 | 4384 | Repl. Pad for 46LB | 12 X 4 | 305 X 102 |

Green Foam Float



- Plastic foam pad specially bonded to an aluminum backing plate
- Wears well and does an excellent job on any sand surface
- Pads are 3/4" (19mm) thick
- Sold 1 per inner pack/12 per outer

QLT BY MARSHALLTOWN

| EDI | Part# | Description | Size-in. | Size-mm |
|-------|--------|-------------|----------|-----------|
| 18729 | GFF94 | Green/Fine | 9 X 4 | 299 X 102 |
| 11100 | GFF124 | Green/Fine | 12 X 4 | 305 X 102 |

Sponge Float

- Fine cell yellow foam pad specially bonded to an aluminum backing plate
- Wears well and does an excellent job on any sand surface
- Pad is 1 1/8" (28mm) thick
- Sold 1 per inner pack/12 per outer pack
- Replacement pads are packed 6 per bag, 1 per inner pack/12 per outer pack

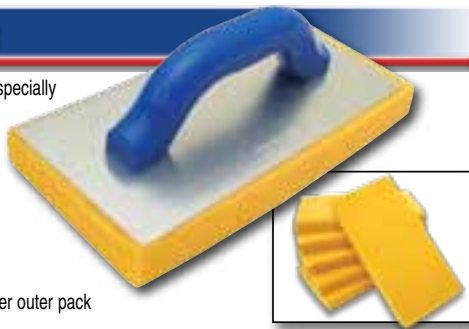

ASSEMBLED
IN U.S.A.

MARSHALLTOWN The Premier Line

| EDI | Part# | Description | Size-in. | Size-mm |
|-------|-------|-------------|------------|-----------|
| 14419 | 4412 | Float | 11 X 5 1/2 | 279 X 140 |
| 14412 | 4419 | Repl. Pad | 11 X 5 1/2 | 279 X 140 |

Cork Float

- Dense cork pad is 1/4" (6mm) thick and bonded to an aluminum backing plate
- This cork is 50% denser than the competitors'
- Commonly used in the plastering trade to smooth and compact the plastered surface
- Sold 1 per inner pack/12 per outer pack



ASSEMBLED
IN U.S.A.

MARSHALLTOWN The Premier Line

| EDI | Part# | Size-in. | Size-mm |
|-------|-------|----------|-----------|
| 14402 | 37 | 12 X 5 | 305 X 127 |

Beige Foam Float

- Plastic foam pad specially bonded to an aluminum backing plate
- Wears well and does an excellent job on any sand surface
- Pads are 3/4" (19mm) thick
- Sold 1 per inner pack/12 per outer



QLTTM BY MARSHALLTOWN

| EDI | Part# | Description | Size-in. | Size-mm |
|-------|--------|--------------|----------|-----------|
| 11099 | BFF124 | Beige/Coarse | 12 X 4 | 305 X 102 |

Acrylic Angle Float

- Made of clear acrylic with no risk of discoloration
- Sides form a perfect 90° angle
- Used in the plastering trade to square-up the inside corners of the base coat
- Can also be used like a trowel for small areas
- Sold 1 per inner pack / 4 per outer pack



MADE IN
U.S.A.

MARSHALLTOWN The Premier Line

| EDI | Part# | Size-in. | Size-mm |
|-------|--------|-----------|----------------|
| 13377 | PAF377 | 4 x 9 x 1 | 102 x 229 x 25 |

Drywall Vacuum Sanders

- Dustless drywall sanding
- Ergonomic DuraSoft® handle designed specifically for vacuum sanding
- 360° pivoting elbow keeps hose out of the way
- Adjustable vent allows for variable vacuum force
- Low profile knobs stay out of the way
- Durable sanding pad for a smooth finish
- Designed for use with standard sanding screen, 1 sheet included in each model
- VS792 includes 6' (1.8M) of hose, coupler and adapter for compatibility with most shop type vacuums
- VS733 includes 12" (305mm) of hose
- VS733 sold 1 per inner pack/12 per outer pack, VS792 sold 1 per inner pack/4 per outer pack



Three Comfortable Sanding Positions

MADE IN
U.S.A.

MARSHALLTOWN The Premier Line

| EDI | Part# | Description | Size-in. | Size-mm |
|-------|-------|-------------------------------|---------------|----------|
| 13733 | VS733 | Vac Sander, 12" hose | 9 1/4 X 3 1/4 | 235 X 82 |
| 13792 | VS792 | Vac Sander, 6' hose, adapters | 9 1/4 X 3 1/4 | 235 X 82 |

Drywall Vacuum Sander

- Adjustable valve control
- Ergonomically designed soft grip handle
- Simple and fast screen changes
- Universal screen sizing fits all standard sized sanding screens
- Sold 1 per inner pack/4 per outer pack



QLTTM BY MARSHALLTOWN

| EDI | Part# | Size-in. | Size-mm |
|-------|-------|-----------|----------|
| 19287 | HVS87 | 9 X 3 1/4 | 229 X 82 |

DuraSoft® Hand Sander

- Lightweight aluminum backing plate bonded to foam pad
- Resilient DuraSoft® handle provides a soft feel and reduces fatigue
- Designed for die-cut or a half sheet of standard sandpaper or sand screen
- Sold 6 per inner pack/6 per outer pack



MADE IN
U.S.A

MARSHALLTOWN The Premier Line

| EDI | Part# | Size-in. | Size-mm |
|-------|-------|---------------|----------|
| 16320 | 20D | 9 1/2 X 3 1/4 | 239 X 82 |

Soft Grip Hand Sander

- Unique quick snap together feature
- Soft grip handle
- Designed for die-cut or a half sheet of standard sandpaper
- Sold 1 per inner pack/6 per outer pack



U.S. Patent No. D525,508

QLT BY MARSHALLTOWN

| EDI | Part# | Size-in. | Size-mm |
|-------|-------|---------------|----------|
| 16097 | HS097 | 9 1/2 X 3 1/4 | 232 X 83 |

Hand Sanders

- Lightweight aluminum backing plate bonded to foam pad
- For use with die-cut or a half sheet of standard sandpaper
- **HS98W** has wood handle designed for knuckle clearance
- **HS98SG** has comfortable soft grip handle
- Sold 1 per inner pack/6 per outer pack

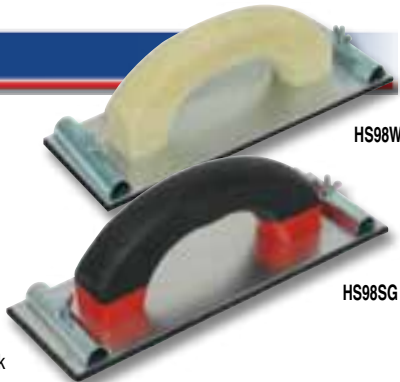

QLT BY MARSHALLTOWN

| EDI | Part# | Size-in. | Size-mm |
|-------|--------|---------------|----------|
| 16098 | HS98W | 9 1/2 X 3 1/4 | 241 X 83 |
| 16099 | HS98SG | 9 1/2 X 3 1/4 | 241 X 83 |

Hand Sander

- Rust resistant backer bonded to a foam rubber pad
- Smooth contour handle
- Exclusive one piece handle clamp design makes for easy use and holds the sandpaper firmly in place
- For use with die-cut or a half sheet of standard sandpaper
- Sold 6 per inner pack/6 per outer pack

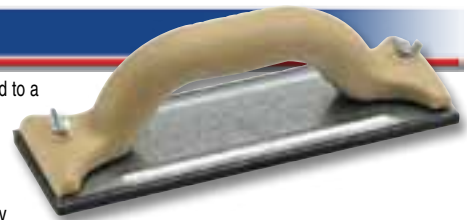

MADE IN
U.S.A

QLT BY MARSHALLTOWN

| EDI | Part# | Size-in. | Size-mm |
|-------|-------|---------------|----------|
| 16101 | HS901 | 9 1/2 X 3 1/4 | 242 X 82 |

Hand Sander

- Made of molded plastic
- A comfortable lightweight tool
- For use with die-cut or a half sheet of standard sandpaper
- Sold 10 per inner pack/60 per outer pack



MADE IN
U.S.A

QLT BY MARSHALLTOWN

| EDI | Part# | Size-in. | Size-mm |
|-------|-------|-----------|----------|
| 16158 | 6158 | 9 X 3 1/4 | 229 X 82 |

Sanding Block

- Semi-flex solid rubber design
- Steel grippers hold standard 1/4 sheet of sandpaper
- Non-marking
- Sold 10 per inner pack/10 per outer pack



QLT BY MARSHALLTOWN

| EDI | Part# | Size-in. | Size-mm |
|-------|-------|---------------|----------|
| 19558 | E40 | 4 3/4 X 3 5/8 | 121 X 68 |

Universal Pole Sander

- Made of reinforced die-cast aluminum
- Unique design keeps the entire pad on your work surface
- Won't flip or bind
- Fast, positive clamps lock securely to hold sandpaper in place
- Used for sanding drywall joints
- Combining this sander with our **28** or **28L** pole sander handle permits sanding anywhere (handle sold separately)
- Sold 12 per inner pack/12 per outer pack



For 28 & 28L see page 181

MARSHALLTOWN The Premier Line

| EDI | Part# | Size-in. | Size-mm |
|-------|-------|---------------|----------|
| 14428 | 26A | 9 1/2 X 3 1/4 | 239 X 82 |

Swivel Pole Sander

- Made of reinforced die-cast aluminum bonded to a foam rubber pad
- Fast positive clamps lock securely to hold sandpaper in place
- Used for sanding drywall joints
- Combining this sander with our **28** or **28L** pole sander handle permits sanding anywhere (handle sold separately)
- Sold 12 per inner pack/12 per outer pack



28 & 28L found on this page, see next column

MARSHALLTOWN The Premier Line

| EDI | Part# | Size-in. | Size-mm |
|-------|-------|----------|----------|
| 14426 | 26 | 9% X 3¼ | 239 X 82 |

Pole Sander

- Made of reinforced die-cast aluminum bonded to a foam rubber pad
- Fast, positive clamps lock securely to hold the sandpaper in place
- Used for sanding drywall joints
- Combining this sander with our **28** or **28L** pole sander handle permits sanding anywhere
- PS660 sold 10 per inner pack/50 per outer pack
- PS660A includes 28 handle, sold 18 per inner pack/18 per outer pack



Included in PS660A

QLT BY MARSHALLTOWN

| EDI | Part# | Description | Size-in. | Size-mm |
|-------|--------|-----------------|----------|----------|
| 14660 | PS660 | Sander Head | 9% X 3¼ | 239 X 82 |
| 14680 | PS660A | Sander w/Handle | 9% X 3¼ | 239 X 82 |

Pole Sander

- Durable and lightweight cast aluminum head
- Rubber pad with wing nut clamps
- Universal joint for work at any angle
- Ideal for wall, floor and ceiling applications
- Sold 12 per inner pack/12 per outer pack



MARSHALLTOWN The Premier Line

| EDI | Part# | Description | Size-in. | Size-mm |
|-------|-------|-------------|----------|----------|
| 19658 | E551 | Sander Head | 9% X 3¼ | 239 X 82 |

Pole Sander

- Made from lightweight injection molded plastic
- Durable and inexpensive
- Can be used with any standard ¾" (19mm) broom handle
- Used for sanding drywall joints
- Sold 10 per inner pack/60 per outer pack



QLT BY MARSHALLTOWN

| EDI | Part# | Size-in. | Size-mm |
|-------|-------|----------|----------|
| 16157 | 6157 | 9 X 3¼ | 229 X 82 |

Wood Pole Sander Handles

- Made from hardwood
- For use with our pole sanders **26** & **26A** (sold separately)
- Hammerhead tip
- Sold 1 per inner pack/12 per outer pack



MADE IN U.S.A.

MARSHALLTOWN The Premier Line

| EDI | Part# | Size-in. | Size-mm |
|-------|-------|----------|-----------|
| 14827 | 28 | 48 X 1 | 1219 X 25 |
| 14829 | 28L | 60 X 1 | 1524 X 25 |

Threaded Wood Handle

- Hardwood construction and metal threads for longer life
- Will fit any brand of pole sander that takes a standard broom thread
- Sold 1 per inner pack/12 per outer pack



MADE IN U.S.A.

MARSHALLTOWN The Premier Line

| EDI | Part# | Size-in. | Size-mm |
|-------|-------|-------------------------------------|-----------|
| 14931 | WH60 | 60 X 1 ⁵ / ₁₆ | 1219 X 25 |

Wood Pole Sander Handles

- Wooden handle
- Will fit any brand of pole sander that takes a standard broom thread
- Sold 12 per inner pack/12 per outer pack



MADE IN U.S.A.

QLT BY MARSHALLTOWN

| EDI | Part# | Size-in. | Size-mm |
|-------|---------|-------------------------------------|-----------|
| 14543 | PSH753 | 48 X 1 ⁵ / ₁₆ | 1219 X 24 |
| 14544 | PSH753L | 60 X 1 ⁵ / ₁₆ | 1524 X 24 |

Plastic Coated Pole Sander Handle

- Plastic coated aluminum handle
- Will fit any brand of pole sander that takes a standard broom thread
- **WARNING:** Avoid contact with electrical power lines or any electrical source
- Sold 6 per inner pack/6 per outer pack



MADE IN
U.S.A

QLT by MARSHALLTOWN

| EDI | Part# | Size-in. | Size-mm |
|-------|-------|----------|-----------|
| 19657 | E550 | 48 X 1 | 1219 X 25 |

Adjustable Poles

- Fiberglass outer tube
- Aluminum inner tube with broom threaded end
- **FP832** has three sections
- **WARNING:** Avoid contact with electrical power lines or any electrical source
- Sold 1 per inner pack/6 per outer pack



MADE IN
U.S.A

MARSHALLTOWN The Premier Line

| EDI | Part# | Size-in. | Size-mm | Diameter |
|-------|-------|----------|-----------|----------|
| 14830 | FP48 | 51-96 | 1295-2438 | 1¼ X 31 |
| 14831 | FP612 | 75-144 | 1905-3658 | 1¼ X 31 |
| 14832 | FP832 | 78-213 | 1981-5401 | 1¼ X 31 |

Sanding Pole Adapter

- Connects wood handle to a standard sander head
- Made of aluminum
- Sold 12 per inner pack/144 per outer pack



QLT by MARSHALLTOWN

| EDI | Part# | Size-in. | Size-mm |
|-------|-------|----------|---------|
| 14429 | 14429 | N/A | N/A |

Sandscreen

- Has an open weave that provides the versatility to use in wet or dry applications
- Lasts six to eight times longer than sandpaper
- Will fit all **MARSHALLTOWN** sanders and similar sanders
- Packed in boxes of 25 sheets
- Sold 1 box per inner pack/10 boxes per outer pack

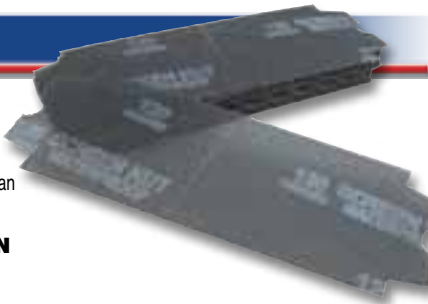

MADE IN
U.S.A

MARSHALLTOWN The Premier Line

| EDI | Part# | Description | Size-in. | Size-mm |
|-------|-------|-------------|----------|-----------|
| 16592 | 816 | 120 Grit | 11¼ X 4¾ | 279 X 107 |
| 16593 | 817 | 220 Grit | 11¼ X 4¾ | 279 X 107 |

Sandscreen

- Can be used wet or dry
- Will outlast regular sandpaper six to one
- Will fit all **MARSHALLTOWN** sanders and similar sanders
- Packed in bags of 5 sheets
- 918 sold 1 bag per inner pack/25 bags per outer pack, 935 sold 1 bag per inner pack/100 bags per outer pack

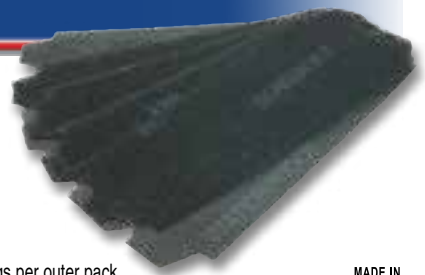

MADE IN
U.S.A

MARSHALLTOWN The Premier Line

| EDI | Part# | Description | Size-in. | Size-mm |
|-------|-------|-------------|----------|-----------|
| 16119 | 918 | 120 Grit | 11¼ X 4¾ | 285 X 107 |
| 16174 | 935 | 220 Grit | 11¼ X 4¾ | 285 X 107 |

Die-Cut Sandpaper

- Will fit all **MARSHALLTOWN** sanders and similar sanders
- Packed in boxes of 100 sheets
- Sold 1 box per inner pack/10 boxes per outer pack



MADE IN
U.S.A

MARSHALLTOWN The Premier Line

| EDI | Part# | Description | Size-in. | Size-mm |
|-------|-------|-------------|----------|-----------|
| 16589 | 809 | 80 Grit | 11¼ X 4¾ | 285 X 107 |
| 16590 | 811 | 100 Grit | 11¼ X 4¾ | 285 X 107 |
| 16591 | 815 | 150 Grit | 11¼ X 4¾ | 285 X 107 |

Die-Cut Sandpaper

- Will fit all **MARSHALLTOWN** sanders and similar sanders
- Packed in bags of 10 sheets
- Sold 1 bag per inner pack/100 bags per outer pack



MADE IN
U.S.A

MARSHALLTOWN The Premier Line

| EDI | Part# | Description | Size-in. | Size-mm |
|-------|-------|-------------|----------|-----------|
| 16116 | 916 | 80 Grit | 11¼ X 4¾ | 285 X 107 |
| 16121 | 919 | 100 Grit | 11¼ X 4¾ | 285 X 107 |
| 16176 | 936 | 150 Grit | 11¼ X 4¾ | 285 X 107 |

Contour Sanding Pads

- Use wet or dry
- Can be used on wood, drywall and metal surfaces
- Contour pads are very flexible and great for sanding round objects
- Sold 100 per inner pack/100 per outer pack

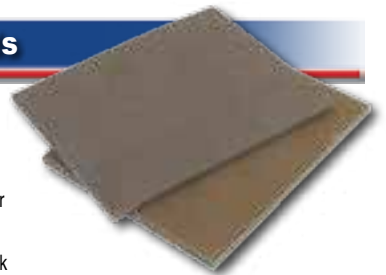

MARSHALLTOWN The Premier Line

| EDI | Part# | Description | L x W x H-in. | L x W x H-mm |
|-------|---------|-------------|---------------|---------------|
| 10494 | CSP494F | Fine | 5½ X 4½ X ½ | 140 X 114 X 5 |
| 10495 | CSP494M | Medium | 5½ X 4½ X ½ | 140 X 114 X 5 |

Sanding Sponge Pads

- Conforms to substrate, directing more pressure to high spots and less pressure to surrounding flat surface - reducing over sanding
- Sponge allows for a smoother finish when using a heavier grit
- Works with existing sander heads and attachment systems
- Wing design sands both sides of inside corners in a single motion
- Can be used with water for wet sanding
- Intended to sand many surfaces including drywall compound, texture, wood, and paint prep work
- 5 pads per bag, Sold 1 bag per inner pack/12 bags per outer pack

**OUTLASTS
SANDPAPER &
SAND SCREEN
6-10X**

MADE IN
U.S.A.

U.S. Patent No. 7,497,765

QLT BY MARSHALLTOWN

| EDI | Part# | Description | Size |
|-------|--------|----------------|------------------|
| 10496 | SP496F | Fine 100 grit | 12 3/8 X 4 3/16" |
| 10497 | SP496M | Medium 60 grit | 12 3/8 X 4 3/16" |

Sanding Sponges

- Several grits available
- Use wet or dry
- Can be used on wood, drywall and metal surfaces
- Can be rinsed and reused
- Angled sponges are great for sanding one side of a corner without scratching the other side
- Sold 24 per inner pack/24 per outer pack, Extra large sponges sold 20 per inner pack/20 per outer pack



MARSHALLTOWN The Premier Line

| EDI | Part# | Description | L x W x H-in. | L x W x H-mm |
|-------|---------|------------------------|-------------------|---------------|
| 10483 | SB483F | Sml. fine | 3 3/4 X 2 5/8 X 1 | 95 X 67 X 25 |
| 10484 | SB483MF | Sml. med./fine | 3 3/4 X 2 5/8 X 1 | 95 X 67 X 25 |
| 10485 | SB483C | Sml. coarse | 3 3/4 X 2 5/8 X 1 | 95 X 67 X 25 |
| 10486 | SB486F | Sngl. angle fine | 4 7/8 X 2 7/8 X 1 | 127 X 73 X 25 |
| 10487 | SB486M | Sngl. angle med. | 4 7/8 X 2 7/8 X 1 | 127 X 73 X 25 |
| 10488 | SB488MF | Dual angle med./fine | 4 7/8 X 2 7/8 X 1 | 127 X 73 X 25 |
| 10489 | SB488MC | Dual angle med./coarse | 4 7/8 X 2 7/8 X 1 | 127 X 73 X 25 |
| 10490 | SB490MF | XL med./fine | 9 X 3 5/16 X 1 | 229 X 84 X 25 |
| 10491 | SB491F | LG fine | 4 7/8 X 2 7/8 X 1 | 127 X 73 X 25 |
| 10492 | SB491MF | LG med./fine | 4 7/8 X 2 7/8 X 1 | 127 X 73 X 25 |
| 10493 | SB491MC | LG med./coarse | 4 7/8 X 2 7/8 X 1 | 127 X 73 X 25 |

Drywall Sanding Sponge

- Abrasive side for wet sanding; sponge side for removing residue
- Recommended by compound manufacturers
- Virtually dustless drywall sanding
- Cleans easily, reusable
- Individual sponge dimensions are: 9L X 4 1/2W X 1 3/4H" (229L X 115W X 44H mm)
- DWS467 display contains 144 sponges per inner/144 outer pack; DWS467-3 contains 48 sponges per inner/48 outer pack



QLT BY MARSHALLTOWN

| EDI | Part# | Description | L x W x H-in. | L x W x H-mm |
|-------|----------|----------------|--------------------------|------------------|
| 16467 | DWS467 | Display of 144 | 18 1/2 X 18 1/2 X 48 | 470 X 470 X 1219 |
| 16468 | DWS467-3 | Display of 48 | 12 1/2 X 22 1/2 X 13 1/2 | 318 X 572 X 343 |

Dust Mask

- Lightweight, disposable paper filter mask
- Easily wear glasses or safety goggles
- Low profile for clear vision
- Uses include: working with fiberglass and cement, sanding drywall, plaster and wood walls, cleaning dusty areas, gardening and mowing
- **WARNING:** Not for use in paint spray operation
- Come 50 per box
- Sold 1 box per inner pack/20 boxes per outer pack



QLT BY MARSHALLTOWN

| EDI | Part# | Size-in. | Size-mm |
|-------|-------|----------|---------|
| 16585 | 16585 | N/A | N/A |

Scratcher Trowels

- High grade spring steel blade with aluminum alloy mounting
- Blade is notched on three sides: 1/2 X 1 5/32" (13 X 12mm) "V"
- Resilient DuraSoft® handle provides a soft feel and reduces fatigue
- Sold 4 per inner pack/4 per outer pack

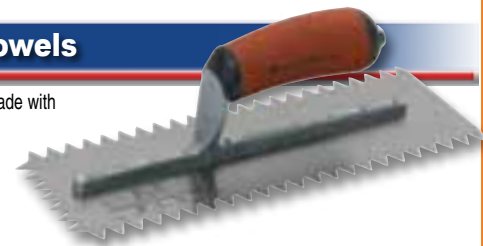

MADE IN
U.S.A.

U.S. Patent No. 5,522,111

MARSHALLTOWN The Premier Line

| EDI | Part# | Size-in. | Size-mm |
|-------|-------|------------|-----------|
| 15742 | 715SD | 12 X 4 1/2 | 305 X 114 |
| 15650 | 714SD | 16 X 4 1/2 | 406 X 114 |

Scarifiers

- Made of lightweight yet sturdy, flexible blue or stainless steel
- Comfortable handle is attached to a non-corrosive aluminum backer plate
- 1/4" (6mm) wide, 3" (76mm) long tines will easily scratch the plaster undercoat to promote a good bond with the finish coat
- Sold 6 per inner pack/6 per outer pack



QLT BY MARSHALLTOWN

MADE IN U.S.A.

| EDI | Part# | Description | Size-in. | Size-mm |
|-------|-------|-----------------|----------|---------|
| 15701 | 721 | Blue Steel | 6 | 152 |
| 15211 | 721SS | Stainless Steel | 6 | 152 |
| 15740 | 722 | Blue Steel | 8 | 203 |
| 15741 | 723 | Blue Steel | 12 | 305 |

Wall Repair Patch Kit

- No-rust aluminum plate provides rigid backing
- Self-adhesive patches
- Fiberglass mesh eliminates the need to pre-plaster
- Inner pack and outer pack quantities are shown in table



MADE IN U.S.A.

MARSHALLTOWN The Premier Line

| EDI | Part# | Size-in. | Size-mm | Inner/Outer |
|-------|-------|----------|-----------|-------------|
| 16301 | DP4 | 4 X 4 | 102 X 102 | 24/24 |
| 16302 | DP6 | 6 X 6 | 152 X 152 | 12/360 |
| 16303 | DP8 | 8 X 8 | 203 X 203 | 12/240 |

Ornamental Tools

- Perfectly forged and tempered
- Available with trowel and square end, or leaf and square end
- Used in the detailing of ornate foam shapes and unusual wall surfaces
- Also ideal for plaster work and drywall work in small areas
- Sold 12 per inner pack/120 per outer pack

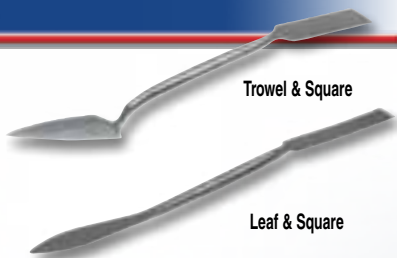

QLT BY MARSHALLTOWN

| EDI | Part# | Description | Size-in. | Size-mm |
|-------|-------|-----------------|--------------|----------|
| 13080 | TS080 | Trowel & Square | 3/8 X 8 1/2 | 10 X 216 |
| 13081 | TS081 | Trowel & Square | 1/2 X 9 1/2 | 13 X 241 |
| 13082 | TS082 | Trowel & Square | 5/8 X 10 1/2 | 16 X 267 |
| 13083 | TS083 | Trowel & Square | 3/4 X 10 1/2 | 19 X 267 |
| 13084 | TS084 | Trowel & Square | 1 X 10 1/2 | 25 X 267 |
| 13085 | LS085 | Leaf & Square | 3/8 X 8 1/2 | 10 X 216 |
| 13086 | LS086 | Leaf & Square | 1/2 X 8 1/2 | 13 X 216 |
| 13087 | LS087 | Leaf & Square | 5/8 X 8 1/2 | 16 X 216 |
| 13088 | LS088 | Leaf & Square | 3/4 X 8 1/2 | 19 X 216 |



Magnesium Plaster Darbies

- Available in double knob and keyhole shaped handles
- All lengths and handle configurations available in plain, single serrated and double serrated blades
- Dual raised edges increase the overall strength and durability
- Magnesium alloy is lightweight and long wearing
- Sold 2 per inner pack/2 per outer pack

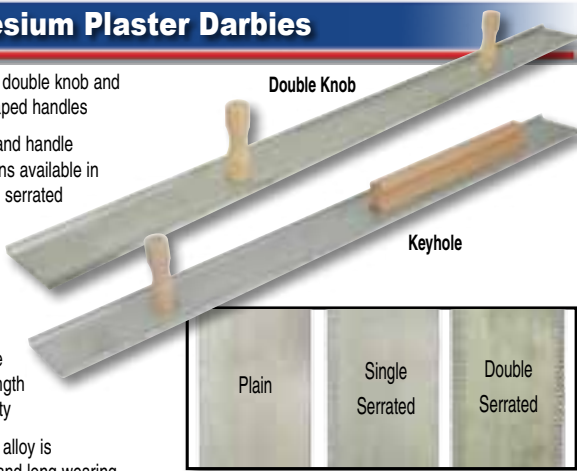

MADE IN U.S.A

MARSHALLTOWN The Premier Line

| EDI | Part# | Description | Size-in. | Size-mm | Handle |
|-------|-------|-----------------|----------|---------|---------|
| 14877 | 14877 | Plain | 42 | 1067 | Keyhole |
| 14876 | 14876 | Single Serrated | 42 | 1067 | Keyhole |
| 14875 | 14875 | Double Serrated | 42 | 1067 | Keyhole |
| 14883 | 14883 | Plain | 42 | 1067 | Double |
| 14882 | 14882 | Single Serrated | 42 | 1067 | Double |
| 14881 | 14881 | Double Serrated | 42 | 1067 | Double |
| 14880 | 14880 | Plain | 48 | 1219 | Keyhole |
| 14879 | 14879 | Single Serrated | 48 | 1219 | Keyhole |
| 14878 | 14878 | Double Serrated | 48 | 1219 | Keyhole |
| 14886 | 14886 | Plain | 48 | 1219 | Double |
| 14885 | 14885 | Single Serrated | 48 | 1219 | Double |
| 14884 | 14884 | Double Serrated | 48 | 1219 | Double |

Sacramento Go Devils

- Made of lightweight and long wearing magnesium alloy or aluminum
- Used for spreading stucco, plaster and EIFS
- Magnesium sold 4 per inner pack/4 per outer pack
- Aluminum sold 6 per inner pack/6 per outer pack



MADE IN U.S.A

MARSHALLTOWN The Premier Line

| EDI | Part# | Description | Size-in. | Size-mm |
|-------|-------|-------------|----------|-----------|
| 13725 | 13725 | Magnesium | 22 X 8 | 559 X 203 |
| 13727 | 13727 | Aluminum | 22 X 8 | 559 X 203 |
| 13726 | 13726 | Aluminum | 22 X 10 | 559 X 254 |

High Strength Screeds

- 3 lengths to choose from
- For sizes and details **see page 95**

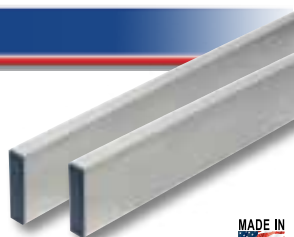

MADE IN U.S.A

Wedge-Shaped Magnesium Darbies

- Magnesium alloy is lightweight and long wearing
- Used in the plastering trade to smooth and compact the plastered surface, much like a featheredge
- Preferred by some plasterers because it can be used to effectively cut off the higher points of the surface
- Sold 2 per inner pack/2 per outer pack



MADE IN U.S.A

MARSHALLTOWN The Premier Line

| EDI | Part# | Size-in. | Size-mm |
|-------|-------|--------------|----------------|
| 15760 | 5760 | 36 X 5 X 1/4 | 914 X 127 X 6 |
| 15762 | 5762 | 48 X 5 X 1/4 | 1219 X 127 X 6 |

Magnesium Slicker

- Magnesium alloy is lightweight and long wearing
- Has a bent edge that makes the slicker more rigid than a wedge-shaped darby, yet more flexible than a featheredge
- Used to plane the brown coat and square up the inside corner angles
- Sold 2 per inner pack/2 per outer pack



MADE IN U.S.A

MARSHALLTOWN The Premier Line

| EDI | Part# | Size-in. | Size-mm |
|-------|-------|------------|------------|
| 15764 | 5764 | 42 X 4 3/4 | 1067 X 121 |

Magnesium Featheredges

- Magnesium alloy is lightweight and long wearing
- Extrusion shape allows for comfortable finger grip
- Tool pitch is controlled with thumb and palm
- Used in the plastering trade to plane the brown coat and square up the inside corner angles
- Sold 2 per inner pack/2 per outer pack
- Items 10' (3M) and longer ship LTL



MADE IN U.S.A

MARSHALLTOWN The Premier Line

| EDI | Part# | Size-standard | Size-metric |
|-------|-------|---------------|--------------|
| 15754 | 5754 | 4' X 4 1/2" | 1.2M X 115mm |
| 15756 | 5756 | 6' X 4 1/2" | 1.8M X 115mm |
| 15758 | 5758 | 8' X 4 1/2" | 2.4M X 115mm |
| 15755 | 5755 | 10' X 4 1/2" | 3M X 115mm |
| 15759 | 5759 | 12' X 4 1/2" | 3.6M X 115mm |

Knockdown Knives

- Blades made of GE Lexan®
- Threaded DuraSoft® handle with metal ferrule and hanging hole
- Drying time reduced when used for texturing
- Sold 6 per inner pack/6 per outer pack



MARSHALLTOWN The Premier Line

| EDI | Part# | Size-in. | Size-mm |
|-------|-------|----------|---------|
| 14395 | KD12 | 12 | 305 |
| 14396 | KD18 | 18 | 457 |
| 14397 | KD24 | 24 | 610 |
| 14398 | KD36 | 36 | 914 |

Adjustable Squeegee Trowels

- Adjust the pitch 35° in either direction for ceilings and tight corners
- Threaded DuraSoft® handle with metal ferrule and hanging hole
- DuraSoft® blade molded to a high impact backing ensures consistent finishes and long life
- Sold 1 per inner pack/6 per outer pack



MARSHALLTOWN The Premier Line

| EDI | Part# | Size-in. | Size-mm |
|-------|-------|----------|---------|
| 14475 | AKD12 | 12 | 305 |
| 14476 | AKD14 | 14 | 356 |
| 14477 | AKD18 | 18 | 457 |
| 14478 | AKD22 | 22 | 559 |

Adjustable Squeegee Trowel Replacement Blades

- Allows different blade sizes to be used on one handle
- DuraSoft® blade molded to a high impact backing
- Tightening knob and blade cover included
- Sold 1 per inner pack/6 per outer pack



MARSHALLTOWN The Premier Line

| EDI | Part# | Size-in. | Size-mm |
|-------|---------|----------|---------|
| 14895 | AKD12RB | 12 | 305 |
| 14896 | AKD14RB | 14 | 356 |
| 14897 | AKD18RB | 18 | 457 |
| 14898 | AKD22RB | 22 | 559 |

Curved Blade Knockdown Knife

- Curved blade and handle pitch is ideal for knockdown finishes
- Threaded DuraSoft® handle with metal ferrule and hanging hole
- Durable 18" (457mm) plastic handle for hard to reach areas
- Sold 6 per inner pack/6 per outer pack



MARSHALLTOWN The Premier Line

| EDI | Part# | Size-in. | Size-mm | Handle |
|-------|--------|----------|---------|--------|
| 16036 | KD18C | 18 | 457 | |
| 16037 | KD18CD | 18 | 457 | |
| 16038 | KD24C | 24 | 609 | |
| 16039 | KD24CD | 24 | 609 | |

Crows Foot Texture Brushes

- Made of white Tampico fibers set in clear lacquered hardwood block
- Has a threaded hole for use with any standard broom handle
- 846 sold 1 per inner pack/6 per outer pack, 844 sold 1 per inner pack/12 per outer pack

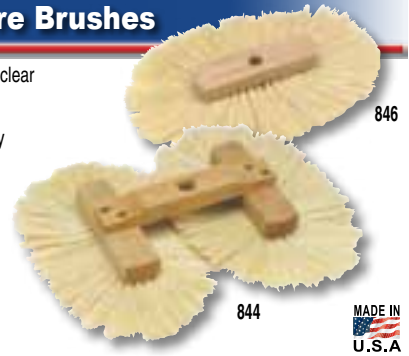

MARSHALLTOWN The Premier Line

| EDI | Part# | Description | Size-in. | Size-mm |
|-------|-------|-------------|----------|-----------|
| 16354 | 846 | Single | 13 X 9 | 330 X 229 |
| 16344 | 844 | Double | 14 X 16½ | 356 X 419 |

Single Texture Brushes

- Slightly flared bristles of black horsehair and polypropylene
- Block with molded hand grip
- Threaded center and side hole, also a tapered side hole
- Ideal for stippled, swirled or sponged effects with plaster or paint
- 832 sold 1 per inner pack/12 per outer pack, 849 sold 1 per inner pack/6 per outer pack



MARSHALLTOWN The Premier Line

| EDI | Part# | Bristle Size | Dia.-in. | Dia.-mm |
|-------|-------|--------------|----------|---------|
| 16332 | 832 | 3½" (89mm) | 5 | 127 |
| 16348 | 849 | 2½" (64mm) | 4¾ | 121 |

The ENFORCER™ Portable Texture Sprayer

- One air hose from any compressor does all the work for both pressurized tank and hopper gun
- 2.5-gallon capacity
- Up to 1.75 gpm flow rate
- Piston seal cleans the inner tank wall for less mess
- Empty weight of unit - 15 lbs.
- Full weight of unit - 45 lbs.
- 15 psi. max. air in tank no matter what compressor is set at for hopper gun
- Quick-Release top cap with pressure release pin easily removes for cleaning and filling
- Refill using a mud pump for maximum efficiency
- Sprays knockdown, popcorn, orange peel and splatter textures
- Minimum compressor requirement is 5.0 CFM at 40 psi.
- E400C for international customers only
- Sold 1 per inner pack/1 per outer pack



U.S. Patent No. 7,997,511



OTHERS



Lightweight



Heavy

Weight



Clean



Messy

Cleanliness



Quick & Easy



Awkward & Difficult

Filling

Portable Like a Hopper... Professional Like a Rig!

MARSHALLTOWN The Premier Line

| EDI | Part# | Description |
|-------|--------|---|
| 10400 | E400 | ENFORCER™ |
| 10460 | E400C | ENFORCER™ w/ international conversion coupler |
| 10145 | E400NB | ENFORCER™ w/o backpack |

The ENFORCER™ Replacement Parts

- Prior to each use of the ENFORCER™ check all connections and check for worn parts
- Use only official ENFORCER™ replacement parts for maximum product life



MARSHALLTOWN The Premier Line

| EDI | Part# | Description | Inner/Outer |
|-------|-------|-----------------------------|-------------|
| 10146 | 10146 | Bottom Cap | 1/1 |
| 10401 | 10401 | Backpack Assembly | 1/1 |
| 10402 | 10402 | Piston Assembly | 1/1 |
| 10403 | 10403 | Top Cap Assembly | 1/1 |
| 10404 | 10404 | Pneumatic Assembly | 1/1 |
| 10406 | 10406 | Mud Hose Kit | 1/1 |
| 10407 | 10407 | Filling Hose Kit | 1/1 |
| 10408 | 10408 | Top Cap Bolt Set (set of 4) | 4/1 |
| 10409 | 10409 | Mud Hose Barbed Fitting | 1/1 |
| 10410 | 10410 | Total Hose Kit | 1/1 |
| 10411 | 10411 | Repl. Backpack Tank Straps | 1/1 |
| 10412 | 10412 | Sharpshooter 2.0 Repl. Plug | 1/1 |
| 10413 | 10413 | Seal Kit | 1/1 |
| 10415 | 10415 | Replacement Caps (2) | 2/1 |

30" Open Tote

- Holds up to 80 lbs. (36 kgs)
- Sturdy polyester and aluminum construction
- Adjustable shoulder strap
- Inner and outer pockets to hold all of your **MARSHALLTOWN** tools*
- Works great with our ENFORCER™
- Sold 1 per inner pack/1 per outer pack



*Tools not included



MARSHALLTOWN The Premier Line

| EDI | Part# | Size-in. | Size-mm |
|-------|--------|----------|---------|
| 10388 | TOTE30 | 30 | 762 |

To order: Phone: 800-888-0127 • Fax: 800-477-6341 • Visit our Website at www.MARSHALLTOWN.com

DRYWALL - PLASTERING - PAINT SUNDRY - WALLCOVERING TOOLS

DuoFlex® Dual Function Air Compressor

- Oil-less, direct drive pump
- Single stage
- Two air outlets; 1 for air tools, 1 for hopper guns
- 2 hp, 14.2 amp (115V)
- Capacitor start and capacitor run motor for long life
- 50' (15.24M) air hose included with HC127A, HC128A, HC129A & HC130A
- 1000 hour pump life
- Air delivery: Minimum 8.3 cfm @ 40 psi
Minimum 6.1 cfm @ 90 psi
- UL and CSA approved
- One year warranty
- Compressor with gun weighs 72 lbs.
- Sold 1 per inner pack/1 per outer pack



HC125A



See Video

DuoFlex® Air Compressor available alone or with any of these Hopper Guns



HC130A



HC128A



HC127A



HC129A

Compressor hose and coupling set:

- For DuoFlex® air compressor
- Includes one 50' X 3/8" (15.24M X 10mm) i.d. hose and one coupling set
- Sold 1 per inner pack/4 per outer pack



HOS308

MADE IN U.S.A.

MARSHALLTOWN The Premier Line

| EDI | Part# | Description |
|-------|--------|---------------------------------|
| 10341 | HC130A | Compressor w/SS20 |
| 16377 | HC128A | Compressor w/693 |
| 16378 | HC127A | Compressor w/HG692 |
| 16034 | HC129A | Compressor w/HG577 |
| 16369 | HC125A | Compressor Only |
| 16308 | HOS308 | 50' (15.24M) Air Hose & Coupler |

Compressor Air Filter Kit

- For DuoFlex® air compressor
- Four filters per bag
- Sold 1 per inner pack/10 per outer pack



MADE IN U.S.A.

MARSHALLTOWN The Premier Line

| EDI | Part# | Size-in. | Size-mm |
|-------|--------|----------|---------|
| 16309 | FIL309 | N/A | N/A |

Compressor Hinge Repair Kit

- For DuoFlex® air compressor
- Includes two hinges, one bolt w/washer, two lockwasher nuts, one knob clamp and two machine screws
- Sold 1 per inner pack/6 per outer pack

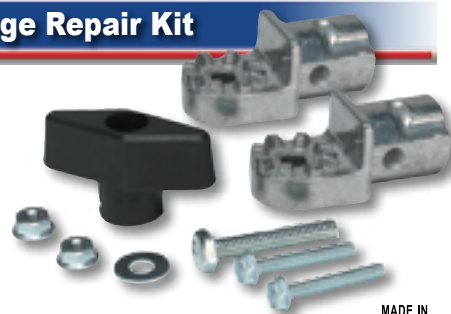

MADE IN U.S.A.

MARSHALLTOWN The Premier Line

| EDI | Part# | Size-in. | Size-mm |
|-------|--------|----------|---------|
| 16307 | HNG307 | N/A | N/A |

Compressor Piston Repair Kit

- For DuoFlex® air compressor
- Kits include a cylinder, piston, cylinder o-ring and a head o-ring
- Sold 1 per inner pack/6 per outer pack



MADE IN U.S.A.

MARSHALLTOWN The Premier Line

| EDI | Part# | Size-in. | Size-mm |
|-------|-------|----------|---------|
| 16299 | PC299 | N/A | N/A |

Compressor Relief Valve Kit

- For DuoFlex® air compressor
- Sold 1 per inner pack/6 per outer pack



MADE IN U.S.A.

MARSHALLTOWN The Premier Line

| EDI | Part# | Size-in. | Size-mm |
|-------|-------|----------|---------|
| 16569 | RV569 | N/A | N/A |

SharpShooter® 2.0

- New adjustment knob allows a full trigger pull at any spray setting
- Tick marks located on both sides of gun to indicate knob setting
- Spring plunger under orifice plate indicates when orifice is centered over nozzle
- Sold 1 per inner pack/1 per outer pack

SHARPSHOOTER 2.0

Drywall Hopper Gun

SHARPSHOOTER 2.0

Drywall Hopper Gun



Trigger flow control



Trigger lock



Soft grip handle and trigger



ENFORCER™ compatible



45° Angle Adapter Included



New Hopper Design!



See Video

For Spraying Acoustics, Drywall Mud, Silica Sand with Primer, Waterproofing, Concrete Overlays, and Most Other Gravity Fed Materials



MARSHALLTOWN The Premier Line

| EDI | Part# | Description | Size-in. | Size-mm |
|-------|-------|-------------|----------|---------|
| 10338 | SS20 | Hopper Gun | N/A | N/A |
| 16359 | 797 | Hopper Only | N/A | N/A |
| 10339 | SS20G | Gun Only | N/A | N/A |

To order: Phone: 800-888-0127 • Fax: 800-477-6341 • Visit our Website at www.MARSHALLTOWN.com

DRYWALL - PLASTERING - PAINT SUNDRY - WALLCOVERING TOOLS

SharpShooter® I Hopper Gun

- Specially formulated nylon gun
- Seven orifice sizes with tubular design for reduced overspray and greater texture variety
- Knurled knobs let you adjust the orifice plate without wrenches
- Tight sealing flow shutoff prevents leakage
- Angled hopper adapter allows hopper to remain level while spraying floors and ceilings
- Gun features a handy air control valve which allows flow control at the gun instead of at the pump
- Easy pull swing trigger for greater control and less fatigue
- Adjustable trigger stop for consistency of pattern
- Hopper with seamless corner design eliminates material build-up and reduces clogging
- Plastic hopper capacity is approximately 2 gallons (7.57 liters)
- Sold 1 per inner pack/1 per outer pack



MADE IN U.S.A.

MARSHALLTOWN The Premier Line

| EDI | Part# | Description | Size-in. | Size-mm |
|-------|-------|-------------|----------|---------|
| 16356 | 693 | Hopper Gun | N/A | N/A |
| 16359 | 797 | Hopper Only | N/A | N/A |
| 16373 | G695 | Gun Only | N/A | N/A |

SprayMate™ Hopper Gun

- High impact, thermoplastic gun housing
- Nine orifice sizes that create the most popular texture patterns
- Knurled knobs let you adjust the orifice plate without wrenches
- Gun features a handy air control valve which allows flow control at the gun instead of at the pump
- All metal internal parts of exceptional quality
- Hopper cover provides the ability to keep material from falling out of the hopper and will slow down the drying process of drywall mud when not in use
- Lid can be placed in front or back orientation which allows for spraying ceilings or floors
- Plastic hopper capacity is approximately 2 gallons (7.57 liters)
- Sold 1 per inner pack/1 per outer pack



Two piece hopper lid included

MADE IN U.S.A.

QLT-MARSHALLTOWN

| EDI | Part# | Description | Size-in. | Size-mm |
|-------|-------|-------------|----------|---------|
| 14582 | HG692 | Hopper Gun | N/A | N/A |
| 14585 | H724 | Hopper Only | N/A | N/A |
| 14586 | G725 | Gun Only | N/A | N/A |

QuickShooter™ Hopper Gun

- Durable plastic hopper with handle
- Three air nozzle sizes
- Rugged die-cast aluminum gun body
- Adjustable material control
- Easy squeeze trigger with lock
- Air flow regulator valve with quick connector
- Hopper cover provides the ability to keep material from falling out of the hopper and will slow down the drying process of drywall mud when not in use
- Sold 1 per inner pack/4 per outer pack, G578 sold 1 per inner pack/1 per outer pack



QLT-MARSHALLTOWN

| EDI | Part# | Description | Size-in. | Size-mm |
|-------|-------|-------------|----------|---------|
| 14577 | HG577 | Hopper Gun | N/A | N/A |
| 14608 | H608 | Hopper Only | N/A | N/A |
| 14578 | G578 | Gun Only | N/A | N/A |

Hopper Gun Cleaning Kit

- Can be used to clean any hopper gun
- Contains: (size is length of brush and handle)
 - 1-6" (152mm) brass brush
 - 1-6⁷/₈" (175mm) brass brush
 - 1-7" (178mm) nylon brush
 - 1-3⁷/₈" (98mm) precision twisted mini brush
- Sold 6 per inner pack/6 per outer pack



QLT-MARSHALLTOWN

| EDI | Part# | Size-in. | Size-mm |
|-------|-------|----------|---------|
| 14285 | 14285 | N/A | N/A |

Hopper Gun Stand

- Stabilizes hopper gun when on a solid surface
- One person easy loading
- Made of zinc plated steel rod
- Sold 1 per inner pack/6 per outer pack



QLT-MARSHALLTOWN

| EDI | Part# | Size-in. | Size-mm |
|-------|-------|----------|---------|
| 16634 | HS634 | N/A | N/A |

45° Angled Hopper Adapter

- Allows hopper to remain level while spraying floors and ceilings
- Offers 90° of spraying mobility
- For use with our 693 SharpShooter® I, SS20 SharpShooter® 2.0 and HG692 SprayMate®
- Sold 1 per inner pack/12 per outer pack



QLT BY MARSHALLTOWN

| EDI | Part# | Size-in. | Size-mm |
|-------|-------|----------|---------|
| 16229 | RK299 | N/A | N/A |

Hopper Flex Connector

- Allows hopper to remain level while spraying floors and ceilings
- Flexible spraying mobility
- For use with our 693 SharpShooter® I, SS20 SharpShooter® 2.0 and HG692 SprayMate®
- Sold 1 per inner pack/6 per outer pack



MARSHALLTOWN The Premier Line

| EDI | Part# | Size-in. | Size-mm |
|-------|-------|----------|---------|
| 15244 | FC244 | N/A | N/A |

SharpShooter® 2.0 Repair Kit

- Contains:
 - Trigger
 - E-clip
 - Rubber Boot
 - Adjustment Knob
 - Orifice Plate
 - Mix Nozzle
 - Center Knob
 - Replacement Cap
- For use with our SS20 SharpShooter 2.0
- Sold 1 per inner pack/1 per outer pack



MADE IN U.S.A

MARSHALLTOWN The Premier Line

| EDI | Part# | Size-in. | Size-mm |
|-------|--------|----------|---------|
| 10340 | SS20RK | N/A | N/A |

SharpShooter® I Repair Kit

- Includes one orifice plate, center knob, knurled knob, rubber boot, trigger, e-clip, transfer bar and nozzle
- For use with our 693 SharpShooter® I
- Sold 1 per inner pack/1 per outer pack



MADE IN U.S.A

MARSHALLTOWN The Premier Line

| EDI | Part# | Size-in. | Size-mm |
|-------|-------|----------|---------|
| 16374 | RK696 | N/A | N/A |

SprayMate® Repair Kit

- Includes two knurled knobs, an orifice plate, rubber boot and rubber mix nozzle
- For use with our HG692 SprayMate®
- Sold 1 per inner pack/1 per outer pack



MADE IN U.S.A

MARSHALLTOWN The Premier Line

| EDI | Part# | Size-in. | Size-mm |
|-------|-------|----------|---------|
| 16355 | 794A | N/A | N/A |

QuickShooter™ Repair Kits

- **12107** Nozzle Kit Contains:
 - (1) Retaining Ring
 - (1) 4.0mm Fluid Nozzle
 - (1) 6.0mm Fluid Nozzle
 - (1) 8.0mm Fluid Nozzle
- **12108** O-Ring Kit Contains:
 - (4) O-Ring 10.82 X 1.78mm
 - (1) O-Ring 9.25 X 1.78mm
 - (2) O-Ring 35 X 3mm
- **12114** Fluid Control Kit Contains:
 - (1) O-Ring 9.25 X 1.78mm
 - (1) Fluid Control Knob Body
 - (1) Washer
 - (1) Spring
 - (1) Screw
- **12115** Air Regulation Kit Contains:
 - (1) O-Ring 11.5 X 1.5mm
 - (1) Air Inlet Nipple
 - (1) Air Regulator
 - (1) Brass Elbow
 - (1) Quick Disconnecter
- **12116** Trigger Kit Contains:
 - (1) Bail Trigger
 - (1) Gun Trigger
 - (2) E-Rings
 - (1) Trigger Pin
- **12117** Gun Body Kit Contains:
 - (1) Gun Body
- **12118** 45° Elbow Kit Contains:
 - (1) Hopper Clip
 - (1) 45° Elbow
- **12119** Needle Kit Contains:
 - (1) Nut Guide
 - (1) Gun Needle
 - (1) Cage
- Sold 1 per inner pack/1 per outer pack, sold 1 per inner pack/12 per outer pack where noted with *



QLT BY MARSHALLTOWN

| EDI | Part# | Description |
|-------|--------|--------------------|
| 12107 | 12107* | Nozzle Kit |
| 12108 | 12108* | O-Ring Kit |
| 12114 | 12114 | Fluid Control Kit |
| 12115 | 12115 | Air Regulation Kit |
| 12116 | 12116 | Trigger Kit |
| 12117 | 12117 | Gun Body |
| 12118 | 12118 | 45° Elbow |
| 12119 | 12119 | Needle Kit |

Skywalker Stilts® 2.1

- Calf cuff ratchet system to comfortably fit any size leg
- Ratchet ankle adjustment and locking toe strap ensure a tight comfortable fit
- New & improved composite footplate, reinforced with aluminum truss
- Flip and switch system allows for quick height adjustment
- Fully adjustable ankle spring allows for a more natural walking motion
- Durable rubber sole allows for longer life and better traction
- 225 lbs load limit
- Sold 1 per inner pack/1 per outer pack



NEW & IMPROVED
COMPOSITE FOOTPLATE



See Video



Ratchet system



Flip and switch system



Strong calf cuff design



U.S. Patent No. 7,981,008

MARSHALLTOWN The Premier Line

| EDI | Part# | Size-in. | Size-mm |
|-------|---------|----------|----------|
| 18590 | SKY2115 | 15-23 | 381-584 |
| 18591 | SKY2118 | 18-30 | 460-760 |
| 18592 | SKY2124 | 24-40 | 610-1016 |

Skywalker Stilts® 2.1 Replacement Parts

- C902 and FS903 replacement packs include left and right replacement parts
- CS925 fits only older style cuff with screw attachments for strap (not compatible with new rivet style)
- Sold 1 per inner pack/1 per outer pack



MARSHALLTOWN The Premier Line

| EDI | PART# | Description |
|-------|----------|---|
| 14902 | C902 | Calf Cuff Replacement (Pair) |
| 14903 | FS903 | Foot Strap Replacement Pack (2.0 Design) |
| 14904 | CB904 | Calf Cuff Replacement Bolts |
| 14905 | FP905 | Foot Plate/Outer Sole - SW215 & SW218 |
| 14926 | FP224 | Foot Plate/Outer Sole - SW224 |
| 14906 | AB906 | Ankle Bushing |
| 14907 | SP907 | Spring Set (Single) |
| 14929 | SC929 | Spring Cover |
| 14945 | LL945 | Lower Lock Assembly |
| 19004 | 21CP | Replacement Cuff Post |
| 19015 | 21FSP | 2.1 Replacement Foot Strap Pads |
| 18995 | 21FS903 | 2.1 Foot Strap Replacement Pack |
| 18996 | 21UFBL | 2.1 Complete Upper Foot Base Assembly - Left |
| 18997 | 21UFBR | 2.1 Complete Upper Foot Base Plate Assembly - Right |
| 18998 | 21UFBK | 2.1 Replacement Upper Foot Base Plate Kit |
| 18999 | 21HC | 2.1 Heel Cup Replacement |
| 19000 | 21CCB | 2.1 Replacement Calf Cuff Brackets |
| 19001 | 21ECBL | 2.1 Extrusion Clamp Bracket - Left |
| 19002 | 21ECBR | 2.1 Extrusion Clamp Bracket - Right |
| 19003 | 21UFBHDW | 2.1 Upper Foot Base Hardware Kit |
| 19005 | 21HLCL | 2.1 Height Lock Collar Replacement - Left |
| 19006 | 21HLCR | 2.1 Height Lock Collar Replacement - Right |
| 19007 | 21LAL | 2.1 Lock Assembly Replacement - Left |
| 19008 | 21LAR | 2.1 Lock Assembly Replacement - Right |
| 19009 | 21LE15L | SKY2115 Leg Extrusion Assembly - Left |
| 19010 | 21LE15R | SKY2115 Leg Extrusion Assembly - Right |
| 19011 | 21LE18L | SKY2118 Leg Extrusion Assembly - Left |
| 19012 | 21LE18R | SKY2118 Leg Extrusion Assembly - Right |
| 19013 | 21LE24L | SKY2124 Leg Extrusion Assembly - Left |
| 19014 | 21LE24R | SKY2124 Leg Extrusion Assembly - Right |

Skywalker Stilts® 1.0

- Heavy gauge overlapping aluminum leg tubes
- Padded calf brace
- Dual spring action
- Adjustable metal buckle straps and adjustable heel plates already attached
- 225 lb. load limit
- Sold 1 per inner pack/4 per outer pack



Padded Calf Brace



Dual Spring Action



Heavy Gauge Overlapping Aluminum Leg Tubes



QLT BY MARSHALLTOWN

| EDI | Part# | Size-in. | Size-mm |
|-------|-------|----------|----------|
| 16658 | ST18 | 18-30 | 457-762 |
| 16659 | ST24 | 24-40 | 610-1016 |

Part Kits for Skywalker Stilts® 1.0

- Part kits fit both **ST18** and **ST24**
- Individual replacement parts available
- Replacement parts for the discontinued **SW18** & **SW24** stilts are available- please contact customer service or visit our website for details
- Sold 1 per inner pack/1 per outer pack
- **SA45** Includes:
 - (4) 1/4" - 20 Locknuts
 - (8) Flat Washers
 - (4) 1/4" - 20 Hex Nuts
 - (4) Spring Adjusters
 - (2) Upper Coil Springs (Black)
 - (8) Nylon Bearings
 - (8) #8 - 3/8" Self Thread Screws
 - (2) Spring Dividers
 - (2) 1/4" - 20 X 7 7/8" Threaded Studs
 - (2) Lower Coil Springs (Zinc)
- **RS52** Includes:
 - (2) Calf Straps
 - (2) Ankle Straps
 - (2) Toe Straps
 - (8) Washers
 - (8) Screws
- **WB61** Includes:
 - (4) Wing Bolts with Washers
- **RS64** Includes:
 - (4) Soles
 - (16) Screws

QLT BY MARSHALLTOWN

| EDI | Part# | Description | Size-in. | Size-mm |
|-------|-------|-----------------------|----------|---------|
| 16315 | SA45 | Spring Assembly Kit | N/A | N/A |
| 16316 | RS52 | Replacement Strap Kit | N/A | N/A |
| 16317 | WB61 | Wing Bolt Kit | N/A | N/A |
| 16318 | RS64 | Replacement Sole Kit | N/A | N/A |

Replacement Parts for Skywalker Stilts® 1.0

- Sold 1 per inner pack/1 per outer pack

QLT BY MARSHALLTOWN

| EDI | Part# | Description |
|-------|-----------|--|
| 16470 | P1 | Leg Band |
| 16698 | P1ST | Leg Band Assembly |
| 16471 | P2 | Band Spacer |
| 16696 | P3 | 1/4"-20 X 2" (6-20 X 51mm) Screw |
| 16472 | P4 | Leg Strap |
| 16496 | P6 | Machine Screw |
| 16475 | P7 | Arch Straps |
| 16476 | P8 | Toe Straps |
| 16477 | P9 | Foot Plate |
| 16478 | P10 | Heel Bracket |
| 11670 | P11 | Leg Bearing |
| 11671 | P12 | 1/4" (6mm) Flat Washer |
| 11672 | P13 | 1/4" (6mm) Nylon Insert Lock Nut |
| 11673 | P14 | 1/4" (3mm)-20 Hex Nut |
| 16479 | P15 | Spring Adjuster |
| 16480 | P16 | Upper Coil Spring |
| 11674 | P17 | Strap Mounting Washer |
| 11675 | P18 | Nylon Spring Bearing |
| 16481 | P20 | Spring Divider |
| 16700 | P21 | Leg Band Washer |
| 11677 | P22 | 1/4 X 7 7/8" (3 X 200mm) Stud |
| 16676 | P23-18ST | 1" (25mm) o.d. lw. strut tube-ST18 |
| 16678 | P23-24ST | 1" (25mm) o.d. lw. strut tube-ST24 |
| 16680 | P24ST | 1/4"-20 X 1 1/2" (6-20 X 13mm) Hex Head Bolt, Flat Washer, Lock Washer |
| 11681 | P26 | Nylon Floor Plate - Plate Only |
| 16482 | P26B | Floor Plate w/Soles |
| 11682 | P27 | 1/4"-20 X 3" (6-20 X 76mm) Cap Screw |
| 11683 | P28 | 1/4"-20 X 2" (6-20 X 51mm) Cap Screw |
| 11684 | P29 | Rnd-Lock Front Tube Clamp |
| 11685 | P30 | Rnd-Lock Back Tube Clamp |
| 11686 | P31 | Metal Clamp Bracket |
| 11687 | P32 | 1/4"-20 X 1 3/4" (6-20 X 44mm) Cap Screw |
| 11688 | P35 | Strap Mounting Screw |
| 11689 | P37 | Sole Mounting Screw |
| 16485 | P42 | Wing Bolt |
| 16486 | P44 | Lower Coil Spring |
| 16487 | P45 | Spring Assembly |
| 16488 | P46 | Soles w/Screws |
| 16682 | P47-18ST | Fwd. Adj. Leg Extr.-ST18 |
| 16684 | P47-24ST | Fwd. Adj. Leg Extr.-ST24 |
| 16489 | P48 | Lrg. Sleeve |
| 16490 | P49 | Sml. Sleeve |
| 16686 | P50L-18ST | Left Rr. Out. Leg Extr.-ST18 |
| 16688 | P50L-24ST | Left Rr. Out. Leg Extr.-ST24 |
| 16690 | P50R-18ST | Right Rr. Out. Leg Extr.-ST18 |
| 16692 | P50R-24ST | Right Rr. Out. Leg Extr.-ST24 |
| 16494 | P51-18 | Extension Tube |
| 16495 | P51-24 | Extension Tube |

(See next page for a breakdown of replacement parts and kits)

Schematic for Skywalker Stilts® 1.0

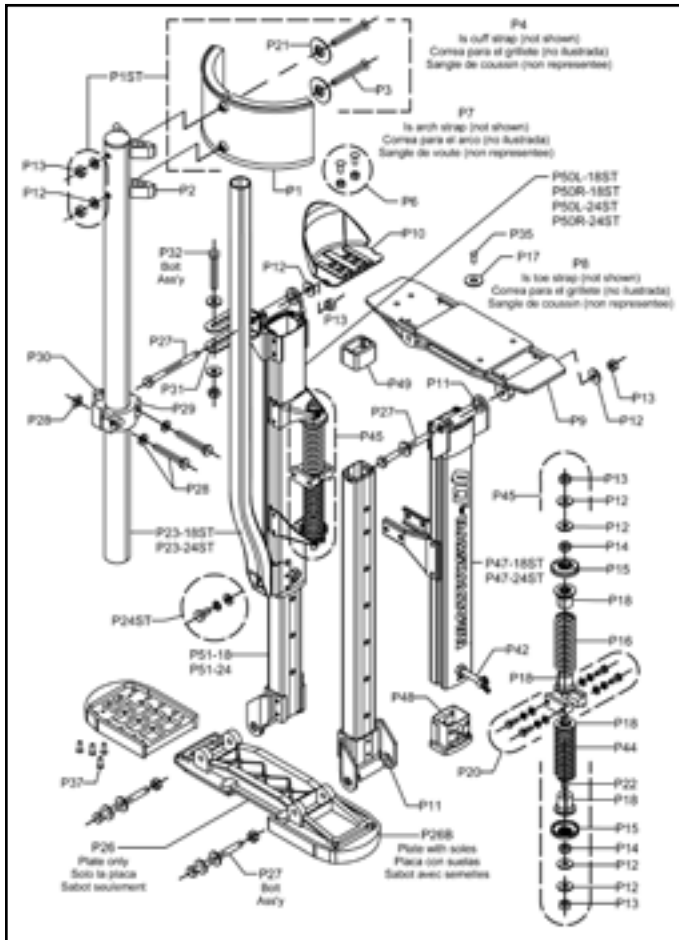

Drywall Panel Lift

- Lifts sheets of drywall up to 11' (3.35M) ceilings
- Lifting capacity of 150 lbs.
- Cradle can support up to 4 x 16' (1.22 x 4.88M) sheets
- Cradle tilts for attaching sheets to sloped ceilings or side walls
- 34" (864mm) loading height
- Can easily be assembled and operated by 1 person
- Built-in brake to prevent free falls
- Breaks down to 3 pieces for easy transport
- Sold 1 per inner pack/1 per outer pack



QLT BY MARSHALLTOWN

| EDI | Part# | Size-Ft. | Size-M |
|-------|-------|----------|--------|
| 12421 | PL11C | 11 | 3.35 |

Aluminum Work Bench

- High strength aluminum alloy construction
- E-Z lock height slide for quick effortless adjustments
- Bench height adjustable from 18 to 30" in 2" increments (457 to 762mm in 51mm increments)
- Folds up and locks shut
- Rubber feet to prevent slipping
- Maximum load 500 lbs.
- Sold 1 per inner pack/1 per outer pack



QLT BY MARSHALLTOWN

| EDI | Part# | Size-in. | Size-mm |
|-------|-------|------------|------------|
| 13700 | WB700 | 48 X 9 1/2 | 1219 X 241 |

Aluminum Work Bench Extension Legs

- High strength aluminum alloy construction
- Fits **WB700** Aluminum Work Bench
- Two additional crossbar/rungs included (not pictured)
- Legs adjust from 33 to 44" in 2" increments (838 to 1143mm in 51mm increments)
- Sold 1 per inner pack/1 per outer pack



QLT BY MARSHALLTOWN

| EDI | Part# | Size-in. | Size-mm |
|-------|-------|----------|----------|
| 13701 | EL701 | 33-44 | 838-1118 |

Spray Shield

- High quality aluminum shield is easy to clean
- One-piece construction with 1/2" (13mm) lip to catch drips
- Hardwood handle measures 17" (432mm) long
- Sold 6 per inner pack/6 per outer pack



MADE IN
U.S.A.

MARSHALLTOWN The Premier Line

| EDI | Part# | Size-in. | Size-mm |
|-------|-------|------------|-----------|
| 14319 | 2536 | 36 X 9 1/2 | 914 X 242 |

Aluminum Spray Shield

- Corrosion resistant aluminum blades, with a rigid plastic backer, are lightweight and easy to clean
- Front and back run-off lips direct paint away from handle
- Can be used during wall texturing applications
- Comfortable 18" (432mm) plastic handle
- Sold 6 per inner pack/6 per outer pack



2633

QLT BY MARSHALLTOWN

| EDI | Part# | Size-in. | Size-mm |
|-------|-------|----------|---------|
| 12633 | 2633 | 24 | 610 |
| 12634 | 2634 | 36 | 914 |
| 12635 | 2635 | 48 | 1219 |
| 12636 | 2636 | 60 | 1524 |

Plastic Spray Shield

- Flexible polystyrene blades, with a rigid plastic backer, are lightweight and easy to clean
- Front and back run-off lips direct paint away from handle
- Comfortable 18" (432mm) plastic handle
- Sold 6 per inner pack/6 per outer pack



2629

QLT BY MARSHALLTOWN

| EDI | Part# | Size-in. | Size-mm |
|-------|-------|----------|---------|
| 12629 | 2629 | 24 | 610 |
| 12630 | 2630 | 36 | 914 |
| 12631 | 2631 | 48 | 1219 |
| 12632 | 2632 | 60 | 1524 |

Door Painting Stands

- Used to stand-up and brace multiple doors for easier painting
- Galvanized steel plate attaches easily with a mallet or hammer
- Unique screw-hole allows for a sturdier connection
- 6 stands per set
- Sold 1 set per inner pack/6 sets per outer pack

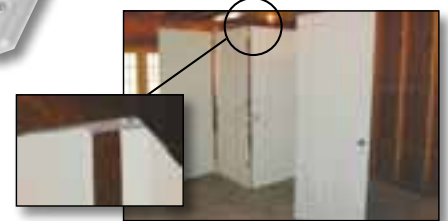

MARSHALLTOWN The Premier Line

| EDI | Part# | Size-in. | Size-mm |
|-------|-------|----------|---------|
| 16079 | 16079 | N/A | N/A |

Resealable Zipper Doorway

- Creates entryway that can be opened and closed
- Adhesive backed zippers stick to plastic used to seal off room
- Plastic not included
- Creates 7ft tall doorway
- Pack includes 2 adhesive backed zippers
- Sold 1 per inner pack /1 per outer pack



QLT BY MARSHALLTOWN

| EDI | Part# | Size-in. | Size-mm |
|-------|-------|-------------|----------|
| 18386 | DBZ | 3/4 X 8 1/4 | 19 X 209 |

Bucket Opener

- Sturdy molded plastic
- Removes 5-gallon plastic pail lids quickly and easily
- Sold 6 per inner pack/24 per outer pack



MADE IN
U.S.A.

QLT BY MARSHALLTOWN

| EDI | Part# | Size-in. | Size-mm |
|-------|-------|-------------|----------|
| 19662 | E740 | 3/4 X 8 1/4 | 19 X 209 |

Can Opener

- Quart and gallon can/bottle opener
- Sold 50 per inner pack/outer pack

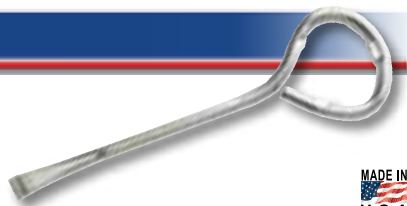

MADE IN
U.S.A

QLT BY MARSHALLTOWN

| EDI | Part# | Size-in. | Size-mm |
|-------|-------|-----------------|---------|
| 19541 | E14 | 4 $\frac{1}{2}$ | 124 |

Pot Hooks

- Swivel pot hook allows pot to seek level
- Snaps onto paint pot
- Secure on ladders, eaves, troughs or any convenient place
- E383 sold 12 per inner pack/144 per outer pack; E385 sold 2 per card/12 cards per inner/outer pack



MADE IN
U.S.A

MARSHALLTOWN The Premier Line

| EDI | Part# | Description | Size-in. | Size-mm |
|-------|-------|--------------------|-----------------|---------|
| 19620 | E383 | Swivel Pot Hook | 6 | 152 |
| 19622 | E385 | Side Rail Pot Hook | 7 $\frac{1}{4}$ | 197 |

Paint Brush Comb

- Recommended by most brush manufacturers for maintaining maximum brush performance
- Comb through brush bristles to clean and straighten before storage
- High density polyethylene handle will not absorb water or solvents
- Redesigned with roller cleaner
- E6121 come carded; sold 12 per inner pack/12 per outer pack
- E6125 sold 12 per inner pack/144 per outer pack



QLT BY MARSHALLTOWN

| EDI | Part# | Size-in. | Size-mm |
|-------|-------|----------|---------|
| 19773 | E6121 | N/A | N/A |
| 19774 | E6125 | N/A | N/A |

DuraSoft® Scraper

- Accepts standard single edge razor blades
- Durasoft® handle for increased comfort and reduced fatigue
- Comes with 10 replacement blades
- One display box contains 8 individually packaged knives
- Sold 12 per inner pack/48 per outer pack



MARSHALLTOWN The Premier Line

| EDI | Part# | Size-in. | Size-mm |
|-------|-------|----------|---------|
| 19074 | 9074 | 6 | 152 |

Double Ended Window Tool

- Chisel side to remove putty and caulk for a clean start
- Use the chisel side to apply new compound
- V-shaped side to pack and shape the caulk or putty
- Sold 12 per inner pack/144 per outer pack



QLT BY MARSHALLTOWN

| EDI | Part# | Size-in. | Size-mm |
|-------|-------|----------|---------|
| 16140 | 16140 | N/A | N/A |

Razor Blades

- Fits knives 9055, 9056 and 9074
- Merchandiser holds 2 display boxes (40 packs of 5 blades)
- Inner/outer pack quantities are shown in table



QLT BY MARSHALLTOWN

| EDI | Part# | Description | Size | Inner/Outer |
|-------|-------|---------------------|------|-------------|
| 19625 | E397 | Pkg. of 100 Blades | N/A | 10/50 |
| 19626 | E398 | 2 Packs of 5 Blades | N/A | 10/200 |
| 19627 | E399 | Blade Merchandiser | N/A | 1/1 |

Metal Razor Blade Scraper

- Soft grip strips provide comfortable and sure gripping surface
- Strong metal frame
- Blade locks into position for safety
- Retractable thumb-push design
- Packed with 5 blades
- One display box contains 12 scrapers
- Uses E397, E398 and E399 razor blades
- Sold 1 per inner pack/12 per outer pack



QLT BY MARSHALLTOWN

| EDI | Part# | Size-in. | Size-mm |
|-------|-------|----------|---------|
| 19055 | 9055 | 4 | 102 |

Mini Razor Blade Scraper

- Removes coatings, paint and stickers from glass, mirrors or windshields
- Accepts standard single edge razor blades
- Includes one blade
- One display box contains 24 scrapers
- Uses E397, E398 and E399 razor blades
- Sold 1 per inner pack/20 per outer pack



QLT BY MARSHALLTOWN

| EDI | Part# | Size-in. | Size-mm |
|-------|-------|----------|---------|
| 19056 | 9056 | 2 | 51 |

Refinishing Tool

- Made of solvent resistant plastic
- Used for scraping and removing chemically dissolved paint
- Beveled points on sides of blade for tight crevices
- Sold 24 per inner pack/24 per outer pack



MADE IN
U.S.A

MARSHALLTOWN The Premier Line

| EDI | Part# | Size-in. | Size-mm |
|-------|-------|----------|---------|
| 10855 | 10855 | N/A | N/A |

Bent Blade Scraper

- Thick tempered blade with a sharp edge
- Blade is angled at 20° for easier paint removal
- Hardwood handle
- Scraper works equally well with heat guns or chemical removers
- Sold 24 per inner pack/96 per outer pack



QLT^{BY} MARSHALLTOWN

| EDI | Part# | Size-in. | Size-mm |
|-------|-------|----------|----------|
| 16748 | BS748 | 3 X 12 | 76 X 305 |

Threaded Handle Scrapers

- 5 $\frac{3}{4}$ " (146mm) ACME threaded handle fits all standard extension poles (see page 182 for options)
- Steel ferrule reinforces the joint for reliable overhead work
- High polished stainless steel blade
- Polypropylene handle contoured for easy grip
- E90 sold 12 per inner pack/72 per outer pack, E91 sold 12 per inner pack/72 per outer pack



QLT^{BY} MARSHALLTOWN

| EDI | Part# | Description | Size-in. | Size-mm |
|-------|-------|-------------|----------------------|----------|
| 19567 | E90 | Straight | 3 X 10 $\frac{1}{4}$ | 76 X 260 |
| 19568 | E91 | Bent | 3 X 10 | 76 X 254 |

Floor Scraper

- 60" (1524mm) steel handle welded to angle iron bracket
- Diameter of handle is 1 $\frac{1}{8}$ " (28mm)
- Blade is made of heavy gauge spring steel
- Plastic grip on handle to protect hands
- Sold 6 per inner pack/6 per outer pack



MADE IN
U.S.A

MARSHALLTOWN The Premier Line

| EDI | Part# | Description | Size-in. | Size-mm |
|-------|-------|--------------------|----------------------|-----------|
| 12127 | 420 | Floor Scraper | 9 X 4 $\frac{1}{2}$ | 229 X 114 |
| 12129 | 420B | Replacement Blades | 9 X 4 $\frac{1}{2}$ | 229 X 114 |
| 16453 | 720 | 14" Floor Scraper | 14 X 4 $\frac{1}{2}$ | 356 X 114 |
| 16454 | 720B | Replacement Blade | 14 X 4 $\frac{1}{2}$ | 356 X 114 |
| 16398 | 820 | 20" Floor Scraper | 20 X 4 $\frac{1}{2}$ | 508 X 114 |
| 16399 | 820B | Replacement Blade | 20 X 4 $\frac{1}{2}$ | 508 X 114 |

T-Handled Floor Scraper

- All steel construction
- 54" (1372mm) long T-handle
- Heavy duty construction
- Removes many types of floor coverings from a variety of floors
- Inner/Outer Pack quantities listed in table



QLT^{BY} MARSHALLTOWN

| EDI | Part# | Description | Size-in. | Size-mm | Inner/Outer |
|-------|--------|------------------|----------|------------|-------------|
| 12504 | THS7 | Scraper w/ Blade | 54 x 7 | 1372 x 178 | 1/6 |
| 12506 | THS7B | 7" Repl. Blade | 7 x 3 | 178 x 76 | 24/120 |
| 12507 | THS10B | 10" Repl. Blade | 10 x 3 | 254 x 76 | 24/96 |

Floor Scrapers

- For more floor scrapers see pages 221-223



4" Wall and Floor Scrapers

- 4" replaceable blade
- Strips and removes wallpaper, paint, and varnish
- Offset blade for optimum scraping angle
- Use for cleaning glass, tile, and floors
- Use 17476 Replacement Blades
- Replacement Blades contains 5 blades
- Caution: Blades very sharp, handle with care
- Inner/Outer quantities shown in table



QLT BY MARSHALLTOWN

| EDI | Part# | Description | Handle | Inner/Outer |
|-------|--------|--------------|--------------|-------------|
| 17473 | WFS45 | Scraper | 5" (127mm) | 25/100 |
| 17474 | WFS49 | Scraper | 9" (229mm) | 12/72 |
| 17475 | WFS448 | Scraper | 48" (1219mm) | 12/36 |
| 17476 | 17476 | Repl. Blades | N/A | 25/400 |

Heavy Duty Scrapers

- Sharp 4" (102mm) wide blade for stripping hard to remove floor covering and adhesives
- Heavy duty aluminum construction
- Double sided, hardened steel blade
- Easy to replace blade
- Scraper size refers to handle length
- Inner/outer pack quantities shown in table



MARSHALLTOWN The Premier Line

| EDI | Part# | Description | Size-in. | Size-mm | Inner/Outer |
|-------|---------|-------------|----------|---------|-------------|
| 10467 | SC412 | Scraper | 12 | 305 | 6/24 |
| 10468 | SC418 | Scraper | 18 | 457 | 6/30 |
| 10469 | SC448 | Scraper | 48 | 1219 | 6/18 |
| 10470 | SCBLADE | Repl. Blade | 4 | 102 | 10/100 |

Paint Scrapers

- Can be used on wood or paint
- For easy removal of paint or other finishes
- Blade is easily replaced
- Replacement blades sold 2 per card
- Inner/Outer pack quantities listed in table



QLT BY MARSHALLTOWN

| EDI | Part# | Size-in. | Size-mm | Inner/Outer |
|-------|---------|----------|---------|-------------|
| 11044 | PS1W1 | 1 | 25 | 6/72 |
| 11045 | PS112W2 | 1 1/2 | 38 | 6/72 |
| 11046 | PS212W2 | 2 1/2 | 64 | 6/72 |

Replacement Blades

| EDI | Part# | Size-in. | Size-mm | Inner/Outer |
|-------|----------|----------|---------|-------------|
| 11047 | PS1WRB | 1 | 25 | 24/144 |
| 11048 | PS112WRB | 1 1/2 | 38 | 24/144 |
| 11049 | PS212WRB | 2 1/2 | 64 | 12/144 |

Soft Grip Paint Scrapers

- Can be used for wood or paint
- For easy removal of paint or other finishes
- Soft grip handle
- 2 or 4 edged blade
- Replacement blades available
- Inner/Outer pack quantities listed in table

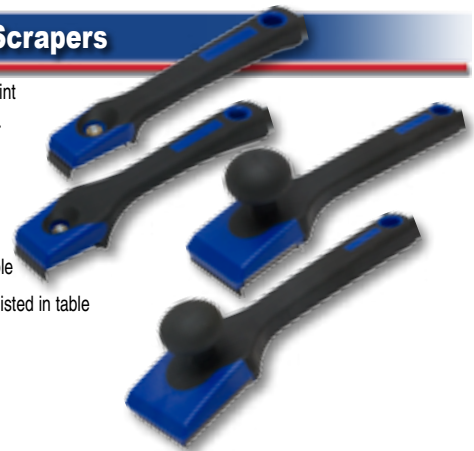

QLT BY MARSHALLTOWN

| EDI | Part# | Size-in. | Size-mm | Inner/Outer |
|-------|---------|----------|---------|-------------|
| 11051 | PS1S2 | 1 | 25 | 6/72 |
| 11052 | PS112S2 | 1 1/2 | 38 | 6/72 |
| 11053 | PS212S2 | 2 1/2 | 64 | 6/72 |
| 11050 | PS212S4 | 2 1/2 | 64 | 4/24 |
| 11054 | PS3S4 | 3 | 76 | 4/24 |

Replacement Blades

| EDI | Part# | Size-in. | Size-mm | Inner/Outer |
|-------|-----------|----------|---------|-------------|
| 11055 | PS1SRB | 1 | 25 | 24/144 |
| 11056 | PS112SRB | 1 1/2 | 38 | 24/144 |
| 11057 | PS212S2RB | 2 1/2 | 64 | 12/144 |
| 11058 | PS212S4RB | 2 1/2 | 64 | 12/144 |
| 11059 | PS3S4RB | 3 | 76 | 12/144 |

Soft Grip Carbide Scrapers

- Lasts 10 times longer than hardened steel
- Contoured soft grip handle
- Capped end unscrews for extra blade storage and is ACME threaded for broom handle attachment
- Scrapers sold 1 per inner pack/12 per outer pack
- E341 blades come six per pack; E343 and E345 come ten per pack, all sold 1 pack per inner pack/1 per outer pack



QLT BY MARSHALLTOWN

| EDI | Part# | Description | Size-in. | Size-mm |
|-------|-------|----------------------|----------|---------|
| 14367 | 367 | Scraper | 1 | 25 |
| 14368 | 368 | Scraper | 2 | 51 |
| 14369 | 369 | Scraper w/Knob | 2½ | 64 |
| 19939 | E341 | Repl. Blades for 367 | 1 | 25 |
| 19934 | E343 | Repl. Blades for 368 | 2 | 51 |
| 19941 | E345 | Repl. Blades for 369 | 2½ | 64 |

Molding Scraper

- High quality detail scraper
- Designed to scrape molding contours, carved woodwork and cracks/seams
- Also used for shutters, eaves, doors, boats... you name it
- 9" (229mm) handle balanced for a variety of blades
- E9483 sold 6 per inner pack/72 per outer pack, E1241 sold 6 per inner pack/72 per outer pack, replacement blades sold 1 per card/12 cards per inner pack/12 cards per outer pack



Triangle
*Available in two sizes

Shield

Cyma

Half Ogee

Ogee

Panel

MADE IN U.S.A

MARSHALLTOWN The Premier Line

| EDI | Part# | Description | Size-in. | Size-mm |
|-------|-------|--------------------|----------|----------|
| 19483 | E9483 | Scraper w/7 Blades | 9 | 229 |
| 19691 | E1241 | Scraper w/ E1242 | 2¼ X 9 | 64 X 229 |
| 19692 | E1242 | Triangle Blade | 2¼ | 64 |
| 19693 | E1243 | Triangle Blade | 3 | 76 |
| 19694 | E1244 | Ogee Blade | N/A | N/A |
| 19695 | E1245 | Half Ogee Blade | N/A | N/A |
| 19696 | E1246 | Panel Blade | N/A | N/A |
| 19697 | E1247 | Cyma Blade | N/A | N/A |
| 19484 | E9484 | Shield Blade | N/A | N/A |

Wallpaper Stripper

- Heavy gauge die cast construction
- Razor sharp 4" (102mm) blade, angle mounted
- Ergonomic 13½" (343mm) handle
- E440 sold 6 per inner pack/6 per outer pack, E442 sold 10 per inner pack/10 per outer pack, E444 sold 1 per inner pack/1 per outer pack



MADE IN U.S.A

QLT BY MARSHALLTOWN

| EDI | Part# | Description | Size-in. | Size-mm |
|-------|-------|--------------------|----------|---------|
| 19634 | E440 | Scraper | 4 | 102 |
| 19635 | E442 | Pack of 5 Blades | N/A | N/A |
| 19636 | E444 | Pack of 100 Blades | N/A | N/A |

Tack Cloth

- Sticky material used to remove dust before painting, varnishing or staining
- Sold 1 per inner pack/72 per outer pack



MARSHALLTOWN The Premier Line

| EDI | Part# | Size-in. | Size-mm |
|-------|-------|----------|-----------|
| 10472 | TC472 | 18 X 36 | 457 X 914 |

Sharpening File

- Heavy, extra-fine high carbon steel
- Sharpen and/or reshape blades
- Ideal for scrapers, chisels, shears and mower blades
- Sold 12 per inner pack/12 per outer pack



MADE IN U.S.A

MARSHALLTOWN The Premier Line

| EDI | Part# | Size-in. | Size-mm |
|-------|-------|----------|----------|
| 19556 | E38 | ¾ X 8 | 19 X 203 |

Triple Edge Knife

- Textured handle for better grip
- Used for taping, scraping and trimming
- Made of durable plastic
- Sold 30 per inner pack/30 per outer pack



MADE IN U.S.A

QLT BY MARSHALLTOWN

| EDI | Part# | Size-in. | Size-mm |
|-------|--------|----------|-----------|
| 16290 | TEK290 | 10 X 6 | 254 X 152 |

Wire Brushes

- Tempered spring steel or brass filaments
- Used for removing semi-dry concrete from tools and forms, asbestos removal, surface prep or chemical paint removal
- Sold 12 per inner pack/12 per outer pack



QLT[®] MARSHALLTOWN

| EDI | Part# | Description | Size-in. | Size-mm | Bristle Size | Bristle Rows |
|-------|-------|------------------------|--|----------|--|------------------|
| 19628 | E404 | Steel/28 ga. | 7 ¹ / ₄ X 2 ¹ / ₄ | 184 X 57 | 3 ³ / ₄ " (44mm) | 6 wide X 19 long |
| 19629 | E406 | Brass/32 ga. | 13 ³ / ₄ X 1 | 349 X 25 | 1 ¹ / ₈ " (29mm) | 3 wide X 19 long |
| 19630 | E407 | Steel/33 ga. | 10 ¹ / ₄ X 1 ¹ / ₈ | 260 X 29 | 1 ¹ / ₈ " (29mm) | 4 wide X 16 long |
| 19631 | E408 | Steel/33 ga. | 14 X 1 ¹ / ₈ | 356 X 29 | 1 ¹ / ₈ " (29mm) | 4 wide X 18 long |
| 19632 | E409 | Steel/28 ga. w/Scraper | 11 X 1 ¹ / ₂ | 279 X 38 | 5 ⁵ / ₈ " (41mm) | 4 wide X 10 long |
| 19633 | E410 | Steel/33 ga. w/Scraper | 14 X 1 | 356 X 25 | 1 ¹ / ₈ " (29mm) | 3 wide X 19 long |
| 16649 | 6649 | Steel w/Scraper | 10 X 1 | 254 X 25 | 1 ¹ / ₈ " (29mm) | 4 wide X 16 long |

Carbon Steel Wire Brush w/Scraper

- Domestic hardwood handle
- Tempered spring steel filaments
- Used for removing semi-dry concrete from tools and forms, asbestos removal, surface prep or chemical paint removal
- Bristle rows are 4 wide X 16 long
- Sold 1 per inner pack/12 per outer pack



MADE IN
U.S.A.

MARSHALLTOWN The Premier Line

| EDI | Part# | Size-in. | Size-mm | Bristle Size |
|-------|-------|----------|----------|--|
| 16518 | 6518 | 10 X 1 | 254 X 25 | 1 ¹ / ₈ " (29mm) |

Stainless Steel Seam Rollers

- 1¹/₈" (29mm) head designed to push through commercial materials
- High density polyethylene core will not wear
- Resilient DuraSoft[®] handle provides a soft feel, reduces fatigue and offers excellent durability
- Sold 6 per inner pack/6 per outer pack



MADE IN
U.S.A.

MARSHALLTOWN The Premier Line

| EDI | Part# | Description | Size-in. | Size-mm |
|-------|-------|--------------|-------------------------------|---------|
| 19602 | E225D | Flat | 2 | 51 |
| 19603 | E226D | Sidearm Flat | 1 ¹ / ₂ | 38 |

Professional Gemstone Plastic Seam Rollers

- Preferred by professionals
- High density polyethylene head won't split or wear out-of-round
- Head individually machined for perfect concentricity and smooth running
- Wear resistant, outer pack hardened, plated axle and rust resistant frame
- Resilient DuraSoft[®] handle provides a soft feel, reduces fatigue and offers excellent durability
- Sold 6 per inner pack/6 per outer pack



E216D

MADE IN
U.S.A.

MARSHALLTOWN The Premier Line

| EDI | Part# | Description | Size-in. | Size-mm |
|-------|-------|-------------|----------|---------|
| 19600 | E216D | Flat | 2 | 51 |

Solid Rubber Seam Roller

- Medium firm rubber roller is versatile and rugged
- Use on string, grass cloth, expanded vinyl and embossed wallcovering
- Resilient DuraSoft[®] handle provides a soft feel, reduces fatigue and offers excellent durability
- Sold 6 per inner pack/6 per outer pack



MADE IN
U.S.A.

MARSHALLTOWN The Premier Line

| EDI | Part# | Description | Size-in. | Size-mm |
|-------|-------|-------------|----------|---------|
| 19560 | E54D | Flat | 2 | 51 |

Solid Maple Seam Rollers

- Polished hard maple roller for no-track seams and better hold
- Wear resistant, outer pack hardened, plated axle and rust resistant frame
- Resilient DuraSoft® handle provides a soft feel, reduces fatigue and offers excellent durability
- Sold 6 per inner pack/6 per outer pack



E98D

E83D



MARSHALLTOWN The Premier Line

| EDI | Part# | Description | Size-in. | Size-mm |
|-------|-------|-------------|----------|---------|
| 19571 | E98D | Flat | 1 | 25 |
| 19564 | E83D | Flat | 2 | 51 |

Economy Grade Seam Rollers

- Solid wood roller and oval handle
- Sturdy steel frame and axle
- For DIY paperhanging, arts/crafts and letterpress
- Sold 6 per inner pack/6 per outer pack



QLT BY MARSHALLTOWN

| EDI | Part# | Description | Size-in. | Size-mm |
|-------|-------|-------------|----------|---------|
| 19570 | E97 | Flat | 1 | 25 |
| 19565 | E84 | Flat | 2 | 51 |

Soft Grip Shears

- Soft grip handles
- Stainless steel blades
- For right or left handed cutting
- Sold 6 per inner pack/144 per outer pack



QLT BY MARSHALLTOWN

| EDI | Part# | Size-in. | Size-mm |
|-------|-------|----------|---------|
| 19482 | E119 | 11 | 279 |

Heavy Duty Professional Shears

- Designed for 54" (1372mm) commercial wallcovering
- Bent handle shear
- Hot drop forged, plated
- Sold 1 per inner pack/1 per outer pack



QLT BY MARSHALLTOWN

| EDI | Part# | Size-in. | Size-mm |
|-------|-------|----------|---------|
| 19569 | E96 | 10 | 254 |

DuraSoft® Razor Knife

- Ergonomically designed DuraSoft® razor knife for increased comfort and reduced fatigue
- Locking mechanism ensures blade is firmly locked in place, but can be changed quickly and easily
- Magnetic blade storage; holds 3 extra blades
- Uses most single edge razor blades
- Sold 6 per inner pack/24 per outer pack



MARSHALLTOWN The Premier Line

| EDI | Part# | Size-in. | Size-mm |
|-------|-------|----------|---------|
| 16657 | R657 | 5 3/4 | 146 |

Razor Knife

- Metal frame holds standard single edge razor blade
- Soft grip handle for added comfort and increased grip
- One display box contains 12 knives
- Sold 1 display box per inner pack/12 display boxes per outer pack



QLT BY MARSHALLTOWN

| EDI | Part# | Size-in. | Size-mm |
|-------|-------|----------|---------|
| 19057 | 9057 | 6 1/4 | 158 |

Paste Brush

- 6" (152mm) wood handle
- 3/4" (19mm) thick with hanging hole
- 3 1/8" (79mm) white Tampico bristles, 2 rows
- Sold 12 per inner pack/12 per outer pack



MARSHALLTOWN The Premier Line

| EDI | Part# | Size-in. | Size-mm |
|-------|-------|----------|---------|
| 19705 | E2002 | N/A | N/A |

Combination Graining Tool

- Solid molded plastic design
- Detachable handle and graining surface for easy cleaning
- Easy to simulate beautiful grain on wood and metal
- Instruction booklet included
- E6151 sold 6 per inner pack/6 per outer pack; E6151-1 comes in bulk of 150, sold 1 inner pack/outer pack



MARSHALLTOWN The Premier Line

| EDI | Part# | Size-in. | Size-mm |
|-------|---------|----------|---------|
| 19775 | E6151 | N/A | N/A |
| 19529 | E6151-1 | N/A | N/A |

Single Line Stripers

- Roll out permanent lines and stripes, easily and quickly on any smooth surface including paper, wood, glass and metal
- Works with paint, enamel, lacquer, bronze, even glue
- Equipped with adjustable line guide
- Use with straight edge, template or free hand
- Interchangeable wheel tip assemblies ranging in width from 1/64" to 1/4" (.4 to 6mm)
- Complete with easy-to-follow instructions
- Sold 6 per inner pack/6 per outer pack
- E1080 kit includes one single line striper and all eight interchangeable wheels, sold 6 per inner pack/6 per outer pack

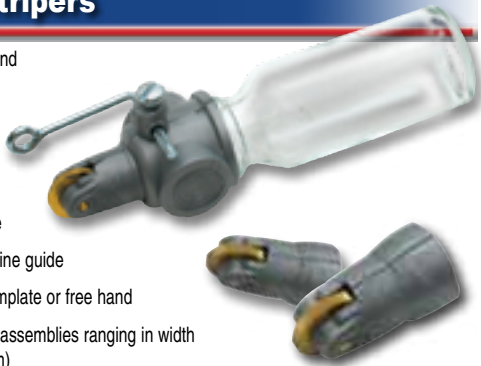

Extra Wheel Tip Assemblies



MARSHALLTOWN The Premier Line

| EDI | Part# | Size-in. | Size-mm |
|-------|-------|----------|---------|
| 19664 | E1001 | 1/64 | .4 |
| 19665 | E1002 | 1/32 | .8 |
| 19666 | E1003 | 3/64 | 1 |
| 19667 | E1004 | 1/16 | 1.5 |
| 19668 | E1005 | 5/64 | 2 |
| 19669 | E1006 | 3/32 | 2.5 |
| 19670 | E1007 | 1/8 | 3 |
| 19671 | E1008 | 1/4 | 6 |
| 19680 | E1080 | N/A | N/A |

Extra Wheel Tip Assemblies

| EDI | Part# | Size-in. | Size-mm |
|-------|-------|----------|---------|
| 19672 | E1011 | 1/64 | .4 |
| 19673 | E1012 | 1/32 | .8 |
| 19674 | E1013 | 3/64 | 1 |
| 19675 | E1014 | 1/16 | 1.5 |
| 19676 | E1015 | 5/64 | 2 |
| 19677 | E1016 | 3/32 | 2.5 |
| 19678 | E1017 | 1/8 | 3 |
| 19679 | E1018 | 1/4 | 6 |

Double Line Striper Kit

- Includes:
 - One double wheel striping tool
 - Six wheels: two 1/16" (.4mm), two 1/32" (.8mm), one 3/32" (2.5mm), one 1/4" (6mm)
 - Four spacers: two 1/16" (.4mm), one 1/32" (.8mm), one 3/32" (2.5mm)
 - Extra washer
 - Extra 1/2 oz. bottle
 - Self-storing plastic tray-carded and blister packed with instructions
- Sold 6 per inner pack/6 per outer pack



MARSHALLTOWN The Premier Line

| EDI | Part# | Size-in. | Size-mm |
|-------|-------|----------|---------|
| 19681 | E1100 | N/A | N/A |

Line Striper Accessories

- E1202 & E1203 come two per card; sold 6 cards per inner pack/6 cards per outer pack
- E1204 sold uncarded
- Line striper adapter replaces bottle when tool is used with a 1/4" (6mm) hose, sold 1 per inner pack/1 per outer pack
- Line striper gasket come six per card, sold 6 cards per inner/outer pack



MARSHALLTOWN The Premier Line

| EDI | Part# | Description | Size |
|-------|-------|-----------------------|---------|
| 19683 | E1202 | Capped Bottle—Glass | 1/2 oz. |
| 19684 | E1203 | Capped Bottle—Plastic | 1 oz. |
| 19685 | E1204 | Capped Bottle—Glass | 4 oz. |
| 19686 | E1205 | Striper Adapter | N/A |
| 19687 | E1207 | Six Striper Gaskets | N/A |

Drywall Apprentice Tool Kit

- Tools included:
 - 831 - Canvas Tool Bag
 - 812 - 12" (35mm) Stainless Steel Mud Pan
 - JK8860 - 6" (152mm) Joint Knife
 - 3510D - 10 X 3" (254 X 76mm) DuraSoft® Blue Steel Taping Knife
 - 20D - 9 3/8 X 3 1/4" (238 X 83mm) DuraSoft® Hand Sander
 - SGDS32 - 15" (381mm) Drywall Saw
 - RW426 - Rock Warrior® Utility Saw
 - 9070 - Adjustable Utility Knife
- Sold 1 per inner pack/1 per outer pack



MARSHALLTOWN The Premier Line

| EDI | Part# | Size-in. | Size-mm |
|-------|-------|----------|---------|
| 15903 | DTK3 | N/A | N/A |

Drywall Apprentice Tool Kit

- Tools included:
 - NB202** - Nylon Tool Bag
 - 812** - 12" (35mm) Stainless Steel Mud Pan
 - JK8860** - 6" (152mm) Joint Knife
 - 3510D** - 10 X 3" (254 X 76mm) DuraSoft® Blue Steel Taping Knife
 - 20D** - 9³/₈ X 3¹/₄" (238 X 83mm) DuraSoft® Hand Sander
 - SGDS32** - 15" (381mm) Drywall Saw
 - RW426** - Rock Warrior® Utility Saw
 - 9070** - Adjustable Utility Knife
- Sold 1 per inner pack/1 per outer pack



MARSHALLTOWN The Premier Line

| EDI | Part# | Size-in. | Size-mm |
|-------|-------|----------|---------|
| 16206 | DTK4 | N/A | N/A |

Drywall Kit

- Kit contains:
 - 6158** - Hand Sander
 - CT292** - Corner Tool
 - TEK290** - Triple Edge Knife
- Kit also includes a plastic knife and a 10" (254mm) mud pan
- Components are shrink-wrapped together
- Sold 12 per inner pack/12 per outer pack



MADE IN
U.S.A

QLT BY MARSHALLTOWN

| EDI | Part# | Size-in. | Size-mm |
|-------|-------|----------|---------|
| 16296 | DK296 | N/A | N/A |

Drywall Kit

- Kit contains:
 - DWS467** - Drywall Sponge
 - CT292** - Corner Tool
 - TEK290** - Triple Edge Knife
- Kit also includes a plastic knife and a 10" (254mm) mud pan
- Components are shrink-wrapped together
- Sold 12 per inner pack/12 per outer pack



MADE IN
U.S.A

QLT BY MARSHALLTOWN

| EDI | Part# | Size-in. | Size-mm |
|-------|-------|----------|---------|
| 16298 | DK298 | N/A | N/A |

Square Notches

Notches are shown actual size

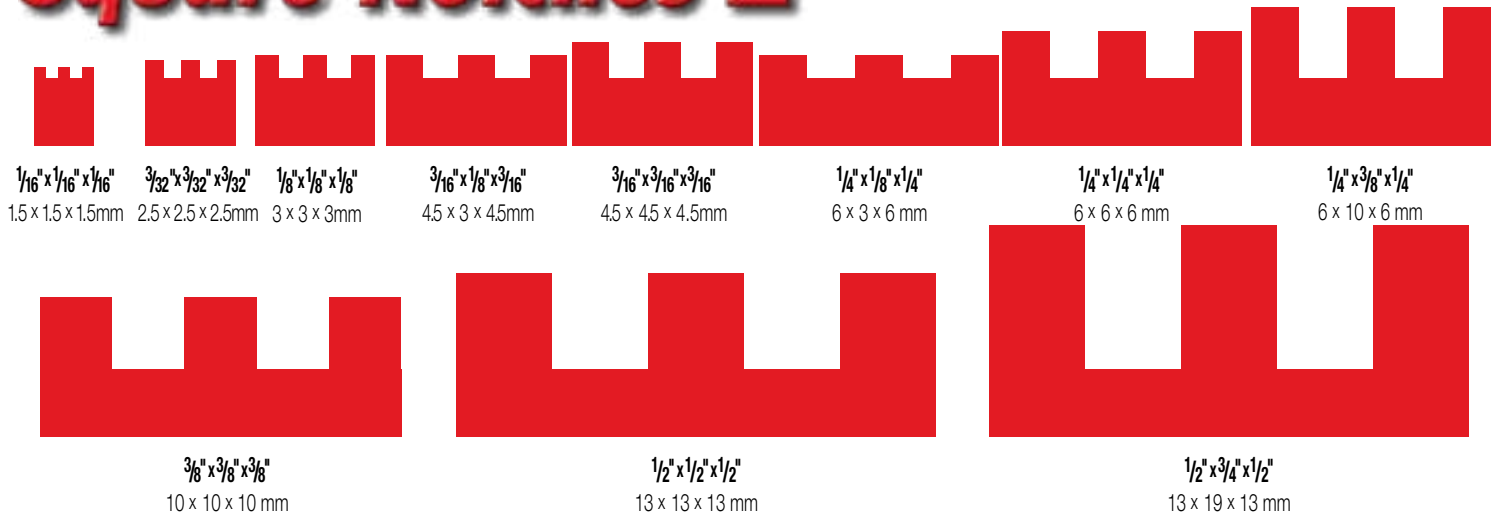

U Notches

Notches are shown actual size

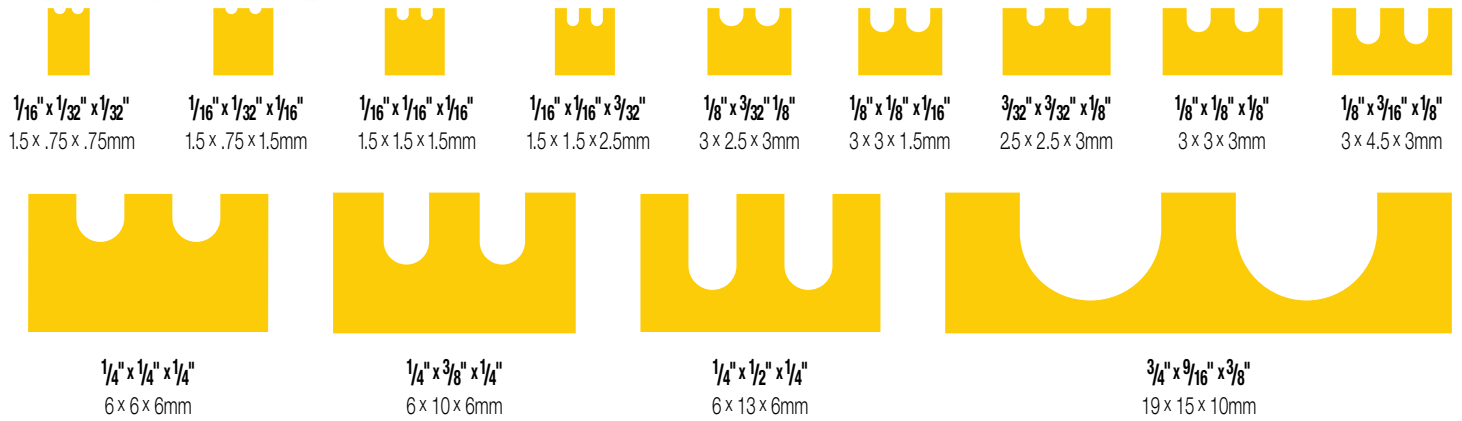

V Notches

Notches are shown actual size

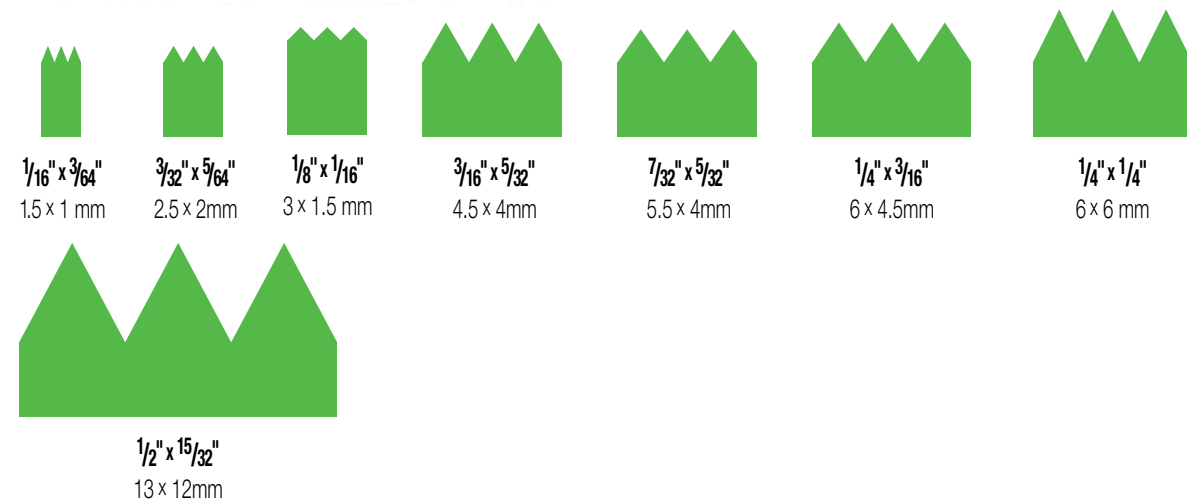

Flat V Notches

Notches are shown actual size

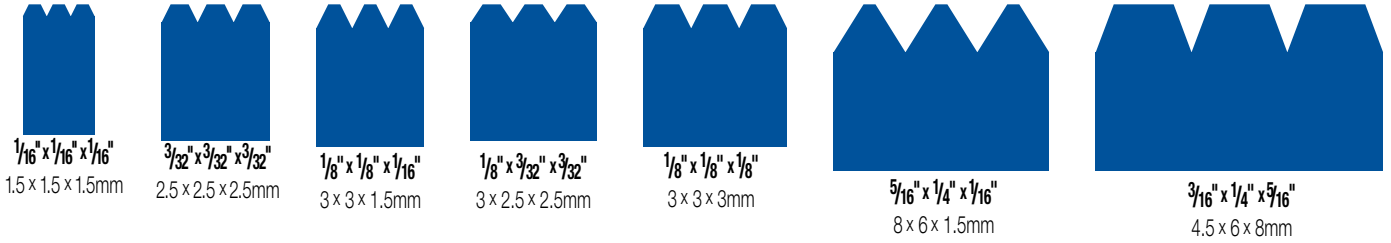

Elliptical Notches







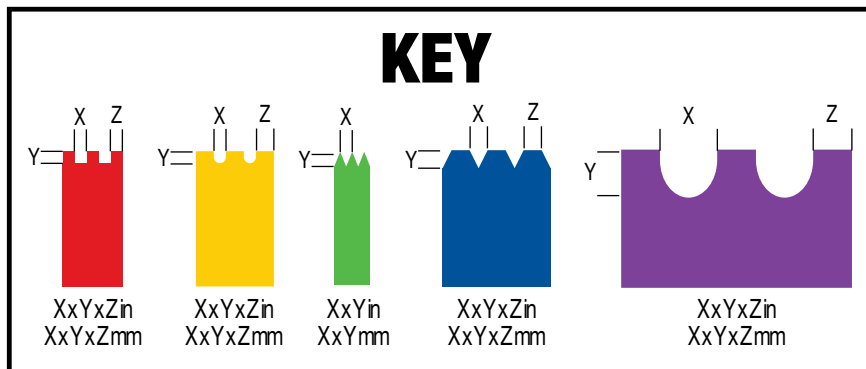



































Notches are shown actual size



Notch Dimensions Are: Notch Width(X) by Notch Depth(Y) by Space Between Notches (Z)



Recommended Notch Use Guide

| Notch Type | Notch Size-in. | Notch Size-mm | Uses |
|--|--|-----------------|---|
| Square  | $\frac{1}{16} \times \frac{1}{16} \times \frac{1}{16}$ | 1.5 x 1.5 x 1.5 | Carpet, Wall Tile, Vinyl |
| Square  | $\frac{3}{32} \times \frac{3}{32} \times \frac{3}{32}$ | 2.5 x 2.5 x 2.5 | Carpet, Wall Tile, Vinyl |
| Square  | $\frac{1}{8} \times \frac{1}{8} \times \frac{1}{8}$ | 3 x 3 x 3 | Small Ceramic Tile Floor, Carpet, Wall Tile |
| Square  | $\frac{3}{16} \times \frac{1}{8} \times \frac{3}{16}$ | 4.5 x 3 x 4.5 | Small Ceramic Tile Floor, Carpet, Wall Tile |
| Square  | $\frac{3}{16} \times \frac{3}{16} \times \frac{3}{16}$ | 4.5 x 4.5 x 4.5 | Small Ceramic Tile Floor, Metal Tile, Wall Tile, Mosaic |
| Square  | $\frac{1}{4} \times \frac{1}{8} \times \frac{1}{4}$ | 6 x 3 x 6 | Small Ceramic Tile Floor, Carpet, Wall Tile |
| Square  | $\frac{1}{4} \times \frac{1}{4} \times \frac{1}{4}$ | 6 x 6 x 6 | Medium Ceramic Tile Floor, Wall Tile |
| Square  | $\frac{1}{4} \times \frac{3}{8} \times \frac{1}{4}$ | 6 x 10 x 6 | Large Ceramic Tile Floor, Pavers |
| Square  | $\frac{3}{8} \times \frac{3}{8} \times \frac{3}{8}$ | 10 x 10 x 10 | Medium Ceramic Tile Floor, EIFS |
| Square  | $\frac{1}{2} \times \frac{1}{2} \times \frac{1}{2}$ | 13 x 13 x 13 | Large Ceramic Tile Floor, Pavers, EIFS |
| Square  | $\frac{1}{2} \times \frac{3}{4} \times \frac{1}{2}$ | 13 x 19 x 13 | Large Ceramic Tile Floor |
| U  | $\frac{1}{16} \times \frac{1}{32} \times \frac{1}{32}$ | 1.5 x .75 x .75 | Vinyl Sheet Goods, Carpet |
| U  | $\frac{1}{16} \times \frac{1}{32} \times \frac{1}{16}$ | 1.5 x .75 x 1.5 | Vinyl Sheet Goods, Light-Weight Flooring |
| U  | $\frac{1}{16} \times \frac{1}{16} \times \frac{1}{16}$ | 1.5 x 1.5 x 1.5 | Carpet, Wall Tile |
| U  | $\frac{1}{16} \times \frac{1}{16} \times \frac{3}{32}$ | 1.5 x 1.5 x 2.5 | Carpet, Wall Tile, Vinyl Sheet Goods |
| U  | $\frac{3}{32} \times \frac{3}{32} \times \frac{1}{8}$ | 2.5 x 2.5 x 3 | Carpet, Wall Tile, Vinyl |
| U  | $\frac{1}{8} \times \frac{3}{32} \times \frac{1}{8}$ | 3 x 2.5 x 3 | Wall Tile, Carpet, Vinyl |
| U  | $\frac{1}{8} \times \frac{1}{8} \times \frac{1}{16}$ | 3 x 3 x 1.5 | Small Ceramic Tile Floor, Carpet, Wall Tile |
| U  | $\frac{1}{8} \times \frac{1}{8} \times \frac{1}{8}$ | 3 x 3 x 3 | Carpet, Wall Tile, Mosaic |
| U  | $\frac{1}{8} \times \frac{3}{16} \times \frac{1}{8}$ | 3 x 4.5 x 3 | Small Ceramic Tile Floor, Carpet, Wall Tile |
| U  | $\frac{1}{4} \times \frac{1}{4} \times \frac{1}{4}$ | 6 x 6 x 6 | Medium Ceramic Tile Floor |
| U  | $\frac{1}{4} \times \frac{3}{8} \times \frac{1}{4}$ | 6 x 10 x 6 | Medium Ceramic Tile Floor, Wall Tile |
| U  | $\frac{1}{4} \times \frac{1}{2} \times \frac{1}{4}$ | 6 x 13 x 6 | Large Ceramic Tile Floor, Wall Tile |
| U  | $\frac{3}{4} \times \frac{9}{16} \times \frac{3}{8}$ | 19 x 14 x 10 | Large Ceramic Tile Floor, Marble Mortar |
| V  | $\frac{1}{16} \times \frac{3}{64}$ | 1.5 x 1 | Carpet, Wall Tile |
| V  | $\frac{3}{32} \times \frac{5}{64}$ | 2.5 x 2 | Carpet, Wall Tile |
| V  | $\frac{1}{8} \times \frac{1}{16}$ | 3 x 1.5 | Carpet, Wall Tile |
| V  | $\frac{1}{8} \times \frac{3}{32}$ | 3 x 2.5 | Wall Tile, Carpet, Vinyl |
| V  | $\frac{3}{16} \times \frac{5}{32}$ | 4.5 x 4 | Small Ceramic Tile Floor, Carpet, Wall Tile, Mosaic |
| V  | $\frac{7}{32} \times \frac{5}{32}$ | 5.5 x 4 | Small Ceramic Tile Floor, Carpet, Wall Tile |
| V  | $\frac{1}{4} \times \frac{3}{16}$ | 6 x 4.5 | Small Ceramic Tile Floor, Metal Tile, Wall Tile |
| V  | $\frac{1}{4} \times \frac{1}{4}$ | 6 x 6 | Small Ceramic Tile Floor, Metal Tile, Wall Tile |
| V  | $\frac{1}{2} \times \frac{15}{32}$ | 13 x 12 | Large Ceramic Tile Floor |
| Flat V  | $\frac{1}{16} \times \frac{1}{16} \times \frac{1}{16}$ | 1.5 x 1.5 x 1.5 | Vinyl, Carpet |
| Flat V  | $\frac{3}{32} \times \frac{3}{32} \times \frac{3}{32}$ | 2.5 x 2.5 x 2.5 | Carpet, Wall Tile |
| Flat V  | $\frac{1}{8} \times \frac{3}{32} \times \frac{3}{32}$ | 3 x 2.5 x 2.5 | Carpet, Wall Tile |
| Flat V  | $\frac{1}{8} \times \frac{1}{8} \times \frac{1}{16}$ | 3 x 3 x 1.5 | Carpet, Wall Tile |
| Flat V  | $\frac{1}{8} \times \frac{1}{8} \times \frac{1}{8}$ | 3 x 3 x 3 | Carpet, Wall Tile |
| Flat V  | $\frac{3}{16} \times \frac{1}{4} \times \frac{5}{16}$ | 4.5 x 6 x 8 | Carpet, Wall Tile |
| Flat V  | $\frac{5}{16} \times \frac{1}{4} \times \frac{1}{16}$ | 8 x 6 x 1.5 | Carpet, Wall Tile, Vinyl |
| Elliptical  | $\frac{5}{16} \times \frac{1}{4} \times \frac{3}{16}$ | 8 x 6 x 4.5 | Medium Ceramic Tile Floor |
| Elliptical  | $\frac{7}{16} \times \frac{3}{8} \times \frac{1}{4}$ | 11 x 10 x 6 | Medium Ceramic Tile Floor |
| Elliptical  | $\frac{3}{4} \times \frac{1}{2} \times \frac{1}{4}$ | 19 x 13 x 6 | Large Ceramic Tile Floor, Marble Mortar |

Standard & NTCA Approved Notched Trowels

- Aluminum alloy mounting riveted to a hard tempered steel blade
- Choice DuraSoft® or hardwood handle
- Blade size is 11 X 4½" (279 X 114mm)
- NTCA Approved Trowels indicated in table by *
- Sold 6 per inner pack/6 per outer pack



MADE IN U.S.A

U.S. Patent No. 5,522,111

MARSHALLTOWN The Premier Line

| EDI | Part# | Notch Size-in. | Notch Size-mm | Notch | Handle |
|-------|--------|--------------------|-----------------|-------|--------|
| 15722 | 706 | 3/32 X 3/32 X 3/32 | 2.5 x 2.5 x 2.5 | SQ | Red |
| 15724 | 706S | 3/32 X 3/32 X 3/32 | 2.5 x 2.5 x 2.5 | SQ | Red |
| 15725 | 706SD | 3/32 X 3/32 X 3/32 | 2.5 x 2.5 x 2.5 | SQ | Red |
| 15710 | 703 | 3/16 X 1/8 X 3/16 | 4.5 x 3 x 4.5 | SQ | Red |
| 15712 | 703S | 3/16 X 1/8 X 3/16 | 4.5 x 3 x 4.5 | SQ | Red |
| 15713 | 703SD | 3/16 X 1/8 X 3/16 | 4.5 x 3 x 4.5 | SQ | Red |
| 15706 | 702* | 1/4 X 1/4 X 1/4 | 6 x 6 x 6 | SQ | Red |
| 15708 | 702S* | 1/4 X 1/4 X 1/4 | 6 x 6 x 6 | SQ | Red |
| 15709 | 702SD* | 1/4 X 1/4 X 1/4 | 6 x 6 x 6 | SQ | Red |
| 15776 | 776S | 1/4 X 3/8 X 1/4 | 6 x 10 x 6 | SQ | Red |
| 15806 | 776SD | 1/4 X 3/8 X 1/4 | 6 x 10 x 6 | SQ | Red |
| 15779 | 5779S | 3/8 X 3/8 X 3/8 | 10 x 10 x 10 | SQ | Red |
| 15820 | 5779SD | 3/8 X 3/8 X 3/8 | 10 x 10 x 10 | SQ | Red |
| 15775 | 775S | 1/2 X 1/2 X 1/2 | 13 x 13 x 13 | SQ | Red |
| 15804 | 775SD | 1/2 X 1/2 X 1/2 | 13 x 13 x 13 | SQ | Red |
| 15781 | 781S | 1/2 X 3/4 X 1/2 | 13 x 19 x 13 | SQ | Red |
| 15782 | 781SD | 1/2 X 3/4 X 1/2 | 13 x 19 x 13 | SQ | Red |
| 15714 | 704 | 3/32 X 3/32 X 1/8 | 2.5 x 2.5 x 3 | U | Yellow |
| 15716 | 704S | 3/32 X 3/32 X 1/8 | 2.5 x 2.5 x 3 | U | Yellow |
| 15717 | 704SD | 3/32 X 3/32 X 1/8 | 2.5 x 2.5 x 3 | U | Yellow |
| 15732 | 718S | 1/4 X 1/4 X 1/4 | 6 x 6 x 6 | U | Yellow |
| 15733 | 718SD | 1/4 X 1/4 X 1/4 | 6 x 6 x 6 | U | Yellow |
| 15728 | 716S* | 1/4 X 3/8 X 1/4 | 6 x 10 x 6 | U | Yellow |
| 15729 | 716SD* | 1/4 X 3/8 X 1/4 | 6 x 10 x 6 | U | Yellow |
| 15730 | 717S* | 1/4 X 1/2 X 1/4 | 6 x 13 x 6 | U | Yellow |
| 15731 | 717SD* | 1/4 X 1/2 X 1/4 | 6 x 13 x 6 | U | Yellow |
| 15734 | 719S* | 3/4 X 9/16 X 3/8 | 19 x 14 x 9 | U | Yellow |
| 15735 | 719SD* | 3/4 X 9/16 X 3/8 | 19 x 14 x 9 | U | Yellow |
| 15702 | 701 | 7/32 X 5/32 | 5.5 x 4 | V | Green |
| 15704 | 701S | 7/32 X 5/32 | 5.5 x 4 | V | Green |
| 15705 | 701SD | 7/32 X 5/32 | 5.5 x 4 | V | Green |
| 15771 | 771S | 3/16 X 5/32 | 4.5 x 4 | V | Green |
| 15802 | 771SD* | 3/16 X 5/32 | 4.5 x 4 | V | Green |
| 15780 | 780S | 1/4 X 3/16 | 6 x 4.5 | V | Green |
| 15808 | 780SD | 1/4 X 3/16 | 6 x 4.5 | V | Green |
| 11170 | 779S | 1/4 X 1/4 | 6 x 6 | V | Green |
| 11171 | 779SD | 1/4 X 1/4 | 6 x 6 | V | Green |
| 15770 | 770S | 1/2 X 15/32 | 13 x 12 | V | Green |
| 15800 | 770SD | 1/2 X 15/32 | 13 x 12 | V | Green |

DuraNotch® Trowels

- DuraNotch® teeth are hard chrome plated to keep their shape longer than regular notched trowels
- Tempered steel blade
- Cast aluminum mounting
- Blade size is 11 X 4½" (279 X 114mm)
- Sold 1 per inner pack/12 per outer pack

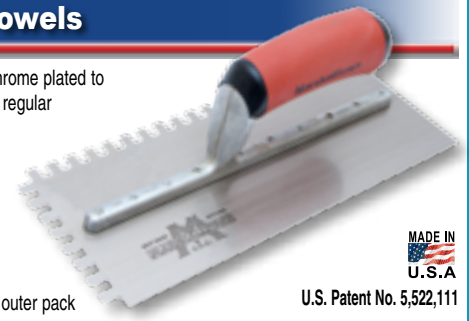

MADE IN U.S.A

U.S. Patent No. 5,522,111

MARSHALLTOWN The Premier Line

| EDI | Part# | Notch Size-in. | Notch Size-mm | Notch |
|-------|---------|-----------------|---------------|-------|
| 15840 | 776SDDN | 1/4 X 3/8 X 1/4 | 6 x 10 x 6 | SQ |
| 15848 | 716SDDN | 1/4 X 3/8 X 1/4 | 6 x 10 x 6 | U |
| 15850 | 717SDDN | 1/4 X 1/2 X 1/4 | 6 x 13 x 6 | U |
| 15842 | 780SDDN | 1/4 X 3/16 | 6 x 4.5 | V |

Left Handed Notched Trowel

- Aluminum alloy mounting riveted to a hard tempered steel blade
- Resilient DuraSoft® handle
- Blade size is 11 X 4½" (279 X 114mm)
- Sold 6 per inner pack/6 per outer pack



718SDL

MADE IN U.S.A

U.S. Patent No. 5,522,111

MARSHALLTOWN The Premier Line

| EDI | Part# | Notch Size-in. | Notch Size-mm | Notch |
|-------|--------|-----------------|---------------|-------|
| 15711 | 702SDL | 1/4 X 1/4 X 1/4 | 6 x 6 x 6 | SQ |
| 15757 | 775SDL | 1/2 X 1/2 X 1/2 | 13 x 13 x 13 | SQ |
| 15761 | 776SDL | 1/4 X 3/8 X 1/4 | 6 x 10 x 6 | SQ |
| 15739 | 718SDL | 1/4 X 1/4 X 1/4 | 6 x 6 x 6 | U |
| 15720 | 716SDL | 1/4 X 3/8 X 1/4 | 6 x 10 x 6 | U |
| 15721 | 717SDL | 1/4 X 1/2 X 1/4 | 6 x 13 x 6 | U |
| 15763 | 780SDL | 1/4 X 3/16 | 6 x 4.5 | V |

Elliptical Notched Trowels

- Aluminum alloy mounting riveted to a hard tempered steel blade
- Resilient DuraSoft® handle
- Blade size is 11 X 4½" (279 X 114mm)
- Sold 6 per inner pack/6 per outer pack



MADE IN
U.S.A

U.S. Patent No. 5,522,111

MARSHALLTOWN The Premier Line

| EDI | Part# | Notch Size-in. | Notch Size-mm | Notch |
|-------|-------|-------------------|---------------|---------|
| 15836 | 734SD | 5/16 X 1/4 X 3/16 | 8 x 6 x 4.5 | Ellipse |
| 15837 | 735SD | 7/16 X 3/8 X 1/4 | 11 x 10 x 6 | Ellipse |
| 15838 | 736SD | 3/4 X 1/2 X 1/4 | 19 x 13 x 6 | Ellipse |

Standard & Lefty Cut-Back Notched Trowels

- For resilient flooring and carpet
- Aluminum alloy mounting riveted to a hard tempered steel blade
- Blade has 10° cut-back for corners and tight places
- Blade size is 11 X 4½" (279 X 114mm)
- Resilient DuraSoft® handle provides a soft feel, reduces fatigue and offers excellent durability
- Sold 6 per inner pack/6 per outer pack

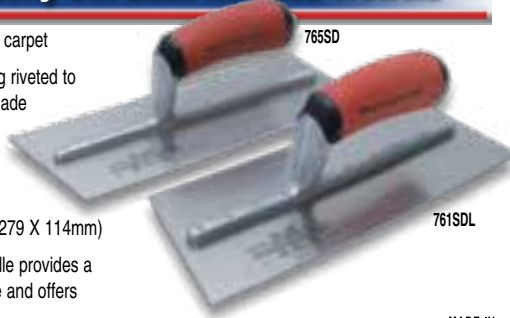

MADE IN
U.S.A

U.S. Patent No. 5,522,111

MARSHALLTOWN The Premier Line

| EDI | Part# | Notch Size-in. | Notch Size-mm | Notch |
|-------|-------|--------------------|-----------------|--------|
| 15875 | 761SD | 1/16 X 1/16 X 1/16 | 1.5 x 1.5 x 1.5 | SQ |
| 15887 | 767SD | 1/4 X 1/8 X 1/4 | 6 x 3 x 6 | SQ |
| 15885 | 766SD | 1/16 X 1/32 X 1/32 | 1.5 x .75 x .75 | U |
| 13694 | 664SD | 1/16 X 1/16 X 1/16 | 1.5 x 1.5 x 1.5 | U |
| 13692 | 663SD | 1/16 X 1/16 X 3/32 | 1.5 x 1.5 x 2.5 | U |
| 15891 | 769SD | 1/8 X 3/32 X 1/8 | 3 x 2.5 x 3 | U |
| 15877 | 762SD | 1/8 X 1/8 X 1/16 | 3 x 3 x 1.5 | U |
| 15889 | 768SD | 1/8 X 1/8 X 1/8 | 3 x 3 x 3 | U |
| 15881 | 764SD | 1/8 X 3/16 X 1/8 | 3 x 4.5 x 3 | U |
| 13690 | 662SD | 1/16 X 1/16 X 1/16 | 1.5 x 1.5 x 1.5 | Flat V |
| 15883 | 765SD | 3/32 X 3/32 X 3/32 | 2.5 x 2.5 x 2.5 | Flat V |
| 15879 | 763SD | 1/8 X 1/8 X 1/16 | 3 x 3 x 1.5 | Flat V |
| 13688 | 661SD | 1/8 X 1/8 X 1/8 | 3 x 3 x 3 | Flat V |

Left Handed Cut-Back

| EDI | Part# | Notch Size-in. | Notch Size-mm | Notch |
|-------|--------|--------------------|-----------------|--------|
| 15746 | 761SDL | 1/16 X 1/16 X 1/16 | 1.5 x 1.5 x 1.5 | SQ |
| 15753 | 766SDL | 1/16 X 1/32 X 1/32 | 1.5 x .75 x .75 | U |
| 15747 | 765SDL | 3/32 X 3/32 X 3/32 | 2.5 x 2.5 x 2.5 | Flat V |

Two & Three Sided Notched Trowels

- For resilient flooring and carpet
- Aluminum alloy mounting riveted to a hard tempered steel blade
- Three sided trowels notched on both sides and toe to lengthen useful life of the trowel
- Blade size is 16 X 4" (406 X 102mm)
- Resilient DuraSoft® handle provides a soft feel, reduces fatigue and offers excellent durability
- Three sided trowels are noted in table with *
- Trowels sold 4 per inner pack/4 per outer pack



MADE IN
U.S.A

U.S. Patent No. 5,522,111

MARSHALLTOWN The Premier Line

| EDI | Part# | Notch Size-in. | Notch Size-mm | Notch |
|-------|----------|--------------------|-----------------|--------|
| 13658 | 646SD | 1/16 X 1/16 X 1/16 | 1.5 x 1.5 x 1.5 | SQ |
| 13684 | DU659SD* | 1/16 X 1/16 X 1/16 | 1.5 x 1.5 x 1.5 | SQ |
| 13640 | 637SD | 1/4 X 1/8 X 1/4 | 6 x 3 x 6 | SQ |
| 13666 | DU650SD* | 1/4 X 1/8 X 1/4 | 6 x 3 x 6 | SQ |
| 15828 | 710SD | 1/4 X 1/4 X 1/4 | 6 x 6 x 6 | SQ |
| 15826 | 709SD | 1/4 X 3/8 X 1/4 | 6 x 10 x 6 | SQ |
| 15830 | 711SD | 1/2 X 1/2 X 1/2 | 13 x 13 x 13 | SQ |
| 13660 | 647SD | 1/16 X 1/32 X 1/32 | 1.5 x .75 x .75 | U |
| 13686 | DU660SD* | 1/16 X 1/32 X 1/32 | 1.5 x .75 x .75 | U |
| 13656 | 645SD | 1/16 X 1/16 X 1/16 | 1.5 x 1.5 x 1.5 | U |
| 13682 | DU658SD* | 1/16 X 1/16 X 1/16 | 1.5 x 1.5 x 1.5 | U |
| 13654 | 644SD | 1/16 X 1/16 X 3/32 | 1.5 x 1.5 x 2.5 | U |
| 13680 | DU657SD* | 1/16 X 1/16 X 3/32 | 1.5 x 1.5 x 2.5 | U |
| 13644 | 639SD | 1/8 X 3/32 X 1/8 | 3 x 2.5 x 3 | U |
| 13670 | DU652SD* | 1/8 X 3/32 X 1/8 | 3 x 2.5 x 3 | U |
| 13648 | 641SD | 1/8 X 1/8 X 1/16 | 3 x 3 x 1.5 | U |
| 13674 | DU654SD* | 1/8 X 1/8 X 1/16 | 3 x 3 x 1.5 | U |
| 13646 | 640SD | 1/8 X 1/8 X 1/8 | 3 x 3 x 3 | U |
| 13672 | DU653SD* | 1/8 X 1/8 X 1/8 | 3 x 3 x 3 | U |
| 13642 | 638SD | 1/8 X 3/16 X 1/8 | 3 x 4.5 x 3 | U |
| 13668 | DU651SD* | 1/8 X 3/16 X 1/8 | 3 x 4.5 x 3 | U |
| 15824 | 708SD | 1/4 X 3/16 | 6 x 4.5 | V |
| 13652 | 643SD | 1/16 X 1/16 X 1/16 | 1.5 x 1.5 x 1.5 | Flat V |
| 13678 | DU656SD* | 1/16 X 1/16 X 1/16 | 1.5 x 1.5 x 1.5 | Flat V |
| 13638 | 636SD | 3/32 X 3/32 X 3/32 | 2.5 x 2.5 x 2.5 | Flat V |
| 13664 | DU649SD* | 3/32 X 3/32 X 3/32 | 2.5 x 2.5 x 2.5 | Flat V |
| 13636 | 635SD | 1/8 X 1/8 X 1/16 | 3 x 3 x 1.5 | Flat V |
| 13662 | DU648SD* | 1/8 X 1/8 X 1/16 | 3 x 3 x 1.5 | Flat V |
| 13650 | 642SD | 1/8 X 1/8 X 1/8 | 3 x 3 x 3 | Flat V |
| 13676 | DU655SD* | 1/8 X 1/8 X 1/8 | 3 x 3 x 3 | Flat V |

Narrow Notched Trowel

- Blade size is 10½ X 3³⁄₁₆" (267 X 86mm); front is angle cut back 10°
- Resilient DuraSoft® handle provides a soft feel and reduces fatigue
- Blade is narrow enough to permit work under toe spaces
- Sold 6 per inner pack/6 per outer pack



MADE IN
U.S.A

U.S. Patent No. 5,522,111

MARSHALLTOWN The Premier Line

| EDI | Part# | Notch Size-in. | Notch Size-mm | Notch |
|-------|-------|----------------|---------------|----------|
| 15719 | 705SD | ¼ x ⅜ x ⅜ | 3 x 2.5 x 2.5 | Flat V ▼ |

Soft Grip Notched Trowels

- Aluminum alloy mounting riveted to a hard tempered steel blade
- Soft grip handle
- Blade sizes are 11 X 4½" (279 X 114mm), or 16 X 4" (406 X 102mm) where noted with *
- Sold 6 per inner pack/36 per outer pack



NT672

QLT MARSHALLTOWN

| EDI | Part# | Notch Size-in. | Notch Size-mm | Notch |
|-------|--------|----------------|-----------------|----------|
| 15669 | NT669 | ⅛ x ⅛ x ⅛ | 1.5 x 1.5 x 1.5 | SQ ■ |
| 15692 | NT692* | ⅛ x ⅛ x ⅛ | 1.5 x 1.5 x 1.5 | SQ ■ |
| 15673 | NT673 | ⅜ x ⅜ x ⅜ | 2.5 x 2.5 x 2.5 | SQ ■ |
| 15674 | NT674 | ⅜ x ⅜ x ⅜ | 4.5 x 3 x 4.5 | SQ ■ |
| 15675 | NT675 | ⅜ x ⅜ x ⅜ | 4.5 x 4.5 x 4.5 | SQ ■ |
| 15671 | NT671 | ¼ x ¼ x ¼ | 6 x 6 x 6 | SQ ■ |
| 15697 | NT697* | ¼ x ¼ x ¼ | 6 x 6 x 6 | SQ ■ |
| 15793 | NT793 | ¼ x ⅜ x ¼ | 6 x 3 x 6 | SQ ■ |
| 15672 | NT672 | ¼ x ⅜ x ¼ | 6 x 10 x 6 | SQ ■ |
| 15698 | NT698* | ¼ x ⅜ x ¼ | 6 x 10 x 6 | SQ ■ |
| 15670 | NT670 | ½ x ½ x ½ | 13 x 13 x 13 | SQ ■ |
| 15696 | NT696* | ½ x ½ x ½ | 13 x 13 x 13 | SQ ■ |
| 15684 | NT684 | ⅛ x ⅜ x ⅜ | 1.5 x .75 x .75 | U ☺ |
| 15695 | NT695* | ⅛ x ⅜ x ⅜ | 1.5 x .75 x .75 | U ☺ |
| 15688 | NT688 | ⅛ x ⅜ x ⅜ | 1.5 x .75 x 1.5 | U ☺ |
| 15690 | NT690 | ⅜ x ⅜ x ⅜ | 3 x 3 x 3 | U ☺ |
| 15687 | NT687 | ⅜ x ⅜ x ⅜ | 3 x 4.5 x 3 | U ☺ |
| 15689 | NT689 | ¼ x ¼ x ¼ | 6 x 6 x 6 | U ☺ |
| 15686 | NT686 | ¼ x ⅜ x ¼ | 6 x 10 x 6 | U ☺ |
| 15685 | NT685 | ¼ x ½ x ¼ | 6 x 13 x 6 | U ☺ |
| 15691 | NT691 | ¾ x ⅜ x ¾ | 19 x 14 x 10 | U ☺ |
| 15677 | NT677 | ⅜ x ⅜ | 4.5 x 4 | V ▼ |
| 15679 | NT679 | ⅜ x ⅜ | 5.5 x 4 | V ▼ |
| 15676 | NT676 | ¼ x ⅜ | 6 x 4.5 | V ▼ |
| 15699 | NT699* | ¼ x ⅜ | 6 x 4.5 | V ▼ |
| 15678 | NT678 | ½ x 1½ | 13 x 12 | V ▼ |
| 15681 | NT681 | ⅜ x ⅜ x ⅜ | 2.5 x 2.5 x 2.5 | Flat V ▼ |
| 15694 | NT694* | ⅜ x ⅜ x ⅜ | 2.5 x 2.5 x 2.5 | Flat V ▼ |
| 15680 | NT680 | ⅜ x ⅜ x ⅜ | 3 x 3 x 1.5 | Flat V ▼ |
| 15693 | NT693* | ⅜ x ⅜ x ⅜ | 3 x 3 x 1.5 | Flat V ▼ |
| 15683 | NT683 | ⅜ x ¼ x ⅜ | 8 x 6 x 1.5 | Flat V ▼ |
| 15682 | NT682 | ⅜ x ¼ x ⅜ | 4.5 x 6 x 8 | Flat V ▼ |

Notched Trowels

- Aluminum alloy mounting riveted to a hard tempered steel blade
- Curved smooth hardwood handle
- Blade size is 11 X 4½" (279 X 114mm)
- Sold 6 per inner pack/6 per outer pack

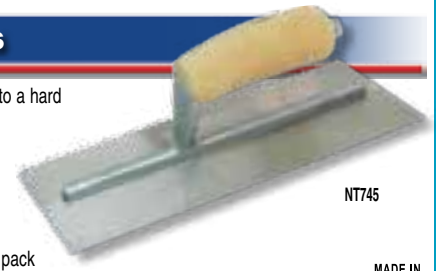

NT745

MADE IN
U.S.A

QLT MARSHALLTOWN

| EDI | Part# | Notch Size-in. | Notch Size-mm | Notch |
|-------|-------|----------------|---------------|-------|
| 17937 | NT747 | ¼ x ¼ x ¼ | 6 x 6 x 6 | SQ ■ |
| 17938 | NT748 | ½ x ½ x ½ | 13 x 13 x 13 | SQ ■ |
| 17935 | NT745 | ⅜ x ⅜ | 4.5 x 4 | V ▼ |
| 17936 | NT746 | ¼ x ⅜ | 6 x 4.5 | V ▼ |

Notched Trowels

- Aluminum alloy mounting riveted to a hard tempered steel blade
- Curved smooth hardwood handle
- Blade size is 11 X 4½" (279 X 114mm)
- Sold 12 per inner pack/60 per outer pack



NT973

QLT MARSHALLTOWN

| EDI | Part# | Notch Size-in. | Notch Size-mm | Notch |
|-------|-------|----------------|-----------------|-------|
| 15857 | NT972 | ⅛ x ⅛ x ⅛ | 1.5 x 1.5 x 1.5 | SQ ■ |
| 15862 | NT974 | ⅜ x ⅜ x ⅜ | 4.5 x 4.5 x 4.5 | SQ ■ |
| 15856 | NT973 | ¼ x ¼ x ¼ | 6 x 6 x 6 | SQ ■ |
| 15858 | NT976 | ¼ x ⅜ x ¼ | 6 x 10 x 6 | SQ ■ |
| 15860 | NT975 | ½ x ½ x ½ | 13 x 13 x 13 | SQ ■ |
| 15855 | NT971 | ⅜ x ⅜ | 4.5 x 4 | V ▼ |
| 15859 | NT981 | ¼ x ⅜ | 6 x 4.5 | V ▼ |
| 15861 | NT970 | ½ x 1½ | 13 x 12 | V ▼ |

Cut-Back Notched Trowels

- Aluminum alloy mounting riveted to a hard tempered steel blade
- 11 X 4½" (279 X 114mm) with a 10° cutback
- Soft grip handle for extra comfort and grip
- Sold 6 per inner pack/36 per outer pack



NT794

QLT MARSHALLTOWN

| EDI | Part# | Notch Size-in. | Notch Size-mm | Notch |
|-------|-------|----------------|-----------------|----------|
| 15794 | NT794 | ⅜ x ⅜ x ⅜ | 3 x 3 x 3 | SQ ■ |
| 15803 | NT803 | ⅛ x ⅛ x ⅛ | 1.5 x 1.5 x 1.5 | SQ ■ |
| 15805 | NT805 | ⅜ x ⅜ | 4.5 x 4 | V ▼ |
| 15811 | NT811 | ⅜ x ⅜ x ⅜ | 3 x 3 x 1.5 | Flat V ▼ |
| 15813 | NT813 | ⅜ x ⅜ x ⅜ | 2.5 x 2.5 x 2.5 | Flat V ▼ |
| 15815 | NT815 | ⅜ x ⅜ x ⅜ | 1.5 x .75 x .75 | U ☺ |

Cut-Back Notched Trowels

- Feature a 10° cut back blade on front end
- Aluminum alloy mounting riveted to a hard tempered steel blade
- Curved smooth hardwood handle
- Blade size is 11 X 4½" (279 X 114mm)
- Sold 12 per inner pack/60 per outer pack



NT995

QLT BY MARSHALLTOWN

| EDI | Part# | Notch Size-in. | Notch Size-mm | Notch |
|-------|-------|--------------------|-----------------|----------|
| 15892 | NT991 | 1/16 X 1/16 X 1/16 | 1.5 x 1.5 x 1.5 | SQ ■ |
| 15898 | NT997 | 1/4 X 1/8 X 1/4 | 6 x 3 x 6 | SQ ■ |
| 15897 | NT996 | 1/16 X 1/32 X 1/32 | 1.5 x .75 x .75 | U ● |
| 15893 | NT992 | 1/8 X 1/8 X 1/16 | 3 x 3 x 1.5 | U ● |
| 15900 | NT999 | 1/8 X 3/32 X 1/8 | 3 x 2.5 x 3 | U ● |
| 15899 | NT998 | 1/8 X 1/8 X 1/8 | 3 x 3 x 3 | U ● |
| 15895 | NT994 | 1/8 X 3/16 X 1/8 | 3 x 4.5 x 3 | U ● |
| 15896 | NT995 | 3/32 X 3/32 X 3/32 | 2.5 x 2.5 x 2.5 | Flat V ▼ |
| 15894 | NT993 | 1/8 X 1/8 X 1/16 | 3 x 3 x 1.5 | Flat V ▼ |

Notched Trowels

- Aluminum alloy mounting riveted to a hard tempered steel blade
- Smooth wood handle slightly curved
- Blade size is 11 X 4½" (279 X 114mm)
- Sold 6 per inner pack/60 per outer pack



971

QLT BY MARSHALLTOWN

| EDI | Part# | Notch Size-in. | Notch Size-mm | Notch |
|-------|-------|--------------------|-----------------|-------|
| 16172 | 972 | 1/16 X 1/16 X 1/16 | 1.5 x 1.5 x 1.5 | SQ ■ |
| 16175 | 974 | 3/16 X 3/16 X 3/16 | 4.5 x 4.5 x 4.5 | SQ ■ |
| 16173 | 973 | 1/4 X 1/4 X 1/4 | 6 x 6 x 6 | SQ ■ |
| 16179 | 976 | 1/4 X 3/8 X 1/4 | 6 x 10 x 6 | SQ ■ |
| 16177 | 975 | 1/2 X 1/2 X 1/2 | 13 x 13 x 13 | SQ ■ |
| 16178 | 981 | 1/16 X 1/16 X 1/16 | 1.5 x 1.5 x 1.5 | U ● |
| 16171 | 971 | 3/16 X 3/32 | 4.5 x 4 | V ▼ |
| 16168 | 970 | 1/2 X 15/32 | 13 x 12 | V ▼ |

Cut-Back Notched Trowels

- Feature a 10° cut back blade on front end
- Aluminum alloy mounting riveted to a blue steel blade
- Smooth hardwood handle, slightly curved
- Blade size is 16 X 4" (406 X 102mm)
- **NT980** blade size is 11 X 4½" (279 X 114mm)
- Sold 6 per inner pack/36 per outer pack, NT980 sold 12 per inner pack/36 per outer pack

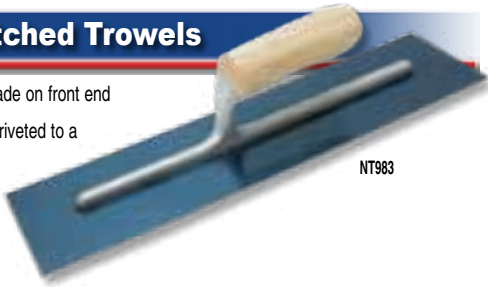

NT983

QLT BY MARSHALLTOWN

| EDI | Part# | Notch Size-in. | Notch Size-mm | Notch |
|-------|-------|--------------------|-----------------|----------|
| 15852 | NT982 | 1/16 X 1/16 X 1/16 | 1.5 x 1.5 x 1.5 | SQ ■ |
| 15854 | NT984 | 1/16 X 1/32 X 1/32 | 1.5 x .75 x .75 | U ● |
| 15864 | NT986 | 1/8 X 3/32 X 1/8 | 3 x 2.5 x 3 | U ● |
| 15853 | NT983 | 3/32 X 3/32 X 3/32 | 2.5 x 2.5 x 2.5 | Flat V ▼ |
| 15863 | NT985 | 1/8 X 1/8 X 1/16 | 3 x 3 x 1.5 | Flat V ▼ |
| 15865 | NT980 | 3/16 X 1/4 X 5/16 | 4.5 x 6 x 8 | Flat V ▼ |

Plastic Notched Trowels

- Dual edged for use with bonding and floor tile adhesives
- Excellent for installing radiant floor heating elements
- Non-conductive plastic blade & handle
- Won't rust or corrode; easy to clean
- Blade size is 11 X 5½" (279 X 140mm)
- Sold 10 per inner pack/60 per outer pack

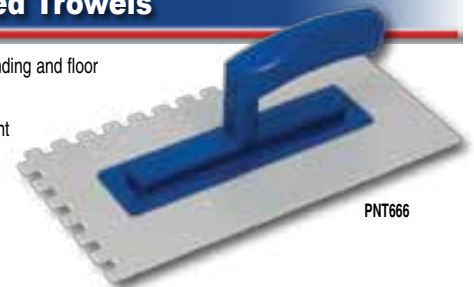

PNT666

QLT BY MARSHALLTOWN

| EDI | Part# | Notch Size-in. | Notch Size-mm | Notch |
|-------|--------|-----------------|---------------|-------|
| 10666 | PNT666 | 1/4 X 1/4 X 1/4 | 6 x 6 x 6 | SQ ■ |
| 10667 | PNT667 | 7/8 X 7/8 X 7/8 | 10 x 10 x 10 | SQ ■ |

Plastic Notched Trowels

- All plastic blade measures 9½ X 4¼" (241 X 108mm)
- "V" notched and angled for either right or left hand use
- Sold 36 per inner pack/36 per outer pack



6261

MADE IN U.S.A.

QLT BY MARSHALLTOWN

| EDI | Part# | Notch Size-in. | Notch Size-mm | Notch |
|-------|-------|----------------|---------------|-------|
| 16274 | 6274 | 1/16 X 1/16 | 1.5 x 1.5 | V ▼ |
| 16260 | 6260 | 3/32 X 3/32 | 2.5 x 2.5 | V ▼ |
| 16261 | 6261 | 1/8 X 1/8 | 3 x 3 | V ▼ |
| 16262 | 6262 | 3/16 X 3/16 | 4.5 x 4.5 | V ▼ |
| 16275 | 6275 | 1/4 X 1/4 | 6 x 6 | V ▼ |
| 16263 | 6263 | 3/8 X 3/8 | 10 x 10 | V ▼ |

Mixers

- For our complete line of mixers, details and size options

see pages 163-164

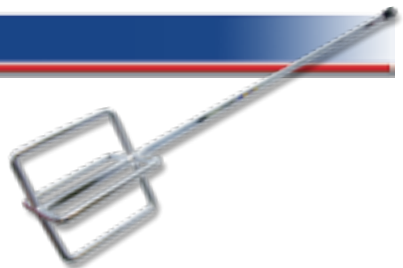

Notched Trowels

- Black plastic handle with full hard steel blade
- 10° angle indicated with*
- All 9 X 4" (229 x 102mm) Notched trowels are dual notched except **206 & 242**
- Sold 12 per inner pack/12 per outer pack, sold 24 per inner pack where noted with**



QLT BY MARSHALLTOWN

Blade Size 11 X 4½" (279 X 114mm)

| EDI | Part# | Notch Size-in. | Notch Size-mm | Notch |
|-------|-------|--------------------|-----------------|----------|
| 16255 | 222 | 1/16 X 1/16 X 1/16 | 1.5 x 1.5 x 1.5 | SQ ■ |
| 16259 | 226 | 1/4 X 1/4 X 1/4 | 6 x 6 x 6 | SQ ■ |
| 16254 | 221 | 1/16 X 1/32 X 1/16 | 1.5 x .75 x 1.5 | U ● |
| 16257 | 224 | 3/16 X 5/32 | 4.5 x 4 | V ▼ |
| 16258 | 225 | 1/4 X 3/16 | 6 x 4.5 | V ▼ |
| 16256 | 223 | 1/8 X 1/8 X 1/16 | 3 x 3 x 1.5 | Flat V ▼ |

Blade Size 9 X 4" (229 X 102mm)

| EDI | Part# | Notch Size-in. | Notch Size-mm | Notch |
|-------|---------|--------------------|-----------------|----------|
| 16250 | 206* | 3/16 X 5/32 | 4.5 x 4 | V ▼ |
| 16251 | 207* | 1/4 X 1/4 X 1/4 | 6 x 6 x 6 | SQ ■ |
| | | 1/4 X 3/16 | 6 x 4.5 | V ▼ |
| 15518 | 207-1** | 1/4 X 1/4 X 1/4 | 6 x 6 x 6 | SQ ■ |
| | | 1/4 X 3/16 | 6 x 4.5 | V ▼ |
| 16252 | 208* | 1/16 X 1/16 X 1/16 | 1.5 x 1.5 x 1.5 | SQ ■ |
| | | 1/16 X 1/32 X 1/16 | 1.5 x .75 x 1.5 | U ● |
| 15519 | 208-1** | 1/16 X 1/16 X 1/16 | 1.5 x 1.5 x 1.5 | SQ ■ |
| | | 1/16 X 1/32 X 1/16 | 1.5 x .75 x 1.5 | U ● |
| 16220 | 220* | 1/8 X 1/8 X 1/16 | 3 x 3 x 1.5 | Flat V ▼ |
| | | 1/8 X 1/8 X 1/8 | 3 x 3 x 3 | SQ ■ |
| 16234 | 234* | 1/16 X 1/32 X 1/32 | 1.5 x .75 x .75 | U ● |
| | | 3/32 X 3/32 X 3/32 | 2 x 2 x 2 | Flat V ▼ |
| 16236 | 236* | 3/32 X 3/32 X 3/32 | 2 x 2 x 2 | SQ ■ |
| | | 1/8 X 3/16 X 1/8 | 3 x 1.5 x 3 | U ● |
| 16238 | 238* | 1/8 X 1/8 X 1/8 | 3 x 3 x 3 | U ● |
| | | 3/16 X 1/4 X 3/16 | 4.5 x 6 x 8 | Flat V ▼ |
| 16239 | 239* | 1/4 X 3/8 X 1/4 | 6 x 10 x 6 | SQ ■ |
| | | 1/4 X 1/2 X 1/4 | 6 x 13 x 6 | U ● |
| 16240 | 240* | 1/4 X 3/8 X 1/4 | 6 x 10 x 6 | U ● |
| | | 1/2 X 1/2 X 1/2 | 13 x 13 x 13 | SQ ■ |
| 18639 | 242 | 1/8 X 1/8 X 1/2 | 3 x 3 x 13 | Flat V ▼ |

MADE IN U.S.A.

Notched Spreaders

- Made of galvanized material to prevent rust
- Blade is ribbed for rigidity and strength
- Size is 6 X 4" (152 X 102mm)
- Sold 100 per inner pack/100 per outer pack



QLT BY MARSHALLTOWN

| EDI | Part# | Notch Size-in. | Notch Size-mm | Notch |
|-------|-------|--------------------|-----------------|-------|
| 15810 | 977 | 1/16 X 1/16 X 1/16 | 1.5 x 1.5 x 1.5 | SQ ■ |
| 15814 | 979 | 1/16 X 1/32 X 1/32 | 1.5 x .75 x .75 | U ● |
| 15812 | 978 | 3/16 X 5/32 | 4.5 x 4 | V ▼ |
| 15816 | 980 | 1/4 X 3/16 | 6 x 4.5 | V ▼ |

Plastic Notched Spreaders

- Multi-use spreader/scrapper
- Won't rust or corrode
- Each side has a different notch size
- Sold 45 per inner pack/135 per outer pack



QLT BY MARSHALLTOWN

| EDI | Part# | Notch Size-in. | Notch Size-mm | Notch |
|-------|-------|--------------------------------------|-----------------------------|-------|
| 16286 | 6286 | 1/8 X 1/16; 3/16 X 5/32; | 3 x 1.5; 4.5 x 4; | V ▼ |
| | | 1/4 X 3/16; Tapered Edge | 6 x 4.5; Tapered Edge | |
| 16287 | 6287 | 1/16 X 1/16 X 1/16; 1/8 X 1/8 X 1/8; | 1.5 x 1.5 x 1.5; 3 x 3 x 3; | SQ ■ |
| | | 1/4 X 1/4 X 1/4; 1/4 X 1/8 X 1/4 | 6 x 6 x 6; 6 x 3 x 6 | |

Plastic Notched Spreaders

- Won't rust or corrode
- Blade width is 3" (76mm)
- Used to apply adhesives quickly and easily
- Sold 36 per inner pack/288 per outer pack



QLT BY MARSHALLTOWN

| EDI | Part# | Notch Size-in. | Notch Size-mm | Notch |
|-------|---------|--------------------|-----------------|-------|
| 16956 | PNS116S | 1/16 X 1/16 X 1/16 | 1.5 x 1.5 x 1.5 | SQ ■ |
| 16953 | PNS18V | 1/8 X 1/8 | 3 x 3 | V ▼ |
| 16952 | PNS332V | 3/32 X 3/32 | 2 x 2 | V ▼ |
| 16954 | PNS316V | 3/16 X 3/16 | 4.5 x 4.5 | V ▼ |
| 16955 | PNS14V | 1/4 X 1/4 | 6 x 6 | V ▼ |

Notched Margin Trowels

- Forged from a single piece of highest grade tool steel
- Tempered, ground and polished from toe to heel
- Available with hardwood or DuraSoft® handle
- Blade size is 5 X 2" (127 X 51mm)
- Sold 6 per inner pack/6 per outer pack

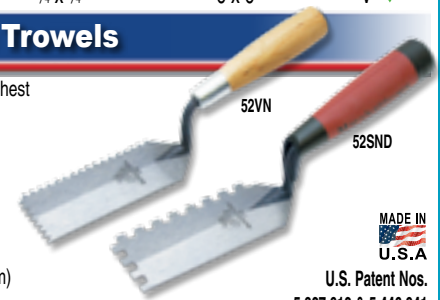

MADE IN U.S.A.

U.S. Patent Nos. 5,327,612 & 5,446,941

MARSHALLTOWN The Premier Line

| EDI | Part# | Notch Size-in. | Notch Size-mm | Notch | Handle |
|-------|-------|-----------------|---------------|-------|--------|
| 11200 | 52SN | 1/4 X 1/4 X 1/4 | 6 x 6 x 6 | SQ ■ | |
| 11190 | 52SND | 1/4 X 1/4 X 1/4 | 6 x 6 x 6 | SQ ■ | |
| 11201 | 52VN | 1/4 X 3/16 | 6 x 4.5 | V ▼ | |
| 11192 | 52VND | 1/4 X 3/16 | 6 x 4.5 | V ▼ | |

Tile Grouter's Floats

- Pure gum rubber face is bonded to the dense rubber pad; cemented to an aluminum backing plate with a smooth handle
- Edges are beveled and the two front corners are rounded
- Dense rubber pad is designed specifically for tile grouting
- **43BC** has an offset handle for base/cove work
- Sold 1 per inner pack/24 per outer pack, 43XL sold 12 per outer pack



ASSEMBLED
IN U.S.A.

MARSHALLTOWN The Premier Line

| EDI | Part# | Size-in. | Size-mm |
|-------|-------|----------|-----------|
| 14422 | 43 | 9 X 4 | 229 X 102 |
| 14423 | 43XL | 12 X 4 | 305 X 102 |
| 14425 | 43BC | 12 X 3 | 305 X 76 |

Tile Grouter's Margin Float

- Pure gum rubber face is bonded to the dense rubber pad; cemented to a tempered steel blade with a soft grip handle
- Edges are beveled
- Dense rubber pad is designed specifically for tile grouting
- Sold 1 per inner pack/6 per outer pack



QLT[®] MARSHALLTOWN

| EDI | Part# | Size-in. | Size-mm |
|-------|-------|----------|----------|
| 14454 | MF54 | 6 X 2 | 152 X 51 |

Tile Grouter's Float

- Pure gum rubber face is bonded to the dense rubber pad; tempered steel blade with a soft grip handle
- Edges are beveled
- Specifically for tile grouting
- Sold 1 per inner pack/6 per outer pack



QLT[®] MARSHALLTOWN

| EDI | Part# | Size-in. | Size-mm |
|-------|-------|----------|-----------|
| 19286 | GF248 | 9 X 4 | 229 X 102 |

Tile Grouter's Float

- Pure gum rubber face is bonded to the dense rubber pad; cemented to an aluminum backing plate with a smooth handle
- Edges are beveled and the two front corners are rounded for ease of spreading
- Dense rubber pad is designed specifically for tile grouting
- Sold 1 per inner pack/24 per outer pack



MADE IN
U.S.A.

QLT[®] MARSHALLTOWN

| EDI | Part# | Size-in. | Size-mm |
|-------|-------|----------|-----------|
| 14421 | 43A | 8½ X 4 | 216 X 102 |

Grout Float

- Plastic blade
- Foam pad is ¼" (6mm) thick
- Sold 24 per inner pack/24 per outer pack



MADE IN
U.S.A.

QLT[®] MARSHALLTOWN

| EDI | Part# | Size-in. | Size-mm |
|-------|-------|----------|-----------|
| 16266 | 6266 | 9½ X 4¼ | 241 X 108 |

Grout Float

- All plastic handle and backing plate - won't scratch tile
- Foam rubber pad for all types of grout, including epoxy grout
- Easy clean-up
- Sold 10 per inner pack/60 per outer pack



MADE IN
U.S.A.

QLT[®] MARSHALLTOWN

| EDI | Part# | Size-in. | Size-mm |
|-------|-------|----------|----------|
| 15247 | GF247 | 9 X 3¼ | 229 X 83 |

Epoxy Floats

- Pads are harder and stiffer for demanding applications
- Edges are beveled and front two corners are rounded
- Plastic backing plate is recessed to prevent scraping
- **EF88D** has offset handle and narrow plate for working in tight places
- Sold 1 per inner pack/6 per outer pack



MADE IN
U.S.A.

MARSHALLTOWN The Premier Line

| EDI | Part# | Blade Size-in. | Blade Size-mm |
|-------|-------|----------------|---------------|
| 12187 | EF87D | 10 X 4 | 254 X 102 |
| 12188 | EF88D | 12 ¾ X 3 | 324 X 76 |

Epoxy Float

- Edges of the hardened pad can be resharpened to prolong use
- Dense green rubber pad works well with tough to spread epoxy and sanded grouts
- Can be used for both grouting and cleaning tile
- Sold 1 per inner pack/24 per outer pack



ASSEMBLED
IN U.S.A.

MARSHALLTOWN The Premier Line

| EDI | Part# | Size-in. | Size-mm |
|-------|-------|----------|-----------|
| 14427 | GF43 | 9 X 4 | 229 X 102 |

Neoprene Floats

- Aluminum backing plate is bonded to the non-porous neoprene pad
- 49XH has a heavy duty backing plate
- Pad is 1/4" (6mm) thick
- Sold 1 per inner pack/12 per outer pack



ASSEMBLED
IN U.S.A.

MARSHALLTOWN The Premier Line

| EDI | Part# | Size-in. | Size-mm |
|-------|-------|----------|-----------|
| 14424 | 49 | 12 X 4 | 305 X 102 |
| 14434 | 49L | 12 X 5 | 305 X 127 |
| 14435 | 49XH | 12 X 5 | 305 X 127 |

Molded Rubber Float

- Black sponge rubber pad has beveled edges and rounded front corners
- Plastic backing plate is recessed to prevent scraping
- DuraSoft® handle provides a soft feel, reduces fatigue and offers excellent durability
- Sold 1 per inner pack/6 per outer pack



MADE IN
U.S.A.

MARSHALLTOWN The Premier Line

| EDI | Part# | Size-in. | Size-mm |
|-------|-------|----------|-----------|
| 14453 | 53D | 10 X 4 | 254 X 102 |

Molded Rubber Float

- Molded black rubber pad is ideal for bringing sand to the surface
- Float face is cemented to the lightweight aluminum backing
- Sold 1 per inner pack/24 per outer pack



ASSEMBLED
IN U.S.A.

MARSHALLTOWN The Premier Line

| EDI | Part# | Size-in. | Size-mm |
|-------|-------|----------|-----------|
| 14408 | 40 | 9 X 4 | 229 X 102 |

Molded Rubber Float

- Molded black rubber pad is very compact and dense
- Thick aluminum backing plate resists bending
- Rubber pad is 5/8" (16mm) thick
- Sold 6 per inner pack/60 per outer pack



QLT BY MARSHALLTOWN

| EDI | Part # | Size-in. | Size-mm |
|-------|--------|----------|-----------|
| 10753 | MRF94 | 9 X 4 | 229 X 102 |

Grout System

- Oversized center roller for maximum water removal
- Durable 6 gallon bucket
- Cleans grout in less time with less mess
- Cross slit sponge traps grout for more effective cleaning
- Deluxe Grout System includes: wash bucket with handle, DuraSoft® sponge float, oversized DuraSoft® sponge float, extra sponge float pad, extra oversized sponge float pad, fine grit scrub pad, medium grit scrub pad
- Sold 1 per inner pack/1 per outer pack, sold 1 per inner pack/6 per outer pack where noted with *, sold 1 per inner pack/12 per outer pack where noted with **



QLT BY MARSHALLTOWN

| EDI | Part# | Description | Size-in. | Size-mm |
|-------|----------|--------------------|----------|-----------|
| 16791 | DGS91 | Deluxe System | 20½ X 13 | 508 X 330 |
| 16793 | SSF93* | Small Sponge Float | 11 X 5½ | 279 X 140 |
| 16794 | LSF94* | Large Sponge Float | 13 X 4½ | 330 X 114 |
| 16796 | SF93RP** | Small Repl. Sponge | 11 X 5½ | 279 X 140 |
| 16797 | SF94RP** | Large Repl. Sponge | 13 X 4½ | 330 X 114 |

Grit Guard

- Grit floats to bottom of bucket keeping sponge free from debris
- For more details **see page 245**

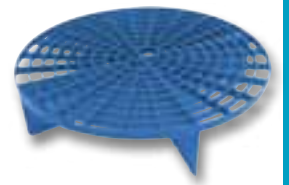

Plastic Foam Floats

- Plastic foam pad specially bonded to an aluminum backing plate
- Wears well and does an excellent job on any sand surface
- Pads are 3/4" (19mm) thick
- Replacement pads are packed 6 per bag, 1 bag per inner pack/12 bags per outer pack
- Floats sold 1 per inner pack/12 per outer pack, 24 per outer pack where noted with *



ASSEMBLED
IN U.S.A.

MARSHALLTOWN The Premier Line

| EDI | Part# | Description | Size-in. | Size-mm |
|-------|-------|--------------------|----------|-----------|
| 14416 | 46G* | Green/Fine | 9½ X 4 | 242 X 102 |
| 14418 | 46LG | Green/Fine | 12 X 4 | 305 X 102 |
| 14432 | 46BG | Green/Fine | 12 X 5 | 305 X 127 |
| 14420 | 46LB | Orange/Coarse | 12 X 4 | 305 X 102 |
| 14417 | 4417 | Repl. Pad for 46G | 9½ X 4 | 242 X 102 |
| 14379 | 4379 | Repl. Pad for 46LG | 12 X 4 | 305 X 102 |
| 14382 | 4382 | Repl. Pad for 46BG | 12 X 5 | 305 X 127 |
| 14384 | 4384 | Repl. Pad for 46LB | 12 X 4 | 305 X 102 |

Tile Grout Sponges

- Used to wipe off excess grout from joints
- Rounded corners to prevent digging out or marring joints
- Available in three sizes: medium, large and extra large
- Inner/outer pack quantities shown in table, individually bagged sponges are noted in table with *



MADE IN
U.S.A.

MARSHALLTOWN The Premier Line

| EDI | Part# | Description | Size-in. | Size-mm | Qty. |
|-------|-------|--------------|--------------|----------------|-------|
| 16461 | TGS2 | Medium * | 6 x 4 x 2 | 152 x 102 x 51 | 72/72 |
| 16462 | TGSL | Large* | 6½ x 4¼ x 2½ | 165 x 108 x 54 | 50/50 |
| 16465 | TL | Lg.-Bulk-650 | 6½ x 4¼ x 2½ | 165 x 108 x 54 | 1/1 |
| 16463 | TGS1 | XL* | 7¼ x 5½ x 2¼ | 184 x 130 x 57 | 40/40 |
| 16466 | TXL | XL Bulk-450 | 7¼ x 5½ x 2¼ | 184 x 130 x 57 | 1/1 |

Tile Grout Scrubbing Sponges

- For scrubbing and haze removal
- Yellow grout sponge on one side to wipe off excess grout from joints
- White scrubber side to remove grout haze and stubborn mortar colors
- Sold 50 per inner pack/50 per outer pack



MADE IN
U.S.A.

MARSHALLTOWN The Premier Line

| EDI | Part# | Size-in. | Size-mm |
|-------|-------|--------------|----------------|
| 16460 | TLW | 6½ X 4¼ X 2½ | 165 X 114 X 54 |

Turtle Back Sponge

- Great general purpose cellulose sponge
- Shape conforms to hand
- Sold 24 per inner pack/24 per outer pack



MADE IN
U.S.A.

MARSHALLTOWN The Premier Line

| EDI | Part# | Size-in. | Size-mm |
|-------|-------|----------|---------|
| 16587 | 16587 | N/A | N/A |

Grout Sealant Tool

- Roll out grout sealant with ease
- Equipped with adjustable line guide
- Interchangeable wheel tip assemblies ranging in width from 1/64" to 1/4" (.4 to 6mm)
- Sold 6 per inner pack/6 per outer pack
- E1080 kit includes one single line striper and all eight interchangeable wheels, sold 6 per inner pack/6 per outer pack



MARSHALLTOWN The Premier Line

| EDI | Part# | Description | Size-in. | Size-mm |
|-------|-------|--------------|----------|---------|
| 19680 | E1080 | Striper Assy | N/A | N/A |
| 19672 | E1011 | Tip Assy | 1/64 | .4 |
| 19676 | E1015 | Tip Assy | 5/64 | 2 |

Scrub Float with Pads

- Cleans all types of grout film, including tough epoxy films from tile without damaging the grout joint
- Velcro® backing makes changing/cleaning pads quick and easy
- Resilient DuraSoft® handle provides a soft feel, reduces fatigue and offers excellent durability
- Sold 1 per inner pack/6 per outer pack
- Replacement pads sold 5 per bag, 1 per inner pack/4 per outer pack



MADE IN
U.S.A.

MARSHALLTOWN The Premier Line

| EDI | Part# | Description | Size-in. | Size-mm |
|-------|-------|---------------------|----------|-----------|
| 14036 | 14036 | Scrub Float w/ Pads | 10 X 4½ | 254 X 114 |
| 14037 | 14037 | Handle/Plate Assy. | 10 X 4½ | 254 X 114 |
| 15468 | WP468 | White Pads, Fine | 10 X 4½ | 254 X 114 |
| 15469 | BP469 | Blue Pads, Medium | 10 X 4½ | 254 X 114 |

Stand-Up Scrub Bug

- Clean all types of grout films, including tough epoxy films, from tile without damaging the grout joint
- To clean the pads, simply pull off and rinse in water
- Includes one scrubbing head, one white pad and one blue pad
- Use with a standard threaded handle (not included)
- Sold 6 per inner pack/6 per outer pack



For handle choices see pages 181-182

MADE IN U.S.A.

QLT^{BY} MARSHALLTOWN

| EDI | Part# | Size-in. | Size-mm |
|-------|-------|----------|-----------|
| 15561 | SB561 | 10 X 4½ | 254 X 114 |

Cheesecloth

- Loosely woven cotton fabric used for cleaning grout from tile
- 100% unbleached cotton
- Sold 1 per inner pack/72 per outer pack



MADE IN U.S.A.

MARSHALLTOWN The Premier Line

| EDI | Part# | Size-sq. ft. | Size-sq. M |
|-------|-------|--------------|------------|
| 10471 | CC471 | 5 | .46 |

Margin Trowels

- Forged from a single piece of high carbon steel
- Tempered, ground and polished from toe to heel
- For our complete line of margin trowels, details and size options **see page 11**

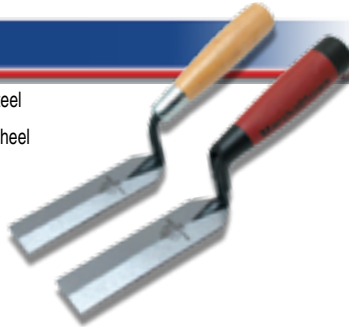

Pointing Trowels

- Forged from a single piece of high carbon steel for unsurpassed strength
- For our complete line of pointing trowels, details and size options **see page 10**



Bucket Trowels

- Forged from a single piece of high carbon steel
- For our complete line of bucket trowels, details and size options **see pages 9-10**



Tile Setter's Trowels

- Forged from a single piece of high carbon steel
- Blade is fully tempered, ground and polished
- Available with hardwood or DuraSoft[®] handle
- Sold 6 per inner pack/6 per outer pack



MADE IN U.S.A.

U.S. Patent Nos. 5,327,612 & 5,446,941

MARSHALLTOWN The Premier Line

| EDI | Part# | Size-in. | Size-mm | Handle |
|-------|-------|----------|-----------|--------|
| 10757 | 57 | 7 X 4¾ | 178 X 112 | |
| 10758 | 57D | 7 X 4¾ | 178 X 112 | |

Tile Setter's Trowel

- Durable construction
- Designed for repeated use but priced for the Do-It-Yourselfer
- Soft grip handle for increased comfort
- Sold 6 per inner pack/60 per outer pack



NEW!

QLT^{BY} MARSHALLTOWN

| EDI | Part# | Size-in. | Size-mm |
|-------|---------|----------|-----------|
| 18636 | TSTSG74 | 7 X 4½ | 178 X 114 |

Tile Setter's Trowel

- Tempered blade; fully ground and polished
- Hardwood handle
- Sold 6 per inner pack/60 per outer pack



QLT^{BY} MARSHALLTOWN

| EDI | Part# | Size-in. | Size-mm |
|-------|-------|----------|-----------|
| 16127 | 927 | 7 X 4½ | 178 X 114 |

Crain® Super Saw

- Has 6½" (165mm) flush-cutting blade; cuts into corners
- Powerful 13 amp motor
- Blade height adjustable up from a flush cut to a maximum of 1" (25mm) off the floor
- Comes with one combination and one masonry blade, detailed instructions, carrying case and guarantee
- Five different blades available
- **15492, 15493 and 15494** fit **810SS** Crain® Super Saw
- **15516 and 15517** fit **812SS** Crain® Super Saw
- Sold 1 per inner pack/10 per outer pack, sold 1 per inner pack/1 per outer pack where noted with *



MARSHALLTOWN The Premier Line

| EDI | Part# | Description | Size-in. | Size-mm |
|-------|--------|------------------------------|----------|---------|
| 15515 | 812SS* | Saw w/Case | 6½ | 165 |
| 15492 | 803SB | Fine Cut (100 teeth) | 6½ | 165 |
| 15493 | 804SB | Rough Cut (40 carbide teeth) | 6½ | 165 |
| 15494 | 805SB | Masonry (dry cut) | 6½ | 165 |
| 15516 | 821SB* | Carbide Tipped Blade | 6½ | 165 |
| 15517 | 822SB* | Diamond Undercut Blade | 6½ | 165 |

"Super Clinker" Tile Cutter

- Can score and break tile up to 9/16" (14mm) thick
- Has 5/8" (16mm) diameter guide rails
- Has 7/8" (22mm) diameter solid carbide scoring wheel
- Tile size capacity is 147/8" (380mm)
- Sold 1 per inner pack/4 per outer pack

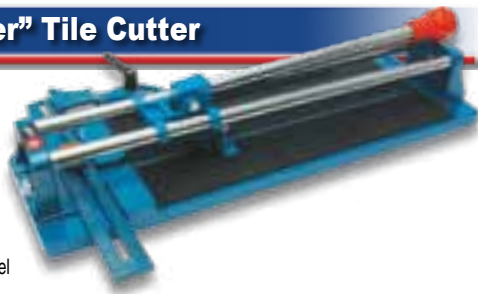

QLT[™] MARSHALLTOWN

| EDI | Part# | Size-in. | Size-mm |
|-------|-------|----------|---------|
| 15375 | M14T | 13½ | 333 |

"Deluxe Big Clinker" Tile Cutter

- Four position scoring height adjustment knob to allow scoring and cutting of tiles up to 3/4" (19mm) thick
- Cutter has 20 mm diameter dual chrome plated steel bars that are heat treated for longest life
- Features a 4¾" wide breaker foot and a 12" wide protractor gauge
- Makes 27½" straight cut and 19½" diagonal cut length
- 1 per inner/2 per outer pack

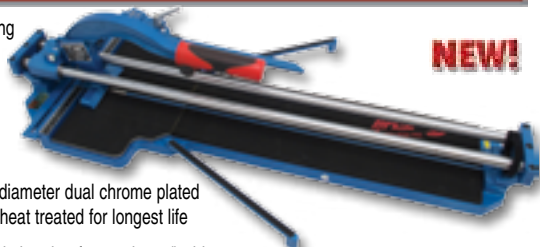

QLT[™] MARSHALLTOWN

| EDI | Part# | Size-in. | Size-mm |
|-------|---------|----------|---------|
| 18965 | JP700ST | 27½ | 699 |

"Big Clinker" Tile Cutter

- Four position scoring height adjustment knob to allow scoring and cutting of tile up to 3/4" (19mm) thick
- Titanium scoring wheel and breaker bar of these cutters ride smoothly over the extra large 51/64" (20mm) diameter chrome plated rails
- Has a 20" (508mm) straight cut length and a 16" (406mm) diagonal cut length
- Heavy duty breaker bar with a plastic bottom pad to prevent tile marking
- Sold 1 per inner pack/2 per outer pack



QLT[™] MARSHALLTOWN

| EDI | Part# | Size-in. | Size-mm |
|-------|---------|----------|---------|
| 15569 | JP570XE | 22½ | 570 |

Replacement Parts

- Replacement parts for **M14T, JP570XE** and **JP680XE** tile cutters
- Inner/Outer pack quantities shown in table



Super Clinker Replacement Parts

| EDI | Part# | Description | Inner/Outer |
|-------|-------|-----------------|-------------|
| 15379 | MSW3 | Scoring Wheel | 1/12 |
| 15600 | M1404 | Rubber Pads (2) | 1/1 |
| 15604 | M1415 | Rail Bar | 1/1 |
| 15605 | M1420 | Sliding Block | 1/1 |
| 15606 | M1421 | Breaker Foot | 1/1 |
| 15607 | M1422 | Pivot Arm | 1/1 |

Power & Big Clinker Replacement Parts

| EDI | Part# | Description | JP570XE | JP680XE | JP700ST |
|-------|----------|-------------------------------|---------|---------|---------|
| 15592 | MX47011P | Protractor Gauge | X | X | X |
| 15593 | MX47014D | Screw & Washer for Protractor | X | X | X |
| 15596 | MX47021 | Breaker Foot w/Rubber | X | X | X |
| 15575 | MX47025 | Pivot Arm Bearing (2/set) | X | X | X |
| 15599 | 22X | Titanium Rotary Wheel | X | X | X |
| 15576 | JP50003 | Side Arm Extension (2/set) | X | X | X |
| 15578 | JP50010 | Handle Assembly w/o Wheel | X | X | X |
| 15579 | JP50010A | Wheel Holder | X | X | X |
| 15580 | JP50010B | Wheel Holder Coil Spring | X | X | X |
| 15581 | JP50010C | Wheel Height Adj. Cam | X | X | X |
| 15582 | JP50010D | Cam Knob w/Washer & Screw | X | X | X |
| 15584 | JP50020 | Bearing Block | X | X | X |
| 15586 | JP50026 | Knob Screw (Arm Extension) | X | X | X |
| 15570 | JP57015 | Rail Bar (2/set) | X | | |
| 15571 | JP57004 | Rubber Pad (2/set) | X | | |
| 15587 | JP68004 | Rubber Pad (2/set) | | X | |
| 15588 | JP68015 | Rail Bar (2/set) | | X | |

VCT Cutters

- Rugged, precision die cast aluminum base
- Adjustable 45° miter guide
- Industrial grade ball bearing action
- Powder coated epoxy enamel finish
- Built-in casters and rubber feet for stationary use
- Adjustable height high carbon steel cutting blades
- VCT12 sold 1 per inner pack/2 per outer pack, VCT18 sold 1 per inner pack/1 per outer pack, replacement parts sold 1 per inner pack/6 per outer pack



MARSHALLTOWN The Premier Line

| EDI | Part# | Description | Size in. | Size mm |
|-------|----------|-----------------------------|----------|---------|
| 17380 | VCT12 | Small Cutter | 12 | 305 |
| 17381 | VCT18 | Large Cutter | 18 | 457 |
| 17382 | TOPBLD12 | Top Cutting Blade w/Bolts | 12 | 305 |
| 17383 | LWRBLD12 | Lower Cutting Blade w/Bolts | 12 | 305 |
| 17384 | CRSH12 | Crankshaft w/Handle & Grip | 12 | 305 |
| 17385 | GUIDE12 | Tile Guide w/Screws | 12 | 305 |
| 17386 | TOPBLD18 | Top Cutting Blade w/Bolts | 18 | 457 |
| 17387 | LWRBLD18 | Lower Cutting Blade w/Bolts | 18 | 457 |
| 17388 | CRSH18 | Crankshaft w/Handle & Grip | 18 | 457 |
| 17389 | GUIDE18 | Tile Guide w/Screws | 18 | 457 |

Crescent® Tile Nippers

- Has 5/8" (16mm) offset jaws with carbide tips
- Unique handle design for added comfort
- Plastic grip
- Handle stops to protect tips
- Center spring returns jaws to open position
- **WARNING:** Always wear safety goggles when using this tool
- Sold 1 per inner pack/6 per outer pack



MARSHALLTOWN The Premier Line

| EDI | Part# | Size-in. | Size-mm |
|-------|--------|----------|---------|
| 15350 | GT28CN | N/A | N/A |

Square Head Tile Nippers

- Made from drop forged steel
- Has 5/8" (16mm) offset jaws with carbide tips
- Cushioned handle grips
- Handle stops prevent carbide cutting edges from biting together
- Center return spring opens jaws and improves the feel
- **WARNING:** Always wear safety goggles when using this tool
- Sold 2 per inner pack/20 per outer pack



QLT by MARSHALLTOWN

| EDI | Part# | Size-in. | Size-mm |
|-------|-------|----------|---------|
| 16723 | TN724 | N/A | N/A |

Power Grip Tile Nippers

- Made from drop forged steel
- Has 5/8" (16mm) offset jaws with carbide tips
- Cushioned handle
- Handle stops prevent carbide cutting edges from biting together
- Center return spring opens jaws and improves the feel
- **WARNING:** Always wear safety goggles when using this tool
- Sold 2 per inner pack/20 per outer pack



QLT by MARSHALLTOWN

| EDI | Part# | Size-in. | Size-mm |
|-------|-------|----------|---------|
| 16724 | TN725 | N/A | N/A |

Quarry Pliers

- Longer 10" (254mm) handle capable of cutting thicker, harder tile
- TOSHIBA 5/8" (16mm) carbide tips for long life
- Center-cut design
- Made of drop-forged steel
- **WARNING:** Always wear safety goggles when using this tool
- Sold 1 per inner pack/36 per outer pack



QLT by MARSHALLTOWN

| EDI | Part# | Size-in. | Size-mm |
|-------|-------|----------|---------|
| 15449 | MP4 | N/A | N/A |

Tile Pliers

- Features a 1/2" (13mm) tungsten carbide wheel for scoring
- Also has pliers to break the tile along the score line
- Handles have cushion grip for added comfort
- **WARNING:** Always wear safety goggles when using this tool
- Sold 2 per inner pack/20 per outer pack



QLT by MARSHALLTOWN

| EDI | Part# | Size-in. | Size-mm |
|-------|-------|----------|---------|
| 16720 | TP721 | N/A | N/A |

Mosaic Glass Cutter

- Tungsten carbon scoring wheels with titanium coating
- Circular cutting blades for easy nipping and cutting
- Wheels can be repositioned to get new edge
- **WARNING:** Always wear safety goggles when using this tool
- MGC599 sold 1 per inner pack/1 per outer pack, MGC599SW sold 1 per inner pack/12 per outer pack



QLT by MARSHALLTOWN

| EDI | Part# | Description | Size-in. | Size-mm |
|-------|----------|--------------|----------|---------|
| 10599 | MGC599 | Cutter | N/A | N/A |
| 15245 | MGC599SW | Repl. Wheels | N/A | N/A |

Tile File

- Removes sharp and irregular edges from tile and marble
- Tungsten carbide grit
- Soft grip handle
- Sold 10 per inner pack/100 per outer pack



QLT BY MARSHALLTOWN

| EDI | Part# | Size-in. | Size-mm |
|-------|----------|----------|---------|
| 11290 | TILEFILE | N/A | N/A |

Tile Screen

- Smooths rough edges on tile
- Can be bent to fit curves
- Can also be used on wood and plaster
- Two screens per package
- Sold 50 per inner pack/500 per outer pack

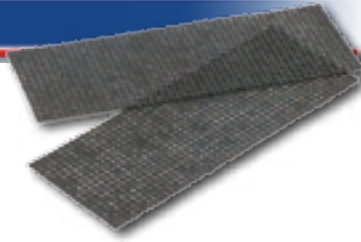

QLT BY MARSHALLTOWN

| EDI | Part# | Size-in. | Size-mm |
|-------|----------|----------|---------|
| 11291 | TILESCRN | N/A | N/A |

Carbide Tipped Chisels

- Specially designed for removing tile
- Shaped to prevent damage to adjacent tiles
- Carbide tips provide long life
- WARNING:** Always wear safety goggles when using this tool
- Sold 1 per inner pack/1 per outer pack



QLT BY MARSHALLTOWN

| EDI | Part# | Size-in. | Size-mm |
|-------|-------|----------|---------|
| 15356 | 15356 | ¼ | 6 |
| 15357 | 15357 | ⅜ | 10 |
| 15358 | 15358 | ½ | 13 |

Carbide Hole Saw

- Carbide grit edge cuts 1⅝" (35mm) diameter holes in ceramic wall tile for water pipes
- Spring automatically ejects slug
- Has ⅜" (10mm) diameter shank that holds a ¼" (6mm) diameter carbide tipped pilot drill
- Sold 1 per inner pack/1 per outer pack



QLT BY MARSHALLTOWN

| EDI | Part# | Size-in. | Size-mm |
|-------|-------|----------|----------|
| 15393 | 15393 | 1⅝ Diam. | 35 Diam. |

Diamond Hole Saw

- For use on all types of ceramic tile and other hard materials
- Gives clean cut holes and long saw life
- Use with water to reduce friction, heat and dust
- Maximum cutting depth is 1¼" (31mm)
- Sold 1 per inner pack/1 per outer pack



QLT BY MARSHALLTOWN

| EDI | Part# | Size-in. | Size-mm |
|-------|-------|----------|----------|
| 15394 | 15394 | 1⅝ Diam. | 35 Diam. |

DuraSoft® Undercut Saw

- Undercuts door jambs and other wall base obstacles
- Specially shaped 12" (305mm) long blade permits right or left hand cutting
- DuraSoft® handle
- Saw sold 1 per inner pack/6 per outer pack, replacement blades sold 12 per inner pack/60 per outer pack



MADE IN
U.S.A.

U.S. Patent No. 5,522,111

MARSHALLTOWN The Premier Line

| EDI | Part# | Description | Size-in. | Size-mm |
|-------|--------|-------------|----------|---------|
| 19041 | US9041 | Saw | 12 | 305 |
| 19040 | RB9041 | Repl. Blade | 12 | 305 |

Utility Saws

- Four styles to choose from
- For our complete line of utility saws, details and size options **see pages 173-174**



Carbide Scoring Cutter

- Reversible blade has carbide tips on each end for double life
- Score and cut cement backer board, linoleum, Plexiglas and soft tile
- Excellent tool for degrouting work or removing caulk
- WARNING:** Always wear the necessary eye, ear and breathing protection when using this tool
- Sold 1 per inner pack/12 per outer pack



QLT BY MARSHALLTOWN

| EDI | Part# | Description | Size-in. | Size-mm |
|-------|--------|------------------------|----------|---------|
| 16068 | SC68 | Carbide Scoring Cutter | 5½ | 140 |
| 16069 | SC68RB | Carbide Repl. Blade | 3 | 76 |

Carbide Cement Board Cutter

- Multi-purpose cutter features three tungsten carbide cutting blades: two scoring and one chiseling
- Professional grade tool ideal for scoring laminates, counter tops, roof tiles, fiberglass roofing, shingles and much more
- Sold 12 per inner pack/120 per outer pack



QLT BY MARSHALLTOWN

| EDI | Part# | Size-in. | Size-mm |
|-------|--------|-------------|---------------|
| 17813 | CBC813 | 7½ x 1½ x ¾ | 191 x 38 x 19 |

Cushion Back Cutter

- For trimming and cutting dense or sponge back carpet
- Double 30 degree angle blades cut either side of the row close and clean, producing better seams
- Slotted blades are easily retractable and replaceable
- Replace dull blades with 9060RB
- Sold 1 per inner pack/ 20 per outer pack
- Blades sold in boxes of 100, 1 per inner pack/ 1 per outer pack

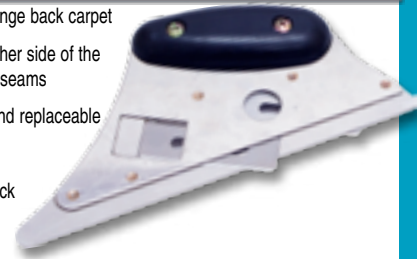

QLT BY MARSHALLTOWN

| EDI | Part# | Description | Size-in. | Size-mm |
|-------|--------|--------------|----------|---------|
| 12210 | CBC | Cutter | N/A | N/A |
| 14947 | 9060RB | Repl. Blades | N/A | N/A |

Knives

- Many styles of knives to choose from
- For our complete line of knives, details and size options



see page 235

Carpet Knife

- Magnet holds blade in place during replacement
- Large knob allows for easy opening
- DuraSoft® handle for increased comfort and reduced fatigue
- Includes three blades, stored in handle
- 12 knives per display box
- Sold 12 per inner pack/12 per outer pack



MARSHALLTOWN The Premier Line

| EDI | Part# | Description | Size-in. | Size-mm |
|-------|--------|--------------------|----------|---------|
| 19060 | 9060 | Knife | 5¾ | 146 |
| 14946 | 9060SB | Replacement Blades | N/A | N/A |
| 14947 | 9060RB | Replacement Blades | N/A | N/A |

Stair Tool

- For tucking carpet into stair crotches and tack strip
- Soft cushion grip provides added comfort and superior grip
- Edges are rounded to prevent snagging and cutting
- Chrome plated steel extends life of tool
- Sold 1 per inner pack/ 24 per outer pack



QLT BY MARSHALLTOWN

| EDI | Part# | Size-in. | Size-mm |
|-------|-------|----------|---------|
| 12211 | ST35 | 3½ | 89 |

Claw Hammers

- For details and size options on Claw Hammers
- see pages 237-238



Carpet Seam Roller

- Star wheel design blends carpet yarn at seam
- Soft grip handle for increased comfort
- Improves seam strength by forcing adhesive into carpet backing
- Sold 1 per inner pack/ 24 per outer pack



QLT BY MARSHALLTOWN

| EDI | Part# | Description | Size-in. | Size-mm |
|-------|-------|-------------------|----------|---------|
| 12214 | CSR35 | Small Seam Roller | 3½ | 89 |
| 12213 | CSR5 | Large Seam Roller | 5 | 127 |

Knee Kicker

- Extra thick knee pad for comfort
- Non-slip hand grip
- Adjusts from 17½" to 21½"
- High contour neck
- Sold 1 per inner pack/ 9 per outer pack



QLT BY MARSHALLTOWN

| EDI | Part# | Description | Size-in. | Size-mm |
|-------|-------|-------------------------|-----------|-----------|
| 12212 | CSKK | Knee Kicker | 17½ - 21½ | 445 - 546 |
| 12403 | PPACS | Pin Plate Assy 16 Teeth | N/A | N/A |
| 12527 | NGPCS | Nap Grip Pads (3) | N/A | N/A |
| 12562 | BACS | Bumper Assy | N/A | N/A |
| 13379 | KKSC | Repl Spring Clip | N/A | N/A |

Power Carpet Stretcher

- 60 degree swivel for stretching angles or into corners
- Includes power unit, 18" tail block with wheels, transfer tube, 3 - 3ft(914mm) extension tubes, 1 adjustable locking tube, and one carrying case
- Can reach a maximum distance of 23ft 4in. (7.1M)
- Extension tubes extend out up to 5ft(1.5M)
- Tail block has wheels for easy movement, won't mark walls
- Adjustable pin penetration and easy to reach locking mechanism
- Adjustable locking tube extends without having to use push buttons
- Sold 1 per inner pack/ 1 per outer pack



Gripper View

QLT BY MARSHALLTOWN

| EDI | Part# | Size-in. | Size-M |
|-------|-------|----------|--------|
| 12215 | PCS | 280 | 7.1 |

Electric Stapler

- Used for installing carpet
- Jam proof with 85 staple capacity
- Low overall height makes it easier to get into small spaces (9" L x 7.5"H x 2.75" W)
- Works with 1/4", 5/16", 3/8", 1/2", and 9/16" length staples with a 20 gauge 3/16" crown
- Includes a box of 5000 20 gauge 3/16" crown, 9/16" length staples
- 5 Amp, 120 Volt 60 hz single phase power
- Stapler sold 1 per inner pack/ 5 per outer pack
- Staples come 5000 pcs. per box
- Staples sold 1 box per inner pack/ 20 boxes per outer pack



QLT BY MARSHALLTOWN

| EDI | Part# | Description |
|-------|----------|----------------------------|
| 17471 | ESTAPLER | Electric Stapler with Case |
| 17472 | ESTAPLES | Repl. Staples |

Hammer Tackers

- Easy loading of staples
- Professional quality for carpet installation, roofing, insulation, upholstery and much more
- **WARNING:** Do not hold the tacker toward people as it could cause serious injury
- Sold 10 per inner pack/20 per outer pack



REDUCED PRICE WHILE SUPPLIES LAST!

QLT BY MARSHALLTOWN

| EDI | Part# | Size-in. | Size-mm |
|-------|----------|----------|---------|
| 12940 | HT1438 | ¼ - ⅜ | 6 - 10 |
| 12941 | HT516916 | ⅝ - ⅞ | 8 - 14 |

Staple Gun

- For use with different crown width staples
- Adjustable wire attachment for wires and cables up to ⅜" (9.52mm) in diameter
- Includes 600 high carbon wire staples, 8mm wrench, and instruction sheet
- **WARNING:** Do not hold the stapler toward people as it could cause serious injury
- Sold 1 per inner pack/10 per outer pack



REDUCED PRICE WHILE SUPPLIES LAST!

QLT BY MARSHALLTOWN

| EDI | Part# | Size-in. | Size-mm |
|-------|---------|----------|---------|
| 12942 | SG14916 | ¼ - ⅞ | 6-14 |

Staples

- 100 piece strips, 1,000 pieces per box
- Sold 50 per inner pack/100 per outer pack



QLT BY MARSHALLTOWN

| EDI | Part# | Size-in. | Size-mm |
|-------|------------|----------|---------|
| 12943 | STAPLES14 | ¼ | 6 |
| 12944 | STAPLES516 | ⅝ | 8 |
| 12947 | STAPLES38 | ⅜ | 10 |
| 12948 | STAPLES12 | ½ | 12 |
| 12949 | STAPLES916 | ⅞ | 14 |

Snips

- Durable aluminum frame
- Ideal tool for cutting sheet metal, wire and plastic
- Replaceable blades (sold separately)
- Easy blade replacement-no need to grind off rivets
- Snips sold 3 per inner pack/12 per outer pack, blades sold 12 pair per inner pack/60 pair per outer pack



QLT BY MARSHALLTOWN

| EDI | Part# | Description | Size-in. | Size-mm |
|-------|-------|--------------|----------|---------|
| 15396 | 15396 | Snips | 12 | 305 |
| 15397 | 15397 | Snips | 14 | 356 |
| 15496 | 15496 | Repl. Blades | 12 | 305 |
| 15497 | 15497 | Repl. Blades | 14 | 356 |

Aviation Snips

- Double-action snips
- Available in three styles, vinyl grips are color coded for cutting direction: left cut (red), right cut (green), straight (yellow)
- 10" (254 mm) long
- Sold 6 per inner pack/24 per outer pack

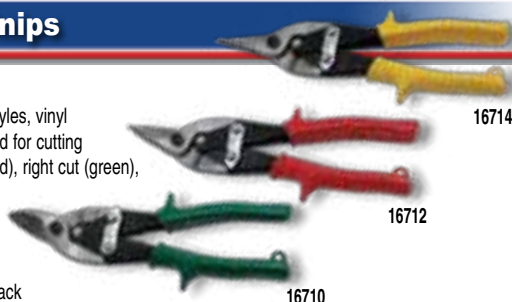

QLT BY MARSHALLTOWN

| EDI | Part# | Description |
|-------|-------|--------------|
| 16710 | 16710 | Right Cut |
| 16712 | 16712 | Left Cut |
| 16714 | 16714 | Straight Cut |

Grout Saw

- Resilient DuraSoft® handle with finger guard
- Die cast aluminum mounting with thumb rest
- Blade coated with tungsten carbide
- Replacement blades available
- Saw sold 6 per inner pack/24 per outer pack, blades sold 1 per inner pack/1 per outer pack



MADE IN U.S.A.

U.S. Patent Nos. 5,327,612 & 5,446,941

MARSHALLTOWN The Premier Line

| EDI | Part# | Description | Size-in. | Size-mm |
|-------|-------|--------------|----------|---------|
| 15470 | 446 | Grout Saw | N/A | N/A |
| 15465 | 15465 | Repl. Blades | N/A | N/A |

Grout Saw

- Made of hard plastic yet lightweight
- Blade is coated with tungsten carbide abrasive and can be removed and replaced
- Designed to aid in the removal of tile grout
- Saw sold 6 per inner pack/6 per outer pack, replacement blades sold 1 per inner pack/1 per outer pack



QLT BY MARSHALLTOWN

| EDI | Part# | Description | Size-in. | Size-mm |
|-------|-------|-------------|----------|---------|
| 17800 | GS671 | Saw w/Blade | N/A | N/A |
| 17802 | RB670 | Repl. blade | N/A | N/A |

Tile Stones & Rub Bricks

- Available in many sizes with or without handle
- Smooths and dresses down newly cut tile
- Variety of grits available
- Available in black (silicon carbide) or white (aluminum oxide)
- White stones will not mark tile
- Sold 1 per inner pack/6 per outer pack, * sold 1 per inner pack/4 per outer pack, ** sold 1 per inner pack/5 per outer pack



MARSHALLTOWN The Premier Line

| EDI | Part# | Grit/Description | Size-in. | Size-mm |
|-------|---------|--------------------|-------------|---------------|
| 16533 | 16533* | 20 Round w/Handle | 6 X 1 | 152 X 25 |
| 16537 | 16537** | 20 w/Handle | 8 X 3½ X ¾ | 203 X 89 X 19 |
| 16547 | 16547* | 20 Fluted | 6 X 2 X 2 | 152 X 51 X 51 |
| 16545 | 16545* | 20 Fluted | 8 X 2 X 2 | 203 X 51 X 51 |
| 16440 | 840** | 20 Fluted w/Handle | 6 X 3 X 1 | 152 X 76 X 25 |
| 16441 | 841** | 20 Fluted w/Handle | 8 X 3½ X 1½ | 203 X 89 X 38 |
| 15503 | 15503 | 24 Black | 6 X 2 X 1 | 152 X 51 X 25 |
| 15504 | 15504 | 30 Black | 6 X 2 X 1 | 152 X 51 X 25 |
| 15505 | 15505 | 46 Black | 6 X 2 X 1 | 152 X 51 X 25 |
| 16531 | 16531 | 60-90 Combo Black | 4 X 1 | 102 X 25 |
| 15506 | 15506 | 60 Black | 6 X 2 X 1 | 152 X 51 X 25 |
| 15510 | 15510 | 60-90 Combo Black | 6 X 2 X 1 | 152 X 51 X 25 |
| 16535 | 16535 | 60 w/Handle-Fluted | 6 X 3 X 1 | 152 X 76 X 25 |
| 15380 | 15380 | 60 Black | 8 X 2 X 1 | 203 X 51 X 25 |
| 15382 | 15382 | 60 White | 8 X 2 X 1 | 203 X 51 X 25 |
| 15383 | 15383 | 80 White | 8 X 2 X 1 | 203 X 51 X 25 |
| 15507 | 15507 | 80 Black | 6 X 2 X 1 | 152 X 51 X 25 |
| 15381 | 15381 | 80 Black | 8 X 2 X 1 | 203 X 51 X 25 |
| 15508 | 15508 | 120 Black | 6 X 2 X 1 | 152 X 51 X 25 |
| 15509 | 15509 | 150 Black | 6 X 2 X 1 | 152 X 51 X 25 |

Heavy Duty Scrapers

- Sharp 4" (102mm) wide blade for stripping hard to remove floor coverings and adhesives
- Heavy duty aluminum construction
- Double sided, hardened steel blade
- Easy to replace blade
- Scraper size refers to handle length
- Inner/outer pack quantities shown in table



MARSHALLTOWN The Premier Line

| EDI | Part# | Description | Size-in. | Size-mm | Inner/Outer |
|-------|---------|-------------|----------|---------|-------------|
| 10467 | SC412 | Scraper | 12 | 305 | 6/24 |
| 10468 | SC418 | Scraper | 18 | 457 | 6/30 |
| 10469 | SC448 | Scraper | 48 | 1219 | 6/18 |
| 10470 | SCBLADE | Repl. Blade | 4 | 102 | 10/100 |

Crain® Scrapers

- 4 or 8" (102 or 203mm) scraping blade
- Available with 12" (305mm), 18" (457mm) handles or with a 39 to 59" (991 to 1499mm) telescoping handle
- Comfortable rubber handle grip
- Inner/outer pack quantities shown in table



MADE IN
U.S.A.

MARSHALLTOWN The Premier Line

| EDI | Part# | Size-in. | Size-mm | Inner/Outer |
|-------|-------|-----------|----------------|-------------|
| 15384 | 350 | 4 X 12 | 102 X 305 | 6/24 |
| 15385 | 360 | 4 X 18 | 102 X 457 | 10/30 |
| 15388 | 375 | 8 X 39-59 | 203 X 991-1499 | 6/6 |

Replacement Blades For Scrapers

- All blades are 3/4" (19mm) wide and 1/32" (8mm) thick
- Sold 1 per inner pack/10 per outer pack



MADE IN
U.S.A.

MARSHALLTOWN The Premier Line

| EDI | Part# | Description | Size-in. | Size-mm |
|-------|-------|-------------------|----------|---------|
| 15386 | 15386 | Tube of 10 blades | 4 | 102 |
| 19636 | E444 | Box of 100 blades | 4 | 102 |
| 15389 | 15389 | Tube of 3 blades | 8 | 203 |
| 15390 | 15390 | Tube of 10 blades | 8 | 203 |

T-Handled Floor Scraper

- All steel heavy duty construction
- 54" (1372mm) long T-handle
- Removes many types of floor coverings from a variety of floors
- Ships with 7" (178mm) blade
- Inner/Outer Pack quantities listed in table



QLT-MARSHALLTOWN

| EDI | Part# | Description | Size-in. | Size-mm | Inner/Outer |
|-------|--------|------------------|----------|------------|-------------|
| 12504 | THS7 | Scraper w/ Blade | 54 x 7 | 1372 x 178 | 1/6 |
| 12506 | THS7B | 7" Repl. Blade | 7 x 3 | 178 x 76 | 24/120 |
| 12507 | THS10B | 10" Repl. Blade | 10 x 3 | 254 x 76 | 24/96 |

Floor Scrapers

- 60 X 1 1/8" (1524 X 28mm) steel handle securely welded to heavy angle iron bracket
- Blade is heavy gauge spring steel
- Plastic grip on handle to protect hands
- This durable scraper is the perfect clean-up tool
- Replacement blades available
- Sold 6 per inner pack/6 per outer pack

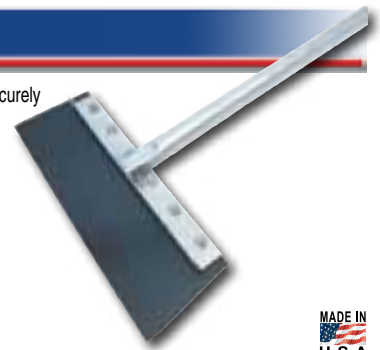

MADE IN
U.S.A.

MARSHALLTOWN The Premier Line

| EDI | Part# | Description | Size-in. | Size-mm |
|-------|-------|---------------|------------|-----------|
| 12127 | 420 | Floor Scraper | 9 X 4 1/2 | 229 X 114 |
| 12129 | 420B | Repl. Blade | 9 X 4 1/2 | 229 X 114 |
| 16453 | 720 | Floor Scraper | 14 X 4 1/2 | 356 X 114 |
| 16454 | 720B | Repl. Blade | 14 X 4 1/2 | 356 X 114 |
| 16398 | 820 | Floor Scraper | 20 X 4 1/2 | 508 X 114 |
| 16399 | 820B | Repl. Blade | 20 X 4 1/2 | 508 X 114 |

Floor Scrapers

- Used for surface preparation or cleaning of concrete forms and concrete and wood floors
- 54 x 1 1/8" (1372 x 28mm) steel handle securely bolts to blade stiffener
- Non-Slip grip provides comfort and durability
- Blade is made of high quality 20 gauge high carbon steel
- Inner/Outer Pack quantities listed in table

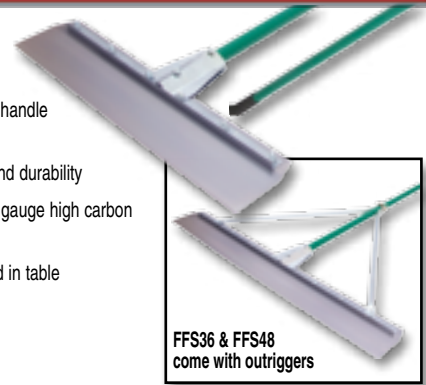

FFS36 & FFS48
come with outriggers

MADE IN
U.S.A.

MARSHALLTOWN The Premier Line

| EDI | Part# | Description | Size-in. | Size-mm | Inner/Outer |
|-------|---------|-------------|----------|---------|-------------|
| 18359 | FFS7 | Scraper | 7 | 178 | 4 / 4 |
| 18360 | FFS14 | Scraper | 14 | 356 | 4 / 4 |
| 18361 | FFS18 | Scraper | 18 | 457 | 4 / 4 |
| 18362 | FFS22 | Scraper | 22 | 559 | 4 / 4 |
| 18363 | FFS36 | Scraper | 36 | 914.4 | 1 / 1 |
| 18364 | FFS48 | Scraper | 48 | 1219 | 1 / 1 |
| 18365 | FFS7RB | Repl Blade | 7 | 178 | 4 / 4 |
| 18366 | FFS14RB | Repl Blade | 14 | 356 | 4 / 4 |
| 18367 | FFS18RB | Repl Blade | 18 | 457 | 4 / 4 |
| 18368 | FFS22RB | Repl Blade | 22 | 559 | 4 / 4 |
| 18369 | FFS36RB | Repl Blade | 36 | 914 | 1 / 1 |
| 18370 | FFS48RB | Repl Blade | 48 | 1219 | 1 / 1 |

Squeegees

- For our complete line of squeegees see pages 144-145



Floor Scraper

- Blade is spring steel
- Metal ferule connects 60" (1524mm) wood handle
- Size in table refers to blade
- Sold 6 per inner pack/6 per outer pack

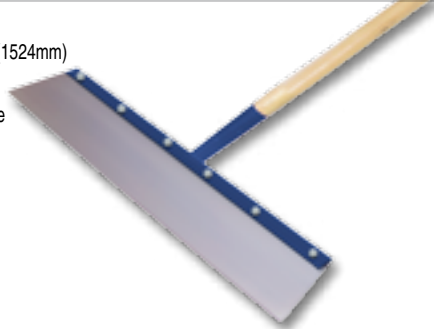

QLT BY MARSHALLTOWN

| EDI | Part# | Description | Size-in. | Size-mm |
|-------|-----------|-------------|----------|---------|
| 25490 | RED700506 | Scraper | 14 | 356 |
| 25491 | RED700518 | Scraper | 18 | 457 |
| 25496 | RED700855 | Scraper | 22 | 559 |
| 25500 | RED700506 | Repl. Blade | 14 | 356 |
| 25492 | RED700519 | Repl. Blade | 18 | 457 |
| 25497 | RED700856 | Repl. Blade | 22 | 559 |

Heavy Duty Forged Scraper

- Stamped from a single piece of steel
- D-Grip handles are one-piece high-density nylon
- Sold 1 per inner pack/1 per outer pack



MARSHALLTOWN The Premier Line

| EDI | Part# | Description | Size-in. | Size-mm |
|-------|-------|----------------------------|----------|---------|
| 17303 | FS47D | 7" (178 mm) Forged Scraper | 47 | 1194 |

Heavy Duty Forged Scraper

- Stamped from a single piece of steel
- Ash wood handle is 48" (1219mm)
- Blade size is 7" X 6" (178 X 152mm)
- Sold 1 per inner pack/1 per outer pack



MARSHALLTOWN The Premier Line

| EDI | Part# | Description | Size-in. | Size-mm |
|-------|------------|------------------|----------|---------|
| 24305 | RED802911A | Scraper w/Handle | 48 | 1219 |

Scraper

- Stamped steel head, shank pattern handle attachment
- Wood handle is 54" (1372mm)
- Blade size is 7" X 5" (178 X 127mm)
- Sold 1 per inner pack/1 per outer pack



QLT BY MARSHALLTOWN

| EDI | Part# | Description | Size-in. | Size-mm |
|-------|------------|------------------|----------|---------|
| 24304 | RED802910P | Scraper w/Handle | 54 | 1372 |

Scraper

- Homeowner grade
- Wood handle is 48" (1219mm)
- Blade size is 7" X 4 1/2" (178 X 115mm)
- Sold 1 per inner pack/1 per outer pack



QLT BY MARSHALLTOWN

| EDI | Part# | Description | Size-in. | Size-mm |
|-------|-----------|------------------|----------|---------|
| 24300 | RED802912 | Scraper w/Handle | 48 | 1219 |

"The Persuader" Floor Board Lifter

- Blade section is 2 1/4" (57mm) wide
- Designed for positive leverage with minimal damage
- Sold 1 per inner pack/10 per outer pack



MARSHALLTOWN The Premier Line

| EDI | Part# | Size-in. | Size-mm |
|-------|-------|----------|---------|
| 12012 | PB012 | 18 1/4 | 463 |

Tape Measure

- For our tape measures, details and size options **see page 28**



Levels

- Many styles to choose from
- For our complete line of levels, details and size options **see page 238**



High Strength Screeds

- Many sizes to choose from
- For our complete line of screeds, details and size options **see page 95**



Straight Edge Sets

- Made from extruded magnesium or aluminum; "L" shaped
- Aluminum set contains: 24, 36, 48, 58, and 72" lengths (610, 914, 1219, 1473 and 1829 mm)
- Magnesium set contains: 18, 24, 30, 36, 54, and 72" lengths (457, 610, 762, 914, 1372 and 1829mm)
- Sold 1 set per inner/outer pack



MADE IN
U.S.A

MARSHALLTOWN The Premier Line

| EDI | Part# | Description | Size-in. | Size-mm |
|-------|-------|-------------|-----------|-----------|
| 17815 | TS685 | Magnesium | 3½W x 1¼H | 89W x 31H |
| 15411 | TS686 | Aluminum | 3½W x 1¼H | 89W x 31H |

Tavy® Tile Spacers

- Made of stiffer material to keep line better and will not sink into mud as much
- Easy to use and remove
- 100 per bag
- Sold 1 bag per inner pack/24 per outer pack



MADE IN
U.S.A

MARSHALLTOWN The Premier Line

| EDI | Part# | Description | Size-in. | Size-mm |
|-------|-------|-------------|----------|---------|
| 15546 | 15546 | White | 1/8 | 3 |
| 15545 | 15545 | Blue | 3/16 | 5 |
| 15548 | 15548 | Orange | 1/4 | 6 |
| 15547 | 15547 | Grey | 3/8 | 10 |

Tile Spacers

- Available in different thicknesses
- For evenly spacing wall and floor tile
- Accurately sized for uniform spacing
- Easier to remove soft material
- Inner/outer pack quantities are shown in table



MADE IN
U.S.A

MARSHALLTOWN The Premier Line

| EDI | Part# | Size-in. | Size-mm | Qty | Inner/Outer |
|-------|-------|----------|---------|----------|-------------|
| 15249 | 15249 | 1/16 | 1.5 | 300/Bag | 1/45 |
| 15479 | 15479 | 1/8 | 3 | 200/Bag | 1/45 |
| 15480 | 15480 | 1/8 | 3 | 1600/Box | 1/12 |
| 15483 | 15483 | 3/16 | 4 | 150/Bag | 1/45 |
| 15484 | 15484 | 3/16 | 4 | 850/Box | 1/12 |
| 15487 | 15487 | 1/4 | 6 | 100/Bag | 1/45 |
| 15488 | 15488 | 1/4 | 6 | 550/Box | 1/12 |
| 15489 | 15489 | 3/8 | 10 | 50/Bag | 1/45 |
| 15490 | 15490 | 3/8 | 10 | 300/Box | 1/12 |

Tile Spacers

- Floor spacers made of soft, dense foam
- Allows for precise setting of floor tiles while providing some compression to compensate for inconsistent tiles
- Sold 1 per inner pack/12 per outer pack, 45 per inner pack/135 per outer pack where noted with *



QLT BY MARSHALLTOWN

| EDI | Part# | Description | Size-in. | Size-mm | Qty |
|-------|--------|-------------|----------|---------|----------|
| 15228 | 15228* | + | 1/8 | 3 | 200/bag |
| 15229 | 15229 | + | 1/8 | 3 | 1600/box |
| 15230 | 15230* | + | 3/16 | 5 | 150/bag |
| 15231 | 15231 | + | 3/16 | 5 | 950/box |
| 15232 | 15232* | + | 1/4 | 6 | 100/bag |
| 15234 | 15234* | + | 3/8 | 10 | 50/bag |
| 15235 | 15235 | + | 3/8 | 10 | 350/box |
| 15236 | 15236* | + | 1/2 | 13 | 35/bag |
| 15250 | 15250* | T | 1/8 | 3 | 200/bag |
| 15251 | 15251* | T | 3/16 | 5 | 150/bag |
| 15252 | 15252* | T | 1/4 | 6 | 100/bag |
| 15253 | 15253* | T | 3/8 | 10 | 50/bag |
| 15237 | 15237* | Long + | 1/8 | 3 | 150/bag |
| 15238 | 15238* | Long + | 3/16 | 5 | 100/bag |
| 15239 | 15239* | Long + | 1/4 | 6 | 75/bag |

Chalk & Chalk Boxes

- For details **see pages 238-239**



Suction Cups

- Helps protect against cuts and scrapes when handling glass or sheet metal
- Good for installing ceramic tiles
- Use on any non-porous surface
- 12121 lifts up to 8lbs., 12120 lifts up to 10lbs.
- Sold 1 per inner pack/12 per outer pack



QLT BY MARSHALLTOWN

| EDI | Part# | Size-in. | Size-mm |
|-------|-------|-----------------|---------|
| 12121 | 12121 | 2 $\frac{5}{8}$ | 67 |
| 12120 | 12120 | 3 $\frac{1}{4}$ | 83 |

Tile Spacer Popper

- Used to easily remove tile spacers
- Comfortable DuraSoft® handle with finger guard
- Sold 6 per inner pack/6 per outer pack



MADE IN U.S.A.

MARSHALLTOWN The Premier Line

| EDI | Part# | Size-in. | Size-mm |
|-------|--------|----------|---------|
| 15473 | TSP473 | N/A | N/A |

Grout Bags

- For our complete line of grout bags, details and size options see pages 17-18



Rubber Mallet

- White rubber leaves no marks
- Hardwood handle
- Sold 6 per inner pack/36 per outer pack



QLT BY MARSHALLTOWN

| EDI | Part# | Size-in. | Size-mm | Weight-oz. |
|-------|-------|----------|---------|------------|
| 15430 | 789 | 12 | 305 | 16 |

Tile Dolly

- Wood platform with non-marking wheels
- 400lb. (181 kg) working load rating
- Sold 1 per inner pack/1 per outer pack



QLT BY MARSHALLTOWN

| EDI | Part# | Size-in. | Size-mm |
|-------|--------|-----------------------|-----------|
| 19044 | TD9044 | 11 $\frac{1}{2}$ X 22 | 286 X 559 |

Silver Foxtail Brush

- For cleaning grout film from ceramic tile
- Stiff bristles with soft ends
- 13 $\frac{1}{2}$ " (343mm) long hardwood block
- Sold 1 per inner pack/12 per outer pack



MADE IN U.S.A.

MARSHALLTOWN The Premier Line

| EDI | Part# | Size-in. | Size-mm |
|-------|-------|---------------------|----------|
| 15434 | 6520 | 9 X 2 $\frac{5}{8}$ | 229 X 67 |

All-Terrain™ Knee Pads

- Injected gel provides superior comfort and protection
- All Terrain™ cover easily snaps off and on
- GKP368 with raised heel that evenly distributes body weight
- Extended feet absorb pressure while supporting the knee
- Adjustable clip fastener
- Double straps eliminate binding behind the knee
- Sold 1 pair per inner pack/6 pair per outer pack



MARSHALLTOWN The Premier Line

| EDI | Part# | Size-in. | Size-mm |
|-------|--------|-----------------------------------|-----------|
| 12138 | GKP368 | 9 $\frac{1}{2}$ X 6 $\frac{1}{2}$ | 242 X 165 |
| 12137 | GKP37 | 8 X 6 $\frac{1}{2}$ | 203 X 165 |

Gel Knee Pads

- Injected gel provides superior comfort and protection
- Tough nylon exterior for added durability
- Adjustable clip fastener
- Double straps eliminate binding behind the knee
- Sold 1 pair per inner pack/4 pair per outer pack



MARSHALLTOWN The Premier Line

| EDI | Part# | Size-in. | Size-mm |
|-------|-------|---------------------|-----------|
| 12136 | GKP36 | 8 X 6 $\frac{1}{2}$ | 203 X 165 |

Replacement Clips for Gel Knee Pads

- Replacement clips for GKP368, GKP37 and GKP36
- 4 clips per pack
- Sold 1 per inner pack/1 per outer pack



MARSHALLTOWN The Premier Line

| EDI | Part# | Description |
|-------|----------|-------------|
| 10899 | GKPClips | Repl. Clips |

Rubber Knee Pads

- Made from comfortable foam rubber
- Single web strap holds them in place
- Strap will not slip or bind
- 823 sold 1 pair per inner pack/20 pair per outer pack
- 16411 sold individually, 1 per inner/outer pack



MADE IN
U.S.A

MARSHALLTOWN The Premier Line

| EDI | Part# | Description | Size-in. | Size-mm |
|-------|-------|-------------------|----------|-----------|
| 16412 | 823 | Knee Pads | 7 X 5½ | 178 X 140 |
| 16411 | 16411 | Replacement Strap | N/A | N/A |

Neolite Knee Pads

- Tough construction stands up under hard wear
- Neolite pads are felt lined and shaped to fit your knee
- One leather strap holds them in place
- Strap will not slip or bind
- Sold 1 pair per inner pack/20 pair per outer pack



MADE IN
U.S.A

MARSHALLTOWN The Premier Line

| EDI | Part# | Size-in. | Size-mm |
|-------|-------|----------|-----------|
| 16410 | 821 | 7 X 7 | 178 X 178 |

Professional Knee Pads

- Foam liner to absorb pressure on knee joint
- Liner held in place by four studs
- Liner nests in the flexible, non-slip shell
- Secured by two easy-to-adjust straps
- Sold 1 pair per inner pack/12 pair per outer pack



QLT^{BY} MARSHALLTOWN

| EDI | Part# | Size-in. | Size-mm |
|-------|-------|----------|-----------|
| 16450 | KP1 | 6½ X 6 | 169 X 152 |

Racatac™

- Adjustable seat supports upper body weight and leaves feet free to control movement
- Knee pads allow knees to rest freely
- Work in shorts without bulky knee pads
- 2 or 3" (51 or 76mm) casters allow you to roll instead of bouncing around your work on your knees
- Keeps you elevated off your work and above wet, dirty or dusty floors
- Work on 1 or 2 knees
- Sold 1 per inner pack/1 per outer pack



01RAC3

Racatac™ w/Chest Support

- Allows you to work in a supported and leaning over position while sitting and kneeling on the Racatac™
- Adjustable seat supports upper body weight and leaves feet free to control movement
- Knee pads allow knees to rest freely
- Work in shorts without bulky knee pads
- 2 or 3" (51 or 76mm) casters allow you to roll instead of bouncing around your work on your knees
- Keeps you elevated off your work and above wet, dirty or dusty floors
- Work on 1 or 2 knees
- Sold 1 per inner pack/1 per outer pack



01RACCS

MADE IN
U.S.A

MARSHALLTOWN The Premier Line

| EDI | Part# | Description |
|-------|----------|---|
| 11091 | 01RAC | Racatac w/ 2" Casters |
| 11092 | 01RAC3 | Racatac w/ 3" Casters |
| 11093 | 01RACCS | Racatac w/ Chest Support and 2" Casters |
| 11094 | 01RAC3CS | Racatac w/ Chest Support and 3" Casters |

Replacement Parts

| EDI | Part# | Description | Inner/Outer |
|-------|---------|--------------------------------|-------------|
| 11095 | 05RCS | Racatac Chest Support | 1/6 |
| 11096 | MR1006 | 2" Replacement Caster (single) | 1/1 |
| 11097 | MR10063 | 3" Replacement Caster (single) | 1/1 |
| 11098 | MR1004 | Replacement Knee Pads (single) | 1/1 |

China Markers

- Paper wrapped pencils with tear string
- Perfect for marking on glass, plastic, film, paper, metal, rubber or any other smooth surface
- Each inner pack contains 12 markers
- Sold 1 per inner pack/10 per outer pack

QLT BY MARSHALLTOWN

| EDI | Part# | Description | Size-in. | Size-mm |
|-------|-------|-------------|----------|---------|
| 15438 | B77 | Black | N/A | N/A |
| 15439 | R79 | Red | N/A | N/A |
| 15440 | W92 | White | N/A | N/A |

Bucket Heater

- Designed to continuously heat buckets of water
- 1000 watt, 120 volt power will heat water over 150°
- Ideal for use on cold winter days
- Stainless steel guard
- Sold 1 per inner pack/12 per outer pack



MADE IN
U.S.A.

MARSHALLTOWN The Premier Line

| EDI | Part# | Size-in. | Size-mm |
|-------|-------|----------|---------|
| 19043 | 742G | N/A | N/A |

Extension Roller

- Adjustable design, plated to prevent rust
- No axle projections, allowing flush work into corners
- For use on counter tops, walls and resilient flooring
- Roller is 7³/₈ X 1¹/₂" (187 X 38mm)
- Sold 2 per inner pack/24 per outer pack



QLT BY MARSHALLTOWN

| EDI | Part# | Size-in. | Size-mm |
|-------|-------|----------|------------|
| 16007 | ER007 | 17 to 27 | 432 to 686 |

"J" Roller

- Recessed end permits rolling near back splashes or walls
- Designed for use by plastic laminate installers
- Roller is 3" (76mm) wide; 1¹/₂" (38mm) diameter
- Sold 6 per inner pack/60 per outer pack



QLT BY MARSHALLTOWN

| EDI | Part# | Size-in. | Size-mm |
|-------|-------|----------|---------|
| 16008 | JR008 | 13 | 330 |

Wax Bowl Ring Kit

- Can be used for all floor type toilets
- Lasting gas-proof, water-proof, odor-proof seal between bowl and flange
- Will not dry out, harden or lose its "tackiness"
- Kit contains bowl ring, washers, nuts and bolts
- **RWG5** is to be used in remodeling jobs where a thicker floor is installed
- Sold 1 per inner pack/1 per outer pack



QLT BY MARSHALLTOWN

| EDI | Part# | Wax Thickness | Hardware Length |
|-------|-------|--|--|
| 13731 | RWG5 | 1 ¹ / ₄ " (32mm) | 3 ¹ / ₂ " (89mm) |
| 15495 | RWG6 | ³ / ₄ " (19mm) | 2 ¹ / ₄ " (57mm) |

Safety Gear

- For our complete line of safety products **see pages 249-250**



Square Notches



Notches are shown actual size



$\frac{3}{8}'' \times \frac{3}{8}'' \times \frac{3}{8}''$
10 x 10 x 10 mm



$\frac{1}{2}'' \times \frac{1}{2}'' \times \frac{1}{2}''$
13 x 13 x 13 mm



$\frac{19}{32}'' \times \frac{19}{32}'' \times \frac{13}{16}''$
15 x 15 x 30 mm

U Notches



Notches are shown actual size



$\frac{3}{16}'' \times \frac{3}{16}'' \times \frac{5}{8}''$
4.5 x 4.5 x 16 mm



$\frac{1}{2}'' \times \frac{1}{2}'' \times 2''$
13 x 13 x 51 mm



$\frac{3}{16}'' \times \frac{11}{32}'' \times \frac{15}{64}''$
4.5 x 8.5 x 46 mm



$\frac{3}{8}'' \times \frac{1}{2}'' \times \frac{1}{2}''$
10 x 13 x 38 mm



$\frac{3}{16}'' \times \frac{3}{8}'' \times \frac{13}{4}''$
4.5 x 10 x 44 mm



$\frac{5}{16}'' \times \frac{5}{16}'' \times \frac{3}{4}''$
8 x 8 x 19 mm



$\frac{1}{4}'' \times \frac{1}{4}'' \times \frac{1}{2}''$
6 x 6 x 38 mm



$\frac{9}{16}'' \times \frac{5}{8}'' \times 1''$
14 x 16 x 25 mm



$\frac{1}{4}'' \times \frac{3}{8}'' \times \frac{1}{4}''$
6 x 10 x 32 mm



$\frac{5}{8}'' \times \frac{5}{8}'' \times 1''$
16 x 16 x 25 mm

• For a Notched Trowel dimension key **see page 205**

Stainless Steel Trowels

- Aluminum alloy mounting riveted to hard tempered blade
- U Notched **5776SS**
- Blade size is 4½ X 11" (114 X 279mm) unless specified otherwise
- For EIFS applications
- Choice of resilient DuraSoft® handle or smooth, natural finish hardwood handle
- Trowels with notches on the right side only and 4½ X 12" (114 X 305mm) blade indicated with *
- Sold 6 per inner pack/6 per outer pack



5776SSD



U.S. Patent No. 5,522,111

MARSHALLTOWN The Premier Line

| EDI | Part# | Size-in. | Size-mm | Handle |
|-------|----------|------------|----------------|--------|
| 10705 | 5705SSD | ¾ X ¾ X ⅝ | 4.5 X 4.5 X 16 | |
| 10712 | 5705SS | ¾ X ¾ X ⅝ | 4.5 X 4.5 X 16 | |
| 10704 | 5704SSD | ¾ X ¾ X 1¼ | 4.5 X 10 X 44 | |
| 10711 | 5704SS | ¾ X ¾ X 1¼ | 4.5 X 10 X 44 | |
| 10706 | 5706SSD | ¼ X ¼ X 1½ | 6 X 6 X 38 | |
| 10713 | 5706SS | ¼ X ¼ X 1½ | 6 X 6 X 38 | |
| 10707 | 5707SSD | ⅝ X ⅝ X ¾ | 8 X 8 X 19 | |
| 10714 | 5707SS | ⅝ X ⅝ X ¾ | 8 X 8 X 19 | |
| 10709 | 5709SSD | ¾ X ½ X 1½ | 10 X 13 X 38 | |
| 10716 | 5709SS | ¾ X ½ X 1½ | 10 X 13 X 38 | |
| 10710 | 5776SSD* | ½ X ½ X 2 | 13 X 13 X 51 | |
| 10717 | 5776SS* | ½ X ½ X 2 | 13 X 13 X 51 | |
| 10708 | 5708SSD | ⅝ X ⅝ X 1 | 16 X 16 X 25 | |
| 10715 | 5708SS | ⅝ X ⅝ X 1 | 16 X 16 X 25 | |

Carbon Steel Trowels

- Aluminum alloy mounting riveted to a hard tempered steel blade
- Choice of resilient DuraSoft® handle or hardwood handle
- Trowels with notches on the right side only indicated with *
- Sold 6 per inner pack/6 per outer pack

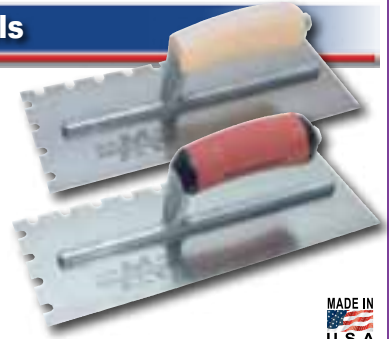

U.S. Patent No. 5,522,111

MARSHALLTOWN The Premier Line

4½ X 11" (102 X 279) Blade

| EDI | Part# | Notch Size-in. | Notch Size-mm | Notch | Handle |
|-------|---------|----------------|----------------|-------|--------|
| 10719 | 5705SD | ¾ X ¾ X ⅝ | 4.5 X 4.5 X 16 | U | |
| 10725 | 5705S | ¾ X ¾ X ⅝ | 4.5 X 4.5 X 16 | U | |
| 10718 | 5704SD | ¾ X ¾ X 1¼ | 4.5 X 10 X 44 | U | |
| 10724 | 5704S | ¾ X ¾ X 1¼ | 4.5 X 10 X 44 | U | |
| 10720 | 5706SD | ¼ X ¼ X 1½ | 6 X 6 X 38 | U | |
| 10726 | 5706S | ¼ X ¼ X 1½ | 6 X 6 X 38 | U | |
| 10721 | 5707SD | ⅝ X ⅝ X ¾ | 8 X 8 X 19 | U | |
| 10727 | 5707S | ⅝ X ⅝ X ¾ | 8 X 8 X 19 | U | |
| 15779 | 5779S | ¾ X ¾ X ¾ | 10 X 10 X 10 | SQ | |
| 15820 | 5779SD | ¾ X ¾ X ¾ | 10 X 10 X 10 | SQ | |
| 10723 | 5709SD | ¾ X ½ X 1½ | 10 X 13 X 38 | U | |
| 10729 | 5709S | ¾ X ½ X 1½ | 10 X 13 X 38 | U | |
| 15775 | 775S | ½ X ½ X ½ | 13 X 13 X 13 | SQ | |
| 15804 | 775SD | ½ X ½ X ½ | 13 X 13 X 13 | SQ | |
| 15774 | 5774S* | 1⅞ X 1⅞ X 1⅞ | 15 X 15 X 30 | SQ | |
| 15818 | 5774SD* | 1⅞ X 1⅞ X 1⅞ | 15 X 15 X 30 | SQ | |
| 10722 | 5708SD | ⅝ X ⅝ X 1 | 16 X 16 X 25 | U | |
| 10728 | 5708S | ⅝ X ⅝ X 1 | 16 X 16 X 25 | U | |

4½ X 12" (102 X 305mm) Blade

| EDI | Part# | Notch Size-in. | Notch Size-mm | Notch | Handle |
|-------|---------|----------------|----------------|-------|--------|
| 15772 | 5772S* | ¾ X 1½ X 1⅝ | 4.5 X 8.5 X 46 | U | |
| 15773 | 5772SD* | ¾ X 1½ X 1⅝ | 4.5 X 8.5 X 46 | U | |
| 15783 | 5783S | ¼ X ¾ X 1¼ | 6 X 10 X 32 | U | |
| 15822 | 5783SD | ¼ X ¾ X 1¼ | 6 X 10 X 32 | U | |
| 15777 | 5776S* | ½ X ½ X 2 | 13 X 13 X 51 | U | |
| 15778 | 5776SD* | ½ X ½ X 2 | 13 X 13 X 51 | U | |
| 15784 | 5784S | ¾ X ⅝ X 1 | 14 X 16 X 25 | U | |
| 15785 | 5784SD | ¾ X ⅝ X 1 | 14 X 16 X 25 | U | |

DuraFlex Trowels

- PermaShape® guarantees trowel will maintain original flat shape
- Flat, yet flexible blade makes applications easier with more consistent finish
- Available with a long or short mounting which allows for more flexibility
- Highest grade hardened and tempered golden stainless steel blade, properly shaped and fastened with stainless steel rivets
- Withstands pressure of hard-troweling
- Sold 1 per inner pack/12 per outer pack, 6 per outer pack where noted with *

Golden Stainless!

MOST FLEXIBLE TROWEL AVAILABLE



MADE IN U.S.A.

U.S. Patent Nos. 5,697,265; 5,522,111; & 5,791,009

MARSHALLTOWN The Premier Line

| EDI | Part# | Mounting | Blade-in. | Blade-mm | Handle |
|-------|-----------|----------------------------|-----------|-----------|--------|
| 14468 | 4468DF | 7 $\frac{3}{4}$ " (197mm) | 12 X 5 | 305 X 127 | |
| 14467 | 4467DFD | 7 $\frac{3}{4}$ " (197mm) | 12 X 5 | 305 X 127 | |
| 14658 | 4658DFL | 9 $\frac{3}{4}$ " (248mm) | 12 X 5 | 305 X 127 | |
| 14663 | 4663DFDL | 9 $\frac{3}{4}$ " (248mm) | 12 X 5 | 305 X 127 | |
| 14470 | 4470DF | 7 $\frac{3}{4}$ " (197mm) | 13 X 5 | 330 X 127 | |
| 14469 | 4469DFD | 7 $\frac{3}{4}$ " (197mm) | 13 X 5 | 330 X 127 | |
| 14665 | 4665DFL | 9 $\frac{3}{4}$ " (248mm) | 13 X 5 | 330 X 127 | |
| 14681 | 4681DFDL | 9 $\frac{3}{4}$ " (248mm) | 13 X 5 | 330 X 127 | |
| 14472 | 4472DF | 9 $\frac{3}{4}$ " (248mm) | 14 X 5 | 356 X 127 | |
| 14471 | 4471DFD | 9 $\frac{3}{4}$ " (248mm) | 14 X 5 | 356 X 127 | |
| 14682 | 4682DFL | 11 $\frac{1}{8}$ " (295mm) | 14 X 5 | 356 X 127 | |
| 14683 | 4683DFDL | 11 $\frac{1}{8}$ " (295mm) | 14 X 5 | 356 X 127 | |
| 14474 | 4474DF* | 11 $\frac{1}{8}$ " (295mm) | 16 X 5 | 406 X 127 | |
| 14473 | 4473DFD* | 11 $\frac{1}{8}$ " (295mm) | 16 X 5 | 406 X 127 | |
| 14694 | 4694DFL* | 13 $\frac{3}{8}$ " (346mm) | 16 X 5 | 406 X 127 | |
| 14713 | 4713DFDL* | 13 $\frac{3}{8}$ " (346mm) | 16 X 5 | 406 X 127 | |

PermaShape® "Flat"

- Guaranteed to stay flat after use
- For details and size options on PermaShape® trowels **see page 149**

Golden Stainless!



PermaShape® "Flat"

- Guaranteed to stay flat after use
- For details and size options on PermaShape® trowels **see page 150**

Stainless Steel!



Golden Stainless

- For details and size options on Golden Stainless trowels **see page 43**

Golden Stainless!



Bright Stainless

- For details and size options on Bright Stainless trowels **see page 43**

Stainless Steel!



Insulator's Finishing Trowel

- Highest grade hardened and tempered spring steel blade, properly shaped
- Aluminum alloy Xtralite® mounting is lightweight but very strong
- Resilient DuraSoft® handle provides a soft feel, reduces fatigue and offers excellent durability
- Tapered blade measures 4 $\frac{1}{4}$ " (114mm) at the heel and 3 $\frac{1}{4}$ " (89mm) at the toe
- Sold 1 per inner pack/12 per outer pack



MADE IN U.S.A.

U.S. Patent No. 5,522,111

MARSHALLTOWN The Premier Line

| EDI | Part# | Size-in. | Size-mm |
|-------|---------|---|----------------|
| 12141 | MXS91AD | 10 $\frac{1}{2}$ X 4 $\frac{1}{2}$ heel | 267 X 114 heel |

Plastic Texturing Trowel

- Unique composition blade material
- Has the ability to retain its flat shape
- Can be used for embedding the mesh in EIFS applications or texturing
- Curved, smooth, natural finish hardwood handle
- Sold 1 per inner pack/12 per outer pack



MADE IN U.S.A

MARSHALLTOWN The Premier Line

| EDI | Part# | Size-in. | Size-mm |
|-------|-------|----------|-----------|
| 12161 | 2161 | 11" X 5" | 292 X 127 |

Plastic Texturing Trowel

- Blade made of durable plastic for long wear
- The mounting is permanently bonded to the blade
- The bottom of the blade is smooth so it will not mark the surface while troweling
- Resilient handle feels soft and is comfortable to use
- Sold 12 per inner pack/48 per outer pack



QLTTM MARSHALLTOWN

| EDI | Part# | Size-in. | Size-mm |
|-------|-------|----------|-----------|
| 12160 | 2160 | 11 X 5½" | 279 X 140 |

Plastic Texturing Trowel

- Blade made of durable plastic for long wear
- The mounting is permanently bonded to the blade
- The bottom of the blade is smooth so it will not mark the surface while troweling
- Won't rust or corrode, easy to clean
- Sold 10 per inner pack/60 per outer pack



QLTTM MARSHALLTOWN

| EDI | Part# | Size-in. | Size-mm |
|-------|--------|----------|-----------|
| 10668 | PTT668 | 11 X 5½" | 279 X 140 |

EIFS Outside Corner Trowels

- Lightweight tool made from one piece of 4¼" (108mm) long stainless steel
- Has a 90° angle between the blades
- Resilient DuraSoft® handle with integral finger guard
- Designed to be used with the inside corner trowels for finishing decorative details
- Sold 2 per inner pack/2 per outer pack



MADE IN U.S.A

U.S. Patent Nos. 5,327,612 & 5,446,941

MARSHALLTOWN The Premier Line

| EDI | Part# | Size-in. | Size-mm |
|-------|-------|----------|---------|
| 15767 | 5767D | 1" | 25 |
| 15768 | 5768D | 1½" | 38 |
| 15769 | 5769D | 2" | 51 |

EIFS Inside Corner Trowels

- Lightweight tool made from one piece of 4¼" (108mm) long stainless steel
- Has a 90° angle between the blades
- Resilient DuraSoft® handle with integral finger guard
- Designed to be used with the outside corner trowels for finishing decorative details
- Sold 2 per inner pack/2 per outer pack



MADE IN U.S.A

U.S. Patent Nos. 5,327,612 & 5,446,941

MARSHALLTOWN The Premier Line

| EDI | Part# | Size-in. | Size-mm |
|-------|-------|----------|---------|
| 15786 | 5786D | 1" | 25 |
| 15787 | 5787D | 1½" | 38 |
| 15788 | 5788D | 2" | 51 |

Angle Trowels

- Lightweight tool made from one piece of 4¼" (108mm) long stainless steel
- Blade is formed at a 45° angle
- Resilient DuraSoft® handle with integral finger guard
- Sold 2 per inner pack/2 per outer pack



MADE IN U.S.A

U.S. Patent Nos. 5,327,612 & 5,446,941

MARSHALLTOWN The Premier Line

| EDI | Part# | Size-in. | Size-mm |
|-------|-------|----------|---------|
| 15796 | 5796D | 1" | 25 |
| 15798 | 5798D | 2" | 51 |

Bullnose Corner Trowels

- For our Bullnose Corner Trowels, details and size options **see page 160**



Ornamental Tools

- For details and size options on Ornamental Tools **see page 184**



Bucket Trowels

- Forged from a single piece of high carbon steel
- For our complete line of bucket trowels, details and size options **see pages 9-10**



Putty and Joint Knives

- For our complete line of Joint and Putty knives, details, and size options **see pages 155-158**



Bucket Opener

- For details on our Bucket Opener **see page 195**



Notched Margin Trowels

- For our complete line of Notched Margin Trowels, details, and size options **see page 211**



Hawks

- For our complete line of hawks, details and size options **see pages 162-163**



Margin Trowels

- Forged from a single piece of high carbon steel
- Tempered, ground and polished from toe to heel
- For our complete line of margin trowels, details and size options **see pages 11**

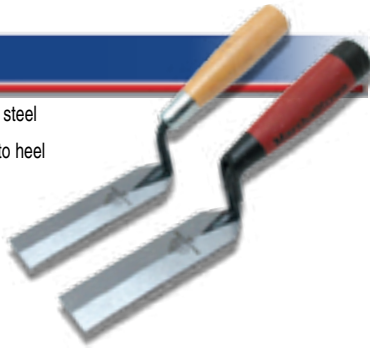

Mixers

- For our complete line of mixers, details and size options **see pages 163-164**



Pointing Trowels

- Forged from a single piece of high carbon steel for unsurpassed strength
- For our complete line of pointing trowels, details and size options **see pages 10**



Compressor and Hopper Guns

- For our compressor, hopper guns, repair parts and accessories and details **see pages 188-190**



The ENFORCER™ Portable Texture Sprayer

- Great for E.I.F.S. applications
- 2.5-gallon capacity
- Up to 1.75 gpm flow rate
- Piston seal cleans the inner tank wall for less mess
- Empty weight of unit - 15 lbs.
- Full weight of unit - 45 lbs.
- 15 psi. max. air in tank no matter what compressor is set at for hopper gun
- Quick-Release top cap with pressure release pin easily removes for cleaning and filling
- Refill using a mud pump for maximum efficiency
- Sprays knockdown, popcorn, orange peel and splatter textures
- Minimum compressor requirement is 5.0 CFM at 40 psi.
- **E400C** for international customers only
- Sold 1 per inner pack/1 per outer pack



U.S. Patent No. 7,997,511



OTHERS



Lightweight



Heavy

Weight



Clean



Messy

Cleanliness



Quick & Easy



Awkward & Difficult

Filling

Portable Like a Hopper... Professional Like a Rig!

MARSHALLTOWN The Premier Line

| EDI | Part# | Description |
|-------|---------------|---|
| 10400 | E400 | ENFORCER™ |
| 10460 | E400C | ENFORCER™ w/ international conversion coupler |
| 10145 | E400NB | ENFORCER™ w/o backpack |

Neoprene Floats

- For our Neoprene Floats, details and size options **see page 178**



Rapid Rasps™

- Removes as much EIFS foam per stroke as carbide style rasps at a fraction of the price
- Long wearing stainless steel blade is rugged and will not rust
- Aggressive pierced teeth are easy to control and won't leave lines
- Resilient DuraSoft® handle is comfortable, ergonomic and holds up to abuse
- Sold 1 per inner pack/12 per outer pack, 6 per outer pack where noted with*



MARSHALLTOWN The Premier Line

| EDI | Part# | Size-in. | Size-mm |
|-------|--------|----------|-----------|
| 16090 | RR214 | 14 X 2 | 356 X 51 |
| 16091 | RR414 | 14 X 4 | 356 X 102 |
| 16092 | RR614* | 14 X 6 | 356 X 152 |
| 16093 | RR814* | 14 X 8 | 356 X 203 |

Sanding Rasps

- Flat aluminum backing plate in two sizes
- 12 grit sandpaper is included
- Can be used with pressure sensitive adhesive or with plain backing sandpaper
- Sold 2 per inner pack/2 per outer pack

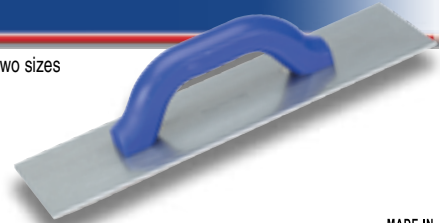

MARSHALLTOWN The Premier Line

| EDI | Part# | Size-in. | Size-mm |
|-------|-------|----------|-----------|
| 15744 | 5744 | 14 X 4 | 356 X 102 |
| 15745 | 5745 | 14 X 8 | 356 X 203 |

Rasp Sandpaper

- 12 grit
- Pressure sensitive adhesive back
- Packed in bags of 10 sheets
- Sold 1 per inner pack/1 per outer pack

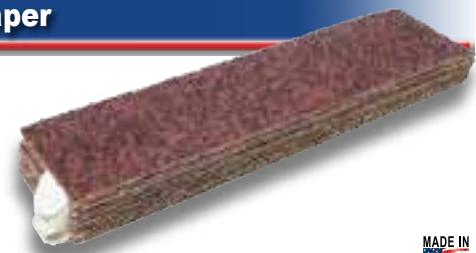

MARSHALLTOWN The Premier Line

| EDI | Part# | Size-in. | Size-mm |
|-------|-------|----------|-----------|
| 15748 | 5748 | 14 X 4 | 356 X 102 |
| 15749 | 5749 | 14 X 8 | 356 X 203 |

To order: Phone: 800-888-0127 • Fax: 800-477-6341 • Visit our Website at www.MARSHALLTOWN.com

Darbies, Slicker & Featheredges

- For details and size options on our darbies, slicker or featheredges
see page 185



Sacramento Go Devil

- For details
see page 185

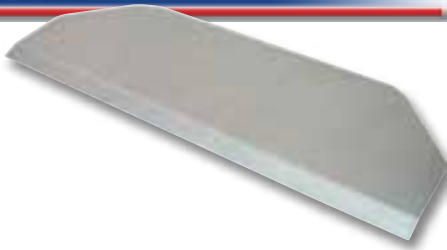

Utility Saws

- Five styles to choose from
- For our complete line of utility saws, details and size options
see pages 173-174



Knives

- Several styles of knives to choose from
- For our complete line of knives, details and size options
see page 235



Snips

- For details
see page 221



Chalk & Chalk Boxes

- For details
see pages 238-239



Sponges

- For our complete line of Sponges, details and size options
see page 214



Plastic Bristle Stucco Dash Brush

- Wood block with 8" (203mm) long handle
- Yellow plastic bristles are 5½" (140mm) long
- 10 rows of bristles, 5 rows deep
- Sold 1 per inner pack/12 per outer pack



MADE IN
U.S.A

MARSHALLTOWN The Premeir Line

| EDI | Part# | Size-in. | Size-mm |
|-------|-------|----------|----------|
| 16556 | 6556 | 5½ X 3 | 146 X 76 |

Bassine Bristle Stucco Dash Brush

- Wood block with 8" (203mm) long handle
- Brown bassine bristles are 4" (102mm) long
- 10 rows of bristles, 5 rows deep
- Sold 1 per inner pack/12 per outer pack



MADE IN
U.S.A

MARSHALLTOWN The Premeir Line

| EDI | Part# | Size-in. | Size-mm |
|-------|-------|----------|----------|
| 16555 | 6555 | 6 X 3¾ | 152 X 86 |

Brushes

- For our complete line of Bucket Brushes and Scrub Brushes details and size options
see pages 28-29



DuraSoft® Utility Knives

- Push button blade release
- **9058** has sliding storage that holds five extra blades
- **9059** has butterfly storage that holds five extra blades
- DuraSoft® handle for increased comfort and reduced fatigue
- Cut string safely and easily
- **804** & **E2411** replacement blades sold separately
- One display box contains 12 knives
- Sold 12 per inner pack/48 per outer pack



MARSHALLTOWN The Premier Line

| EDI | Part # | Description | Size-in. | Size-mm |
|-------|--------|-------------------|----------|---------|
| 19058 | 9058 | Slide Storage | 6¼ | 158 |
| 19059 | 9059 | Butterfly Storage | 6½ | 165 |

DuraSoft® Utility Knife

- Push-button blade release
- Strong metal frame
- Durasoft® handle for increased comfort and reduced fatigue
- One display box contains 12 individually packaged knives
- Sold 12 per inner pack/72 per outer pack



MARSHALLTOWN The Premier Line

| EDI | Part# | Size-in. | Size-mm |
|-------|-------|----------|---------|
| 19070 | 9070 | 6 | 152 |

DuraSoft® Auto-retractable Knife

- Blade retracts automatically for safety when not in use
- Butterfly storage compartment holds five extra blades
- Durasoft® handle for increased comfort and reduced fatigue
- Magnet holds blade during replacement
- One display box contains 12 individually packaged knives
- Sold 12 per inner pack/48 per outer pack



MARSHALLTOWN The Premier Line

| EDI | Part# | Size-in. | Size-mm |
|-------|-------|----------|---------|
| 19069 | 9069 | 6 3/4 | 171 |

Utility Knife

- Tough aluminum body
- Two extra blades are stored in the handle, will hold up to five extra blades
- Blade adjusts and locks in three positions
- **804** & **E2411** replacement blades sold separately
- Sold 12 per inner pack/12 per outer pack



MARSHALLTOWN The Premier Line

| EDI | Part # | Description | Size-in. | Size-mm |
|-------|--------|------------------|----------|---------|
| 16383 | 803 | Adjustable Blade | 6 | 152 |

Fixed Blade Utility Knife

- Magnet holds blade in place during replacement
- Large knob allows for easy opening
- Zinc alloy body
- Includes three blades, stored in handle
- **804** & **E2411** replacement blades sold separately
- One display box contains 12 knives
- Sold 12 per inner pack/72 per outer pack



MARSHALLTOWN The Premier Line

| EDI | Part# | Size-in. | Size-mm |
|-------|-------|----------|---------|
| 13998 | 998 | 5¾ | 146 |

Utility Knife Blades

- 0.025" (0.64mm) thick
- Inner/outer pack quantities shown in table



MARSHALLTOWN The Premier Line

| EDI | Part# | Description | Inner/Outer |
|-------|-------|-----------------|-------------|
| 16384 | 804 | 100 Std. Blades | 1/1 |
| 19719 | E2411 | 100 Hook Blades | 1/25 |

Folding Utility Knife

- One-hand opening and closing
- One-step blade change
- Lightweight aluminum handle
- One display box contains 12 knives
- Sold 12 per inner pack/48 per outer pack



DLT BY MARSHALLTOWN

| EDI | Part# | Size-in. | Size-mm |
|-------|-------|----------|---------|
| 19063 | 9063 | 5¾ | 149 |

Auto-Load Break-Off Blade Knife

- 18mm/8 point break-off blade
- Soft grip handle for added comfort and increased grip
- Auto-load mechanism allows for quick and easy blade changes
- Blade automatically locks when in position
- Heavy-duty for commercial grade wallcovering
- Packed with 8 extra blades inside handle
- One display box contains 12 knives
- Sold 12 per inner pack/48 per outer pack



MARSHALLTOWN The Premier Line

| EDI | Part# | Size-in. | Size-mm |
|-------|-------|----------|---------|
| 19053 | 9053 | 6¼ | 159 |

Auto-Load Break-Off Blade Knife

- 18mm/8 point break-off blade
- Soft grip handle for added comfort and increased grip
- Auto-load mechanism allows for quick and easy blade changes
- Blade automatically locks when in position
- Heavy-duty for commercial grade wallcovering
- Packed with 5 extra blades inside handle
- One display box contains 12 knives
- Sold 12 per inner pack/72 per outer pack



MARSHALLTOWN The Premier Line

| EDI | Part# | Size-in. | Size-mm |
|-------|-------|----------|---------|
| 19052 | 9052 | 6¾ | 171 |

18mm Auto-Load Break-off Blade

- 18mm 8 point blade
- 3 extra blades stored inside handle
- Auto-load mechanism allows for quick and easy blade changes
- Blade automatically locks when in position
- One display box contains 12 individually packaged knives, sold 12 per inner pack/72 per outer pack



QLT^{BY}MARSHALLTOWN

| EDI | Part# | Size-in. | Size-mm |
|-------|-------|----------|---------|
| 19072 | 9072 | 6 3/4 | 171 |



Knives look great on their own or in Display Packs

18mm Break-off Blade

- 18mm/8 point break-off blade with auto-lock feature
- Metal slide track and plastic outer grip
- Packed with 2 extra blades inside handle
- Sold 12 per inner pack/144 per outer pack



QLT^{BY}MARSHALLTOWN

| EDI | Part# | Size-in. | Size-mm |
|-------|-------|----------|----------|
| 19064 | 9064 | 6¼ X 1½ | 159 X 38 |

Break-Off Blade Knife

- 9mm/13 point break-off blade
- Soft grip handle for added comfort and increased grip
- Blade automatically locks when in position
- End cap used to snap blades
- Packed with 2 extra blades inside handle
- E176, E177 & E182 replacement blades sold separately
- One display box contains 24 knives
- Sold in display box quantities only, Sold 24 per inner pack/288 per outer pack



MARSHALLTOWN The Premier Line

| EDI | Part# | Size-in. | Size-mm |
|-------|-------|----------|---------|
| 19051 | 9051 | 5½ | 140 |

Mini Pro Break-Off Blade Knife

- 9mm break-off blade with auto-lock feature
- Metal slide track and plastic outer grip
- Heavy-duty for commercial grade wallcovering
- Comes with 2 extra blades inside handle
- E176, E177 & E182 replacement blades sold separately
- Sold 24 per inner pack/288 per outer pack



QLT^{BY}MARSHALLTOWN

| EDI | Part# | Size-in. | Size-mm |
|-------|-------|----------|----------|
| 19065 | 9065 | 5½ X ¾ | 140 X 19 |

Break-Off Blade Knife

- Non-locking 9mm break-off blade
- For wallcovering, hobby, craft and household use
- All metal casing
- E176, E177 & E182 replacement blades sold separately
- Sold 24 per inner pack/288 per outer pack

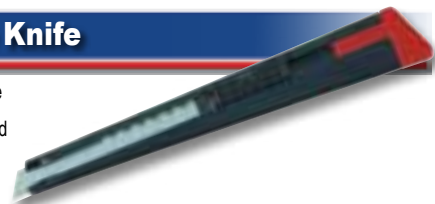

QLT^{BY}MARSHALLTOWN

| EDI | Part# | Size-in. | Size-mm |
|-------|-------|----------|----------|
| 19066 | 9066 | 5½ X ¾ | 140 X 19 |

9mm Replacement Blades

- For 9051, 9065 and 9066
- Inner/outer pack quantities are shown in table

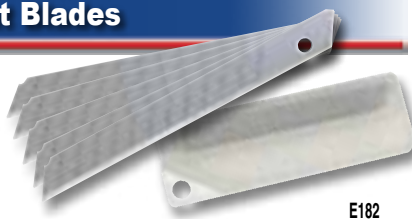

E182

QLT BY MARSHALLTOWN

| EDI | Part# | Description | Inner/Outer |
|-------|-------|------------------------|-------------|
| 19590 | E176 | Pack of 5 Blades | 12/144 |
| 19591 | E177 | Pack of 100 Blades | 1/50 |
| 19594 | E182 | Dispenser of 10 Blades | 10/200 |

DuraSoft® Scraper

- Accepts standard single edge razor blades
- Durasoft® handle for increased comfort and reduced fatigue
- Comes with 10 replacement blades
- One display box contains 12 individually packaged knives
- Sold 12 per inner pack/48 per outer pack



MARSHALLTOWN The Premier Line

| EDI | Part# | Size-in. | Size-mm |
|-------|-------|----------|---------|
| 19074 | 9074 | 6 | 152 |

Shears

- For our complete line of shears **see page 201**



Bolt Cutters

- For general cutting of medium steel, soft bolts, rods and chains
- Replacement heads available
- For our complete line of bolt cutters **see page 104**



Staplers

- For our full line of staplers **see page 220**



6-in-1 Screwdriver

- 8" (203mm) overall length
- Cushioned soft-grip handle for increased comfort
- All-in-one screwdriver with six popular bit sizes:
Slotted: 3/16 and 1/4"
Phillips: #1 and #2
Nut Drivers: 1/4 and 5/16"
- Sold 12 per inner pack/72 per outer pack; SD6SGDP sold 12 per box/6 boxes per container



QLT BY MARSHALLTOWN

| EDI | Part# | Description | Size-in. | Size-mm |
|-------|---------|---------------------|----------|---------|
| 10120 | SD6SG | Screwdriver | 8 | 203 |
| 10139 | SD6SGDP | Screwdriver Display | N/A | N/A |

19-in-1 Ratcheting Screwdriver

- 9½" (241mm) overall length
- Cushioned soft-grip handle for increased comfort
- All-in-one screwdriver with 19 popular bit sizes:
Slotted: 3/16, 1/4 and 5/16"
Phillips: #1, #2 and #3
Square: #1 and #2
Torx®: T10, T15, T20 and T25
Hex Key: 5/64, 1/8, 3/16 and 1/4"
Nut Drivers: 1/4, 5/16 and 7/16"
- Sold 6 per inner pack/54 per outer pack



QLT BY MARSHALLTOWN

| EDI | Part# | Size-in. | Size-mm |
|-------|---------|----------|---------|
| 10144 | SDR19SG | 9½ | 241 |

Estwing Claw Framing Hammers

- For driving and removing nails
- Full polished, forged one piece tool steel
- Shock Reduction Grip
- Sold 4 per inner pack/20 per outer pack



E3-16S

E3-30SM

E3-22SM

MADE IN
U.S.A

MARSHALLTOWN The Premier Line

| EDI | Part# | Description | Length-in. | Length-mm | Weight-oz. |
|-------|---------|-------------|------------|-----------|------------|
| 11430 | E3-16S | Smooth Face | 13 | 330 | 16 oz |
| 11431 | E3-20S | Smooth Face | 13 | 330 | 20 oz |
| 11276 | E3-22SM | Milled Face | 16 | 406 | 22 oz |
| 11277 | E3-24SM | Milled Face | 16 | 406 | 24 oz |
| 11278 | E3-28SM | Milled Face | 16 | 406 | 28 oz |
| 11279 | E3-30SM | Milled Face | 16 | 406 | 30 oz |

Claw Framing Hammers

- For driving and removing nails
- Full polished, forged one piece tool steel
- CFH292 and CFH293 sold 4 per inner pack/24 per outer pack, CFH293M and CFH280 sold 4 per inner pack/12 per outer pack, CFH281 sold 2 per inner pack/12 per outer pack



MARSHALLTOWN The Premier Line

| EDI | Part# | Description | Length-in. | Length-mm | Weight-oz. |
|-------|---------|-------------|------------|-----------|------------|
| 11292 | CFH292 | Smooth Face | 13 | 330 | 16 oz |
| 11293 | CFH293 | Smooth Face | 13 | 330 | 20 oz |
| 11294 | CFH293M | Milled Face | 13 | 330 | 20 oz |
| 11280 | CFH280 | Milled Face | 16 | 406 | 22 oz |
| 11281 | CFH281 | Milled Face | 16 | 406 | 28 oz |

Crick® Levels

- Standard 3-Piece Level is strong and durable
- Accurate to .015" in length of level
- Optional rubber end cushions
- 3 year warranty
- Inner/Outer pack quantities listed in table

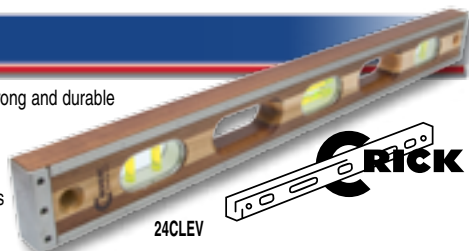

MARSHALLTOWN The Premier Line

| EDI | Part# | Vial Color | Size-in. | Size-mm | Inner/Outer |
|-------|---------|------------|----------|---------|-------------|
| 11074 | 24CLEV | Green | 24 | 610 | 1/16 |
| 18707 | 24CLEVC | Clear | 24 | 610 | 1/16 |
| 11075 | 36CLEV | Green | 36 | 914 | 1/8 |
| 18708 | 36CLEVC | Clear | 36 | 914 | 1/8 |
| 11076 | 42CLEV | Green | 42 | 1067 | 1/8 |
| 18709 | 42CLEVC | Clear | 42 | 1067 | 1/8 |
| 11077 | 48CLEV | Green | 48 | 1219 | 1/8 |
| 18710 | 48CLEVC | Clear | 48 | 1219 | 1/8 |

Crick Levels with Rubber End Cushions

| EDI | Part# | Vial Color | Size-in. | Size-mm | Inner/Outer |
|-------|-----------|------------|----------|---------|-------------|
| 18711 | 24CLEVCRB | Clear | 24 | 610 | 1/16 |
| 18715 | 24CLEVGRB | Green | 24 | 610 | 1/16 |
| 18712 | 36CLEVCRB | Clear | 36 | 914 | 1/8 |
| 18716 | 36CLEVGRB | Green | 36 | 914 | 1/8 |
| 18713 | 42CLEVCRB | Clear | 42 | 1067 | 1/8 |
| 18717 | 42CLEVGRB | Green | 42 | 1067 | 1/8 |
| 18714 | 48CLEVCRB | Clear | 48 | 1219 | 1/8 |
| 18718 | 48CLEVGRB | Green | 48 | 1219 | 1/8 |

Crick Levels Care Kit

| EDI | Part# | Description | Inner/Outer |
|-------|-------|----------------|-------------|
| 11078 | 11078 | Level Care Kit | 1/16 |

Kit includes: 6 lenses, 12 lens clips, clip removal tool, 1 pint linseed oil, 1 hanging hook

Box Beam Levels

- 1 horizontal and 2 plumb vials
- Available with and without magnets
- Shock absorbent end caps
- Vials electronically aligned
- Unbreakable acrylic block vials
- Horizontal vial has magnifying lens and luminous backing for greater visibility in low light
- Ribbed for easier handling and greater stability
- 30 year warranty against vial leakage
- Sold 1 per inner pack/1 per outer pack



MARSHALLTOWN The Premier Line

| EDI | Part# | Handles | Magnets | Size-in. | Size-mm |
|-------|-------|---------|---------|----------|---------|
| 16070 | 24NH | No | No | 24 | 610 |
| 16072 | 24H2 | Yes | No | 24 | 610 |
| 16075 | 24NHM | No | Yes | 24 | 610 |
| 16071 | 48NH | No | No | 48 | 1219 |
| 16076 | 48HM | Yes | Yes | 48 | 1219 |
| 16074 | 78H2 | Yes | No | 78 | 1981 |
| 16077 | 78HM | Yes | Yes | 78 | 1981 |

Line Level

- Break resistant reversed line hooks for positive hold
- Lightweight design eliminates line sag
- Sold 10 per inner pack/100 per outer pack



MARSHALLTOWN The Premier Line

| EDI | Part# | Size-in. | Size-mm |
|-------|-------|----------|---------|
| 16554 | 16554 | N/A | N/A |

Chalk Boxes

- Available in aluminum or plastic housing
- Easy-to-hold, sure-grip shape
- Easy to fill by simply sliding the nylon cover open
- Self-locking handle and plated anchoring ring
- Cotton line is highly absorbent for positive marking and is replaceable
- Can also be used as a plumb bob
- Sold 6 per inner pack/6 per outer pack



MARSHALLTOWN The Premier Line

| EDI | Part# | Description | Size-ft. | Size-M |
|-------|-------|-------------|----------|--------|
| 15422 | 64110 | Standard | 100 | 30.5 |
| 15423 | 64310 | High Speed | 100 | 30.5 |

Chalk

- 8 oz. refill bottles
- Sold 6 per inner pack/24 per outer pack



MARSHALLTOWN The Premier Line

| EDI | Part# | Description | Size-in. | Size-mm |
|-------|-------|-------------|----------|---------|
| 15426 | 64901 | Blue | N/A | N/A |
| 15424 | 64902 | Red | N/A | N/A |

5 pc. Pencil Sharpener Set

- Set includes 4 carpenter pencils and a handy sharpener
- One display box contains 12 individually packaged sets
- Sold 12 per inner pack/144 per outer pack



MARSHALLTOWN The Premier Line

| EDI | Part# | Size-in. | Size-mm |
|-------|-------|----------|---------|
| 19075 | 9075 | N/A | N/A |

Tape Measures

- Soft feel grip
- Self retracting
- Wide belt clip
- Auto locking mechanism
- Push button to retract tape
- Sold 1 per inner pack/1 per outer pack



QLT-MARSHALLTOWN

| EDI | Part# | Description | Length |
|-------|-------|-----------------------|--------|
| 10516 | 10516 | Standard tape measure | 25' |
| 12986 | BST16 | Brick spacing | 16' |
| 12987 | MST16 | Modular spacing | 16' |

Freight Van & Truck Washing Brush

- Densely filled fiber bristles, staple set in a plastic block
- Acid resistant
- Threaded handle hole
- Bristle length is 2" (51mm)
- **WARNING:** Prior to use, test an inconspicuous area to make sure finish is scratch resistant
- Sold 1 per inner pack/12 per outer pack



MADE IN U.S.A.

MARSHALLTOWN The Premier Line

| EDI | Part# | Size-in. | Size-mm |
|-------|--------|----------|---------|
| 10797 | TWB797 | 10 | 254 |

Utility Broom

- Made of select broom corn and fiber on a heavy duty wood handle
- Sewn four times and reinforced with wire band
- Designed for sweeping smooth and rough surfaces with moderate to heavy debris
- Ideal for construction site cleanup
- Sold 1 per inner pack/1 per outer pack



MARSHALLTOWN The Premier Line

| EDI | Part# | Size-in. | Size-mm |
|-------|-------|----------|------------|
| 10372 | UB371 | 57 X 12 | 1448 X 305 |

Dust Pans

- Black baked enamel finish is durable with beveled edge
- Corrugated ribs add to strength
- Made of heavy 20 - gauge steel
- Sold 1 per inner pack/12 per outer pack



DP16

MARSHALLTOWN The Premier Line

| EDI | Part# | Size-in. | Size-mm |
|-------|-------|----------|---------|
| 10373 | DP12 | 12 | 305 |
| 10374 | DP16 | 16 | 406 |

Ranger Series Wood Handle Shovels

- Forward turned step for secure foot placement
- Ash handle
- Open back design
- Two handle choices: straight or "D" grip
- Size in table refers to size of blade
- Sold 1 per inner pack/5 per outer pack, Sold 1 per inner pack/6 per outer pack where noted with *



QLT-MARSHALLTOWN

| EDI | Part# | Description | Handle | Size-in | Size-mm | Handle |
|-------|-----------|----------------------|-----------|---------|-----------|--------|
| 11180 | 14DSOBW* | Round Drain Spade | 63"(1600) | 5 X 14 | 127 X 356 | |
| 11181 | 14DSOBWD* | Round Drain Spade | 45"(1143) | 5 X 14 | 127 X 356 | |
| 24221 | RED804003 | Straight Drain Spade | 30"(762) | 5 X 14 | 127 X 356 | |

Badger Series Shovels

- Heavy 14 gauge heat treated blade with 11" tab socket to prevent handle breakage
- Forward turned step for secure foot placement
- Available with double riveted solid core fiberglass, or ash wood handle
- Size in table refers to size of blade
- Sold 1 per inner pack/5 per outer pack



MADE IN
U.S.A.

MARSHALLTOWN The Premier Line

| EDI | Part# | Description | Size-in. | Size-mm | Handle |
|-------|-------------|-----------------------|----------|-----------|--------|
| 24096 | RED8015101 | Open Back Round Point | 8¾ X 12 | 222 X 305 | |
| 24131 | RED8011G113 | Open Back Square End | 9½ X 12 | 241 X 305 | |

Wolverine Series Wood Handle Shovels

- Heavy 14 gauge blade with tapered socket and collar for added strength
- Available in round point or garden spade
- Forward turned step for secure foot placement
- Single riveted ash handle
- D grip handle measures 30" (767mm), long handle measures 48" (1219mm)
- Size in table refers to size of blade
- Sold 1 per inner pack/5 per outer pack



MADE IN
U.S.A.

MARSHALLTOWN The Premier Line

| EDI | Part# | Description | Size-in. | Size-mm | Handle |
|-------|-----------|--------------|----------|-----------|--------|
| 24070 | RED801001 | Round Shovel | 8¾ X 12 | 219 X 305 | |
| 24194 | RED801004 | Garden Spade | 7¼ X 12 | 184 X 305 | |
| 24197 | RED801011 | Garden Spade | 7¼ X 12 | 184 X 305 | |

240

Wolverine Series Steel Scoop Shovels

- Heavy gauge heat treated blade
- Long socket and collar for added strength
- Available with single riveted solid core fiberglass, or ash wood handle
- Size in table refers to size of blade
- D grip ash handle length is 30" (762mm)
- D grip fiberglass handle length is 27" (686mm)
- Long ash and fiberglass handles length are 48" (1219mm)
- Sold 6 per inner pack/6 outer pack



MADE IN
U.S.A.

MARSHALLTOWN The Premier Line

| EDI | Part# | Description | Size-in | Size-mm | Handle |
|-------|-------------|-----------------|-----------|-----------|--------|
| 24164 | RED801008 | D Hndl Scoop | 11 X 15 | 279 X 381 | |
| 24187 | RED8011G123 | D Hndl Scoop | 11 X 15 | 279 X 381 | |
| 24165 | RED801009 | Long Hndl Scoop | 11 X 15 | 279 X 381 | |
| 24186 | RED8011G122 | Long Hndl Scoop | 11 X 15 | 279 X 381 | |
| 24167 | RED801114 | D Hndl Scoop | 13½ X 14½ | 343 X 369 | |

Wolverine Series Aluminum Scoop Shovels

- Aluminum blade
- Available with single riveted solid core fiberglass, or ash wood handle
- Size in table refers to size of blade
- D grip fiberglass handle length is 27" (686mm)
- Long fiberglass handle length is 48" (1219mm)
- Sold 6 per inner pack/6 outer pack



MADE IN
U.S.A.



MARSHALLTOWN The Premier Line

| EDI | Part# | Description | Size-in | Size-mm | Handle |
|-------|-------------|-----------------|----------|-----------|--------|
| 24190 | RED806012FG | D Hndl Scoop | 15¼ X 19 | 387 X 483 | |
| 24191 | RED806013FG | Long Hndl Scoop | 15¼ X 19 | 387 X 483 | |

Shingle Shovel

- Heavy 16 gauge blade with tapered socket and collar for added strength
- Back rolled step
- Heavy duty fulcrum welded to back for added leverage
- Size in table refers to size of blade
- D grip ash handle length is 30" (762mm)
- Sold 6 per inner pack/6 outer pack



MADE IN
U.S.A.

MARSHALLTOWN The Premier Line

| EDI | Part# | Description | Size-in | Size-mm | Handle |
|-------|------------|----------------|---------|-----------|--------|
| 24250 | RED807009D | Straight Blade | 7¼ X 12 | 184 X 305 | |

Trenching Shovels

- Make trench cleaning quick and easy
- Four color coded sizes to choose from
- Single riveted ash handle is 48" (1219mm)
- Size in table refers to width and length of blade
- Sold 6 per inner pack/6 outer pack

MADE IN
U.S.A.



MARSHALLTOWN The Premier Line

| EDI | Part# | Description | Size-in. | Size-mm |
|-------|-----------|--------------|----------|-----------|
| 24083 | RED801300 | Blue Blade | 3 X 12 | 76 X 305 |
| 24084 | RED801400 | Orange Blade | 4 X 12 | 102 X 305 |
| 24087 | RED801500 | Red Blade | 5 X 12 | 127 X 305 |
| 24089 | RED801600 | Green Blade | 6 X 12 | 152 X 305 |

Pitchforks

- One piece forged head
- Lacquered ash wood handle
- Available in four or five prong head
- Digging pitchfork has thicker tines for durability
- Digging fork head measures 7¼ X 12" (184 X 305mm)
- Manure fork head measures 9½ X 13" (241 X 330mm)
- Size in table refers to length of handle
- Sold 6 per inner pack/6 outer pack



MADE IN
U.S.A.

MARSHALLTOWN The Premier Line

| EDI | Part# | Description | Size-in | Size-mm | Handle |
|-------|-----------|---------------------|---------|---------|--------|
| 24205 | RED802404 | 4 Tine Digging Fork | 30 | 762 | |
| 24206 | RED802504 | 4 Tine Manure Fork | 48 | 1219 | |
| 24207 | RED802505 | 5 Tine Manure Fork | 48 | 1219 | |
| 24208 | RED802506 | 4 Tine Manure Fork | 30 | 762 | |
| 24209 | RED802507 | 5 Tine Manure Fork | 30 | 762 | |

Forged Scraper

- Stamped from a single piece of steel
- D-Grip handles are one-piece high-density nylon
- Sold 1 per inner pack/1 per outer pack



MADE IN
U.S.A

MARSHALLTOWN The Premier Line

| EDI | Part# | Description | Size-in. | Size-mm |
|-------|-------|----------------------------|----------|---------|
| 17303 | FS47D | 7" (178 mm) Forged Scraper | 47 | 1194 |

Scraper

- Homeowner grade
- Wood handle is 48" (1219mm)
- Blade size is 7" X 4½" (178 X 115mm)
- Sold 1 per inner pack/1 per outer pack



QLT **MARSHALLTOWN**

| EDI | Part# | Description | Size-in. | Size-mm |
|-------|-----------|------------------|----------|---------|
| 24300 | RED802912 | Scraper w/Handle | 48 | 1219 |

Heavy Duty Forged Scraper

- Stamped from a single piece of steel
- Ash wood handle is 48" (1219mm)
- Blade size is 7" X 6" (178 X 152mm)
- Sold 1 per inner pack/1 per outer pack



MARSHALLTOWN The Premier Line

| EDI | Part# | Description | Size-in. | Size-mm |
|-------|------------|------------------|----------|---------|
| 24305 | RED802911A | Scraper w/Handle | 48 | 1219 |

Industrial Rakes

- One-piece forged head for strength and durability
- Available with 60" (1524mm) fiberglass handle or ash handle
- Sold 6 per inner pack/6 per outer pack

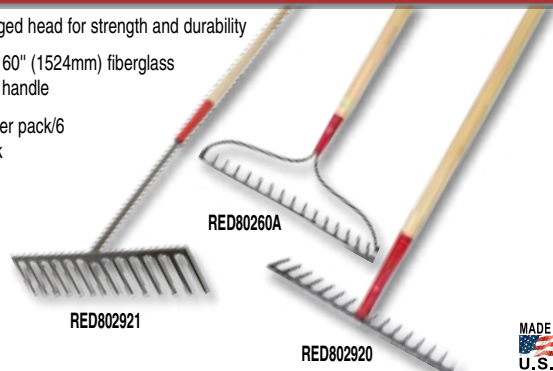

MADE IN
U.S.A

MARSHALLTOWN The Premier Line

| EDI | Part# | Description | Size-in | Size-mm | Handle |
|-------|-------------|-----------------------|---------|---------|--------|
| 24285 | RED802060A | 16-Tine Bow Rake | 15 | 381 | |
| 24286 | RED802060FG | 16-Tine Bow Rake | 15 | 381 | |
| 24270 | RED802920 | 16-Tooth Road Rake | 15½ | 394 | |
| 24271 | RED802921 | 14-Tooth Asphalt Rake | 15½ | 394 | |

Scraper

- Stamped steel head, shank pattern handle attachment
- Wood handle is 54" (1372mm)
- Blade size is 7" X 5" (178 X 127mm)
- Sold 1 per inner pack/1 per outer pack



QLT **MARSHALLTOWN**

| EDI | Part# | Description | Size-in. | Size-mm |
|-------|------------|------------------|----------|---------|
| 24304 | RED802910P | Scraper w/Handle | 54 | 1372 |

Rake

- 1" (25mm) spacing between 16 curved tines
- One-piece forged head for strength and durability
- Fiberglass handle
- Bow acts as shock absorber, provides additional strength for working with heavier materials
- Sold 6 per inner pack/6 per outer pack



QLT **MARSHALLTOWN**

| EDI | Part# | Description | Size-in. | Size-mm | Handle |
|-------|---------|------------------|----------|---------|--------|
| 11182 | RAKE16F | 16-Tine Bow Rake | 61 | 1,549 | |

Picks and Mattocks

- One-piece forged head for strength and durability
- Available with 36" (914mm) fiberglass handle or ash handle
- Used for cutting roots and breaking up soil
- Size in table refers to head size
- Sold 6 per inner pack/6 per outer pack



MADE IN U.S.A.

MARSHALLTOWN The Premier Line

| EDI | Part# | Description | Size-in | Size-mm | Handle |
|-------|-------------|------------------------|---------|---------|--------|
| 24374 | RED803321F | Clay Pick | 23 | 584 | |
| 24375 | RED803321FG | Clay Pick | 23 | 584 | |
| 24377 | RED803421F | Pick/Cutter Mattock | 20 | 508 | |
| 24378 | RED803421FG | Pick/Cutter Mattock | 20 | 508 | |
| 24380 | RED803521F | Cutter Mattock | 16 | 406 | |
| 24381 | RED803521FG | Cutter Mattock | 16 | 406 | |
| 24369 | RED804045 | Hickory Repl Handle | 36 | 914 | |
| 24370 | RED804138 | Fiberglass Repl Handle | 36 | 914 | |

Tile Probes

- Heavy duty steel construction
- Used for locating irrigation or utility lines
- Sold 6 per inner pack/6 per outer pack

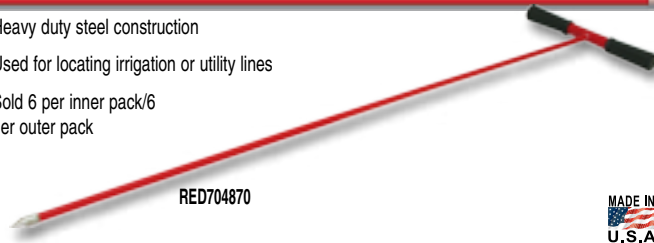

MADE IN U.S.A.

MARSHALLTOWN The Premier Line

| EDI | Part# | Description | Size-in | Size-mm |
|-------|-----------|------------------|---------|---------|
| 25845 | RED704870 | Steel Tile Probe | 48 | 1219 |
| 25848 | RED704911 | Probe Tip | N/A | N/A |

Garden Hoe

- Welded hoe head
- Handle is 48" (1219mm)
- Size in table refers to size of blade
- Sold 1 per inner pack/5 per outer pack



QLT BY MARSHALLTOWN

| EDI | Part# | Description | Size-in. | Size-mm | Handle |
|-------|------------|-------------|-----------|-----------|--------|
| 24288 | RED802254A | Ash Handle | 7 X 4 1/4 | 178 X 108 | |

Tool Hooks

- Clean, easy way to carry your hand tool when not in use
- Fits easily on belt or back pocket
- Small but very sturdy cross section holds almost any tool
- Sold 12 per inner pack/12 per outer pack



MADE IN U.S.A.

MARSHALLTOWN The Premier Line

| EDI | Part# | Size-in. | Size-mm |
|-------|-------|----------|---------|
| 14289 | 14289 | N/A | N/A |

Tool Holster

- Rugged construction and long-wearing protective insert
- Stitched, then reinforced with rivets
- Riveted belt loop for secure and easy portability
- Holds a variety of small hand tools
- Sold 1 per inner pack/1 per outer pack



MADE IN U.S.A.

MARSHALLTOWN The Premier Line

| EDI | Part# | Size-in. | Size-mm |
|-------|-------|----------|---------|
| 11163 | ATH63 | N/A | N/A |

Drywall Pouch

- Two genuine leather drywall pouches to choose from
- To see more styles and details [see page 177](#)



MADE IN U.S.A.

Hammer Holder

- Made of genuine top grain russet leather
- Steel cradle turns up slightly to let hammer swing freely when walking or kneeling
- Slotted for belt
- Sold 1 per inner pack/1 per outer pack

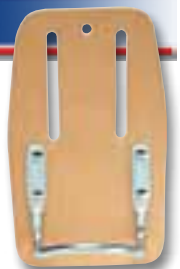

MADE IN U.S.A.

MARSHALLTOWN The Premier Line

| EDI | Part# | Description | Size-in. | Size-mm |
|-------|-------|---------------|----------|---------|
| 16654 | 874 | Hammer Holder | N/A | N/A |

Work Belt

- Made of top grain strap leather
- Multi-purpose work belt for all tool pouches
- Basket weave design
- Fits waists from 29 to 46" (737 to 1168mm)
- Sold 1 per inner pack/1 per outer pack



MADE IN U.S.A.

MARSHALLTOWN The Premier Line

| EDI | Part# | Size-in. | Size-mm |
|-------|-------|-------------|----------|
| 16651 | 871 | 1 1/4 Width | 44 Width |

All-Terrain™ Knee Pads

- Injected gel provides superior comfort and protection
- All Terrain™ cover easily snaps off and on
- **GKP368** with raised heel that evenly distributes body weight
- Extended feet absorb pressure while supporting the knee
- Adjustable clip fastener
- Double straps eliminate binding behind the knee
- Sold 1 pair per inner pack/6 pair per outer pack



MARSHALLTOWN The Premier Line

| EDI | Part# | Size-in. | Size-mm |
|-------|--------|----------|-----------|
| 12138 | GKP368 | 9½ X 6½ | 242 X 165 |
| 12137 | GKP37 | 8 X 6½ | 203 X 165 |

Gel Knee Pads

- Injected gel provides superior comfort and protection
- Tough nylon exterior for added durability
- Adjustable clip fastener
- Double straps eliminate binding behind the knee
- Sold 1 pair per inner pack/4 pair per outer pack



MARSHALLTOWN The Premier Line

| EDI | Part# | Size-in. | Size-mm |
|-------|-------|----------|-----------|
| 12136 | GKP36 | 8 X 6½ | 203 X 165 |

Replacement Clips for Gel Knee Pads

- Replacement clips for **GKP368**, **GKP37** and **GKP36**
- 4 clips per pack
- Sold 1 per inner pack/1 per outer pack

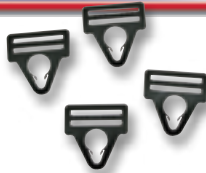

MARSHALLTOWN The Premier Line

| EDI | Part# | Description |
|-------|----------|-------------|
| 10899 | GKPClips | Repl. Clips |

Rubber Knee Pads

- Made from comfortable foam rubber
- Single web strap holds them in place
- Strap will not slip or bind
- 823 sold 1 pair per inner pack/20 pair per outer pack
- 16411 sold individually, 1 per inner/outer pack



MADE IN
U.S.A

MARSHALLTOWN The Premier Line

| EDI | Part# | Description | Size-in. | Size-mm |
|-------|-------|-------------------|----------|-----------|
| 16412 | 823 | Knee Pads | 7 X 5½ | 178 X 140 |
| 16411 | 16411 | Replacement Strap | N/A | N/A |

Neolite Knee Pads

- Tough construction to stand up under hard wear
- Neolite pads are felt lined and shaped to fit your knee
- One leather strap holds them in place
- Strap will not slip or bind
- Sold 1 pair per inner pack/20 pair per outer pack



MADE IN
U.S.A

MARSHALLTOWN The Premier Line

| EDI | Part# | Size-in. | Size-mm |
|-------|-------|----------|-----------|
| 16410 | 821 | 7 X 7 | 178 X 178 |

Professional Knee Pads

- Foam liner to absorb pressure on knee joint
- Liner held in place by four studs
- Liner nests in the flexible, non-slip shell
- Secured by two easy-to-adjust straps
- Sold 1 pair per inner pack/12 pair per outer pack



QLT^{BY}-MARSHALLTOWN

| EDI | Part# | Size-in. | Size-mm |
|-------|-------|----------|-----------|
| 16450 | KP1 | 6½ X 6 | 169 X 152 |

Plain Toe Boots

- Available in white or black PVC
- Reinforced seamless molded construction
- 100% waterproof
- Anti-Skid™ outsole and heel
- Great for construction, general maintenance, and utilities
- Over the foot style, men's sizes shown in table
- Height - 15" from floor
- Sold 6 pair per inner pack/6 pair per outer pack



MADE IN
U.S.A.

MARSHALLTOWN The Premier Line

Black PVC Boots

| EDI | Part# | Size-U.S. | Size-U.K. | Size-Europe |
|-------|-------|-----------|-----------|-------------|
| 13468 | BPT6 | 6 | 5.5 | 38 |
| 14081 | BPT7 | 7 | 6.5 | 40 |
| 14076 | BPT8 | 8 | 7.5 | 42 |
| 14077 | BPT9 | 9 | 8.5 | 43 |
| 14078 | BPT10 | 10 | 9.5 | 44 |
| 14079 | BPT11 | 11 | 10.5 | 45 |
| 14080 | BPT12 | 12 | 11.5 | 46 |
| 13469 | BPT13 | 13 | 12.0 | 47 |

White PVC Boots

| EDI | Part# | Size-U.S. | Size-U.K. | Size-Europe |
|-------|-------|-----------|-----------|-------------|
| 13435 | WPT6 | 6 | 5.5 | 38 |
| 13437 | WPT7 | 7 | 6.5 | 40 |
| 14084 | WPT8 | 8 | 7.5 | 42 |
| 14085 | WPT9 | 9 | 8.5 | 43 |
| 14086 | WPT10 | 10 | 9.5 | 44 |
| 14087 | WPT11 | 11 | 10.5 | 45 |
| 13466 | WPT12 | 12 | 11.5 | 46 |
| 13467 | WPT13 | 13 | 12.0 | 47 |

Bucket Bags

- Durable, water resistant nylon construction
- Ideal for use with standard 5 gallon buckets
- Slip bag over bucket to turn your bucket into a tool organizer
- Pockets on inside and outside
- Will not damage or gouge walls like standard squared toolboxes
- **10844** has 42 exterior triple row pockets, 10 interior pockets, 1 key chain lobster claw clasp and 1 tape loop
- **10847** has 33 exterior pockets, 1 covered pocket with Velcro® closure, 14 interior pockets, 1 key chain lobster claw clasp, 1 tape loop and 1 hammer loop
- Sold 1 per inner pack/12 per outer pack



10847



*Tools not included

MARSHALLTOWN The Premier Line

| EDI | Part# | Description | Size-in. | Size-mm |
|-------|-------|------------------|----------|---------|
| 10844 | 10844 | Bucket Bag | N/A | N/A |
| 10847 | 10847 | Super Bucket Bag | N/A | N/A |

Bucket Grit Guard Insert

- Place the insert in the bottom of any 12" (305 mm) diameter bucket/pail
- Simply rub your sponge or mitt across the insert while cleaning grout or washing your vehicle
- Radial Surface Design extracts particles and contaminants from sponges, mitts, and brushes
- Gravity causes dirt and debris to settle to the bottom of the container so your wash water stays clean
- Overall height is 2½" (64mm)
- Sold 1 per inner pack/12 per outer pack

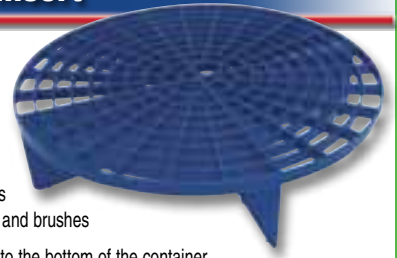

MADE IN
U.S.A.

MARSHALLTOWN The Premier Line

| EDI | Part# | Width-in. | Width-mm |
|-------|-------|-----------|----------|
| 10371 | GG371 | 10¼ | 260 |

Duffel Bag

- Royal blue duffel bag with white screen printed logo
- Sold 1 per inner pack/1 per outer pack



MARSHALLTOWN The Premier Line

| EDI | Part# | Size-in. | Size-mm |
|-------|-------|----------|---------|
| 17839 | 17839 | N/A | N/A |

30" Open Tote

- Holds up to 80 lbs.
- Sturdy polyester and aluminum construction
- Inner and outer pockets to hold all of your **MARSHALLTOWN** tools*
- Adjustable shoulder strap
- Sold 1 per inner pack/1 per outer pack



*Tools not included



MARSHALLTOWN The Premier Line

| EDI | Part# | Size-in. | Size-mm |
|-------|--------|----------|---------|
| 10388 | TOTE30 | 30 | 762 |

Tool Bags

- Made of heavy duty canvas with lock stitched seams
- Waterproof masonite bottom with four metal studs
- **831L** has a leather bottom for extra durability
- Built on a 12-gauge steel frame
- Handles, billets and buckles are riveted to frame
- Inside pocket to prevent small tools from being lost
- Sold 1 per inner pack/12 per outer pack



MARSHALLTOWN The Premier Line

| EDI | Part# | Size-in. | Size-mm |
|-------|-------|----------|-----------|
| 16431 | 831 | 20 X 15 | 508 X 381 |
| 14169 | 831L | 20 X 15 | 508 X 381 |

Small Nylon Tool Bag

- Made of a double layer of durable, water-resistant nylon with a reinforced bottom panel
- Padded handles and an adjustable shoulder strap
- Has 1 outside pocket, 2 outside web pockets and an enclosed compartment at base of bag
- Sold 1 per inner pack/6 per outer pack



MARSHALLTOWN The Premier Line

| EDI | Part# | Size-in. | Size-mm |
|-------|-------|-----------------|--------------------|
| 16201 | NB201 | 15½L X 9W X 9½H | 394L X 229W X 241H |

Medium Nylon Tool Bag

- Made of a double layer of durable, water-resistant nylon with a reinforced bottom panel
- Padded handles and an adjustable shoulder strap
- Has 6 multi-purpose inside pockets, 6 outside pockets and 6 outside web pockets
- Sold 1 per inner pack/6 per outer pack



MARSHALLTOWN The Premier Line

| EDI | Part# | Size-in. | Size-mm |
|-------|-------|------------------|--------------------|
| 16202 | NB202 | 20L X 8½W X 13½H | 508L X 216W X 343H |

Large Nylon Tool Bag

- Made of a double layer of durable, water-resistant nylon with a reinforced bottom panel
- Padded handles and an adjustable shoulder strap
- Has 14 multi-purpose inside pockets, 6 outside pockets and 4 outside web pockets
- Sold 1 per inner pack/6 per outer pack



MARSHALLTOWN The Premier Line

| EDI | Part# | Size-in. | Size-mm |
|-------|-------|-------------------|--------------------|
| 16203 | NB203 | 24L X 10½W X 13½H | 610L X 267W X 343H |

Canvas Jacket

- Navy blue cotton canvas jacket with removable lining embroidered logo
- Sold 1 per inner pack/1 per outer pack



MARSHALLTOWN The Premier Line

| EDI | Size |
|-------|------|
| 17820 | S |
| 17821 | M |
| 17822 | L |
| 17823 | XL |
| 17824 | XXL |
| 17825 | XXXL |

Golf Jacket

- Navy blue jacket with white embroidered logo
- Sold 1 per inner pack/1 per outer pack



MARSHALLTOWN The Premier Line

| EDI | Size |
|-------|------|
| 17307 | S |
| 17308 | M |
| 17309 | L |
| 17310 | XL |
| 17311 | XXL |
| 17312 | XXXL |

Women's Jacket

- Harbor blue zip jacket with dark blue embroidered logo
- Sold 1 per inner pack/1 per outer pack



MARSHALLTOWN The Premier Line

| EDI | Size |
|-------|----------|
| 17441 | Medium |
| 17442 | Large |
| 17443 | X-Large |
| 17448 | XX-Large |

Hooded Jacket

- Navy blue cotton jacket with removable lining and white embroidered logo
- Sold 1 per inner pack/1 per outer pack



MARSHALLTOWN The Premier Line

| EDI | Size |
|-------|------|
| 17332 | S |
| 17333 | M |
| 17334 | L |
| 17335 | XL |
| 17337 | XXL |
| 17338 | XXXL |

Dress Shirts

- Available in two colors: Khaki or Blue with embroidered logos
- Sold 1 per inner pack/1 per outer pack

MARSHALLTOWN The Premier Line

| EDI-Khaki | Size |
|-----------|------|
| 17319 | S |
| 17320 | M |
| 17321 | L |
| 17322 | XL |
| 17323 | XXL |
| 17324 | XXXL |



Fleece-Lined Jacket

- Navy blue fleece-lined jacket with white embroidered logo
- Sold 1 per inner pack/1 per outer pack



MARSHALLTOWN The Premier Line

| EDI | Size |
|-------|------|
| 17915 | S |
| 17916 | M |
| 17917 | L |
| 17918 | XL |
| 17919 | XXL |
| 17920 | XXXL |



MARSHALLTOWN The Premier Line

| EDI-Blue | Size |
|----------|------|
| 17325 | S |
| 17326 | M |
| 17327 | L |
| 17328 | XL |
| 17329 | XXL |
| 17331 | XXXL |

Women's Blouse

- Black blouse with charcoal embroidered logo
- Sold 1 per inner pack/1 per outer pack



MARSHALLTOWN The Premier Line

| EDI | Size |
|-------|----------|
| 17435 | Small |
| 17437 | Medium |
| 17438 | Large |
| 17439 | X-Large |
| 17440 | XX-Large |

Denim Shirt

- Long sleeve shirt with embroidered navy logo
- Sold 1 per inner pack/1 per outer pack



MARSHALLTOWN The Premier Line

| EDI | Size |
|-------|------|
| 17861 | S |
| 17862 | M |
| 17863 | L |
| 17864 | XL |
| 17865 | XXL |
| 17866 | XXXL |

Navy Women's V-Neck

- Navy Blue V-Neck with white embroidered logo
- Sold 1 per inner pack/1 per outer pack

MARSHALLTOWN The Premier Line

| EDI | Size |
|-------|----------|
| 17431 | Medium |
| 17432 | Large |
| 17433 | X-Large |
| 17434 | XX-Large |



Polo Shirts

- Available in three colors: Navy with white embroidered logo, Tan with brown embroidered logo or Black with royal blue embroidered logo
- Sold 1 per inner pack/1 per outer pack



MARSHALLTOWN The Premier Line

| EDI-Navy | Size |
|----------|------|
| 17886 | M |
| 17887 | L |
| 17888 | XL |
| 17889 | XXL |
| 17890 | XXXL |

MARSHALLTOWN The Premier Line

| EDI-Black | Size |
|-----------|------|
| 17892 | M |
| 17893 | L |
| 17894 | XL |
| 17895 | XXL |
| 17896 | XXXL |



MARSHALLTOWN The Premier Line

| EDI-Khaki | Size |
|-----------|----------|
| 17425 | Medium |
| 17426 | Large |
| 17427 | X-Large |
| 17428 | XX-Large |



Sweatshirts

- Available in two colors: Light gray with navy screen printed logo or Navy with white screen printed logo
- Sold 1 per inner pack/1 per outer pack

MARSHALLTOWN The Premier Line

| EDI-Gray | Size |
|----------|------|
| 17873 | S |
| 17874 | M |
| 17875 | L |
| 17876 | XL |
| 17877 | XXL |
| 17878 | XXXL |



MARSHALLTOWN The Premier Line

| EDI-Navy | Size |
|----------|------|
| 17867 | S |
| 17868 | M |
| 17869 | L |
| 17870 | XL |
| 17871 | XXL |
| 17872 | XXXL |



Hooded Sweatshirt

- Gray with navy screen printed logo
- Sold 1 per inner pack/1 per outer pack

MARSHALLTOWN The Premier Line

| EDI-Gray | Size |
|----------|------|
| 17313 | S |
| 17314 | M |
| 17315 | L |
| 17316 | XL |
| 17317 | XXL |
| 17318 | XXXL |



Embroidered Logo Caps

- Available in six colors: Navy, Blue, Black, Khaki, Dark Saddle and Camo with embroidered logo
- Sold 1 per inner pack/24 per outer pack

MARSHALLTOWN The Premier Line

| EDI | Description |
|-------|-------------|
| 17347 | Navy |
| 18063 | Blue |
| 18064 | Dark Saddle |
| 18065 | Camo |
| 18329 | Black |
| 18330 | Khaki |



T-shirts

- Available in three colors: White with navy screen printed logo, Navy with white screen printed logo or Light Gray with navy screen printed logo
- Sold 1 per inner pack/1 per outer pack

MARSHALLTOWN The Premier Line

| EDI-White | Size |
|-----------|------|
| 17897 | S |
| 17898 | M |
| 17899 | L |
| 17900 | XL |
| 17901 | XXL |
| 17902 | XXXL |



MARSHALLTOWN The Premier Line

| EDI-Navy | Size |
|----------|------|
| 17903 | S |
| 17904 | M |
| 17905 | L |
| 17906 | XL |
| 17907 | XXL |
| 17908 | XXXL |

MARSHALLTOWN The Premier Line

| EDI-Gray | Size |
|----------|------|
| 17909 | S |
| 17910 | M |
| 17911 | L |
| 17912 | XL |
| 17913 | XXL |
| 17914 | XXXL |



Beanie

- Navy stocking cap with white embroidered logo
- Sold 1 per inner pack/1 per outer pack

MARSHALLTOWN The Premier Line

| EDI | Size |
|-------|------|
| 17306 | N/A |



Anti-Fog Safety Glasses

- Curved lens for snug secure fit
- Durable scratch-resistant poly carbonate lenses
- Provides protection from impact and UV rays
- SGC has adjustable temple for snug, secure fit
- Both feature anti-fog lenses
- ANSI Z87.1 compliant
- Sold 1 per inner pack 12 per outer pack



MARSHALLTOWN The Premier Line

| EDI | Part# | Description |
|-------|-------|---|
| 13857 | SGCE | Economy Clear Safety Glasses w/Anti-fog |
| 13859 | SGC | Clear Safety Glasses w/Anti-fog |

Safety Eyewear

- 99.9% UV protection from harmful UVA and UVB rays
- Exceeds ANSI Z87.1-2003 high impact standards
- All lenses are de-centered for 100% visual correctness
- HD (High Definition) lenses provide sharp, enhanced vision by filtering the most damaging blue rays and allowing for more transmission of the HD light spectrum
- SG213 designed to fit over prescription lenses
- Display is two-sided 27½" (698.5mm) swivel unit that holds 36 pairs
- Sold 12 per inner pack/300 per outer pack, SGDISP36 sold 1 per inner pack/1 per outer pack



SGDISP36 (Glasses sold separately)

MARSHALLTOWN The Premier Line

| EDI | Part# | Description | Frame | Lens |
|-------|----------|----------------------|-------|----------|
| 18355 | SG355 | Glasses | Black | Green HD |
| 11189 | SG189 | Glasses | Black | Red |
| 11195 | SG195 | Glasses | Black | Blue |
| 11196 | SG196 | Glasses w/foam liner | Black | Gray |
| 11197 | SG197 | Goggles | Black | Yellow |
| 11213 | SG213 | Glasses | Clear | Clear |
| 11214 | SDGISP36 | Display only | N/A | N/A |

Hard Hat

- "Secure Fit" ratchet features an easy turn knob that allows adjustment for a perfect fit without removing helmet
- No-slip hold maintains the desired fit even in the most physically active jobs or extreme weather conditions
- Allows for 40 different head sizes with a turn of a knob (sizes 6½-8)
- Thick sponge padding cushions back of head
- Cushioned brow pad absorbs moisture; is removable and washable
- Meets ANSI Z89.1-2003, Type 1, Class C, E, and G requirements
- Sold 1 per inner pack/30 per outer pack



MADE IN
U.S.A

MARSHALLTOWN The Premier Line

| EDI | Part# | Size-in. | Size-mm |
|-------|-------|----------|---------|
| 14219 | 14219 | N/A | N/A |

Ear Plugs

- Ultra-soft, polyurethane foam provides comfortable fit and close-fitting seal against harmful noise
- One size fits all
- Meets ANSI S3.19 and CE EN352-2 requirements
- NRR 32dB; SNR 37dB
- Choice between corded or uncorded ear plugs
- Sold 100 pairs to a box
- Sold 1 per inner pack/ 10 per outer pack



MARSHALLTOWN The Premier Line

| EDI | Part# | Description |
|-------|--------|-------------|
| 10462 | EP462 | Uncorded |
| 10463 | EPC463 | Corded |

Hearing Protection Band

- Soft caps with flexible, durable band
- Fits comfortably over ear canal
- Meets ANSI S3.19 and CE EN352-2 requirements
- NRR 26dB; SNR 19dB
- Sold 100 per inner pack/ 500 per outer pack



MARSHALLTOWN The Premier Line

| EDI | Part# | Description |
|-------|-------|-------------|
| 10464 | EB464 | Ear Band |

Ear Muffs

- Lightweight, with soft foam-filled cushions and adjustable, reinforced headband
- Meets ANSI S3.19 and CE EN352-1 requirements
- NRR 20dB; SNR 25dB
- Sold 10 inner pack/ 60 per outer pack



MARSHALLTOWN The Premier Line

| EDI | Part# | Description |
|-------|-------|-------------|
| 10465 | EM465 | Ear Muffs |

Ear Muffs-Foldable

- Large foam-filled cushions with deep ear cups
- Can be folded into a compact unit for easy storage and transport
- Meets ANSI S3.19 and CE EN352-1 requirements
- NRR 25dB; SNR 30dB
- Sold 10 per inner pack/ 60 per outer pack



MARSHALLTOWN The Premier Line

| EDI | Part# | Description |
|-------|--------|--------------------|
| 10466 | EMF466 | Ear Muffs-Foldable |

Titleist® DT Solo Golf Balls

- Sold 12 balls per inner pack/outer pack



MADE IN
U.S.A

MARSHALLTOWN The Premier Line

| EDI | Part# | Description |
|-------|-------|-----------------------------------|
| 17840 | 17840 | 1 dozen Golf Balls with navy logo |

Gondolas

- Easy to assemble
- Standard ¼" (6mm) perforboard holes, 1" (25mm) apart
- Sold 1 per inner pack/1 per outer pack



MADE IN
U.S.A

MARSHALLTOWN The Premier Line

| EDI | Part# | Size-in. | Size-mm |
|-------|-------|----------|-------------|
| WX913 | 36" | 36 X 48 | 914 X 1219 |
| WX927 | 48" | 48 X 48 | 1219 X 1219 |

Perfboard Backer

- Used to draw attention to your display and separate your **MARSHALLTOWN** product from other brands
- Made of durable styrene and marked with 16 evenly spaced **MARSHALLTOWN** logos
- Fits 48 X 48" (1219 X 1219mm) gondola with standard 1/4" (6mm) perfboard holes that are 1" (25mm) apart; or put two together to cover a full sheet of perfboard
- Six "push pins" included for hanging
- Sold 1 per inner pack/1 per outer pack

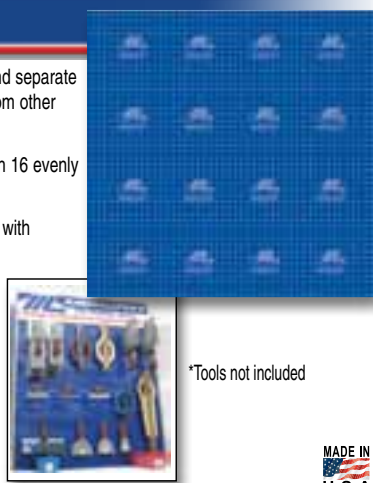

*Tools not included

MADE IN
U.S.A.

MARSHALLTOWN The Premier Line

| EDI | Part# | Size-in. | Size-mm |
|-------|-------|----------|-------------|
| 17500 | 17500 | 48 X 48 | 1219 X 1219 |

Display Boxes

- Attaches to perfboard
- Jointer holds six brick jointers, Tuck holds six tuck pointers
- Comes with two screws and two mounting anchors
- Sold 1 per inner pack/1 per outer pack



MADE IN
U.S.A.

MARSHALLTOWN The Premier Line

| EDI | Part# | Size-in. | Size-mm |
|-------|---------|----------|---------|
| WX915 | Jointer | N/A | N/A |
| WX917 | Tuck | N/A | N/A |

Wire Grid Tool Display

- Mix and match components to create the ideal set
- Ideal display for long handle or asphalt tools
- Black powder coated finish ensures a long lasting attractive display
- Tools not included
- Display Includes:
 - 4- 20113, 2' x 7' grid panels
 - 20- 20111, grid panel connectors
 - 44- 20112, 10" shelf brackets
 - 2- 20114, flat grid shelves
 - 1- 20115, literature holder
 - 1- WX982, 9" x 36" Marshalltown sign
- Sold 1 per inner pack /1 per outer pack



MARSHALLTOWN The Premier Line

| EDI | Part# | Size-ft. | Size-M |
|-------|-----------|--------------|--------------------|
| 26691 | RED700397 | 2W X 4L X 7H | .61W X 1.2L X 2.1H |

Wire Grid Rack

- Ideal for creating theft proof displays
- Mix and match components to create the ideal set
- Powder coated finish ensures a long lasting attractive display
- 15256 sold 3 per inner pack /3 per outer pack
- Accessories sold 1 per inner pack/1 per outer pack
- Available in inner pack quantities only

*Tools not included



15257

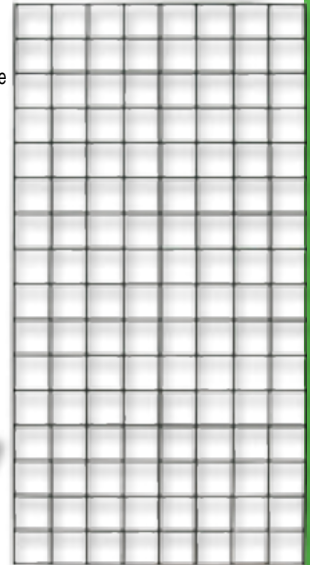

MARSHALLTOWN The Premier Line

| EDI | Part# | Description | Size-in. | Size-mm |
|-------|-------|------------------------|-------------|------------|
| 15256 | 15256 | Wire Grid Display | 24 1/4 X 48 | 616 X 1219 |
| 15257 | 15257 | Connector Clips | N/A | N/A |
| 15258 | 15258 | Wall Mounting Brackets | N/A | N/A |
| 15259 | 15259 | Zip Ties (100/bag) | 15 | 381 |

Display Hooks

"A" Hook

EDI # 15981

- 8 1/4" long - Holds 6 finishing trowels or 6 concrete edgers
- Sold 1 per inner pack/1 per outer pack

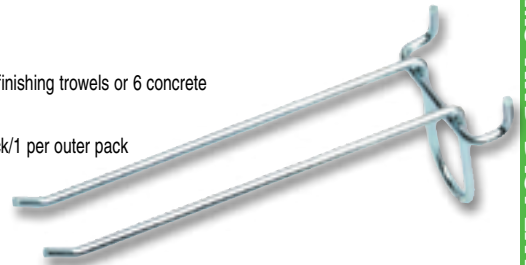

"C" Hook

EDI # 15983

- 9 1/4" long - Holds 6 groovers
- Sold 1 per inner pack/1 per outer pack

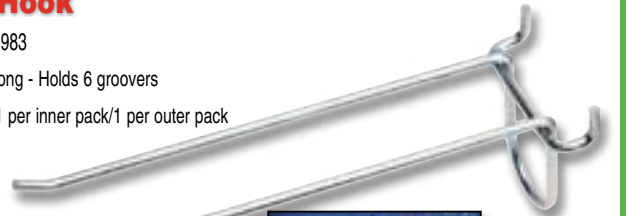

"B" Hook

EDI # 15982

- 11 3/4" long - Holds 6 rubber floats
- Sold 1 per inner pack/1 per outer pack

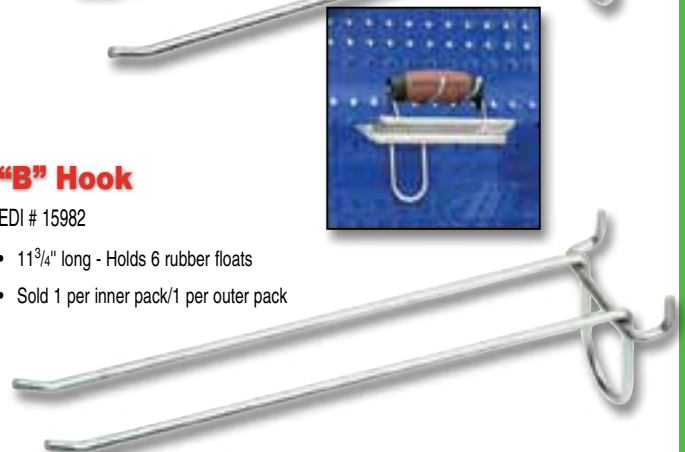

Display Hooks Continued

"F" Hook

EDI # 15986

- 6" long - Holds 6 taping knives or 2 hand sanders
- Sold 1 per inner pack/1 per outer pack



"H" Hook

EDI # 17339

- 9 1/2" long - Holds 6 DuraSoft® scrapers or putty knives
- Sold 1 per inner pack/1 per outer pack

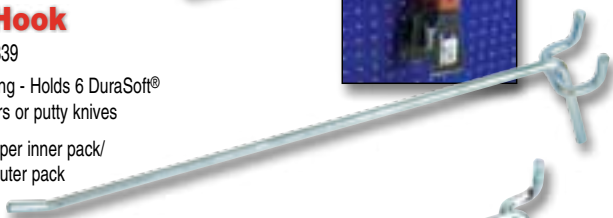

"D" Hook

EDI # 15984

- 7 1/4" long - Holds 4 brick trowels
- Sold 1 per inner pack/1 per outer pack



"G" Hook

EDI # 15987

- 9 1/8" long - Holds 4 corner trowels
- Sold 1 per inner pack/1 per outer pack



"E" Hook

EDI # 15985

- 10" long - Holds 6 pointing or margin trowels
- Sold 1 per inner pack/1 per outer pack

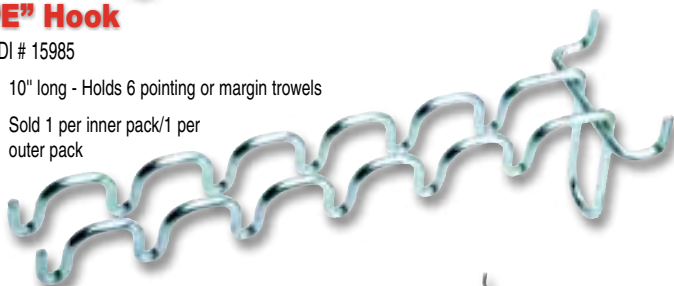

Display Rack

EDI # 15956

- Holds 9 brick trowels or 9 four inch finishing trowels
- Also holds pointing and margin trowels
- Sold 1 per inner pack/8 per outer pack

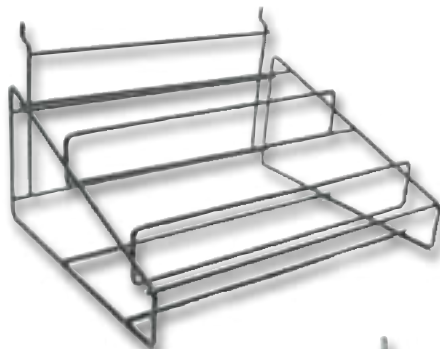

"Pole" Hook

EDI # 15980

- 13 1/2" long - Holds various pole handles
- Also available in black (EDI 15950)
- 15980 sold 1 per inner pack/100 per outer pack, 15950 sold 1 per inner pack/60 per outer pack

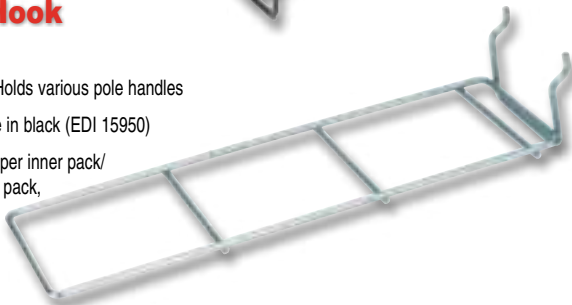

Perfboard Display Racks

- Zinc plated
- Designed to mount on perfboard
- 16017 holds a variety of items including: brick trowels, finishing trowels, tuck pointers and more
- 16023 holds putty knives, packaged items and more
- 16016 & 16078 are ideal for holding loose merchandise; fold flat when not in use and are slotted in front for signage
- 15260 is a great way to display your **MARSHALLTOWN**® catalogs on perfboard, horizontal slat wall or countertops
- 17497 works great for signage on our Wire Baskets
- 19803 holds six bull floats vertically
- MIC & 17497 sold in singles, other inner and outer pack quantities shown in table



16078



16017



MIC



17497



16023



15260

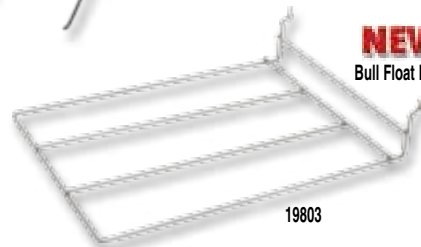

19803

NEW!
Bull Float Rack

MARSHALLTOWN The Premier Line

| EDI | Part# | Description | Size-in. | Size-mm | Inner/Outer |
|-------|-------|-------------------|------------------------|-----------------|-------------|
| 16016 | 16016 | Lg. Wire Basket | 10 X 13 | 254 X 330 | 1/12 |
| 16078 | 16078 | Sm. Wire Basket | 5 X 13 | 127 X 330 | 1/12 |
| 16023 | 16023 | Putty Knife Rack | 4 3/8 X 16 3/4 X 5 1/4 | 111 X 425 X 133 | 1/1 |
| 16017 | 16017 | Skinny Rack | 32 | 813 | 24/24 |
| 15260 | 15260 | Literature Holder | 9 X 9 1/4 X 4 1/2 | 229 X 235 X 115 | 12/12 |
| 17014 | MIC | Re-order Card | 3 5/8 X 3 5/8 | 92 X 92 | N/A |
| 17497 | 17497 | Plastic Sign | 5 X 8 3/4 | 127 X 210 | N/A |
| 19083 | 19803 | Bull Float Rack | 10 1/4 X 14 1/4 | 260 X 362 | 2/2 |

Marshalltown Part Number Listing

| PART NO. | PAGE NO. | PART NO. | PAGE NO. | PART NO. | PAGE NO. | PART NO. | PAGE NO. | PART NO. | PAGE NO. |
|-----------|------------|----------|----------|----------|----------|----------|----------|----------|----------|
| 0 | 163 | 10590 | 95 | 13313 | 92 | 14289 | 51,243 | 14BST | 152 |
| 1D | 13,162 | 10591 | 95 | 13314 | 92 | 14429 | 182 | 14L | 8 |
| 1GSFP | 149 | 10593 | 95 | 13315 | 92 | 14730 | 103 | 14P | 8 |
| 1GSFPD | 149 | 10594 | 95 | 13316 | 92 | 14731 | 104 | 15096 | 28 |
| 01RAC | 226 | 10595 | 95 | 13317 | 92 | 14732 | 102,148 | 15228 | 224 |
| 01RAC3 | 226 | 10596 | 95 | 13318 | 92 | 14743 | 103 | 15229 | 224 |
| 01RAC3CS | 226 | 10597 | 95 | 13319 | 92 | 14744 | 103 | 15230 | 224 |
| 01RACCS | 226 | 10598 | 95 | 13320 | 92 | 14745 | 103 | 15231 | 224 |
| 1SSFP | 150 | 10819 | 24 | 13321 | 92 | 14747 | 103 | 15232 | 224 |
| 1SSFPD | 150 | 10844 | 245 | 13322 | 92 | 14749 | 103 | 15234 | 224 |
| 1W | 13,162 | 10847 | 245 | 13323 | 92 | 14751 | 103 | 15235 | 224 |
| 2D | 13,162 | 10855 | 197 | 13324 | 92 | 14770 | 95 | 15236 | 224 |
| 2W | 13,162 | 10NC | 88 | 13325 | 92 | 14771 | 95 | 15237 | 224 |
| 3D | 13,162 | 10NW | 88 | 13330 | 92 | 14772 | 95 | 15238 | 224 |
| 3W | 13,162 | 11 | 46 | 13331 | 92 | 14773 | 95 | 15239 | 224 |
| 4GSFP | 149 | 11078 | 238 | 13332 | 92 | 14775 | 95 | 15249 | 224 |
| 4GSFPD | 149 | 11165 | 24 | 13333 | 92 | 14776 | 95 | 15250 | 224 |
| 4SSFP | 150 | 11166 | 24 | 13334 | 92 | 14777 | 95 | 15251 | 224 |
| 4SSFPD | 150 | 11167 | 24 | 13335 | 92 | 14778 | 95 | 15252 | 224 |
| 5D | 13,162 | 11735 | 27 | 13702 | 144 | 14779 | 95 | 15253 | 224 |
| 05RCS | 226 | 11D | 46 | 13703 | 144 | 14780 | 95 | 15254 | 88 |
| 5W | 13,162 | 11SSD | 46 | 13704 | 144 | 14781 | 95 | 15255 | 88 |
| 6D | 13,162 | 12 | 151 | 13706 | 144 | 14782 | 95 | 15256 | 251 |
| 6IN1212HH | 157 | 12107 | 191 | 13708 | 144 | 14783 | 95 | 15257 | 251 |
| 6W | 13,162 | 12108 | 191 | 13709 | 144 | 14784 | 95 | 15258 | 251 |
| 6WPBLACK | 122 | 12114 | 191 | 13710 | 144 | 14785 | 95 | 15259 | 251 |
| 6WPBLUE | 122 | 12115 | 191 | 13712 | 144 | 14786 | 95 | 15260 | 252 |
| 6WPFLEX | 122 | 12116 | 191 | 13715 | 144 | 14788 | 95 | 15349 | 102 |
| 6WPFLEXY | 122 | 12117 | 191 | 13717 | 100 | 14789 | 95 | 15356 | 218 |
| 6WPSGL | 122 | 12118 | 191 | 13718 | 100 | 14790 | 95 | 15357 | 218 |
| 6WPSKIN | 122 | 12119 | 191 | 13719 | 165 | 14791 | 95 | 15358 | 218 |
| 7D | 13,162 | 12120 | 225 | 13720 | 165 | 14792 | 95 | 15380 | 221 |
| 7GSFP | 149 | 12121 | 225 | 13725 | 185 | 14793 | 95 | 15381 | 221 |
| 7GSFPD | 149 | 12196 | 84 | 13726 | 185 | 14794 | 95 | 15382 | 221 |
| 7W | 13,162 | 12197 | 84 | 13727 | 185 | 14795 | 95 | 15383 | 221 |
| 8D | 13,162 | 12637 | 104 | 13741 | 96 | 14833 | 95 | 15386 | 222 |
| 8W | 13,162 | 12951 | 92 | 13743 | 96 | 14850 | 96 | 15389 | 222 |
| 9 | 88 | 12952 | 92 | 13744 | 96 | 14851 | 96 | 15390 | 222 |
| 9NC | 88 | 12985 | 28 | 13745 | 96 | 14852 | 96 | 15393 | 218 |
| 9NW | 88 | 12A | 151 | 13746 | 96 | 14853 | 96 | 15394 | 218 |
| 10 | 88 | 12AD | 151 | 13869 | 87 | 14854 | 96 | 15396 | 221 |
| 10146 | 187 | 12ASD | 151 | 13GSFP | 149 | 14855 | 96 | 15397 | 221 |
| 10147 | 145 | 12ASS | 151 | 13GSFPD | 149 | 14856 | 96 | 15465 | 221 |
| 10147RB | 145 | 12ASSD | 151 | 13SSFP | 150 | 14857 | 96 | 15479 | 224 |
| 10156 | 145 | 12B | 151 | 13SSFPD | 150 | 14858 | 96 | 15480 | 224 |
| 10156RB | 145 | 12BSD | 151 | 14 | 8 | 14859 | 96 | 15483 | 224 |
| 10375 | 23 | 12BSS | 151 | 14047 | 66 | 14860 | 96 | 15484 | 224 |
| 10376 | 23 | 12BSSD | 151 | 14048 | 66 | 14861 | 96 | 15487 | 224 |
| 10377 | 23 | 12BST | 152 | 14049 | 66 | 14862 | 96 | 15488 | 224 |
| 10401 | 187 | 12C | 151 | 14055 | 66 | 14863 | 96 | 15489 | 224 |
| 10402 | 187 | 12CSD | 151 | 14082 | 66 | 14864 | 96 | 15490 | 224 |
| 10403 | 187 | 12CSS | 151 | 14088 | 66 | 14865 | 96 | 15496 | 221 |
| 10404 | 187 | 12CSSD | 151 | 14089 | 66 | 14866 | 96 | 15497 | 221 |
| 10406 | 187 | 12D | 151 | 14090 | 66 | 14867 | 96 | 15503 | 221 |
| 10407 | 187 | 12SD | 151 | 14091 | 66 | 14868 | 96 | 15504 | 221 |
| 10408 | 187 | 12SS | 151 | 14092 | 66 | 14869 | 96 | 15505 | 221 |
| 10409 | 187 | 12SSD | 151 | 14093 | 66 | 14870 | 96 | 15506 | 221 |
| 10410 | 187 | 13071 | 66 | 14094 | 66 | 14875 | 185 | 15507 | 221 |
| 10411 | 187 | 13072 | 66 | 14095 | 66 | 14876 | 185 | 15508 | 221 |
| 10412 | 187 | 13073 | 66 | 14096 | 66 | 14877 | 185 | 15509 | 221 |
| 14013 | 187 | 13074 | 66 | 14141 | 66 | 14788 | 185 | 15510 | 221 |
| 10415 | 187 | 13075 | 66 | 14148 | 66 | 14789 | 185 | 15536 | 23 |
| 10453 | 102 | 13076 | 66 | 14151 | 66 | 14880 | 185 | 15537 | 23 |
| 10516 | 28,174,239 | 13100 | 63 | 14153 | 66 | 14881 | 185 | 15538 | 84 |
| 10584 | 95 | 13101 | 63 | 14171 | 104 | 14882 | 185 | 15539 | 84 |
| 10585 | 95 | 13102 | 63 | 14246 | 23 | 14883 | 185 | 15545 | 224 |
| 10586 | 95 | 13103 | 49 | 14278 | 23 | 14884 | 185 | 15546 | 224 |
| 10587 | 95 | 13308 | 92 | 14279 | 23 | 14885 | 185 | 15547 | 224 |
| 10588 | 95 | 13309 | 92 | 14281 | 23 | 14886 | 185 | 15548 | 224 |
| 10589 | 95 | 13312 | 92 | 14285 | 190 | 14892 | 23 | 15549 | 63 |

Marshalltown Part Number Listing

| PART NO. | PAGE NO. | PART NO. | PAGE NO. | PART NO. | PAGE NO. | PART NO. | PAGE NO. | PART NO. | PAGE NO. |
|----------|----------|-----------|----------|-----------|----------|-----------|----------|----------|----------|
| 15551 | 65 | 16SF | 69 | 21LE24R | 192 | 34 11 | 7 | 49L | 178,213 |
| 15553 | 65 | 17445 | 113 | 21UFBHDW | 192 | 34 11FG | 7 | 49XH | 178,213 |
| 15555 | 65 | 17446 | 113 | 21UFBK | 192 | 34 12 | 7 | 50D | 159 |
| 15557 | 65 | 17447 | 113 | 21UFBL | 192 | 34 12FG | 7 | 51D | 159 |
| 15559 | 65 | 17476 | 198 | 21UFBR | 192 | 34L10.5 | 7 | 52 | 11 |
| 16016 | 252 | 17497 | 252 | 22 | 173 | 34L11 | 7 | 52D | 11 |
| 16017 | 252 | 17500 | 251 | 22X | 216 | 34L12 | 7 | 52SN | 211 |
| 16023 | 252 | 17839 | 245 | 23D | 158 | 34P10.5 | 7 | 52SND | 211 |
| 16031 | 9 | 17840 | 250 | 24CLEV | 25,238 | 34P11 | 7 | 52VN | 211 |
| 16078 | 252 | 17-6ASU | 83 | 24CLEVC | 25,238 | 34P12 | 7 | 52VND | 211 |
| 16079 | 195 | 17-7ASUM | 83 | 24CLEVCRB | 25,238 | 35 | 15 | 53D | 213 |
| 16140 | 196 | 17-8ASU | 83 | 24CLEVGRB | 25,238 | 36CLEV | 25,238 | 54 | 11 |
| 16493 | 175 | 17-8F | 84 | 24D | 159 | 36CLEVC | 25,238 | 54D | 11 |
| 16509 | 27 | 17-9ASUM | 83 | 24H2 | 238 | 36CLEVCRB | 25,238 | 54S | 12 |
| 16531 | 221 | 17-12M7 | 84 | 24NH | 238 | 36CLEVGRB | 25,238 | 54SD | 12 |
| 16533 | 22,221 | 17-13F | 84 | 24NHM | 238 | 36E55 | 108 | 56 | 11 |
| 16535 | 22,221 | 18 | 173 | 25D | 159 | 36PE9 | 108 | 56D | 11 |
| 16537 | 22,221 | 18644 | 144 | 26 | 181 | 37 | 179 | 57 | 215 |
| 16545 | 22,221 | 18645 | 144 | 26991 | 142 | 38 | 177 | 57D | 215 |
| 16547 | 22,221 | 18730 | 96 | 26A | 180 | 38L | 177 | 58 | 11 |
| 16554 | 24,238 | 18731 | 96 | 27 | 175 | 39 | 177 | 58D | 11 |
| 16585 | 183 | 18732 | 96 | 27A | 175 | 40 | 213,177 | 62GSFP | 149 |
| 16587 | 30,214 | 18733 | 96 | 27HD | 175 | 41 | 177 | 62GSFPD | 149 |
| 16595 | 102 | 18988 | 123 | 27XM | 176 | 42 | 177 | 71 | 12 |
| 16650 | 27 | 18989 | 123 | 28 | 181 | 42CLEV | 25,238 | 73 | 12 |
| 16710 | 221 | 19104 | 8 | 28L | 181 | 42CLEVC | 25,238 | 75 | 15 |
| 16712 | 221 | 19 7.5 | 9 | 30 | 160 | 42CLEVCRB | 25,238 | 76 | 15 |
| 16714 | 221 | 19 7.5L | 9 | 31 | 171 | 42CLEVGRB | 25,238 | 77 | 15 |
| 16801 | 70 | 19 8.25 | 9 | 32 | 15 | 43 | 212 | 78 | 15 |
| 16803 | 70 | 19 8.25L | 9 | 33 9 | 8 | 43A | 212 | 78H2 | 238 |
| 16806 | 70 | 19 9.5 | 7 | 33 9.5 | 8 | 43BC | 212 | 78HM | 238 |
| 16807 | 70 | 19 9.5FG | 7 | 33 9.5FG | 8 | 43XL | 212 | 79 | 173 |
| 16809 | 70 | 19 10 | 7 | 33 9FG | 8 | 44 | 69 | 80 | 15 |
| 16811 | 70 | 19 10.5 | 7 | 33 10 | 8 | 44D | 69 | 81 | 15 |
| 16813 | 70 | 19 10FG | 7 | 33 10.5 | 8 | 45 4.5 | 10 | 82 | 15 |
| 16815 | 70 | 19 11 | 7 | 33 10.5FG | 8 | 45 4.5D | 10 | 83 | 15 |
| 16817 | 70 | 19 11.5 | 7 | 33 10FG | 8 | 45 4.5S | 12 | 84HD | 16 |
| 16818 | 70 | 19 11.5FG | 7 | 33 11 | 8 | 45 4.5SD | 12 | 86 | 27 |
| 16819 | 70 | 19 11FG | 7 | 33 11.5 | 8 | 45 5 | 10 | 86P | 27 |
| 16839 | 100 | 19 12 | 7 | 33 11.5FG | 8 | 45 5D | 10 | 88 | 22 |
| 16839RB | 100 | 19 12FG | 7 | 33 11FG | 8 | 45 5S | 12 | 89 | 16 |
| 16840 | 100 | 19L9.5 | 7 | 33 12 | 8 | 45 5SD | 12 | 91 | 64 |
| 16840RB | 100 | 19L10 | 7 | 33 12FG | 8 | 45 6 | 10 | 92 | 56 |
| 16841 | 100 | 19L10.5 | 7 | 33 12FGS | 7 | 45 6A | 10 | 93 | 16 |
| 16841RB | 100 | 19L11 | 7 | 33 13 | 8 | 45 6D | 10 | 95 | 10 |
| 16842 | 100 | 19L11.5 | 7 | 33 13FG | 8 | 45 7 | 10 | 96 | 9 |
| 16842RB | 100 | 19L12 | 7 | 33 13FGS | 7 | 45 7D | 10 | 97 | 11 |
| 16843 | 100 | 19P9.5 | 7 | 33 13S | 7 | 46 114D | 10 | 98 | 14 |
| 16843RB | 100 | 19P10 | 7 | 33L9 | 8 | 46 114S | 12 | 121BD | 53 |
| 16844 | 100 | 19P10.5 | 7 | 33L9.5 | 8 | 46 114SD | 12 | 121SSD | 53 |
| 16844RB | 100 | 19P11 | 7 | 33L10 | 8 | 46 115D | 10 | 122 | 58 |
| 16845 | 100 | 19P11.5 | 7 | 33L10.5 | 8 | 46 116D | 10 | 122B | 58 |
| 16845RB | 100 | 19P12 | 7 | 33L11 | 8 | 46BG | 178,214 | 123 | 58 |
| 16846 | 100 | 20D | 180 | 33L11.5 | 8 | 46E9NH | 108 | 123B | 58 |
| 16846RB | 100 | 21CCB | 192 | 33L12 | 8 | 46E11 | 108 | 124 | 58 |
| 16847 | 100 | 21CP | 192 | 33L12S | 7 | 46G | 178,214 | 124B | 58 |
| 16847RB | 100 | 21ECBL | 192 | 33L13 | 8 | 46LB | 178,214 | 125 | 58 |
| 16848 | 100 | 21ECBR | 192 | 33L13S | 7 | 46LG | 178,214 | 126B | 58 |
| 16848RB | 100 | 21FS903 | 192 | 33P9 | 8 | 47A | 13 | 130SSD | 54 |
| 16849 | 100 | 21FSP | 192 | 33P9.5 | 8 | 48 | 12 | 132SSD | 54 |
| 16849RB | 100 | 21HC | 192 | 33P10 | 8 | 48A | 13 | 134SSD | 54 |
| 16BST | 152 | 21HLCL | 192 | 33P10.5 | 8 | 48AD | 13 | 135SSD | 54 |
| 16D | 69 | 21HLCR | 192 | 33P11 | 8 | 48CLEV | 25,238 | 136BD | 53 |
| 16LRW | 69 | 21LAL | 192 | 33P11.5 | 8 | 48CLEVC | 25,238 | 136D | 53 |
| 16M | 69 | 21LAR | 192 | 33P12 | 8 | 48CLEVCRB | 25,238 | 136SSD | 53 |
| 16-MR | 86 | 21LE15L | 192 | 33P12S | 7 | 48CLEVGRB | 25,238 | 138BD | 53 |
| 16-MRL | 86 | 21LE15R | 192 | 33P13 | 8 | 48D | 12 | 138D | 53 |
| 16RD | 69 | 21LE18L | 192 | 33P13S | 7 | 48HM | 238 | 138SSD | 53 |
| 16-RKT-N | 85 | 21LE18R | 192 | 34 10.5 | 7 | 48NH | 238 | 140 | 71 |
| 16RW | 69 | 21LE24L | 192 | 34 10.5FG | 7 | 49 | 178,213 | 141 | 69 |

Marshalltown Part Number Listing

| PART NO. | PAGE NO. | PART NO. | PAGE NO. | PART NO. | PAGE NO. | PART NO. | PAGE NO. | PART NO. | PAGE NO. |
|----------|----------|-----------|----------|----------|------------|----------|----------|----------|------------|
| 141D | 69 | 167BD | 52 | 402 | 51 | 611D | 17 | 703 | 207 |
| 141LRW | 69 | 170SSD | 61 | 402D | 51 | 612D | 17 | 703S | 207 |
| 142 | 68 | 171SSD | 61 | 403 | 64 | 613D | 17 | 703SD | 207 |
| 142D | 68 | 172SSD | 61 | 412D | 163 | 614D | 17 | 704 | 207 |
| 142LRW | 68 | 174BD | 61 | 412W | 163 | 617D | 17 | 704S | 207 |
| 142RD | 68 | 175BD | 61 | 420 | 30,222,197 | 618D | 17 | 704SD | 207 |
| 142RW | 68 | 176D | 53 | 420B | 30,222,197 | 619D | 17 | 706 | 207 |
| 143 | 69 | 177SSD | 61 | 423 | 97 | 620 | 26 | 706S | 207 |
| 143D | 69 | 178SSD | 61 | 423HH | 97 | 620D | 17 | 706SD | 207 |
| 143LRW | 69 | 179SSD | 61 | 427 | 97 | 621 | 26 | 708SD | 208 |
| 143RD | 69 | 180D | 64 | 427HH | 97 | 621D | 17 | 709SD | 208 |
| 143RW | 69 | 184SSD | 52 | 428 | 97 | 622 | 25 | 710SD | 208 |
| 144 | 69 | 18587 | 9 | 428HH | 97 | 622D | 17 | 711SD | 208 |
| 144D | 69 | 185SSD | 52 | 429 | 97 | 623 | 25 | 714SD | 183 |
| 145 | 68 | 18630 | 11 | 429HH | 97 | 623D | 17 | 715SD | 183 |
| 145D | 68 | 18631 | 11 | 430 | 97 | 624 | 25 | 716S | 207 |
| 145GSFP | 149 | 18633 | 10 | 430HH | 97 | 624D | 17 | 716SD | 207 |
| 145GSFPD | 149 | 18634 | 10 | 446 | 221 | 625 | 25 | 716SDDN | 207 |
| 145LRW | 68 | 186BD | 61 | 479CH | 53 | 625D | 17 | 716SDL | 207 |
| 145RD | 68 | 18730 | 96 | 480CH | 53 | 626 | 25 | 717S | 207 |
| 145RW | 68 | 18731 | 96 | 481CH | 53 | 627 | 25 | 717SD | 207 |
| 145SH | 68 | 18732 | 96 | 482CH | 53 | 628 | 25 | 717SDDN | 207 |
| 146 | 68 | 18733 | 96 | 483CH | 53 | 629 | 26 | 717SDL | 207 |
| 146D | 68 | 18736 | 10 | 484CH | 53 | 631 | 25 | 718S | 207 |
| 146LRW | 68 | 18737 | 10 | 485CH | 53 | 632 | 25 | 718SD | 207 |
| 146RD | 68 | 18738 | 10 | 486CH | 53 | 634 | 26 | 718SDL | 207 |
| 146RW | 68 | 187BD | 61 | 487NCH | 53 | 635 | 26 | 719S | 207 |
| 146SH | 68 | 188SSD | 52 | 488NCH | 53 | 635SD | 208 | 719SD | 207 |
| 147 | 70 | 190SSD | 52 | 489N | 53 | 636SD | 208 | 720 | 30,222,197 |
| 147D | 70 | 192SSD | 52 | 490N | 53 | 637SD | 208 | 720B | 30,222,197 |
| 148 | 68 | 194SSD | 52 | 491N | 53 | 638SD | 208 | 721 | 184 |
| 148D | 68 | 196SSD | 52 | 502 | 14 | 639SD | 208 | 721SS | 184 |
| 148LRW | 68 | 202 | 11 | 502D | 14 | 640SD | 208 | 722 | 184 |
| 148RD | 68 | 206 | 211 | 503 | 14 | 641SD | 208 | 723 | 184 |
| 148RW | 68 | 207 | 211 | 503D | 14 | 642SD | 208 | 734 | 68 |
| 149 | 71 | 207-1 | 211 | 504 | 14 | 643SD | 208 | 734D | 68 |
| 150 | 71 | 208 | 211 | 504D | 14 | 644SD | 208 | 734LRW | 68 |
| 151 | 71 | 208-1 | 211 | 505 | 14 | 645SD | 208 | 734RD | 68 |
| 152 | 71 | 209 | 47 | 505D | 14 | 646 | 21 | 734RW | 68 |
| 153 | 68 | 220 | 211 | 506 | 14 | 646SD | 208 | 734SD | 208 |
| 153D | 68 | 221 | 211 | 506D | 14 | 646SG | 20 | 735SD | 208 |
| 153LRW | 68 | 222 | 211 | 507 | 14 | 647 | 21 | 736 | 68 |
| 154 | 69 | 223 | 211 | 507D | 14 | 647SD | 208 | 736D | 68 |
| 154D | 69 | 224 | 211 | 508 | 14 | 647SG | 20 | 736LRW | 68 |
| 154LRW | 69 | 225 | 211 | 508D | 14 | 648 | 21 | 736RD | 68 |
| 155 | 69 | 226 | 211 | 508N | 53 | 648SG | 20 | 736RW | 68 |
| 155BD | 53 | 227 | 47 | 509 | 14 | 651 | 117 | 736SD | 208 |
| 155D | 69 | 234 | 211 | 509D | 14 | 654 | 21 | 738 | 68 |
| 155LRW | 69 | 236 | 211 | 510 | 14 | 654SG | 20 | 738D | 68 |
| 155SSD | 53 | 238 | 211 | 510D | 14 | 655 | 21 | 738LRW | 68 |
| 156BD | 53 | 239 | 211 | 513N | 53 | 655SG | 20 | 738RD | 68 |
| 156D | 53 | 240 | 211 | 521 | 29 | 656 | 21 | 738RW | 68 |
| 156SSD | 53 | 244 | 69 | 521P | 29 | 657 | 20 | 740 | 68 |
| 158BD | 52 | 247 | 70 | 558 | 14 | 657SG | 20 | 740D | 68 |
| 159BD | 52 | 247D | 70 | 560 | 14 | 658 | 20 | 740LRW | 68 |
| 160BD | 52 | 3 | 5 | 562 | 14 | 659 | 20 | 740RD | 68 |
| 160SSD | 52 | 350 | 222 | 564 | 14 | 660 | 117 | 740RW | 68 |
| 161BD | 52 | 360 | 222 | 566 | 14 | 661 | 117 | 742 | 68 |
| 161SSD | 52 | 360PBA134 | 87 | 568 | 14 | 661SD | 208 | 742D | 68 |
| 162BD | 52 | 360PBA138 | 87 | 600 | 18 | 662SD | 208 | 742LRW | 68 |
| 162SSD | 52 | 360RAHEAD | 87 | 601 | 18 | 663SD | 208 | 742RD | 68 |
| 163BD | 52 | 360STUDHD | 87 | 603SG | 20 | 664SD | 208 | 742RW | 68 |
| 163SSD | 52 | 360THREAD | 87 | 604 | 20 | 693 | 190 | 761SD | 208 |
| 164BD | 52 | 360UNIV6 | 87 | 604SG | 20 | 701 | 207 | 762SD | 208 |
| 164SSD | 52 | 367 | 199 | 606 | 20 | 701S | 207 | 763SD | 208 |
| 165GSFP | 149 | 368 | 199 | 606SG | 20 | 701SD | 207 | 764SD | 208 |
| 165GSFPD | 149 | 369 | 199 | 607 | 21 | 702 | 207 | 765SD | 208 |
| 165SSD | 52 | 375 | 222 | 607SG | 20 | 702S | 207 | 766SD | 208 |
| 166BD | 52 | 401 | 51 | 609D | 17 | 702SD | 207 | 767SD | 208 |
| 166SSD | 52 | 401D | 51 | 610D | 17 | 702SDL | 207 | 768SD | 208 |

Marshalltown Part Number Listing

| PART NO. | PAGE NO. | PART NO. | PAGE NO. | PART NO. | PAGE NO. | PART NO. | PAGE NO. | PART NO. | PAGE NO. |
|----------|------------|----------|----------|----------|----------|----------|----------|----------|----------|
| 769SD | 208 | 844 | 186 | 2160 | 231 | 36" | 250 | 4002D | 52 |
| 770S | 207 | 846 | 186 | 2161 | 231 | 3600 | 57 | 4012 | 56 |
| 770SD | 207 | 847 | 97 | 2162 | 28 | 3601 | 57 | 4013 | 56 |
| 771S | 207 | 848 | 97 | 2166D | 13,163 | 3602 | 57 | 4038D | 63 |
| 771SD | 207 | 849 | 186 | 2508 | 153 | 3602HOLE | 87 | 4039D | 63 |
| 775S | 207,229 | 854 | 98 | 2508SS | 153 | 3603 | 57 | 4040D | 63 |
| 775SD | 207,229 | 855 | 98 | 2510 | 153 | 3604 | 57 | 4041D | 63 |
| 775SDL | 207 | 856 | 98 | 2510SS | 153 | 3605 | 57 | 4042D | 63 |
| 776S | 207 | 864D | 63 | 2512 | 153 | 3606 | 57 | 4043D | 63 |
| 776SD | 207 | 865D | 63 | 2512SS | 153 | 3607 | 57 | 4044D | 63 |
| 776SDDN | 207 | 866D | 63 | 2514 | 153 | 3608 | 57 | 4045D | 63 |
| 776SDL | 207 | 867D | 63 | 2514SS | 153 | 3609 | 57 | 4046D | 63 |
| 779S | 207 | 868D | 63 | 2536 | 195 | 3610 | 57 | 4097 | 66 |
| 779SD | 207 | 869 | 64 | 2629 | 195 | 3611 | 57 | 4098 | 66 |
| 780S | 207 | 871 | 243 | 2630 | 195 | 3612 | 57 | 4099 | 66 |
| 780SD | 207 | 874 | 243 | 2631 | 195 | 3613 | 57 | 4113D | 64 |
| 780SDDN | 207 | 891 | 164 | 2632 | 195 | 3614 | 57 | 4119 | 58 |
| 780SDL | 207 | 891L | 164 | 2633 | 195 | 3615 | 57 | 4120 | 58 |
| 781S | 207 | 892 | 165 | 2634 | 195 | 3616 | 57 | 4121 | 58 |
| 781SD | 207 | 893 | 163 | 2635 | 195 | 3617 | 57 | 4129 | 58 |
| 789 | 225 | 897 | 164 | 2636 | 195 | 3618 | 57 | 4131 | 58 |
| 790 | 172 | 902 | 158 | 2984 | 29 | 3619 | 57 | 4133 | 58 |
| 794A | 191 | 903SS | 153 | 3006 | 88 | 3620 | 57 | 4135 | 58 |
| 797 | 189,190 | 904 | 158 | 3007 | 88 | 3621 | 57 | 4137 | 58 |
| 798D | 170 | 905 | 158 | 3008 | 88 | 3622 | 57 | 4139 | 58 |
| 799 | 97 | 905M | 153 | 3138 | 46 | 3623 | 57 | 4140 | 58 |
| 799D | 170 | 905SS | 153 | 3138D | 46 | 3624 | 57 | 4143D | 59 |
| 800 | 176 | 907M | 153 | 3140 | 46 | 3625 | 57 | 4144D | 59 |
| 803 | 235 | 907SS | 153 | 3140D | 46 | 3626 | 57 | 4145D | 59 |
| 803SB | 216 | 911 | 159 | 3142 | 79 | 3627 | 57 | 4154D | 52 |
| 804 | 235 | 912 | 151 | 3485D | 62 | 3628 | 57 | 4260D | 59 |
| 804SB | 216 | 913M | 153 | 3485W | 62 | 3629 | 57 | 4261D | 61 |
| 805 | 177 | 913SS | 153 | 3486D | 62 | 3631 | 57 | 4262D | 59 |
| 805SB | 216 | 914 | 161 | 3486W | 62 | 3632 | 57 | 4263D | 61 |
| 809 | 182 | 915M | 153 | 3487D | 62 | 3740 | 67 | 4264D | 59 |
| 811 | 182 | 915SS | 153 | 3487W | 62 | 3742 | 67 | 4265D | 61 |
| 812 | 161 | 916 | 182 | 3488D | 62 | 3748 | 88 | 4266D | 59 |
| 812SS | 216 | 918 | 182 | 3488W | 62 | 3749 | 87 | 4267D | 61 |
| 813 | 161 | 919 | 182 | 3489D | 62 | 3750 | 78 | 4268D | 60 |
| 814 | 161 | 921 | 26 | 3489W | 62 | 3751 | 59 | 4269D | 60 |
| 815 | 182 | 922 | 15 | 3490D | 62 | 3752 | 59 | 4270D | 59 |
| 819 | 163 | 923 | 15 | 3490W | 62 | 3753 | 59 | 4272D | 59 |
| 819L | 163 | 924 | 12 | 3491D | 62 | 3754 | 59 | 4274D | 59 |
| 820 | 30,222,197 | 925 | 10 | 3491W | 62 | 3755 | 59 | 4276D | 59 |
| 820B | 30,222,197 | 926 | 9 | 3492D | 62 | 3756 | 59 | 4280D | 61 |
| 821 | 226,244 | 927 | 215 | 3492W | 62 | 3757 | 59 | 4282D | 62 |
| 821SB | 216 | 929 | 14 | 3493D | 62 | 3758 | 59 | 4283D | 61 |
| 822 | 95 | 930 | 14 | 3493W | 62 | 3759 | 59 | 4379 | 178,214 |
| 822SB | 216 | 931 | 15 | 3494D | 62 | 3760 | 59 | 4382 | 178,214 |
| 823 | 226,244 | 934 | 11 | 3494W | 62 | 3761 | 59 | 4384 | 178,214 |
| 824 | 95 | 935 | 182 | 3495D | 62 | 3762 | 59 | 4412 | 179 |
| 825 | 95 | 936 | 182 | 3495W | 62 | 3763 | 59 | 4413 | 177 |
| 826 | 89 | 970 | 210 | 3496D | 62 | 3764 | 59 | 4415 | 177 |
| 827 | 89 | 971 | 210 | 3496W | 62 | 3765 | 59 | 4417 | 178,214 |
| 828 | 89 | 972 | 210 | 3506D | 153 | 3766 | 59 | 4419 | 179 |
| 829 | 29 | 973 | 210 | 3506SD | 152 | 3767 | 59 | 4467DFD | 149,230 |
| 830 | 97 | 974 | 210 | 3508D | 153 | 3768 | 59 | 4468DF | 149,230 |
| 831 | 246 | 975 | 210 | 3508SD | 152 | 3769 | 59 | 4469DFD | 149,230 |
| 831L | 246 | 976 | 210 | 3508SDN | 153 | 3770 | 59 | 4470DF | 149,230 |
| 832 | 186 | 977 | 211 | 3510D | 153 | 3771 | 59 | 4471DFD | 149,230 |
| 833D | 63 | 978 | 211 | 3510SD | 152 | 3772 | 59 | 4472DF | 149,230 |
| 834D | 63 | 979 | 211 | 3512D | 153 | 3773 | 59 | 4473DFD | 149,230 |
| 835D | 63 | 980 | 211 | 3512SD | 152 | 3774 | 59 | 4474DF | 149,230 |
| 836 | 64 | 981 | 210 | 3512SDN | 153 | 3775 | 59 | 4497D | 70 |
| 838 | 141 | 990S | 47 | 3514D | 153 | 3776 | 59 | 4497P | 70 |
| 839 | 141 | 994S | 47 | 3514SD | 152 | 3777 | 59 | 4497RD | 70 |
| 840 | 22,117,221 | 998 | 235 | 3516SD | 152 | 3881SD | 61 | 4497RP | 70 |
| 841 | 22,117,221 | 999S | 47 | 3516SDN | 153 | 3883SD | 61 | 4498RD | 70 |
| 842 | 98 | 1790D | 64 | 3520SD | 152 | 3885SD | 61 | 4499RD | 70 |
| 843 | 98 | 1910.5FG | 7 | 3520SDN | 153 | 3887S | 58 | 4500D | 70 |

Marshalltown Part Number Listing

| PART NO. | PAGE NO. | PART NO. | PAGE NO. | PART NO. | PAGE NO. | PART NO. | PAGE NO. | PART NO. | PAGE NO. |
|----------|----------|----------|----------|----------|----------|----------|----------|----------|----------|
| 4500P | 70 | 5208D | 13,162 | 5796D | 231 | 6646 | 28 | 8304 | 65 |
| 4500RD | 70 | 5208W | 13,162 | 5798D | 231 | 6647 | 28 | 8305 | 65 |
| 4500RP | 70 | 5209D | 13,162 | 5871 | 98 | 6648 | 28 | 8308 | 65 |
| 4501D | 70 | 5209W | 13,162 | 6024 | 171 | 6649 | 200 | 8314 | 65 |
| 4501P | 70 | 5210D | 13,162 | 6040 | 160 | 6746 | 69 | 8316 | 65 |
| 4501RD | 70 | 5210W | 13,162 | 6041 | 160 | 6747 | 69 | 8317 | 65 |
| 4501RP | 70 | 5211D | 13,162 | 6042 | 160 | 6982 | 98 | 8374 | 65 |
| 4506D | 152 | 5211W | 13,162 | 6043 | 160 | 6983 | 98 | 9051 | 236 |
| 4506SD | 152 | 5301 | 170 | 6044 | 160 | 7258 | 71 | 9052 | 236 |
| 4508D | 152 | 5301BP | 170 | 06150D | 68 | 7258D | 71 | 9053 | 236 |
| 4508SD | 152 | 5301HP | 170 | 06150LRW | 68 | 7259 | 71 | 9055 | 196 |
| 4510D | 152 | 5301RH | 170 | 06150RD | 68 | 7259D | 71 | 9056 | 196 |
| 4510SD | 152 | 5301SK | 170 | 6157 | 181 | 7259DK | 71 | 9057 | 201 |
| 4512D | 152 | 5704S | 229 | 6158 | 180 | 7260 | 63 | 9058 | 235 |
| 4512SD | 152 | 5704SD | 229 | 6186 | 139 | 7260RDW | 71 | 9059 | 235 |
| 4514D | 152 | 5704SS | 229 | 6260 | 210 | 7260W | 63 | 9060 | 219 |
| 4514SD | 152 | 5704SSD | 229 | 6261 | 210 | 7301 | 63 | 9060RB | 219 |
| 4526D | 70 | 5705S | 229 | 6262 | 210 | 7301W | 63 | 9060SB | 219 |
| 4526P | 70 | 5705SD | 229 | 6263 | 210 | 7303 | 63 | 9063 | 235 |
| 4526RP | 70 | 5705SS | 229 | 6265 | 47 | 7303W | 63 | 9064 | 236 |
| 4528D | 70 | 5705SSD | 229 | 6266 | 212 | 7304 | 63 | 9069 | 235 |
| 4528P | 70 | 5706S | 229 | 6267 | 158 | 7304W | 63 | 9070 | 235 |
| 4528RP | 70 | 5706SD | 229 | 6268 | 158 | 7305 | 63 | 9072 | 236 |
| 4591 | 172 | 5706SS | 229 | 6269 | 158 | 7305W | 63 | 9074 | 237,196 |
| 4615D | 71 | 5706SSD | 229 | 6270 | 158 | 7314 | 63 | 9075 | 239 |
| 4623D | 71 | 5707S | 229 | 6271 | 154 | 7314W | 63 | 64110 | 238 |
| 4626D | 71 | 5707SD | 229 | 6272 | 154 | 7315 | 63 | 64310 | 238 |
| 4658DFL | 149,230 | 5707SS | 229 | 6273 | 154 | 7315W | 63 | 64901 | 239 |
| 4663DFDL | 149,230 | 5707SSD | 229 | 6274 | 210 | 7316 | 63 | 64902 | 239 |
| 4665DFL | 149,230 | 5708S | 229 | 6275 | 210 | 7316W | 63 | A3001 | 87 |
| 4681DFDL | 149,230 | 5708SD | 229 | 6286 | 211 | 7317 | 63 | A3002 | 87 |
| 4682DFL | 149,230 | 5708SS | 229 | 6287 | 211 | 7317W | 63 | A3003 | 87 |
| 4683DFDL | 149,230 | 5708SSD | 229 | 6392 | 161 | 7319 | 63 | A3008 | 87 |
| 4694DFL | 149,230 | 5709S | 229 | 6394 | 160 | 7319W | 63 | A4171 | 113 |
| 4710 | 67 | 5709SD | 229 | 6395 | 160,161 | 7374 | 63 | A4171LH | 113 |
| 4712 | 67 | 5709SS | 229 | 6396 | 160,161 | 7374W | 63 | A4172 | 113 |
| 4713DFDL | 149,230 | 5709SSD | 229 | 6397 | 160,161 | 7380 | 63 | A4172LH | 113 |
| 4714 | 67 | 5744 | 233 | 6415 | 99 | 7380W | 63 | A4173 | 113 |
| 4733 | 95 | 5745 | 233 | 6416 | 99 | 7408 | 63 | A4174 | 112 |
| 4734 | 95 | 5748 | 233 | 6417 | 99 | 7408W | 63 | A4175 | 112 |
| 4735 | 95 | 5749 | 233 | 6419 | 99 | 7545 | 67 | A4176 | 112 |
| 4746 | 95 | 5754 | 185 | 6423 | 99 | 7546 | 67 | AB4 | 85 |
| 4748 | 95 | 5755 | 185 | 6425 | 99 | 7547 | 67 | AB906 | 192 |
| 4750 | 95 | 5756 | 185 | 6442 | 98 | 7550 | 67 | AB4013 | 97 |
| 4752 | 95 | 5758 | 185 | 6443 | 98 | 7551 | 67 | ADA22 | 125 |
| 4754 | 95 | 5759 | 185 | 6515 | 97 | 7552 | 67 | ADA23 | 125 |
| 48" | 250 | 5760 | 185 | 6516 | 97 | 7553 | 67 | ADA24 | 125 |
| 4816 | 88 | 5762 | 185 | 6517 | 29 | 7554 | 67 | AH212D | 13,162 |
| 4817 | 88 | 5764 | 185 | 6518 | 200 | 7555 | 67 | AH659 | 13,163 |
| 4818 | 85 | 5767D | 231 | 6519 | 29 | 7556 | 67 | AHK4948 | 85 |
| 4819 | 85 | 5768D | 231 | 6520 | 225 | 7588 | 52 | AKD12 | 186 |
| 4820 | 85 | 5769D | 231 | 6522 | 29 | 7589 | 52 | AKD12RB | 186 |
| 4821 | 85 | 5772S | 229 | 6523 | 29 | 7590 | 52 | AKD14 | 186 |
| 4822 | 85 | 5772SD | 229 | 6524 | 29 | 7591 | 52 | AKD14RB | 186 |
| 4826 | 88 | 5774S | 229 | 6525 | 29 | 7592 | 57 | AKD18 | 186 |
| 4844 | 28,147 | 5774SD | 229 | 6526 | 28 | 7593 | 57 | AKD18RB | 186 |
| 4908 | 25 | 5776S | 229 | 6527 | 28 | 7594 | 52 | AKD22 | 186 |
| 4910 | 25 | 5776SD | 229 | 6528 | 29 | 7595 | 52 | AKD22RB | 186 |
| 4911 | 25 | 5776SS | 229 | 6529 | 29 | 7596 | 52 | ALS504 | 27 |
| 4912 | 25 | 5776SSD | 229 | 6555 | 28,234 | 7597 | 52 | AP753 | 90 |
| 4913 | 25 | 5779S | 207,229 | 6556 | 28,234 | 7598 | 52 | AP753H | 90 |
| 4914 | 25 | 5779SD | 207,229 | 6596 | 97 | 7599 | 52 | AP867 | 90 |
| 4915 | 25 | 5783S | 229 | 6597 | 97 | 7600 | 52 | AP867-5 | 90 |
| 5205D | 13,162 | 5783SD | 229 | 6598 | 97 | 8275 | 65 | AP867H | 90 |
| 5205W | 13,162 | 5784S | 229 | 6599 | 97 | 8276 | 65 | AP867H-5 | 90 |
| 5206D | 13,162 | 5784SD | 229 | 6629 | 98 | 8277 | 65 | AP867RH | 90 |
| 5206W | 13,162 | 5786D | 231 | 6630 | 98 | 8278 | 65 | APH24H | 91 |
| 5207D | 13,162 | 5787D | 231 | 6631 | 98 | 8279 | 65 | APH30 | 91 |
| 5207W | 13,162 | 5788D | 231 | 6645 | 28 | 8303 | 65 | APH30H | 91 |

Marshalltown Part Number Listing

| PART NO. | PAGE NO. | PART NO. | PAGE NO. | PART NO. | PAGE NO. | PART NO. | PAGE NO. | PART NO. | PAGE NO. |
|-----------|----------|-----------|----------|-------------|----------|-------------|----------|----------|----------|
| APH195 | 91 | B300 | 20 | BC2520BF9 | 73 | BHF624 | 18 | CB72DE | 76 |
| APH195H | 91 | B300SG | 20 | BC2520RB | 73 | BHS720 | 18 | CB96 | 76 |
| ARBLFCLUS | 124 | B312 | 20 | BC2520T91 | 73 | B1142D | 67 | CB96DE | 76 |
| ARBORLEAF | 124 | B312SG | 20 | BC2524BF9 | 73 | B1145D | 67 | CB120 | 76 |
| ASBLACK | 119 | B361MT | 78 | BC2524RB | 73 | B1146D | 67 | CB120DE | 76 |
| ASBLACKF | 119 | B365MT | 78 | BC2524T91 | 73 | B1153D | 67 | CB144 | 76 |
| ASBLUE | 119 | B400 | 20 | BC3697 | 23 | BJ850 | 16 | CB168 | 76 |
| ASBLUEF | 119 | B412 | 20 | BC15358BF9 | 73 | BJCC1 | 15 | CB192 | 76 |
| ASGREEN | 119 | B481MT | 78 | BC15358RB | 73 | BJCC12 | 15 | CB370 | 177 |
| ASGREENF | 119 | B485MT | 78 | BC15358T91 | 73 | BJCC34 | 15 | CB429 | 177 |
| ASHLFCLUS | 124 | B2415MT | 78 | BC153510BF9 | 73 | BJCC38 | 15 | CB507 | 27 |
| AT10MA | 140 | B2475MT | 78 | BC153510RB | 73 | BJCC58 | 15 | CB904 | 192 |
| ATH45 | 12 | B3615MT | 78 | BC153510T91 | 73 | BJCV1 | 15 | CBC | 219 |
| ATH45S | 12 | B3675MT | 78 | BC153512BF9 | 73 | BJCV12 | 15 | CBC813 | 219 |
| ATH50 | 12 | B4815MT | 78 | BC153512RB | 73 | BJCV34 | 15 | CC471 | 215 |
| ATH50S | 12 | B4875MT | 78 | BC153512T91 | 73 | BJCV38 | 15 | CC480 | 175 |
| ATH54 | 12 | B24225MT | 78 | BC153514BF9 | 73 | BJCV58 | 15 | CC766 | 175 |
| ATH54S | 12 | B36225MT | 78 | BC153514RB | 73 | BK385 | 154 | CE384 | 54 |
| ATH63 | 12,243 | B48225MT | 78 | BC153514T91 | 73 | BK386 | 154 | CE384P | 55 |
| ATH114S | 12 | BACS | 220 | BC153516BF9 | 73 | BK387 | 154 | CE500S | 54 |
| ATS81 | 175 | BART4 | 104 | BC153516RB | 73 | BK388 | 154 | CE500SP | 55 |
| B5 48 | 82 | BART7 | 104 | BC153516T91 | 73 | BKTSG75 | 10 | CE501S | 54 |
| B5 60 | 82 | BART8 | 104 | BC153520BF9 | 73 | BKTSG75SS | 10 | CE501SP | 55 |
| B5 60M | 82 | BART9 | 104 | BC153520RB | 73 | BKTSG825 | 10 | CE502S | 54 |
| B5 72 | 82 | BART10 | 104 | BC153520T91 | 73 | BP469 | 214 | CE502SP | 55 |
| B5 72M | 82 | BART12 | 104 | BC153524BF9 | 73 | BP984M | 98 | CE503S | 54 |
| B5 72TF | 83 | BBJ1258 | 16 | BC153524RB | 73 | BPT6 | 245 | CE503SP | 55 |
| B5 96 | 82 | BC14 | 104 | BC153524T91 | 73 | BPT7 | 245 | CE504S | 54 |
| B5 120 | 82 | BC14RH | 104 | BCAXLE | 23 | BPT8 | 245 | CE504SP | 55 |
| B5 144 | 82 | BC18 | 104 | BCBEARING | 23 | BPT9 | 245 | CE505S | 54 |
| B30BI | 76 | BC18RH | 104 | BCWHEEL | 23 | BPT10 | 245 | CE505SP | 55 |
| B32LB | 105 | BC24 | 104 | BD862 | 165 | BPT11 | 245 | CE506S | 54 |
| B33LB | 105 | BC24RH | 104 | BD863 | 165 | BPT12 | 245 | CE506SP | 55 |
| B34LB | 105 | BC30 | 104 | BF8 | 84 | BPT13 | 245 | CE507S | 54 |
| B34LBL | 105 | BC30RH | 104 | BF9 | 86 | BS748 | 197 | CE507SP | 55 |
| B36 | 77 | BC36 | 104 | BF422 | 77 | BSBLACK | 121 | CE508S | 54 |
| B36B | 77 | BC36RH | 104 | BF428 | 77 | BSBLACKF | 121 | CE508SP | 55 |
| B36FR | 77 | BC42 | 104 | BF428B | 77 | BSBLUE | 121 | CE509S | 54 |
| B36FRB | 77 | BC42RH | 104 | BFB36 | 97 | BSBLUEF | 121 | CE509SP | 55 |
| B42 | 77 | BC82 | 160 | BFB40 | 97 | BSGREEN | 121 | CE510S | 54 |
| B42B | 77 | BC246BF9 | 73 | BFB48 | 97 | BSGREENF | 121 | CE510SP | 55 |
| B42BI | 76 | BC246RB | 73 | BFB54 | 97 | BST16 | 28,239 | CE511S | 54 |
| B42FR | 77 | BC246T91 | 73 | BFB60 | 97 | BSTK6 | 154 | CE511SP | 55 |
| B42FRB | 77 | BC248BF9 | 73 | BFB72 | 97 | BSTK8 | 154 | CE512S | 54 |
| B45 | 77 | BC248RB | 73 | BFF124 | 179 | BSTK10 | 154 | CE512SP | 55 |
| B45B | 77 | BC248T91 | 73 | BFH9 | 84 | BSTK12 | 154 | CE513S | 54 |
| B45FR | 77 | BC2410BF9 | 73 | BFH9N | 84 | BSTK14 | 154 | CE513SP | 55 |
| B45FRB | 77 | BC2410RB | 73 | BFKIT1 | 75 | BTk1 | 30 | CE514S | 54 |
| B45RA | 77 | BC2410T91 | 73 | BFKIT2 | 75 | BTk2 | 30 | CE514SP | 55 |
| B48 | 77 | BC2412BF9 | 73 | BFKIT3 | 75 | BTP10 | 9 | CE515S | 54 |
| B48B | 77 | BC2412RB | 73 | BFKIT4 | 75 | BTSG11 | 9 | CE515SP | 55 |
| B48BI | 76 | BC2412T91 | 73 | BFKIT5 | 75 | BTSG12 | 9 | CE516S | 54 |
| B48FR | 77 | BC2414BF9 | 73 | BFKIT6 | 75 | BTSG1155 | 9 | CE516SP | 55 |
| B48FRB | 77 | BC2414RB | 73 | BFKIT7 | 75 | BWBRICK | 121 | CE517S | 54 |
| B48FRRA | 77 | BC2414T91 | 73 | BFKIT8 | 75 | BWBRICKF | 121 | CE517SP | 55 |
| B48RA | 77 | BC2416BF9 | 73 | BFKIT9 | 75 | C24R | 79 | CE518S | 54 |
| B60 | 77 | BC2416RB | 73 | BFKIT10 | 75 | C30 | 79 | CE518SP | 55 |
| B60B | 77 | BC2416T91 | 73 | BFKIT11 | 75 | C30R | 79 | CE519S | 54 |
| B60BI | 76 | BC2418BF9 | 73 | BFKIT12 | 75 | C36R | 79 | CE519SP | 55 |
| B60FR | 77 | BC2418RB | 73 | BG36 | 82 | C48 | 79 | CE520S | 54 |
| B60FRB | 77 | BC2418T91 | 73 | BG36F | 82 | C48R | 79 | CE520SP | 55 |
| B72 | 77 | BC2420BF9 | 73 | BG42 | 82 | C902 | 192 | CE521S | 54 |
| B72B | 77 | BC2420RB | 73 | BG42F | 82 | CANTERVVMIX | 130 | CE522S | 54 |
| B72FR | 77 | BC2420T91 | 73 | BG48 | 82 | CANTILCOR | 125 | CE523S | 54 |
| B72FRB | 77 | BC2424BF9 | 73 | BG60 | 82 | CANTILEEDGE | 125 | CE524S | 54 |
| B77 | 227 | BC2424RB | 73 | BG72 | 82 | CB48 | 76 | CE525S | 54 |
| B212 | 20 | BC2424T91 | 73 | BG120 | 82 | CB48DE | 76 | CE526S | 54 |
| B212SG | 20 | BC2516BF9 | 73 | BH760 | 18 | CB60 | 76 | CE527S | 54 |
| B241MT | 78 | BC2516RB | 73 | BH761 | 18 | CB60DE | 76 | CE528S | 54 |
| B245MT | 78 | BC2516T91 | 73 | BHF616 | 18 | CB72 | 76 | CE529S | 54 |

Marshalltown Part Number Listing

| PART NO. | PAGE NO. | PART NO. | PAGE NO. | PART NO. | PAGE NO. | PART NO. | PAGE NO. | PART NO. | PAGE NO. |
|----------|----------|-----------|----------|--------------|----------|----------|----------|-----------|----------|
| CE530S | 54 | CG81814D | 65 | CR4RRB | 72 | DCM30 | 163 | E343 | 199 |
| CE531S | 54 | CG83478D | 65 | CR5 | 160 | DCM36 | 163 | E345 | 199 |
| CE532S | 54 | CG83478W | 65 | CR5RP | 160 | DF10 | 24 | E383 | 196 |
| CE533S | 54 | CG83812D | 65 | CR5RRB | 72 | DF12 | 24 | E385 | 196 |
| CE534S | 54 | CG83812W | 65 | CR6RRB | 72 | DFP18 | 24 | E397 | 196 |
| CE535S | 54 | CG101234D | 65 | CR6RT91 | 72 | DGB661 | 18 | E398 | 196 |
| CE535SP | 55 | CG101234W | 65 | CR6SRB | 72 | DGS91 | 213 | E399 | 196 |
| CE540B | 56 | CG101412D | 65 | CR6ST91 | 72 | DH178 | 176 | E400 | 187 |
| CE540BP | 56 | CG101412W | 65 | CR8RRB | 72 | DH694 | 176 | E400C | 187 |
| CE541B | 56 | CG101814D | 65 | CR8RT91 | 72 | DH764 | 176 | E400NB | 187 |
| CE541BP | 56 | CG103478D | 65 | CR8SRB | 72 | DH886 | 176 | E404 | 200 |
| CE542B | 56 | CG103478W | 65 | CR8ST91 | 72 | DK296 | 203 | E406 | 200 |
| CE543B | 56 | CG103812D | 65 | CR10RRB | 72 | DK298 | 203 | E407 | 200 |
| CE543BP | 56 | CG103812W | 65 | CR10RT91 | 72 | DP4 | 184 | E408 | 200 |
| CE544B | 56 | CGW961SS | 60 | CR10SRB | 72 | DP6 | 184 | E409 | 200 |
| CE544BP | 56 | CGW962SS | 60 | CR10ST91 | 72 | DP8 | 184 | E410 | 200 |
| CE545B | 56 | CHOCLNR1 | 137 | CR12RRB | 72 | DP12 | 239,100 | E440 | 199 |
| CE545BP | 56 | CHOCLNR5 | 137 | CR12RT91 | 72 | DP16 | 239,100 | E442 | 199 |
| CE546B | 56 | CHPAT18 | 124 | CR12SRB | 72 | DPC930 | 172 | E444 | 222,199 |
| CE546BP | 56 | CHRB | 122 | CR12ST91 | 72 | DPLE72 | 194 | E550 | 182 |
| CE547B | 56 | CHRBFB | 122 | CRPACK1 | 72,73,74 | DR381 | 173 | E551 | 181 |
| CE547BP | 56 | CHSCB | 121 | CRPACK2 | 72,73,74 | DR389 | 173 | E740 | 195 |
| CE548B | 56 | CHSCBF | 121 | CRPACK3 | 72,73,74 | DR390 | 173 | E1001 | 202 |
| CE548BP | 56 | CHSLT18 | 123 | CRSH12 | 217 | DS628 | 175 | E1002 | 202 |
| CE550B | 56 | CHSLT48 | 123 | CRSH18 | 217 | DS921 | 173 | E1003 | 202 |
| CE551B | 56 | CK861D | 155 | CS247 | 89 | DTK3 | 202 | E1004 | 202 |
| CE551BP | 56 | CLB20FR | 79 | CS247H | 89 | DTK4 | 203 | E1005 | 202 |
| CE552B | 56 | CLB66FR | 79 | CSBLACK | 119 | DJ648SD | 208 | E1006 | 202 |
| CE552BP | 56 | CLB205FR | 79 | CSBLACKF | 119 | DJ649SD | 208 | E1007 | 202 |
| CE553B | 56 | CLB224FR | 79 | CSBLUE | 119 | DJ650SD | 208 | E1008 | 202 |
| CE553BP | 56 | CLB225FR | 79 | CSBLUEF | 119 | DJ651SD | 208 | E1011 | 214,202 |
| CE554B | 56 | CLB244FR | 79 | CSGREEN | 119 | DJ652SD | 208 | E1012 | 202 |
| CE554BP | 56 | CLB284FR | 79 | CSGREENF | 119 | DJ653SD | 208 | E1013 | 202 |
| CE555B | 56 | CLB304FR | 79 | CSHDL | 89 | DJ654SD | 208 | E1014 | 202 |
| CE555BP | 56 | CLC28R | 79 | CSKK | 220 | DJ655SD | 208 | E1015 | 214,202 |
| CE556B | 56 | CLC30R | 79 | CSP494F | 182 | DJ656SD | 208 | E1016 | 202 |
| CE556BP | 56 | CLR REL | 137 | CSP494M | 182 | DJ657SD | 208 | E1017 | 202 |
| CE557B | 56 | CM419 | 91 | CSR5 | 219 | DJ658SD | 208 | E1018 | 202 |
| CE558B | 56 | CM419-5 | 91 | CSR35 | 219 | DJ659SD | 208 | E1080 | 214,202 |
| CE558BP | 56 | COBBLE | 119 | CT03 | 172 | DJ660SD | 208 | E1100 | 202 |
| CE559B | 56 | COBBLEF | 119 | CT197SSD | 59 | DWS467 | 183 | E1202 | 202 |
| CE559BP | 56 | COFLAG | 121 | CT292 | 159 | DWS467-3 | 183 | E1203 | 202 |
| CE560B | 56 | COFLAGF | 121 | CT911 | 159 | E3-16S | 237 | E1204 | 202 |
| CE561B | 56 | COLDISP | 169 | CTHCHISEL12 | 19 | E3-20S | 237 | E1205 | 202 |
| CE562B | 56 | CPOAK | 132 | CTHCHISEL34 | 19 | E3-22SM | 237 | E1207 | 202 |
| CE563B | 56 | CPBRKRD | 132 | CTHCHISEL38 | 19 | E3-24SM | 237 | E1241 | 199 |
| CE564S | 54 | CPCBUFF | 132 | CTHPOINT1 | 19 | E3-28SM | 237 | E1242 | 199 |
| CE565S | 54 | CPCHAR | 132 | CTHPOINT58 | 19 | E3-30SM | 237 | E1243 | 199 |
| CE566S | 54 | CPCSAGE | 132 | CTHPOINT78 | 19 | E14 | 196 | E1244 | 199 |
| CE567S | 54 | CPDCHAR | 132 | CTHSET2 | 19 | E38 | 199 | E1245 | 199 |
| CE568S | 54 | CPDROSE | 132 | CTHSET3 | 19 | E40 | 180 | E1246 | 199 |
| CE569S | 54 | CPGCLAY | 132 | CTHSET112 | 19 | E54D | 200 | E1247 | 199 |
| CE570S | 54 | CPGGRAY | 132 | CTHSET214 | 19 | E83D | 201 | E2002 | 201 |
| CFH280 | 238 | CPHRED | 132 | CTHTRACER2 | 19 | E84 | 201 | E2411 | 235 |
| CFH281 | 238 | CPHWHEAT | 132 | CTHTRACER3 | 19 | E90 | 197 | E6121 | 196 |
| CFH292 | 238 | CPLANST | 132 | CTHTRACER112 | 19 | E91 | 197 | E6125 | 196 |
| CFH293 | 238 | CPMBROWN | 132 | CTK2 | 117 | E96 | 201 | E6151 | 201 |
| CFH293M | 238 | CPMILLST | 132 | CTK3 | 117 | E97 | 201 | E6151-1 | 201 |
| CG396 | 64 | CPPEWTER | 132 | CUTSTNEDGE | 125 | E98D | 201 | E9483 | 199 |
| CG396P | 64 | CPSANDST | 132 | DA097SSD | 60 | E119 | 201 | E9484 | 199 |
| CG511SSD | 60 | CPSBEIGE | 132 | DA098SSD | 60 | E176 | 237 | EA917 | 158 |
| CG512SSD | 60 | CPSFBUFF | 132 | DA099SSD | 60 | E177 | 237 | EB464 | 250 |
| CG513SSD | 60 | CPSIENNA | 132 | DAW360SS | 60 | E182 | 237 | EF87D | 212 |
| CG514SSD | 59 | CPSMGRAY | 132 | DAW361SS | 60 | E216D | 200 | EF88D | 212 |
| CG650SSD | 60 | CPSMOKE | 132 | DAW362SS | 60 | E225D | 200 | EL701 | 194 |
| CG651SSD | 60 | CPSLATE | 132 | DAW363SS | 60 | E226D | 200 | ELMLEAF | 124 |
| CG81234D | 65 | CPSTAN | 132 | DBZ | 195 | E312BL | 18 | EM465 | 250 |
| CG81234W | 65 | CPTCOTTA | 132 | DC344LSC | 172 | E320BLC | 18 | EMF466 | 250 |
| CG81412D | 65 | CR3 | 160 | DC344SC | 172 | E324BLC | 18 | ENG-HONDA | 92 |
| CG81412W | 65 | CR3RP | 160 | DC344U | 172 | E341 | 199 | EP462 | 250 |

Marshalltown Part Number Listing

| PART NO. | PAGE NO. | PART NO. | PAGE NO. | PART NO. | PAGE NO. | PART NO. | PAGE NO. | PART NO. | PAGE NO. |
|------------|----------|------------|----------|-----------|----------|------------|----------|------------|----------|
| EPC463 | 250 | FOCM | 133 | FS47D | 223,242 | GRH | 138 | HT1438 | 220 |
| ER007 | 227 | FOPOLY5 | 133 | FS903 | 192 | GS671 | 221 | HT516916 | 220 |
| ESBAMBER4 | 129 | FP48 | 84,182 | FSBLACK | 120 | GT28CN | 217 | HVS87 | 179 |
| ESBAMBER32 | 129 | FP224 | 192 | FSBLACKF | 120 | GT198SSD | 59 | HVYSTN18 | 123 |
| ESBLACK4 | 129 | FP612 | 84,182 | FSBLUE | 120 | GT871D | 155 | HVYSTN48 | 123 |
| ESBLACK32 | 129 | FP832 | 84,182 | FSBLUEF | 120 | GT872D | 155 | HWPLANK | 123 |
| ESBLUE4 | 129 | FP905 | 192 | FSGREEN | 120 | GTP7 | 12 | HWPLANKSGL | 123 |
| ESBLUE32 | 129 | FPK2 | 157 | FSGREENF | 120 | GTSG35 | 12 | HWPLANKX | 123 |
| ESCORLTH4 | 129 | FPK2HH | 157 | FT6 | 84 | GUIDE12 | 217 | HWPLANKY | 123 |
| ESCORLTH32 | 129 | FPK3HH | 157 | FT6N | 84 | GUIDE18 | 217 | INAOAK5 | 135 |
| ESCSEA4 | 129 | FPK112 | 157 | FT114P | 47 | H2OCS1 | 138 | INAOAK6 | 135 |
| ESCSEA32 | 129 | FPK112HH | 157 | FT124SS | 46 | H2OCS5 | 138 | INBRED5 | 135 |
| ESGRAY4 | 129 | FPK112SSHH | 157 | FT144 | 47 | H2OWL1 | 138 | INBRED6 | 135 |
| ESGRAY32 | 129 | FPK114 | 157 | FT144P | 47 | H2OWL5 | 138 | INCBLF5 | 135 |
| ESKONA4 | 129 | FR18R | 82 | FT164 | 47 | H608 | 190 | INCBLF6 | 135 |
| ESKONA32 | 129 | FR24 | 82 | FT164P | 47 | H724 | 190 | INCHAR5 | 135 |
| ESLICHEN4 | 129 | FR24AA | 81 | FT362 | 46 | H826-5 | 89 | INCHAR6 | 135 |
| ESLICHEN32 | 129 | FR24R | 82 | FT363 | 46 | H827-5 | 89 | INCSAGE5 | 135 |
| ESPURPLE4 | 129 | FR24RAA | 81 | FT364 | 46 | HC125A | 188 | INCSAGE6 | 135 |
| ESPURPLE32 | 129 | FR24RTA | 81 | FT365 | 46 | HC127A | 188 | INDCHAR5 | 135 |
| ESRED4 | 129 | FR24TA | 81 | FT366 | 150 | HC128A | 188 | INDCHAR6 | 135 |
| ESRED32 | 129 | FR30 | 82 | FT367 | 150 | HC129A | 188 | INDROSE5 | 135 |
| ESSTYGN4 | 129 | FR30AA | 81 | FT368 | 150 | HC130A | 188 | INDROSE6 | 135 |
| ESSTYGN32 | 129 | FR30R | 82 | FT372R | 46 | HDARBUFF | 136 | INGCLAY5 | 135 |
| ESTANNIN4 | 129 | FR30RAA | 81 | FT373R | 46 | HDBLUST | 136 | INGCLAY6 | 135 |
| ESTANNIN32 | 129 | FR30RTA | 81 | FT374R | 46 | HDBONE | 136 | INGGRY5 | 135 |
| ESTAPLER | 220 | FR30TA | 81 | FT375R | 46 | HDBRKR | 136 | INGGRY6 | 135 |
| ESTAPLES | 220 | FR36 | 82 | FT376R | 46 | HDCCGRAY | 136 | INHRED5 | 135 |
| ESTAUP4 | 129 | FR36AA | 81 | FT377R | 150 | HDGCPNK | 136 | INHRED6 | 135 |
| ESTAUP32 | 129 | FR36BF9 | 81 | FT799SS | 47 | HDCHSTNT | 136 | INHWHT5 | 135 |
| ESVERDIG4 | 129 | FR36R | 82 | FTFR360 | 47 | HDCTAN | 136 | INHWHT6 | 135 |
| ESVERDIG32 | 129 | FR36RAA | 81 | FTFR362 | 47 | HDDCHAR | 136 | INLSTN5 | 135 |
| ESWBRNZ4 | 129 | FR36RBF9 | 81 | FTFR363 | 47 | HDDRKR | 136 | INLSTN6 | 135 |
| ESWBRNZ32 | 129 | FR36RTA | 81 | FTFR364 | 47 | HDFRCRM | 136 | INMBRN5 | 135 |
| ESYELLOW4 | 129 | FR36TA | 81 | FTFR365 | 47 | HDGINKGO | 136 | INMBRN6 | 135 |
| ESYELLOW32 | 129 | FR42 | 82 | FTFR369 | 47 | HDGRLIN | 136 | INMGRY5 | 135 |
| FB865 | 177 | FR42AA | 81 | FTFR370R | 47 | HDGRPLM | 136 | INMGRY6 | 135 |
| FB865RP | 177 | FR42R | 82 | FTFR372R | 47 | HDJUNIP | 136 | INMILL5 | 135 |
| FC244 | 191 | FR42RAA | 81 | FTFR373R | 47 | HDNANWHT | 136 | INMILL6 | 135 |
| FFPK2 | 157 | FR42RTA | 81 | FTFR374R | 47 | HDRUSSET | 136 | INPEWT5 | 135 |
| FFPK112 | 157 | FR42TA | 81 | FTFR375R | 47 | HDSLTRY | 136 | INPEWT6 | 135 |
| FFPK114 | 157 | FR48 | 82 | FTFR379R | 47 | HDSMOKE | 136 | INSBEIG5 | 135 |
| FFS7 | 222 | FR48AA | 81 | FTS24 | 176 | HDTCOTTA | 136 | INSBEIG6 | 135 |
| FFS7RB | 222 | FR48R | 82 | FTS48 | 176 | HDTRAVR | 136 | INSFBUF5 | 135 |
| FFS14 | 222 | FR48RAA | 81 | G578 | 190 | HDWALNUT | 136 | INSFBUF6 | 135 |
| FFS14RB | 222 | FR48RTA | 81 | G695 | 190 | HDWHEAT | 136 | INSIEN5 | 135 |
| FFS18 | 222 | FR48TA | 81 | G725 | 190 | HERRBRK | 121 | INSIEN6 | 135 |
| FFS18RB | 222 | FRB24AA | 81 | GB690 | 18 | HERBRKF | 121 | INSMOKE5 | 135 |
| FFS22 | 222 | FRB24RAA | 81 | GB691 | 17 | HG577 | 190 | INSMOKE6 | 135 |
| FFS22RB | 222 | FRB24RTA | 81 | GB692 | 17 | HG692 | 190 | INSDST5 | 135 |
| FFS36 | 222 | FRB24TA | 81 | GBK0306 | 23 | HGSTGRY | 136 | INSDST6 | 135 |
| FFS36RB | 222 | FRB30AA | 81 | GF43 | 213 | HH987F | 98 | INSSLT5 | 135 |
| FFS48 | 222 | FRB30RAA | 81 | GF247 | 212 | HHP986F | 98 | INSSLT6 | 135 |
| FFS48RB | 222 | FRB30RTA | 81 | GF248 | 212 | HICKLFCLUS | 124 | INTAN5 | 135 |
| FIL309 | 188 | FRB30TA | 81 | GFF124 | 178 | HM4949 | 162 | INTAN6 | 135 |
| FJK4 | 157 | FRB36AA | 81 | GG371 | 245 | HNG307 | 188 | INWTC5 | 135 |
| FJK4HH | 157 | FRB36BF9 | 81 | GINKLEAFL | 124 | HONLFLCLUS | 124 | INWTC6 | 135 |
| FJK4SSHH | 157 | FRB36RAA | 81 | GINKLEAFS | 124 | HOS308 | 188 | ITSLAT18 | 123 |
| FJK5 | 157 | FRB36RBF9 | 81 | GJ1258 | 16 | HP15 | 24 | ITSLAT48 | 123 |
| FJK5HH | 157 | FRB36RTA | 81 | GJ5834 | 16 | HS097 | 180 | JAWSET | 107 |
| FJK5SSHH | 157 | FRB36TA | 81 | GKP36 | 225,244 | HS98SG | 180 | JK445F | 158 |
| FJK6 | 157 | FRB42AA | 81 | GKP37 | 225,244 | HS98W | 180 | JK744 | 158 |
| FJK6HH | 157 | FRB42RAA | 81 | GKP368 | 225,244 | HS634 | 190 | JK745 | 158 |
| FJK6SSHH | 157 | FRB42RTA | 81 | GKPClips | 225,244 | HS901 | 180 | JK746 | 158 |
| FJK8 | 157 | FRB42TA | 81 | GOISHOES | 139 | HSP88 | 107 | JK883D | 155 |
| FLAT PST | 138 | FRB48AA | 81 | GP478 | 160,161 | HT8 | 102,148 | JK884D | 155 |
| FM629 | 164 | FRB48RAA | 81 | GP479 | 160,161 | HT9R | 139 | JK885D | 155 |
| FM661 | 164 | FRB48RTA | 81 | GR24 | 138 | HT10 | 102,148 | JK886D | 155 |
| FM774 | 164 | FRB48TA | 81 | GR36 | 138 | HT54 | 175 | JK886SSD | 155 |

Marshalltown Part Number Listing

| PART NO. | PAGE NO. | PART NO. | PAGE NO. | PART NO. | PAGE NO. | PART NO. | PAGE NO. | PART NO. | PAGE NO. |
|-----------|----------|----------|----------|-----------|----------|-----------|----------|----------|----------|
| JK896D | 155 | M8FBB | 167 | M7124 | 157 | MAH4 | 170 | MC36RPBA | 80 |
| Jointer | 251 | M8FFB | 167 | M7152 | 157 | MAH8 | 170 | MC36RRL | 80 |
| JP570XE | 216 | M10FBB | 167 | M7153 | 157 | MAH8A | 170 | MC36RTA | 80 |
| JP50003 | 216 | M10FFB | 167 | M7154 | 157 | MAH9 | 170 | MC48 | 80 |
| JP50010 | 216 | M12FBB | 167 | M7155 | 157 | MAH9A | 170 | MC48AA | 80 |
| JP50010A | 216 | M12FFB | 167 | M7203 | 157 | MAH32 | 170 | MC48PBA | 80 |
| JP50010B | 216 | M14T | 216 | M7204 | 157 | MAH33 | 170 | MC48R | 80 |
| JP50010C | 216 | M25CF | 167 | M7205 | 157 | MAH325 | 170 | MC48RAA | 80 |
| JP50010D | 216 | M35CF | 167 | M7221 | 157 | MAH335 | 170 | MC48RL | 80 |
| JP50020 | 216 | M42BBH | 168 | M7303 | 157 | MAHEXT | 167 | MC48RPBA | 80 |
| JP50026 | 216 | M42BH | 168 | M7304 | 157 | MAHEXTL | 167 | MC48RRL | 80 |
| JP57004 | 216 | M1404 | 216 | M7305 | 157 | MAHR12 | 167 | MC48RTA | 80 |
| JP57015 | 216 | M1415 | 216 | M7340 | 113 | MAHR13 | 167 | MC48TA | 80 |
| JP68004 | 216 | M1420 | 216 | M7341 | 113 | MAHR22 | 167 | MCBNCR | 166 |
| JP68015 | 216 | M1421 | 216 | M7342 | 113 | MAHR23 | 167 | MCEXT90 | 166 |
| JP700ST | 216 | M1422 | 216 | M7342ELB | 112 | MAHR125 | 167 | MCFBEXT | 168 |
| JR008 | 227 | M3142 | 79 | M7342ELG | 112 | MAHR135 | 167 | MCFBH | 168 |
| KB230 | 101 | M5121 | 156 | M7343 | 113 | MAHR225 | 167 | MCFH | 167 |
| KB451 | 101 | M5122 | 156 | M7343ELB | 112 | MAHR235 | 167 | MCINT90 | 166 |
| KB455 | 101 | M5122SS | 156 | M7343ELG | 112 | MAPLELEAF | 124 | MCMT24 | 166 |
| KB459 | 101 | M5123 | 156 | M7345 | 110 | MAPLFCLUS | 124 | MCMT36 | 166 |
| KD12 | 186 | M5124 | 156 | M7346 | 110 | MB36 | 77 | MCMT42 | 166 |
| KD18 | 186 | M5124SS | 156 | M7349 | 113 | MB36B | 77 | MCOBCR | 166 |
| KD18C | 186 | M5153 | 156 | M7349ELB | 112 | MB36R | 77 | MCR | 166 |
| KD18CD | 186 | M5154 | 156 | M7349ELG | 112 | MB36RB | 77 | MCRA2 | 166 |
| KD24 | 186 | M5155 | 156 | M7352 | 113 | MB42 | 77 | MCREXT | 166,169 |
| KD24C | 186 | M5203 | 156 | M7352ELB | 112 | MB42R | 77 | MCREXTL | 166,169 |
| KD24CD | 186 | M5203SS | 156 | M7352ELG | 112 | MB42RB | 77 | MCRH | 166,169 |
| KD36 | 186 | M5204 | 156 | M7360ELG | 113 | MB45 | 77 | MCT2 | 170 |
| KENLFCLUS | 124 | M5221 | 156 | M7363ELG | 113 | MB45B | 77 | MCT4 | 170 |
| KKSC | 220 | M5221DP | 156 | M7367 | 113 | MB45R | 77 | MCT5 | 170 |
| KP1 | 226,244 | M5303 | 156 | M7368 | 113 | MB45RB | 77 | MCT15 | 170 |
| LB14 | 94 | M5303SS | 156 | M7371 | 113 | MB48 | 77 | MCT16 | 170 |
| LB18 | 94 | M5304 | 156 | M7371R | 113 | MB48B | 77 | MCT28 | 170 |
| LB36 | 78 | M5403 | 156 | M7372 | 113 | MB48R | 77 | MCT29 | 170 |
| LB48 | 78 | M5403SS | 156 | M7373RELB | 112 | MB48RB | 77 | MCT29A | 170 |
| LB60 | 78 | M5404 | 156 | M7403 | 157 | MB48RR | 77 | MCT42A | 170 |
| LF48 | 78 | M5503 | 156 | M7405 | 157 | MB54 | 77 | MCT54 | 170 |
| LGSTFAN | 120 | M5603 | 156 | M7407 | 112 | MB54B | 77 | MCT63 | 170 |
| LGSTFANF | 120 | M5721 | 156 | M7408 | 112 | MB54R | 77 | MCT67 | 170 |
| LL945 | 192 | M5721DP | 156 | M7410 | 112 | MB54RB | 77 | MCT72 | 170 |
| LS24 | 27 | M5721SS | 156 | M7411 | 112 | MB60 | 77 | MCTA41 | 170 |
| LS46 | 27 | M5734 | 156 | M7413 | 112 | MB60B | 77 | MCTA107 | 170 |
| LS68 | 27 | M5743 | 156 | M7414 | 112 | MB60R | 77 | MCTR2 | 165 |
| LS085 | 184 | M5743SS | 156 | M7416 | 112 | MB60RB | 77 | MCTRR1 | 165 |
| LS086 | 184 | M5753 | 156 | M7417 | 112 | MB72 | 77 | MEBH | 168 |
| LS087 | 184 | M5753SS | 156 | M7503 | 157 | MB72B | 77 | MF54 | 212 |
| LS088 | 184 | M5763 | 156 | M7505 | 157 | MB72R | 77 | MF380R | 69 |
| LS810 | 27 | M5763SS | 156 | M7536 | 113 | MB72RB | 77 | MFFB7 | 170 |
| LS812 | 27 | M5863 | 156 | M7544 | 113 | MBF | 169 | MFFB7A | 170 |
| LSF94 | 213 | M5864 | 156 | M7603 | 157 | MBS22 | 22 | MFFB97 | 170 |
| LWRBLD12 | 217 | M6092 | 113 | M7636 | 113 | MBS22RB | 22 | MFFB98 | 170 |
| LWRBLD18 | 217 | M6092ELB | 112 | M7644 | 113 | MC24R | 80 | MFFB910 | 170 |
| M2CF | 167 | M6092ELG | 112 | M7710 | 117 | MC24RAA | 80 | MFFB912 | 170 |
| M2NS | 169 | M6093 | 113 | M11502 | 18 | MC24RPBA | 80 | MFFBA6 | 167 |
| M3BBH | 168 | M6093ELB | 112 | M23017 | 94 | MC24RRL | 80 | MFFBR17 | 167 |
| M3BH | 168 | M6093ELG | 112 | M23043 | 94 | MC24RTA | 80 | MFFBR18 | 167 |
| M3CF | 167 | M6094 | 113 | M23044 | 94 | MC30 | 80 | MFFBR27 | 167 |
| M3CFW | 167 | M6094ELB | 112 | MABLACK | 119 | MC30AA | 80 | MFFBR28 | 167 |
| M3NS | 169 | M6094ELG | 112 | MABLACKF | 119 | MC30PBA | 80 | MFFBR110 | 167 |
| M4BBH | 168 | M6095 | 113 | MABLUE | 119 | MC30R | 80 | MFFBR112 | 167 |
| M4BH | 168 | M6095ELB | 112 | MABLUEF | 119 | MC30RAA | 80 | MFFBR210 | 167 |
| M5BBH | 168 | M6095ELG | 112 | MACIR5 | 120 | MC30RL | 80 | MFFBR212 | 167 |
| M5BH | 168 | M6096 | 113 | MACIR10 | 120 | MC30RPBA | 80 | MGC599 | 217 |
| M6BBH | 168 | M6219 | 113 | MACIR15 | 120 | MC30RRL | 80 | MGC599SW | 217 |
| M6BH | 168 | M7071 | 157 | MACOBB | 120 | MC30RTA | 80 | MGF241 | 82 |
| M7CFB | 168 | M7073 | 157 | MACOBBF | 120 | MC30TA | 80 | MGF361 | 82 |
| M7FFB | 167 | M7081 | 157 | MAGREEN | 119 | MC36R | 80 | MGF481 | 82 |
| M8CFB | 168 | M7123 | 157 | MAGREENF | 119 | MC36RAA | 80 | MGF2415 | 82 |

Marshalltown Part Number Listing

| PART NO. | PAGE NO. | PART NO. | PAGE NO. | PART NO. | PAGE NO. | PART NO. | PAGE NO. | PART NO. | PAGE NO. |
|--------------|----------|-----------|----------|----------|----------|----------|----------|-----------|----------|
| MGF2475 | 82 | MIX61115 | 33 | MP657 | 161 | MXS2D | 41 | MXS62SSD | 43 |
| MGF3615 | 82 | MIX62000 | 32 | MPT105D | 45 | MXS2GS | 43 | MXS64 | 42 |
| MGF3675 | 82 | MIX62001 | 32 | MR1004 | 226 | MXS2SS | 43 | MXS64B | 44 |
| MGF4815 | 82 | MIX62002 | 32 | MR1006 | 226 | MXS2SSD | 43 | MXS64BD | 44 |
| MGF4875 | 82 | MIX62003 | 33 | MR10063 | 226 | MXS3 | 42 | MXS64BFR | 45 |
| MGN | 169 | MIX62004 | 33 | MRF94 | 177,213 | MXS3D | 41 | MXS64BRD | 45 |
| MHAV4 | 105 | MIX62005 | 33 | MS225BRD | 45 | MXS3GS | 43 | MXS64D | 41 |
| MHAV25 | 105 | MIX62006 | 34 | MS245BRD | 45 | MXS3GSD | 43 | MXS64FR | 45 |
| MHF3 | 106 | MIX62006B | 34 | MSF9 | 177 | MXS3SS | 43 | MXS64FRD | 45 |
| MHF4 | 106 | MIX62011 | 33 | MSH34 | 107 | MXS3SSD | 43 | MXS64GS | 43 |
| MHF25 | 106 | MIX69000 | 32 | MSNP34 | 107 | MXS4 | 42 | MXS64GSD | 43 |
| MHM3 | 105 | MIX69002 | 32 | MSNP78 | 107 | MXS4D | 41 | MXS64RE | 44 |
| MHMP | 169 | MIX69125 | 32 | MSP34 | 107 | MXS4GS | 43 | MXS64RED | 44 |
| MHNSA2 | 169 | MIX69204 | 32 | MSP78 | 107 | MXS4GSD | 43 | MXS64SS | 43 |
| MHNSA3 | 169 | MIX245007 | 33 | MST16 | 28,239 | MXS4SS | 43 | MXS64SSD | 43 |
| MHW2 | 106 | MIX245881 | 35 | MSW3 | 216 | MXS4SSD | 43 | MXS65 | 42 |
| MHW3 | 106 | ML338 | 25 | MT04 | 171 | MXS7 | 42 | MXS65D | 41 |
| MHW4 | 106 | ML339 | 25 | MT05 | 171 | MXS7D | 41 | MXS66 | 42 |
| MIC | 252 | ML340 | 25 | MT06 | 171 | MXS7GS | 43 | MXS66B | 44 |
| MICROCGRAY | 138 | ML341 | 25 | MT07 | 171 | MXS7GSD | 43 | MXS66BD | 44 |
| MICROCWHY | 138 | ML566 | 26 | MT72 | 171 | MXS11SS | 151 | MXS66BFR | 45 |
| MICROPOLY5 | 138 | ML567 | 26 | MTAPER | 165 | MXS11SSD | 151 | MXS66BRD | 45 |
| MIX771-40257 | 33 | ML569 | 26 | MTP52 | 11 | MXS13 | 42 | MXS66D | 41 |
| MIX27070 | 32 | ML570 | 26 | MTSG52 | 11 | MXS13D | 41 | MXS66FR | 45 |
| MIX27071 | 33 | ML571 | 26 | MTSG52SS | 11 | MXS13GS | 43 | MXS66FRD | 45 |
| MIX27254 | 32 | ML577 | 26 | MTSG62 | 11 | MXS13GSD | 43 | MXS66GS | 43 |
| MIX59000D | 38 | ML578 | 26 | MTSG82 | 11 | MXS13SS | 43 | MXS66GSD | 43 |
| MIX59015C | 32 | ML579 | 26 | MTSG515 | 11 | MXS13SSD | 43 | MXS66RE | 44 |
| MIX59016A | 33 | ML581 | 26 | MX1 | 42 | MXS20 | 42 | MXS66RED | 44 |
| MIX59289 | 34 | ML582 | 26 | MX1D | 41 | MXS20B | 44 | MXS66SS | 43 |
| MIX59289B | 34 | ML583 | 26 | MX2 | 42 | MXS20BD | 44 | MXS66SSD | 43 |
| MIX59292 | 34 | ML584 | 26 | MX4 | 42 | MXS20BFR | 45 | MXS67 | 42 |
| MIX59292B | 34 | ML585 | 26 | MX20 | 42 | MXS20BRD | 45 | MXS67D | 41 |
| MIX59309AB | 36 | ML587 | 26 | MX54 | 42 | MXS20D | 41 | MXS67GS | 43 |
| MIX59312A | 36 | ML588 | 26 | MX55 | 42 | MXS20FR | 45 | MXS67GSD | 43 |
| MIX59312AB | 36 | ML589 | 26 | MX56 | 42 | MXS20FRD | 45 | MXS68 | 42 |
| MIX59328 | 36 | ML590 | 26 | MX57 | 42 | MXS20RE | 44 | MXS68D | 41 |
| MIX59328B | 36 | ML591 | 25 | MX57D | 41 | MXS20RED | 44 | MXS73 | 42 |
| MIX59334 | 36 | ML592 | 25 | MX58 | 42 | MXS22 | 42 | MXS73D | 41 |
| MIX59334B | 36 | ML598 | 25 | MX60 | 42 | MXS22BRD | 45 | MXS73GS | 43 |
| MIX59353 | 37 | ML599 | 25 | MX61 | 42 | MXS24 | 42 | MXS73GSD | 43 |
| MIX59353B | 37 | ML601 | 25 | MX62 | 42 | MXS24BRD | 45 | MXS73SS | 43 |
| MIX59358 | 37 | ML602 | 25 | MX62D | 41 | MXS24D | 41 | MXS73SSD | 43 |
| MIX59358B | 37 | ML603 | 25 | MX64 | 42 | MXS25BRD | 45 | MXS75 | 42 |
| MIX59359 | 37 | ML604 | 25 | MX64D | 41 | MXS25SSD | 43 | MXS75BFR | 45 |
| MIX59359B | 37 | ML605 | 25 | MX65 | 42 | MXS54 | 42 | MXS75BFRD | 45 |
| MIX59362 | 37 | ML606 | 25 | MX66 | 42 | MXS54D | 41 | MXS75D | 41 |
| MIX59362B | 37 | ML607 | 25 | MX66D | 41 | MXS55 | 42 | MXS75FR | 45 |
| MIX59387 | 37 | ML609 | 25 | MX67 | 42 | MXS55D | 41 | MXS75FRD | 45 |
| MIX59387B | 37 | ML610 | 25 | MX68 | 42 | MXS56 | 42 | MXS76 | 42 |
| MIX59388 | 37 | ML611 | 25 | MX73 | 42 | MXS56B | 44 | MXS76D | 41 |
| MIX59388B | 37 | ML612 | 25 | MX75 | 42 | MXS56BD | 44 | MXS77 | 42 |
| MIX59389 | 37 | ML613 | 26 | MX76 | 42 | MXS56D | 41 | MXS77D | 41 |
| MIX59389B | 37 | ML614 | 26 | MX77 | 42 | MXS57 | 42 | MXS81 | 42 |
| MIX59390 | 37 | ML615 | 26 | MX81 | 42 | MXS57B | 44 | MXS81B | 44 |
| MIX59390B | 37 | ML616 | 26 | MX81D | 41 | MXS57BD | 44 | MXS81BD | 44 |
| MIX59398 | 35 | ML617 | 26 | MX82 | 42 | MXS57D | 41 | MXS81BFR | 45 |
| MIX59398B | 35 | ML618 | 26 | MX114 | 42 | MXS58 | 42 | MXS81BRD | 45 |
| MIX59402 | 35 | MM662 | 165 | MX205 | 42 | MXS58D | 41 | MXS81D | 41 |
| MIX59402B | 35 | MMP33 | 170 | MX47011P | 216 | MXS60 | 42 | MXS81FR | 45 |
| MIX59405 | 35 | MMPR1 | 169 | MX47014D | 216 | MXS60D | 41 | MXS81FRD | 45 |
| MIX59405B | 35 | MNP09 | 107 | MX47021 | 216 | MXS61 | 42 | MXS81GS | 43 |
| MIX59980 | 32 | MNS72 | 170 | MX47025 | 216 | MXS61D | 41 | MXS81GSD | 43 |
| MIX59981 | 32 | MNS73 | 170 | MXS1 | 42 | MXS62 | 42 | MXS81RE | 44 |
| MIX59990 | 33 | MNS152 | 170 | MXS1D | 41 | MXS62B | 44 | MXS81RED | 44 |
| MIX61110 | 32 | MNS153 | 170 | MXS1GS | 43 | MXS62BD | 44 | MXS82 | 42 |
| MIX61111 | 32 | MP4 | 217 | MXS1GSD | 43 | MXS62D | 41 | MXS82D | 41 |
| MIX61112 | 32 | MP228 | 171 | MXS1SS | 43 | MXS62GS | 43 | MXS91 | 42 |
| MIX61113 | 33 | MP294 | 161 | MXS1SSD | 43 | MXS62GSD | 43 | MXS91AD | 230 |
| MIX61114 | 33 | MP656 | 161 | MXS2 | 42 | MXS62SS | 43 | MXS91D | 41 |

Marshalltown Part Number Listing

| PART NO. | PAGE NO. | PART NO. | PAGE NO. | PART NO. | PAGE NO. | PART NO. | PAGE NO. | PART NO. | PAGE NO. |
|-----------|----------|-----------|----------|-----------|----------|---------------|----------|-----------|----------|
| MXS91GS | 43 | MXS875SSD | 151 | NT995 | 210 | PABSCF | 121 | PB144 | 83 |
| MXS91GSD | 43 | NB201 | 246 | NT996 | 210 | PAF377 | 179 | PB144L | 83 |
| MXS91SS | 43 | NB202 | 246 | NT997 | 210 | PAHBRK | 122 | PB145D | 39 |
| MXS91SSD | 43 | NB203 | 246 | NT998 | 210 | PAHBRKF | 122 | PB145GSD | 39 |
| MXS114 | 42 | NBRT18 | 122 | NT999 | 210 | PAN24-4CE | 109 | PB165D | 39 |
| MXS114D | 41 | NBSC | 121 | OAKLEAF | 124 | PAN24-4CE-P | 109 | PB165GSD | 39 |
| MXS145 | 42 | NBSCCOR | 121 | OAKLFCLUS | 124 | PAN36-4C | 109 | PB192 | 83 |
| MXS145B | 44 | NBSCF | 121 | OS751 | 159 | PAN36-4CE | 109 | PB192L | 83 |
| MXS145BD | 44 | NGPCS | 220 | OSBLACK | 121 | PAN36-4CE-P | 109 | PB205D | 39 |
| MXS145D | 41 | NONSKID | 138 | OSBLACKF | 121 | PAN36-4C-P | 109 | PB815D | 39 |
| MXS145GD | 43 | NT669 | 209 | OSBLUE | 121 | PAN36SC-4C | 110 | PBI | 83 |
| MXS145GS | 43 | NT670 | 209 | OSBLUEF | 121 | PAN36SC-4CE | 110 | PBI72 | 83 |
| MXS165 | 42 | NT671 | 209 | OSCCOR | 121 | PAN36SC-4CE-P | 110 | PBI96 | 83 |
| MXS165B | 44 | NT672 | 209 | OSGREEN | 121 | PAN36SC-4C-P | 110 | PBI120 | 83 |
| MXS165BD | 44 | NT673 | 209 | OSGREENF | 121 | PAN42-4C | 109 | PBI144 | 83 |
| MXS165D | 41 | NT674 | 209 | P1 | 193 | PAN42-4C-P | 109 | PC299 | 188 |
| MXS165GD | 43 | NT675 | 209 | P1ST | 193 | PAN42SC-4C | 110 | PCS | 220 |
| MXS165GS | 43 | NT676 | 209 | P2 | 193 | PAN42SC-4C-P | 110 | PEBBLE18 | 124 |
| MXS165SD | 43 | NT677 | 209 | P3 | 193 | PAN44-4C | 109 | PEBBLE24 | 124 |
| MXS205 | 42 | NT678 | 209 | P4 | 193 | PAN44-4C-P | 109 | PEBBLE36 | 124 |
| MXS205B | 44 | NT679 | 209 | P6 | 193 | PAN44-5C | 109 | PEBBLE48 | 124 |
| MXS205BD | 44 | NT680 | 209 | P7 | 193 | PAN44-5C-P | 109 | PK440F | 158 |
| MXS205BR | 45 | NT681 | 209 | P8 | 193 | PAN44SC-4C | 110 | PK441S | 158 |
| MXS205D | 41 | NT682 | 209 | P9 | 193 | PAN44SC-4C-P | 110 | PK740S | 158 |
| MXS205FD | 45 | NT683 | 209 | P10 | 193 | PAN44SC-5C | 110 | PK741F | 158 |
| MXS205FR | 45 | NT684 | 209 | P11 | 193 | PAN44SC-5C-P | 110 | PK742S | 158 |
| MXS205GD | 43 | NT685 | 209 | P12 | 193 | PAN45-5C | 109 | PK743F | 158 |
| MXS205GS | 43 | NT686 | 209 | P13 | 193 | PAN45-5C-P | 109 | PK764SSD | 155 |
| MXS205RD | 44 | NT687 | 209 | P14 | 193 | PAN45SC-5C | 110 | PK860D | 155 |
| MXS205RE | 44 | NT688 | 209 | P15 | 193 | PAN45SC-5C-P | 110 | PK863D | 155 |
| MXS205SS | 43 | NT689 | 209 | P16 | 193 | PAN46-4C | 109 | PK865D | 155 |
| MXS224B | 44 | NT690 | 209 | P17 | 193 | PAN46-4C-P | 109 | PK866D | 155 |
| MXS224BD | 44 | NT691 | 209 | P18 | 193 | PAN46-5C | 109 | PK876D | 155 |
| MXS224BR | 45 | NT692 | 209 | P20 | 193 | PAN46-5C-P | 109 | PK877D | 155 |
| MXS224FD | 45 | NT693 | 209 | P21 | 193 | PAN46SC-4C | 110 | PK878D | 155 |
| MXS224FR | 45 | NT694 | 209 | P22 | 193 | PAN46SC-4C-P | 110 | PK888D | 155 |
| MXS224RD | 44 | NT695 | 209 | P23-18ST | 193 | PAN46SC-5C | 110 | PL11C | 194 |
| MXS224RE | 44 | NT696 | 209 | P23-24ST | 193 | PAN46SC-5C-P | 110 | PL589 | 172 |
| MXS225 | 42 | NT697 | 209 | P24ST | 193 | PAN60-6C | 109 | PL589-5 | 172 |
| MXS225BR | 45 | NT698 | 209 | P26 | 193 | PAN60-6C-P | 109 | PLBLACKLG | 131 |
| MXS225D | 41 | NT699 | 209 | P26B | 193 | PAN60SC-6C | 110 | PLBLACKSM | 131 |
| MXS225FD | 45 | NT745 | 209 | P27 | 193 | PAN60SC-6C-P | 110 | PLBLUESGL | 131 |
| MXS225FR | 45 | NT746 | 209 | P28 | 193 | PAN62-5C | 109 | PLBLUESM | 131 |
| MXS225RD | 44 | NT747 | 209 | P29 | 193 | PAN62-5C-P | 109 | PLGREENLG | 131 |
| MXS225RE | 44 | NT748 | 209 | P30 | 193 | PAN62-6C | 109 | PLGREENSM | 131 |
| MXS244B | 44 | NT793 | 209 | P31 | 193 | PAN62-6C-P | 109 | PLREDLG | 131 |
| MXS244BD | 44 | NT794 | 209 | P32 | 193 | PAN62SC-5C | 110 | PLUG | 21 |
| MXS244BR | 45 | NT803 | 209 | P35 | 193 | PAN62SC-5C-P | 110 | PLUGSG | 20 |
| MXS244FD | 45 | NT805 | 209 | P37 | 193 | PAN62SC-6C | 110 | PM798 | 164 |
| MXS244FR | 45 | NT811 | 209 | P42 | 193 | PAN62SC-6C-P | 110 | PM6092R | 110 |
| MXS244RD | 44 | NT813 | 209 | P44 | 193 | PASCCOR | 121 | PM6092W | 110 |
| MXS244RE | 44 | NT815 | 209 | P45 | 193 | PB1GSD | 39 | PM6094R | 110 |
| MXS245 | 42 | NT970 | 209 | P46 | 193 | PB4GSD | 39 | PM6094W | 110 |
| MXS245B | 44 | NT971 | 209 | P47-18ST | 193 | PB7GSD | 39 | PMAOAK | 134 |
| MXS245BD | 44 | NT972 | 209 | P47-24ST | 193 | PB012 | 223 | PMBRKR | 134 |
| MXS245BR | 45 | NT973 | 209 | P48 | 193 | PB13GSD | 39 | PMCHAR | 134 |
| MXS245D | 41 | NT974 | 209 | P49 | 193 | PB20D | 39 | PMCORB | 134 |
| MXS245FD | 45 | NT975 | 209 | P50L18ST | 193 | PB48 | 83 | PMCSAGE | 134 |
| MXS245FR | 45 | NT976 | 209 | P50L24ST | 193 | PB48L | 83 | PMDCHAR | 134 |
| MXS245RD | 44 | NT980 | 210 | P50R18ST | 193 | PB56D | 39 | PMDROSE | 134 |
| MXS245RE | 44 | NT981 | 209 | P50R24ST | 193 | PB57D | 39 | PMGCLAY | 134 |
| MXS815 | 42 | NT982 | 210 | P51-18 | 193 | PB62D | 39 | PMGGRAY | 134 |
| MXS815B | 44 | NT983 | 210 | P51-24 | 193 | PB64D | 39 | PMHRED | 134 |
| MXS815BD | 44 | NT984 | 210 | P200 | 21 | PB66D | 39 | PMHWHEAT | 134 |
| MXS815D | 41 | NT985 | 210 | P200SG | 20 | PB72 | 83 | PMLANST | 134 |
| MXS815FR | 45 | NT986 | 210 | P212 | 21 | PB72L | 83 | PMMBROWN | 134 |
| MXS815FRD | 45 | NT991 | 210 | P300 | 21 | PB81D | 39 | PMMILLST | 134 |
| MXS815GD | 43 | NT992 | 210 | PABRK | 122 | PB96 | 83 | PMPEWTER | 134 |
| MXS815GS | 43 | NT993 | 210 | PABRK | 122 | PB96L | 83 | PMSANDST | 134 |
| MXS875SS | 151 | NT994 | 210 | PABSC | 121 | PB120L | 83 | PMSBEIGE | 134 |

Marshalltown Part Number Listing

| PART NO. | PAGE NO. | PART NO. | PAGE NO. | PART NO. | PAGE NO. | PART NO. | PAGE NO. | PART NO. | PAGE NO. |
|-----------|----------|-------------|----------|--------------|----------|------------|----------|------------|-------------|
| PMSFBUFF | 134 | PVCRT4 | 104 | RED700092 | 143 | RED700519 | 223 | RED701154 | 74 |
| PMSIENNA | 134 | PVCRT5 | 104 | RED700093 | 143 | RED700520 | 91 | RED701154K | 74 |
| PMSMGRAY | 134 | PVCRT7 | 104 | RED700094 | 143 | RED700521 | 91 | RED701155 | 74 |
| PMSMOKE | 134 | PVCRT9 | 104 | RED700094C | 142 | RED700522 | 83 | RED701155K | 74 |
| PMSSLATE | 134 | PVCRT10 | 104 | RED700095C | 142 | RED700524 | 83 | RED701156 | 74 |
| PMSTAN | 134 | PVCRT12 | 104 | RED700096 | 143 | RED700524M | 83 | RED701156K | 74 |
| PMTCOTTA | 134 | R79 | 227 | RED700096C | 142 | RED700546 | 144 | RED701157 | 74 |
| PMT280 | 11 | R657 | 201 | RED700097C | 142 | RED700547 | 144 | RED701157K | 74 |
| PMXS1 | 48 | RABUFF | 137 | RED700098 | 143 | RED700548 | 144 | RED701158 | 74 |
| PMXS1D | 48 | RAKE16F | 242 | RED700099 | 143 | RED700549 | 144 | RED701158K | 74 |
| PNS14V | 211 | RB24 | 78 | RED700100 | 143 | RED700550 | 144 | RED701159 | 74 |
| PNS18V | 211 | RB24R | 78 | RED700101 | 143 | RED700551 | 144 | RED701159K | 74 |
| PNS116S | 211 | RB36 | 78 | RED700102 | 143 | RED700561 | 91 | RED701160 | 74 |
| PNS316V | 211 | RB36R | 78 | RED700103 | 143 | RED700567 | 90 | RED701160K | 74 |
| PNS332V | 211 | RB42 | 78 | RED700104 | 143 | RED700658 | 76 | RED701161 | 74 |
| PNT666 | 210 | RB42R | 78 | RED700104C | 142 | RED700659 | 76 | RED701161K | 74 |
| PNT667 | 210 | RB48 | 78 | RED700105 | 143 | RED700660 | 76 | RED701162 | 74 |
| PPACS | 220 | RB48R | 78 | RED700105C | 142 | RED700661 | 76 | RED701162K | 74 |
| PPT282 | 11 | RB192 | 22,117 | RED700106C | 142 | RED700755 | 87 | RED701163 | 74 |
| PR15 | 23 | RB194 | 22,117 | RED700107C | 142 | RED700778 | 99 | RED701163K | 74 |
| PR75 | 23 | RB670 | 221 | RED700108 | 143 | RED700779 | 99 | RED701164 | 74 |
| PS1S2 | 198 | RB798 | 170 | RED700109 | 143 | RED700780 | 99 | RED701164K | 74 |
| PS1SRB | 198 | RB799 | 170 | RED700110 | 143 | RED700781 | 99 | RED701165 | 74 |
| PS1W1 | 198 | RB851 | 16 | RED700111 | 143 | RED700782 | 99 | RED701165K | 74 |
| PS1WRB | 198 | RB852 | 16 | RED700112 | 143 | RED700783 | 99 | RED701166 | 74 |
| PS3S4 | 198 | RB853 | 16 | RED700113 | 143 | RED700784 | 99 | RED701166K | 74 |
| PS3S4RB | 198 | RB854 | 16 | RED700152 | 90 | RED700786 | 99 | RED701167 | 74 |
| PS112S2 | 198 | RB6025 | 171 | RED700153 | 90 | RED700787 | 99 | RED701167K | 74 |
| PS112SRB | 198 | RB9041 | 218 | RED700156 | 90 | RED700788 | 99 | RED701168 | 74 |
| PS112W2 | 198 | RBONE | 137 | RED700157 | 90 | RED700855 | 223 | RED701168K | 74 |
| PS112WRB | 198 | RBRKRD | 137 | RED700158 | 90 | RED700856 | 223 | RED701169 | 74 |
| PS212S2 | 198 | RCB63 | 103 | RED700200A | 89 | RED700863 | 83 | RED701169K | 74 |
| PS212S2RB | 198 | RCB63RH | 103 | RED700221 | 147 | RED700916 | 144 | RED701170 | 72 |
| PS212S4 | 198 | RCCGRAY | 137 | RED700227 | 71 | RED700916S | 144 | RED701172 | 72 |
| PS212S4RB | 198 | RCLEAR | 137 | RED700228 | 71 | RED700928 | 90 | RED701172K | 72 |
| PS212W2 | 198 | RCTAN | 137 | RED700229 | 71 | RED700983 | 142 | RED701173 | 72 |
| PS212WRB | 198 | RDCHAR | 137 | RED700232 | 141 | RED700984 | 142 | RED701173K | 72 |
| PS660 | 181 | RED804KR2 | 148 | RED700232-84 | 141 | RED700985 | 142 | RED701174 | 72 |
| PS660A | 181 | RED8011G113 | 240 | RED700244 | 144 | RED700986 | 142 | RED701174K | 72 |
| PSB48 | 76 | RED8011G122 | 240 | RED700245 | 144 | RED700987 | 142 | RED701175 | 72 |
| PSB48FR | 76 | RED8011G123 | 240 | RED700246 | 144 | RED700989 | 142 | RED701175K | 72 |
| PSH753 | 181 | RED700012 | 75 | RED700247 | 144 | RED700990 | 90 | RED701182 | 72 |
| PSH753L | 181 | RED700013 | 75 | RED700248 | 144 | RED700993 | 145 | RED701182K | 72 |
| PSP10 | 48 | RED700014 | 75 | RED700249 | 144 | RED700993R | 145 | RED701183 | 72 |
| PSP10SD | 48 | RED700026 | 143 | RED700254 | 145 | RED700994 | 145 | RED701183K | 72 |
| PSP12 | 48 | RED700026C | 142 | RED700255 | 145 | RED700994R | 145 | RED701184 | 72 |
| PSP12SD | 48 | RED700027 | 143 | RED700256 | 145 | RED700996 | 146 | RED701184K | 72 |
| PSP14 | 48 | RED700027C | 142 | RED700257 | 145 | RED701037 | 75 | RED701190 | 72 |
| PSP14SD | 48 | RED700028 | 143 | RED700289 | 142 | RED701038 | 75 | RED701190K | 72 |
| PSP81 | 48 | RED700028C | 142 | RED700290 | 142 | RED701039 | 75 | RED701437 | 96 |
| PSP81SD | 48 | RED700029 | 143 | RED700291 | 142 | RED701040 | 75 | RED702032 | 142,143,144 |
| PSP164 | 48 | RED700029C | 142 | RED700292 | 142 | RED701041 | 75 | RED702033 | 142,143,144 |
| PSP164SD | 48 | RED700030 | 143 | RED700293 | 142 | RED701043 | 144 | RED702034 | 142,143,144 |
| PT76 | 171 | RED700030C | 142 | RED700294 | 142 | RED701048 | 141 | RED702035 | 142,143,144 |
| PT144B | 51 | RED700031 | 143 | RED700344 | 83 | RED701051 | 142 | RED702036 | 142,143,144 |
| PT144BR | 51 | RED700031C | 142 | RED700344M | 83 | RED701065 | 143 | RED702037 | 142,143,144 |
| PT164B | 51 | RED700064 | 75 | RED700346 | 148 | RED701066 | 143 | RED702366 | 141 |
| PT164BR | 51 | RED700065 | 75 | RED700347 | 148 | RED701068 | 143 | RED704041 | 147 |
| PT185B | 51 | RED700066 | 75 | RED700372 | 146 | RED701069 | 143 | RED704123 | 146,147 |
| PT185BR | 51 | RED700081 | 143 | RED700373 | 146 | RED701070 | 143 | RED704124 | 147 |
| PT205B | 51 | RED700081C | 142 | RED700376 | 146 | RED701079 | 142 | RED704126 | 147 |
| PT205BR | 51 | RED700082C | 142 | RED700397 | 251 | RED701080 | 142 | RED704127 | 147 |
| PT446 | 158 | RED700083 | 143 | RED700448 | 96 | RED701081 | 142 | RED704128 | 147 |
| PT747 | 158 | RED700083C | 142 | RED700505 | 91 | RED701144 | 143,144 | RED704130 | 147 |
| PTP73 | 10 | RED700084 | 143 | RED700506 | 223 | RED701151 | 74 | RED704133 | 146 |
| PTP525 | 10 | RED700084C | 142 | RED700513 | 97 | RED701151K | 74 | RED704138 | 148 |
| PTSG73 | 10 | RED700088 | 143 | RED700514 | 97 | RED701152 | 74 | RED704139 | 148 |
| PTSG525 | 10 | RED700089 | 143 | RED700515 | 97 | RED701152K | 74 | RED704152 | 146 |
| PTSG6275 | 10 | RED700090 | 143 | RED700516 | 97 | RED701153 | 74 | RED704204 | 75 |
| PTT668 | 231 | RED700091 | 143 | RED700518 | 223 | RED701153K | 74 | RED704210 | 147 |

Marshalltown Part Number Listing

| PART NO. | PAGE NO. | PART NO. | PAGE NO. | PART NO. | PAGE NO. | PART NO. | PAGE NO. | PART NO. | PAGE NO. |
|--------------|----------|-------------|----------|-------------|----------|------------|----------|----------|----------|
| RED704240 | 144 | RED705050 | 86 | RED806012FG | 241 | RL6 | 85 | SG14916 | 220 |
| RED704241 | 147 | RED705050W | 86 | RED806013FG | 241 | RL6C | 85 | SGC | 249 |
| RED704262 | 99 | RED705101 | 99 | RED807009D | 241 | RL801 | 172 | SGCE | 249 |
| RED704335 | 91 | RED705102 | 99 | RED8015101 | 240 | RM435 | 176 | SGDS32 | 173 |
| RED704405 | 85 | RED705109 | 99 | RED8043768 | 103 | RM771 | 164 | SK867D | 155 |
| RED704406 | 85 | RED705110 | 99 | RED8043860 | 103 | RM772 | 164 | SK879D | 155 |
| RED704408 | 85 | RED705111 | 99 | RED8043872 | 103 | RM773 | 164 | SK880D | 155 |
| RED704432 | 88 | RED714193 | 146 | RED8043960 | 103 | RR214 | 233 | SK880SSD | 155 |
| RED704531 | 99 | RED714195 | 145 | RED901000 | 142 | RR414 | 233 | SK881D | 155 |
| RED704532 | 75 | RED714196 | 145 | RED901001 | 142 | RR614 | 233 | SK882D | 155 |
| RED704559 | 103 | RED714197 | 141 | RED901002 | 142 | RR814 | 233 | SK882SSD | 155 |
| RED704560 | 103 | RED750114 | 96 | RED901003 | 142 | RRF94C | 178 | SK890D | 155 |
| RED704661 | 83 | RED790175 | 99 | RED901004 | 142 | RRF94F | 178 | SKY2115 | 192 |
| RED704842 | 90 | RED790276 | 83 | RED901005 | 142 | RRF124F | 178 | SKY2118 | 192 |
| RED704857 | 103 | RED790324 | 99 | RED901006 | 142 | RRFW94F | 178 | SKY2124 | 192 |
| RED704858 | 103 | RED790325 | 99 | RED901007 | 142 | RRUSSET | 137 | SL1 | 14 |
| RED704870 | 243 | RED790326 | 99 | RED901008 | 142 | RS52 | 193 | SL12 | 14 |
| RED704873 | 99 | RED801001 | 240 | RED901009 | 142 | RS64 | 193 | SL14 | 14 |
| RED704874 | 99 | RED801004 | 240 | RED901010 | 142 | RSLTGRY | 137 | SL34 | 14 |
| RED704875 | 99 | RED801008 | 240 | RED901011 | 142 | RSMOKE | 137 | SL38 | 14 |
| RED704876 | 99 | RED801009 | 240 | RED901012 | 142 | RSTGRAY | 137 | SL58 | 14 |
| RED704911 | 243 | RED801011 | 240 | RED901013 | 142 | RT693 | 17 | SL78 | 14 |
| RED704916 | 145 | RED801114 | 240 | RED901014 | 142 | RV569 | 188 | SL316 | 14 |
| RED704926 | 144 | RED8011G113 | 240 | RED901015 | 142 | RW426 | 173 | SLATE6 | 119 |
| RED704927 | 144 | RED8011G122 | 240 | REDK2 | 86 | RW426-5 | 173 | SLATE6F | 119 |
| RED704928 | 144 | RED8011G123 | 240 | REDRR01SC | 128 | RWALNUT | 137 | SLATE12 | 119 |
| RED704932 | 144 | RED801300 | 241 | REDRR02TS | 128 | RWG5 | 227 | SLATE12F | 119 |
| RED704933 | 144 | RED801400 | 241 | REDRR03DS | 128 | RWG6 | 227 | SLRCLEAR | 137 |
| RED704934 | 144 | RED801500 | 241 | REDRR04DC | 128 | RWHEAT | 137 | SLW66 | 26 |
| RED704935 | 145 | RED801600 | 241 | REDRR100 | 126,127 | S112 | 21 | SLW66FO | 26 |
| RED704936 | 145 | RED802060A | 242 | REDRR100W | 127 | S200 | 21 | SLW66FY | 26 |
| RED704937 | 145 | RED802060FG | 242 | REDRR105 | 126,127 | S200SG | 20 | SMH3 | 19 |
| RED704938 | 145 | RED802254A | 243 | REDRR110 | 127 | SA45 | 193 | SMH4 | 19 |
| RED704939 | 145 | RED802404 | 241 | REDRR115 | 127 | SALTEX18 | 123 | SMH6 | 19 |
| RED704940 | 145 | RED802504 | 241 | REDRR120 | 126 | SALTEX48 | 123 | SP10 | 50 |
| RED704942 | 146 | RED802505 | 241 | REDRR125 | 126 | SASLFLCLUS | 124 | SP10B | 50 |
| RED704942-01 | 146 | RED802506 | 241 | REDRR130 | 126 | SB561 | 215 | SP10BD | 50 |
| RED704943 | 146 | RED802507 | 241 | REDRR135 | 126 | SBT49 | 22 | SP10BR3 | 48 |
| RED704953 | 145 | RED802900 | 147 | REDRR140 | 126 | SC3HH | 157 | SP10GS | 51 |
| RED704954 | 145 | RED802910P | 223,242 | REDRR145 | 126 | SC68 | 218 | SP10GSD | 51 |
| RED704955 | 145 | RED802911A | 223,242 | REDRR150 | 126 | SC68RB | 218 | SP10P | 49 |
| RED704956 | 145 | RED802912 | 223,242 | REDRR155 | 126 | SC412 | 198,221 | SP10PD | 49 |
| RED704959 | 146 | RED802920 | 242 | REDRR160 | 127 | SC418 | 198,221 | SP10PR3 | 49 |
| RED704964 | 146 | RED802921 | 147 | REDRR160RS | 127 | SC448 | 198,221 | SP10SD | 50 |
| RED704965 | 146 | RED803006FG | 105 | REDRR165 | 126 | SC929 | 192 | SP10SS | 51 |
| RED704966 | 146 | RED803008FG | 105 | REDRR170 | 127 | SCBLADE | 198,221 | SP10SSD | 51 |
| RED704969 | 146 | RED803012FG | 105 | REDRR194 | 128 | SCPK114 | 157 | SP10SSR3 | 49 |
| RED704973 | 140 | RED803016FG | 105 | REDRR195 | 128 | SCPK114HH | 157 | SP12 | 50 |
| RED704974 | 140 | RED803020FG | 105 | REDRR196 | 128 | SD6SG | 237 | SP12B | 50 |
| RED704975 | 140 | RED803321F | 243 | REDRR197 | 128 | SD6SGDP | 237 | SP12BD | 50 |
| RED704976 | 140 | RED803321FG | 243 | REDRR199 | 128 | SDGISP36 | 249 | SP12BR3 | 48 |
| RED704977 | 140 | RED803421F | 243 | REDRR300TX | 127 | SDR19SG | 237 | SP12GS | 51 |
| RED704978 | 140 | RED803421FG | 243 | REDRR301TX | 127 | SE41G | 138 | SP12GSD | 51 |
| RED704979 | 140 | RED803521F | 243 | REDRR302TX | 127 | SE5G | 138 | SP12P | 49 |
| RED704981 | 140 | RED803521FG | 243 | REDRR305TX | 127 | SEALER | 137 | SP12PD | 49 |
| RED704982 | 140 | RED804042 | 106 | REDRR565 | 127 | SENBKRT | 75 | SP12PR5 | 49 |
| RED704983 | 140 | RED804043 | 106 | REDRR566 | 127 | SEPACK1 | 75 | SP12S | 50 |
| RED704984 | 140 | RED804092 | 105 | REDRR567 | 127 | SF93RP | 213 | SP12SD | 50 |
| RED704985 | 140 | RED804108 | 105 | REDRR569 | 127 | SF94RP | 213 | SP12SDS | 50 |
| RED704986 | 141 | RED804109 | 105 | REDRRX1SC | 128 | SG189 | 249 | SP12SS | 51 |
| RED704988 | 141 | RED804129 | 105 | REDRRX2TS | 128 | SG195 | 249 | SP12SSD | 51 |
| RED704988W | 141 | RED804136 | 141 | REDRRX3DS | 128 | SG196 | 249 | SP12SSR3 | 49 |
| RED704989 | 141 | RED804137 | 141 | REDRRX4DC | 128 | SG197 | 249 | SP14 | 50 |
| RED704995 | 87 | RED804139 | 105 | RFRCRM | 137 | SG213 | 249 | SP14B | 50 |
| RED704996 | 87 | RED804167 | 105 | RGRPLUM | 137 | SG355 | 249 | SP14BD | 50 |
| RED704998 | 87 | RED805503 | 106 | Ri335 | 160 | SG13072 | 66 | SP14BR3 | 48 |
| RED704999 | 87 | RED805504 | 106 | RISERSTN | 125 | SG13073 | 66 | SP14BR5 | 48 |
| RED705002 | 99 | RED805703 | 106 | RK299 | 191 | SG14088 | 66 | SP14D | 50 |
| RED705003 | 99 | RED805703FG | 106 | RK696 | 191 | SG14090 | 66 | SP14GS | 51 |
| RED705042 | 99 | RED805706 | 105 | RKP230 | 101 | SG14091 | 66 | SP14GSD | 51 |

Marshalltown Part Number Listing

| PART NO. | PAGE NO. | PART NO. | PAGE NO. | PART NO. | PAGE NO. | PART NO. | PAGE NO. | PART NO. | PAGE NO. |
|------------|----------|---------------|----------|--------------|----------|--------------|----------|----------|----------|
| SP14P | 49 | SP205SD | 50 | SW215 | 192 | TS2S | 93 | WFS45 | 198 |
| SP14PD | 49 | SP205SSR12 | 49 | SW218 | 192 | TS5S | 93 | WFS49 | 198 |
| SP14PR8 | 49 | SP225 | 50 | SW224 | 192 | TS10S | 93 | WFS448 | 198 |
| SP14S | 50 | SP225B | 50 | SWSBLADE4 | 92 | TS25S | 93 | WH60 | 181 |
| SP14SD | 50 | SP225BD | 50 | SWSBLADE6 | 92 | TS75S | 93 | WP12T | 122 |
| SP14SDS | 50 | SP225D | 50 | SWSBLADE8 | 92 | TS080 | 184 | WP16 | 122 |
| SP14SS | 51 | SP245 | 50 | SWSBLADE10 | 92 | TS081 | 184 | WP16F | 122 |
| SP14SSD | 51 | SP245B | 50 | SWSBLADE12 | 92 | TS082 | 184 | WP32 | 122 |
| SP14SSR5 | 49 | SP245BD | 50 | SWSBLADE14 | 92 | TS083 | 184 | WP32F | 122 |
| SP16 | 50 | SP245SSR16 | 49 | SWSBLADE16 | 92 | TS084 | 184 | WP48 | 122 |
| SP16B | 50 | SP496F | 183 | SWSBLADE16P2 | 92 | TS685 | 224 | WP48F | 122 |
| SP16BD | 50 | SP496M | 183 | SWSBLADE45 | 92 | TS686 | 224 | WP64 | 122 |
| SP16BR8 | 48 | SP815 | 50 | T1MPRIMER | 138 | TS917 | 176 | WP64F | 122 |
| SP16D | 50 | SP815B | 50 | T1MSPRAYOLW | 134 | TSABRKT | 71 | WP80 | 122 |
| SP16GS | 51 | SP815BD | 50 | T1MSTAMPOLW | 132 | TSBRKT | 71 | WP80F | 122 |
| SP16GSD | 51 | SP815BR10 | 48 | T34 | 101 | TSDSH | 71 | WP96 | 122 |
| SP16SD | 50 | SP815SD | 50 | T48 | 101 | TSDSK | 71 | WP96F | 122 |
| SP20BR8 | 48 | SP815SSR10 | 49 | T91 | 86 | TSEHG | 93 | WP468 | 214 |
| SP20BSER12 | 48 | SP907 | 192 | T112 | 21 | TSLPEK9 | 93 | WPT6 | 245 |
| SP22 | 50 | SP1635BR8 | 48 | T200 | 21 | TSLPEK11 | 93 | WPT7 | 245 |
| SP22BR8 | 48 | SP2245BR10 | 48 | T200SG | 20 | TSMWG | 93 | WPT8 | 245 |
| SP22D | 50 | SP2245BR14 | 48 | T212 | 21 | TSP473 | 225 | WPT9 | 245 |
| SP24 | 50 | SP2245SSR14 | 49 | T212SG | 20 | TSTSG74 | 215 | WPT10 | 245 |
| SP24BR8 | 48 | SPK2 | 157 | T300 | 21 | TSWBLACK | 131 | WPT11 | 245 |
| SP24D | 50 | SPK112HH | 157 | T300SG | 20 | TSWBBLUE | 131 | WPT12 | 245 |
| SP81BR5 | 48 | SPRAYOVERLAYF | 134 | T455 | 101 | TSWGREEN | 131 | WPT13 | 245 |
| SP81BR6 | 48 | SR668 | 16 | T456 | 101 | TSWTOOLBLACK | 131 | WS442F | 158 |
| SP81BR8 | 48 | SS20 | 189 | T457 | 101 | Tuck | 251 | WS443S | 158 |
| SP81BR10 | 48 | SS20G | 189 | T458 | 101 | TWB797 | 239 | YP985M | 98 |
| SP81BSER10 | 48 | SS20RK | 191 | T459 | 101 | TWG640 | 62 | | |
| SP83 | 50 | SSBAMBER | 129 | T460 | 101 | TWG642 | 62 | | |
| SP83BR3 | 48 | SSCORLTH | 129 | TBH3 | 19 | TWG644 | 62 | | |
| SP83SD | 50 | SSCSEA | 129 | TBH4 | 19 | TWG646 | 62 | | |
| SP83SSR3 | 49 | SSF93 | 213 | TC472 | 199 | TWR19 | 104 | | |
| SP104BR3 | 48 | SSKONA | 129 | TD9044 | 225 | TWR26 | 104 | | |
| SP123B | 50 | SSTANNIN | 129 | TEK290 | 199 | TXL | 214 | | |
| SP123BD | 50 | SSTK6 | 154 | TETRA | 120 | UB371 | 239,100 | | |
| SP124BSER8 | 48 | SSTK8 | 154 | TETRAF | 120 | US810 | 174 | | |
| SP143B | 50 | SSTK10 | 154 | TG640D | 62 | US920 | 173 | | |
| SP143BD | 50 | SSTK12 | 154 | TG642D | 62 | US9041 | 218 | | |
| SP143P | 49 | SSTK14 | 154 | TG644D | 62 | VCT12 | 217 | | |
| SP143PD | 49 | SSVERDIG | 129 | TG646D | 62 | VCT18 | 217 | | |
| SP143PR6 | 49 | SSWBRNZ | 129 | TGS1 | 214 | VERCOBB | 120 | | |
| SP143SS | 51 | ST12 | 21 | TGS2 | 214 | VERCOBBF | 120 | | |
| SP143SSD | 51 | ST14 | 46 | TGSL | 214 | VS733 | 179 | | |
| SP163B | 50 | ST14D | 46 | THS7 | 222,197 | VS792 | 179 | | |
| SP163BD | 50 | ST16 | 46 | THS7B | 222,197 | W92 | 227 | | |
| SP163P | 49 | ST16D | 46 | THS10B | 222,197 | WAP120 | 89 | | |
| SP163PD | 49 | ST18 | 193 | TILEFILE | 218 | WAP130 | 89 | | |
| SP163PR8 | 49 | ST24 | 193 | TILESCRN | 218 | WAPHDL | 89 | | |
| SP163SS | 51 | ST34 | 21 | TL | 214 | WB61 | 193 | | |
| SP163SSD | 51 | ST34SG | 20 | TLW | 214 | WB700 | 194 | | |
| SP164 | 50 | ST35 | 219 | TN724 | 217 | WCB48 | 78 | | |
| SP164B | 50 | ST78 | 21 | TN725 | 217 | WCB48R | 78 | | |
| SP164BD | 50 | ST78SG | 20 | TOPBLD12 | 217 | WCG093D | 62 | | |
| SP164BR3 | 48 | STAMPOVERLAY | 132 | TOPBLD18 | 217 | WCG093W | 62 | | |
| SP164BR6 | 48 | STAPLES12 | 220 | TOTE | 75 | WCT6 | 19 | | |
| SP164GS | 51 | STAPLES14 | 220 | TOTE30 | 187,245 | WCT8 | 19 | | |
| SP164GSD | 51 | STAPLES38 | 220 | TP159 | 89 | WEWBLACK | 131 | | |
| SP164P | 49 | STAPLES516 | 220 | TP159-5 | 89 | WEWBLUE | 131 | | |
| SP164PD | 49 | STAPLES916 | 220 | TP159H | 89 | WEWGREEN | 131 | | |
| SP164PR8 | 49 | STP14 | 107 | TP159H-5 | 89 | WEWTOOLBLACK | 131 | | |
| SP164SDS12 | 50 | SV459 | 96 | TP648 | 89 | WEWTOOLBLUE | 131 | | |
| SP164SS | 51 | SW3 | 22 | TP648-5 | 89 | WEWTOOLGREEN | 131 | | |
| SP164SSD | 51 | SW4 | 22 | TP648H | 89 | WF569D | 69 | | |
| SP164SSR8 | 49 | SW6 | 22 | TP648H-5 | 89 | WF943 | 70 | | |
| SP205 | 50 | SW8 | 22 | TP721 | 217 | WF944 | 70 | | |
| SP205B | 50 | SW12 | 22 | TPSG38 | 14 | WF946 | 70 | | |
| SP205BD | 50 | SW100H | 92 | TPSG614 | 14 | WF947 | 70 | | |
| SP205BR12 | 48 | SW212 | 22 | TPSG655 | 14 | WF948 | 70 | | |

Marshalltown EDI Number Listing

| EDI NO. | PAGE NO. | EDI NO. | PAGE NO. | EDI NO. | PAGE NO. | EDI NO. | PAGE NO. | EDI NO. | PAGE NO. |
|---------|----------|---------|----------|---------|----------|---------|------------|---------|----------|
| 10095 | 109 | 10217 | 26 | 10328 | 8 | 10432 | 63 | 10529 | 73 |
| 10096 | 109 | 10218 | 26 | 10329 | 89 | 10433 | 63 | 10530 | 73 |
| 10098 | 87 | 10219 | 26 | 10330 | 8 | 10434 | 63 | 10531 | 73 |
| 10099 | 87 | 10221 | 26 | 10332 | 8 | 10435 | 63 | 10532 | 73 |
| 10100 | 87 | 10222 | 26 | 10334 | 8 | 10436 | 63 | 10533 | 73 |
| 10101 | 87 | 10223 | 26 | 10336 | 8 | 10437 | 63 | 10534 | 73 |
| 10102 | 9 | 10224 | 26 | 10338 | 189 | 10438 | 63 | 10535 | 73 |
| 10103 | 87 | 10225 | 26 | 10339 | 189 | 10439 | 63 | 10536 | 73 |
| 10104 | 9 | 10226 | 8 | 10340 | 191 | 10440 | 63 | 10537 | 73 |
| 10105 | 7 | 10228 | 8 | 10341 | 188 | 10441 | 65 | 10538 | 73 |
| 10106 | 7 | 10229 | 26 | 10342 | 102,148 | 10442 | 65 | 10539 | 73 |
| 10108 | 7 | 10230 | 8 | 10343 | 102,148 | 10443 | 65 | 10540 | 73 |
| 10109 | 7 | 10231 | 26 | 10344 | 172 | 10444 | 65 | 10541 | 73 |
| 10110 | 7 | 10232 | 8 | 10345 | 106 | 10445 | 65 | 10542 | 73 |
| 10112 | 7 | 10233 | 26 | 10347 | 106 | 10446 | 65 | 10543 | 73 |
| 10113 | 87 | 10234 | 8 | 10348 | 7 | 10447 | 65 | 10544 | 73 |
| 10114 | 7 | 10235 | 7 | 10349 | 14 | 10448 | 65 | 10545 | 73 |
| 10116 | 7 | 10236 | 8 | 10350 | 7 | 10449 | 65 | 10546 | 73 |
| 10117 | 87 | 10237 | 7 | 10351 | 14 | 10450 | 65 | 10547 | 73 |
| 10118 | 7 | 10238 | 26 | 10352 | 14 | 10451 | 65 | 10548 | 73 |
| 10120 | 237 | 10239 | 25 | 10353 | 14 | 10452 | 65 | 10549 | 73 |
| 10121 | 8 | 10240 | 25 | 10354 | 7 | 10453 | 102 | 10550 | 73 |
| 10122 | 8 | 10246 | 25 | 10355 | 14 | 10457 | 172 | 10551 | 73 |
| 10123 | 8 | 10247 | 25 | 10356 | 14 | 10458 | 172 | 10552 | 73 |
| 10124 | 8 | 10248 | 7 | 10357 | 14 | 10459 | 96 | 10553 | 73 |
| 10125 | 8 | 10250 | 7 | 10358 | 45 | 10460 | 187 | 10554 | 73 |
| 10126 | 8 | 10251 | 25 | 10361 | 14 | 10462 | 250 | 10555 | 73 |
| 10128 | 8 | 10252 | 25 | 10362 | 8 | 10463 | 250 | 10556 | 73 |
| 10130 | 8 | 10253 | 25 | 10363 | 8 | 10464 | 250 | 10557 | 73 |
| 10132 | 8 | 10254 | 7 | 10371 | 245 | 10465 | 250 | 10558 | 73 |
| 10134 | 8 | 10255 | 25 | 10372 | 239,100 | 10466 | 250 | 10559 | 73 |
| 10136 | 8 | 10256 | 25 | 10373 | 239,100 | 10467 | 198,221 | 10560 | 73 |
| 10138 | 8 | 10257 | 25 | 10374 | 239,100 | 10468 | 198,221 | 10561 | 73 |
| 10139 | 237 | 10258 | 25 | 10375 | 23 | 10469 | 198,221 | 10562 | 73 |
| 10141 | 7 | 10260 | 25 | 10376 | 23 | 10470 | 198,221 | 10563 | 73 |
| 10142 | 7 | 10261 | 25 | 10377 | 23 | 10471 | 215 | 10564 | 73 |
| 10143 | 7 | 10262 | 25 | 10388 | 187,245 | 10472 | 199 | 10565 | 73 |
| 10144 | 237 | 10263 | 25 | 10400 | 187 | 10473 | 19 | 10566 | 73 |
| 10145 | 187 | 10264 | 26 | 10401 | 187 | 10474 | 19 | 10567 | 73 |
| 10146 | 187 | 10265 | 26 | 10402 | 187 | 10475 | 19 | 10568 | 73 |
| 10147 | 145 | 10266 | 26 | 10403 | 187 | 10476 | 19 | 10569 | 73 |
| 10148 | 7 | 10267 | 26 | 10404 | 187 | 10477 | 19 | 10570 | 73 |
| 10149 | 145 | 10268 | 26 | 10406 | 187 | 10479 | 21 | 10571 | 73 |
| 10150 | 7 | 10269 | 26 | 10407 | 187 | 10480 | 21 | 10572 | 73 |
| 10152 | 7 | 10302 | 16 | 10408 | 187 | 10481 | 21 | 10573 | 73 |
| 10153 | 7 | 10303 | 16 | 10409 | 187 | 10482 | 21 | 10574 | 73 |
| 10154 | 7 | 10304 | 106 | 10410 | 187 | 10483 | 183 | 10575 | 73 |
| 10156 | 145 | 10306 | 7 | 10411 | 187 | 10484 | 183 | 10576 | 73 |
| 10157 | 145 | 10308 | 7 | 10412 | 187 | 10485 | 183 | 10577 | 73 |
| 10171 | 8 | 10310 | 7 | 10413 | 187 | 10486 | 183 | 10578 | 73 |
| 10173 | 8 | 10311 | 70 | 10415 | 187 | 10487 | 183 | 10579 | 73 |
| 10185 | 8 | 10312 | 7 | 10416 | 63 | 10488 | 183 | 10580 | 73 |
| 10186 | 8 | 10313 | 70 | 10417 | 63 | 10489 | 183 | 10581 | 73 |
| 10187 | 8 | 10314 | 7 | 10418 | 63 | 10490 | 183 | 10582 | 73 |
| 10188 | 8 | 10315 | 15 | 10419 | 63 | 10491 | 183 | 10583 | 73 |
| 10189 | 7 | 10316 | 15 | 10420 | 63 | 10492 | 183 | 10584 | 95 |
| 10190 | 7 | 10317 | 15 | 10421 | 63 | 10493 | 183 | 10585 | 95 |
| 10201 | 26 | 10318 | 15 | 10422 | 63 | 10494 | 182 | 10586 | 95 |
| 10202 | 26 | 10319 | 15 | 10423 | 63 | 10495 | 182 | 10587 | 95 |
| 10204 | 26 | 10320 | 15 | 10424 | 63 | 10496 | 183 | 10588 | 95 |
| 10205 | 26 | 10321 | 15 | 10425 | 63 | 10497 | 183 | 10589 | 95 |
| 10206 | 7 | 10322 | 15 | 10426 | 63 | 10498 | 29 | 10590 | 95 |
| 10207 | 26 | 10323 | 15 | 10427 | 63 | 10516 | 28,174,239 | 10591 | 95 |
| 10208 | 7 | 10324 | 15 | 10428 | 63 | 10522 | 14 | 10593 | 95 |
| 10210 | 7 | 10325 | 89 | 10429 | 63 | 10523 | 14 | 10594 | 95 |
| 10212 | 7 | 10326 | 8 | 10430 | 63 | 10527 | 73 | 10595 | 95 |
| 10214 | 7 | 10327 | 89 | 10431 | 63 | 10528 | 73 | 10596 | 95 |

Marshalltown EDI Number Listing

| EDI NO. | PAGE NO. | EDI NO. | PAGE NO. | EDI NO. | PAGE NO. | EDI NO. | PAGE NO. | EDI NO. | PAGE NO. |
|---------|----------|---------|----------|---------|----------|---------|----------|---------|----------|
| 10597 | 95 | 10735 | 7 | 10879 | 155 | 11046 | 198 | 11155 | 20 |
| 10598 | 95 | 10736 | 7 | 10880 | 155 | 11047 | 198 | 11156 | 20 |
| 10599 | 217 | 10737 | 7 | 10881 | 155 | 11048 | 198 | 11157 | 20 |
| 10636 | 24 | 10738 | 11 | 10882 | 155 | 11049 | 198 | 11158 | 20 |
| 10637 | 24 | 10739 | 11 | 10883 | 155 | 11050 | 198 | 11159 | 20 |
| 10638 | 24 | 10740 | 11 | 10884 | 155 | 11051 | 198 | 11160 | 20 |
| 10639 | 24 | 10741 | 14 | 10885 | 155 | 11052 | 198 | 11161 | 20 |
| 10640 | 62 | 10742 | 12 | 10886 | 155 | 11053 | 198 | 11162 | 20 |
| 10641 | 62 | 10743 | 10 | 10888 | 155 | 11054 | 198 | 11163 | 12,243 |
| 10642 | 62 | 10744 | 10 | 10890 | 155 | 11055 | 198 | 11165 | 24 |
| 10643 | 62 | 10745 | 10 | 10896 | 155 | 11056 | 198 | 11166 | 24 |
| 10644 | 62 | 10746 | 9 | 10899 | 225,244 | 11057 | 198 | 11167 | 24 |
| 10645 | 62 | 10748 | 12 | 10917 | 108 | 11058 | 198 | 11169 | 83 |
| 10646 | 62 | 10749 | 12 | 10918 | 108 | 11059 | 198 | 11170 | 207 |
| 10647 | 62 | 10750 | 13 | 10919 | 108 | 11061 | 177 | 11171 | 207 |
| 10648 | 80 | 10751 | 13 | 10926 | 68 | 11074 | 25,238 | 11180 | 239 |
| 10649 | 80 | 10752 | 9 | 10927 | 68 | 11075 | 25,238 | 11181 | 239 |
| 10650 | 80 | 10753 | 177,213 | 10928 | 68 | 11076 | 25,238 | 11182 | 242 |
| 10651 | 80 | 10754 | 178 | 10929 | 55 | 11077 | 25,238 | 11189 | 249 |
| 10652 | 80 | 10755 | 178 | 10930 | 56 | 11078 | 238 | 11190 | 211 |
| 10653 | 80 | 10756 | 178 | 10931 | 56 | 11091 | 226 | 11192 | 211 |
| 10654 | 80 | 10757 | 215 | 10933 | 56 | 11092 | 226 | 11195 | 249 |
| 10655 | 80 | 10758 | 215 | 10934 | 56 | 11093 | 226 | 11196 | 249 |
| 10656 | 80 | 10760 | 108 | 10935 | 56 | 11094 | 226 | 11197 | 249 |
| 10657 | 80 | 10764 | 155 | 10936 | 56 | 11095 | 226 | 11198 | 11 |
| 10658 | 80 | 10766 | 155 | 10937 | 56 | 11096 | 226 | 11200 | 211 |
| 10659 | 80 | 10768 | 155 | 10938 | 56 | 11097 | 226 | 11201 | 211 |
| 10660 | 80 | 10782 | 155 | 10940 | 56 | 11098 | 226 | 11202 | 11 |
| 10661 | 80 | 10797 | 239 | 10941 | 56 | 11099 | 179 | 11203 | 12 |
| 10662 | 80 | 10798 | 164 | 10942 | 56 | 11100 | 178 | 11204 | 11 |
| 10663 | 80 | 10799 | 16 | 10943 | 56 | 11101 | 46 | 11205 | 11 |
| 10664 | 88 | 10805 | 9 | 10944 | 56 | 11102 | 13 | 11206 | 11 |
| 10665 | 96 | 10809 | 18 | 10945 | 56 | 11103 | 47 | 11207 | 11 |
| 10666 | 210 | 10810 | 174 | 10947 | 56 | 11104 | 47 | 11208 | 11 |
| 10667 | 210 | 10819 | 24 | 10948 | 56 | 11107 | 109 | 11209 | 11 |
| 10668 | 231 | 10821 | 10 | 10953 | 64 | 11108 | 109 | 11213 | 249 |
| 10671 | 12 | 10822 | 10 | 10954 | 55 | 11109 | 109 | 11217 | 47 |
| 10673 | 12 | 10823 | 9 | 10955 | 55 | 11112 | 109 | 11218 | 47 |
| 10704 | 229 | 10824 | 9 | 10956 | 55 | 11113 | 10 | 11219 | 47 |
| 10705 | 229 | 10838 | 25 | 10957 | 55 | 11117 | 10 | 11220 | 47 |
| 10706 | 229 | 10839 | 25 | 10958 | 55 | 11118 | 10 | 11221 | 47 |
| 10707 | 229 | 10840 | 25 | 10959 | 55 | 11119 | 10 | 11222 | 47 |
| 10708 | 229 | 10841 | 25 | 10960 | 55 | 11121 | 12 | 11223 | 47 |
| 10709 | 229 | 10844 | 245 | 10961 | 55 | 11122 | 10 | 11224 | 47 |
| 10710 | 229 | 10845 | 18 | 10962 | 55 | 11123 | 12 | 11225 | 47 |
| 10711 | 229 | 10846 | 18 | 10963 | 55 | 11124 | 10 | 11226 | 47 |
| 10712 | 229 | 10847 | 245 | 10964 | 55 | 11125 | 10 | 11227 | 47 |
| 10713 | 229 | 10847 | 245 | 10965 | 55 | 11127 | 10 | 11228 | 47 |
| 10714 | 229 | 10850 | 16 | 10966 | 55 | 11128 | 10 | 11271 | 110 |
| 10715 | 229 | 10851 | 16 | 10967 | 55 | 11130 | 10 | 11272 | 110 |
| 10716 | 229 | 10852 | 16 | 10968 | 55 | 11131 | 10 | 11273 | 110 |
| 10717 | 229 | 10853 | 16 | 10969 | 55 | 11133 | 10 | 11276 | 237 |
| 10718 | 229 | 10854 | 16 | 10970 | 55 | 11139 | 109 | 11277 | 237 |
| 10719 | 229 | 10855 | 197 | 10971 | 55 | 11140 | 109 | 11278 | 237 |
| 10720 | 229 | 10858 | 10 | 10972 | 55 | 11142 | 20 | 11279 | 237 |
| 10721 | 229 | 10859 | 10 | 10973 | 55 | 11143 | 20 | 11280 | 238 |
| 10722 | 229 | 10860 | 155 | 10974 | 55 | 11144 | 20 | 11281 | 238 |
| 10723 | 229 | 10861 | 155 | 10989 | 55 | 11145 | 20 | 11284 | 22 |
| 10724 | 229 | 10863 | 155 | 10997 | 170 | 11146 | 20 | 11285 | 22 |
| 10725 | 229 | 10865 | 155 | 10998 | 170 | 11147 | 20 | 11286 | 22 |
| 10726 | 229 | 10866 | 155 | 10999 | 170 | 11148 | 20 | 11287 | 22 |
| 10727 | 229 | 10867 | 155 | 11000 | 170 | 11149 | 20 | 11288 | 22 |
| 10728 | 229 | 10871 | 155 | 11001 | 170 | 11150 | 20 | 11289 | 22 |
| 10729 | 229 | 10872 | 155 | 11040 | 113 | 11151 | 20 | 11290 | 218 |
| 10730 | 7 | 10876 | 155 | 11041 | 113 | 11152 | 20 | 11291 | 218 |
| 10731 | 7 | 10877 | 155 | 11044 | 198 | 11153 | 20 | 11292 | 238 |
| 10733 | 7 | 10878 | 155 | 11045 | 198 | 11154 | 20 | 11293 | 238 |

Marshalltown EDI Number Listing

| EDI NO. | PAGE NO. | EDI NO. | PAGE NO. | EDI NO. | PAGE NO. | EDI NO. | PAGE NO. | EDI NO. | PAGE NO. |
|---------|----------|---------|------------|---------|----------|---------|----------|---------|----------|
| 11294 | 238 | 11689 | 193 | 12141 | 230 | 12236 | 45 | 12506 | 222,197 |
| 11303 | 14 | 11705 | 156 | 12143 | 43 | 12237 | 45 | 12507 | 222,197 |
| 11304 | 14 | 11706 | 156 | 12144 | 43 | 12238 | 45 | 12508 | 107 |
| 11305 | 14 | 11707 | 156 | 12145 | 43 | 12239 | 45 | 12509 | 107 |
| 11306 | 14 | 11709 | 156 | 12146 | 43 | 12240 | 44 | 12513 | 107 |
| 11307 | 14 | 11711 | 156 | 12147 | 43 | 12241 | 44 | 12515 | 107 |
| 11308 | 14 | 11712 | 156 | 12148 | 43 | 12242 | 44 | 12517 | 107 |
| 11309 | 14 | 11716 | 156 | 12149 | 43 | 12243 | 44 | 12519 | 107 |
| 11310 | 14 | 11717 | 156 | 12150 | 43 | 12263 | 165 | 12527 | 220 |
| 11311 | 14 | 11719 | 156 | 12151 | 43 | 12264 | 166 | 12562 | 220 |
| 11313 | 14 | 11735 | 27 | 12152 | 46 | 12265 | 166,169 | 12611 | 151 |
| 11315 | 14 | 11750 | 51 | 12153 | 46 | 12266 | 166,169 | 12612 | 151 |
| 11317 | 14 | 11751 | 51 | 12159 | 39 | 12267 | 166,169 | 12613 | 151 |
| 11319 | 14 | 11752 | 51 | 12160 | 231 | 12268 | 167 | 12614 | 151 |
| 11321 | 14 | 11753 | 76 | 12161 | 231 | 12269 | 167 | 12615 | 151 |
| 11323 | 14 | 11754 | 76 | 12162 | 28 | 12270 | 167 | 12616 | 151 |
| 11324 | 14 | 11755 | 76 | 12165 | 149 | 12271 | 167 | 12617 | 151 |
| 11430 | 237 | 11790 | 64 | 12166 | 149 | 12272 | 167 | 12618 | 151 |
| 11431 | 237 | 11801 | 104 | 12167 | 149 | 12273 | 167 | 12619 | 151 |
| 11432 | 154 | 11805 | 104 | 12168 | 149 | 12274 | 167 | 12620 | 151 |
| 11433 | 154 | 11806 | 104 | 12169 | 149 | 12275 | 168 | 12622 | 151 |
| 11434 | 154 | 11808 | 104 | 12170 | 149 | 12276 | 168 | 12629 | 195 |
| 11435 | 154 | 11809 | 104 | 12171 | 149 | 12277 | 168 | 12630 | 195 |
| 11436 | 154 | 11810 | 104 | 12172 | 149 | 12278 | 168 | 12631 | 195 |
| 11567 | 105 | 11811 | 104 | 12173 | 149 | 12281 | 169 | 12632 | 195 |
| 11568 | 105 | 11812 | 104 | 12174 | 149 | 12283 | 169 | 12633 | 195 |
| 11569 | 105 | 11814 | 104 | 12175 | 149 | 12284 | 169 | 12634 | 195 |
| 11570 | 105 | 11816 | 104 | 12176 | 149 | 12285 | 167 | 12635 | 195 |
| 11571 | 106 | 11817 | 104 | 12177 | 149 | 12286 | 167 | 12636 | 195 |
| 11572 | 106 | 11818 | 104 | 12178 | 149 | 12287 | 167 | 12637 | 104 |
| 11573 | 106 | 11820 | 94 | 12179 | 150 | 12288 | 167 | 12638 | 94 |
| 11574 | 105 | 11821 | 94 | 12180 | 150 | 12289 | 167 | 12639 | 94 |
| 11575 | 105 | 11822 | 94 | 12181 | 150 | 12290 | 167 | 12648 | 89 |
| 11576 | 105 | 12012 | 223 | 12182 | 150 | 12291 | 167 | 12649 | 89 |
| 11581 | 65 | 12104 | 42 | 12183 | 150 | 12292 | 168 | 12682 | 89 |
| 11582 | 65 | 12105 | 41 | 12184 | 150 | 12293 | 168 | 12683 | 89 |
| 11583 | 65 | 12106 | 42 | 12187 | 212 | 12294 | 168 | 12782 | 104 |
| 11584 | 65 | 12107 | 191 | 12188 | 212 | 12295 | 168 | 12783 | 104 |
| 11585 | 65 | 12108 | 191 | 12194 | 47 | 12296 | 168 | 12784 | 104 |
| 11586 | 65 | 12110 | 42 | 12196 | 84 | 12297 | 168 | 12785 | 104 |
| 11587 | 65 | 12114 | 191 | 12197 | 84 | 12298 | 169 | 12786 | 104 |
| 11588 | 65 | 12115 | 191 | 12210 | 219 | 12299 | 169 | 12787 | 104 |
| 11589 | 65 | 12116 | 191 | 12211 | 219 | 12304 | 165 | 12788 | 104 |
| 11590 | 65 | 12117 | 191 | 12212 | 220 | 12305 | 165 | 12789 | 104 |
| 11591 | 65 | 12118 | 191 | 12213 | 219 | 12306 | 166 | 12790 | 104 |
| 11592 | 65 | 12119 | 191 | 12214 | 219 | 12307 | 167 | 12791 | 104 |
| 11593 | 65 | 12120 | 225 | 12215 | 220 | 12308 | 167 | 12792 | 104 |
| 11594 | 65 | 12121 | 225 | 12216 | 44 | 12309 | 167 | 12793 | 104 |
| 11595 | 65 | 12122 | 42 | 12217 | 44 | 12310 | 167 | 12863 | 103 |
| 11596 | 65 | 12123 | 41 | 12218 | 44 | 12311 | 167 | 12939 | 103 |
| 11597 | 65 | 12124 | 42 | 12219 | 44 | 12312 | 167 | 12940 | 220 |
| 11598 | 65 | 12125 | 41 | 12220 | 44 | 12313 | 167 | 12941 | 220 |
| 11670 | 193 | 12126 | 42 | 12221 | 44 | 12314 | 167 | 12942 | 220 |
| 11671 | 193 | 12127 | 30,222,197 | 12222 | 44 | 12315 | 169 | 12943 | 220 |
| 11672 | 193 | 12128 | 42 | 12223 | 44 | 12316 | 167 | 12944 | 220 |
| 11673 | 193 | 12129 | 30,222,197 | 12224 | 45 | 12317 | 167 | 12947 | 220 |
| 11674 | 193 | 12130 | 42 | 12225 | 45 | 12318 | 167 | 12948 | 220 |
| 11675 | 193 | 12131 | 41 | 12226 | 45 | 12319 | 167 | 12949 | 220 |
| 11677 | 193 | 12132 | 42 | 12227 | 45 | 12320 | 167 | 12950 | 92 |
| 11681 | 193 | 12133 | 41 | 12228 | 45 | 12321 | 167 | 12951 | 92 |
| 11682 | 193 | 12134 | 42 | 12229 | 45 | 12322 | 167 | 12952 | 92 |
| 11683 | 193 | 12135 | 41 | 12230 | 45 | 12323 | 167 | 12984 | 29 |
| 11684 | 193 | 12136 | 225,244 | 12231 | 45 | 12324 | 167 | 12985 | 28 |
| 11685 | 193 | 12137 | 225,244 | 12232 | 45 | 12335 | 169 | 12986 | 28,239 |
| 11686 | 193 | 12138 | 225,244 | 12233 | 45 | 12403 | 220 | 12987 | 28,239 |
| 11687 | 193 | 12139 | 46 | 12234 | 45 | 12421 | 194 | 12988 | 78 |
| 11688 | 193 | 12140 | 46 | 12235 | 45 | 12504 | 222,197 | 12989 | 78 |

Marshalltown EDI Number Listing

| EDI NO. | PAGE NO. | EDI NO. | PAGE NO. | EDI NO. | PAGE NO. | EDI NO. | PAGE NO. | EDI NO. | PAGE NO. |
|---------|----------|---------|----------|---------|----------|---------|----------|---------|----------|
| 12990 | 78 | 13134 | 49 | 13231 | 19 | 13312 | 92 | 13440 | 44 |
| 12991 | 78 | 13135 | 50 | 13232 | 42 | 13313 | 92 | 13441 | 44 |
| 12992 | 78 | 13136 | 49 | 13233 | 41 | 13314 | 92 | 13442 | 44 |
| 12993 | 78 | 13137 | 50 | 13234 | 42 | 13315 | 92 | 13443 | 44 |
| 12994 | 78 | 13138 | 50 | 13235 | 41 | 13316 | 92 | 13444 | 43 |
| 12995 | 78 | 13139 | 46 | 13236 | 39 | 13317 | 92 | 13445 | 43 |
| 12996 | 78 | 13140 | 46 | 13237 | 19 | 13318 | 92 | 13446 | 43 |
| 12997 | 78 | 13141 | 49 | 13238 | 44 | 13319 | 92 | 13447 | 43 |
| 12998 | 78 | 13142 | 79 | 13239 | 44 | 13320 | 92 | 13448 | 43 |
| 12999 | 78 | 13143 | 49 | 13240 | 44 | 13321 | 92 | 13449 | 43 |
| 13000 | 77 | 13144 | 49 | 13241 | 44 | 13322 | 92 | 13450 | 43 |
| 13001 | 80 | 13145 | 49 | 13242 | 19 | 13323 | 92 | 13451 | 43 |
| 13002 | 80 | 13146 | 49 | 13243 | 19 | 13324 | 92 | 13452 | 43 |
| 13003 | 80 | 13147 | 49 | 13244 | 42 | 13325 | 92 | 13453 | 50 |
| 13004 | 80 | 13148 | 49 | 13245 | 41 | 13330 | 92 | 13454 | 50 |
| 13005 | 79 | 13149 | 51 | 13246 | 42 | 13331 | 92 | 13455 | 50 |
| 13006 | 88 | 13150 | 51 | 13247 | 39 | 13332 | 92 | 13456 | 50 |
| 13007 | 88 | 13151 | 51 | 13248 | 42 | 13333 | 92 | 13457 | 51 |
| 13008 | 88 | 13152 | 51 | 13249 | 41 | 13334 | 92 | 13458 | 41 |
| 13071 | 66 | 13153 | 49 | 13250 | 42 | 13335 | 92 | 13459 | 41 |
| 13072 | 66 | 13154 | 49 | 13251 | 41 | 13336 | 92 | 13460 | 43 |
| 13073 | 66 | 13155 | 51 | 13252 | 39 | 13371 | 138 | 13461 | 43 |
| 13074 | 66 | 13156 | 49 | 13253 | 19 | 13372 | 138 | 13462 | 43 |
| 13075 | 66 | 13157 | 49 | 13254 | 19 | 13373 | 138 | 13463 | 39 |
| 13076 | 66 | 13158 | 49 | 13255 | 19 | 13374 | 138 | 13464 | 43 |
| 13080 | 184 | 13159 | 49 | 13256 | 19 | 13377 | 179 | 13465 | 43 |
| 13081 | 184 | 13160 | 49 | 13257 | 19 | 13379 | 220 | 13466 | 245 |
| 13082 | 184 | 13161 | 49 | 13258 | 19 | 13381 | 79 | 13467 | 245 |
| 13083 | 184 | 13162 | 49 | 13259 | 19 | 13383 | 79 | 13468 | 245 |
| 13084 | 184 | 13163 | 48 | 13260 | 19 | 13384 | 79 | 13469 | 245 |
| 13085 | 184 | 13164 | 50 | 13261 | 92 | 13385 | 79 | 13472 | 171 |
| 13086 | 184 | 13166 | 50 | 13262 | 42 | 13386 | 79 | 13476 | 171 |
| 13087 | 184 | 13167 | 50 | 13263 | 41 | 13387 | 79 | 13478 | 160,161 |
| 13088 | 184 | 13168 | 50 | 13265 | 39 | 13389 | 79 | 13479 | 160,161 |
| 13100 | 63 | 13169 | 50 | 13266 | 42 | 13395 | 43 | 13480 | 175 |
| 13101 | 63 | 13174 | 50 | 13267 | 41 | 13396 | 43 | 13481 | 175 |
| 13102 | 63 | 13175 | 50 | 13268 | 42 | 13397 | 79 | 13482 | 160 |
| 13104 | 46 | 13176 | 50 | 13269 | 41 | 13398 | 43 | 13485 | 62 |
| 13105 | 46 | 13194 | 42 | 13270 | 42 | 13399 | 43 | 13486 | 62 |
| 13106 | 46 | 13195 | 42 | 13271 | 39 | 13401 | 43 | 13487 | 62 |
| 13107 | 49 | 13196 | 42 | 13272 | 42 | 13402 | 43 | 13488 | 62 |
| 13108 | 49 | 13197 | 41 | 13273 | 41 | 13403 | 43 | 13489 | 62 |
| 13109 | 50 | 13198 | 42 | 13274 | 42 | 13404 | 43 | 13490 | 62 |
| 13110 | 50 | 13199 | 41 | 13275 | 39 | 13405 | 43 | 13491 | 62 |
| 13111 | 50 | 13200 | 42 | 13276 | 42 | 13406 | 43 | 13492 | 62 |
| 13112 | 50 | 13201 | 41 | 13277 | 41 | 13408 | 43 | 13493 | 62 |
| 13113 | 50 | 13203 | 39 | 13278 | 42 | 13409 | 43 | 13494 | 62 |
| 13114 | 50 | 13204 | 42 | 13279 | 41 | 13410 | 43 | 13495 | 62 |
| 13115 | 51 | 13205 | 41 | 13280 | 39 | 13413 | 39 | 13496 | 62 |
| 13116 | 50 | 13206 | 42 | 13281 | 92 | 13414 | 44 | 13497 | 62 |
| 13117 | 50 | 13207 | 41 | 13282 | 41 | 13415 | 44 | 13498 | 62 |
| 13118 | 50 | 13208 | 42 | 13283 | 92 | 13416 | 44 | 13499 | 62 |
| 13119 | 50 | 13209 | 41 | 13284 | 92 | 13417 | 44 | 13500 | 62 |
| 13120 | 50 | 13210 | 39 | 13285 | 44 | 13418 | 44 | 13501 | 62 |
| 13121 | 50 | 13211 | 44 | 13286 | 44 | 13419 | 44 | 13502 | 62 |
| 13122 | 51 | 13212 | 44 | 13287 | 92 | 13420 | 44 | 13503 | 62 |
| 13123 | 51 | 13220 | 19 | 13288 | 44 | 13421 | 44 | 13504 | 62 |
| 13124 | 51 | 13221 | 39 | 13289 | 44 | 13422 | 43 | 13505 | 62 |
| 13125 | 50 | 13222 | 42 | 13290 | 92 | 13423 | 43 | 13506 | 62 |
| 13126 | 50 | 13223 | 41 | 13291 | 92 | 13424 | 43 | 13507 | 62 |
| 13127 | 51 | 13224 | 42 | 13292 | 44 | 13425 | 43 | 13508 | 62 |
| 13128 | 50 | 13225 | 41 | 13293 | 44 | 13426 | 43 | 13509 | 81 |
| 13129 | 51 | 13226 | 42 | 13296 | 47 | 13435 | 245 | 13510 | 44 |
| 13130 | 50 | 13227 | 41 | 13300 | 47 | 13436 | 39 | 13511 | 44 |
| 13131 | 50 | 13228 | 42 | 13308 | 92 | 13437 | 245 | 13512 | 44 |
| 13132 | 50 | 13229 | 41 | 13309 | 92 | 13438 | 39 | 13513 | 44 |
| 13133 | 51 | 13230 | 39 | 13310 | 92 | 13439 | 39 | 13514 | 44 |

Marshalltown EDI Number Listing

| EDI NO. | PAGE NO. | EDI NO. | PAGE NO. | EDI NO. | PAGE NO. | EDI NO. | PAGE NO. | EDI NO. | PAGE NO. |
|---------|----------|---------|----------|---------|----------|---------|----------|---------|----------|
| 13515 | 44 | 13581 | 48 | 13660 | 208 | 13758 | 59 | 13853 | 13,162 |
| 13516 | 44 | 13582 | 48 | 13662 | 208 | 13759 | 59 | 13857 | 249 |
| 13517 | 44 | 13583 | 48 | 13664 | 208 | 13760 | 59 | 13859 | 249 |
| 13518 | 81 | 13584 | 48 | 13666 | 208 | 13761 | 59 | 13860 | 78 |
| 13519 | 81 | 13585 | 48 | 13668 | 208 | 13762 | 59 | 13862 | 77 |
| 13520 | 45 | 13586 | 48 | 13670 | 208 | 13763 | 59 | 13863 | 78 |
| 13521 | 45 | 13587 | 48 | 13672 | 208 | 13764 | 59 | 13864 | 77 |
| 13522 | 45 | 13588 | 48 | 13674 | 208 | 13765 | 59 | 13865 | 77 |
| 13523 | 45 | 13589 | 48 | 13676 | 208 | 13766 | 59 | 13866 | 77 |
| 13524 | 45 | 13590 | 48 | 13678 | 208 | 13767 | 59 | 13869 | 87 |
| 13525 | 45 | 13591 | 48 | 13680 | 208 | 13768 | 59 | 13870 | 82 |
| 13526 | 45 | 13592 | 48 | 13682 | 208 | 13769 | 59 | 13871 | 82 |
| 13527 | 45 | 13593 | 48 | 13684 | 208 | 13770 | 59 | 13872 | 77 |
| 13528 | 45 | 13594 | 48 | 13686 | 208 | 13771 | 59 | 13873 | 77 |
| 13529 | 45 | 13595 | 48 | 13688 | 208 | 13772 | 59 | 13874 | 77 |
| 13530 | 45 | 13596 | 48 | 13690 | 208 | 13773 | 59 | 13875 | 77 |
| 13531 | 45 | 13597 | 48 | 13692 | 208 | 13774 | 59 | 13876 | 78 |
| 13532 | 45 | 13598 | 48 | 13694 | 208 | 13775 | 59 | 13877 | 91 |
| 13533 | 45 | 13599 | 48 | 13697 | 23 | 13776 | 59 | 13880 | 54 |
| 13534 | 45 | 13600 | 57 | 13698 | 23 | 13777 | 59 | 13881 | 61 |
| 13535 | 45 | 13601 | 57 | 13699 | 23 | 13779 | 79 | 13882 | 54 |
| 13536 | 45 | 13602 | 57 | 13700 | 194 | 13781 | 79 | 13883 | 61 |
| 13537 | 45 | 13603 | 57 | 13701 | 194 | 13782 | 80 | 13884 | 54 |
| 13538 | 45 | 13604 | 57 | 13702 | 144 | 13783 | 80 | 13885 | 61 |
| 13539 | 45 | 13605 | 57 | 13703 | 144 | 13784 | 80 | 13886 | 54 |
| 13540 | 81 | 13606 | 57 | 13704 | 144 | 13785 | 80 | 13887 | 58 |
| 13541 | 81 | 13607 | 57 | 13706 | 144 | 13786 | 80 | 13888 | 54 |
| 13542 | 81 | 13608 | 57 | 13708 | 144 | 13787 | 80 | 13889 | 42 |
| 13543 | 81 | 13609 | 57 | 13709 | 144 | 13788 | 80 | 13890 | 54 |
| 13544 | 81 | 13610 | 57 | 13710 | 144 | 13789 | 80 | 13891 | 42 |
| 13545 | 81 | 13611 | 57 | 13712 | 144 | 13790 | 80 | 13892 | 54 |
| 13546 | 81 | 13612 | 57 | 13715 | 144 | 13791 | 80 | 13893 | 41 |
| 13547 | 81 | 13613 | 57 | 13717 | 100 | 13792 | 179 | 13894 | 54 |
| 13548 | 81 | 13614 | 57 | 13718 | 100 | 13793 | 76 | 13895 | 41 |
| 13549 | 81 | 13615 | 57 | 13719 | 165 | 13794 | 76 | 13896 | 54 |
| 13550 | 81 | 13616 | 57 | 13720 | 165 | 13795 | 76 | 13897 | 44 |
| 13551 | 81 | 13617 | 57 | 13724 | 79 | 13796 | 76 | 13898 | 54 |
| 13552 | 81 | 13618 | 57 | 13725 | 185 | 13797 | 76 | 13899 | 44 |
| 13553 | 81 | 13619 | 57 | 13726 | 185 | 13799 | 47 | 13900 | 54 |
| 13554 | 81 | 13620 | 57 | 13727 | 185 | 13801 | 46 | 13901 | 43 |
| 13555 | 81 | 13621 | 57 | 13730 | 79 | 13802 | 46 | 13902 | 54 |
| 13556 | 81 | 13622 | 57 | 13731 | 227 | 13803 | 46 | 13903 | 43 |
| 13557 | 81 | 13623 | 57 | 13732 | 173 | 13804 | 46 | 13904 | 54 |
| 13558 | 81 | 13624 | 57 | 13733 | 179 | 13805 | 150 | 13905 | 43 |
| 13559 | 81 | 13625 | 57 | 13735 | 91 | 13806 | 150 | 13906 | 54 |
| 13560 | 81 | 13626 | 57 | 13736 | 79 | 13807 | 150 | 13907 | 43 |
| 13561 | 81 | 13627 | 57 | 13737 | 91 | 13808 | 13,162 | 13908 | 54 |
| 13562 | 81 | 13628 | 57 | 13738 | 91 | 13809 | 13,162 | 13909 | 50 |
| 13563 | 81 | 13629 | 57 | 13739 | 90 | 13814 | 13,162 | 13910 | 54 |
| 13564 | 81 | 13630 | 79 | 13740 | 67 | 13815 | 13,162 | 13911 | 50 |
| 13565 | 81 | 13631 | 57 | 13741 | 96 | 13816 | 13,162 | 13912 | 54 |
| 13566 | 81 | 13632 | 57 | 13742 | 67 | 13817 | 46 | 13913 | 50 |
| 13567 | 81 | 13633 | 62 | 13743 | 96 | 13818 | 46 | 13914 | 54 |
| 13568 | 81 | 13634 | 62 | 13744 | 96 | 13819 | 46 | 13915 | 50 |
| 13569 | 81 | 13636 | 208 | 13745 | 96 | 13821 | 13,162 | 13916 | 54 |
| 13570 | 81 | 13638 | 208 | 13746 | 96 | 13822 | 69 | 13917 | 50 |
| 13571 | 81 | 13640 | 208 | 13748 | 88 | 13824 | 54 | 13918 | 54 |
| 13572 | 81 | 13642 | 208 | 13749 | 87 | 13825 | 13,162 | 13919 | 50 |
| 13573 | 81 | 13644 | 208 | 13750 | 78 | 13826 | 13,162 | 13920 | 54 |
| 13574 | 81 | 13646 | 208 | 13751 | 59 | 13833 | 13,162 | 13921 | 51 |
| 13575 | 81 | 13648 | 208 | 13752 | 59 | 13835 | 13,162 | 13922 | 54 |
| 13576 | 81 | 13650 | 208 | 13753 | 59 | 13836 | 64 | 13923 | 51 |
| 13577 | 48 | 13652 | 208 | 13754 | 59 | 13837 | 46 | 13924 | 54 |
| 13578 | 48 | 13654 | 208 | 13755 | 59 | 13838 | 150 | 13925 | 50 |
| 13579 | 48 | 13656 | 208 | 13756 | 59 | 13850 | 13,162 | 13926 | 54 |
| 13580 | 48 | 13658 | 208 | 13757 | 59 | 13851 | 13,162 | 13927 | 50 |

Marshalltown EDI Number Listing

| EDI NO. | PAGE NO. | EDI NO. | PAGE NO. | EDI NO. | PAGE NO. | EDI NO. | PAGE NO. | EDI NO. | PAGE NO. |
|---------|----------|---------|----------|---------|----------|---------|----------|---------|----------|
| 13928 | 54 | 14000 | 112 | 14101 | 56 | 14187 | 68 | 14255 | 84 |
| 13929 | 50 | 14001 | 112 | 14102 | 64 | 14188 | 52 | 14256 | 84 |
| 13930 | 54 | 14002 | 52 | 14103 | 63 | 14189 | 68 | 14257 | 84 |
| 13931 | 50 | 14003 | 112 | 14104 | 63 | 14190 | 53 | 14258 | 83 |
| 13932 | 54 | 14004 | 112 | 14105 | 63 | 14191 | 68 | 14259 | 83 |
| 13933 | 50 | 14005 | 112 | 14106 | 63 | 14192 | 53 | 14260 | 59 |
| 13934 | 54 | 14006 | 112 | 14107 | 63 | 14193 | 68 | 14261 | 61 |
| 13936 | 54 | 14007 | 112 | 14108 | 64 | 14194 | 69 | 14262 | 59 |
| 13937 | 45 | 14008 | 112 | 14109 | 63 | 14195 | 68 | 14263 | 61 |
| 13938 | 54 | 14010 | 194 | 14110 | 63 | 14196 | 69 | 14264 | 59 |
| 13939 | 45 | 14012 | 56 | 14111 | 63 | 14197 | 69 | 14265 | 61 |
| 13940 | 54 | 14013 | 97 | 14112 | 58 | 14198 | 69 | 14266 | 59 |
| 13941 | 50 | 14014 | 97 | 14113 | 64 | 14199 | 69 | 14267 | 61 |
| 13942 | 54 | 14015 | 97 | 14114 | 58 | 14200 | 54 | 14268 | 60 |
| 13943 | 50 | 14016 | 97 | 14116 | 58 | 14201 | 69 | 14269 | 60 |
| 13944 | 54 | 14017 | 97 | 14118 | 58 | 14202 | 54 | 14270 | 59 |
| 13946 | 54 | 14018 | 97 | 14119 | 58 | 14203 | 69 | 14272 | 59 |
| 13947 | 46 | 14019 | 97 | 14120 | 58 | 14204 | 54 | 14274 | 59 |
| 13948 | 54 | 14028 | 77 | 14121 | 58 | 14205 | 69 | 14276 | 59 |
| 13950 | 54 | 14029 | 77 | 14129 | 58 | 14206 | 54 | 14278 | 23 |
| 13951 | 56 | 14030 | 77 | 14130 | 58 | 14207 | 69 | 14279 | 23 |
| 13952 | 56 | 14031 | 77 | 14131 | 58 | 14208 | 69 | 14280 | 61 |
| 13953 | 56 | 14032 | 77 | 14132 | 58 | 14209 | 69 | 14281 | 23 |
| 13954 | 56 | 14033 | 77 | 14133 | 58 | 14210 | 61 | 14282 | 62 |
| 13955 | 56 | 14035 | 77 | 14134 | 58 | 14211 | 68 | 14283 | 61 |
| 13956 | 56 | 14036 | 214 | 14135 | 58 | 14212 | 61 | 14284 | 52 |
| 13957 | 56 | 14036 | 214 | 14136 | 58 | 14213 | 68 | 14285 | 190 |
| 13958 | 56 | 14037 | 214 | 14137 | 58 | 14214 | 61 | 14286 | 52 |
| 13960 | 56 | 14037 | 214 | 14139 | 58 | 14215 | 68 | 14288 | 52 |
| 13961 | 56 | 14038 | 63 | 14140 | 58 | 14216 | 61 | 14289 | 51,243 |
| 13962 | 56 | 14039 | 63 | 14141 | 66 | 14217 | 67 | 14290 | 52 |
| 13963 | 54 | 14040 | 63 | 14143 | 59 | 14218 | 61 | 14292 | 52 |
| 13964 | 56 | 14041 | 63 | 14144 | 59 | 14219 | 250 | 14293 | 70 |
| 13965 | 54 | 14042 | 63 | 14145 | 59 | 14219 | 250 | 14294 | 52 |
| 13966 | 56 | 14043 | 63 | 14146 | 53 | 14220 | 61 | 14295 | 70 |
| 13967 | 54 | 14044 | 63 | 14148 | 66 | 14221 | 52 | 14296 | 52 |
| 13968 | 56 | 14045 | 63 | 14149 | 53 | 14222 | 52 | 14297 | 70 |
| 13969 | 54 | 14046 | 63 | 14150 | 53 | 14223 | 52 | 14298 | 70 |
| 13970 | 56 | 14047 | 66 | 14151 | 66 | 14224 | 52 | 14299 | 70 |
| 13971 | 54 | 14048 | 66 | 14153 | 66 | 14225 | 52 | 14307 | 70 |
| 13972 | 56 | 14049 | 66 | 14154 | 52 | 14226 | 52 | 14308 | 153 |
| 13973 | 54 | 14055 | 66 | 14156 | 53 | 14227 | 52 | 14310 | 153 |
| 13974 | 56 | 14076 | 245 | 14159 | 89 | 14228 | 52 | 14312 | 153 |
| 13975 | 54 | 14077 | 245 | 14160 | 52 | 14229 | 52 | 14314 | 153 |
| 13976 | 56 | 14078 | 245 | 14161 | 52 | 14230 | 61 | 14315 | 70 |
| 13977 | 82 | 14079 | 245 | 14162 | 52 | 14231 | 68 | 14319 | 195 |
| 13978 | 56 | 14080 | 245 | 14163 | 89 | 14232 | 61 | 14320 | 153 |
| 13979 | 82 | 14081 | 245 | 14164 | 53 | 14233 | 68 | 14321 | 152 |
| 13980 | 56 | 14082 | 66 | 14165 | 89 | 14234 | 68 | 14322 | 153 |
| 13981 | 82 | 14084 | 245 | 14166 | 53 | 14235 | 68 | 14323 | 152 |
| 13982 | 56 | 14085 | 245 | 14167 | 89 | 14236 | 68 | 14324 | 153 |
| 13983 | 82 | 14086 | 245 | 14168 | 53 | 14237 | 68 | 14325 | 152 |
| 13984 | 56 | 14087 | 245 | 14169 | 246 | 14238 | 68 | 14326 | 153 |
| 13986 | 56 | 14088 | 66 | 14170 | 52 | 14239 | 68 | 14327 | 152 |
| 13987 | 82 | 14089 | 66 | 14171 | 104 | 14240 | 61 | 14331 | 70 |
| 13988 | 82 | 14089 | 66 | 14172 | 52 | 14241 | 69 | 14333 | 70 |
| 13989 | 82 | 14090 | 66 | 14174 | 53 | 14242 | 61 | 14335 | 160 |
| 13990 | 82 | 14091 | 66 | 14176 | 53 | 14244 | 68 | 14336 | 160 |
| 13991 | 82 | 14092 | 66 | 14178 | 176 | 14245 | 69 | 14337 | 153 |
| 13992 | 82 | 14093 | 66 | 14179 | 68 | 14246 | 23 | 14338 | 153 |
| 13993 | 82 | 14094 | 66 | 14180 | 53 | 14247 | 46 | 14339 | 153 |
| 13994 | 82 | 14095 | 66 | 14181 | 68 | 14248 | 46 | 14341 | 153 |
| 13995 | 82 | 14096 | 66 | 14182 | 53 | 14249 | 46 | 14343 | 152 |
| 13996 | 82 | 14097 | 66 | 14183 | 68 | 14250 | 46 | 14345 | 153 |
| 13997 | 82 | 14098 | 66 | 14184 | 53 | 14251 | 85 | 14358 | 70 |
| 13998 | 235 | 14099 | 66 | 14185 | 68 | 14252 | 86 | 14359 | 152 |
| 13999 | 82 | 14100 | 64 | 14186 | 52 | 14253 | 86 | 14360 | 152 |

Marshalltown EDI Number Listing

| EDI NO. | PAGE NO. | EDI NO. | PAGE NO. | EDI NO. | PAGE NO. | EDI NO. | PAGE NO. | EDI NO. | PAGE NO. |
|---------|----------|---------|----------|---------|----------|---------|----------|---------|----------|
| 14361 | 152 | 14453 | 213 | 14556 | 175 | 14658 | 149,230 | 14751 | 103 |
| 14363 | 153 | 14454 | 212 | 14559 | 68 | 14659 | 13,163 | 14752 | 95 |
| 14364 | 153 | 14455 | 101 | 14560 | 158 | 14660 | 181 | 14753 | 90 |
| 14365 | 153 | 14456 | 101 | 14561 | 158 | 14661 | 164 | 14754 | 95 |
| 14366 | 153 | 14457 | 101 | 14562 | 158 | 14662 | 165 | 14755 | 76 |
| 14367 | 199 | 14458 | 101 | 14563 | 158 | 14663 | 149,230 | 14758 | 152 |
| 14368 | 199 | 14459 | 101 | 14564 | 158 | 14665 | 149,230 | 14759 | 152 |
| 14369 | 199 | 14460 | 101 | 14565 | 158 | 14680 | 181 | 14760 | 152 |
| 14374 | 70 | 14467 | 149,230 | 14566 | 158 | 14681 | 149,230 | 14768 | 88 |
| 14377 | 70 | 14468 | 149,230 | 14567 | 158 | 14682 | 149,230 | 14769 | 88 |
| 14378 | 70 | 14469 | 149,230 | 14569 | 69 | 14683 | 149,230 | 14770 | 95 |
| 14379 | 178,214 | 14470 | 149,230 | 14570 | 176 | 14684 | 76 | 14771 | 95 |
| 14381 | 173 | 14471 | 149,230 | 14571 | 164 | 14685 | 76 | 14772 | 95 |
| 14382 | 178,214 | 14472 | 149,230 | 14572 | 164 | 14687 | 76 | 14773 | 95 |
| 14384 | 178,214 | 14473 | 149,230 | 14573 | 164 | 14688 | 76 | 14774 | 84 |
| 14385 | 154 | 14474 | 149,230 | 14574 | 164 | 14694 | 149,230 | 14775 | 95 |
| 14386 | 154 | 14475 | 186 | 14577 | 190 | 14695 | 76 | 14776 | 95 |
| 14387 | 154 | 14476 | 186 | 14578 | 190 | 14696 | 78 | 14777 | 95 |
| 14388 | 154 | 14477 | 186 | 14582 | 190 | 14697 | 77 | 14778 | 95 |
| 14389 | 173 | 14478 | 186 | 14584 | 172 | 14698 | 76 | 14779 | 95 |
| 14390 | 173 | 14479 | 53 | 14585 | 190 | 14699 | 77 | 14780 | 95 |
| 14391 | 17 | 14480 | 53 | 14586 | 190 | 14700 | 77 | 14781 | 95 |
| 14392 | 17 | 14481 | 53 | 14589 | 172 | 14701 | 77 | 14782 | 95 |
| 14393 | 17 | 14482 | 53 | 14590 | 172 | 14702 | 77 | 14783 | 95 |
| 14394 | 17 | 14483 | 53 | 14591 | 172 | 14703 | 77 | 14784 | 95 |
| 14395 | 186 | 14484 | 53 | 14592 | 152 | 14704 | 77 | 14785 | 95 |
| 14396 | 186 | 14485 | 53 | 14594 | 152 | 14705 | 78 | 14786 | 95 |
| 14397 | 186 | 14486 | 53 | 14596 | 152 | 14706 | 77 | 14787 | 84 |
| 14398 | 186 | 14487 | 53 | 14598 | 152 | 14707 | 76 | 14788 | 95 |
| 14400 | 13,162 | 14488 | 53 | 14601 | 152 | 14708 | 77 | 14789 | 95 |
| 14401 | 89 | 14489 | 53 | 14602 | 68 | 14709 | 78 | 14790 | 95 |
| 14402 | 179 | 14490 | 53 | 14603 | 69 | 14710 | 67 | 14791 | 95 |
| 14403 | 89 | 14491 | 53 | 14604 | 68 | 14712 | 67 | 14792 | 95 |
| 14404 | 177 | 14492 | 70 | 14605 | 68 | 14713 | 149,230 | 14793 | 95 |
| 14406 | 177 | 14493 | 70 | 14606 | 68 | 14714 | 67 | 14794 | 95 |
| 14408 | 213,177 | 14499 | 70 | 14607 | 68 | 14715 | 77 | 14795 | 95 |
| 14410 | 177 | 14500 | 70 | 14608 | 190 | 14717 | 68 | 14796 | 88 |
| 14411 | 177 | 14501 | 70 | 14609 | 68 | 14719 | 77 | 14797 | 88 |
| 14412 | 179 | 14502 | 69 | 14610 | 68 | 14720 | 77 | 14798 | 85 |
| 14413 | 177 | 14503 | 69 | 14611 | 68 | 14721 | 77 | 14799 | 86 |
| 14414 | 177 | 14504 | 69 | 14612 | 69 | 14722 | 101 | 14800 | 85 |
| 14415 | 177 | 14505 | 69 | 14613 | 68 | 14723 | 95 | 14801 | 85 |
| 14416 | 178,214 | 14506 | 70 | 14615 | 71 | 14724 | 95 | 14802 | 82 |
| 14417 | 178,214 | 14507 | 70 | 14616 | 69 | 14725 | 95 | 14804 | 82 |
| 14418 | 178,214 | 14508 | 53 | 14617 | 67 | 14726 | 89 | 14806 | 83 |
| 14419 | 179 | 14509 | 71 | 14618 | 67 | 14727 | 89 | 14807 | 83 |
| 14420 | 178,214 | 14510 | 71 | 14619 | 67 | 14728 | 76 | 14808 | 84 |
| 14421 | 212 | 14511 | 71 | 14622 | 68 | 14729 | 76 | 14810 | 84 |
| 14422 | 212 | 14512 | 70 | 14623 | 71 | 14730 | 103 | 14812 | 84 |
| 14423 | 212 | 14513 | 53 | 14624 | 68 | 14731 | 104 | 14813 | 69 |
| 14424 | 178,213 | 14514 | 70 | 14625 | 68 | 14732 | 102,148 | 14816 | 88 |
| 14425 | 212 | 14515 | 68 | 14626 | 71 | 14733 | 95 | 14817 | 88 |
| 14426 | 181 | 14516 | 70 | 14627 | 69 | 14734 | 95 | 14818 | 85 |
| 14427 | 213 | 14517 | 68 | 14628 | 68 | 14735 | 95 | 14819 | 85 |
| 14428 | 180 | 14518 | 70 | 14629 | 164 | 14739 | 104 | 14820 | 85 |
| 14429 | 182 | 14519 | 68 | 14634 | 68 | 14739 | 104 | 14821 | 85 |
| 14429 | 182 | 14520 | 70 | 14635 | 68 | 14740 | 77 | 14822 | 85 |
| 14432 | 178,214 | 14526 | 70 | 14636 | 68 | 14741 | 77 | 14826 | 88 |
| 14433 | 91 | 14527 | 152 | 14637 | 68 | 14742 | 76 | 14827 | 181 |
| 14434 | 178,213 | 14528 | 70 | 14638 | 68 | 14743 | 103 | 14828 | 89 |
| 14435 | 178,213 | 14531 | 152 | 14639 | 68 | 14744 | 103 | 14829 | 181 |
| 14440 | 158 | 14534 | 152 | 14640 | 68 | 14745 | 103 | 14830 | 84,182 |
| 14441 | 158 | 14537 | 152 | 14641 | 68 | 14746 | 95 | 14831 | 84,182 |
| 14442 | 158 | 14541 | 159 | 14642 | 68 | 14747 | 103 | 14832 | 84,182 |
| 14443 | 158 | 14543 | 181 | 14643 | 68 | 14748 | 95 | 14833 | 95 |
| 14445 | 158 | 14544 | 181 | 14656 | 161 | 14749 | 103 | 14834 | 164 |
| 14446 | 158 | 14555 | 68 | 14657 | 161 | 14750 | 95 | 14835 | 82 |

Marshalltown EDI Number Listing

| EDI NO. | PAGE NO. | EDI NO. | PAGE NO. | EDI NO. | PAGE NO. | EDI NO. | PAGE NO. | EDI NO. | PAGE NO. |
|---------|----------|---------|----------|---------|----------|---------|----------|---------|----------|
| 14836 | 165 | 14914 | 25 | 15046 | 156 | 15186 | 20 | 15274 | 42 |
| 14837 | 82 | 14915 | 25 | 15047 | 156 | 15187 | 20 | 15275 | 41 |
| 14838 | 83 | 14917 | 158 | 15048 | 156 | 15188 | 20 | 15276 | 42 |
| 14839 | 83 | 14918 | 163 | 15049 | 156 | 15189 | 20 | 15277 | 42 |
| 14840 | 83 | 14919 | 163 | 15050 | 156 | 15190 | 21 | 15278 | 42 |
| 14841 | 88 | 14920 | 109 | 15051 | 156 | 15191 | 21 | 15279 | 41 |
| 14842 | 88 | 14921 | 109 | 15052 | 156 | 15192 | 21 | 15280 | 42 |
| 14843 | 83 | 14922 | 109 | 15064 | 157 | 15193 | 21 | 15281 | 42 |
| 14844 | 28,147 | 14926 | 192 | 15065 | 157 | 15194 | 21 | 15282 | 42 |
| 14845 | 83 | 14929 | 192 | 15066 | 157 | 15200 | 13,162 | 15283 | 41 |
| 14846 | 83 | 14930 | 172 | 15067 | 157 | 15202 | 13,162 | 15284 | 42 |
| 14847 | 83 | 14931 | 181 | 15068 | 157 | 15203 | 13,162 | 15285 | 42 |
| 14848 | 83 | 14945 | 192 | 15069 | 157 | 15205 | 13,162 | 15286 | 42 |
| 14849 | 83 | 14946 | 219 | 15070 | 157 | 15207 | 13,162 | 15287 | 41 |
| 14850 | 96 | 14947 | 219 | 15071 | 157 | 15208 | 13,162 | 15288 | 42 |
| 14851 | 96 | 14948 | 85 | 15072 | 157 | 15209 | 13,162 | 15289 | 42 |
| 14852 | 96 | 14949 | 162 | 15073 | 157 | 15211 | 184 | 15290 | 41 |
| 14853 | 96 | 14956 | 102 | 15074 | 157 | 15212 | 13,162 | 15291 | 42 |
| 14854 | 96 | 14957 | 110 | 15075 | 157 | 15215 | 13,162 | 15292 | 42 |
| 14855 | 96 | 14958 | 110 | 15076 | 157 | 15216 | 13,162 | 15293 | 50 |
| 14856 | 96 | 14959 | 110 | 15077 | 157 | 15217 | 13,162 | 15294 | 50 |
| 14857 | 96 | 14960 | 110 | 15078 | 157 | 15218 | 13,162 | 15295 | 50 |
| 14858 | 96 | 14961 | 72 | 15079 | 157 | 15219 | 13,162 | 15296 | 50 |
| 14859 | 96 | 14962 | 72 | 15080 | 157 | 15220 | 13,162 | 15297 | 50 |
| 14860 | 96 | 14963 | 72 | 15081 | 157 | 15221 | 13,162 | 15298 | 50 |
| 14861 | 96 | 14964 | 72 | 15082 | 157 | 15222 | 13,163 | 15299 | 51 |
| 14862 | 96 | 14969 | 72 | 15083 | 157 | 15228 | 224 | 15300 | 51 |
| 14863 | 96 | 14970 | 72 | 15084 | 157 | 15229 | 224 | 15301 | 51 |
| 14864 | 96 | 14971 | 72 | 15087 | 156 | 15230 | 224 | 15302 | 51 |
| 14865 | 96 | 14972 | 72 | 15096 | 28 | 15231 | 224 | 15303 | 49 |
| 14866 | 96 | 14973 | 72,73,74 | 15100 | 83 | 15232 | 224 | 15304 | 49 |
| 14867 | 96 | 14974 | 72,73,74 | 15101 | 83 | 15234 | 224 | 15305 | 49 |
| 14868 | 96 | 14975 | 72,73,74 | 15102 | 83 | 15235 | 224 | 15306 | 49 |
| 14869 | 96 | 14976 | 72 | 15103 | 83 | 15236 | 224 | 15307 | 49 |
| 14870 | 96 | 14977 | 72 | 15104 | 83 | 15237 | 224 | 15308 | 49 |
| 14875 | 185 | 14978 | 72 | 15137 | 60 | 15238 | 224 | 15309 | 43 |
| 14876 | 185 | 14979 | 72 | 15138 | 60 | 15239 | 224 | 15310 | 43 |
| 14877 | 185 | 14984 | 72 | 15139 | 60 | 15240 | 176 | 15311 | 43 |
| 14878 | 185 | 14985 | 72 | 15140 | 59 | 15241 | 176 | 15312 | 43 |
| 14879 | 185 | 14986 | 72 | 15141 | 60 | 15244 | 191 | 15313 | 151 |
| 14880 | 185 | 14987 | 72 | 15142 | 60 | 15245 | 217 | 15314 | 151 |
| 14881 | 185 | 14988 | 72 | 15143 | 59 | 15246 | 249 | 15315 | 151 |
| 14882 | 185 | 14989 | 72 | 15144 | 59 | 15247 | 212 | 15316 | 151 |
| 14883 | 185 | 14994 | 79 | 15145 | 60 | 15249 | 224 | 15317 | 151 |
| 14884 | 185 | 14995 | 79 | 15146 | 60 | 15250 | 224 | 15318 | 151 |
| 14885 | 185 | 14997 | 71 | 15147 | 60 | 15251 | 224 | 15319 | 151 |
| 14886 | 185 | 14998 | 24 | 15148 | 60 | 15252 | 224 | 15320 | 151 |
| 14892 | 23 | 14998 | 24 | 15149 | 60 | 15253 | 224 | 15321 | 43 |
| 14895 | 186 | 14999 | 23 | 15150 | 60 | 15254 | 88 | 15322 | 43 |
| 14896 | 186 | 15015 | 156 | 15151 | 60 | 15255 | 88 | 15323 | 158 |
| 14897 | 186 | 15016 | 156 | 15152 | 60 | 15256 | 251 | 15324 | 159 |
| 14898 | 186 | 15017 | 156 | 15153 | 60 | 15257 | 251 | 15325 | 159 |
| 14899 | 192 | 15019 | 156 | 15164 | 75 | 15258 | 251 | 15326 | 159 |
| 14900 | 192 | 15021 | 156 | 15167 | 75 | 15259 | 251 | 15327 | 159 |
| 14901 | 192 | 15022 | 156 | 15173 | 97 | 15260 | 252 | 15329 | 43 |
| 14902 | 192 | 15024 | 156 | 15174 | 97 | 15263 | 42 | 15330 | 172 |
| 14903 | 192 | 15026 | 156 | 15175 | 97 | 15264 | 42 | 15331 | 43 |
| 14904 | 192 | 15029 | 156 | 15176 | 97 | 15265 | 41 | 15332 | 43 |
| 14905 | 192 | 15030 | 156 | 15177 | 97 | 15266 | 42 | 15333 | 43 |
| 14906 | 192 | 15032 | 156 | 15178 | 97 | 15267 | 46 | 15334 | 43 |
| 14907 | 192 | 15033 | 156 | 15179 | 97 | 15268 | 46 | 15335 | 43 |
| 14908 | 25 | 15038 | 156 | 15181 | 21 | 15269 | 42 | 15336 | 51 |
| 14910 | 25 | 15039 | 156 | 15182 | 21 | 15270 | 42 | 15337 | 51 |
| 14911 | 25 | 15041 | 156 | 15183 | 21 | 15271 | 42 | 15338 | 51 |
| 14912 | 25 | 15042 | 156 | 15184 | 21 | 15272 | 41 | 15339 | 51 |
| 14913 | 25 | 15043 | 156 | 15185 | 20 | 15273 | 42 | 15340 | 51 |

Marshalltown EDI Number Listing

| EDI NO. | PAGE NO. | EDI NO. | PAGE NO. | EDI NO. | PAGE NO. | EDI NO. | PAGE NO. | EDI NO. | PAGE NO. |
|---------|----------|---------|----------|---------|----------|---------|----------|---------|----------|
| 15341 | 51 | 15509 | 221 | 15600 | 216 | 15729 | 207 | 15814 | 211 |
| 15342 | 51 | 15510 | 221 | 15601 | 78 | 15730 | 207 | 15815 | 209 |
| 15343 | 51 | 15511 | 82 | 15604 | 216 | 15731 | 207 | 15816 | 211 |
| 15344 | 42 | 15512 | 82 | 15605 | 216 | 15732 | 207 | 15818 | 229 |
| 15345 | 41 | 15513 | 82 | 15606 | 216 | 15733 | 207 | 15820 | 207,229 |
| 15346 | 42 | 15514 | 82 | 15607 | 216 | 15734 | 207 | 15822 | 229 |
| 15347 | 41 | 15515 | 216 | 15624 | 78 | 15735 | 207 | 15824 | 208 |
| 15349 | 102 | 15516 | 216 | 15625 | 78 | 15739 | 207 | 15826 | 208 |
| 15350 | 217 | 15517 | 216 | 15626 | 78 | 15740 | 184 | 15828 | 208 |
| 15356 | 218 | 15518 | 211 | 15627 | 78 | 15741 | 184 | 15830 | 208 |
| 15357 | 218 | 15519 | 211 | 15628 | 78 | 15742 | 183 | 15836 | 208 |
| 15358 | 218 | 15522 | 15 | 15629 | 78 | 15744 | 233 | 15837 | 208 |
| 15375 | 216 | 15523 | 15 | 15648 | 78 | 15745 | 233 | 15838 | 208 |
| 15379 | 216 | 15524 | 15 | 15650 | 183 | 15746 | 208 | 15840 | 207 |
| 15380 | 221 | 15525 | 15 | 15668 | 16 | 15747 | 208 | 15842 | 207 |
| 15381 | 221 | 15526 | 15 | 15669 | 209 | 15748 | 233 | 15848 | 207 |
| 15382 | 221 | 15528 | 15 | 15670 | 209 | 15749 | 233 | 15850 | 207 |
| 15383 | 221 | 15529 | 16 | 15671 | 209 | 15753 | 208 | 15852 | 210 |
| 15384 | 222 | 15530 | 16 | 15672 | 209 | 15754 | 185 | 15853 | 210 |
| 15385 | 222 | 15532 | 16 | 15673 | 209 | 15755 | 185 | 15854 | 210 |
| 15386 | 222 | 15533 | 50 | 15674 | 209 | 15756 | 185 | 15855 | 209 |
| 15388 | 222 | 15534 | 50 | 15675 | 209 | 15757 | 207 | 15856 | 209 |
| 15389 | 222 | 15536 | 23 | 15676 | 209 | 15758 | 185 | 15857 | 209 |
| 15390 | 222 | 15537 | 23 | 15677 | 209 | 15759 | 185 | 15858 | 209 |
| 15393 | 218 | 15538 | 84 | 15678 | 209 | 15760 | 185 | 15859 | 209 |
| 15394 | 218 | 15539 | 84 | 15679 | 209 | 15761 | 207 | 15860 | 209 |
| 15396 | 221 | 15544 | 18 | 15680 | 209 | 15762 | 185 | 15861 | 209 |
| 15397 | 221 | 15545 | 224 | 15681 | 209 | 15763 | 207 | 15862 | 209 |
| 15411 | 224 | 15546 | 224 | 15682 | 209 | 15764 | 185 | 15863 | 210 |
| 15422 | 238 | 15547 | 224 | 15683 | 209 | 15767 | 231 | 15864 | 210 |
| 15423 | 238 | 15548 | 224 | 15684 | 209 | 15768 | 231 | 15865 | 210 |
| 15424 | 239 | 15549 | 63 | 15685 | 209 | 15769 | 231 | 15871 | 98 |
| 15426 | 239 | 15550 | 15 | 15686 | 209 | 15770 | 207 | 15875 | 208 |
| 15430 | 225 | 15551 | 65 | 15687 | 209 | 15771 | 207 | 15877 | 208 |
| 15434 | 225 | 15552 | 15 | 15688 | 209 | 15772 | 229 | 15879 | 208 |
| 15438 | 227 | 15553 | 65 | 15689 | 209 | 15773 | 229 | 15881 | 208 |
| 15439 | 227 | 15554 | 15 | 15690 | 209 | 15774 | 229 | 15883 | 208 |
| 15440 | 227 | 15555 | 65 | 15691 | 209 | 15775 | 207,229 | 15885 | 208 |
| 15445 | 164 | 15556 | 15 | 15692 | 209 | 15776 | 207 | 15887 | 208 |
| 15449 | 217 | 15557 | 65 | 15693 | 209 | 15777 | 229 | 15889 | 208 |
| 15465 | 221 | 15558 | 14 | 15694 | 209 | 15778 | 229 | 15891 | 208 |
| 15468 | 214 | 15559 | 65 | 15695 | 209 | 15779 | 207,229 | 15892 | 210 |
| 15469 | 214 | 15560 | 14 | 15696 | 209 | 15780 | 207 | 15893 | 210 |
| 15470 | 221 | 15561 | 215 | 15697 | 209 | 15781 | 207 | 15894 | 210 |
| 15473 | 225 | 15562 | 14 | 15698 | 209 | 15782 | 207 | 15895 | 210 |
| 15479 | 224 | 15564 | 14 | 15699 | 209 | 15783 | 229 | 15896 | 210 |
| 15480 | 224 | 15566 | 14 | 15701 | 184 | 15784 | 229 | 15897 | 210 |
| 15483 | 224 | 15568 | 14 | 15702 | 207 | 15785 | 229 | 15898 | 210 |
| 15484 | 224 | 15569 | 216 | 15704 | 207 | 15786 | 231 | 15899 | 210 |
| 15487 | 224 | 15570 | 216 | 15705 | 207 | 15787 | 231 | 15900 | 210 |
| 15488 | 224 | 15571 | 216 | 15706 | 207 | 15788 | 231 | 15901 | 30 |
| 15489 | 224 | 15575 | 216 | 15708 | 207 | 15793 | 209 | 15902 | 117 |
| 15490 | 224 | 15576 | 216 | 15709 | 207 | 15794 | 209 | 15903 | 202 |
| 15492 | 216 | 15578 | 216 | 15710 | 207 | 15796 | 231 | 15956 | 252 |
| 15493 | 216 | 15579 | 216 | 15711 | 207 | 15798 | 231 | 15980 | 252 |
| 15494 | 216 | 15580 | 216 | 15712 | 207 | 15800 | 207 | 15981 | 251 |
| 15495 | 227 | 15581 | 216 | 15713 | 207 | 15802 | 207 | 15982 | 251 |
| 15496 | 221 | 15582 | 216 | 15714 | 207 | 15803 | 209 | 15983 | 251 |
| 15497 | 221 | 15584 | 216 | 15716 | 207 | 15804 | 207,229 | 15984 | 252 |
| 15502 | 16 | 15586 | 216 | 15717 | 207 | 15805 | 209 | 15985 | 252 |
| 15503 | 221 | 15587 | 216 | 15720 | 207 | 15806 | 207 | 15986 | 252 |
| 15504 | 221 | 15588 | 216 | 15721 | 207 | 15808 | 207 | 15987 | 252 |
| 15505 | 221 | 15592 | 216 | 15722 | 207 | 15810 | 211 | 16007 | 227 |
| 15506 | 221 | 15593 | 216 | 15724 | 207 | 15811 | 209 | 16008 | 227 |
| 15507 | 221 | 15596 | 216 | 15725 | 207 | 15812 | 211 | 16016 | 252 |
| 15508 | 221 | 15599 | 216 | 15728 | 207 | 15813 | 209 | 16017 | 252 |

Marshalltown EDI Number Listing

| EDI NO. | PAGE NO. | EDI NO. | PAGE NO. | EDI NO. | PAGE NO. | EDI NO. | PAGE NO. | EDI NO. | PAGE NO. |
|---------|----------|---------|----------|---------|----------|---------|------------|---------|----------|
| 16019 | 104 | 16126 | 9 | 16239 | 211 | 16355 | 191 | 16463 | 214 |
| 16023 | 252 | 16127 | 215 | 16240 | 211 | 16356 | 190 | 16465 | 214 |
| 16024 | 171 | 16128 | 173 | 16245 | 47 | 16359 | 189,190 | 16466 | 214 |
| 16025 | 171 | 16129 | 14 | 16247 | 89 | 16369 | 188 | 16467 | 183 |
| 16026 | 104 | 16130 | 14 | 16248 | 89 | 16371 | 163 | 16468 | 183 |
| 16031 | 9 | 16131 | 15 | 16249 | 89 | 16372 | 164 | 16470 | 193 |
| 16034 | 188 | 16132 | 26 | 16250 | 211 | 16373 | 190 | 16471 | 193 |
| 16036 | 186 | 16136 | 153 | 16251 | 211 | 16374 | 191 | 16472 | 193 |
| 16037 | 186 | 16137 | 153 | 16252 | 211 | 16375 | 170 | 16475 | 193 |
| 16038 | 186 | 16140 | 196 | 16253 | 47 | 16376 | 170 | 16476 | 193 |
| 16039 | 186 | 16143 | 153 | 16254 | 211 | 16377 | 188 | 16477 | 193 |
| 16040 | 160 | 16144 | 153 | 16255 | 211 | 16378 | 188 | 16478 | 193 |
| 16041 | 160 | 16157 | 181 | 16256 | 211 | 16380 | 176 | 16479 | 193 |
| 16042 | 160 | 16158 | 180 | 16257 | 211 | 16383 | 235 | 16480 | 193 |
| 16043 | 160 | 16168 | 210 | 16258 | 211 | 16384 | 235 | 16481 | 193 |
| 16044 | 160 | 16171 | 210 | 16259 | 211 | 16385 | 177 | 16482 | 193 |
| 16046 | 138 | 16172 | 210 | 16260 | 210 | 16389 | 163 | 16485 | 193 |
| 16047 | 138 | 16173 | 210 | 16261 | 210 | 16390 | 161 | 16486 | 193 |
| 16048 | 138 | 16174 | 182 | 16262 | 210 | 16392 | 161 | 16487 | 193 |
| 16049 | 22 | 16175 | 210 | 16263 | 210 | 16393 | 161 | 16488 | 193 |
| 16050 | 153 | 16176 | 182 | 16265 | 47 | 16394 | 161 | 16489 | 193 |
| 16051 | 153 | 16177 | 210 | 16266 | 212 | 16395 | 160,161 | 16490 | 193 |
| 16052 | 153 | 16178 | 210 | 16267 | 158 | 16396 | 160,161 | 16491 | 64 |
| 16053 | 153 | 16179 | 210 | 16268 | 158 | 16397 | 160,161 | 16492 | 56 |
| 16054 | 153 | 16186 | 139 | 16269 | 158 | 16398 | 30,222,197 | 16493 | 175 |
| 16055 | 153 | 16191 | 86 | 16270 | 158 | 16399 | 30,222,197 | 16494 | 193 |
| 16060 | 26 | 16192 | 22,117 | 16271 | 154 | 16403 | 172 | 16495 | 193 |
| 16062 | 151 | 16193 | 16 | 16272 | 154 | 16404 | 171 | 16496 | 193 |
| 16063 | 151 | 16194 | 22,117 | 16273 | 154 | 16405 | 171 | 16499 | 27 |
| 16064 | 151 | 16195 | 10 | 16274 | 210 | 16406 | 171 | 16500 | 27 |
| 16065 | 151 | 16196 | 9 | 16275 | 210 | 16407 | 171 | 16501 | 27 |
| 16066 | 26 | 16197 | 11 | 16280 | 11 | 16410 | 226,244 | 16502 | 27 |
| 16067 | 26 | 16198 | 14 | 16282 | 11 | 16411 | 226,244 | 16503 | 27 |
| 16068 | 218 | 16200 | 11 | 16286 | 211 | 16412 | 226,244 | 16504 | 27 |
| 16069 | 218 | 16201 | 246 | 16287 | 211 | 16416 | 99 | 16506 | 27 |
| 16070 | 238 | 16202 | 246 | 16290 | 199 | 16417 | 99 | 16507 | 27 |
| 16071 | 238 | 16203 | 246 | 16292 | 159 | 16419 | 99 | 16508 | 27 |
| 16072 | 238 | 16204 | 30 | 16294 | 161 | 16420 | 97 | 16509 | 27 |
| 16074 | 238 | 16205 | 117 | 16296 | 203 | 16422 | 101 | 16510 | 22 |
| 16075 | 238 | 16206 | 203 | 16298 | 203 | 16423 | 97 | 16512 | 99 |
| 16076 | 238 | 16207 | 82 | 16299 | 188 | 16424 | 97 | 16513 | 99 |
| 16077 | 238 | 16208 | 82 | 16301 | 184 | 16425 | 97 | 16514 | 99 |
| 16078 | 252 | 16209 | 82 | 16302 | 184 | 16426 | 173 | 16515 | 97 |
| 16079 | 195 | 16210 | 82 | 16303 | 184 | 16428 | 97 | 16516 | 97 |
| 16090 | 233 | 16211 | 82 | 16307 | 188 | 16429 | 177 | 16517 | 29 |
| 16091 | 233 | 16212 | 82 | 16308 | 188 | 16431 | 246 | 16518 | 200 |
| 16092 | 233 | 16213 | 82 | 16309 | 188 | 16433 | 177 | 16519 | 29 |
| 16093 | 233 | 16214 | 82 | 16315 | 193 | 16435 | 176 | 16520 | 29 |
| 16097 | 180 | 16215 | 82 | 16316 | 193 | 16438 | 141 | 16521 | 29 |
| 16098 | 180 | 16216 | 81 | 16317 | 193 | 16439 | 141 | 16522 | 29 |
| 16099 | 180 | 16217 | 81 | 16318 | 193 | 16440 | 22,117,221 | 16523 | 29 |
| 16101 | 180 | 16218 | 81 | 16320 | 180 | 16441 | 22,117,221 | 16524 | 29 |
| 16102 | 158 | 16219 | 81 | 16322 | 173 | 16442 | 98 | 16525 | 29 |
| 16104 | 158 | 16220 | 211 | 16324 | 173 | 16443 | 98 | 16526 | 28 |
| 16105 | 158 | 16222 | 22 | 16327 | 175 | 16450 | 226,244 | 16527 | 28 |
| 16111 | 159 | 16223 | 22 | 16328 | 175 | 16451 | 101 | 16528 | 29 |
| 16114 | 161 | 16224 | 19 | 16330 | 175 | 16452 | 173 | 16529 | 29 |
| 16116 | 182 | 16226 | 19 | 16331 | 171 | 16453 | 30,222,197 | 16530 | 23 |
| 16118 | 176 | 16228 | 171 | 16332 | 186 | 16454 | 30,222,197 | 16531 | 221 |
| 16119 | 182 | 16229 | 191 | 16333 | 175 | 16455 | 101 | 16532 | 23 |
| 16120 | 173 | 16230 | 101 | 16336 | 163 | 16457 | 170 | 16533 | 22,221 |
| 16121 | 182 | 16232 | 101 | 16338 | 176 | 16458 | 170 | 16535 | 22,221 |
| 16122 | 15 | 16233 | 11 | 16343 | 97 | 16459 | 101 | 16536 | 23 |
| 16123 | 15 | 16234 | 211 | 16344 | 186 | 16460 | 214 | 16537 | 22,221 |
| 16124 | 12 | 16236 | 211 | 16348 | 186 | 16461 | 214 | 16541 | 20 |
| 16125 | 10 | 16238 | 211 | 16354 | 186 | 16462 | 214 | 16543 | 20 |

Marshalltown EDI Number Listing

| EDI NO. | PAGE NO. | EDI NO. | PAGE NO. | EDI NO. | PAGE NO. | EDI NO. | PAGE NO. | EDI NO. | PAGE NO. |
|---------|----------|---------|----------|---------|----------|---------|----------|---------|----------|
| 16544 | 21 | 16645 | 28 | 16834 | 48 | 16904 | 77 | 17332 | 247 |
| 16545 | 22,221 | 16646 | 28 | 16835 | 48 | 16905 | 91 | 17333 | 247 |
| 16547 | 22,221 | 16647 | 28 | 16836 | 48 | 16906 | 91 | 17334 | 247 |
| 16548 | 17 | 16648 | 28 | 16837 | 48 | 16940 | 12 | 17335 | 247 |
| 16549 | 17 | 16649 | 200 | 16838 | 100 | 16941 | 12 | 17336 | 113 |
| 16554 | 24,238 | 16650 | 27 | 16839 | 100 | 16942 | 12 | 17337 | 247 |
| 16555 | 28,234 | 16651 | 243 | 16840 | 100 | 16943 | 12 | 17338 | 247 |
| 16556 | 28,234 | 16654 | 243 | 16841 | 100 | 16944 | 12 | 17339 | 252 |
| 16559 | 18 | 16657 | 201 | 16842 | 100 | 16945 | 12 | 17340 | 113 |
| 16560 | 18 | 16658 | 193 | 16843 | 100 | 16946 | 12 | 17341 | 113 |
| 16561 | 17 | 16659 | 193 | 16844 | 100 | 16947 | 12 | 17342 | 113 |
| 16562 | 17 | 16661 | 18 | 16845 | 100 | 16948 | 12 | 17343 | 113 |
| 16563 | 17 | 16666 | 18 | 16846 | 100 | 16949 | 12 | 17344 | 113 |
| 16564 | 17 | 16668 | 18 | 16847 | 100 | 16950 | 12 | 17345 | 110 |
| 16567 | 17 | 16669 | 18 | 16848 | 100 | 16951 | 12 | 17346 | 110 |
| 16568 | 17 | 16673 | 18 | 16849 | 100 | 16952 | 211 | 17347 | 248 |
| 16569 | 188 | 16674 | 18 | 16850 | 100 | 16953 | 211 | 17349 | 113 |
| 16570 | 26 | 16676 | 193 | 16851 | 100 | 16954 | 211 | 17350 | 112 |
| 16571 | 26 | 16678 | 193 | 16852 | 100 | 16955 | 211 | 17351 | 112 |
| 16572 | 25 | 16680 | 193 | 16853 | 100 | 16956 | 211 | 17352 | 113 |
| 16573 | 25 | 16682 | 193 | 16854 | 100 | 16957 | 66 | 17353 | 112 |
| 16574 | 25 | 16684 | 193 | 16855 | 100 | 16958 | 66 | 17354 | 112 |
| 16575 | 25 | 16686 | 193 | 16856 | 100 | 16959 | 66 | 17358 | 112 |
| 16576 | 25 | 16688 | 193 | 16857 | 100 | 16960 | 66 | 17359 | 112 |
| 16577 | 25 | 16690 | 193 | 16858 | 100 | 16961 | 66 | 17360 | 113 |
| 16578 | 25 | 16692 | 193 | 16859 | 100 | 16982 | 98 | 17361 | 112 |
| 16579 | 173 | 16694 | 176 | 16860 | 100 | 16983 | 98 | 17362 | 112 |
| 16581 | 25 | 16696 | 193 | 16861 | 100 | 16984 | 98 | 17363 | 113 |
| 16582 | 25 | 16698 | 193 | 16862 | 165 | 16985 | 98 | 17367 | 113 |
| 16584 | 26 | 16700 | 193 | 16863 | 165 | 16986 | 98 | 17368 | 113 |
| 16585 | 183 | 16710 | 221 | 16865 | 177 | 16987 | 98 | 17371 | 113 |
| 16586 | 26 | 16712 | 221 | 16866 | 177 | 16988 | 107 | 17372 | 113 |
| 16587 | 30,214 | 16714 | 221 | 16867 | 90 | 17014 | 252 | 17376 | 112 |
| 16588 | 26 | 16720 | 217 | 16868 | 90 | 17230 | 113 | 17377 | 107 |
| 16589 | 182 | 16723 | 217 | 16869 | 90 | 17236 | 113 | 17379 | 107 |
| 16590 | 182 | 16724 | 217 | 16870 | 90 | 17244 | 113 | 17380 | 217 |
| 16591 | 182 | 16746 | 69 | 16871 | 90 | 17258 | 71 | 17381 | 217 |
| 16592 | 182 | 16747 | 69 | 16872 | 45 | 17259 | 71 | 17382 | 217 |
| 16593 | 182 | 16748 | 197 | 16873 | 45 | 17260 | 71 | 17383 | 217 |
| 16595 | 102 | 16791 | 213 | 16874 | 45 | 17264 | 71 | 17384 | 217 |
| 16596 | 97 | 16793 | 213 | 16875 | 45 | 17265 | 71 | 17385 | 217 |
| 16597 | 97 | 16794 | 213 | 16876 | 77 | 17266 | 71 | 17386 | 217 |
| 16598 | 97 | 16796 | 213 | 16877 | 77 | 17300 | 75 | 17387 | 217 |
| 16599 | 97 | 16797 | 213 | 16878 | 77 | 17301 | 75 | 17388 | 217 |
| 16600 | 97 | 16801 | 70 | 16879 | 77 | 17302 | 75 | 17389 | 217 |
| 16601 | 98 | 16803 | 70 | 16880 | 77 | 17303 | 223,242 | 17390 | 75 |
| 16606 | 21 | 16806 | 70 | 16883 | 77 | 17304 | 63 | 17391 | 75 |
| 16607 | 21 | 16807 | 70 | 16884 | 77 | 17306 | 249 | 17392 | 75 |
| 16608 | 21 | 16809 | 70 | 16885 | 77 | 17307 | 246 | 17393 | 75 |
| 16611 | 117 | 16811 | 70 | 16886 | 77 | 17308 | 246 | 17394 | 75 |
| 16614 | 21 | 16813 | 70 | 16887 | 77 | 17309 | 246 | 17395 | 75 |
| 16615 | 21 | 16815 | 70 | 16888 | 77 | 17310 | 246 | 17396 | 75 |
| 16616 | 21 | 16817 | 70 | 16889 | 77 | 17311 | 246 | 17397 | 75 |
| 16617 | 20 | 16818 | 70 | 16890 | 77 | 17312 | 246 | 17398 | 75 |
| 16618 | 20 | 16819 | 70 | 16891 | 77 | 17313 | 248 | 17399 | 75 |
| 16619 | 20 | 16821 | 71 | 16892 | 77 | 17314 | 248 | 17407 | 112 |
| 16620 | 117 | 16823 | 71 | 16893 | 77 | 17315 | 248 | 17408 | 112 |
| 16621 | 117 | 16824 | 71 | 16894 | 77 | 17316 | 248 | 17409 | 112 |
| 16623 | 98 | 16825 | 71 | 16895 | 77 | 17317 | 248 | 17410 | 112 |
| 16624 | 98 | 16826 | 48 | 16896 | 77 | 17318 | 248 | 17411 | 112 |
| 16626 | 98 | 16827 | 48 | 16897 | 77 | 17319 | 247 | 17412 | 112 |
| 16627 | 98 | 16828 | 48 | 16898 | 77 | 17320 | 247 | 17413 | 112 |
| 16628 | 175 | 16829 | 48 | 16899 | 77 | 17321 | 247 | 17414 | 112 |
| 16629 | 98 | 16830 | 48 | 16900 | 77 | 17322 | 247 | 17415 | 112 |
| 16630 | 98 | 16831 | 48 | 16901 | 77 | 17323 | 247 | 17416 | 112 |
| 16631 | 98 | 16832 | 48 | 16902 | 77 | 17324 | 247 | 17417 | 112 |
| 16634 | 190 | 16833 | 48 | 16903 | 77 | 17330 | 113 | 17425 | 248 |

Marshalltown EDI Number Listing

| EDI NO. | PAGE NO. | EDI NO. | PAGE NO. | EDI NO. | PAGE NO. | EDI NO. | PAGE NO. | EDI NO. | PAGE NO. |
|---------|----------|---------|----------|---------|----------|---------|----------|---------|----------|
| 17426 | 248 | 17821 | 246 | 17991 | 123 | 18064 | 248 | 18149 | 135 |
| 17427 | 248 | 17822 | 246 | 17992 | 123 | 18065 | 248 | 18150 | 135 |
| 17428 | 248 | 17823 | 246 | 17993 | 123 | 18078 | 120 | 18151 | 135 |
| 17430 | 113 | 17824 | 246 | 17994 | 123 | 18079 | 120 | 18152 | 135 |
| 17431 | 247 | 17825 | 246 | 17995 | 125 | 18080 | 120 | 18153 | 135 |
| 17432 | 247 | 17839 | 245 | 17996 | 125 | 18081 | 120 | 18154 | 135 |
| 17433 | 247 | 17840 | 250 | 17997 | 125 | 18082 | 120 | 18155 | 135 |
| 17434 | 247 | 17867 | 248 | 17998 | 125 | 18083 | 120 | 18156 | 135 |
| 17435 | 247 | 17868 | 248 | 17999 | 123 | 18084 | 121 | 18157 | 135 |
| 17436 | 113 | 17869 | 248 | 18000 | 123 | 18085 | 121 | 18158 | 135 |
| 17437 | 247 | 17870 | 248 | 18001 | 133,134 | 18086 | 121 | 18159 | 135 |
| 17438 | 247 | 17871 | 248 | 18002 | 132 | 18087 | 121 | 18160 | 135 |
| 17439 | 247 | 17872 | 248 | 18003 | 130 | 18088 | 121 | 18161 | 135 |
| 17440 | 247 | 17873 | 248 | 18004 | 131 | 18089 | 121 | 18162 | 135 |
| 17441 | 246 | 17874 | 248 | 18005 | 131 | 18090 | 119 | 18163 | 135 |
| 17442 | 246 | 17875 | 248 | 18006 | 131 | 18091 | 119 | 18164 | 135 |
| 17443 | 246 | 17876 | 248 | 18007 | 131 | 18092 | 119 | 18165 | 135 |
| 17444 | 113 | 17877 | 248 | 18008 | 131 | 18093 | 119 | 18166 | 135 |
| 17445 | 113 | 17878 | 248 | 18009 | 131 | 18094 | 119 | 18167 | 135 |
| 17446 | 113 | 17886 | 248 | 18010 | 131 | 18095 | 119 | 18168 | 135 |
| 17447 | 113 | 17887 | 248 | 18011 | 131 | 18096 | 119 | 18169 | 135 |
| 17448 | 246 | 17888 | 248 | 18012 | 131 | 18097 | 119 | 18170 | 135 |
| 17471 | 220 | 17889 | 248 | 18013 | 131 | 18098 | 119 | 18171 | 135 |
| 17472 | 220 | 17890 | 248 | 18014 | 131 | 18099 | 119 | 18172 | 135 |
| 17473 | 198 | 17892 | 248 | 18015 | 131 | 18100 | 119 | 18173 | 135 |
| 17474 | 198 | 17893 | 248 | 18016 | 131 | 18101 | 119 | 18174 | 135 |
| 17475 | 198 | 17894 | 248 | 18017 | 131 | 18102 | 119 | 18175 | 135 |
| 17476 | 198 | 17895 | 248 | 18018 | 131 | 18103 | 119 | 18176 | 135 |
| 17497 | 252 | 17896 | 248 | 18019 | 131 | 18104 | 119 | 18177 | 135 |
| 17500 | 251 | 17897 | 249 | 18020 | 129 | 18105 | 119 | 18178 | 135 |
| 17536 | 113 | 17898 | 249 | 18021 | 129 | 18106 | 119 | 18179 | 135 |
| 17544 | 113 | 17899 | 249 | 18022 | 129 | 18107 | 119 | 18180 | 135 |
| 17545 | 67 | 17900 | 249 | 18023 | 129 | 18108 | 120 | 18181 | 135 |
| 17546 | 67 | 17901 | 249 | 18024 | 129 | 18109 | 120 | 18182 | 135 |
| 17547 | 67 | 17902 | 249 | 18025 | 129 | 18110 | 120 | 18183 | 135 |
| 17550 | 67 | 17903 | 249 | 18026 | 129 | 18111 | 120 | 18184 | 135 |
| 17551 | 67 | 17904 | 249 | 18027 | 129 | 18112 | 121 | 18185 | 135 |
| 17552 | 67 | 17905 | 249 | 18028 | 129 | 18113 | 121 | 18186 | 135 |
| 17553 | 67 | 17906 | 249 | 18029 | 129 | 18114 | 121 | 18187 | 135 |
| 17554 | 67 | 17907 | 249 | 18030 | 129 | 18115 | 121 | 18188 | 135 |
| 17555 | 67 | 17908 | 249 | 18031 | 129 | 18116 | 122 | 18189 | 135 |
| 17556 | 67 | 17909 | 249 | 18032 | 129 | 18117 | 122 | 18190 | 135 |
| 17588 | 52 | 17910 | 249 | 18033 | 129 | 18118 | 122 | 18191 | 135 |
| 17589 | 52 | 17911 | 249 | 18034 | 129 | 18119 | 122 | 18192 | 135 |
| 17590 | 52 | 17912 | 249 | 18035 | 129 | 18120 | 122 | 18193 | 135 |
| 17591 | 52 | 17913 | 249 | 18036 | 129 | 18121 | 122 | 18194 | 135 |
| 17592 | 57 | 17914 | 249 | 18037 | 129 | 18122 | 121 | 18195 | 135 |
| 17593 | 57 | 17915 | 247 | 18038 | 129 | 18123 | 121 | 18196 | 136 |
| 17594 | 52 | 17916 | 247 | 18039 | 129 | 18124 | 123 | 18197 | 136 |
| 17595 | 52 | 17917 | 247 | 18040 | 129 | 18125 | 123 | 18198 | 136 |
| 17596 | 52 | 17918 | 247 | 18041 | 129 | 18126 | 123 | 18199 | 136 |
| 17597 | 52 | 17919 | 247 | 18042 | 129 | 18127 | 123 | 18200 | 136 |
| 17598 | 52 | 17920 | 247 | 18043 | 129 | 18128 | 122 | 18201 | 136 |
| 17599 | 52 | 17927 | 12 | 18044 | 129 | 18129 | 122 | 18202 | 136 |
| 17600 | 52 | 17935 | 209 | 18045 | 129 | 18130 | 122 | 18203 | 136 |
| 17636 | 113 | 17936 | 209 | 18046 | 129 | 18131 | 122 | 18204 | 136 |
| 17644 | 113 | 17937 | 209 | 18047 | 129 | 18132 | 122 | 18205 | 136 |
| 17710 | 117 | 17938 | 209 | 18048 | 129 | 18133 | 122 | 18206 | 136 |
| 17800 | 221 | 17982 | 121 | 18049 | 129 | 18134 | 122 | 18207 | 136 |
| 17802 | 221 | 17983 | 121 | 18050 | 129 | 18135 | 122 | 18208 | 136 |
| 17813 | 219 | 17984 | 121 | 18051 | 129 | 18136 | 122 | 18209 | 136 |
| 17815 | 224 | 17985 | 121 | 18052 | 137 | 18137 | 122 | 18210 | 136 |
| 17816 | 18 | 17986 | 121 | 18053 | 137 | 18138 | 122 | 18211 | 136 |
| 17817 | 17 | 17987 | 120 | 18054 | 129 | 18139 | 122 | 18212 | 136 |
| 17818 | 17 | 17988 | 120 | 18055 | 129 | 18140 | 123 | 18214 | 136 |
| 17819 | 17 | 17989 | 120 | 18058 | 131 | 18141 | 123 | 18215 | 136 |
| 17820 | 246 | 17990 | 120 | 18063 | 248 | 18148 | 135 | 18216 | 136 |

Marshalltown EDI Number Listing

| EDI NO. | PAGE NO. | EDI NO. | PAGE NO. | EDI NO. | PAGE NO. | EDI NO. | PAGE NO. | EDI NO. | PAGE NO. |
|---------|----------|---------|----------|---------|----------|---------|----------|---------|----------|
| 18217 | 136 | 18289 | 119 | 18417 | 170 | 18631 | 11 | 18916 | 134 |
| 18218 | 136 | 18290 | 119 | 18418 | 170 | 18632 | 11 | 18917 | 134 |
| 18219 | 136 | 18291 | 125 | 18419 | 170 | 18633 | 10 | 18918 | 134 |
| 18220 | 136 | 18292 | 125 | 18420 | 170 | 18634 | 10 | 18919 | 134 |
| 18221 | 137 | 18293 | 125 | 18421 | 170 | 18635 | 12 | 18920 | 134 |
| 18222 | 137 | 18304 | 65 | 18422 | 170 | 18636 | 215 | 18921 | 134 |
| 18223 | 137 | 18342 | 47 | 18423 | 170 | 18637 | 14 | 18922 | 134 |
| 18224 | 137 | 18343 | 47 | 18424 | 170 | 18638 | 14 | 18923 | 134 |
| 18225 | 137 | 18344 | 47 | 18425 | 170 | 18641 | 17 | 18924 | 134 |
| 18226 | 137 | 18345 | 178 | 18426 | 170 | 18642 | 17 | 18925 | 134 |
| 18227 | 124 | 18347 | 110 | 18427 | 170 | 18643 | 17 | 18926 | 134 |
| 18228 | 122 | 18348 | 110 | 18428 | 170 | 18644 | 144 | 18927 | 134 |
| 18229 | 121 | 18349 | 109 | 18429 | 170 | 18645 | 144 | 18928 | 134 |
| 18230 | 137 | 18350 | 109 | 18430 | 170 | 18650 | 110 | 18929 | 134 |
| 18231 | 121 | 18351 | 113 | 18431 | 170 | 18651 | 110 | 18930 | 134 |
| 18232 | 137 | 18355 | 249 | 18432 | 170 | 18652 | 110 | 18931 | 134 |
| 18233 | 137 | 18359 | 222 | 18433 | 170 | 18653 | 110 | 18932 | 134 |
| 18234 | 137 | 18360 | 222 | 18434 | 170 | 18654 | 110 | 18933 | 134 |
| 18235 | 137 | 18361 | 222 | 18448 | 169 | 18655 | 110 | 18934 | 122 |
| 18236 | 137 | 18362 | 222 | 18449 | 169 | 18656 | 110 | 18935 | 122 |
| 18237 | 121 | 18363 | 222 | 18481 | 157 | 18657 | 110 | 18936 | 122 |
| 18238 | 137 | 18364 | 222 | 18482 | 157 | 18658 | 110 | 18937 | 122 |
| 18239 | 137 | 18365 | 222 | 18483 | 157 | 18659 | 110 | 18938 | 122 |
| 18240 | 121 | 18366 | 222 | 18484 | 157 | 18660 | 110 | 18939 | 122 |
| 18241 | 137 | 18367 | 222 | 18486 | 157 | 18661 | 110 | 18940 | 124 |
| 18242 | 137 | 18368 | 222 | 18487 | 157 | 18662 | 110 | 18941 | 124 |
| 18243 | 129 | 18369 | 222 | 18488 | 157 | 18663 | 110 | 18942 | 124 |
| 18244 | 129 | 18370 | 222 | 18489 | 157 | 18664 | 110 | 18943 | 124 |
| 18245 | 129 | 18371 | 93 | 18490 | 157 | 18665 | 110 | 18944 | 124 |
| 18246 | 129 | 18372 | 93 | 18492 | 157 | 18666 | 110 | 18945 | 124 |
| 18248 | 129 | 18373 | 93 | 18493 | 157 | 18706 | 71 | 18946 | 124 |
| 18249 | 137 | 18374 | 93 | 18494 | 157 | 18707 | 25,238 | 18947 | 124 |
| 18250 | 137 | 18375 | 93 | 18496 | 157 | 18708 | 25,238 | 18948 | 124 |
| 18254 | 138 | 18376 | 93 | 18498 | 157 | 18709 | 25,238 | 18949 | 124 |
| 18255 | 138 | 18377 | 93 | 18500 | 157 | 18710 | 25,238 | 18950 | 124 |
| 18257 | 132 | 18378 | 93 | 18501 | 157 | 18711 | 25,238 | 18951 | 124 |
| 18258 | 138 | 18379 | 93 | 18502 | 157 | 18712 | 25,238 | 18952 | 124 |
| 18260 | 134 | 18386 | 195 | 18503 | 157 | 18713 | 25,238 | 18953 | 124 |
| 18261 | 132 | 18387 | 109 | 18505 | 157 | 18714 | 25,238 | 18954 | 124 |
| 18262 | 132 | 18388 | 109 | 18506 | 157 | 18715 | 25,238 | 18955 | 124 |
| 18263 | 132 | 18389 | 109 | 18507 | 157 | 18716 | 25,238 | 18956 | 124 |
| 18264 | 132 | 18390 | 109 | 18509 | 157 | 18717 | 25,238 | 18957 | 124 |
| 18265 | 132 | 18391 | 109 | 18511 | 157 | 18718 | 25,238 | 18958 | 120 |
| 18266 | 132 | 18392 | 109 | 18515 | 157 | 18730 | 96 | 18959 | 120 |
| 18267 | 132 | 18393 | 109 | 18517 | 157 | 18731 | 96 | 18960 | 120 |
| 18268 | 132 | 18394 | 109 | 18518 | 157 | 18732 | 96 | 18961 | 139 |
| 18269 | 132 | 18397 | 109 | 18563 | 82 | 18733 | 96 | 18963 | 139 |
| 18270 | 132 | 18398 | 109 | 18567 | 166 | 18736 | 10 | 18965 | 216 |
| 18271 | 132 | 18399 | 109 | 18568 | 166 | 18737 | 10 | 18970 | 176 |
| 18272 | 132 | 18400 | 170 | 18569 | 166 | 18738 | 10 | 18982 | 121 |
| 18273 | 132 | 18401 | 170 | 18570 | 166 | 18795 | 78 | 18983 | 121 |
| 18274 | 132 | 18402 | 170 | 18571 | 166 | 18796 | 78 | 18984 | 121 |
| 18275 | 132 | 18403 | 170 | 18572 | 166 | 18797 | 78 | 18985 | 121 |
| 18276 | 132 | 18404 | 170 | 18573 | 166 | 18901 | 138 | 18986 | 121 |
| 18277 | 132 | 18405 | 170 | 18574 | 167 | 18902 | 138 | 18987 | 121 |
| 18278 | 132 | 18406 | 170 | 18576 | 168 | 18903 | 133 | 18988 | 123 |
| 18279 | 132 | 18407 | 170 | 18577 | 168 | 18904 | 133 | 18989 | 123 |
| 18280 | 132 | 18408 | 170 | 18578 | 168 | 18905 | 138 | 18990 | 122 |
| 18281 | 132 | 18409 | 170 | 18579 | 168 | 18906 | 138 | 18995 | 192 |
| 18282 | 132 | 18410 | 170 | 18580 | 168 | 18909 | 138 | 18996 | 192 |
| 18283 | 132 | 18411 | 170 | 18586 | 9 | 18910 | 134 | 18997 | 192 |
| 18284 | 132 | 18412 | 170 | 18587 | 9 | 18911 | 134 | 18998 | 192 |
| 18285 | 119 | 18413 | 170 | 18590 | 192 | 18912 | 134 | 18999 | 192 |
| 18286 | 119 | 18414 | 170 | 18591 | 192 | 18913 | 134 | 19000 | 192 |
| 18287 | 119 | 18415 | 170 | 18592 | 192 | 18914 | 134 | 19001 | 192 |
| 18288 | 119 | 18416 | 170 | 18630 | 11 | 18915 | 134 | 19002 | 192 |

Marshalltown EDI Number Listing

| EDI NO. | PAGE NO. | EDI NO. | PAGE NO. | EDI NO. | PAGE NO. | EDI NO. | PAGE NO. | EDI NO. | PAGE NO. |
|---------|----------|---------|----------|---------|----------|---------|----------|---------|----------|
| 19003 | 192 | 19483 | 199 | 19705 | 201 | 20195 | 74 | 20743 | 72 |
| 19004 | 192 | 19484 | 199 | 19719 | 235 | 20198 | 74 | 20744 | 72 |
| 19005 | 192 | 19529 | 201 | 19773 | 196 | 20202 | 74 | 20745 | 72 |
| 19006 | 192 | 19541 | 196 | 19774 | 196 | 20205 | 74 | 20746 | 72 |
| 19007 | 192 | 19556 | 199 | 19775 | 201 | 20208 | 74 | 20754 | 72 |
| 19008 | 192 | 19558 | 180 | 19803 | 252 | 20211 | 74 | 20757 | 72 |
| 19009 | 192 | 19560 | 200 | 19934 | 199 | 20214 | 74 | 20760 | 72 |
| 19010 | 192 | 19564 | 201 | 19939 | 199 | 20217 | 74 | 20763 | 72 |
| 19011 | 192 | 19565 | 201 | 19941 | 199 | 20353 | 75 | 20766 | 72 |
| 19012 | 192 | 19567 | 197 | 20015 | 86 | 20402 | 147 | 20769 | 72 |
| 19013 | 192 | 19568 | 197 | 20030 | 86 | 20403 | 146 | 20773 | 72 |
| 19014 | 192 | 19569 | 201 | 20037 | 86 | 20404 | 146 | 20776 | 72 |
| 19015 | 192 | 19570 | 201 | 20047 | 87 | 20411 | 97 | 21012 | 87 |
| 19034 | 160 | 19571 | 201 | 20063 | 85 | 20412 | 97 | 21013 | 87 |
| 19035 | 154 | 19590 | 237 | 20064 | 85 | 20413 | 97 | 21015 | 87 |
| 19036 | 154 | 19591 | 237 | 20066 | 85 | 20414 | 97 | 21016 | 87 |
| 19037 | 154 | 19594 | 237 | 20067 | 88 | 20419 | 99 | 21488 | 34 |
| 19038 | 154 | 19600 | 200 | 20086 | 148 | 20420 | 99 | 21491 | 34 |
| 19039 | 154 | 19602 | 200 | 20087 | 148 | 20421 | 99 | 21497 | 35 |
| 19040 | 218 | 19603 | 200 | 20092 | 140 | 20422 | 99 | 21500 | 35 |
| 19041 | 218 | 19620 | 196 | 20093 | 140 | 20423 | 99 | 21576 | 35 |
| 19044 | 225 | 19622 | 196 | 20094 | 140 | 20424 | 99 | 21684 | 33 |
| 19046 | 160 | 19625 | 196 | 20095 | 140 | 20425 | 99 | 21737 | 38 |
| 19047 | 160 | 19626 | 196 | 20096 | 140 | 20427 | 99 | 22247 | 36 |
| 19048 | 160 | 19627 | 196 | 20097 | 140 | 20428 | 99 | 22251 | 36 |
| 19049 | 160 | 19628 | 200 | 20098 | 140 | 20429 | 99 | 22256 | 37 |
| 19051 | 236 | 19629 | 200 | 20099 | 140 | 20454 | 147 | 22260 | 37 |
| 19052 | 236 | 19630 | 200 | 20100 | 140 | 20468 | 146,147 | 22261 | 37 |
| 19053 | 236 | 19631 | 200 | 20101 | 140 | 20469 | 147 | 22263 | 37 |
| 19055 | 196 | 19632 | 200 | 20102 | 140 | 20471 | 147 | 22275 | 37 |
| 19056 | 196 | 19633 | 200 | 20103 | 140 | 20472 | 147 | 22276 | 37 |
| 19057 | 201 | 19634 | 199 | 20104 | 141 | 20473 | 147 | 22277 | 37 |
| 19058 | 235 | 19635 | 199 | 20106 | 141 | 20475 | 147 | 22278 | 37 |
| 19059 | 235 | 19636 | 222,199 | 20107 | 141 | 20478 | 146 | 22281 | 35 |
| 19060 | 219 | 19657 | 182 | 20110 | 141 | 20483 | 99 | 22927 | 36 |
| 19063 | 235 | 19658 | 181 | 20127 | 103 | 20489 | 99 | 22930 | 36 |
| 19064 | 236 | 19662 | 195 | 20128 | 103 | 20499 | 99 | 23570 | 32 |
| 19069 | 235 | 19664 | 202 | 20130 | 74 | 20500 | 99 | 23572 | 32 |
| 19070 | 235 | 19665 | 202 | 20131 | 74 | 20501 | 99 | 23579 | 32 |
| 19072 | 236 | 19666 | 202 | 20132 | 74 | 20502 | 99 | 23581 | 32 |
| 19074 | 237,196 | 19667 | 202 | 20133 | 74 | 20509 | 146 | 23647 | 32 |
| 19075 | 239 | 19668 | 202 | 20134 | 74 | 20510 | 146 | 23648 | 33 |
| 19083 | 252 | 19669 | 202 | 20135 | 74 | 20511 | 146 | 23684 | 33 |
| 19102 | 163 | 19670 | 202 | 20136 | 74 | 20514 | 146 | 24070 | 240 |
| 19104 | 8 | 19671 | 202 | 20137 | 74 | 20515 | 99 | 24083 | 241 |
| 19106 | 8 | 19672 | 214,202 | 20138 | 74 | 20516 | 99 | 24084 | 241 |
| 19107 | 8 | 19673 | 202 | 20139 | 74 | 20517 | 99 | 24087 | 241 |
| 19108 | 8 | 19674 | 202 | 20140 | 74 | 20518 | 99 | 24089 | 241 |
| 19111 | 69 | 19675 | 202 | 20141 | 74 | 20519 | 99 | 24096 | 240 |
| 19112 | 69 | 19676 | 214,202 | 20142 | 74 | 20520 | 99 | 24131 | 240 |
| 19114 | 51 | 19677 | 202 | 20143 | 74 | 20521 | 99 | 24164 | 240 |
| 19115 | 51 | 19678 | 202 | 20144 | 74 | 20522 | 99 | 24165 | 240 |
| 19116 | 51 | 19679 | 202 | 20145 | 74 | 20527 | 99 | 24167 | 240 |
| 19117 | 51 | 19680 | 214,202 | 20146 | 74 | 20528 | 99 | 24186 | 240 |
| 19118 | 64 | 19681 | 202 | 20147 | 74 | 20529 | 99 | 24187 | 240 |
| 19127 | 163 | 19683 | 202 | 20148 | 74 | 20530 | 99 | 24190 | 241 |
| 19128 | 163 | 19684 | 202 | 20160 | 74 | 20547 | 146 | 24191 | 241 |
| 19130 | 69 | 19685 | 202 | 20163 | 74 | 20548 | 147 | 24194 | 240 |
| 19162 | 87 | 19686 | 202 | 20166 | 74 | 20644 | 76 | 24197 | 240 |
| 19164 | 87 | 19687 | 202 | 20169 | 74 | 20645 | 76 | 24205 | 241 |
| 19166 | 87 | 19691 | 199 | 20174 | 74 | 20646 | 76 | 24206 | 241 |
| 19176 | 87 | 19692 | 199 | 20177 | 74 | 20647 | 76 | 24207 | 241 |
| 19285 | 159 | 19693 | 199 | 20180 | 74 | 20731 | 72 | 24208 | 241 |
| 19286 | 212 | 19694 | 199 | 20183 | 74 | 20733 | 72 | 24209 | 241 |
| 19287 | 179 | 19695 | 199 | 20186 | 74 | 20734 | 72 | 24221 | 239 |
| 19288 | 92 | 19696 | 199 | 20189 | 74 | 20735 | 72 | 24250 | 241 |
| 19482 | 201 | 19697 | 199 | 20192 | 74 | 20736 | 72 | 24268 | 147 |

Marshalltown EDI Number Listing

| EDI NO. | PAGE NO. | EDI NO. | PAGE NO. | EDI NO. | PAGE NO. | EDI NO. | PAGE NO. | EDI NO. | PAGE NO. |
|---------|----------|---------|-------------|---------|----------|---------|----------|---------|----------|
| 24270 | 242 | 24439 | 143 | 24993 | 91 | 25642 | 83 | 27100 | 32 |
| 24271 | 147 | 24442 | 141 | 25122 | 103 | 25697 | 144 | 27101 | 32 |
| 24285 | 242 | 24461 | 142 | 25123 | 103 | 25698 | 144 | 27110 | 33 |
| 24286 | 242 | 24462 | 144 | 25212 | 128 | 25699 | 144 | 27219 | 127 |
| 24288 | 243 | 24463 | 144 | 25213 | 128 | 25700 | 144 | 27220 | 127 |
| 24300 | 223,242 | 24464 | 144 | 25214 | 128 | 25701 | 144 | 27223 | 140 |
| 24304 | 223,242 | 24465 | 144 | 25215 | 128 | 25702 | 144 | 27224 | 142 |
| 24305 | 223,242 | 24466 | 144 | 25216 | 126,127 | 25707 | 145 | 27225 | 142 |
| 24313 | 106 | 24467 | 144 | 25219 | 127 | 25708 | 145 | 27226 | 142 |
| 24314 | 106 | 24474 | 144 | 25220 | 126,127 | 25709 | 145 | 27227 | 142 |
| 24316 | 106 | 24483 | 144 | 25221 | 127 | 25710 | 145 | 27228 | 142 |
| 24318 | 105 | 24485 | 141 | 25222 | 127 | 25713 | 145 | 27229 | 142 |
| 24324 | 105 | 24486 | 142 | 25223 | 126 | 25714 | 145 | 27230 | 142 |
| 24325 | 105 | 24487 | 143 | 25226 | 126 | 25725 | 145 | 27231 | 142 |
| 24326 | 105 | 24488 | 143 | 25227 | 126 | 25729 | 144 | 27232 | 142 |
| 24328 | 105 | 24490 | 143 | 25230 | 126 | 25730 | 144 | 27233 | 142 |
| 24332 | 105 | 24491 | 143 | 25231 | 126 | 25731 | 144 | 27234 | 142 |
| 24341 | 106 | 24492 | 143 | 25234 | 126 | 25735 | 144 | 27235 | 142 |
| 24342 | 106 | 24496 | 142 | 25235 | 126 | 25736 | 144 | 27236 | 142 |
| 24345 | 106 | 24497 | 142 | 25238 | 126 | 25737 | 144 | 27237 | 142 |
| 24347 | 105 | 24498 | 142 | 25239 | 127 | 25738 | 145 | 27238 | 142 |
| 24355 | 105 | 24501 | 143,144 | 25240 | 127 | 25739 | 145 | 27239 | 142 |
| 24356 | 105 | 24503 | 142,143,144 | 25241 | 126 | 25740 | 145 | 27240 | 32 |
| 24358 | 105 | 24504 | 142,143,144 | 25242 | 128 | 25741 | 145 | 27241 | 32 |
| 24359 | 105 | 24505 | 142,143,144 | 25243 | 128 | 25742 | 145 | 27242 | 32 |
| 24360 | 105 | 24506 | 142,143,144 | 25244 | 128 | 25743 | 145 | 27243 | 33 |
| 24364 | 106 | 24507 | 142,143,144 | 25245 | 128 | 25744 | 146 | 27244 | 33 |
| 24374 | 243 | 24508 | 142,143,144 | 25247 | 128 | 25745 | 146 | 27245 | 33 |
| 24375 | 243 | 24521 | 141 | 25249 | 127 | 25754 | 145 | 27246 | 32 |
| 24377 | 243 | 24537 | 90 | 25250 | 127 | 25755 | 145 | 27247 | 32 |
| 24378 | 243 | 24544 | 142 | 25251 | 127 | 25756 | 145 | 27248 | 32 |
| 24380 | 243 | 24545 | 142 | 25252 | 127 | 25757 | 145 | 27249 | 33 |
| 24381 | 243 | 24547 | 142 | 25253 | 127 | 25759 | 146 | 27250 | 33 |
| 24390 | 103 | 24548 | 142 | 25254 | 127 | 25760 | 146 | 27251 | 33 |
| 24392 | 103 | 24549 | 142 | 25256 | 127 | 25845 | 243 | 27252 | 33 |
| 24393 | 103 | 24550 | 142 | 25265 | 128 | 25848 | 243 | 27253 | 34 |
| 24394 | 103 | 24551 | 142 | 25266 | 128 | 25854 | 148 | 27254 | 32 |
| 24398 | 143 | 24552 | 142 | 25267 | 128 | 25855 | 148 | 27256 | 34 |
| 24399 | 143 | 24553 | 142 | 25268 | 128 | 25883 | 148 | 27257 | 34 |
| 24400 | 143 | 24554 | 142 | 25490 | 223 | 25931 | 96 | 27258 | 35 |
| 24401 | 143 | 24557 | 142 | 25491 | 223 | 25982 | 96 | 27259 | 35 |
| 24402 | 143 | 24558 | 142 | 25492 | 223 | 26031 | 96 | 27260 | 36 |
| 24403 | 143 | 24559 | 142 | 25496 | 223 | 26456 | 147 | 27261 | 36 |
| 24410 | 143 | 24560 | 142 | 25497 | 223 | 26457 | 141 | 27262 | 37 |
| 24412 | 143 | 24561 | 142 | 25500 | 223 | 26458 | 141 | 27263 | 37 |
| 24413 | 143 | 24562 | 142 | 25512 | 75 | 26591 | 141 | 27264 | 37 |
| 24414 | 143 | 24563 | 142 | 25513 | 75 | 26595 | 146 | 27265 | 37 |
| 24415 | 143 | 24564 | 142 | 25514 | 75 | 26691 | 251 | 27267 | 37 |
| 24416 | 143 | 24569 | 141 | 25517 | 75 | 26992 | 142 | 27268 | 37 |
| 24417 | 143 | 24570 | 144 | 25518 | 75 | 26993 | 142 | 27269 | 37 |
| 24418 | 143 | 24642 | 71 | 25519 | 75 | 26994 | 142 | 27270 | 37 |
| 24419 | 143 | 24643 | 71 | 25541 | 75 | 26995 | 142 | 27271 | 36 |
| 24420 | 143 | 24644 | 71 | 25542 | 75 | 26996 | 142 | 27272 | 36 |
| 24422 | 143 | 24833 | 90 | 25543 | 75 | 26997 | 142 | 27273 | 34 |
| 24424 | 143 | 24834 | 90 | 25544 | 75 | 26998 | 142 | 27274 | 35 |
| 24425 | 143 | 24835 | 90 | 25545 | 75 | 26999 | 142 | WX913 | 250 |
| 24426 | 143 | 24836 | 90 | 25577 | 75 | 27000 | 142 | WX915 | 251 |
| 24427 | 143 | 24837 | 90 | 25595 | 178 | 27001 | 142 | WX917 | 251 |
| 24428 | 143 | 24843 | 91 | 25597 | 178 | 27005 | 127 | WX927 | 250 |
| 24429 | 143 | 24844 | 91 | 25604 | 179 | 27036 | 146 | | |
| 24430 | 143 | 24845 | 91 | 25605 | 83 | 27038 | 146 | | |
| 24431 | 143 | 24847 | 91 | 25608 | 83 | 27039 | 145 | | |
| 24434 | 143 | 24849 | 90 | 25609 | 83 | 27040 | 145 | | |
| 24435 | 143 | 24857 | 90 | 25611 | 83 | 27041 | 145 | | |
| 24436 | 143 | 24860 | 90 | 25626 | 83 | 27042 | 145 | | |
| 24437 | 143 | 24915 | 89 | 25631 | 83 | 27070 | 32 | | |
| 24438 | 143 | 24992 | 144 | 25638 | 83 | 27071 | 33 | | |

Marshalltown Tool Index

A

| | |
|--------------------------|---------|
| Adapters | |
| Broom | 98 |
| Fresno | 88 |
| Funny Trowel | 88 |
| Universal Mounting Plate | 87 |
| Push Button Handle | 83-85 |
| Threaded Handle | 84-86 |
| Trowel Handle | 88 |
| Asphalt Melter | 140 |
| Asphalt Shoes | 148 |
| Asphalt Tools | 140-148 |

B

| | |
|--------------------|----------|
| Bags | |
| Bucket | 245 |
| Duffel | 245 |
| Tool, Canvas Nylon | 245-246 |
| Banding Machine | 141 |
| Belts, Tool | 243 |
| Drywall Pouch | 177 |
| Boots | 245 |
| Brackets | |
| 360° Twist Bracket | 87 |
| Bull Float | 85-86 |
| Multi-Mount Fresno | 88 |
| T-Slot Darby | 71 |
| 2-Post Clevis | 88 |
| Brick/Block Carts | 23 |
| Brick Splitter | 22 |
| Brooms | |
| Asphalt | 146-147 |
| Concrete Finishing | 97-99 |
| Flat Wire | 96 |
| Float Adapter | 97 |
| Floor | 99 |
| Seal Coating | 146-147 |
| Street | 147 |
| Finish Strip | 99 |
| Utility | 100, 239 |

| | |
|-------------------|---------|
| Brushes | |
| Acid | 28, 29 |
| Asphalt | 147 |
| Beavertail | 29 |
| Bucket | 29 |
| Curb | 98 |
| Duster | 225 |
| Felt | 177 |
| Masonry | 29 |
| Paste | 201 |
| Scrub | 28 |
| Stucco Dash | 28, 234 |
| Texture | 186 |
| Truck Washing | 239 |
| Wire | 29, 200 |
| Bucket Grit Guard | 244 |
| Bucket Heater | 227 |
| Bucket Opener | 195 |
| Bucket Scoops | 165 |
| Bullnose Cleaner | 160 |
| Bump Cutters | 73-74 |

| | |
|----------------------|---|
| Bumper, Brick Trowel | 8 |
|----------------------|---|

C

| | |
|-----------------------------|---------|
| Callus Preventer | 163 |
| Can Opener | 196 |
| Carbide Scoring Cutter | 218-219 |
| Carpet Cutter, Cushion Back | 219 |
| Carpet Stretcher, Power | 220 |
| Carpet Tools | 219-220 |
| Carriers | |
| Brick | 22 |
| Drywall | 172 |
| Chalk Boxes | 238 |
| Chalk | 239 |
| Check Rods | 72 |
| China Markers | 227 |
| Chisels | |
| Brick | 19-21 |
| Carbide Tipped | 218 |
| Concrete | 117 |
| Circle Cutters | 175 |
| Cloth | |
| Cheesecloth | 215 |
| Tack | 199 |
| Clothing | 246-249 |
| Compressor | 188 |
| Repair Parts | 188 |
| Concrete Tools | 39-139 |
| Cornerbead Tool | 177 |
| Curb Tools | 59-60 |
| Cutters | |
| Bolt | 104 |
| VCT Cutter | 217 |

D

| | |
|----------------------|----------|
| Darbies | |
| Magnesium | 71 |
| Plaster | 185 |
| Resin | 71 |
| T-Slot | 70 |
| Wood | 71 |
| Decorative Concrete | 118-139 |
| Colorant | 135 |
| Countertop | 133 |
| Hardener | 136 |
| Mats & Skins | 119-125 |
| Overlays | 132, 134 |
| Release | 137 |
| Sealant & Additives | 137-138 |
| Shoes | 139 |
| Stains | 129 |
| Texture Rollers | 126-128 |
| Touch up wheels | 127 |
| Vertical | 130-131 |
| Displays | 250-252 |
| Backer | 251 |
| Gondola | 250 |
| Hooks & Boxes | 251-252 |
| Wire Grid Display | 251 |
| Door Painting Stands | 195 |
| Drywall Cart | 172 |
| Drywall Tools | 149-203 |

| | |
|-----------|-----|
| Dust Mask | 183 |
| Dust Pans | 239 |

E

| | |
|----------------------|---------|
| Ear Plugs & Muffs | 250 |
| Edgers | |
| Hand | 52-56 |
| Bronze | 52 |
| Chamfer | 52, 53 |
| Narrow | 53 |
| Tube | 52 |
| w/groover attachment | 62 |
| Zinc | 52 |
| Safety Step | 61 |
| Walking | 56-58 |
| Bronze | 57 |
| w/groover attachment | 62 |
| EIFS Tools | 228-234 |

F

| | |
|---------------------|----------|
| Featheredge | 185 |
| File | |
| Sharpening | 199 |
| Tile | 218 |
| Floats | |
| Acrylic Angle | 179 |
| Aluminum | 77 |
| Bull | |
| Aluminum | 77 |
| Channel | 76 |
| Magnesium | 77-78 |
| Multi-groove | 78 |
| Resin | 78 |
| Wood | 78 |
| Cork | 179 |
| Epoxy | 212-213 |
| Magnesium Hand | 67-69 |
| Molded Rubber | 177, 213 |
| Neoprene | 213 |
| Plastic Foam | 178, 214 |
| Resin | 70 |
| Rubber | 177-178 |
| Sidewalk Slicker | 71 |
| Sponge | 179 |
| Tile Grouter's | 212 |
| Wall Form | 69 |
| Wood | 69 |
| Floor Board Lifter | 223 |
| Form Stakes Remover | 107 |
| Fresnos | 79-82 |

G

| | |
|----------------|-------|
| Gilson Mixers | 31-38 |
| Gliders, Blue | 82 |
| Go Devils | 185 |
| Graining Tools | 201 |
| Groovers | |
| Attachments | 67 |
| Hand | 61-65 |
| All Steel | 63 |
| Bronze | 63 |
| Chicago | 65 |
| Control Joint | 63 |

Marshalltown Tool Index

| | | |
|--------------------------------|----------------------------------|--------------------------------------|
| Rocker..... 64 | Tool Holster..... 243 | Egg Beater..... 164 |
| Grovers Continued | Hopper Guns..... 189-190 | Fan Blade..... 164 |
| Safety Step..... 62 | Cleaning Kit..... 190 | Jiffiler..... 163 |
| Texas..... 62 | Elbow Adapters..... 191 | Paint..... 164 |
| Western..... 64 | Repair Kits..... 191 | Quik-Mix..... 163 |
| Wheelchair..... 62 | Stand..... 190 | Ribbon..... 164 |
| Zinc..... 63 | J | Mortar |
| Walking..... 62-66 | Joint Raker..... 16 | Board, Box, Pan..... 23-24 |
| All Steel..... 66 | Skate Wheel..... 16 | Stand..... 24 |
| Bronze..... 65 | Jointers | Mud Mashers..... 164-165 |
| Cast Aluminum..... 66 | Acrylic..... 15 | Mud Pans..... 160-161 |
| Chicago..... 65 | Ball..... 16 | N |
| Control Joint..... 65 | Barrel..... 16 | Nippers, Tile..... 217 |
| Stealth..... 66 | Concave & Convex..... 15 | O |
| Texas..... 62 | Grapevine..... 16 | Ornamental Tools..... 184 |
| Wheelchair..... 62 | Steel..... 15 | P |
| Zinc..... 64 | K | Pails, Rubber..... 24 |
| Grout Bags..... 17-18 | Kits | Paint Brush Comb..... 196 |
| Grout Sealant Tool..... 214 | Apprentice | Panel Lifts, Drywall..... 194 |
| Grout System..... 213 | Brick..... 30 | Pans, Dust..... 100 |
| Gunite Shoes..... 139 | Concrete..... 117 | Pencil & Sharpener..... 239 |
| H | Drywall..... 202-203 | Pitchforks..... 241 |
| Hammers | DIY Drywall..... 203 | Picks & Mattocks..... 243 |
| Brick..... 18 | Finisher's Tote™..... 75 | Placers..... 89-91 |
| Claw..... 238 | Wall Repair..... 184 | Plaster Patcher..... 184 |
| Drilling..... 106 | Knee Boards..... 101 | Pot Hooks..... 196 |
| Drywall..... 176 | Knee Kicker..... 220 | Pour Pots..... 141 |
| Engineer's..... 106 | Knee Pads..... 225-226, 244 | Power Screeds..... 92-93 |
| Mash..... 105-106 | Kneeler Boards..... 101 | Power Trowels..... 108 |
| Stone Masons..... 19 | Knives | Power Trowel Blades..... 110,112-113 |
| Toothed Bush..... 19 | Break-Off & Blades..... 236-237 | Conversion Chart..... 114-116 |
| Handles | Broad..... 154 | Hardware..... 117 |
| Replacement | Carpet..... 219 | Power Trowel Pans..... 109-110 |
| Brick Trowel..... 8 | Knockdown..... 186 | Conversion Chart..... 111 |
| Finishing Trowel..... 51 | Putty & Joint..... 155-158 | Probes, Tile..... 243 |
| Float..... 69 | Razor..... 201 | Pry Bars..... 102-103 |
| Hawk..... 163 | Scratcher..... 219 | R |
| T-Slot Darby..... 71 | Taping..... 152-154 | Racatac™..... 226 |
| Poles | Triple Edge..... 199 | Rakes..... 242 |
| Adjustable..... 84, 182 | Utility & Blades..... 235 | Asphalt..... 147 |
| Fiberglass..... 83 | L | Gauge..... 138 |
| Lute..... 141-144 | Levels | Rasp |
| Push Button..... 83 | Box Beam..... 238 | Drywall..... 173 |
| Sander..... 181-182 | Crick®..... 25, 238 | EIFS/Paper..... 233 |
| Screed..... 96 | Line..... 24, 238 | Rapid Rasp™..... 233 |
| Threaded..... 82 | Lifters, Drywall..... 172 | Refinishing Tool..... 197 |
| Wood..... 28, 88-91 | Line Blocks..... 27 | Rebar Cutters/Benders |
| Hard Hat..... 250 | Line Pins..... 27 | Manual Benders..... 103 |
| Hatchet, Drywall..... 176 | Line Stretchers..... 27 | Manual Cutters/Benders..... 103 |
| Hawks | Line Twigs..... 27 | Rebar Lifters..... 102 |
| Adjustable Handle..... 13, 162 | Lutes..... 141-144 | Rock 'N' Roller™..... 126-128 |
| Aluminum..... 13, 162 | M | Rollers |
| Composite..... 13, 163 | Mallets, Rubber..... 176 | Corner..... 160 |
| Hawkmate™..... 162 | Masonry Guides..... 25 | Extension..... 227 |
| Magnesium..... 13, 162 | Masonry Tools..... 6-30 | J Style..... 227 |
| Hoes | Mason's Line..... 25-26 | Seam..... 200-201 |
| Crack..... 147 | Miscellaneous Tools..... 235-250 | Carpet Seam..... 219 |
| Garden..... 243 | Mixers, Gilson..... 31-38 | Round-It Tool..... 160 |
| Mortar..... 23 | Mixers | Rub Bricks..... 22, 117, 221 |
| | Die-Cast..... 163 | |

Marshalltown Tool Index

| | |
|---------------------------|------------------|
| Rulers, Rhino..... | 28 |
| S | |
| Safety Glasses | 249 |
| Sanders | |
| Hand | 180 |
| Pole | 180-181 |
| Vacuum..... | 179 |
| Sandpaper/Sandscreen..... | 182 |
| Saws | |
| Acoustical..... | 175 |
| Concrete | 94 |
| Drywall | 173 |
| Grout | 221 |
| Hole | 218 |
| Super Saw, Crain®..... | 216 |
| Blades | 216 |
| Undercut | 218 |
| Utility | 173-174 |
| Scarifiers | 184 |
| Scrapers | |
| Bent Blade | 197 |
| Carbide | 199 |
| Crain®..... | 222 |
| Blades | 222 |
| Floor | 30, 197, 222-223 |
| Forged..... | 242 |
| Molding | 199 |
| Paint | 198 |
| Razor Blade | 196 |
| T-Handled Floor..... | 197, 222 |
| Threaded Handle | 197 |
| Wall | 197 |
| Screeds | 95 |
| Combo | 96 |
| Handles | 96 |
| Screwdrivers..... | 237 |
| Scrub Bug/Float..... | 214-215 |
| Shears | 201 |
| Shovels | 239-241 |
| Scoop..... | 241 |
| Shingle..... | 240 |
| Trenching..... | 241 |
| Sled Runners..... | 17 |
| Slickers | |
| Brick | 14-15 |
| Drywall/EIFS | 185 |
| Snips | 221 |
| Sponges | |
| Contour Sanding..... | 182 |
| Drywall Sanding..... | 183 |
| Sanding Sponge Pads..... | 183 |
| Tile Grout | 214 |
| Turtle Back..... | 30, 214 |
| Spray Shields | 195 |
| Squeegees | |
| Adjustable Texture..... | 186 |
| Asphalt..... | 144 |
| Crack | 145-146 |
| Floor | 100, 145 |
| Notched..... | 100 |

| | |
|---------------------------------|--------------|
| Stair Tool, Carpet | 219 |
| Staple | |
| Guns | 220 |
| Hammer Tackers | 220 |
| Step Tools | 61 |
| Stilts, Drywall..... | 192-194 |
| Repair Kits/Parts..... | 192-194 |
| Straight Edge | |
| Paver's..... | 75 |
| Plain | 224 |
| Set | 224 |
| Stripers | 202 |
| Accessories..... | 202 |
| Double Line Kit | 202 |
| Wheel Tip Assemblies | 202 |
| Stripper, Drywall..... | 175 |
| Stud Finder..... | 177 |
| Suction Cups..... | 225 |
| T | |
| T-Squares..... | 175-176 |
| Tampers | |
| Asphalt | 148 |
| Concrete | 101,102,139 |
| Tape | |
| Cornerbead..... | 172 |
| Mesh | 171 |
| Tape Holders..... | 171 |
| Tape Measures | 28, 174, 239 |
| Tapers | |
| Drywall | 170-171 |
| Mesh | 171 |
| The Paper Taper..... | 171 |
| Taping Tools, Automatic | |
| Angle Head Finishers | 167 |
| Applicators | 166 |
| Corner Flusher Boxes..... | 168 |
| Corner Rollers..... | 166 |
| Flat Boxes | 167 |
| Grip Box Handles..... | 168 |
| Mud Pumps..... | 169 |
| Nail Spotters | 169 |
| Taper | 165 |
| Tool Display Stand..... | 169 |
| Repair Parts..... | 165-170 |
| Tube Syringe..... | 166 |
| Texture Sprayer, Enforcer®..... | 187, 233 |
| Tie Wire | |
| Looped Wire Ties..... | 104 |
| Reels | 104 |
| Twisters..... | 104 |
| Tile and Flooring Tools..... | 204-227 |
| Tile Cutters | 216 |
| Replacement Parts | 216 |
| Tile Dolly | 225 |
| Tile Screen | 218 |
| Tile Spacers | 224 |
| Tile Spacer Popper..... | 225 |
| Tile Stones | 221 |
| Tongs, Brick | 22 |
| Tool Hook..... | 51 |

| | |
|-----------------------------|--------------|
| Tote, 30" Open | 187, 245 |
| Trowels | |
| Archaeology | 12 |
| Holster..... | 12 |
| Brick | |
| Ceremonial..... | 9 |
| London | 7-10 |
| PermaShape® | 7 |
| Philadelphia..... | 7, 9, 10 |
| Wide London | 7 |
| Bucket | 9-10 |
| Stainless..... | 10 |
| Coke | 12 |
| Corner | |
| Concrete..... | 61 |
| Drywall | 158-159 |
| EIFS | 231 |
| Drywall | 158-159 |
| EIFS | 228-233 |
| Finishing..... | 39-51, 149 |
| DuraFlex..... | 149, 230 |
| Front Rounded | 44 |
| Fully Rounded..... | 45, 47 |
| Gunite..... | 46 |
| Midget | 46 |
| PermaShape® | 39 |
| Plastic..... | 47-48 |
| Silo | 46 |
| Gauging | 12 |
| Insulator's..... | 13, 230 |
| Margin..... | 11 |
| Stainless..... | 11 |
| Notched..... | 204-211, 229 |
| DuraNotch® | 207 |
| Margin | 211 |
| Plastic..... | 210 |
| Spreaders..... | 211 |
| Pipe | 45 |
| Plastic Texturing..... | 231 |
| Pointing..... | 10 |
| Pool | 48-51 |
| Exposed Rivet..... | 48-49 |
| Plastic..... | 48 |
| PoolSaver™ | 49 |
| Tile Setter's..... | 215 |
| Wall Form..... | 46 |
| Truss Screeds | 93 |
| Tuck Pointers | 14 |
| W | |
| Wall Capping Tools | 19 |
| Wax Bowl Ring..... | 227 |
| Wedge, Stone Splitting..... | 22 |
| Wipe Down Blade..... | 160 |
| Work Bench..... | 194 |
| Leg Extensions | 194 |
| Z | |
| Zipper Doorway..... | 195 |



Sales/Customer Service:
Phone: 641-753-5999 • 800-888-0127
Fax: 641-753-6341 • 800-477-6341

Manufacturing Plants:
Marshalltown, Iowa • Fayetteville, Arkansas
www.MARSHALLTOWN.com

MTCAT/17003

Printed in U.S.A.