

Features

- Vitreous china.
- Elongated bowl.
- Equipped with Sloan FLUSHMATE®– Sloan® Valve Company.
- Polished chrome trip lever.
- Rear outlet.
- 12" (305 mm) x 10" (254 mm) water area.
- Tank cover locks.
- 4" (102 mm) rough-in.
- Less seat and supply.
- 1.0 gpf (3.8 lpf).
- 31-1/2" (800 mm) x 21-1/4" (540 mm) x 29-1/4" (743 mm).

Recommended Accessories

- K- 4652 Toilet Seat
- K- 4652-A Toilet Seat
- K- 7637 Angle Supply with Stop (single)

Components

Product includes:

- K- 4327 Toilet Bowl
- K- 4484-T Toilet Tank

Additional included component/s: Tank cover, Trip lever, Floor screws and bolt caps, Bolt cap accessory pack, Tank accessory pack, and Equipped with Sloan FLUSHMATE® – Sloan® Valve Company.



Codes/Standards





ASME A112.19.2/CSA B45.1
DOE - Energy Policy Act 1992
EPA WaterSense®

KOHLER® One-Year Limited Warranty

See website for detailed warranty information.

Available Color/Finishes

Color tiles intended for reference only.

Color	Code	Description
	0	White
	96	Biscuit
	47	Almond
	58	Thunder™ Grey
	7	Black Black™

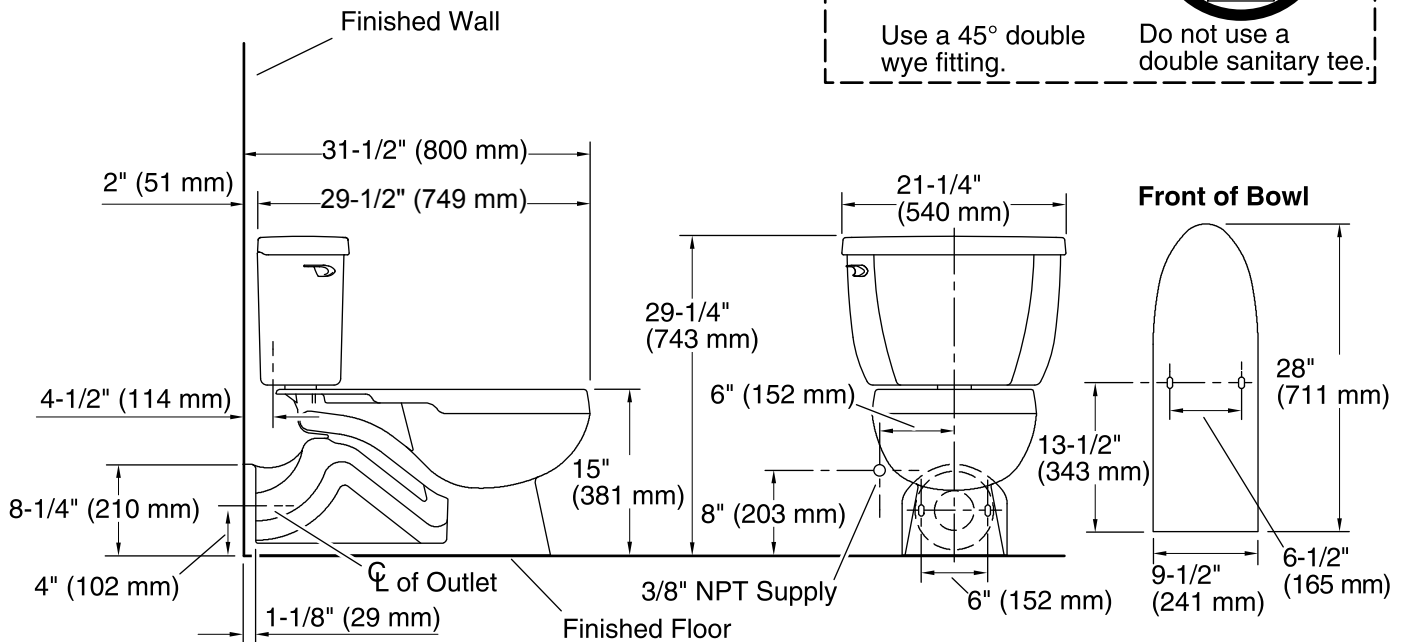
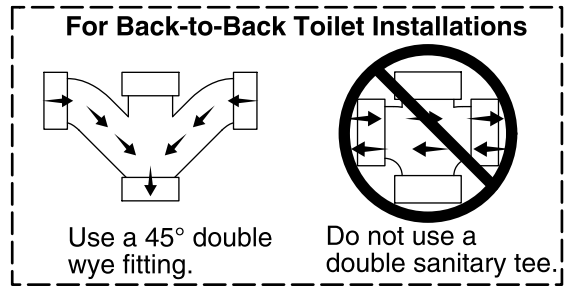

Technical Information

All product dimensions are nominal.

- Toilet type: Two-piece
- Bowl shape: Elongated front
- Flush type: Pressure Assisted
- Trap passageway: 2-1/4" (57 mm)
- Water surface size: 12" x 10" (305 mm x 254 mm)
- Rim to water surface: 7" (178 mm)
- Rough-in: 4" (102 mm)
- Seat-mounting holes: 5-1/2" (140 mm)

Fixture Supply Requirements

- Min static pressure: 35 psi (241.3 kPa)
- Max static pressure: 80 psi (551.6 kPa)

Notes

- Install this product according to the installation guide.
- For back-to-back toilet installations: Use only a 45° double wye fitting.