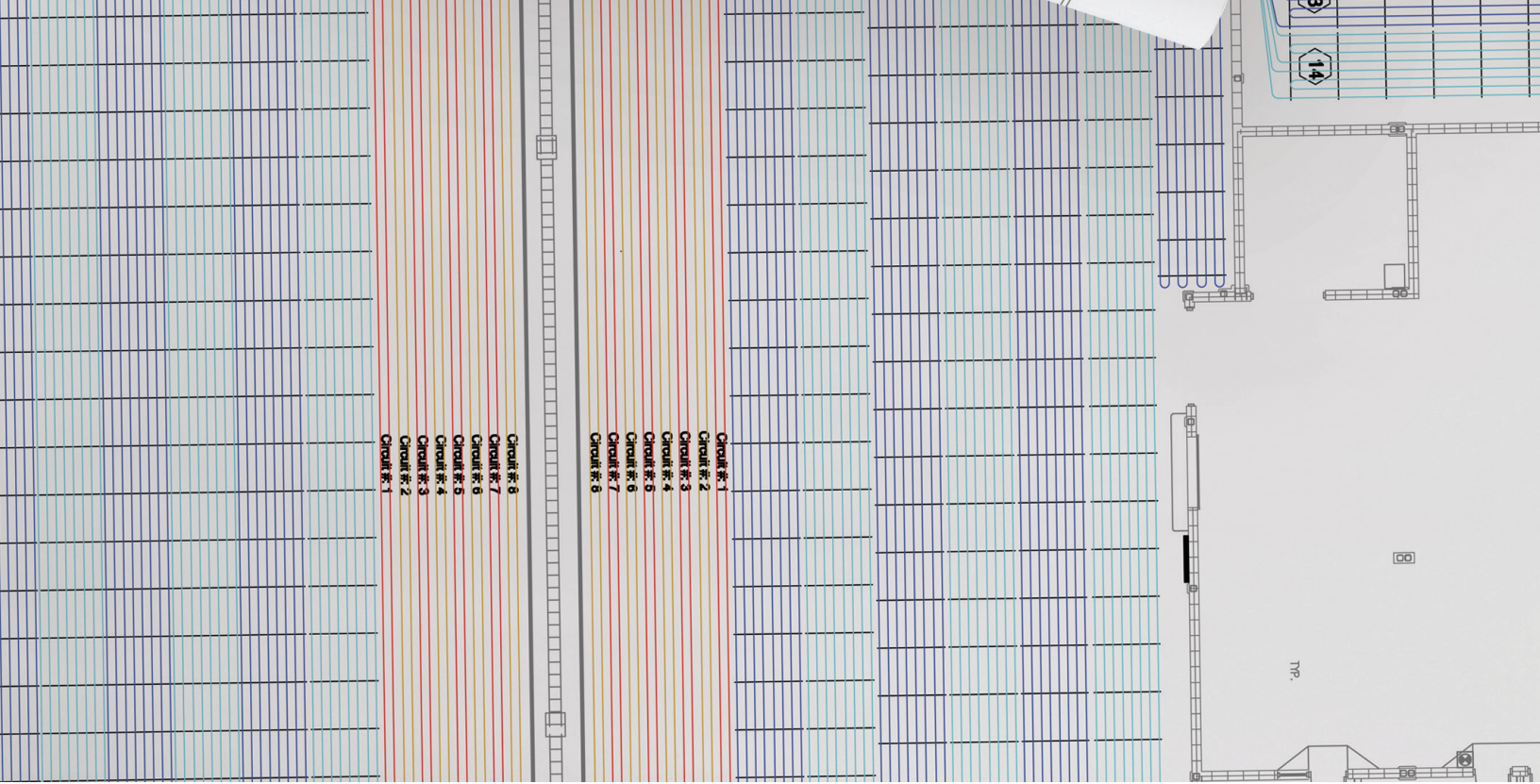


# ProRadiant Heating and Cooling Design Manual 2015



The global leader  
in plumbing, heating  
and pipe joining systems



## **Working with Viega is the perfect solution.**

Viega researches, develops and produces complete system solutions for contractors in the technical plumbing, heating and cooling installation business. The components are produced at our plants or are supplied exclusively by the finest quality manufacturers. Each of our systems is developed in-house and tested under stringent quality control conditions to guarantee safety and efficient operation.

## **An international company with a national commitment.**

Viega recognizes that many of the advances in our industry have their beginnings in Europe. However, that does not mean North America deserves anything less. Therefore, we have been the pioneer in combining technology from both sides of the Atlantic into the very best plumbing and heating systems for our customers.

Our goal is to remain in the forefront of the plumbing and heating industry well into the new century, and with our advanced products and a determination to remain the quality leader, we are convinced this accomplishment is well within our reach.

## **Welcome**

By choosing to install a Viega System, you have joined the ranks of heating system installers across the country who believe there is no substitute for quality.

Viega has a history of bringing high quality and innovative technology to the hydronic marketplace in North America.

It is the business of our engineers to research and develop complete systems that provide you the most effective and easy-to-use products available. In the following pages, you will be guided through the system design, layout, installation and start-up of our residential and commercial products.

We look forward to sharing our story with you. Call 800-976-9819 for your local District Manager and wholesale location.

## **Viega Technical Services**

### *Training*

Viega offers industry-leading training on the hottest topics. From hydronics troubleshooting to commercial radiant heating and cooling, from ground source heat pumps to solar and fire sprinkler, Viega offers a wide variety of courses related to the plumbing and heating industry. For a list of our course offerings as well as course descriptions and registration link, please visit [www.viega.us/training](http://www.viega.us/training).

### *Technical Support*

Whether you are calling in reference to a specific part of a Viega system or have a general plumbing, heating or piping question, we have the staff to help. The experienced industry professionals from diverse backgrounds handle all incoming requests for all product lines and have the background, training and resources to provide accurate and quick responses to all customer inquiries.

To contact our Technical Support Department via telephone please call 800-976-9819 x350, or contact them by email at [plumbing@viega.us](mailto:plumbing@viega.us).

### *Design Services*

Viega offers a wide variety of design services for radiant heating, radiant cooling, residential fire sprinkler and residential plumbing systems. Our design engineers have the expertise to provide detailed material lists, output calculations, pricing and drawings for both residential and commercial radiant systems. Residential 13D fire sprinkler designs completed using our Black ViegaPEX Ultra tubing and press connection system allow users to integrate into a familiar PEX plumbing system. Fire sprinkler services include quotations, material lists, calculations and drawings. Our Technical Services team can also provide material lists and pricing for residential PEX plumbing systems.

For radiant heating or cooling design requests, our design team can be contacted by calling 800-976-9819 x351 or via email by contacting [heating@viega.us](mailto:heating@viega.us).

## 1 Principles of Radiant Heating Design

1.1	Codes, standards and green building . . .	5
1.2	Installation methods . . . . .	5
1.3	Insulation . . . . .	9
1.3.1	Residential insulation recommendations . . . . .	11
1.3.2	Commercial insulation recommendations . . . . .	11
1.3.3	Insulation requirements for Canada . . . . .	13
1.4	Panel coverings . . . . .	14
1.4.1	Hardwoods . . . . .	14
1.4.2	Floor surface temperatures . . . . .	14
1.4.3	Carpet . . . . .	16
1.4.4	Tile, stone and marble . . . . .	17
1.4.5	Concrete . . . . .	17
1.4.6	Laminates . . . . .	18
1.4.7	Resilient surfaces . . . . .	18
1.5	Heat load . . . . .	18
1.6	Design temperatures . . . . .	18
1.6.1	Panel surface temperature . . . . .	18
1.6.2	Floor surface temperatures . . . . .	19
1.6.3	Supply water temperature . . . . .	19
1.6.4	Temperature drop . . . . .	19
1.7	System documentation and operational instructions . . . . .	21
1.8	Piping . . . . .	21
1.8.1	Primary/secondary . . . . .	23
1.8.2	Panel piping . . . . .	25
1.8.3	Piping configurations . . . . .	27
1.9	Circulator pumps . . . . .	31
1.9.1	Flow rates . . . . .	31
1.9.2	Pressure drop . . . . .	31
1.9.3	Using a pump curve . . . . .	35
1.9.4	Circulator placement relative to the expansion tank . . . . .	38
1.10	Expansion . . . . .	40
1.10.1	Selecting an expansion tank . . . . .	40
1.10.2	PEX expansion compensation . . . . .	41
1.11	Freeze protection – glycol mixtures . . . . .	46
1.11.1	Selecting the percent glycol mixture . . . . .	46
1.11.2	Glycol system effects . . . . .	46
1.11.2.1	Glycol flow rate . . . . .	46
1.11.2.2	Glycol primary piping sizing . . . . .	50
1.11.2.3	Glycol pressure drop . . . . .	51
1.11.2.4	Glycol expansion tank selection . . . . .	55
1.11.3	Glycol system maintenance . . . . .	55

1.12	Controlling the system . . . . .	55
1.12.1	Fixed temperature . . . . .	56
1.12.2	Radiant floor heating panels . . . . .	56
1.12.3	Variable temperature . . . . .	57
1.12.4	Radiant floor heating panels . . . . .	57
1.12.5	Flow control . . . . .	61
1.12.6	Zoning . . . . .	61
1.12.7	Differential pressure regulation . . . . .	61
1.13	Minimum required design information . . . . .	67

## 2 Residential Radiant Heating

### Considerations

2.1	Codes and standards . . . . .	68
2.2	System documentation and operational instructions . . . . .	69

## 3 Commercial Radiant Heating and Cooling

### Considerations

3.1	Codes, standards and green building . . . . .	70
3.2	Insulation . . . . .	71
3.3	Heating and cooling load calculations . . . . .	73
3.4	Installation methods . . . . .	73
3.5	Commercial radiant heating . . . . .	77
3.6	Commercial radiant cooling . . . . .	79
3.6.1	Design temperatures . . . . .	79
3.6.2	Capacity . . . . .	83
3.6.2.1	Floor coverings . . . . .	83
3.6.2.2	Placement of tubing within the slab . . . . .	83
3.6.3	Cooling equipment . . . . .	83
3.6.4	Cooling control strategies . . . . .	85
3.7	Combination heating and cooling considerations . . . . .	86

## 4 Installation and Startup

4.1	Installation . . . . .	88
4.1.1	Connecting tubing . . . . .	88
4.1.2	Handling and protecting tubing . . . . .	89
4.1.2.1	Slab joint tube protection . . . . .	89
4.1.3	Layout and fastening . . . . .	91
4.2	Startup . . . . .	91
4.2.1	Pressure testing and purging . . . . .	92
4.2.2	Initial balancing . . . . .	93
4.2.3	Adjusting the high-limit . . . . .	94
4.2.4	Considerations for slabs . . . . .	95
4.2.5	System documentation and operational instructions . . . . .	95

## 5 Snow Melting

5.1	Selecting the design criteria level . . . . .	96
5.2	Calculating the snow melting load . . . . .	98
5.3	Calculating the tubing spacing . . . . .	102
5.4	Calculating the glycol solution supply temperature . . . . .	102
5.5	Selecting the percent glycol mixture . . . . .	103
5.6	Sizing for flow rate, pressure drop and expansion . . . . .	103
5.6.1	Glycol flow rate . . . . .	103
5.6.2	Glycol pressure drop . . . . .	106
5.6.3	Glycol expansion tank selection . . . . .	111
5.7	Selecting the circulator . . . . .	114
5.8	Approximating the operating cost . . . . .	114
5.9	Thermal mass considerations . . . . .	116
5.10	Typical cross sections . . . . .	116
5.11	Controls . . . . .	116
5.11.1	Piping configurations . . . . .	116
5.11.2	Mixing options . . . . .	116
5.11.3	Selecting a heat exchanger . . . . .	124
5.11.4	Control hardware . . . . .	124
5.12	Planning and installation . . . . .	125
5.12.1	Creating a material list . . . . .	125
5.12.2	Layout planning . . . . .	125
5.12.3	Installation . . . . .	126
5.12.4	Slab joint tube protection . . . . .	126
5.13	Startup . . . . .	130
5.13.1	Pressure testing, filling and purging . . . . .	131
5.13.2	Initial Balancing . . . . .	132
5.14	Maintenance . . . . .	133

## Appendix A Tubing . . . . .134

## Appendix B Repair Coupling Wrap . . . . .138

## Appendix C Climate Panel

A.1	Introduction . . . . .	139
A.2	Typical cross sections . . . . .	140
A.3	Creating a material list . . . . .	146
A.4	Layout planning . . . . .	146
A.5	Installation . . . . .	147

## Appendix D In-Slab Systems

B.1	Introduction . . . . .	157
B.2	Typical cross sections . . . . .	157
B.3	Creating a material list . . . . .	166
B.4	Layout planning . . . . .	167
B.5	Installation . . . . .	168
B.5.1	Rapid Grid considerations . . . . .	169
B.5.2	Snap Panel considerations . . . . .	170

## Appendix E Climate Trak

C.1	Overview . . . . .	173
C.2	Creating a material list . . . . .	181
C.3	Layout planning . . . . .	182
C.4	Installation . . . . .	183

## Appendix F Climate Mat

D.1	Components . . . . .	193
D.2	Planning the installation . . . . .	193
D.2.1	Preparing the site . . . . .	193
D.2.2	Off-loading and storing the mats . . . . .	195
D.2.3	Layout and staging . . . . .	195
D.2.4	Items needed for installation . . . . .	196
D.3	Installing the Climate Mat . . . . .	196
D.3.1	Precautions during installation . . . . .	196
D.3.2	Repairing tubing . . . . .	197
D.3.3	Fastening the Climate Mat . . . . .	197
D.3.4	Getting around obstacles . . . . .	198
D.3.5	Sleeving expansion joints and slab penetrations . . . . .	198
D.3.6	Pouring the concrete . . . . .	198
D.3.7	Connecting to permanent manifolds . . . . .	199
D.4	Startup . . . . .	199
D.4.1	Purging procedure . . . . .	199
D.4.2	Warming up the slab . . . . .	199
D.4.3	Testing the concrete for excessive moisture . . . . .	199
D.5	Viega Manifold Cabinet . . . . .	199

## Appendix G R-values of coverings . . . . .201

## Appendix H Btu output tables . . . . .202

## Appendix I Glossary . . . . .205

## References . . . . .208

## Background

Radiant hydronic heating has long been recognized for its advantages over forced air systems in the areas of comfort, efficiency, architectural flexibility and acoustics. Now, radiant hydronic cooling is also emerging to offer the same benefits as radiant heating plus the capability of peak load shifting.

Traditionally, radiant space conditioning is often thought of as circulation of a fluid through radiators or tubing circuits located within a building's floor, and this is still the most common application today. However, radiant hydronic systems have a far wider applicability, including wall installations within buildings and outdoor turf conditioning and snow melting.

In fact, coupling hydronic tubing to any surface can turn it into a heat source or a heat sink, depending on the temperature of the fluid circulating through the tubing and the surface temperature of the objects to be cooled or heated.

This manual is structured to provide the user with an overview of radiant hydronic heating and cooling applications, design considerations for optimizing system performance and efficiency, and installation instructions for Viega's hydronic heating and cooling distribution systems, for residential and commercial applications.

With the right tools and a bit of planning, designing and specifying radiant heating systems can be a relatively straightforward process that provides excellent comfort and heating performance. Software programs are now readily available and greatly simplify the design process for residential and commercial installations. Radiant heating contractors are no longer required to perform tedious hand calculations to develop room-by-room heating loads and system design. Instead,

the role of the contractor in the design process has shifted to carefully selecting inputs for these software programs and ensuring that the program outputs satisfy good design principles. This section is structured to provide the contractors with the context needed to excel in this role.

### 1.1 Codes, standards and green building

The first step in the successful design of a radiant heating or cooling system is identifying the applicable codes, standards and design goals that will impact the final system specification. Depending on the job, the final list of considerations will be determined by state, local and sometimes federal requirements as well as project-specific goals and criteria. Section 2, Residential radiant heating considerations, and Section 3, Commercial radiant heating and cooling considerations, contain a list of typically applicable codes and standards and their potential impact on the project as related to the design and specification of radiant heating and cooling systems. Always check with the local jurisdiction to determine what codes and standards are in effect.

### 1.2 Installation methods

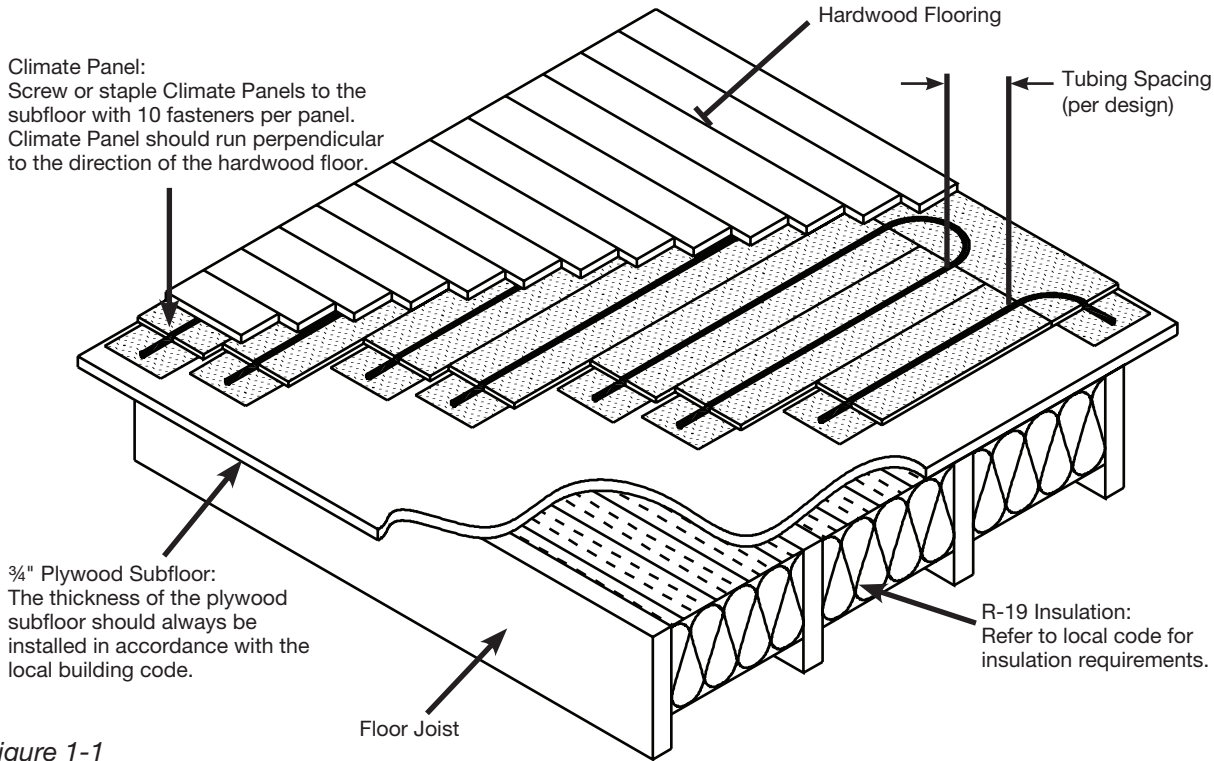
In addition to the tools required to design a system, Viega provides the tools to ensure your installation is smooth, clean and professional. For new floor installations and floor installations that involve replacement or removal of the floor covering, top of subfloor and in-slab applications are popular choices. If it does not make sense to remove the existing floor covering, then a below-subfloor application is a good choice. Viega provides several products that make the installation process easier, including Climate Panel (top of subfloor and walls), Climate Trak (below subfloor), Rapid Grid, Snap Panel and Climate Mat (in-slab applications).

Application	Location	Climate Panel (Appendix C)	Rapid Grid (Appendix D)	Snap Panel (Appendix D)	Climate Trak* (Appendix E)	Climate Mat** (Appendix F)
	Below Subfloor				X	
	Above Subfloor	X				
	In-Slab (gypsum or concrete, thin-slab or full dimension)		X	X		X
	Above Slab	X				
Walls	Behind Covering	X				

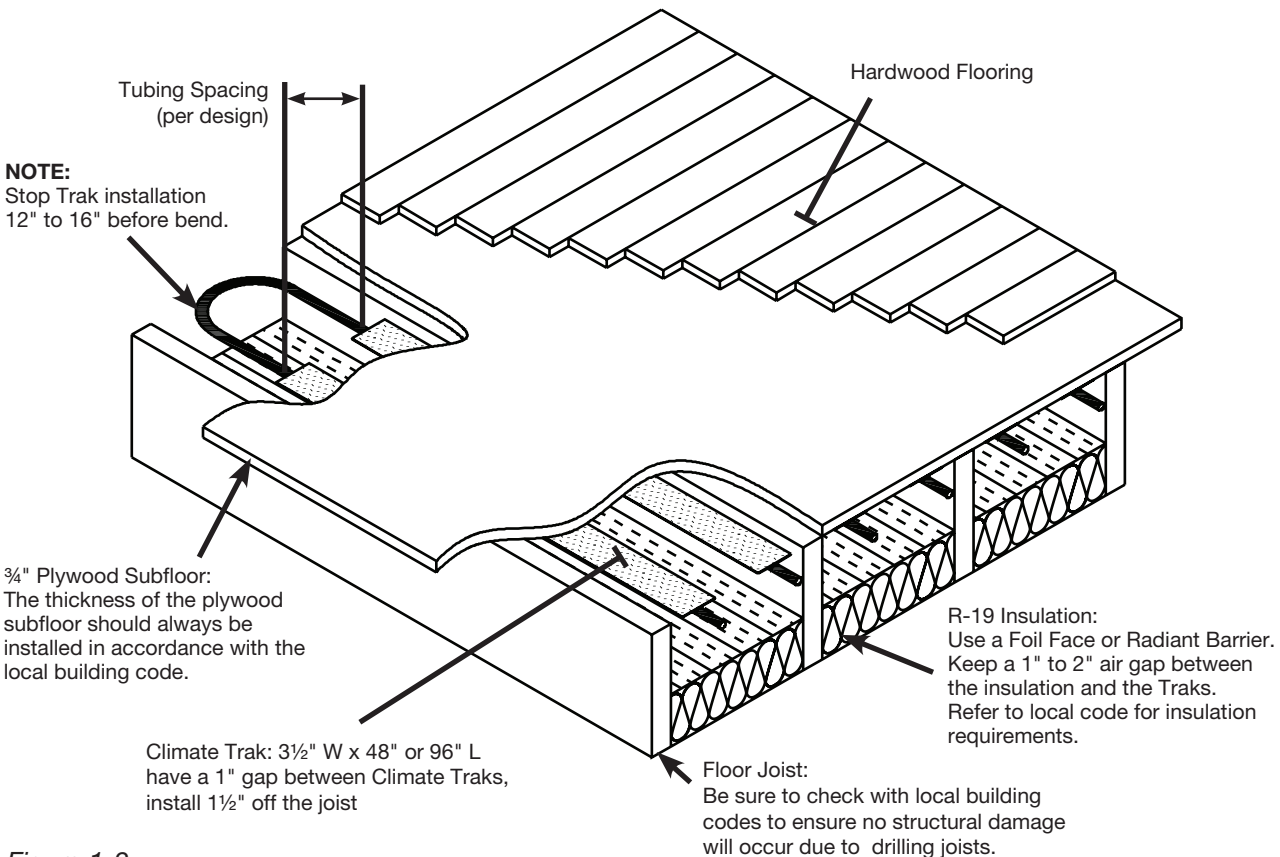
Table 1-1 Installation methods based on application

\*Below-subfloor applications may also use heat transfer plates

\*\*Climate Mat is intended for large open areas greater than 10,000 ft<sup>2</sup>



**Figure 1-1**  
Section through Climate Panel installation above subfloor with hardwood finish floor



**Figure 1-2**  
Section through Climate Trak installation with hardwood finish floor

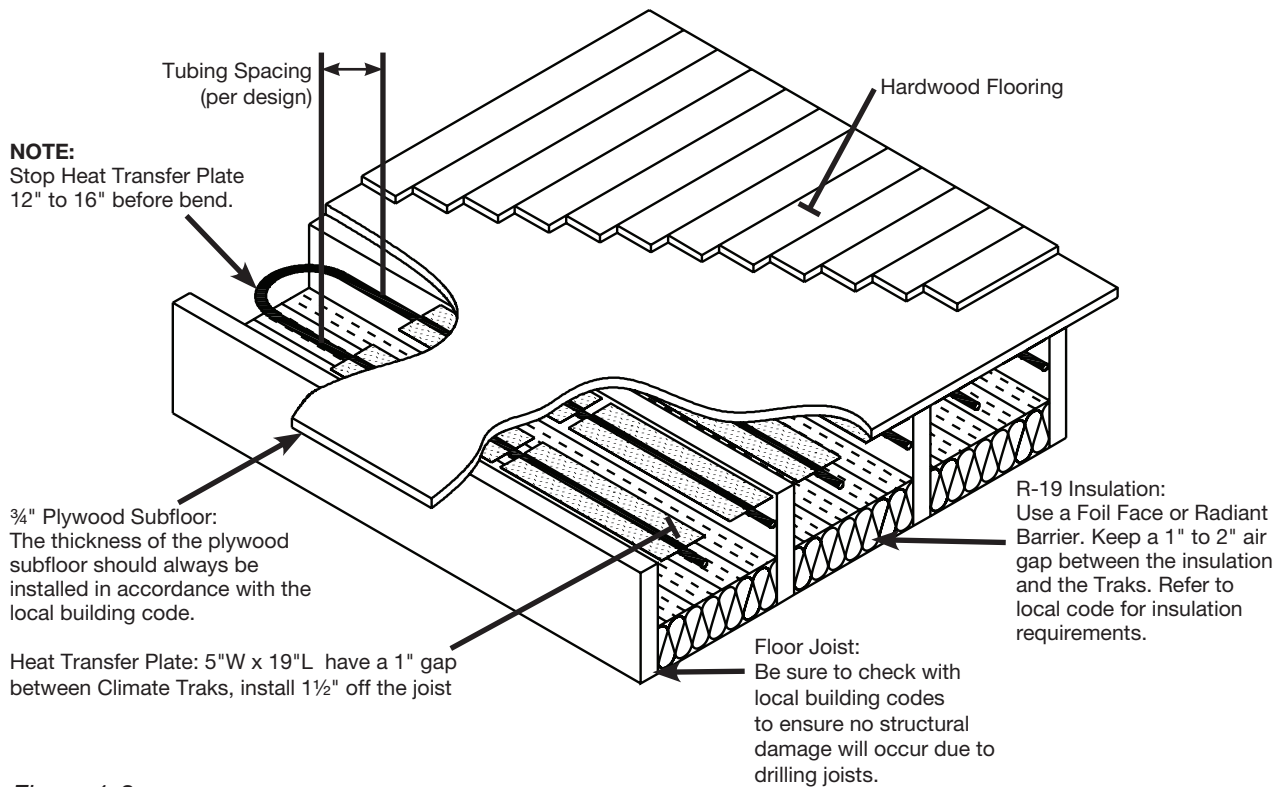


Figure 1-3  
Section through heat transfer plate installation with hardwood finish floor

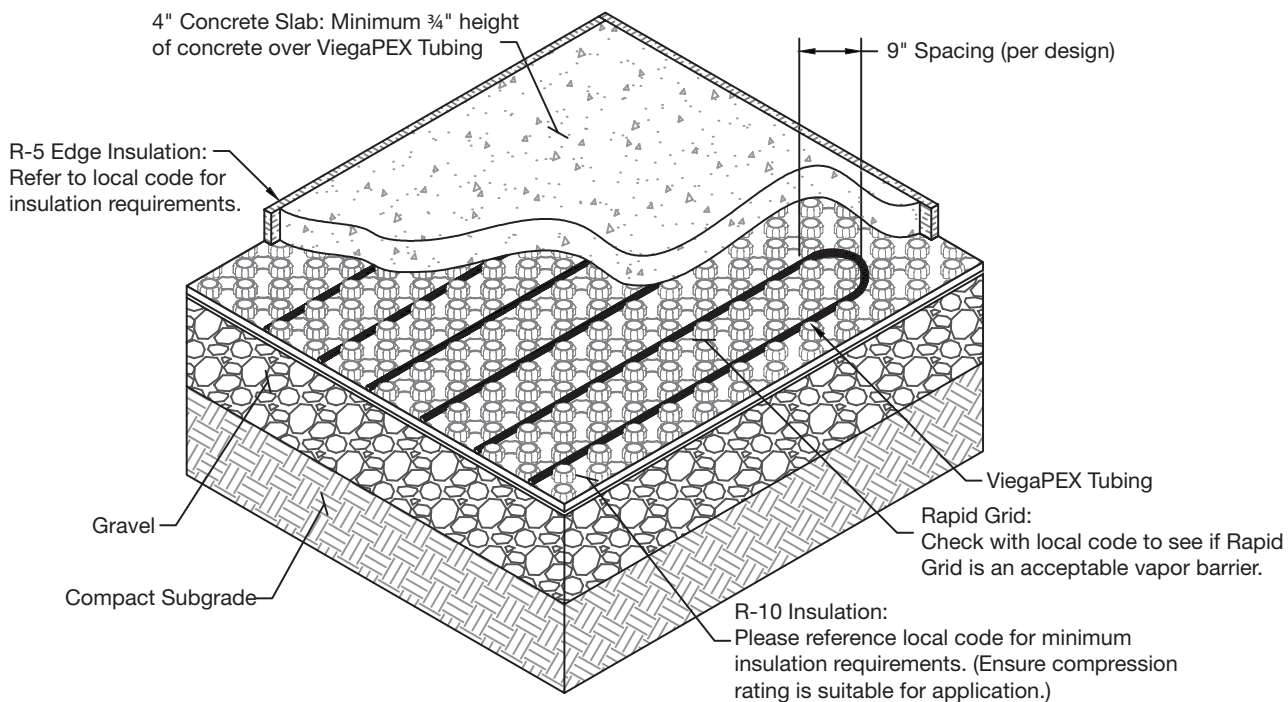
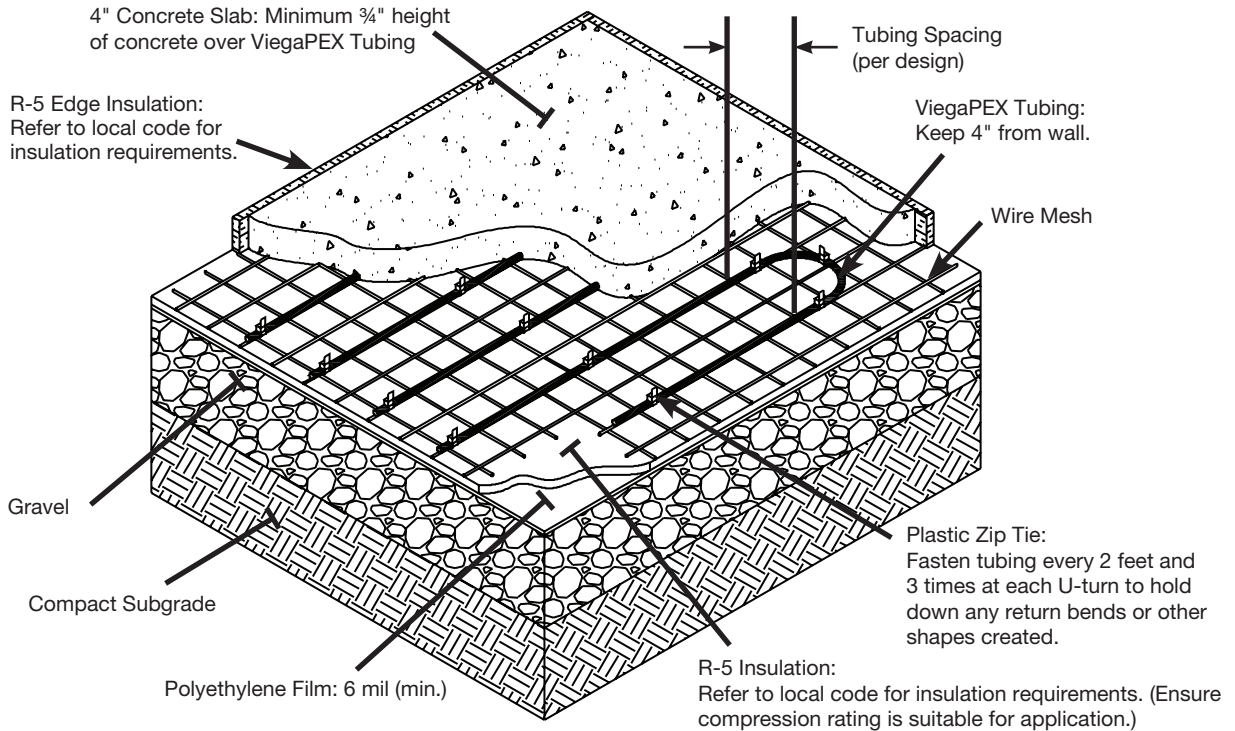
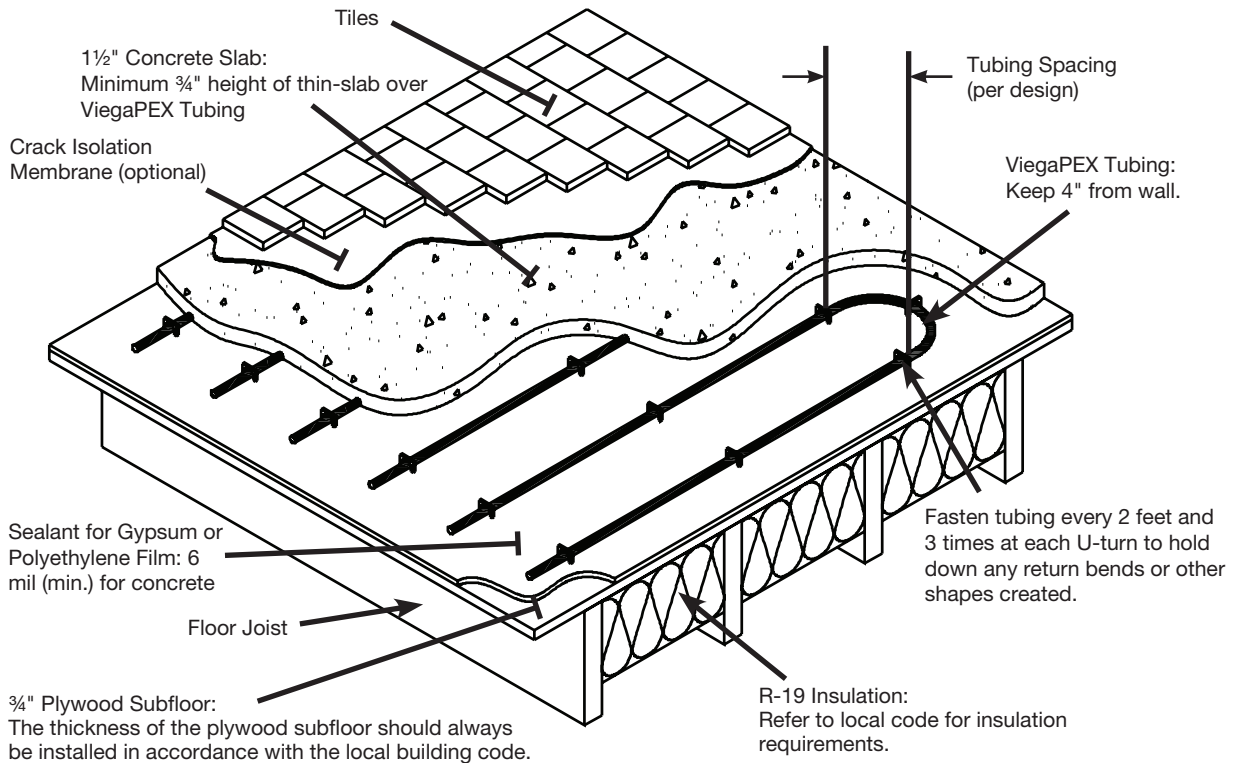


Figure 1-4  
Section through slab on or below grade installation using Rapid Grid



**Figure 1-5**  
Section through slab on or below grade installation using plastic zip ties



**Figure 1-6**  
Section through thin-slab installation with tiles



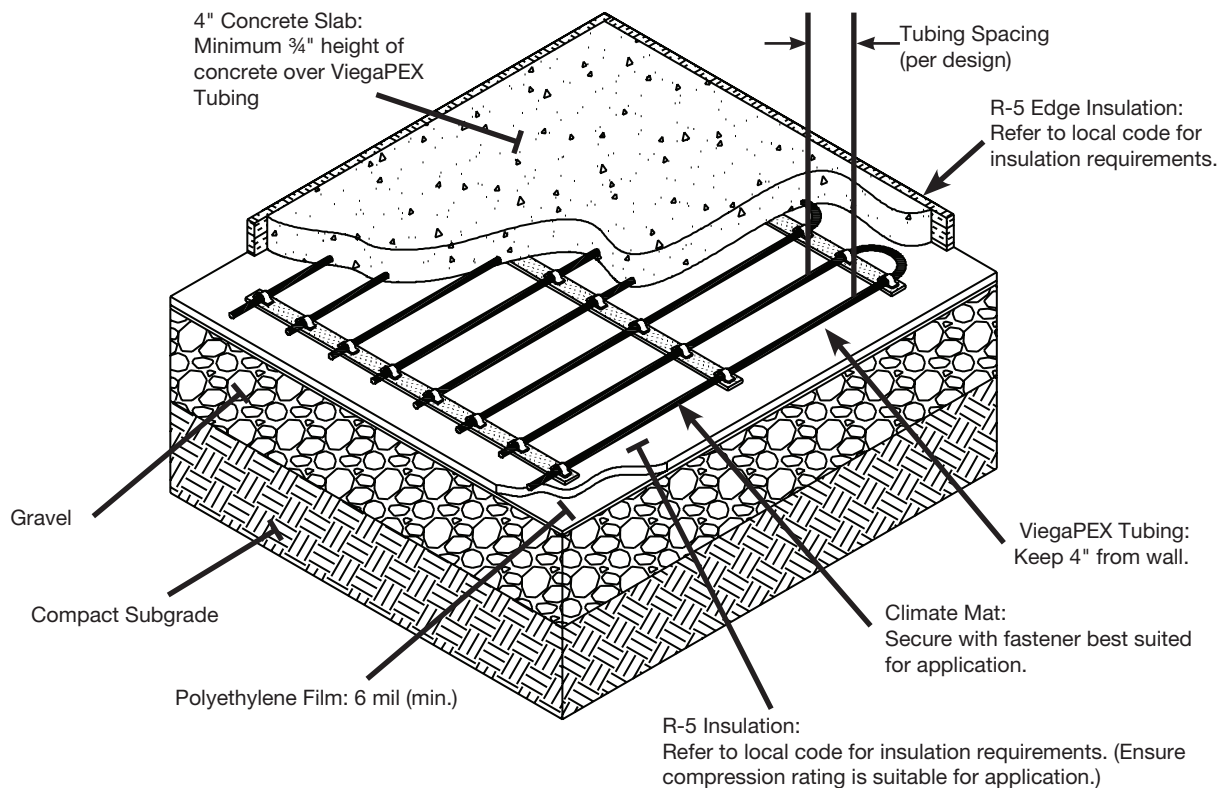


Figure 1-7  
Section through Climate Mat on existing slab

For in-slab installations, at least  $\frac{3}{4}$ " of concrete should be maintained between the top of the tubing and the top of the slab. The minimum permissible thickness of thin-slabs is  $1\frac{1}{2}$ ". Be sure to coordinate with whoever is responsible for control cuts or joints to prevent tubing from being damaged after the pour, if the tubing is to be set high in the slab.

Complete installation instructions for these products, including cross-sectional illustrations, layout planning guidance, material lists and installation tips can be found in Appendices A-D.

### 1.3 Insulation

A key step in designing a comfortable, energy-efficient radiant heating distribution system is ensuring that adequate insulation is installed. In some cases, local building codes will specify the insulation requirements for building assemblies that serve as radiant panels, but in other cases, insulation requirements are left to the discretion of

the designer. Recommended minimum insulation levels for radiant panels in new construction applications vary by application (e.g., commercial or residential) and climate zone, which are shown in Figure 1-5. Higher-level climate zones require higher levels of insulation for radiant panels. If radiant floor delivery temperatures are limited by the equipment type, higher levels of insulation can be specified to increase the heat transfer between the conditioned space and the radiant panel.

Considerations for Insulating Slabs with Ground Contact: Specify a vapor barrier to go beneath the slab and any insulation. Always provide full sub-slab insulation and adequate drainage where there is a high water table. Specify sub-slab insulation whose compressive strength is rated for the weight of the slab and expected dynamic loads (e.g., heavy equipment, storage, etc.). Whenever installing foam board insulation, weigh down the boards to prevent wind uplift. In some jobs this can be done by installing wire mesh as soon as foam boards are placed.

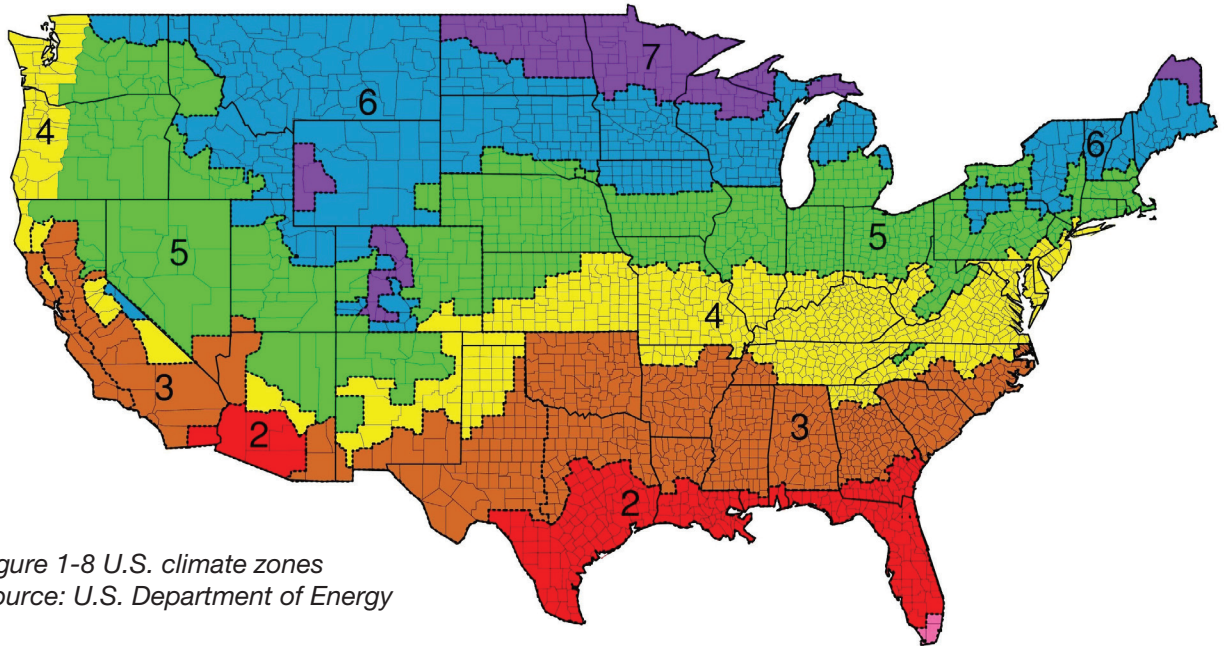


Figure 1-8 U.S. climate zones  
Source: U.S. Department of Energy

Climate Zone	Slab with Ground Contact, Perimeter Insulation	Slab or Floor in Conditioned Space, Horizontal Insulation	Slab or Floor over Unconditioned Space, Horizontal Insulation	Wall Cavity R-Value Exterior	Wall Cavity R-Value Interior
1	R-5.0, 24-inch depth	R-value that is 5 times the value of the floor covering's R-value.	R-13	R-20	R-13
2			R-19		
3	R-30				
4 except Marine 5 and Marine 4	R-15, 24-inch depth		R-38		
6	R-15, 48-inch depth				
7-8					

Table 1-2 Recommended R-values for residential new construction. It may not be feasible to attain these values in existing construction. All installations should comply with local code.

### 1.3.1 Residential insulation recommendations

1. Perimeter insulation may be applied on the interior or exterior of the foundation. Perimeter insulation should be applied vertically if the top of the slab is within 12" of grade, and may be applied vertically and / or horizontally if the top of the slab is more than 12" below grade. Listed depths are measured from the top of the slab. Viega also recommends installing a minimum R-5 horizontal foam board insulation under the entire slab for small residential applications (< 2,000 ft<sup>2</sup>).
2. R-value should be a minimum of 5 times the value of the floor covering's R-value.
3. Or maximum R-value permitted based on the depth of the floor joist.

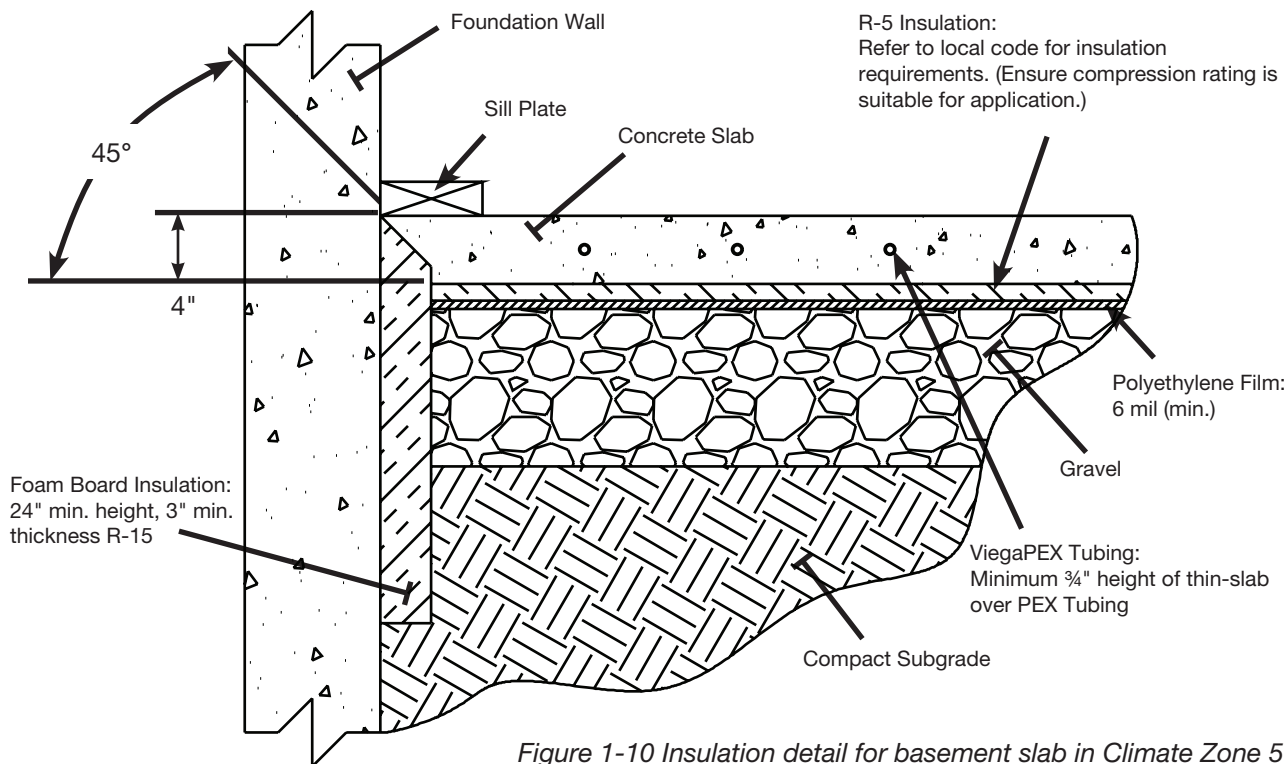


Figure 1-10 Insulation detail for basement slab in Climate Zone 5

### 1.3.2 Commercial insulation recommendations

Recommended minimum levels of slab insulation are given in Table 1-3 based on a location's climate zone, which can be found in Figure 1-5

Application	Slab with Ground Contact, Perimeter Insulation by Climate Zone	Suspended Slab (e.g. between floors) Horizontal Insulation
Heating Only	CZ 1-2: R-7.5, 12-inch depth CZ 3: R-10, 24-inch depth CZ 4-5: R-15, 24-inch depth CZ 6-8: R-20, 48-inch depth	R-value that is 5 times the value of the floor covering's R-value. See Table 3-3 for more detail on the back loss as a function of insulation below the suspended slab.
Cooling Only	R-5 where chilled slab abuts unconditioned space	Same as heating
Heating and Cooling	Same as heating	Same as heating

Table 1-3 Minimum recommended R-values for slab insulation of conditioned slabs. Perimeter insulation may be applied on the interior or exterior of the foundation. Perimeter insulation should be applied vertically or a combination of vertically and horizontally, when it extends to at least the depth of the slab. Listed depths are measured from the top of the slab.

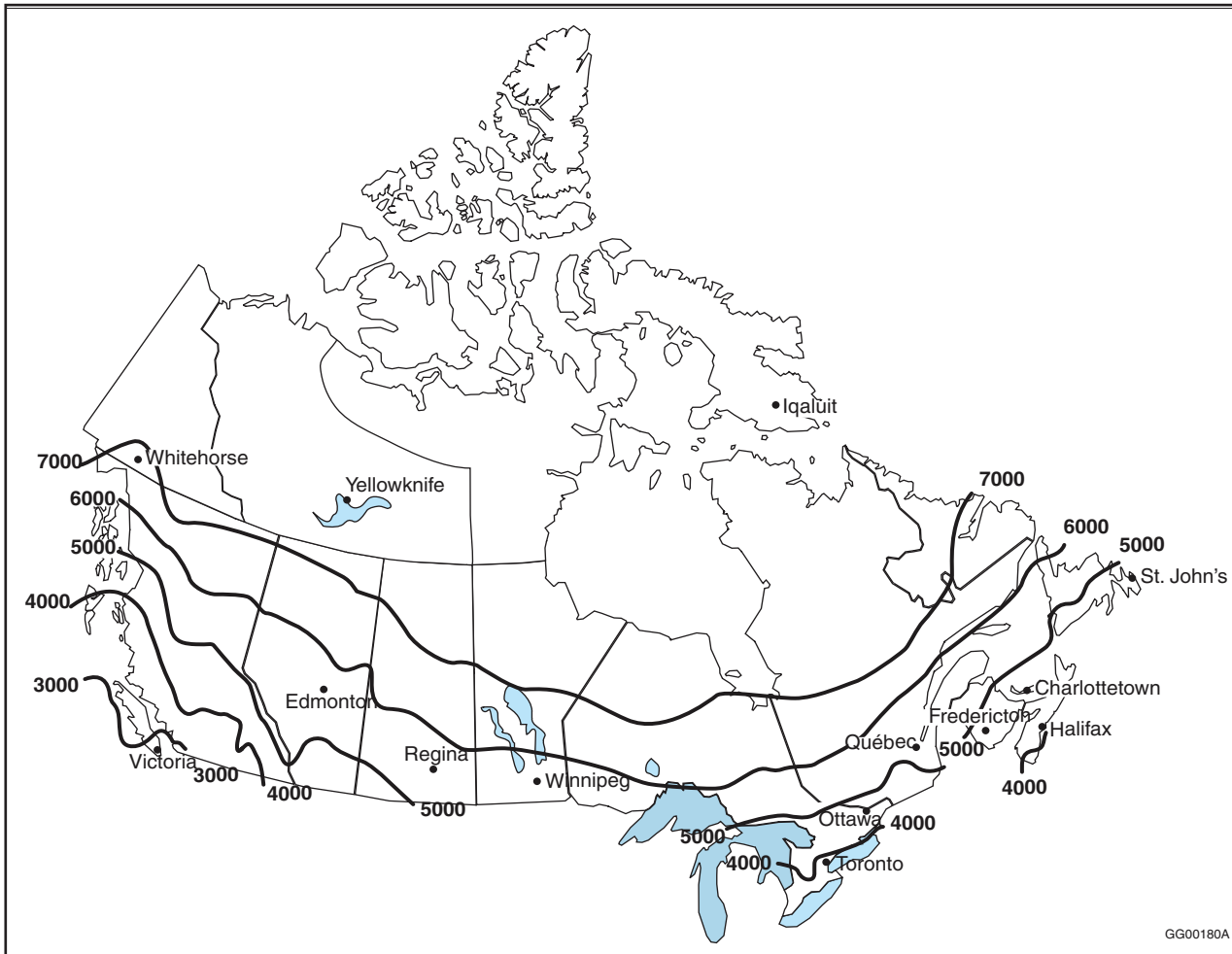


Figure 1-9 Canada average annual heating degree-days (C-degrees)<sup>1</sup>

(NEC Article 3.2.2.2.)

Above-ground Opaque Building Assembly	Heating Degree-Days of Building Location in Celsius Degree-Days					
	Zone 4: < 3000	Zone 5: 3000 to 3999	Zone 6: 4000 to 4999	Zone 7A: 5000 to 5999	Zone 7B: 6000 to 6999	Zone 8: ≥ 7000
	Maximum Overall Thermal Transmittance, in W/(m <sup>2</sup> •K)					
Walls	0.315	0.278	0.247	0.210	0.210	0.183
Roofs	0.227	0.183	0.183	0.162	0.162	0.142
Floors	0.227	0.183	0.183	0.162	0.162	0.142

Table 1-4 Overall Thermal Transmittance of Above-ground Opaque Building Assemblies

NOTE:

- (1) Except as provided in Sentences (2) and (3) and Sentence 3.2.1.3.(1), the overall thermal transmittance of above-ground opaque building assemblies shall be not more than that shown in Table 1-4 for the building or part thereof enclosed by the opaque building assembly, for the applicable heating-degree day category. (See Appendix A of National Energy Code of Canada for Buildings 2011.)
- (2) Where radiant heating cables or heating or cooling pipes or membranes are embedded in the surface of an above-ground opaque building assembly, this assembly shall have an overall thermal transmittance no greater than 80% of that required by Sentence (1). (See Appendix A of the National Energy Code of Canada for Buildings 2011.)<sup>2</sup>

1. ©NRC. 2013. "National Energy Code of Canada for Buildings 2011" Figure A-1.1.4.1.(1) in Appendix A of Division B

2. ©NRC. 2013. "National Energy Code of Canada for Buildings 2011" Article 3.2.2.2.

### 1.3.3 Insulation requirements for Canada

(CSA B214 Clauses 14.4.4.1, 14.4.4.2, 14.5.3 and 14.5.5)

When a poured concrete radiant floor system is installed in contact with the soil, insulation that complies with Clause 14.4.4.3 and has a minimum RSI value of  $0.9 \text{ m}^2\cdot\text{K}/\text{W}$  (R-value of  $5 \text{ h}\cdot\text{ft}^2\cdot\text{°F}/\text{Btu}$ ) shall

- (a) be placed between the soil and the concrete;
- (b) extend as close as practical to the outside edges of the concrete; and
- (c) be placed on all slab edges.

When a poured concrete radiant floor system is installed on grade, insulation that complies with

Clause 14.4.4.3 and has a minimum RSI value of  $0.9 \text{ m}^2\cdot\text{K}/\text{W}$  (R-value of  $5 \text{ h}\cdot\text{ft}^2\cdot\text{°F}/\text{Btu}$ ) shall be placed on all vertical slab edges.

When tubing is installed in the joist cavity, the cavity shall be insulated with material having an RSI value of at least  $2.1 \text{ m}^2\cdot\text{K}/\text{W}$  (R-value of at least  $12.0 \text{ h}\cdot\text{ft}^2\cdot\text{°F}/\text{Btu}$ ).

When tubing is installed above or in the subfloor and not embedded in concrete, the floor assembly shall be insulated with a minimum total insulated RSI value of  $2.1 \text{ m}^2\cdot\text{K}/\text{W}$  (R-value of  $12 \text{ h}\cdot\text{ft}^2\cdot\text{°F}/\text{Btu}$ ) below the tubing.<sup>3</sup>

3. ©CSA Group, B214-12. 2012. "Installation Code for Hydronic Heating Systems" Clauses 14.4.4 - 14.5.5

## 1.4 Panel coverings

Like insulation, a radiant panel's covering (e.g., gypsum for walls; carpet, tile or hardwoods for floors) also affects its ability to deliver heat to a conditioned space. Coverings with lower R-values provide less resistance to the radiation of heat from the panel into the conditioned space. Coverings with higher R-values will require higher supply temperatures or flow rates to deliver the same amount of heat to a space. To optimize water temperatures and promote efficient heat transfer, minimize the R-value of floor coverings and substrates (e.g., padding). Appendix G contains a table of R-values for various panel coverings. To determine the total R-value of a panel covering, add the R-values of its individual components.

### 1.4.1 Hardwoods

Use of hardwood flooring over radiant hydronic heating can be done successfully, provided proper consideration is given to the selection and installation of the hardwood. Detailed instructions for installation of hardwood flooring products over radiant floors are typically provided by manufacturers and should be closely followed. Generally speaking, there are four major considerations for selection and installation of hardwood floors over radiant hydronic heat:

1. Dimensional stability
2. Floor surface temperatures
3. Moisture
4. Subfloor

#### *Dimensional stability*

In general, floors with higher dimensional stability will hold up better under a greater range of temperatures and moisture levels. To choose a dimensionally stable hardwood floor that will remain attractive during the operation of radiant heating, consider the following:

- Milling: Quartersawn are preferable to plainsawn due to tendency to expand vertically instead of horizontally.
- Width: Select narrower boards over wider boards for less shrinking and swelling. Quartersawn wideplank flooring is acceptable, provided you consult the wholesaler or mill where it was produced to ensure proper storing and drying.
- Engineered products: More plies = greater stability. Typically higher stability than solid

plank products, though exceptions may exist for reclaimed woods that have a tighter pattern of growth rings. Thin profiles and lower R-values for some engineered products versus solid plank products can improve heat transfer to the room.

- Parquet products: Small pieces in these floors generally result in less expansion and contraction.
- Techniques to make gaps between boards less obvious: strong grain patterns, beveled edges, distressed finishes, dark colors.
- Species: Oak, walnut, ash, most soft woods and teak have a reputation for stability; hickory, beech, maple, Australian cypress and bamboo are less stable.

#### *Floor surface temperatures*

For many builders, a reluctance to install hardwood floors over radiant heat stems from problems associated with incorrect control of the floor surface temperatures. However, modern insulation and building techniques allow a radiant floor to stay cooler than the floor of the average sunroom while satisfying the room's heat load. When specifying a hardwood floor, the floor surface temperature should not exceed the lesser of manufacturer recommendations, or 85°F or as otherwise specified by local governing bodies. For CSA requirements see Section 1.4.2.

Also be careful when using multiple or high R-value area rugs over hardwood flooring. Your radiant heating system must be designed with this additional R-value taken into account in order to perform properly. If the system was designed for bare wood flooring, adding area rugs may lead to a situation where heat output is diminished.

### 1.4.2 Floor surface temperatures

(CSA B214 Clause 14.2.1)

Floor surface temperatures shall not exceed

- (a) 25°C (77°F) in areas where prolonged foot contact with the floor is likely;
- (b) 31°C (88°F) in dwellings or commercial space;
- (c) 33°C (91°F) in bathrooms, indoor swimming pools and foyers; and
- (d) 35°C (95°F) in radiant panel perimeter areas, i.e., up to 0.8 m (2.5 ft) from outside walls.<sup>4</sup>

4. ©CSA Group, B214-12. 2012. "Installation Code for Hydronic Heating Systems" Clause 14.2.1

### Moisture

To avoid cupping or crowning of the hardwood surface, it should be installed at a moisture content of 6-8%, over a subfloor within ~4% of the hardwood moisture content, as confirmed by a moisture meter. Indoor relative humidity levels should be between 30-50%. Ensuring these moisture and relative humidity levels is important regardless of whether hardwoods are installed over a radiant panel. To reach the targeted moisture content, store the hardwood inside, ideally for several weeks prior to installation. To dry the subfloor, allow the radiant system to run for at least a week before installing the hardwood; longer periods may be required by the hardwood manufacturer. In areas of large humidity fluctuations, install humidity control. In vacation homes with intermittent use, it is recommended to back-seal the boards prior to installation.

Sources of moisture from below:

- Inadequate moisture barrier
- Ground water wicking through the slab
- Unsealed subfloor

Sources of moisture from above:

- High relative humidity

If the moisture content of the wood is relatively high near the bottom of the plank, cupping upward will occur, exaggerating cracks.

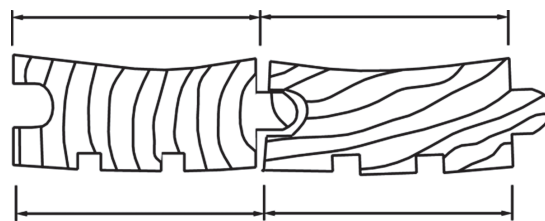


Figure 1-11 Cupping

If the moisture content is relatively high near the top surface of the plank, it will crown downward on the edges.

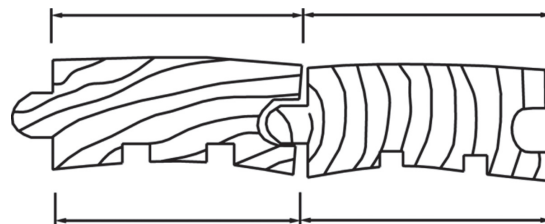


Figure 1-12 Crowning

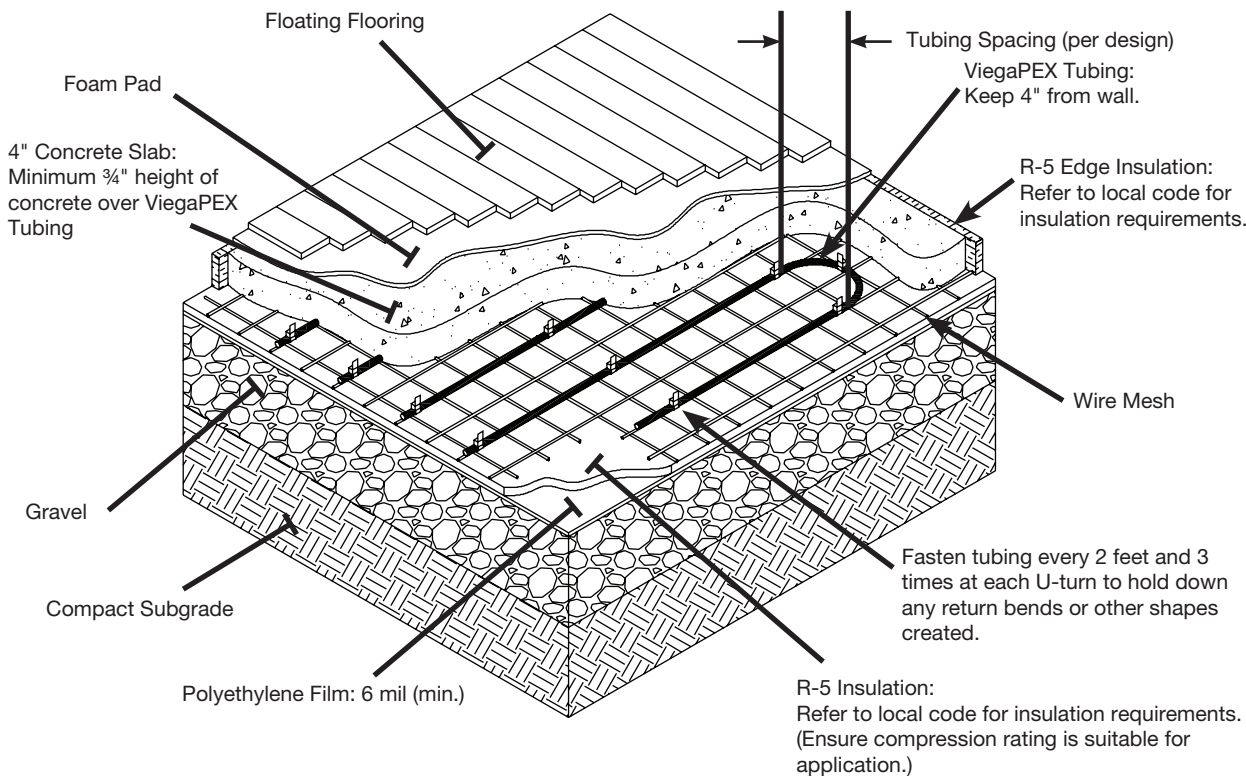


Figure 1-13  
Section through slab on or below grade installation with floating floor

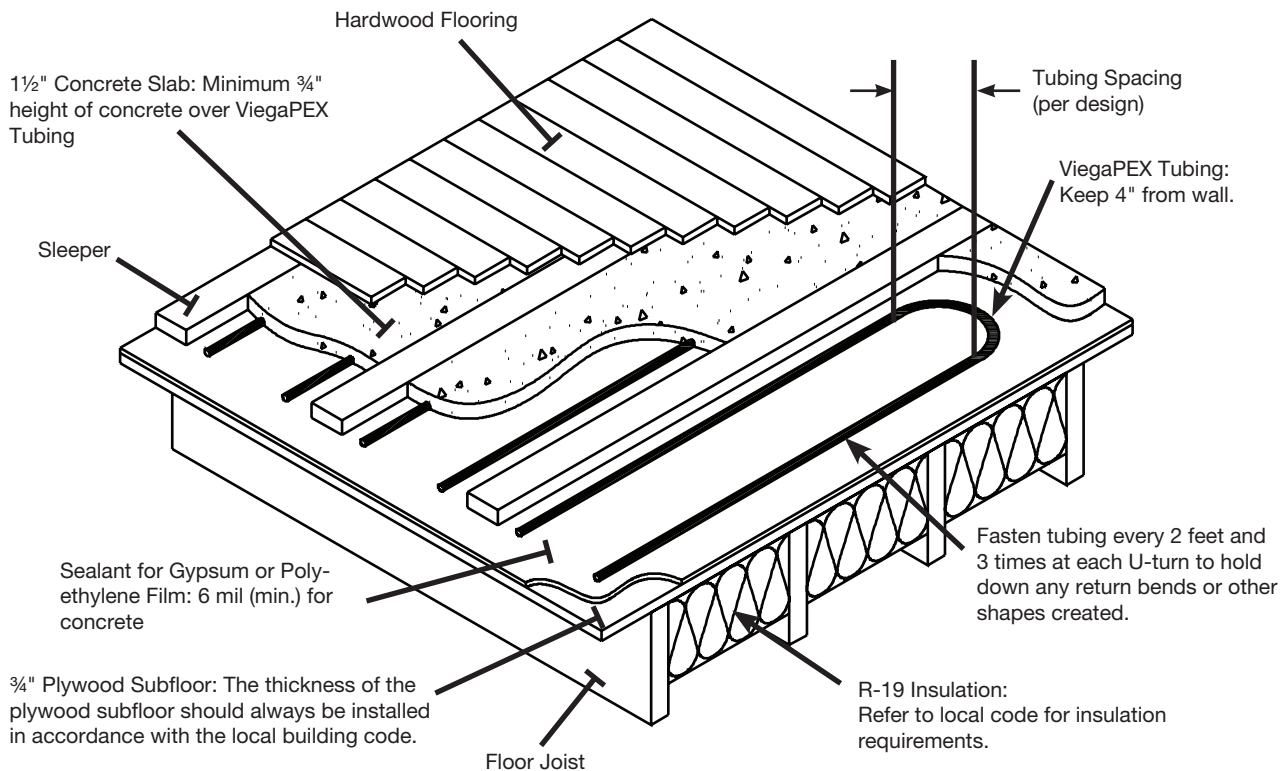


Figure 1-14 Hardwood floor over thin-slab and wood subfloor with sleepers

### Subfloor

Hardwood flooring can be installed directly over slab, thin-slab or wood subfloor applications; a wood subfloor is typically recommended by the National Wood Flooring Association. For applications over a slab, a floating floor assembly is recommended. For applications over a thin-slab, sleepers may be employed to assist with attachment. When selecting fasteners, ensure that the length will not penetrate tubing. If using adhesives that contact PEX tubing, contact Viega first to ensure that the adhesive will not damage the tubing. Examples of installations over slab and thin-slab are shown in the adjacent figures.

For more information on installation of hardwood surfaces over radiant flooring, consult the hardwood manufacturer.

### 1.4.3 Carpet

If selecting a carpet and underlayment, select materials that have a low R-value, to maximize heat transfer and comfort under foot. R-values for typical carpets and pads are provided in Appendix G.

The combined R-value of the underlayment and carpet should be determined prior to selection; however, the following provides general guidance for selecting low R-values.

#### Underlayment

- Typical: Prime and bonded urethane pads, which are the most typical carpet pads available, have R-values that can be 4x those of the best pads. Avoid these if possible.
- Better: Waffled rubber, frothed polyurethane, hair and jute, at roughly half the R-value of urethane pads.
- Best: Thin-slab rubber and synthetic fiber pads have the least resistance to heat transfer, at roughly 1/4 the R-value of urethane pads.

#### Carpet

- Thinner, denser, low-profile, commercial-type carpets (e.g., Berber) are ideal for the promotion of heat transfer.
- Synthetic material is generally preferable to wool. Wool tends to have hollow, highly insulating fibers that resist the flow of heat.



### 1.4.4 Tile, stone and marble

Selection of ceramic tile, stone or marble over radiant floor heating provides a surface that is cool to the touch in warmer months and warm to the touch in colder months. These coverings are thin, dense and conductive, meaning they transfer heat quite well. Although installation of hard coverings over a radiant panel may seem straightforward, the methods are evolving. Recommendations to avoid surface cracks include:

- Use a crack isolation or uncoupling membrane. This is a flexible layer that separates the tile, marble or stone from the thermal mass or the subfloor.
  - The membrane should be approved for use over radiant heat and have a low R-value.
  - When installing a crack isolation membrane with a thin-slab, the membrane should be installed under the thin-slab layer containing the tubing, not above it.
- Provide precise temperature control.
- Be sure that the subfloor and framing are as strong and rigid as possible.
- Cementitious backer boards may be used in some installation configurations.

- Refer to the flooring manufacturer and one of the following resources for installation guidance:
  - Standard Guidelines for the Design and Installation of Residential Radiant Panel Heating Systems. The Radiant Panel Association.
  - TCA Handbook for Ceramic Tile Installation. The Tile Council of North America.
  - The Marble Institute of America. This group has a more restrictive set of recommendations concerning the installation of marble or stone over radiant panels, including a minimum thin-slab thickness of 2½".

### 1.4.5 Concrete

A finished concrete surface can provide excellent heat transfer for a radiant system. Finishing options include staining, etching, engraving, stamping, polishing and painting. When installing a finished concrete floor, pay special attention to manufacturer's recommendations for location and frequency of expansion joints and control cuts. For additional information concerning concrete floors, visit [www.concretenetwork.com](http://www.concretenetwork.com).

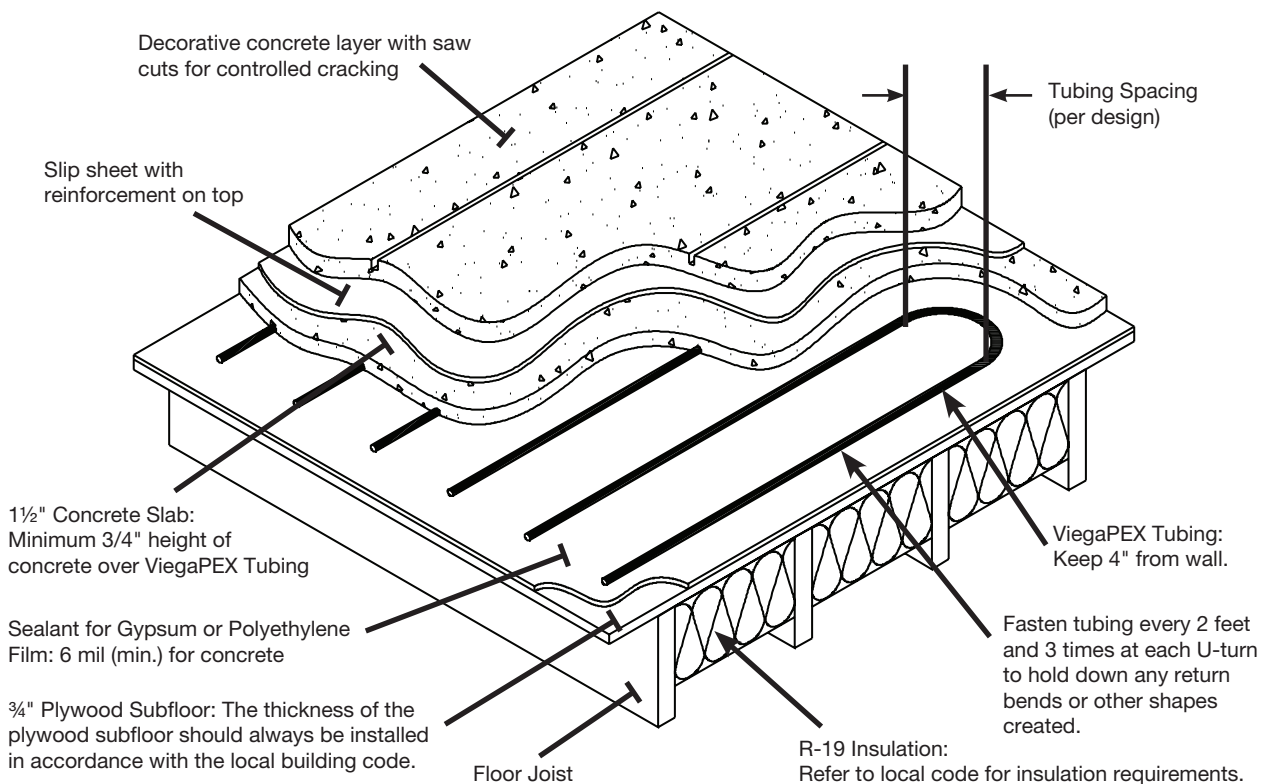


Figure 1-15 Decorative concrete over thin-slab and wood

### 1.4.6 Laminates

Laminate coverings contain multiple material layers, which typically include a coating, visible layer (e.g., thin strip of hardwood), fiberboard and a plastic bonding layer. Most consumers are familiar with wood surfaced laminate floors, but there are many other options that are now available, including tile, stone and vinyl surfaced. Typically thin, dense and highly conductive, laminate coverings generally pair well with radiant panels and have a track record of more than 20 years of operation in radiant flooring systems. Considerations for laminate floors include: lamination quality, surface temperature limitation of 85°F, and the moisture content of slabs when laminates are installed over a slab. Further, the North American Laminate Flooring Association ([www.nalfa.com](http://www.nalfa.com)) recommends that the radiant heating system run for at least 2 weeks prior to installing the laminate. Although most laminates are recommended for use over radiant heat, consult the manufacturer or wholesaler prior to installation.

### 1.4.7 Resilient surfaces

Resilient surfaces are composed of materials such as vinyl, linoleum, cork and rubber. Considerations for specifying and installing these surfaces over a radiant panel are as follows. For each of these products, see the manufacturer's installation instructions for specific requirements.

- General: Maximum recommended surface temperature of 85°F; use only approved adhesives for use over radiant panels; many manufacturers recommend avoiding use of Luan as an underlayment due to off-gassing that may discolor the flooring.
- Vinyl: Recommended room temperature during installation is typically  $\geq 65^{\circ}\text{F}$ .
- Linoleum: Has a higher coefficient of expansion than that of vinyl, so care should be taken when installing in large rooms with high heat losses or surface temperature fluctuations; slabs should be well cured, as linoleum is sensitive to the alkali conditions and moisture content within a concrete slab.
- Rubber: Select product approved for use over radiant panels; typical  $\frac{3}{8}$ " rubber has an R-value of 1.8, so it may be a good idea to keep the thickness at  $\frac{1}{4}$ " or less.
- Cork: Has higher R-value than many other resilient products; products thicker than  $\frac{3}{8}$ " are not recommended due to high R-values; if specifying cork, consider laminate cork floors for a lower R-value.

### 1.5 Heat load

The heating load of a space is the maximum rate of heat that the heating system must provide to maintain the space at a target temperature on a very cold day (called the design heating day). Ensure that the heat load calculation, commonly expressed in units of Btu/hr or Btu/hr/ft<sup>2</sup>, complies with local codes. The easiest way to perform a heating load calculation is through the use of readily available software, which typically requires inputs related to the home's insulation levels, air tightness and location. In this case, loads can be calculated on a room-by-room basis. See Section 5, Snow melting, to calculate heating load for snow melt systems. For other applications, such as turf conditioning, contact Viega Technical Services.

### 1.6 Design temperatures

System temperatures drive heat transfer, impact occupant comfort and can affect the durability of surfaces.

#### 1.6.1 Panel surface temperature

The ability of a radiant panel (e.g., floor, wall, ceiling, etc.) to transfer heat depends on the panel type, the panel surface temperature and the mean radiant temperature of the room. In most cases, the mean radiant temperature can be approximated by the room set point temperature. The heat output of panels is highly dependent on their design and should be determined from manufacturer literature. Panels that are coupled with room surfaces (e.g., floors and walls) have heat outputs that are easy to determine based on the panel surface temperature, panel surface area and room set point temperature:

Floors: 1.9 Btu/hr/ft<sup>2</sup>/°F  
 Walls: 1.4 Btu/hr/ft<sup>2</sup>/°F  
 Ceilings: 1.1 Btu/hr/ft<sup>2</sup>/°F

Simply multiply these radiant thermal transfer coefficients by the temperature difference (between the panel surface temperature and the room set point temperature) and by the square footage of the panel to calculate the Btu/hr that the panel can supply to the room. Or, use Figure 1-12 to determine the panel surface temperatures required to supply a room's heat load.

Maximum recommended panel surface temperatures are based on considerations for occupant comfort and durability of coverings, such as hardwood flooring. Recommended maximum surface temperatures are as follows:

- Floors: 85°F (including hardwood floors)
- Walls: 95°F (higher temperatures may be used where skin contact is not likely and materials are able to withstand the surface temperature)

If a targeted surface temperature exceeds these recommended limits, then consider reducing the heat load of the space by installing extra insulation and/or supply supplemental radiant panels for the space (e.g., walls, fan coils or radiators), or as otherwise specified by local governing bodies. For CSA requirements see Section 1.6.2.

### 1.6.2 Floor surface temperatures

(CSA B214 Clause 14.2.1)

Floor surface temperatures shall not exceed

- (a) 25°C (77°F) in areas where prolonged foot contact with the floor is likely;
- (b) 31°C (88°F) in dwellings or commercial space;
- (c) 33°C (91°F) in bathrooms, indoor swimming pools and foyers; and
- (d) 35°C (95°F) in radiant panel perimeter areas, i.e., up to 0.8 m (2.5 ft) from outside walls.<sup>5</sup>

### 1.6.3 Supply water temperature

Required supply water temperature varies based on the heat load of the space, the tubing spacing and size, and the materials used in the heated assembly. To identify the required supply water temperature, use the figures in Appendix H, based on the assembly type, or use Viega's Radiant Wizard. The figure in Appendix H requires you to know the R-value of the finished assembly located on the conditioned side of the radiant panel. R-values for typical materials (e.g., carpet, gypsum, tile, wood flooring, etc.) may be found in Appendix G.

Options that can lower the required supply temperature include:

- Selecting a covering with a lower R-value
- Decreasing the on-center spacing of tubing
- Increasing flow rate
- Increasing insulation on the unconditioned side of the radiant panel

By doing the opposite of any of these options, the required supply temperature is increased.

Maximum supply water temperatures are a function of the tubing and tubing enclosure/covering. For ViegaPEX Barrier and FostaPEX tubing, the supply water temperature should never exceed 180°F. This supply water temperature is typically only reached in baseboard heating applications. For radiant floor

heating applications, do not exceed the following supply temperatures:

- Thin-slab, gypsum-based products: 140°F
- Tile, stone or marble: 140°F
- Concrete: 150°F
- Contact flooring manufacturers for maximum supply water temperatures based on the application, which may be affected based on the type of adhesive used.

Remember, for all flooring applications, do not exceed a surface temperature of 85°F. In order to achieve a design supply temperature that is lower than that provided by the heat source, see Section 1.12, Controlling the system, for mixing options.

### 1.6.4 Temperature drop

The design temperature drop across the primary loop should be made with consideration given to heating source type (e.g., condensing or non-condensing boiler, ground source heat pump, etc.), first costs of the distribution system, and energy use of the system. Traditionally, a design temperature drop of 20°F has been selected across indoor circuits as a good balance between flow rate, tubing diameter and pump sizing.

Potential effects of increasing the temperature drop beyond 20°F include the ability to reduce flow rates, piping diameter and circulator size. System efficiency may also be increased by specifying a smaller, lower-power circulator. If the heat source is a condensing boiler or ground source heat pump, lower return water temperatures can increase the operating efficiency of the heat source.

Potential negative outcomes of increasing the temperature drop of the primary loop beyond 20°F include returning too low of a water temperature to the heat source (especially in the case of non-condensing boilers, which can fail prematurely if this is the case), and a more expensive installation if tubing spacing must be reduced to satisfy the load at the higher temperature drop. Ensure that the final temperature drop selected does not result in a return temperature to the heat source that is lower than that permitted by the manufacturer. Return temperature may be controlled with a thermostatic bypass or reset control that monitors return water temperature.

5. ©CSA Group, B214-12. 2012. "Installation Code for Hydronic Heating Systems" Clause 14.2.1

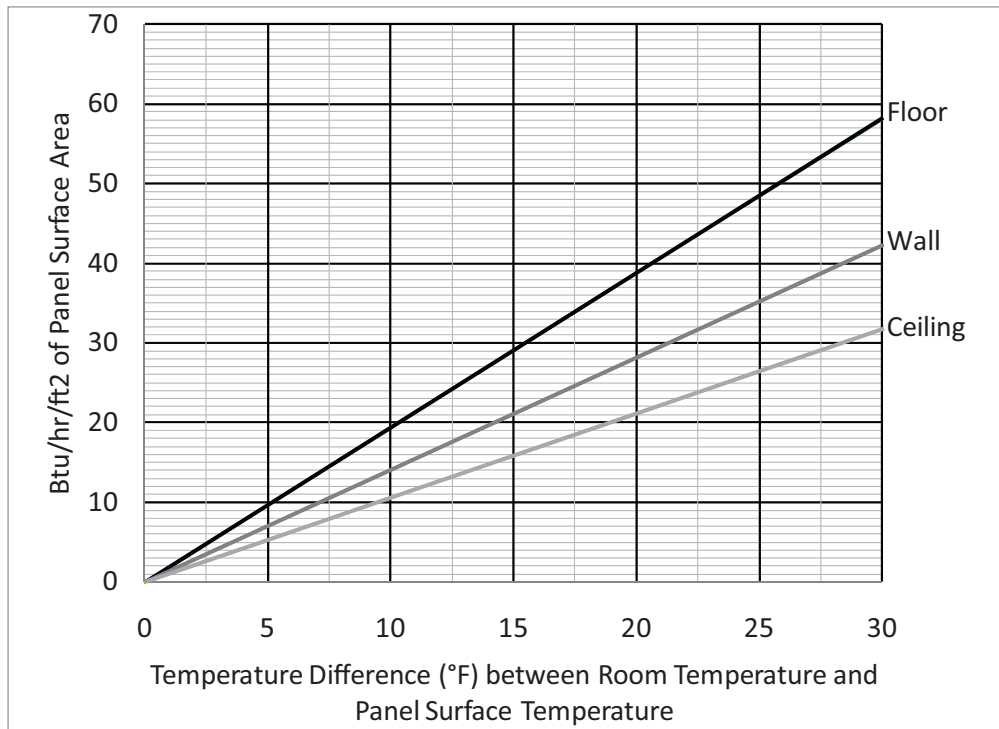


Figure 1-16 Heat load supplied per square foot of floor or wall emitter area based on  $\Delta T$  between the room set point temperature and the emitter surface temperature

Example Equation: A 300 ft<sup>2</sup> room has a heat loss of 40 Btu/hr/ft<sup>2</sup> of floor area. The design calls for 30% of the heating loss to be supplied through the wall and 70% of the heating loss to be supplied through the floor. The room design temperature is 68°F. Available surface area for the radiant panels is 100 ft<sup>2</sup> of wall area and 300 ft<sup>2</sup> of floor area. What surface temperature is required for the wall and the floor to satisfy the heat load?

1. Find the total heat loss of the room in Btu/hr by multiplying the floor area by the heat loss per floor area:  $40 \text{ Btu/hr/ft}^2 \times 300 \text{ ft}^2 = 12,000 \text{ Btu/hr}$
2. Find the heat loss supplied through the wall and floor on a per-square-foot basis.
  - a. Floor:  $(70\% \times 12,000 \text{ Btu/hr})/300 \text{ ft}^2 = 28 \text{ Btu/hr/ft}^2$
  - b. Wall:  $(30\% \times 12,000 \text{ Btu/hr})/100 \text{ ft}^2 = 36 \text{ Btu/hr/ft}^2$
3. Identify  $\Delta T$  between floor and room and wall and room.
  - a. Floor: Find 28 Btu/hr/ft<sup>2</sup> on the vertical axis of Figure 1-12, and move to the right until you intersect the line labeled "Floor." From this intersection, move down to the horizontal axis and read the  $\Delta T$  between the room temperature and the floor surface temperature. The result is 14.7°F.
  - b. Wall: Find 36 Btu/hr/ft<sup>2</sup> on the vertical axis of Figure 1-12 and move to the right until you intersect the line labeled "Wall." From this intersection, move down to the horizontal axis and read the  $\Delta T$  between the room temperature and the floor surface temperature. The result is 25.7°F.
4. Add the  $\Delta T$  for the floor and the wall to the room temperature to determine the required surface temperature.
  - a. Floor:  $14.7^\circ\text{F} + 68^\circ\text{F} = 82.7^\circ\text{F}$
  - b. Wall:  $25.7^\circ\text{F} + 68^\circ\text{F} = 93.7^\circ\text{F}$
5. Verify that surface temperatures are within design limitations.
  - a. Wall: 93.7°F is below the maximum recommended surface temperature range for walls.
  - b. Floor: 82.7°F is below the upper limit of the acceptable surface temperature for floors, which is 85°F.
  - c. Result: Design surface temperatures are less than or equal to the upper limit of the acceptable surface temperatures; the room heat load can be met successfully and comfortably with these design temperatures.

## 1.7 System documentation and operational instructions

(CSA B214 Clause 4.6.2)

The installer shall ensure that the system documentation and manufacturer's operational instructions are left near the primary heating equipment or, if that is not practical, near the main electrical distribution panel, in order for service and maintenance personnel to have access to the documentation and instructions.

**NOTES:**

- (1) *Examples of information that should be provided in the documentation of the system for hydronic space heating include*
  - (a) *a room-by-room heat loss calculation in kW (Btu/h);*
  - (b) *the heat output of the heat-distribution unit in kW (Btu/h);*
  - (c) *the system design water temperatures in °C (°F);*
  - (d) *the pipe size in mm (nominal size NPS, in) and total length of piping in m (ft); and*
  - (e) *the system head loss and flow rates in kPa and L/s (psi and gpm).*
- (2) *Examples of information that should be provided in the documentation of the system for radiant heating include*
  - (a) *a room-by-room heat loss calculation in kW (Btu/h);*
  - (b) *the floor area in m<sup>2</sup> (ft<sup>2</sup>);*

- (c) *the total usable panel area in m<sup>2</sup> (ft<sup>2</sup>);*
  - (d) *the heat output density in W/m<sup>2</sup> ((Btu/h)/ft<sup>2</sup>) of panel area;*
  - (e) *the radiant heating panel supply water temperature in °C (°F);*
  - (f) *the pipe size in mm (nominal size NPS, in), maximum spacing between the lengths of piping in mm (in), and total length of piping in m (ft);*
  - (g) *the minimum number of heating loops;*
  - (h) *the boiler supply water temperature in °C (°F);*
  - (i) *the auxiliary heat required in kW (Btu/h);*
  - (j) *the RSI value in m<sup>2</sup>•K/W (R-value) of the floor coverings;*
  - (k) *the RSI value m<sup>2</sup>•K/W (R-value) of the insulation under and at the edges of the radiant panel;*
  - (l) *the outdoor design temperature in °C (°F);*
  - (m) *the floor surface temperatures in °C (°F); and*
  - (n) *the system friction loss and flow rate in kPa and L/s (psi and gpm).*
- (3) *Additional information for documentation of the system is presented in Figures A.1 and A.2.*
  - (4) *Attempts should be made to instruct the user in the safe and correct operation of the system.<sup>6</sup>*

## 1.8 Piping

In most cases, the piping system uses primary piping, secondary piping and panel piping to distribute heat. Primary piping is the main piping that supplies and returns fluid to the heat source. Secondary piping is piping that is either directly connected to the primary piping or originates off manifolds fed by primary piping, but is not located within a radiant panel. Panel piping is piping that is used within the radiant panel, whether floor, wall or ceiling.

6. ©CSA Group, B214-12. 2012. "Installation Code for Hydronic Heating Systems" Clause 4.6.2

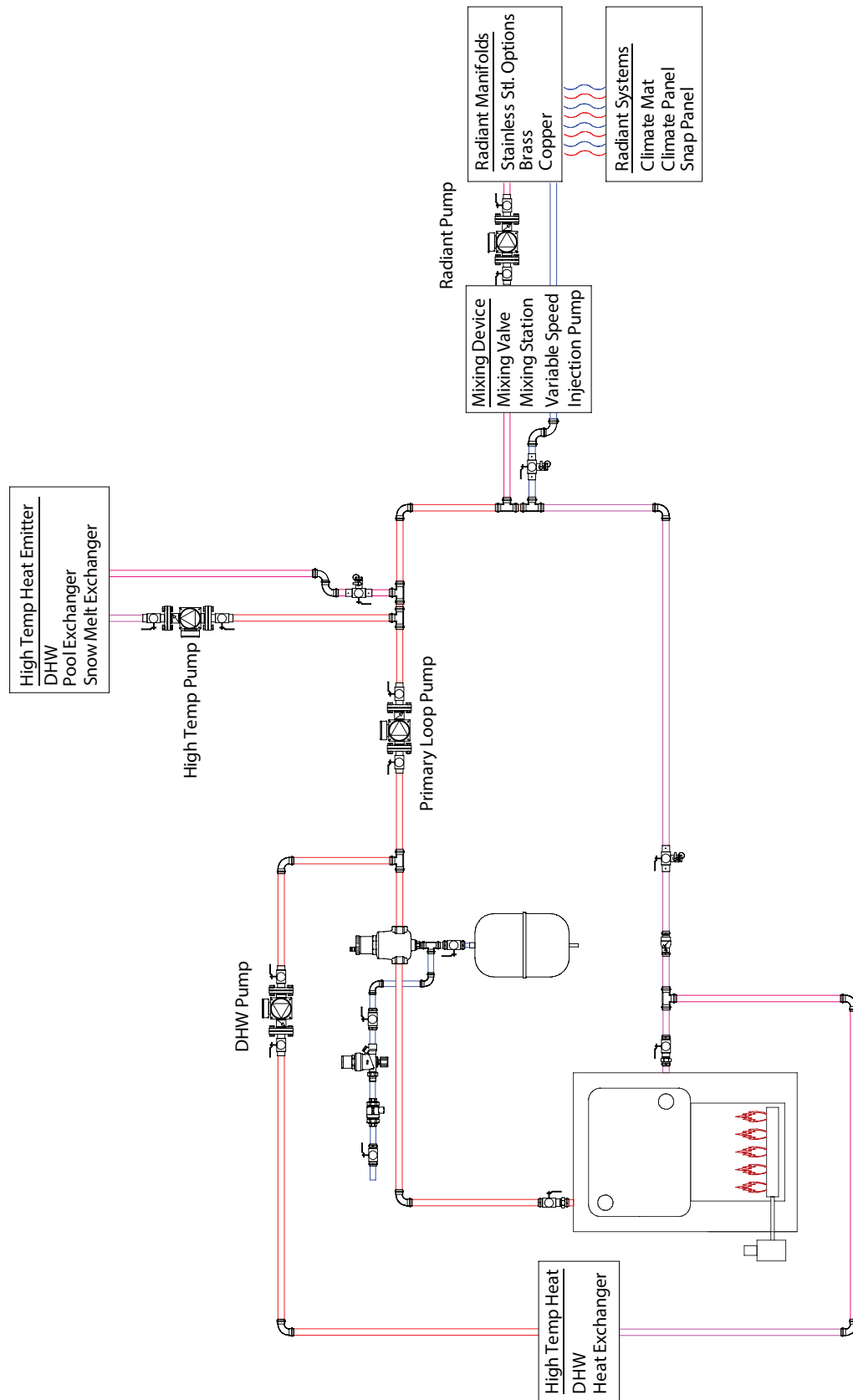


Figure 1-17 Anatomy of a heating system

### 1.8.1 Primary/secondary

When sizing primary piping, maintain a fluid velocity of 2.0 to 4.0 feet per second at a temperature drop that will satisfy the total design heat load of the system. This velocity range is ideal for two reasons. The first is that maintaining fluid flow through the piping above 2 feet per second will facilitate separation of air from the fluid – extending its useful life. Also, to enable the primary piping to operate quietly, fluid flow should not exceed 4 feet per second by any significant amount. Higher fluid flow velocities can contribute to the erosion of copper components within the system.

To optimize control of water temperatures, maintain design flow rates and properly size circulators, it is important to design the piping system to provide hydraulic separation between primary and secondary piping. Designing for hydraulic separation permits greater control over heat delivery and reduces interference that could otherwise result between circuits. Options to achieve hydraulic separation include:

- Hydraulic separators with air and sediment separation functions: See manufacturer literature for sizing guidance.

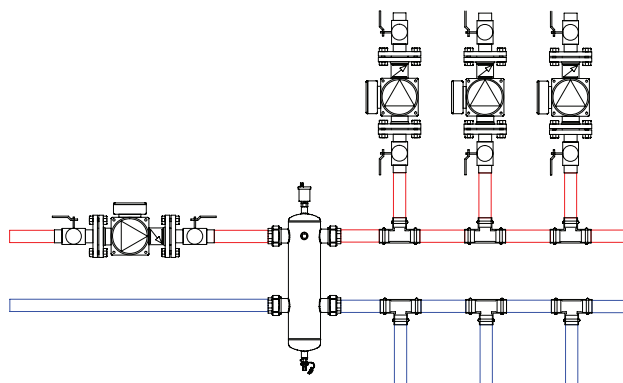


Figure 1-18 Hydraulic separator

- Closely spaced tees: Space tees less than 4 pipe diameters apart and less than 6 pipe diameters from the closest change of direction to achieve design flow rates through secondary piping. See Figure 1-17.

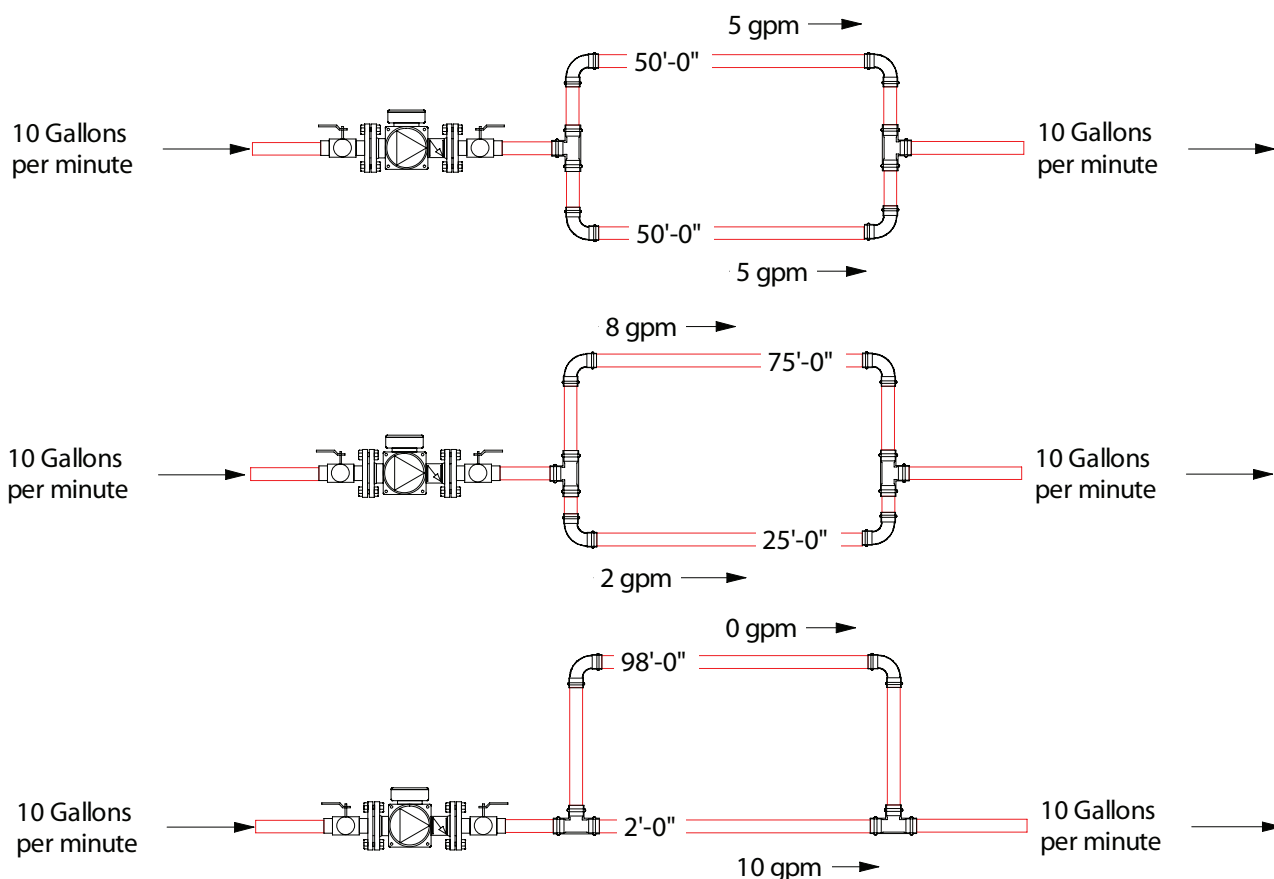


Figure 1-19 Closely spaced tees

- Low loss header: See manufacturer literature for sizing guidance.

For applications where the working fluid is 100% water, use Table 1-5 to identify the heat carrying capacity of the primary piping at various flow rates. For glycol solutions, see Section 1.11.2.2, Glycol primary piping sizing.

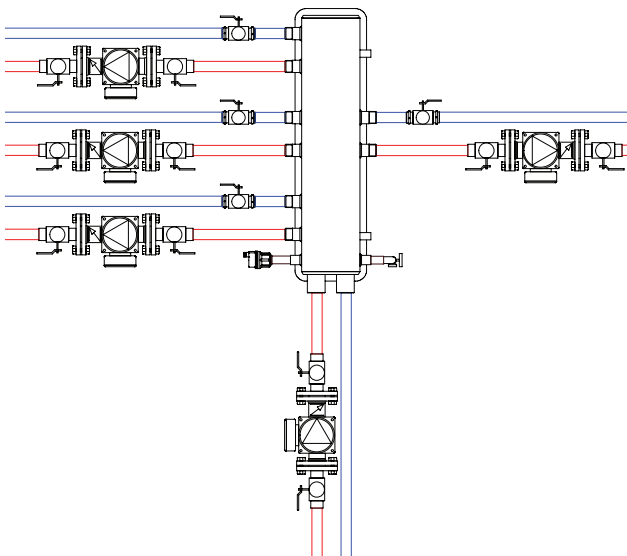


Figure 1-20 Low loss header

Application	Copper Tube Size (In.)	Recommended Flow Rate Range (GPM)	Temperature Drop (°F)		
			10	20	30
			Heat Carrying Capacity Range (Btu/hr)		
Residential & Light Commercial	¾	3.7-7.5	18,500-37,500	37,000-75,000	55,500-112,500
	1	7-12	30,500-62,500	61,000-125,000	91,500-187,500
	1¼	10-18	45,500-93,500	91,000-187,000	136,500-280,500
Commercial, Industrial, Agricultural	1½	13-26	65,000-130,000	130,000-260,000	195,000-390,000
	2	22-44	110,000-220,000	220,000-440,000	330,000-660,000
	2½	33-68	165,000-340,000	330,000-680,000	495,000-1,020,000
	3	49-96	245,000-480,000	490,000-960,000	735,000-1,440,000
	3½	65-130	325,000-650,000	650,000-1,300,000	975,000-1,950,000
	4	82-165	410,000-825,000	820,000-1,650,000	1,230,000-2,475,000
	5	130-260	650,000-1,300,000	1,300,000-2,600,000	1,950,000-3,900,000
	6	180-370	900,000-1,850,000	1,800,000-3,700,000	2,700,000-5,550,000
	8	320-640	1,600,000-3,200,000	3,200,000-6,400,000	4,800,000-9,600,000
10	500-1000	2,500,000-5,000,000	5,000,000-10,000,000	7,500,000-15,000,000	

Table 1-5 Acceptable primary piping size and corresponding heat carrying capacity at various flow rates and system temperature drops for 0% glycol solutions. For each pipe size and corresponding temperature drop, the low end of the heat carrying capacity range corresponds with the low end of the recommended flow rate range (2.0 fps, regardless of GPM), and the high end of the recommended flow rate range corresponds with the high end of the heat carrying capacity range (4.0 fps, regardless of GPM). GPM = gallons per minute.



### 1.8.2 Panel piping

Panel piping is piping that is used within the radiant panel, whether floor, wall, ceiling or other location. Viega provides two types of panel piping, ViegaPEX Barrier and FostaPEX tubing. ViegaPEX Barrier includes 4 layers. The first layer is the cross-linked, high-density polyethylene. The second layer is an adhesive for the third layer, the ethylene vinyl alcohol layer (EVOH oxygen barrier). The fourth layer is another very thin layer of polyethylene, put on the outside to protect the EVOH layer from damage. EVOH is highly resistant to the passage of oxygen. ViegaPEX Barrier is recommended for hydronic radiant heating, cooling and snow melting systems utilizing water or a water/glycol mix as the heat or cold transfer media. Tubing may be installed in concrete, gypsum-based lightweight concrete, sand, asphalt (in accordance with special guidelines) in or under wood flooring or behind wallboard or plaster. ViegaPEX Barrier may also be used as transfer lines for baseboard heating systems with a maximum operating temperature of 200°F @ 80 psi.

Viega's FostaPEX cross-linked polyethylene tubing provides the benefits of flexibility and shape retention. The multi-layered construction of the FostaPEX tubing is made from one full dimensional inner PEX core with an aluminum and outer PE layer surrounding it. This construction allows the inner layer alone to meet all temperature and pressure requirements of the system. The aluminum layer allows tubing to be bent into position and remain in position when released. FostaPEX tubing is intended and recommended for use in hot and cold potable water distribution systems and hydronic radiant heating and cooling systems. Like ViegaPEX Barrier, which has a barrier layer that resists the passage of oxygen through the wall of the tubing, the aluminum layer in FostaPEX offers even higher resistance to oxygen permeation in radiant heating applications. FostaPEX tubing can also be used in water service applications and is virtually impermeable to any soil contaminants. Design temperature and pressure ratings for FostaPEX are 160 psi @ 73°F, 100 psi @ 180°F, and 80 psi @ 200°F. Detailed information on FostaPEX and ViegaPEX Barrier are provided within Viega's Tech Data sheets.

For panel piping, typical tubing spacing ranges from 6" to 12" on center, depending on the application. By reducing tubing spacing, you can increase the heat delivered to a space while encouraging comfortable, even heating of the

assembly. The tightest spacing (i.e., 6") is generally for high heat loads or to support floor drying and occupant comfort in areas where periodic moisture is expected – areas such as bathrooms and foyers. Spacing at the high end of the range (i.e., 12") is typically reserved for areas with low heat loads, such as well-insulated garages that will be maintained at low temperatures; well-insulated, below-grade slabs; or interior zones of large commercial buildings.

Tubing diameter has a larger impact on system pressure (head) and circulator selection than it does on heat delivery to a space. Larger-diameter tubing results in lower head and the potential to downsize circulators, which can save pumping energy. For indoor applications using Viega products, the most common diameters specified in panel piping are ½" and 5/16" diameters (Table 1-6). When very long circuits are specified (e.g., commercial and industrial applications with circuits of 500' or greater), 5/8" or ¾" tubing is common.

The maximum tubing length per circuit should be limited to keep pumping head within a reasonable range. Maximum recommended tubing lengths are based on the circuit's heating load, fluid composition, temperature drop and tubing diameter. Use Table 1-7 for general guidance on maximum recommended tubing length for common installation scenarios. For maximum recommended tubing lengths in snow melt applications, see Section 5.3.

#### *Managing oxygen (O<sub>2</sub>)*

Left unchecked, the presence of oxygen in radiant piping systems can cause serious problems, including corrosion of ferrous components, damage to circulators, reduction of heat transfer and system flow rates, and increase of system pressure and noise. O<sub>2</sub> entry points into a radiant piping system include joints, dissolved O<sub>2</sub> in the fluid itself and tubing without O<sub>2</sub> barrier. Options for managing O<sub>2</sub> include completely isolating any ferrous components (iron and steel) from the rest of the piping via a heat exchanger, use of only non-ferrous components in the system, or Viega's recommendation – the use of O<sub>2</sub> barrier tubing, such as ViegaPEX Barrier or FostaPEX. The use of O<sub>2</sub> tubing is recommended for its cost effectiveness, proven track record and higher system operating efficiency than would otherwise be achieved through a heat exchanger designed for this purpose.

Application	Location	On-Center Spacing (in., typical)	Nominal Tubing Size (in., typical)
In-Slab	On or Above-Grade Living Areas	9"	1/2" or 5/8"*
	Below Grade	9" – 12"	1/2" or 5/8"*
	Bathrooms and High-Output Areas	6" – 9"	3/8" or 1/2"
	Gypsum-concrete (thin-slab)	6" – 9"	1/2"
	Garages and Workshops, Interior Zones of Large Commercial Buildings or Warehouses	12"	1/2", 5/8", or 3/4"
Dry Mass	Above-Subfloor Panels	7" – 10"	5/16"
	Below-Subfloor (Residential Only)	8"	3/8" or 1/2"
	Wall Panels	7" – 10"	5/16"

Table 1-6 Typical spacing and nominal tubing size, by application

\*Used more commonly in commercial applications.

Tubing	≤ 25 Btu/hr/ft <sup>2</sup>	>25 Btu/hr/ft <sup>2</sup>
5/16"	250	200
3/8"	300	250
1/2"	400	350
5/8"	500	450
3/4"	800	750

Table 1-7 Maximum recommended circuit lengths in feet, assuming a temperature drop of ≥ 20°F, 100% water, and air temperature of 68°F

### Maximum loop lengths

(CSA B214 Table 1) See clause 14.3.2

Nominal Tube Size, in	Maximum Loop Length, m (ft)
1/4	39 (125)
5/16	61 (200)
3/8	76 (250)
1/2	91 (300)
5/8	122 (400)
3/4	152 (500)
1	229 (750)

Table 1-8 Maximum length of continuous tubing from a supply-and-return manifold arrangement

**NOTE:** Data for this table were compiled by the B214 Technical Committee and are based on manufacturers' recommendations and good engineering practice.<sup>7</sup>

### CSA B214 Clause 14.3.2

The maximum length of continuous tubing from a supply-and-return manifold arrangement shall not exceed the lengths specified by the manufacturer or, in the absence of manufacturer's specifications, the lengths specified in Table 1. Actual loop lengths shall be determined by spacing, number of loops and pressure drop requirements, as specified in the system design.

7. ©CSA Group, B214-12. 2012. "Installation Code for Hydronic Heating Systems" Table 1

### 1.8.3 Piping configurations

Designers have many different options for piping configurations, including series, parallel with direct return and parallel with reverse return.

Series piping connects manifolds or radiant panels (i.e., radiators) from end to end, creating one continuous loop. One potential disadvantage of series piping is that the supply water temperature continues to fall as it flows to each successive radiant panel. Series piping of floor panels is not advised.

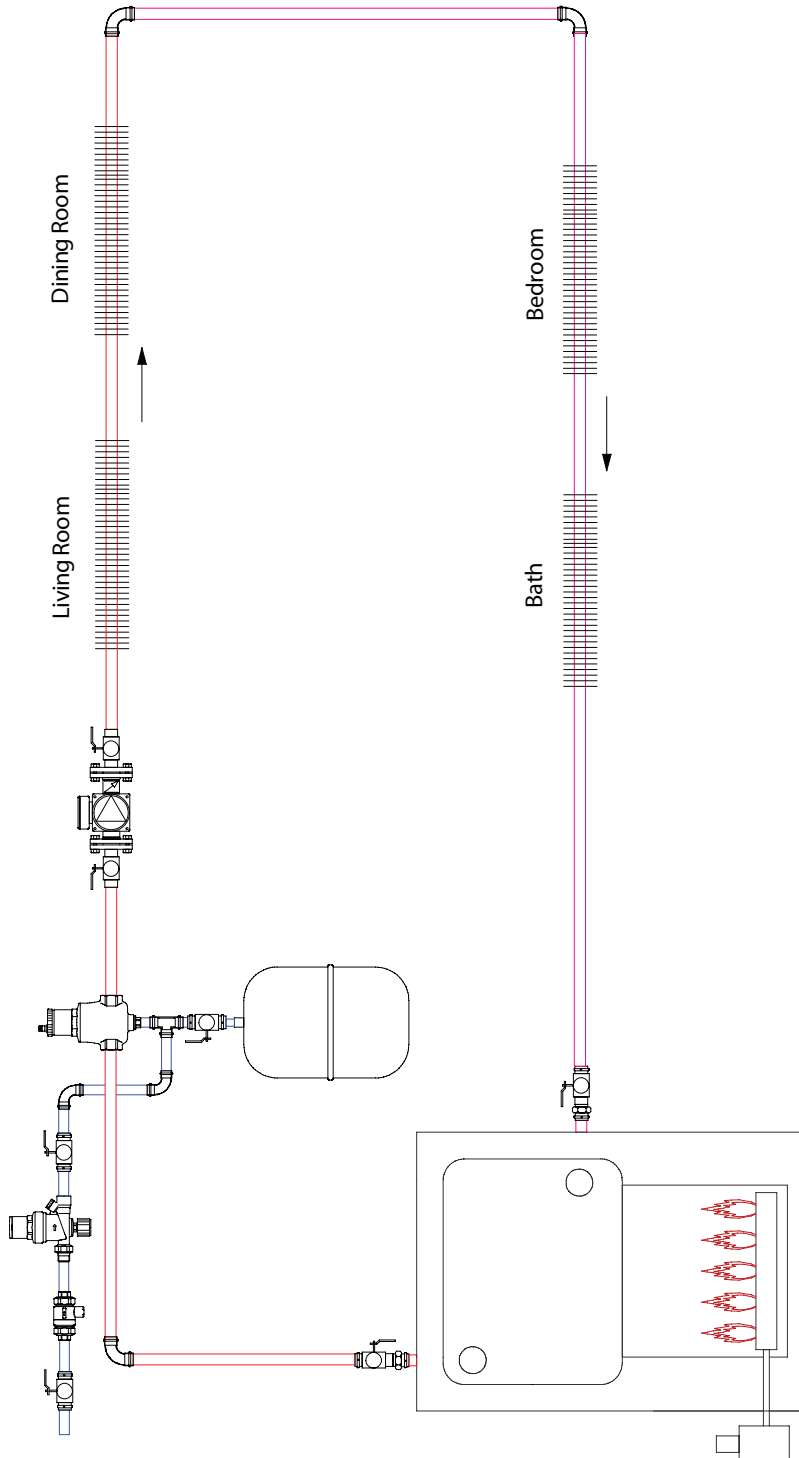


Figure 1-21 Series piping

Parallel piping has two or more branches tied into a common supply and common return. Parallel piping configurations provide for equal supply temperatures across secondary or panel piping. Parallel piping can be configured as direct return or reverse return.

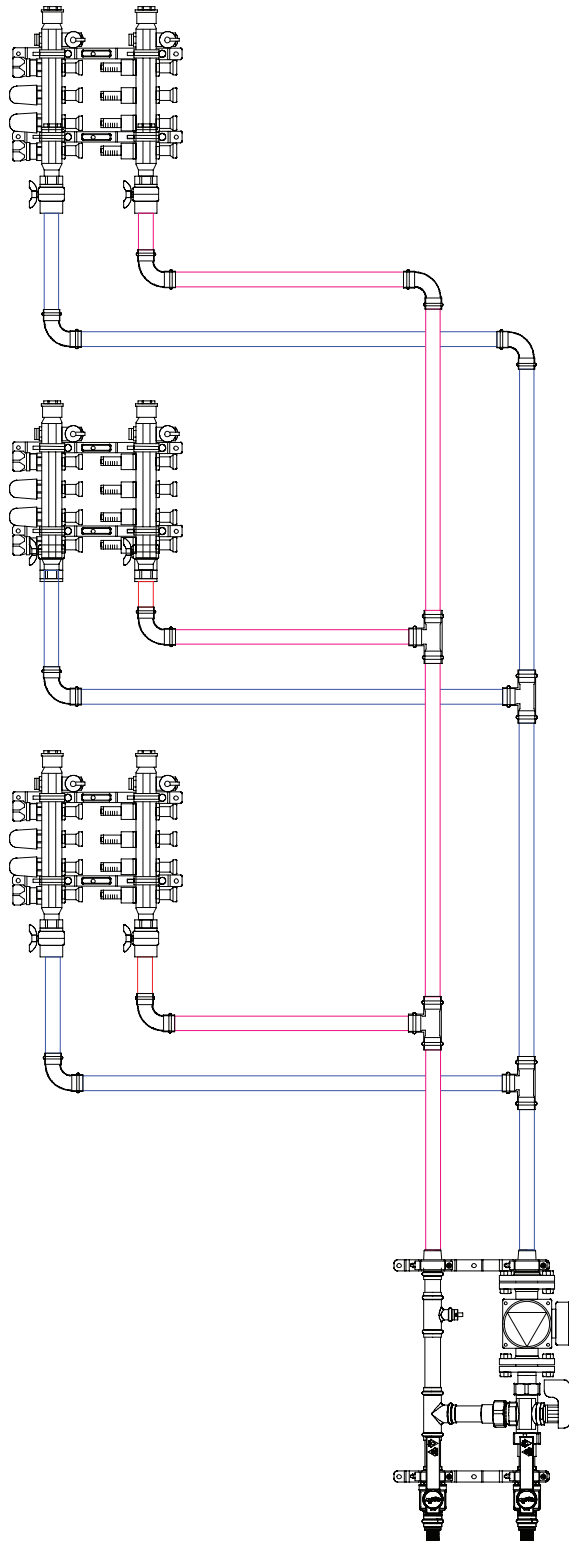


Figure 1-22 Manifolds configured in parallel

Direct return parallel piping occurs when the first branch connected on the supply is also the first branch connected on the return. This configuration will generally require balancing valves to ensure each parallel branch receives the design flow.

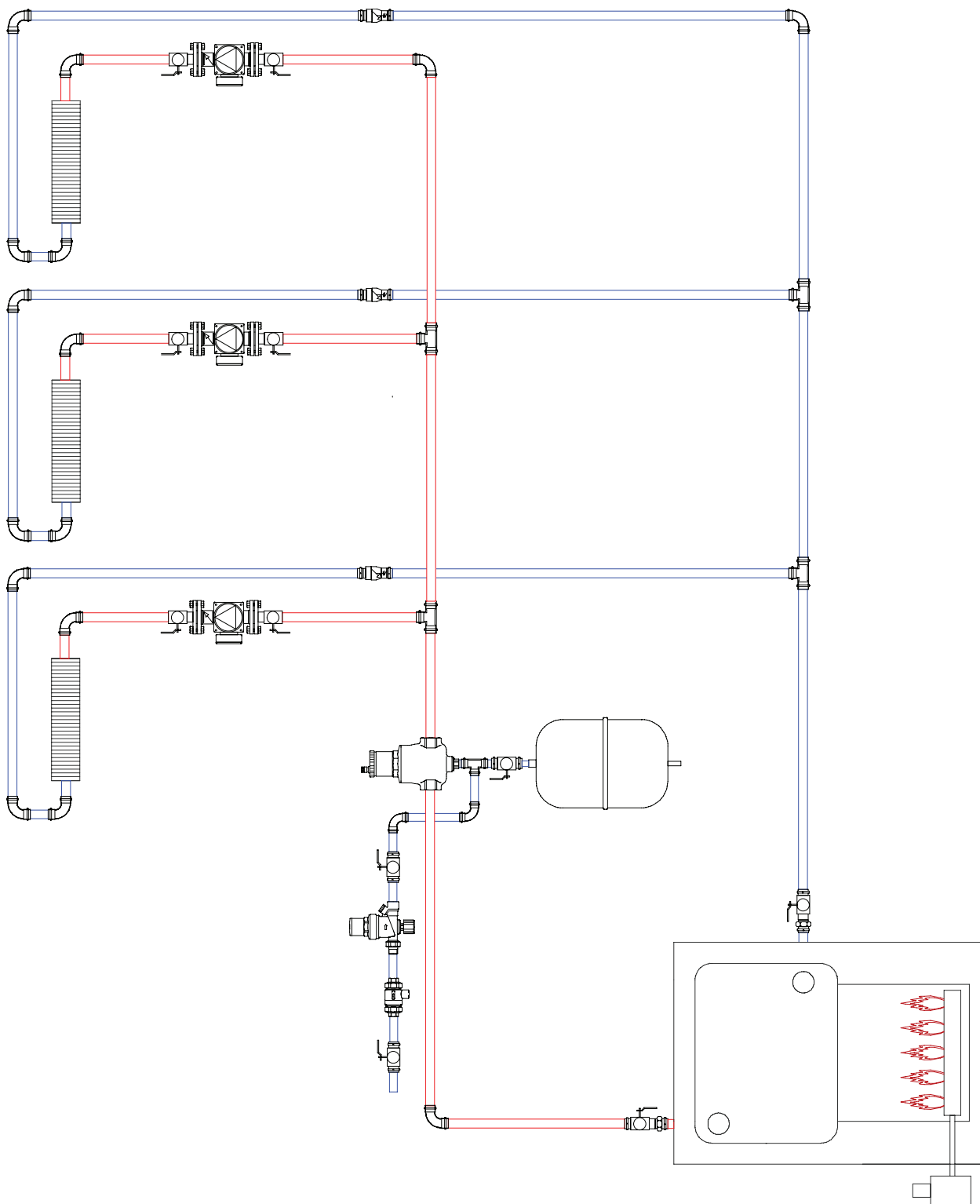


Figure 1-23 Direct return piping. With individual circulators balancing valves are not required.

Reverse return parallel piping occurs when the first branch connected on the supply is also the last branch connected on the return. This configuration can aid in providing balanced flow throughout each parallel branch by facilitating the installation of equivalent tubing lengths that cannot be installed in direct return designs. Based on these equivalent lengths, reverse return piping may not require balancing valves to achieve design flow rates.

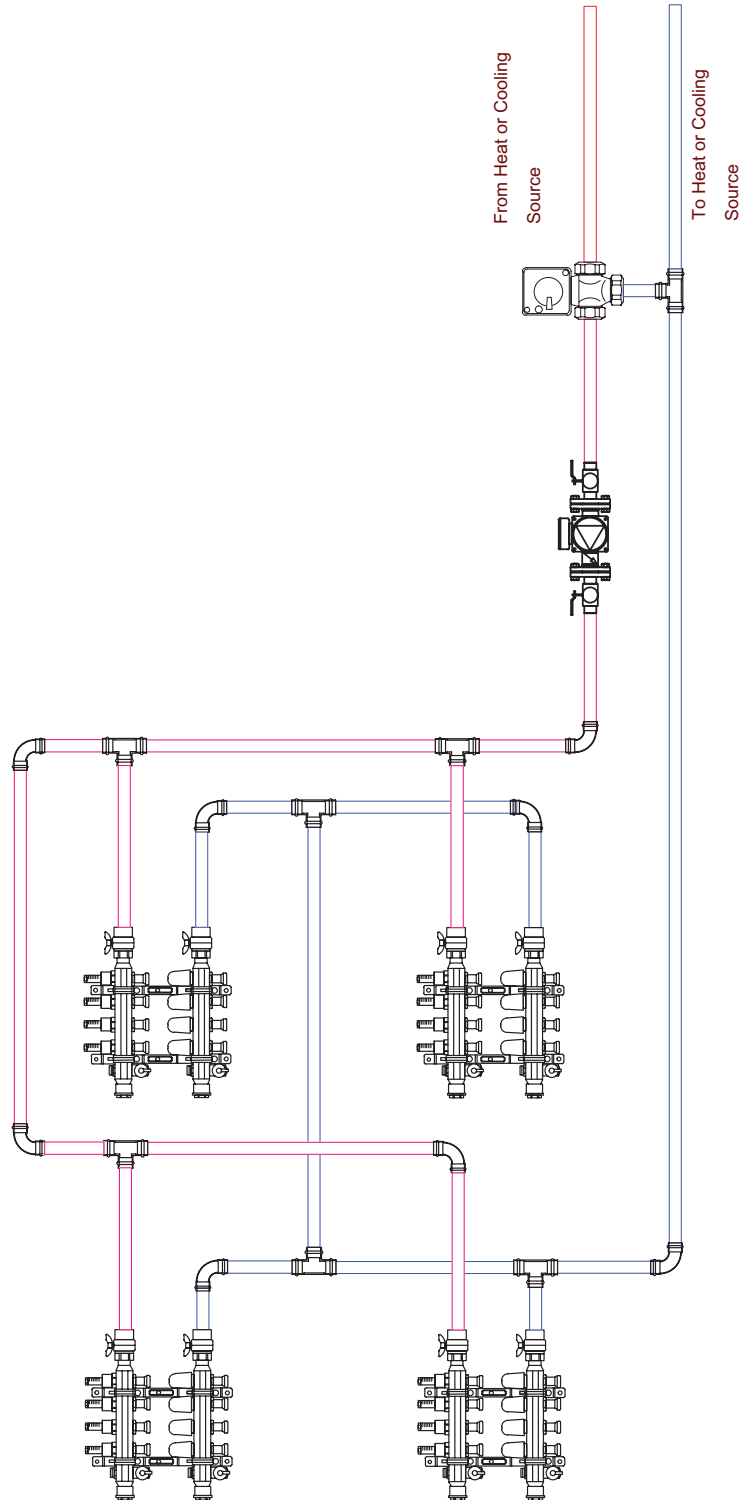


Figure 1-24 Reverse return piping

## 1.9 Circulator pumps

Selection of a system's circulator pump(s) is an important step in the overall system design because it directly affects the system's heating capacity and its electrical energy use. Under-sizing a circulator can result in failure to satisfy heating loads, and over-sizing a circulator can result in wasted energy and increased expenses for the building owner, as well as premature failure and unwanted noise. Proper selection of circulators is based upon the system design flow rates and the relevant pressure drop.

### 1.9.1 Flow rates

Circuit flow rates are determined based on the heat load of a space, the composition of the radiant panel assembly and the temperature drop of the system. To estimate the flow rate required, you may use the following equation:

$$GPM = \frac{\text{Total Design Heat Load (Btu/hr)}}{\Delta T \cdot 8.01 \cdot C_p \cdot P}$$

where

$\Delta T$  is the system temperature drop from supply to return.

$C_p$  is the specific heat of the fluid, taken at the average of the supply and return temperature (Btu/lb/°F). For 100% water solutions in hydronic heating applications, use a value of 1.0 for the specific heat. For the specific heat of glycol solutions, see Table 1-9 for propylene glycol or Table 1-12 for ethylene glycol.

8.01 is a constant to convert between units.

$P$  is the density of the fluid, taken at the average of the supply and return temperature (lbs/ft<sup>3</sup>). For the density of a 100% water solution in hydronic heating applications, see the 0% glycol column in Table 1-11 or Table 1-13. For the density of glycol solutions, see Table 1-11 for propylene glycol or Table 1-13 for ethylene glycol.

For quick approximations in all-water systems, you can use the following equation:

$$GPM = \frac{\text{Total Design Heat Load (Btu/hr)}}{\Delta T \cdot 500}$$

Here, the constant of 500 is calculated by multiplying 8.01\*1.0\*62.4 (conversion constant\*specific heat of water\*density of water at 68°F).

For primary and secondary loops or distribution piping, ensure that the targeted flow rate corresponds to a velocity of between 2 and 4 feet per second by selecting a piping diameter to accommodate the design flow rate within this velocity range. (See Table 1-5 for more details.)

### 1.9.2 Pressure drop

Circulators must be sized for the pressure drop that they will experience at their design flow rate. The first step in calculating the pressure drop associated with a circulator is identifying the network of piping and accessories (valves, fittings, mixing devices, expansion tanks, air separators, etc.) that corresponds with each circulator.

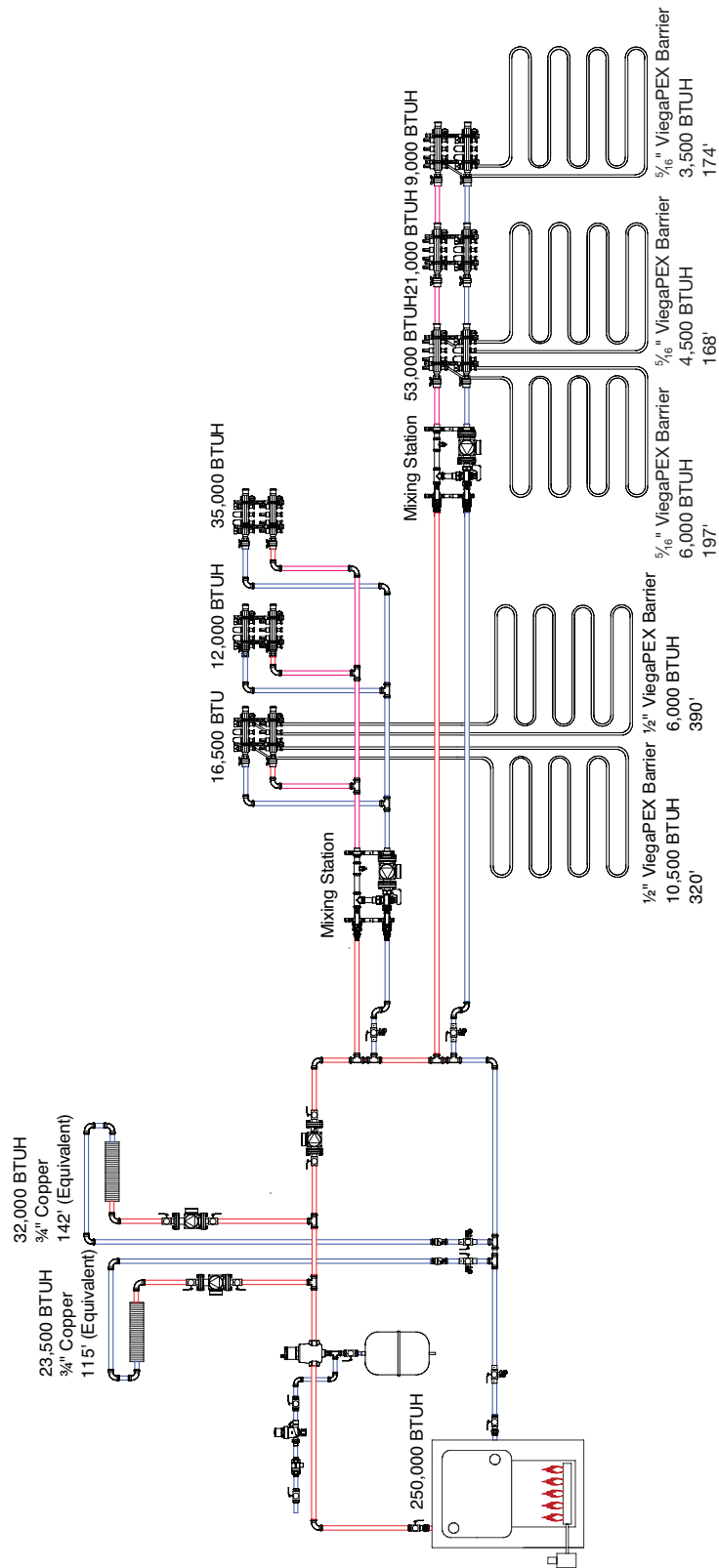


Figure 1-25 Residential piping configuration showing primary, secondary and panel piping associated with each circulator



Once a circulator's network is identified, the basic theory for sizing the circulator is to size it for the maximum flow rate seen at the circulator's location and at the total pressure drop that the working fluid experiences across the circulator's network. When dealing with sections of parallel piping within a network, the maximum pressure drop seen through the parallel section is the greatest pressure drop of any one section. When dealing with series piping within a network, the maximum pressure drop seen through the series section is the sum of the pressure drop of the components in series.

To calculate the pressure drop in secondary and panel piping within a circulator's network, take the following steps:

- Determine the length of each panel piping circuit off each manifold within the circulator network.
- Using the pressure drop tables that correspond to the system's glycol content and tubing size, multiply the pressure drop per foot (obtained from the table using the circuit flow rate) by the circuit length. Because a manifold's circuits are in parallel, identify the circuit with the largest pressure drop at each manifold.
- To the largest circuit pressure drop at each manifold, add the pressure drop through the corresponding supply and return manifolds.
- For each manifold within the circulator network, add the pressure drop of the secondary supply and return piping located between the primary piping and the manifold. For series piping between the primary piping and manifold, add the pressure drop of adjacent sections of series piping. For parallel piping between the primary piping and manifold, select the maximum pressure drop of the parallel piping sections and then add this to adjacent sections of series piping. The pressure drop is determined by using the appropriate pressure drop table corresponding to the system's glycol content and flow rate seen within the relevant section of secondary piping between the primary piping and the manifold.
- When calculating the pressure drop of the secondary piping, be sure to add the pressure drop of all associated valves, fittings, mixing devices and other piping accessories (expansion tanks, air separators, etc.) located within the relevant piping sections. As much as possible, during the

design phase, select valves and accessories with low pressure drop ratings to reduce the system pressure drop. For balancing valves, this means selecting units with high flow coefficients, also known as a "Cv" rating. For mixing valves, select a valve with a Cv rating that is as close as possible to the design flow rate through the valve. This will optimize performance of the valve (good control at reduced head). To determine the pressure drop associated with valves based on their Cv ratings, you may use the following equation:

$$\Delta P = \left( \frac{D}{62.4} \right) \cdot \left( \frac{f}{C_v} \right)^2$$

where

- $\Delta P$  = pressure drop across the valve in psi
- $D$  = density of the fluid at operating temperature (lb/ft<sup>3</sup>)
- 62.4 = density of water at 60°F (lb/ft<sup>3</sup>)
- $f$  = flow rate of fluid (gpm)
- $C_v$  = known Cv rating of the device (gpm)

If a manufacturer provides the pressure drop of an accessory in psi, you may convert the psi to feet of head with the following formula:

$$H = \frac{144 \cdot \Delta P}{D}$$

where

- $H$  is the "head loss," also known as pressure drop, of the accessory (feet of head)
- $\Delta P$  is the pressure drop (psi)
- $D$  is the density of the fluid at its corresponding temperature (lbs/ft<sup>3</sup>). If the fluid is water, or if the density of the fluid has already been accounted for elsewhere, you may use  $D=62.4$ .

- The secondary piping circulator should be sized to accommodate the secondary piping's maximum volumetric flow rate at the total pressure drop for the secondary and panel piping (calculated above).

Continue calculating the pressure drop in the primary piping:

- Determine the length of the primary piping. Be sure to include all piping between the heating source and secondary piping. For each pipe size in the primary piping system, use the pressure drop tables that correspond to the system's glycol content and flow rate, and multiply the pressure drop per foot (obtained from the table) by the equivalent length of each corresponding piping size.
- Add the pressure drop of all valves, fittings, heating source and other piping accessories (expansion tanks, air separators, etc.) located in the primary piping system.
- The primary piping circulator should be sized to accommodate the primary system flow rate at the total pressure drop of the primary piping system (calculated above).

Example:

Determine the pressure drop associated with 200 feet of ½" tubing at a maximum flow rate of 1 gpm:

1. Locate desired 1 gpm flow rate for the tubing on the left vertical axis of Figure 1-26
2. Follow to the right until you reach the diagonal line corresponding to 0.5" tubing
3. Move down to the horizontal axis and read the pressure drop in feet of head per foot of tubing (~0.05 feet of head per foot of tubing)
4. Multiply the pressure drop per foot by the length of tubing to find the feet of head for the circuit (0.05\*200=10 feet of head)

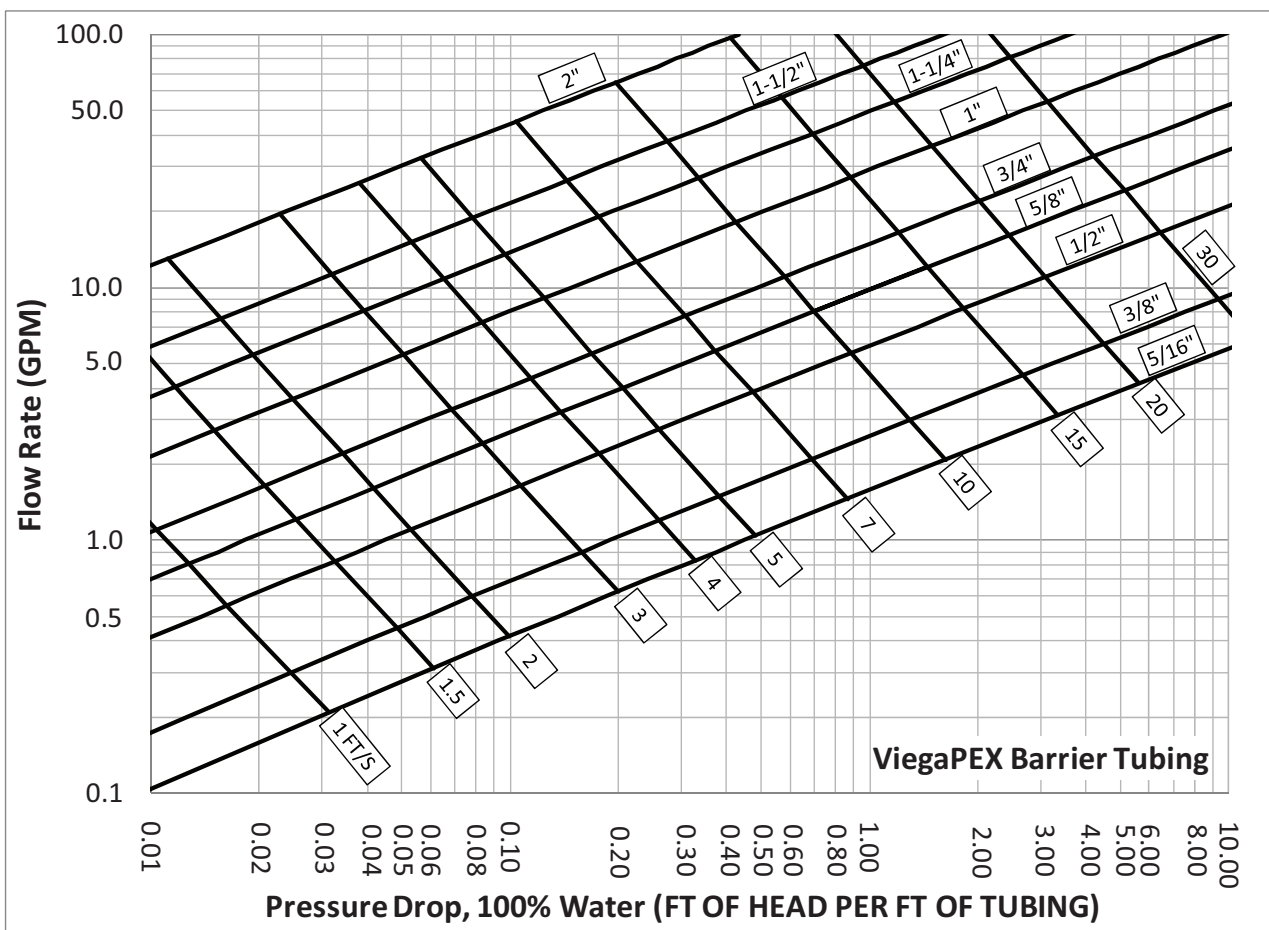


Figure 1-26 Pressure drop of ViegaPEX Barrier tubing based on flow rate and diameter

### 1.9.3 Using a pump curve

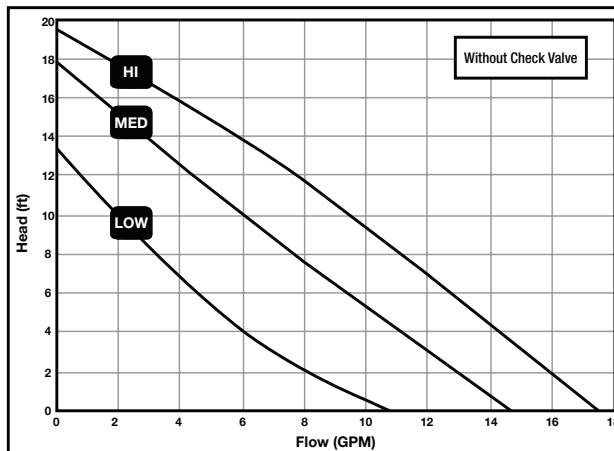
Pump curves help you to select a circulator based on the feet of head expected at the design flow rate. The selected pump must have a capacity greater than or equal to the system flow rate and a head greater than or equal to the total system pressure drop. Derive the pressure drop from Section 1.9.2, Pressure drop. Once these two system characteristics are known, a pump curve can be used to identify the best match for the system. Follow the procedure below to select a pump sourced from Viega:

1. Locate the pressure drop on the left vertical axis.
2. Locate the total system flow rate on the bottom horizontal axis.
3. Follow to the intersection of both variables.
4. Select a pump with a curve just higher than this intersection. If there are multiple pumps with curves higher than this point, then consider selecting the pump with the lowest Watts for the best energy performance. Large commercial and industrial applications may require larger pumps.

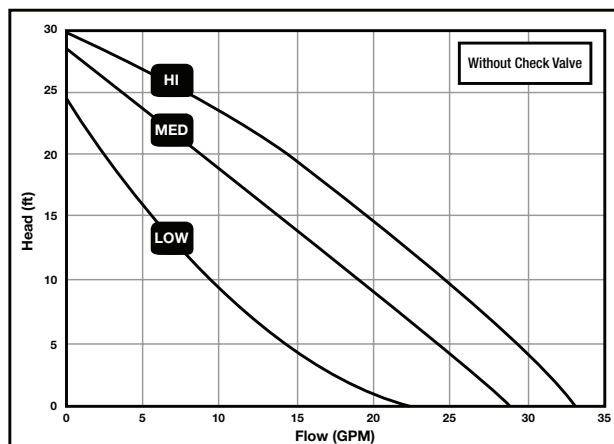
Example:

A system design calls for a circulator that can move 5 gallons per minute at a pressure drop of 10 feet of head. Identify a Viega circulator that will satisfy this application.

5. On the pump curve for model 12126, identify the intersection of 10 feet of head on the vertical axis and 5 gpm on the horizontal axis. This point is below the medium speed curve, which has a power consumption of 80 watts.
6. On the pump curve for model 12127, identify the intersection of 10 feet of head on the vertical axis and 5 gpm on the horizontal axis. This point is below the low speed curve, which has a power consumption of 150 watts.
7. Select model 12126, which will satisfy the design objectives and save 70 watts during its operation.



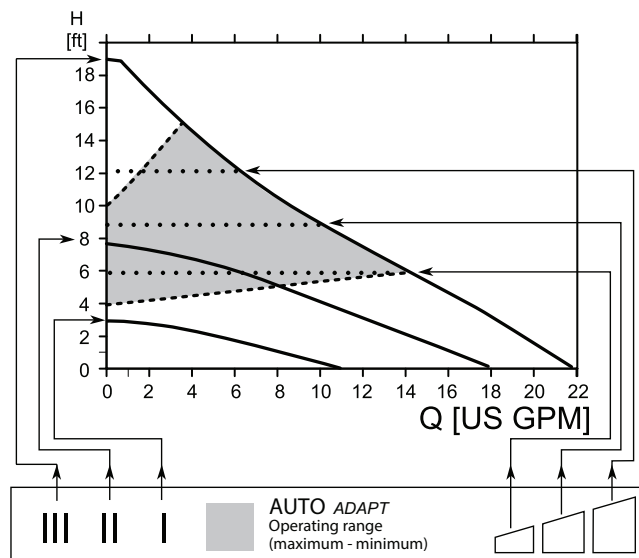
Stock Code	Speed	Amps	Watts	HP
12126	HI	0.75	87	1/25
	MED	0.66	80	1/25
	LOW	0.55	60	1/25



Stock Code	Speed	Amps	Watts	HP
12127	HI	1.8	197	1/6
	MED	1.5	179	1/6
	LOW	1.3	150	1/6

Figure 1-27 Pump curves for the 12126 and 12127 pumps supplied by Viega

### Enhanced mixing station pump curve



\*Hydraulic performance without check valve

Pos.	Description
➤	<ul style="list-style-type: none"> <li>• Push-button for selection of pump setting</li> <li>• Every time the push-button is pressed, the circulator setting is changed</li> </ul>
III	<p><b>High Fixed Speed</b></p> <ul style="list-style-type: none"> <li>• Runs at a constant speed and consequently on a constant curve. In Speed III, the pump is set on the maximum curve under all operating conditions. Quick Vent of the pump can be obtained by setting the pump to Speed III for a short period.</li> </ul>
II	<p><b>Medium Fixed Speed</b></p> <ul style="list-style-type: none"> <li>• Runs at a constant speed and consequently on a constant curve. In Speed II, the pump is set on the medium curve under all operating conditions.</li> </ul>
I	<p><b>Low Fixed Speed</b></p> <ul style="list-style-type: none"> <li>• Runs at a constant speed and consequently on a constant curve. In Speed I, the pump is set on the minimum curve under all operating conditions.</li> </ul>
▭	<p><b>Constant Pressure I</b></p> <ul style="list-style-type: none"> <li>• The duty point of the pump will move left and right along the lowest constant-pressure curve depending on water demand in the system. The pump head (pressure) is kept constant, irrespective of the water demand.</li> </ul>
▭	<p><b>Constant Pressure II</b></p> <ul style="list-style-type: none"> <li>• The duty point of the pump will move left and right along the middle constant-pressure curve depending on water demand in the system. The pump head (pressure) is kept constant, irrespective of the water demand.</li> </ul>
▭	<p><b>Constant Pressure III</b></p> <ul style="list-style-type: none"> <li>• The duty point of the pump will move left and right along the highest constant-pressure curve depending on water demand in the system. The pump head (pressure) is kept constant, irrespective of the water demand.</li> </ul>
	<p><b>AutoADAPT (Factory Setting)</b></p> <ul style="list-style-type: none"> <li>• This function controls the pump performance automatically within the defined performance range (shaded area). AutoADAPT will adjust the pump performance to system demands over time.</li> </ul>

Figure 1-28 Performance\* and operation mode selection

Hydronic mixing block pump curve

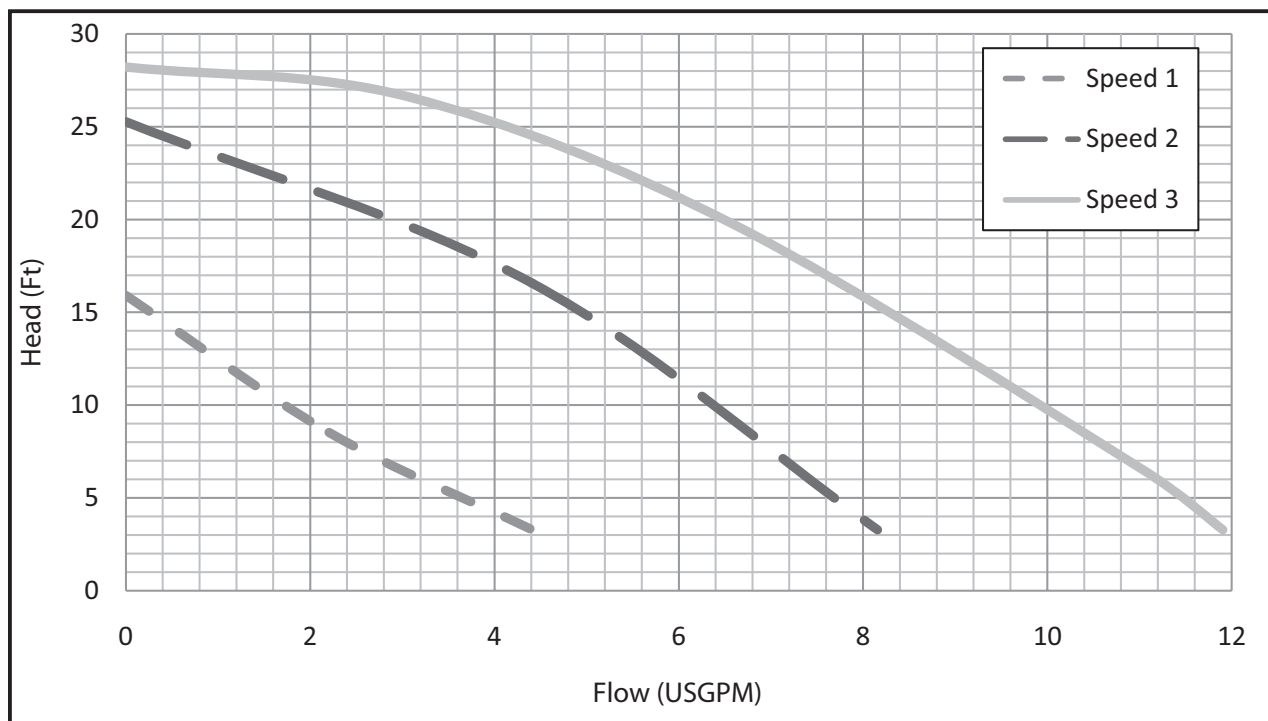


Figure 1-29 Pump curve for hydronic mixing block

### 1.9.4 Circulator placement relative to the expansion tank

A common mistake in installations is incorrect placement of the expansion tank relative to the circulator. The recommended practice is placement of the expansion tank on the suction side of the circulator on the primary loop. Pumping away from the expansion tank will enable the distribution system to operate at a higher pressure, which will help resist the formation of air bubbles in the fluid as well as help avoid cavitation (formation and implosion of air at the impeller due to low fluid pressure) that could otherwise damage the pump. Also, maintain at least 10 to 12 pipe diameters separation from the expansion tank to the inlet side of the pump.

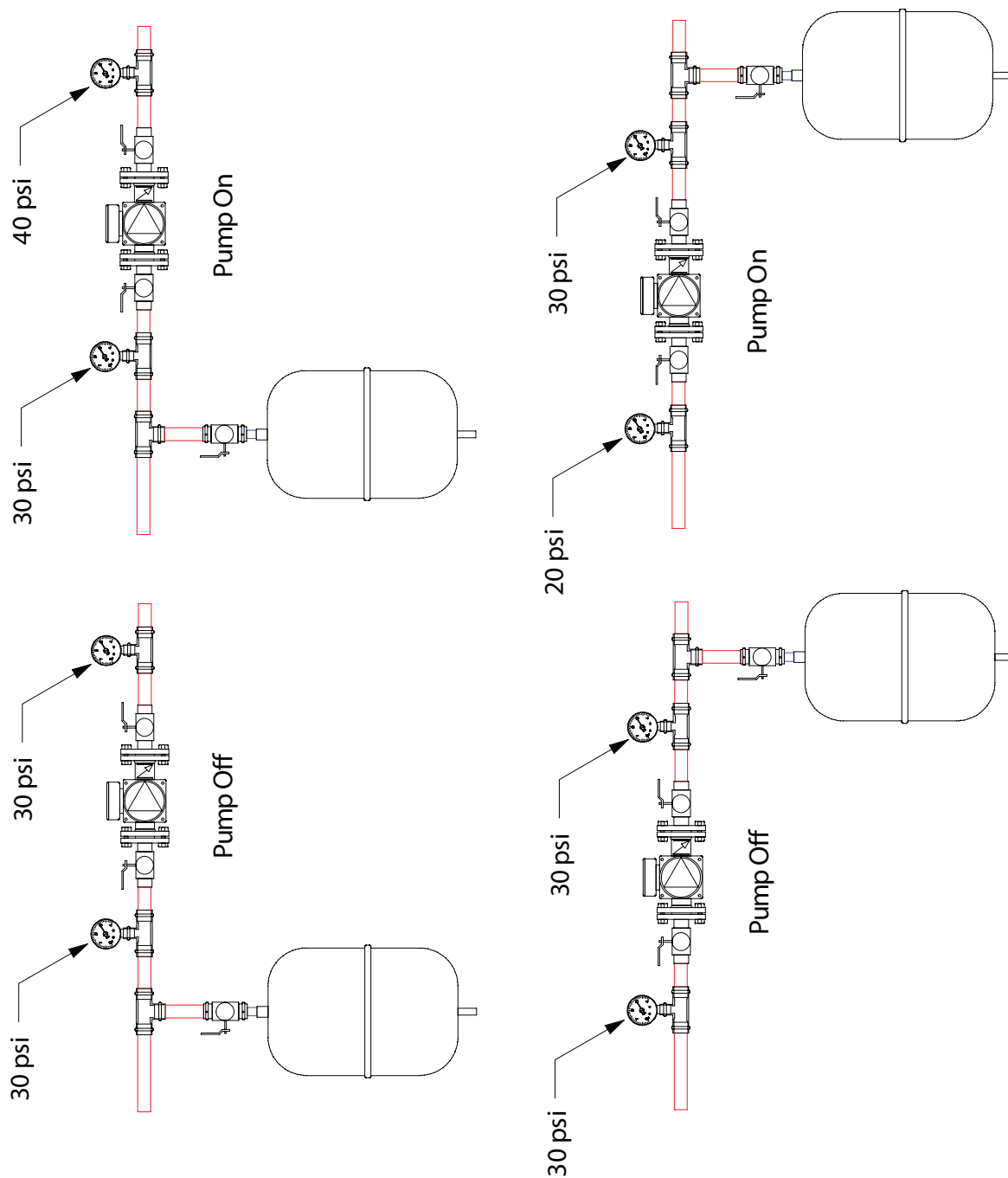


Figure 1-30 Pumping away from the expansion tank helps maintain a higher system pressure and increase the life expectancy of pumps

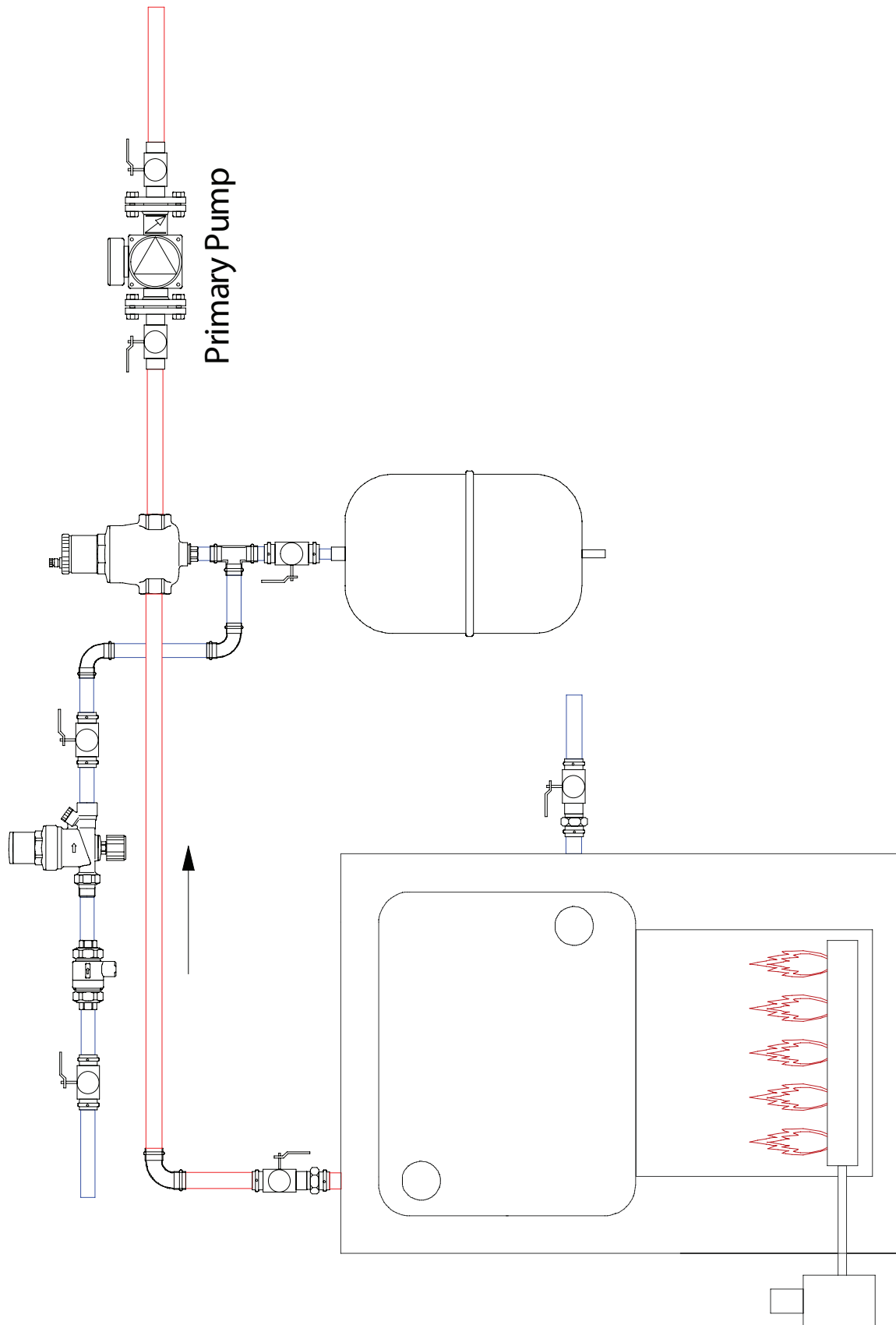


Figure 1-31 Recommended placement of expansion tank in relation to the primary

## 1.10 Expansion

### 1.10.1 Selecting an expansion tank

Expansion tanks are required within hydronic heating systems to allow for the expansion of the working fluid as the temperature is increased. For simple, 100% water-based hydronic heating systems, you may refer to Table 1-9 for expansion tank sizing. Table 1-9 provides expansion tank sizing as a function of the system's maximum operating water temperature when expansion tanks have an air side pressurization of  $\leq 12$  psi and a pressure relief valve setting of  $\geq 30$  psi. For other applications, you may use the following equation to calculate the minimum expansion tank volume required. Always round up when selecting an expansion tank.

$$V_t = V_s \cdot \left( \frac{D_c}{D_h} - 1 \right) \cdot \left( \frac{P_{RV} + 9.7}{P_{RV} - P_a - 5} \right)$$

where

$V_t$  = minimum tank volume (gal)

$V_s$  = fluid volume in system (gal)

$D_c$  = density of the fluid at its initial start temperature (lbs/ft<sup>3</sup>), whether water or glycol mix

$D_h$  = density of the fluid at its maximum operating temperature (lbs/ft<sup>3</sup>), whether water or glycol mix

$P_a$  = air side pressurization on the opposite side of the bladder, typically set at 12 psi from factory (psi)

$P_{RV}$  = pressure relief valve setting in (psi)

Example:

A radiant heating system with 100% water solution and a maximum operating temperature of 120°F has a total volume of 100 gal. The pressure relief valve setting is 30 psi, and the air side pressurization of the tank is 12 psi.

From water density tables, find the density of water at its initial start temperature of 50°F to be 62.4 lbs/ft<sup>3</sup> and the density of water at its maximum operating temperature of 120°F to be 61.7 lbs/ft<sup>3</sup>. Plugging the values into the equation gives:

$$V_t = 100 \cdot \left( \frac{62.4}{61.7} - 1 \right) \cdot \left( \frac{30 + 9.7}{30 - 12 - 5} \right)$$

$$V_t = 100 \cdot (0.0113) \cdot (3.054)$$

$$V_t = 3.45$$

**NOTE:** This value is slightly different than the corresponding value in Table 1-9 due to differences in rounding.

Water Volume in System (gal)	Max Operating Temperature (°F)		
	120	140	200
	Expansion Tank Size (Gal)		
20	0.7	1.0	2.3
30	1.0	1.5	3.5
40	1.3	2.0	4.6
50	1.7	2.5	5.8
60	2.0	3.0	6.9
70	2.3	3.5	8.1
80	2.7	4.0	9.2
90	3.0	4.5	10.4
100	3.3	5.0	11.5
125	4.2	6.3	14.4
150	5.0	7.6	17.3
175	5.8	8.8	20.2
200	6.6	10.1	23.0
225	7.5	11.3	25.9
250	8.3	12.6	28.8
275	9.1	13.9	31.7
300	10.0	15.1	34.5

Table 1-9. Minimum expansion tank size for 100% water systems at various maximum operating temperatures. Assumes 12 psi air side pressurization and 30 psi pressure relief valve setting.

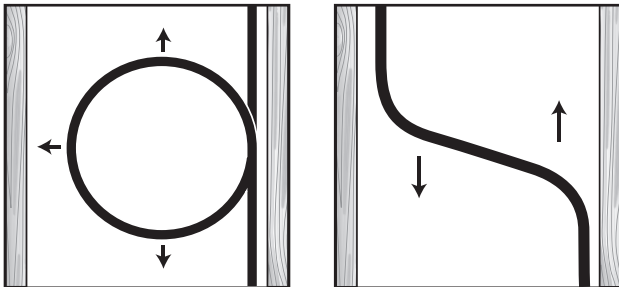


### 1.10.2 PEX expansion compensation

ViegaPEX, ViegaPEX Ultra and ViegaPEX Barrier tubing, as with any PEX tubing, expands and contracts with temperature changes in the environment or the fluid inside the tubing. The longer the tubing run and the higher the temperature change, the more linear expansion the system will experience. This expansion and contraction can affect the appearance as well as integrity of the system by putting stress on the tubing, fittings, valves and fasteners.

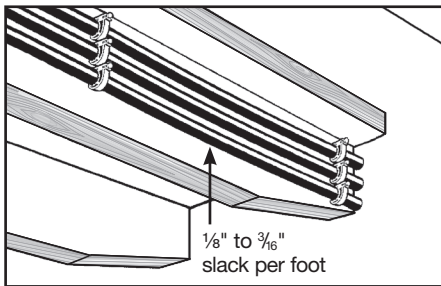
Tubing sizes smaller than 3/4" generally do not require expansion compensators with fittings and can easily be bent into loops and offsets to absorb linear expansion.

For unconstrained tubing runs (not within the floor)



Using a loop to accommodate tubing expansion

Offsets also provide room for tubing expansion



Allow some slack in all runs to prevent damage from tubing contraction.

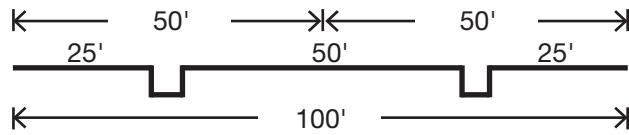
Figure 1-32

Viega recommends the use of expansion offsets. This can be accomplished at a corner or by using offsets or loops on straight tubing runs. Expansion compensators should be installed at the midway point of tubing runs and should be spaced no more than 50 ft. apart.

Below is an example of required offsets for a 100-ft. tubing run. Note that the expansion compensators are

no more than 50 ft. apart.

There are three types of expansion offsets recommended for use with large-diameter PEX tubing:



the corner expansion offset, the Z-type expansion offset and the U-type expansion loop. A description, illustration and dimensional chart for each type of offset is located in the following pages. See Page 45 for FostaPEX recommendations.

#### Tubing fasteners:

Tubing fasteners perform two functions: providing support for the tubing and guiding the tubing during expansion and contraction. It is important to keep this in mind when installing fasteners, as an expansion compensator will not be effective if the fasteners prevent linear movement of the piping system.

#### Linear expansion:

To calculate linear expansion for PEX tubing use the following formula:

$$\Delta L = \frac{\text{PEX expansion rate}}{100' \times 10^\circ\text{F}} \times \Delta T \times \text{tubing length ft}$$

Where:

ViegaPEX and ViegaPEX Ultra expansion rate = 1.1" per 100' per 10°F

ViegaPEX Barrier tubing expansion rate = 0.96" per 100' per 10°F

$\Delta T$  = Change in temperature (in °F)

For example:

40' of 1" ViegaPEX Barrier tubing going from 70°F to 130°F

$$\Delta L = \frac{0.96''}{1000} \times 60^\circ \times 40' = 2.30''$$

$$\Delta L = 2.30''$$

**Compensation distance:**

To calculate the dimensions of the expansion compensation offset needed, use the following formula:

$$L = C\sqrt{OD \times \Delta L}$$

Where:

- L = length of compensation distance
- C = 12 (PEX material specific constant)
- OD = outer tubing diameter (1/8" + nominal tube size)
- ΔL = change in length from temperature change

**Corner expansion offset:**

Where piping takes a corner after a long straight run, a simple 90° elbow in the piping will allow for the absorption of expansion.

Calculate the necessary “L” dimension between elbow and nearest fastener or use the chart below, which was figured using the maximum run for a single expansion compensator (50 ft.).

Following the previous example:

$$L = C\sqrt{OD \times \Delta L}$$

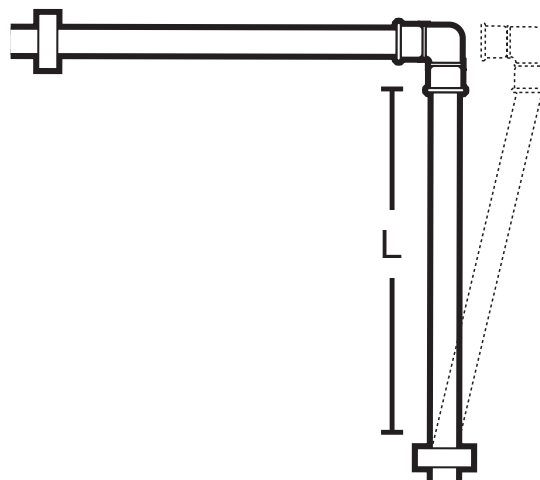
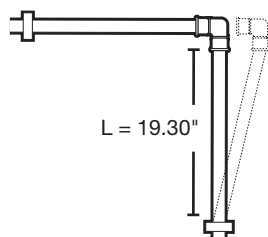
Where:

- C = 12
- OD = 1.125 (1" PEX)
- ΔL = 2.30"

$$L = 12\sqrt{1.125" \times 2.88"} = 19.30"$$

$$L = 19.30"$$

*Illustration of Example*



		Corner Expansion Offset (L, in) per 50 linear feet of run							
Tubing	ΔT(°F) Tube nom.	60	80	100	120	140	160	180	200
ViegaPEX & ViegaPEX Ultra	3/4"	20.4	23.6	26.4	28.9	31.2	33.4	35.4	37.3
	1"	23.2	26.7	29.9	32.8	35.4	37.8	40.1	42.3
	1 1/4"	25.6	29.6	33.1	36.2	39.1	41.8	44.4	46.8
	1 1/2"	27.8	32.1	35.9	39.4	42.5	45.5	48.2	50.8
	2"	31.8	36.8	41.1	45.0	48.6	52.0	55.1	58.1
ViegaPEX Barrier	3/4"	19.0	22.0	24.6	26.9	29.1	31.1	33.0	34.8
	1"	21.6	24.9	27.9	30.5	33.0	35.3	37.4	39.4
	1 1/4"	23.9	27.6	30.8	33.8	36.5	39.0	41.4	43.6
	1 1/2"	26.0	30.0	33.5	36.7	39.7	42.4	45.0	47.4
	2"	29.7	34.3	38.3	42.0	45.3	48.5	51.4	54.2

**Table 1-10 NOTE:** This chart was figured using the maximum run for a single expansion compensator (50 ft.). Refer to Viega installation manuals for recommended operating temperatures, pressures, tubing fasteners and fastener spacing.

### Z-type expansion offset:

The Z-type expansion offset integrates two 90° elbows that form a “Z” pattern.

With this type of configuration ½ of the “L” dimension is applied to the center area of the “Z” (represented as L1 in the table and illustration) while ¼ of the “L” dimension would be applied to each of the top and bottom areas (represented as L2).

Calculate the necessary L1 and L2 dimensions or use the chart below, which was figured using the maximum run for a single expansion compensator (50 ft.).

$$L = 19.30''$$

$$L1 = \frac{1}{2} (L)$$

$$L1 = 19.30''/2 = 9.65''$$

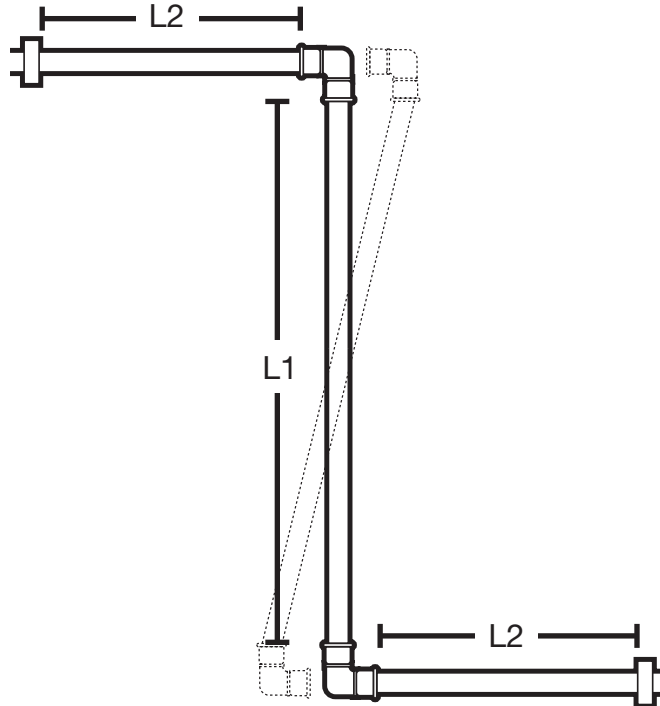
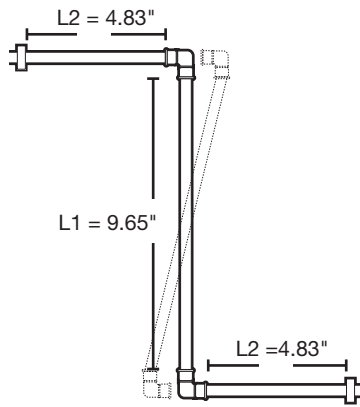
$$L1 = 9.65''$$

$$L2 = \frac{1}{4} (L)$$

$$L2 = 19.30''/4 = 4.83''$$

$$L2 = 4.83''$$

#### Illustration of Example



		Z-Type Expansion Offset (in) per 50 linear feet of run															
Tubing	ΔT(°F) Tube nom.	60		80		100		120		140		160		180		200	
		L1	L2	L1	L2	L1	L2	L1	L2	L1	L2	L1	L2	L1	L2		
ViegaPEX & ViegaPEX Ultra	¾"	10.2	5.1	11.8	5.9	13.2	6.6	14.4	7.2	15.6	7.8	16.7	8.3	17.7	8.8	18.6	9.3
	1"	11.6	5.8	13.4	6.7	15.0	7.5	16.4	8.2	17.7	8.8	18.9	9.5	20.1	10.0	21.1	10.6
	1¼"	12.8	6.4	14.8	7.4	16.5	8.3	18.1	9.1	19.6	9.8	20.9	10.5	22.2	11.1	23.4	11.7
	1½"	13.9	7.0	16.1	8.0	18.0	9.0	19.7	9.8	21.3	10.6	22.7	11.4	24.1	12.1	25.4	12.7
ViegaPEX Barrier	2"	15.9	8.0	18.4	9.2	20.5	10.3	22.5	11.3	24.3	12.2	26.0	13.0	27.6	13.8	29.1	14.5
	¾"	9.5	4.8	11.0	5.5	12.3	6.1	13.5	6.7	14.5	7.3	15.6	7.8	16.5	8.2	17.4	8.7
	1"	10.8	5.4	12.5	6.2	14.0	7.0	15.3	7.6	16.5	8.2	17.6	8.8	18.7	9.4	19.7	9.9
	1¼"	11.9	5.9	13.8	6.9	15.4	7.7	16.9	8.4	18.2	9.1	19.5	9.7	20.7	10.3	21.8	10.9
	1½"	13.0	6.5	15.0	7.5	16.8	8.4	18.4	9.1	19.8	9.9	21.2	10.6	22.5	11.2	23.7	11.8
	2"	14.8	7.4	17.1	8.6	19.2	9.58	21.0	10.5	22.7	11.3	24.2	12.1	25.7	12.9	27.1	13.5

Table 1-11 **NOTE:** This chart was figured using the maximum run for a single expansion compensator (50 ft.). Refer to Viega installation manuals for recommended operating temperatures, pressures, tubing fasteners and fastener spacing.

### U-type expansion loop:

The U-type expansion loop integrates four 90° elbows that form a “U” pattern.

With this arrangement 1/5 of the “L” dimension is applied as the width (represented as L3) while 2/5 of “L” is applied as each leg in the other dimension (represented as L4).

Calculate the necessary L3 and L4 dimensions or use the chart below, which was figured using the maximum run for a single expansion compensator (50 ft.).

$$L = 19.30''$$

$$L3 = \frac{1}{5} (L)$$

$$L3 = \frac{19.30''}{5} = 3.86''$$

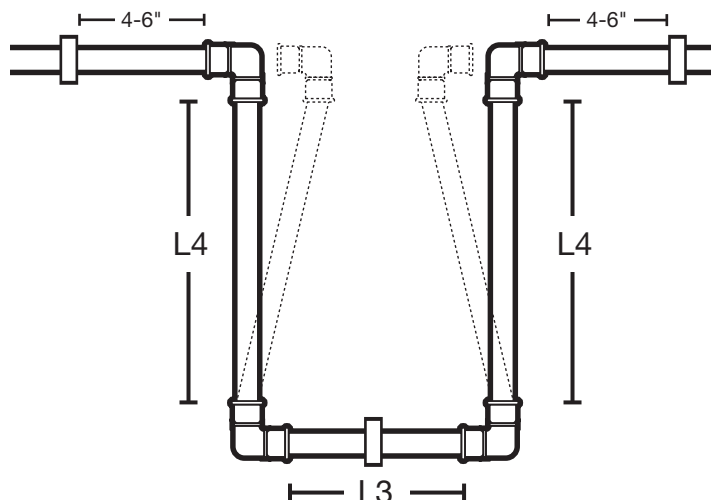
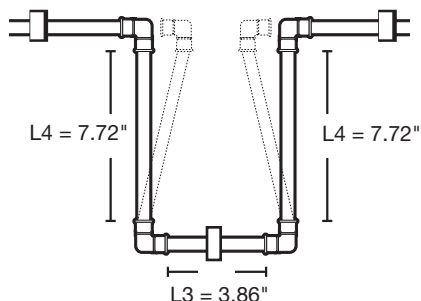
$$L3 = 3.86''$$

$$L4 = \frac{2}{5} (L)$$

$$L4 = \frac{2(19.30'')}{5} = 7.72''$$

$$L4 = 7.72''$$

#### Illustration of Example



The fastener shown on the L3 leg may be required to provide additional support depending on how the expansion loop is installed (horizontal / vertical).

		U-Type Expansion Loop (in) per 50 linear feet of run															
Tubing	ΔT(°F) Tube nom.	60		80		100		120		140		160		180		200	
		L3	L4	L3	L4	L3	L4	L3	L4	L3	L4	L3	L4	L3	L4	L3	L4
ViegaPEX & ViegaPEX Ultra	¾"	4.1	8.2	4.7	9.4	5.3	10.5	5.8	11.6	6.2	12.5	6.7	13.3	7.0	14.2	7.5	14.9
	1"	4.6	9.3	5.3	10.7	6.0	12.0	6.6	13.1	7.1	14.2	7.6	15.1	8.0	16.0	8.5	16.9
	1¼"	5.1	10.2	5.9	11.8	6.6	13.2	7.2	14.5	7.8	15.6	8.4	16.7	8.9	17.7	9.4	18.7
	1½"	5.6	11.1	6.4	12.9	7.2	14.4	7.9	15.7	8.5	17.0	9.1	18.2	9.6	19.3	10.2	20.3
ViegaPEX Barrier	2"	6.4	12.7	7.4	14.7	8.2	16.4	9.0	18.0	9.7	19.5	10.4	20.8	11.0	22.1	11.6	23.2
	¾"	3.8	7.6	4.4	8.8	4.9	9.8	5.4	10.8	5.8	11.6	6.2	12.4	6.6	13.2	7.0	13.9
	1"	4.3	8.6	5.0	10.0	5.6	11.2	6.1	12.2	6.6	13.2	7.1	14.1	7.5	15.0	7.9	15.8
	1¼"	4.8	9.6	5.5	11.0	6.2	12.3	6.8	13.5	7.3	14.6	7.8	15.6	8.3	16.5	8.7	17.4
	1½"	5.2	10.4	6.0	12.0	6.7	13.4	7.3	14.7	7.9	15.9	8.5	17.0	9.0	18.0	9.5	19.0
	2"	5.9	11.9	6.9	13.7	7.7	15.3	8.4	16.8	9.1	18.1	9.7	19.4	10.3	20.6	10.8	21.7

Table 1-12 **NOTE:** This chart was figured using the maximum run for a single expansion compensator (50 ft.). Refer to Viega installation manuals for recommended operating temperatures, pressures, tubing fasteners and fastener spacing.

### FostaPEX:

FostaPEX tubing has a fully dimensioned PEX wall with additional outer layers of aluminum and polyethylene. As a result of these extra layers, FostaPEX expands considerably less than that of standard PEX tubing and slightly more than copper tubing (0.16" per 100' per 10°F).

An approved method for expansion absorption when using FostaPEX is through the use of a coiled loop expansion compensator (at least every 50 ft.). **Do not use fitting offsets as described on prior pages with FostaPEX as the stiffness of FostaPEX may lead to high stress at connections.**

### Coiled loop:

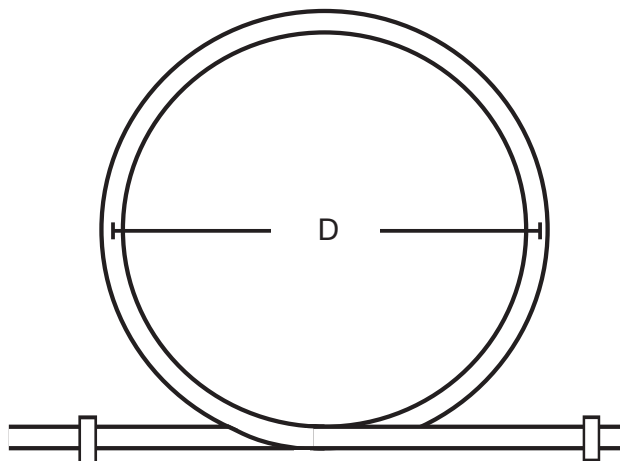
The coiled loop configuration calls for loops within the piping system. The diameter of the loop (D) is shown below and will increase or decrease as the tubing in the system expands and contracts.

**NOTE:** Tubing fasteners should be secured as to not prevent linear movement of tubing.

**NOTE:** Refer to Viega installation manuals for recommended operating temperatures, pressures, tubing fasteners and fastener spacing.

Tube nom.	D (in)
½" FostaPEX	12"
⅝" FostaPEX	14"
¾" FostaPEX	16"
1" FostaPEX	20"

Table 1-13



## 1.11 Freeze protection – glycol mixtures

If freeze protection is required for your system (e.g., snow melting, turf conditioning, seasonal use, some agricultural and commercial applications, etc.), then use this section to determine the percent of glycol to specify as well as the effects of the glycol on system specifications.

### 1.11.1 Selecting the percent glycol mixture

Use Table 1-14 to determine the percent glycol solution necessary based on the freezing point of the solution as a function of the percent glycol by volume.

Glycol (% by volume)	0%	10%	20%	30%	40%	50%
Ethylene	32	25	16	3	-12	-35
Propylene	32	26	18	8	-7	-28

Table 1-14 Freezing point (°F) of glycol solutions, based on type and percent by volume.

#### NOTE:

Automotive antifreeze is not recommended, as the silicates in automotive antifreeze can coat and foul heat transfer surfaces, reducing performance; further, automotive antifreeze may not be compatible with PEX products. Please contact Viega Technical Support for approved antifreeze solutions.

### 1.11.2 Glycol system effects

Although glycol solutions have higher densities than water solutions, they have a lower specific heat, which means that to achieve equivalent Btu output, these systems must operate at a higher flow rate and pressure drop than would a system with the same piping layout that uses 100% water as the working fluid. The higher flow rate and pressure drop must be taken into account when sizing the glycol system's circulator pumps and piping.

#### 1.11.2.1 Glycol flow rate

To estimate the flow rate required in the glycol loop, you may use the following equation:

$$GPM = \left( \frac{\text{Total Design Heat Load (Btu/hr)}}{\Delta T \cdot 8.01 \cdot C_p \cdot P} \right)$$

where

$\Delta T$  is the system temperature drop from supply to return.

$C_p$  is the specific heat of the fluid, taken at the average of the supply and return temperature (Btu/lb/°F). For the specific heat of glycol solutions, see Table 1-15 for propylene glycol or Table 1-17 for ethylene glycol.

8.01 is a constant to convert between units

$P$  is the density of the fluid, taken at the average of the supply and return temperature (lbs/ft<sup>3</sup>). For the density of glycol solutions, see Table 1-16 for propylene glycol or Table 1-18 for ethylene glycol.

Specific Heat of Propylene Glycol Solutions (Btu/lb/°F)									
Temperature (°F)	Propylene Glycol Concentration by Volume								
	10%	20%	30%	40%	50%	60%	70%	80%	90%
-30						0.741	0.680	0.615	0.542
-20					0.799	0.746	0.687	0.623	0.550
-10					0.804	0.752	0.693	0.630	0.558
0				0.855	0.809	0.758	0.700	0.637	0.566
10			0.898	0.859	0.814	0.764	0.707	0.645	0.574
20		0.936	0.902	0.864	0.820	0.770	0.713	0.652	0.583
30	0.966	0.938	0.906	0.868	0.825	0.776	0.720	0.660	0.591
40	0.968	0.941	0.909	0.872	0.830	0.782	0.726	0.667	0.599
50	0.970	0.944	0.913	0.877	0.835	0.787	0.733	0.674	0.607
60	0.972	0.947	0.917	0.881	0.840	0.793	0.740	0.682	0.615
70	0.974	0.950	0.920	0.886	0.845	0.799	0.746	0.689	0.623
80	0.976	0.953	0.924	0.890	0.850	0.805	0.753	0.696	0.631
90	0.979	0.956	0.928	0.894	0.855	0.811	0.760	0.704	0.639
100	0.981	0.959	0.931	0.899	0.861	0.817	0.766	0.711	0.647
110	0.983	0.962	0.935	0.903	0.866	0.823	0.773	0.718	0.656
120	0.985	0.965	0.939	0.908	0.871	0.828	0.779	0.726	0.664
130	0.987	0.967	0.942	0.912	0.876	0.834	0.786	0.733	0.672
140	0.989	0.970	0.946	0.916	0.881	0.840	0.793	0.740	0.680
150	0.991	0.973	0.950	0.921	0.886	0.846	0.799	0.748	0.688
160	0.993	0.976	0.953	0.925	0.891	0.852	0.806	0.755	0.696
170	0.996	0.979	0.957	0.929	0.896	0.858	0.812	0.762	0.704
180	0.998	0.982	0.961	0.934	0.902	0.864	0.819	0.770	0.712
190	1.000	0.985	0.964	0.938	0.907	0.869	0.826	0.777	0.720
200	1.002	0.988	0.968	0.943	0.912	0.875	0.832	0.784	0.729
210	1.004	0.991	0.971	0.947	0.917	0.881	0.839	0.792	0.737
220	1.006	0.994	0.975	0.951	0.922	0.887	0.845	0.799	0.745
230	1.008	0.996	0.979	0.956	0.927	0.893	0.852	0.806	0.753
240	1.011	0.999	0.982	0.960	0.932	0.899	0.859	0.814	0.761
250	1.013	1.002	0.986	0.965	0.937	0.905	0.865	0.821	0.769

Table 1-15 Specific heat of propylene glycol solutions<sup>8</sup>

8. ©ASHRAE Fundamentals, Chapter 31, 2009.

Density of Propylene Glycol Solutions (lbs/ft <sup>3</sup> )										
Temperature (°F)	Propylene Glycol Concentration by Volume									
	0%	10%	20%	30%	40%	50%	60%	70%	80%	90%
-30							67.05	67.47	68.38	68.25
-20						66.46	66.93	67.34	68.13	68.00
-10						66.35	66.81	67.20	67.87	67.75
0					65.71	66.23	66.68	67.05	67.62	67.49
10				65.00	65.60	66.11	66.54	66.89	67.36	67.23
20			64.23	64.90	65.48	65.97	66.38	66.72	67.10	66.97
30		63.38	64.14	64.79	65.35	65.82	66.22	66.54	66.83	66.71
40	62.42	63.30	64.03	64.67	65.21	65.67	66.05	66.35	66.57	66.44
50	62.42	63.20	63.92	64.53	65.06	65.50	65.87	66.16	66.30	66.18
60	62.38	63.10	63.79	64.39	64.90	65.33	65.68	65.95	66.04	65.91
70	62.31	62.98	63.66	64.24	64.73	65.14	65.47	65.73	65.77	65.64
80	62.23	62.86	63.52	64.08	64.55	64.95	65.26	65.51	65.49	65.37
90	62.11	62.73	63.37	63.91	64.36	64.74	65.04	65.27	65.22	65.09
100	62.00	62.59	63.20	63.73	64.16	64.53	64.81	65.03	64.95	64.82
110	61.84	62.44	63.03	63.54	63.95	64.30	64.57	64.77	64.67	64.54
120	61.73	62.28	62.85	63.33	63.74	64.06	64.32	64.51	64.39	64.26
130	61.54	62.11	62.66	63.12	63.51	63.82	64.06	64.23	64.11	63.98
140	61.39	61.93	62.46	62.90	63.27	63.57	63.79	63.95	63.83	63.70
150	61.20	61.74	62.25	62.67	63.02	63.30	63.51	63.66	63.55	63.42
160	61.01	61.54	62.03	62.43	62.76	63.03	63.22	63.35	63.26	63.13
170	60.79	61.33	61.80	62.18	62.49	62.74	62.92	63.04	62.97	62.85
180	60.57	61.11	61.56	61.92	62.22	62.45	62.61	62.72	62.68	62.56
190	60.35	60.89	61.31	61.65	61.93	62.14	62.29	62.39	62.39	62.27
200	60.13	60.65	61.05	61.37	61.63	61.83	61.97	62.05	62.10	61.97
210	59.88	60.41	60.78	61.08	61.32	61.50	61.63	61.69	61.81	61.68
220		60.15	60.50	60.78	61.00	61.17	61.28	61.33	61.51	61.38
230		59.89	60.21	60.47	60.68	60.83	60.92	60.96	61.21	61.08
240		59.61	59.91	60.15	60.34	60.47	60.55	60.58	60.91	60.78
250		59.33	59.60	59.82	59.99	60.11	60.18	60.19	60.61	60.48

Table 1-16 Density of propylene glycol solutions at various concentrations and temperatures<sup>9</sup>

9. ©ASHRAE Fundamentals, Chapter 31, 2009.



Specific Heat of Ethylene Glycol Solutions (Btu/lb/°F)									
Temperature (°F)	Ethylene Glycol Concentration by Volume								
	10%	20%	30%	40%	50%	60%	70%	80%	90%
-30					0.734	0.680	0.625	0.567	
-20					0.739	0.686	0.631	0.574	0.515
-10				0.794	0.744	0.692	0.638	0.581	0.523
0				0.799	0.749	0.698	0.644	0.588	0.530
10			0.849	0.803	0.754	0.703	0.651	0.595	0.538
20		0.897	0.853	0.808	0.759	0.709	0.657	0.603	0.546
30	0.940	0.900	0.857	0.812	0.765	0.715	0.664	0.610	0.553
40	0.943	0.903	0.861	0.816	0.770	0.721	0.670	0.617	0.561
50	0.945	0.906	0.864	0.821	0.775	0.727	0.676	0.624	0.569
60	0.947	0.909	0.868	0.825	0.780	0.732	0.683	0.631	0.576
70	0.950	0.912	0.872	0.830	0.785	0.738	0.689	0.638	0.584
80	0.952	0.915	0.876	0.834	0.790	0.744	0.696	0.645	0.592
90	0.954	0.918	0.880	0.839	0.795	0.750	0.702	0.652	0.600
100	0.957	0.922	0.883	0.843	0.800	0.756	0.709	0.659	0.607
110	0.959	0.925	0.887	0.848	0.806	0.761	0.715	0.666	0.615
120	0.961	0.928	0.891	0.852	0.811	0.767	0.721	0.673	0.623
130	0.964	0.931	0.895	0.857	0.816	0.773	0.728	0.680	0.630
140	0.966	0.934	0.898	0.861	0.821	0.779	0.734	0.687	0.638
150	0.968	0.937	0.902	0.865	0.826	0.785	0.741	0.694	0.646
160	0.971	0.940	0.906	0.870	0.831	0.790	0.747	0.702	0.654
170	0.973	0.943	0.910	0.874	0.836	0.796	0.754	0.709	0.661
180	0.975	0.946	0.913	0.879	0.842	0.802	0.760	0.716	0.669
190	0.978	0.949	0.917	0.883	0.847	0.808	0.766	0.723	0.677
200	0.980	0.952	0.921	0.888	0.852	0.813	0.773	0.730	0.684
210	0.982	0.955	0.925	0.892	0.857	0.819	0.779	0.737	0.692
220	0.985	0.958	0.929	0.897	0.862	0.825	0.786	0.744	0.700
230	0.987	0.961	0.932	0.901	0.867	0.831	0.792	0.751	0.708
240	0.989	0.964	0.936	0.905	0.872	0.837	0.799	0.758	0.715
250	0.992	0.967	0.940	0.910	0.877	0.842	0.805	0.765	0.723

Table 1-17 Specific heat of ethylene glycol solutions<sup>10</sup>

10. ©ASHRAE Fundamentals, Chapter 31, 2009.

Density of Ethylene Glycol Solutions (lbs/ft <sup>3</sup> )										
Temperature (°F)	Ethylene Glycol Concentration by Volume									
	0%	10%	20%	30%	40%	50%	60%	70%	80%	90%
-30						68.12	69.03	69.90	70.75	
-20						68.05	68.96	69.82	70.65	71.45
-10					67.04	67.98	68.87	69.72	70.54	71.33
0					66.97	67.90	68.78	69.62	70.43	71.20
10				65.93	66.89	67.80	68.67	69.50	70.30	71.06
20			64.83	65.85	66.80	67.70	68.56	69.38	70.16	70.92
30		63.69	64.75	65.76	66.70	67.59	68.44	69.25	70.02	70.96
40	62.42	63.61	64.66	65.66	66.59	67.47	68.31	69.10	69.86	70.59
50	62.42	63.52	64.56	65.55	66.47	67.34	68.17	68.95	69.70	70.42
60	62.38	63.42	64.45	65.43	66.34	67.20	68.02	68.79	69.53	70.23
70	62.31	63.31	64.33	65.30	66.20	67.05	67.86	68.62	69.35	70.04
80	62.23	63.19	64.21	65.17	66.05	66.90	67.69	68.44	69.15	69.83
90	62.11	63.07	64.07	65.02	65.90	66.73	67.51	68.25	68.95	69.62
100	62.00	62.93	63.93	64.86	65.73	66.55	67.32	68.05	68.74	69.40
110	61.84	62.79	63.77	64.70	65.56	66.37	67.13	67.84	68.52	69.17
120	61.73	62.63	63.61	64.52	65.37	66.17	66.92	67.63	68.29	68.92
130	61.54	62.47	63.43	64.34	65.18	65.97	66.71	67.40	68.05	68.67
140	61.39	62.30	63.25	64.15	64.98	65.75	66.48	67.16	67.81	68.41
150	61.20	62.11	63.06	63.95	64.76	65.53	66.25	66.92	67.55	68.14
160	61.01	61.92	62.86	63.73	64.54	65.30	66.00	66.66	67.28	67.86
170	60.79	61.72	62.64	63.51	64.31	65.05	65.75	66.40	67.01	67.58
180	60.57	61.51	62.42	63.28	64.07	64.80	65.49	66.12	66.72	67.28
190	60.35	61.29	62.19	63.04	63.82	64.54	65.21	65.84	66.42	66.97
200	60.13	61.06	61.95	62.79	63.56	64.27	64.93	65.55	66.12	66.65
210	59.88	60.82	61.71	62.53	63.29	63.99	64.64	65.24	65.81	66.33
220		60.57	61.45	62.27	63.01	63.70	64.34	64.93	65.48	65.99
230		60.31	61.18	61.99	62.72	63.40	64.03	64.61	65.15	65.65
240		60.05	60.90	61.70	62.43	63.10	63.71	64.28	64.81	65.29
250		59.77	60.62	61.40	62.12	62.78	63.39	63.94	64.46	64.93

Table 1-18 Density of ethylene glycol solutions at various concentrations and temperatures<sup>11</sup>

### 1.11.2.2 Glycol primary piping sizing

Size primary piping for glycol systems similar to how you would size piping for 100% water systems. Maintain a fluid velocity of 2 to 4 feet per second at a temperature drop that will satisfy the total design heat load of the system. Maintaining glycol system flow through the piping above 2 feet per second will facilitate separation of air from the solution – extending its useful life.

Not exceeding 4 feet per second will enable the primary piping to operate quietly. Higher fluid flow velocities can contribute to the erosion of copper components within the system.

Table 1-19 can be used to size primary piping for propylene glycol and Table 1-20 can be used to size primary piping for ethylene glycol systems based on the glycol percentage and flow rate required for typical glycol systems (i.e., those designed for a 30°F temperature drop).

11. ©ASHRAE Fundamentals, Chapter 31, 2009.

Copper Tube Size (In.)	Recommended Flow Rate Range (GPM)	Propylene Glycol Percentage		
		30%	40%	50%
		Heat Carrying Capacity Range (Btu/hr)		
¾	3.7-7.5	52,811 - 107,049	51,393 - 104,174	49,555 - 100,450
1	7-12	87,067 - 178,415	84,729 - 173,624	81,699 - 167,416
1¼	10-18	129,886 - 266,909	126,399 - 259,742	121,880 - 250,455
1½	13-26	185,552 - 371,103	180,570 - 361,139	174,114 - 348,227
2	22-44	314,011 - 628,021	305,579 - 611,158	294,654 - 589,307
2½	33-68	471,016 - 970,579	458,369 - 944,517	441,981 - 910,748
3	49-96	699,388 - 1,370,229	680,608 - 1,333,436	656,275 - 1,285,762
3½	65-130	927,759 - 1,855,518	902,848 - 1,805,695	870,568 - 1,741,136
4	82-165	1,170,404 - 2,355,081	1,138,976 - 2,291,843	1,098,255 - 2,209,904

Table 1-19 Heat carrying capacity of a primary loop containing a propylene glycol solution. Assumes temperature drop of 30°F and supply temperature of 130°F. Accuracy within +/- 1% for supply temperatures between 110-150°F.

Copper Tube Size (In.)	Recommended Flow Rate Range (GPM)	Ethylene Glycol Percentage		
		30%	40%	50%
		Heat Carrying Capacity Range (Btu/hr)		
¾	3.7-7.5	51,061 - 103,502	49,467 - 100,271	47,601 - 96,489
1	7-12	84,182 - 172,503	81,554 - 167,118	78,478 - 160,815
1¼	10-18	125,583 - 258,065	121,663 - 250,009	117,073 - 240,579
1½	13-26	179,404 - 358,807	173,804 - 347,607	167,248 - 334,495
2	22-44	303,606 - 607,212	294,129 - 588,258	283,034 - 566,068
2½	33-68	455,409 - 938,419	441,194 - 909,126	424,552 - 874,833
3	49-96	676,214 - 1,324,827	655,106 - 1,283,473	630,395 - 1,235,059
3½	65-130	897,019 - 1,794,037	869,018 - 1,738,036	836,238 - 1,672,476
4	82-165	1,131,623 - 2,277,047	1,096,299 - 2,205,969	1,054,946 - 2,122,758

Table 1-20 Heat carrying capacity of a primary loop containing an ethylene glycol solution. Assumes temperature drop of 30°F and supply temperature of 130°F. Accuracy within +/- 1% for supply temperatures between 110-150°F.

### 1.11.2.3 Glycol pressure drop

Determining the pressure drop in a system using a glycol solution is achieved in the same manner as for a 100% water system, except that different pressure drop charts must be used based on the % glycol solution. Pressure drop tables for piping using glycol solution are provided above.

See Section 1.9.2, Pressure drop, for information on how to calculate the total pressure drop across the system using the tables provided within this section. Also, don't forget to account for the pressure drop from accessories, as detailed in Section 1.9.2. Once the pressure drop and design flow rate are known, selecting a circulator involves the same steps as for a 100% water system.

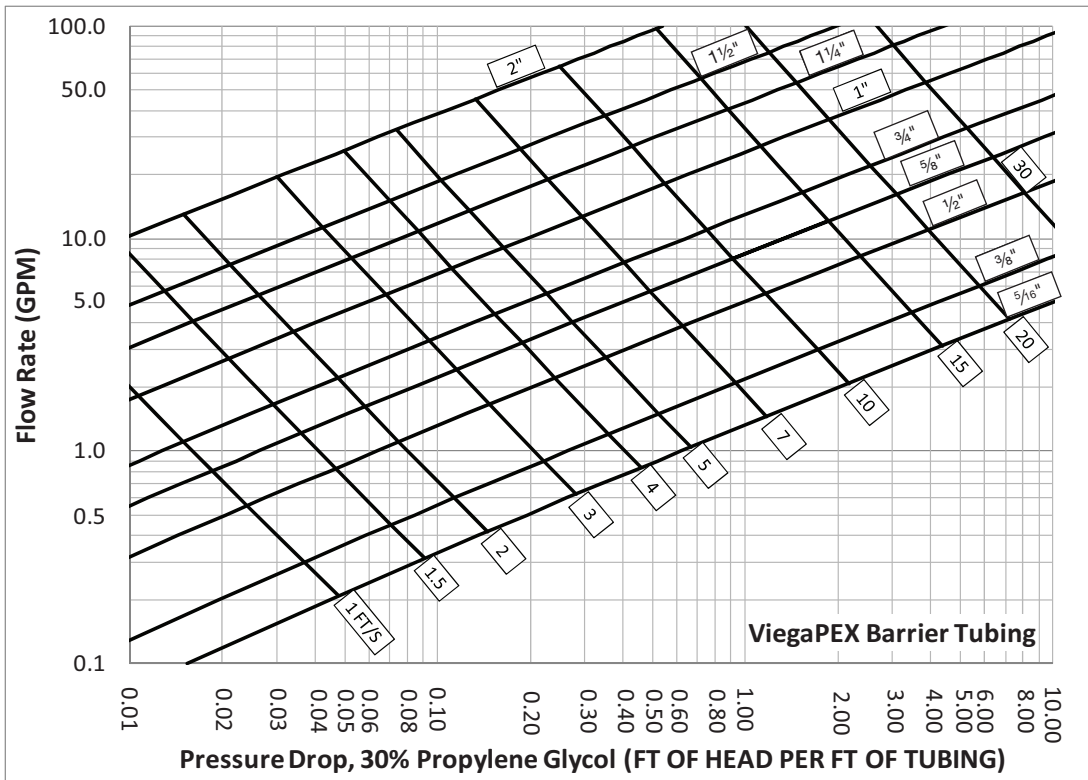


Table 1-21 Thirty percent propylene glycol pressure drop table for ViegaPEX Barrier tubing

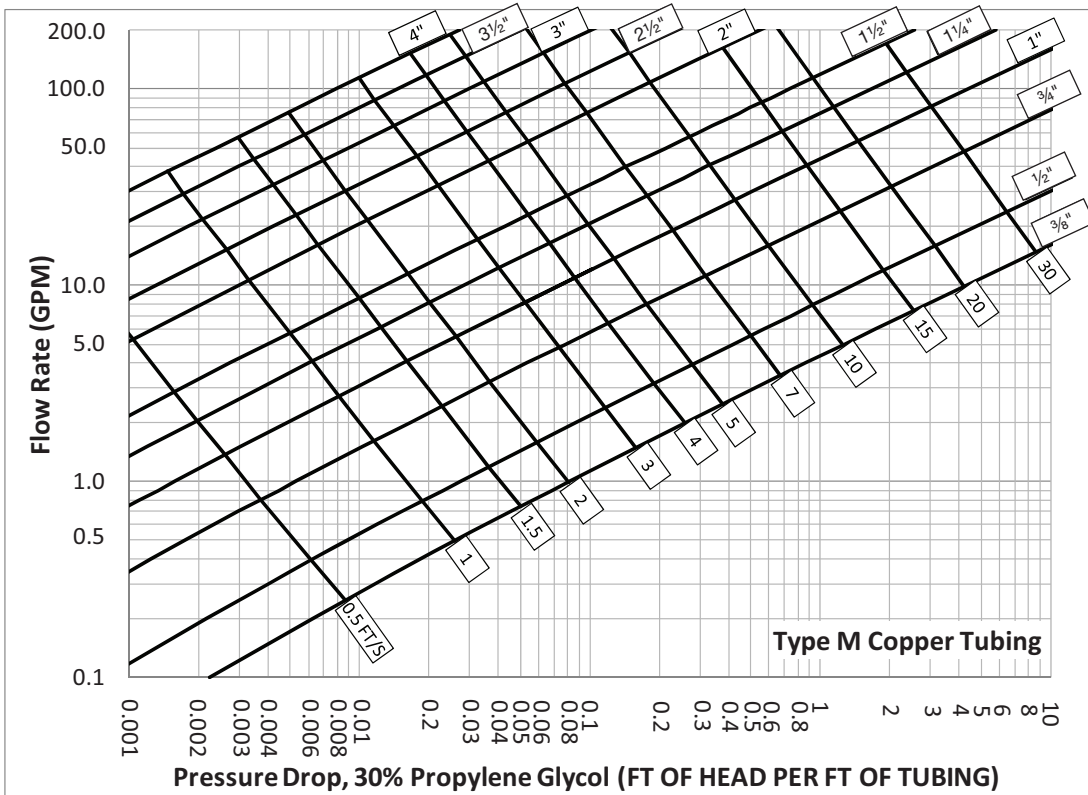


Table 1-22 Thirty percent propylene glycol pressure drop table for Type M copper tubing

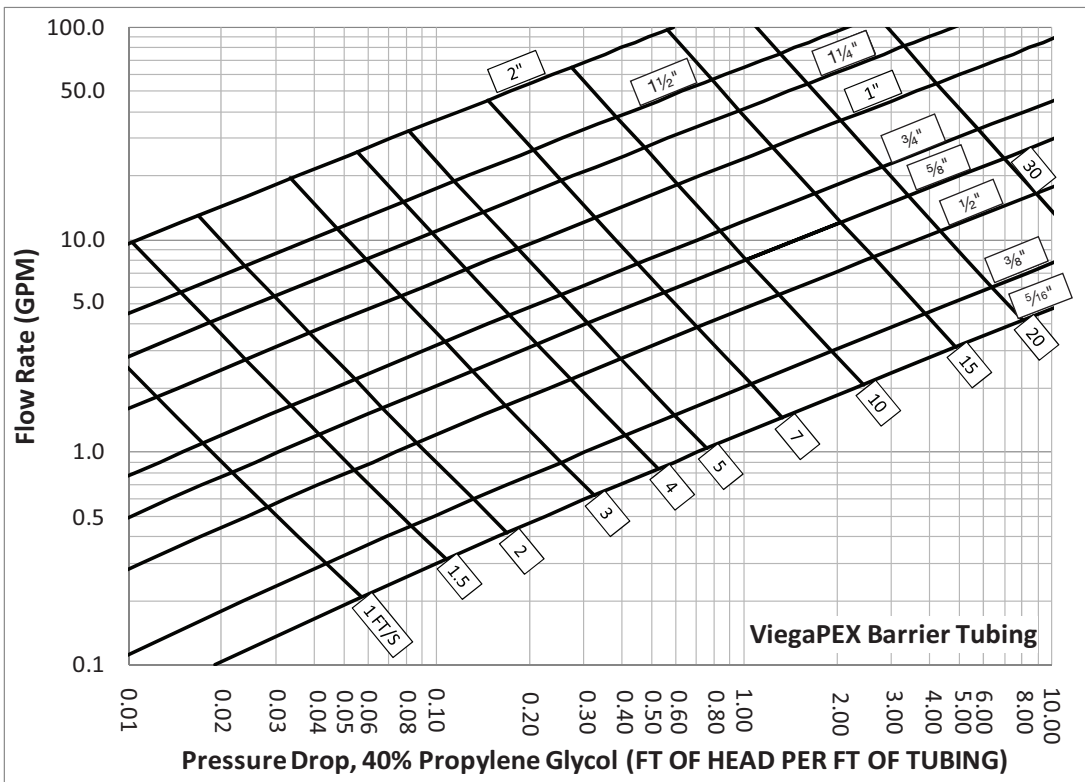


Table 1-23 Forty percent propylene glycol pressure drop table for ViegaPEX Barrier tubing

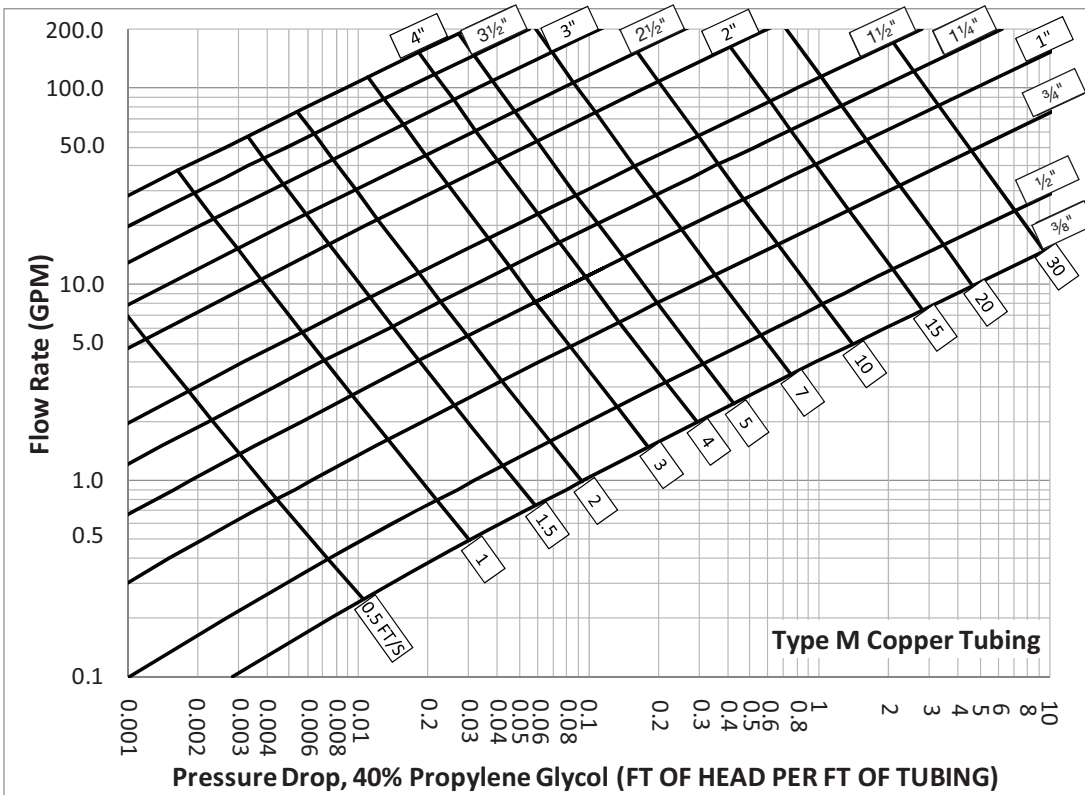


Table 1-24 Forty percent propylene glycol pressure drop table for Type M copper tubing

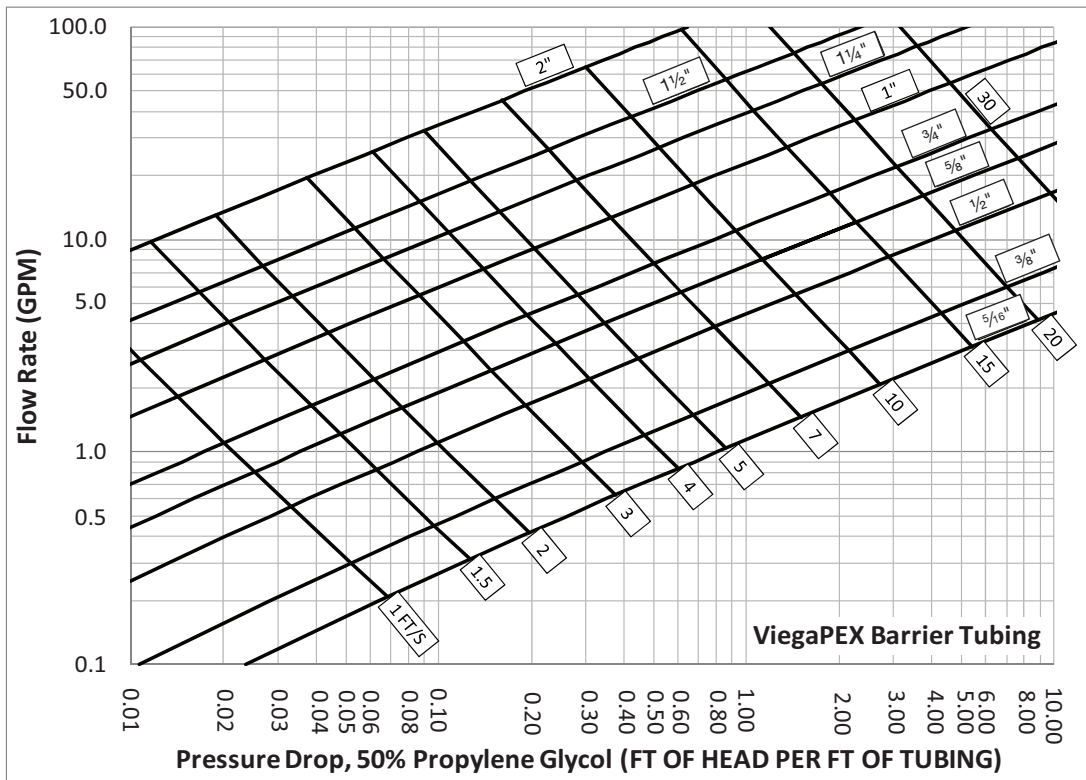


Table 1-25 Fifty percent propylene glycol pressure drop table for ViegaPEX Barrier tubing

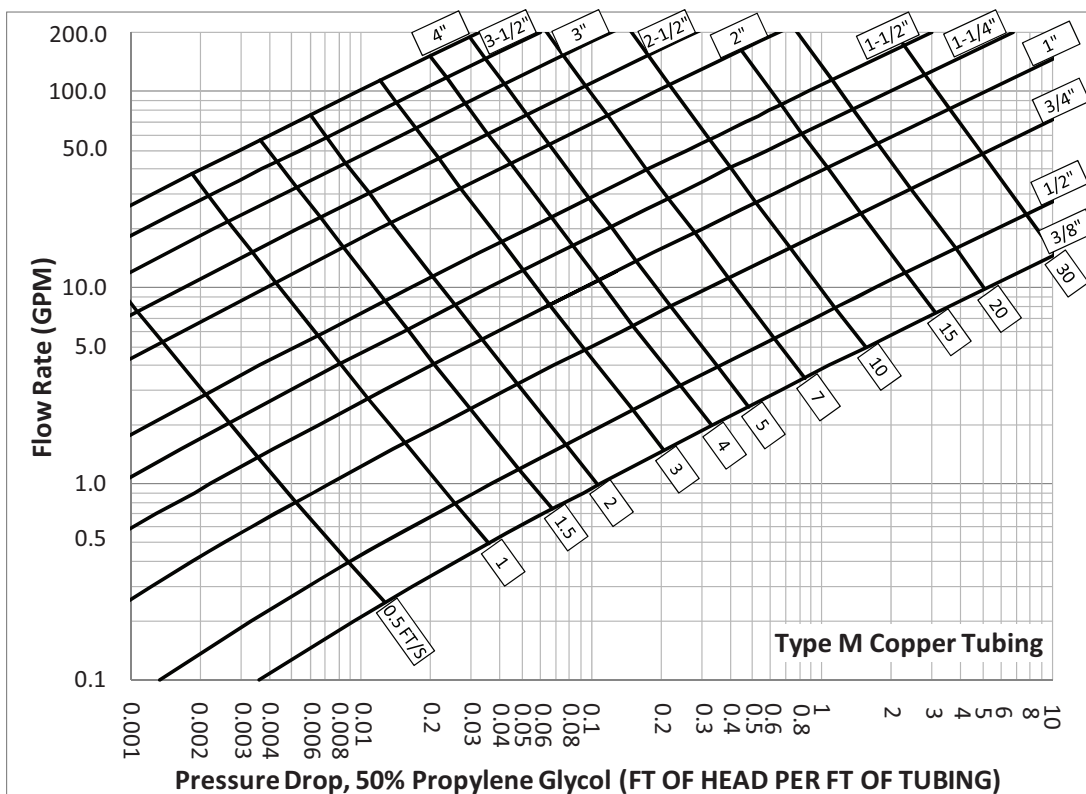


Table 1-26 Fifty percent propylene glycol pressure drop table for Type M copper tubing

### 1.11.2.4 Glycol expansion tank selection

Glycol solutions require larger expansion tanks than 100% water solutions. Expansion tanks for glycol solutions are typically at least 1.2 times the size of those required for 100% water solutions. To size an expansion tank for a glycol solution, use the same equation that you would to size a 100% water solution. When using the following equation to size an expansion tank for a glycol solution, be sure to use the appropriate densities of the % glycol solution based on the type of glycol (i.e., propylene or ethylene), and the values provided in Table 1-16 and Table 1-18.

$$V_t = V_s \cdot \left( \frac{D_c}{D_h} - 1 \right) \cdot \left( \frac{P_{RV} + 9.7}{P_{RV} - P_a - 5} \right)$$

$V_t$  = minimum tank volume (gal)

$V_s$  = fluid volume in system (gal)

$D_c$  = density of the fluid at its initial start

temperature (lbs/ft<sup>3</sup>), whether water or glycol mix

$D_h$  = density of the fluid at its maximum operating

temperature (lbs/ft<sup>3</sup>), whether water or glycol mix

$P_a$  = air side pressurization on the opposite side of the bladder, typically set at 12 psi from factory (psi)

$P_{RV}$  = pressure relief valve setting in (psi)

### 1.11.3 Glycol system maintenance

Glycol solutions should be checked each year using a suitable refractometer to determine glycol concentration. Check the concentration of corrosion inhibitor periodically, following procedures recommended by the glycol manufacturer. Typically, glycol manufacturers offer a maintenance service for a reasonable cost.

### 1.12 Controlling the system

While the sizing of a heating system is based on design day conditions (i.e., full-load), heating systems are required to operate at part-load conditions for over 90% of the heating season. Additionally, modern systems are typically called upon to deliver water to separate zones at different supply temperatures. To maintain comfortable conditions throughout a building regardless of the instantaneous heat load, it is imperative to specify a well-designed control system. Designs may incorporate fixed or variable temperatures, fixed or variable flow, and multiple zoning options.

Supply Temperature	Control Method	Supporting Hardware	Flow	Zoning
Fixed	Thermostat (standard or programmable)	<ul style="list-style-type: none"> <li>Thermostatic mixing valve</li> <li>Dedicated heat source</li> <li>Hydronic mixing block</li> </ul>	Fixed – Single speed circulator(s) with bypass	<ul style="list-style-type: none"> <li>Powerheads</li> <li>Pumps</li> <li>Zone valves</li> </ul>
			Variable – Variable speed circulator(s); no bypass required	
Variable	Thermostat (standard or programmable) with: <ul style="list-style-type: none"> <li>Outdoor reset and/or</li> <li>Indoor reset</li> </ul>	<ul style="list-style-type: none"> <li>Mixing valve</li> <li>Diverting valve</li> <li>Injection mixing</li> <li>Modulating heat source</li> <li>Hydronic mixing block</li> </ul>	Fixed – Single speed circulator(s) with bypass	
			Variable – Variable speed circulator(s); no bypass required	

Table 1-27 Control options and methods for radiant heating systems

### 1.12.1 Fixed temperature

A fixed temperature control is the most simplistic but also the least precise. This temperature control method provides one set water temperature to the system at all times, and can be achieved by setting the heat source to a fixed temperature or by using a thermostatic device to maintain a fixed temperature based upon incoming water temperatures. This control method is typically used in an effort to reduce first costs of controls by eliminating actuators, reset controls, etc. To prevent overheating, it is normally used in conjunction with a device that reduces or stops flow when the space is satisfied.

- Thermostatic mixing valve – Water temperature on the outlet of a thermostatic mixing valve is regulated by a built-in, non-electric temperature control. The non-electric control is set to the desired temperature and adjusts the amount of hot supply or cold return water that flows through the valve in order to maintain the desired supply temperature to the panel. See Figure 1-33.

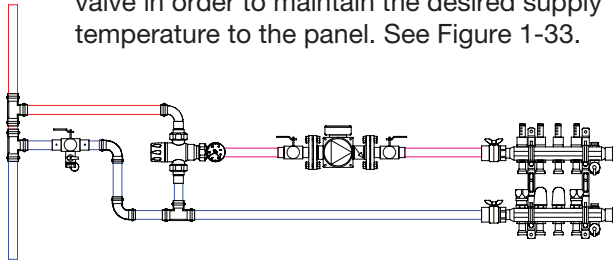


Figure 1-33 Thermostatic mixing valve to provide fixed supply temperature to manifold

- Dedicated heat source – With this configuration, the heat source is programmed to output a fixed supply temperature, which it achieves through its internal sensors and controls that vary the amount of energy consumed (fossil fuel, electricity, etc.). Modulating-condensing boilers and ground source heat pumps are ideal for this configuration. If a cast iron boiler is specified, ensure that boiler protection is provided to avoid low return temperatures that could result in condensation of flue gases and damage to the unit.

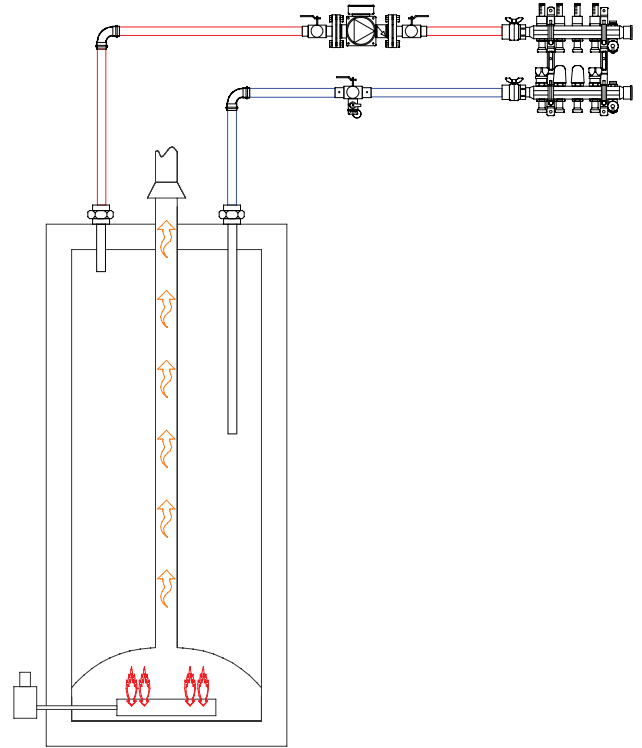


Figure 1-34 Dedicated heat source to provide fixed supply temperature to manifold. Check with manufacturer and local code to ensure application is acceptable. Note that expansion tank, trim, etc, have been omitted for clarity

### 1.12.2 Radiant floor heating panels

(CSA B214 Clause 12.1.2)

Radiant floor heating panels shall be protected with a high-limit control set 11°C (20°F) above the maximum design water temperature for the panel to stop the introduction of heat into the panel. The high-limit setting shall not exceed the temperature rating for the pipe.<sup>12</sup>



### 1.12.3 Variable temperature

A variable temperature system adjusts the system's supply temperature based on the anticipated heat load, which is estimated based on outdoor temperature, indoor temperature or both. Advantages to this temperature control approach include the following:

- Promotion of low-temperature heating, which can increase the efficiency of the heating system (exception: low-efficiency, non-condensing boilers)
- Ability to avoid overheating a space by reducing supply temperatures to respond to dynamic heating loads
- More even heating of surfaces (less striping effect) from longer cycles
- Easy integration with high-efficiency, modulating boilers

An outdoor or indoor reset control is specified in a variable temperature system to anticipate changes in heating load and to adjust the supply temperature to respond accordingly. The outdoor and indoor reset controls both serve the function of increasing supply water temperature when they measure a drop in ambient temperature (outdoor and indoor, respectively), and decreasing supply water temperature when they detect an increase in ambient temperatures. By anticipating heat loads and providing more precise control of a space, reset controls assist with providing a faster system response time and with avoiding overheating of a space. An example of an outdoor reset control curve is provided in Figure 1-35.

### 1.12.4 Radiant floor heating panels

(CSA B214 Clause 12.1.2)

Radiant floor heating panels shall be protected with a high-limit control set 11°C (20°F) above the maximum design water temperature for the panel to stop the introduction of heat into the panel. The high-limit setting shall not exceed the temperature rating for the pipe.<sup>13</sup>

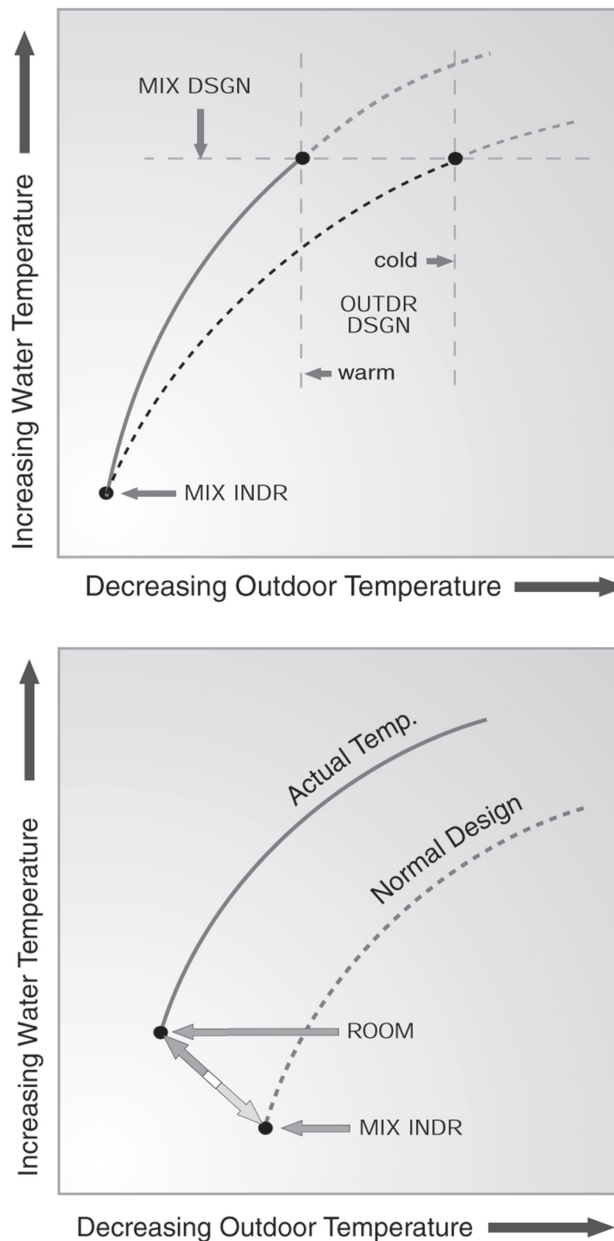
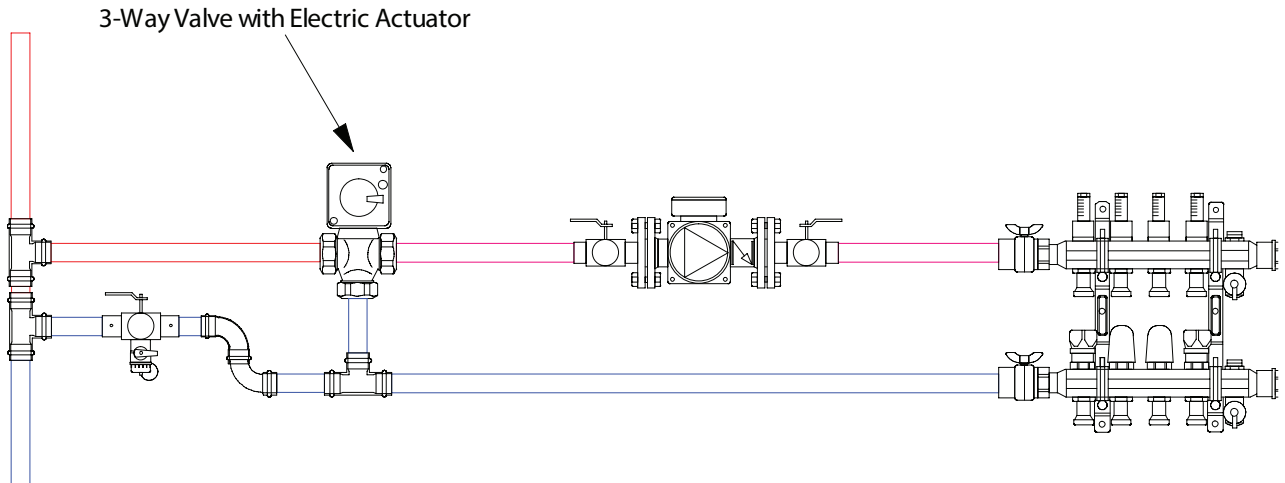


Figure 1-35 Outdoor reset curve

13. ©CSA Group, B214-12. 2012. "Installation Code for Hydronic Heating Systems" Clause 12.1.2

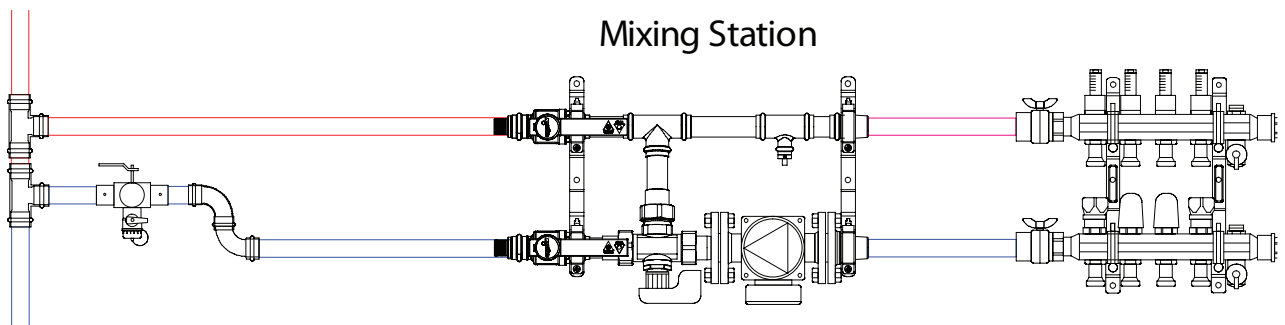
Reset controls communicate with one or more of the following supporting hardware to effectively vary the supply temperature: mixing valve, diverting valve, injection mixing and/or modulating heat source.

- **Mixing Valve** – A mixing valve is controlled by an electronic actuator that receives a signal from a reset control. This control varies the temperature being supplied to the manifold by adjusting the amount of hot supply or cold return water that is permitted to flow through the valve.



*Figure 1-36 Mixing valve with electronic actuator*

- **Diverting Valve** – A diverting valve is controlled by an electronic actuator that receives a signal from a reset control. This control varies the temperature being supplied to the manifold by adjusting the volume of return water being diverted back into the supply stream.



*Figure 1-37 Diverting valve with electronic actuator*

- Injection Mixing – This variable temperature control option uses either a single-speed or variable-speed injection circulator that receives a signal from a reset control to vary the volume of hot water injected into the secondary piping. These small injected amounts of hot water mix with the water in the secondary piping, increasing the temperature as needed. One advantage to using an injection mixing system is that a large amount of Btus can be carried using a relatively small diameter and a low-wattage circulator.

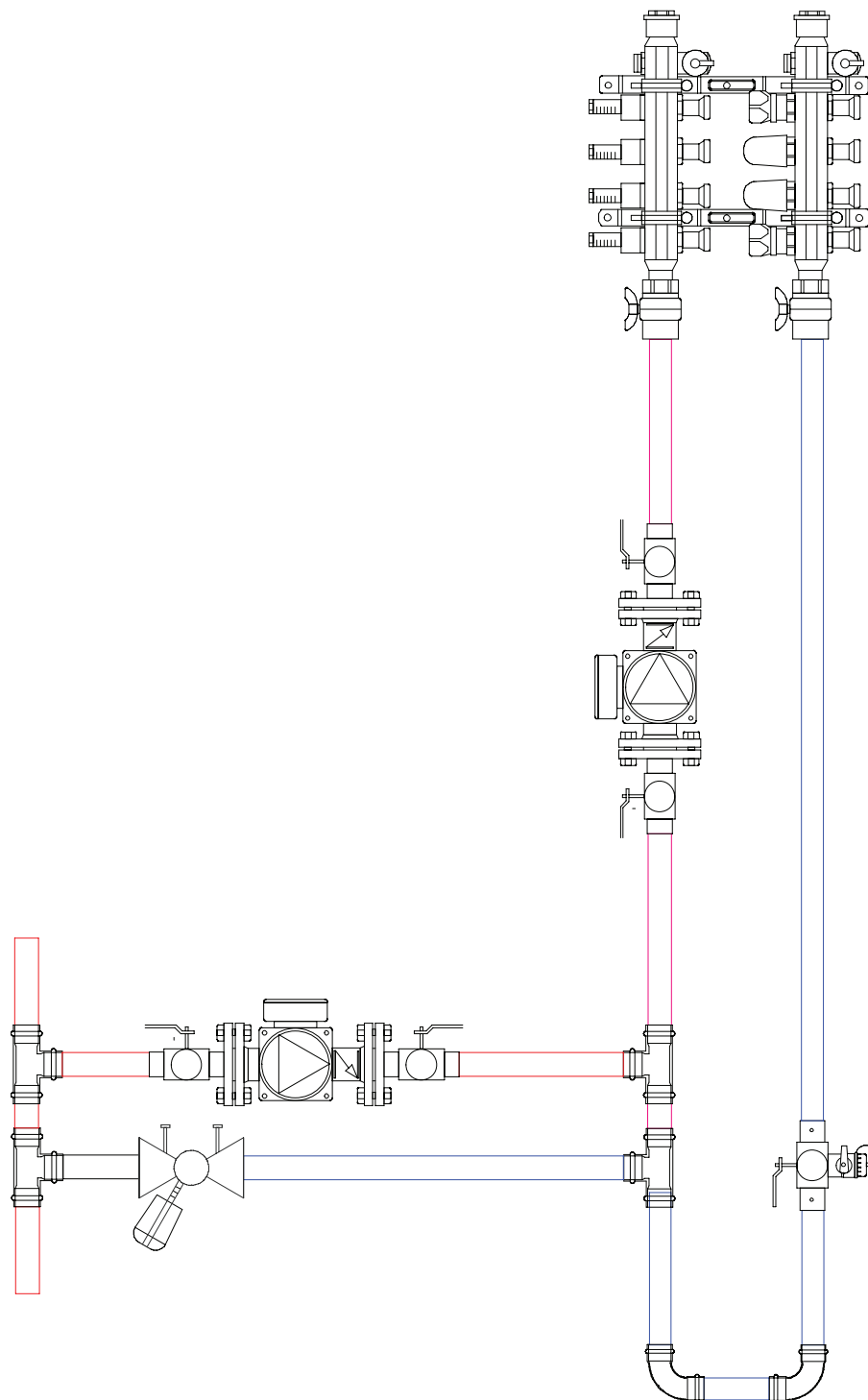


Figure 1-38 Injection mixing with electronic control

- Modulating Heat Source – The heat source is controlled by a reset control to vary the supply water temperature based upon the outdoor and/or indoor temperatures, thus potentially eliminating the need for additional mixing devices. Depending on the heat source type and manufacturer, modulation methods may vary. Multiple temperature systems may require secondary mixing in addition to boiler modulation.

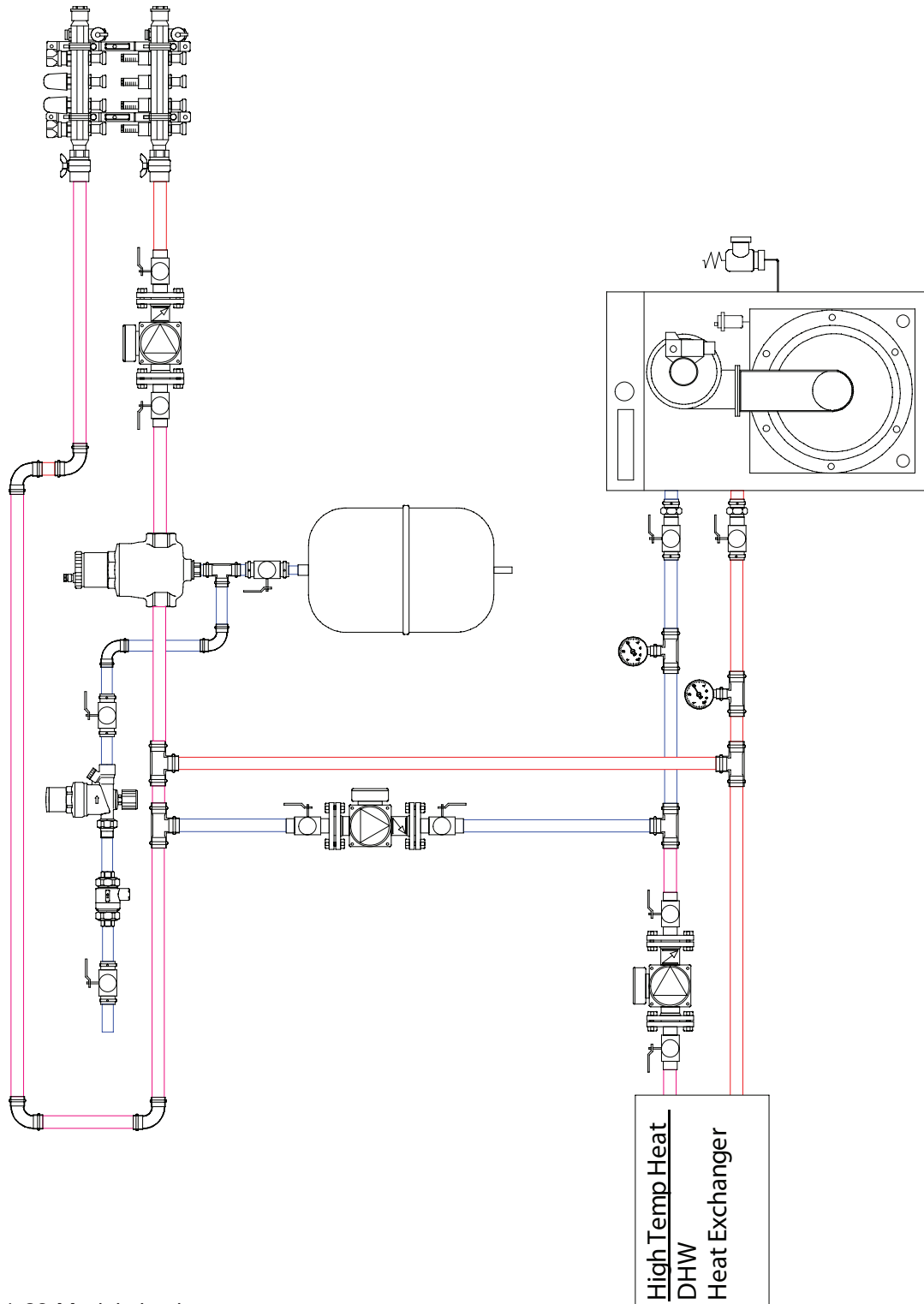


Figure 1-39 Modulating heat source

### 1.12.5 Flow control

Flow may be provided with fixed- or variable-speed circulators, both of which offer proven performance in radiant heating systems.

Fixed-speed circulator benefits

- Generally a lower first cost than variable-speed pumps
- Good availability of circulators with proven performance

Variable-speed circulator benefits

- Potential for reduced energy consumption by reducing flow to meet instantaneous demand
- Less circulators may be required within a system because one circulator can cover a large range of pressure drop, which can occur as circuits open and close
- Higher level of control to satisfy heating loads
- Opportunity for heating system to reach set point more rapidly after setback events

### 1.12.6 Zoning

In areas of a building that have large variations in heating loads or occupancy, zoning can provide precise control of heat delivery across spaces while optimizing comfort. Within a radiant system's piping, zoning can be provided through the use of powerheads, zone valves or circulators that respond to a call for heat.

- Powerheads
  - Located on individual manifold circuits
  - Provides the opportunity to supply multiple zones with a single manifold, allowing for less secondary piping throughout the building
  - Exterior loops can be left to run off outdoor reset alone rather than powerhead control, which may provide smaller temperature swings in the space
  - Simple installation when dealing with small 1- and 2-circuit zones
  - Single circulator may require less power consumption than multiple

### 1.12.7 Differential pressure regulation

(CSA B214 Clause 12.5.5)

#### General

Provision shall be made to control zone flows in a multi-zone hydronic system where the closing of some or all of the two-way zone valves can cause excess flow through the open zones or deadheading of a fixed-speed pump.

#### Differential pressure bypass valve

When a differential pressure bypass valve is used for the purpose specified in Clause 12.5.4, it shall be installed and adjusted to provide bypass of the distribution system when most or all of the zones are closed.<sup>14</sup>

14. ©CSA Group, B214-12. 2012. "Installation Code for Hydronic Heating Systems" Clause 12.5.5

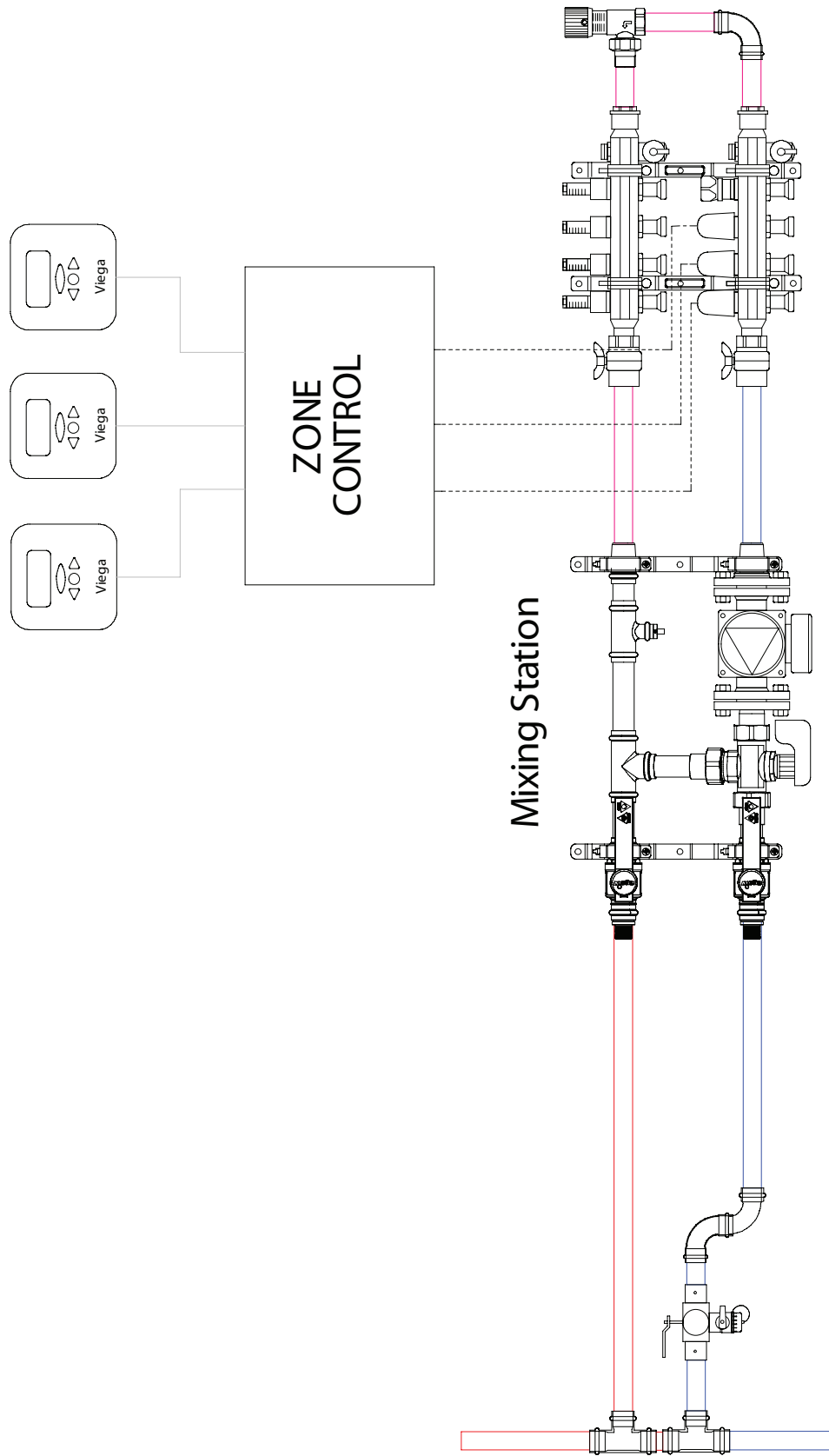


Figure 1-40 Powerhead zoning with fixed-speed circulator and fixed flow bypass

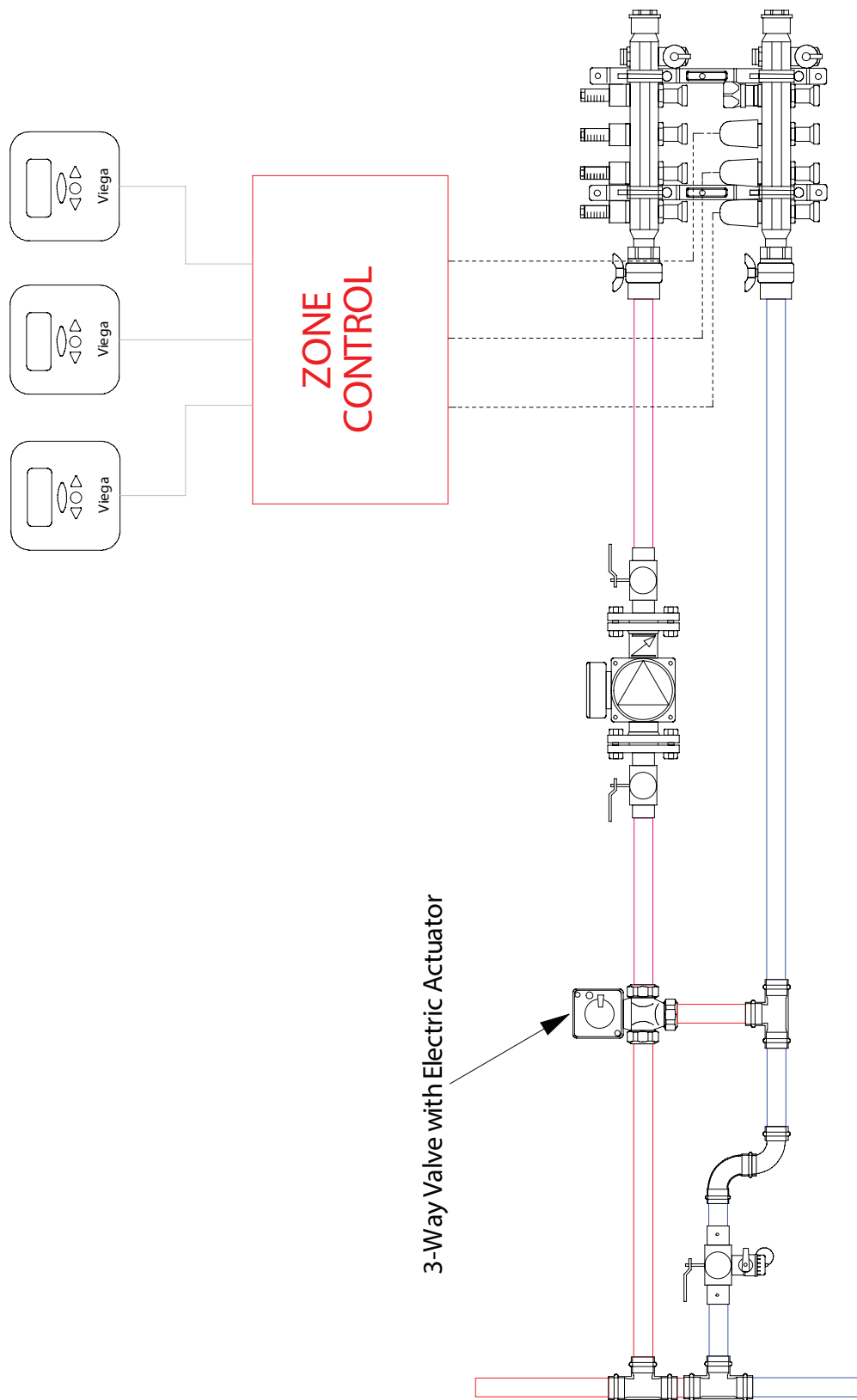


Figure 1-41 Powerhead zoning with variable-speed circulator. No differential bypass is required. Variable-speed circulator ramps up and down as powerheads close to reduce power consumption.

- Zone valves
  - Can control single or multiple circuits
  - Low voltage wiring may reduce trades required
  - Some dry cartridges for easy replacement of failed components
  - Single circulator may require less power consumption than multiple

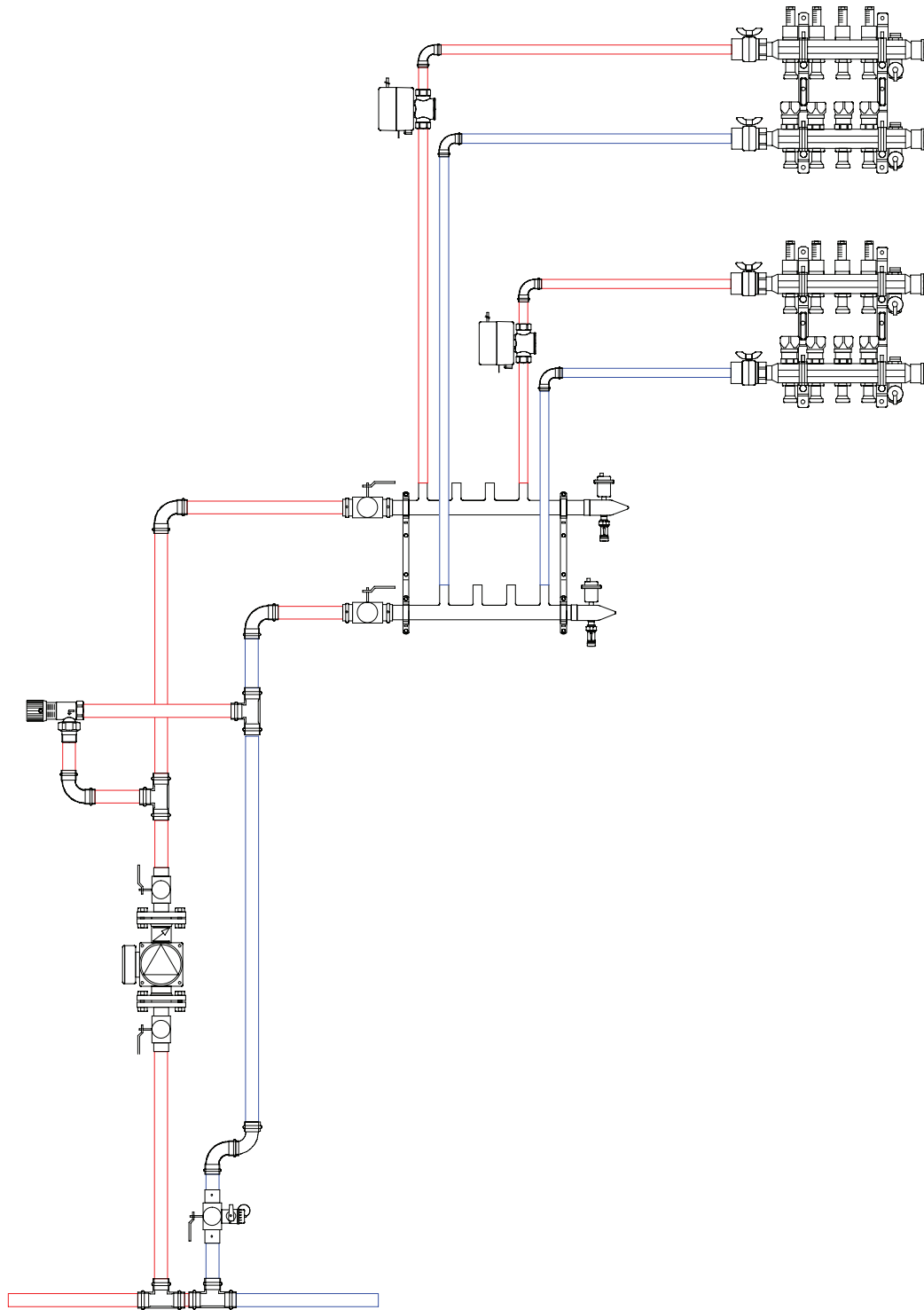
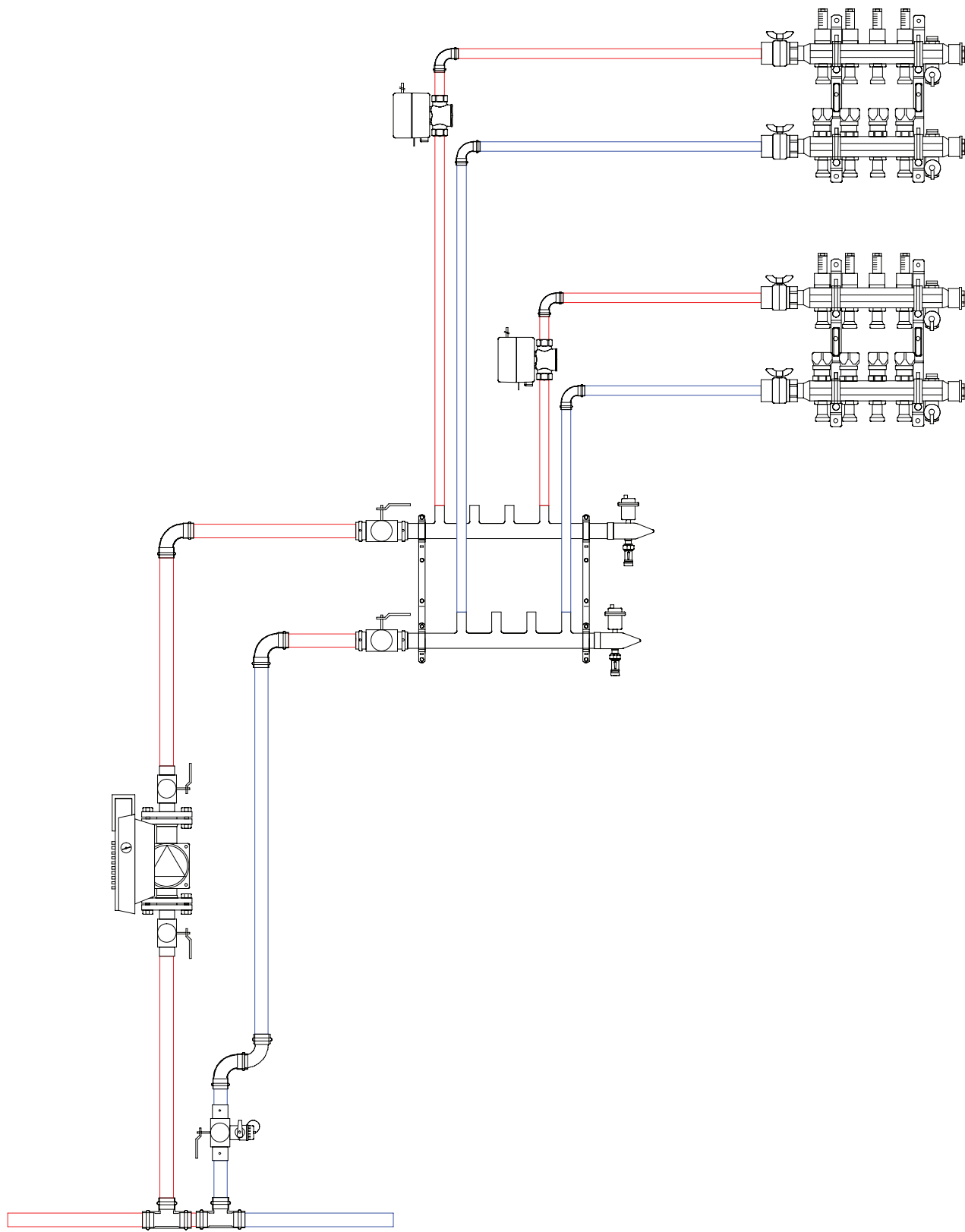


Figure 1-42 Zone valve zoning with fixed-speed circulator and fixed flow bypass





*Figure 1-43 Zone valve zoning with variable-speed circulator. No differential bypass is required. Variable-speed circulator ramps up and down as zone valves close to reduce power consumption.*

- Circulators
  - No differential bypass requirement
  - Larger flow capabilities as circulator sized per zone
  - 120V may simplify wiring
  - Circulator runs only when zone calls for heat

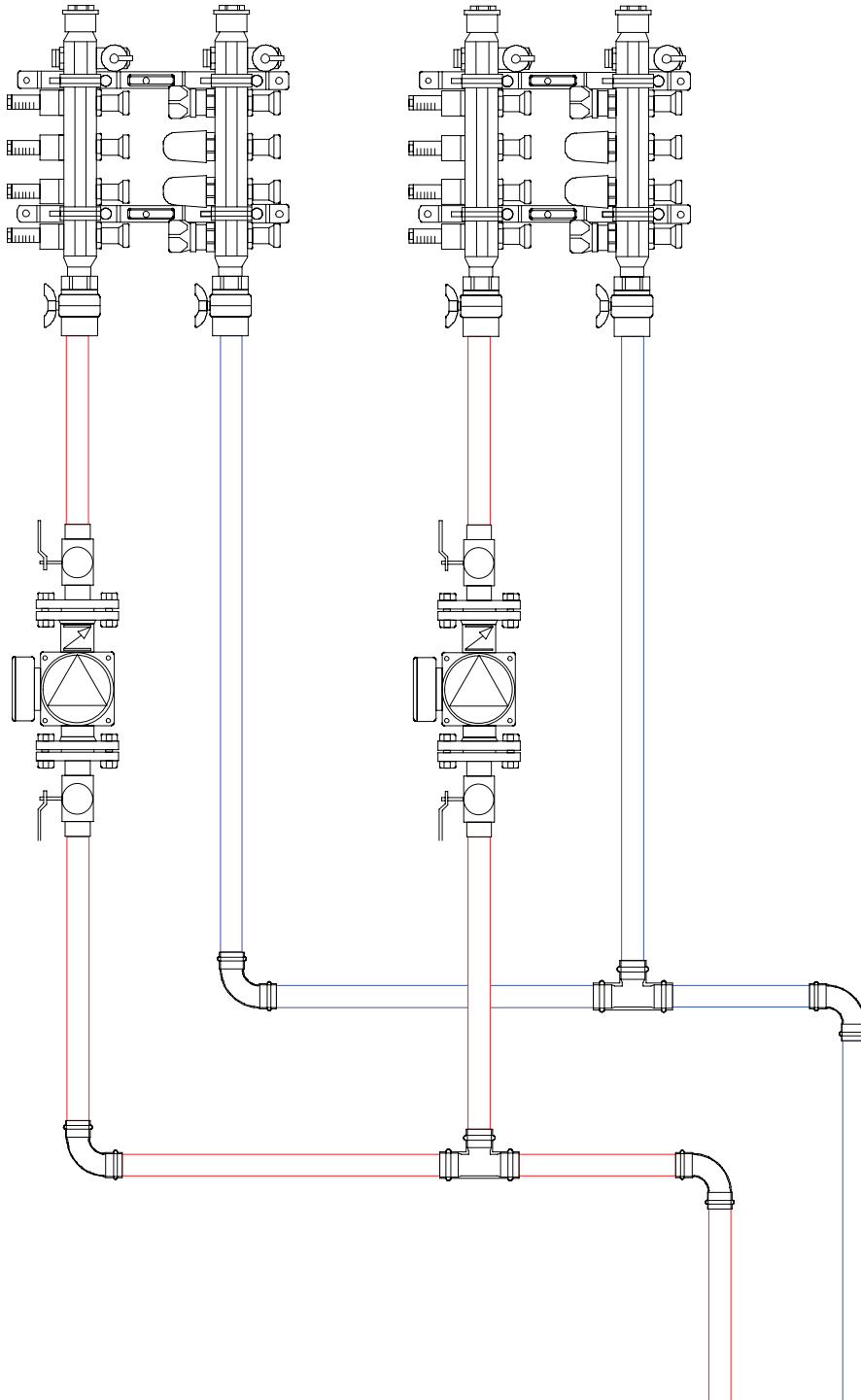


Figure 1-44 Circulator zoning

### 1.13 Minimum required design information

(TECA 2009, Clause 2.9)

Room Identification and Room Heat Loss  
(Btu / hr)

Floor Area and Total Usable Floor Area (ft<sup>2</sup>)  
Btu / hr / ft<sup>2</sup> of Panel Area

Floor Covering R-Value or Adjustment  
Factor \*(See Note below)

System Design Temperature Drop  
Radiant Floor Heating Supply Water  
Temperature

Boiler Supply Water Temperature

Pipe Size, Maximum Spacing and Total  
Length of Piping per Room

Minimum Number of Loops

Auxiliary Heat Required per Room

Active Element Length per Room  
(Baseboard Systems)

Btu / LF Used to Calculate Baseboard  
Active Length

Size and Output of Other Heat Emitters

Supply Water Temperature of all Heat  
Emitter Systems<sup>15</sup>

15. ©TECA. 2009. "Hydronic & Combo Guidelines" Clause 2.9

## 2 Residential Radiant Heating Considerations

The basic principles of residential radiant heating design are contained in Section 1, Principles of radiant heating design. This section contains additional information related specifically to residential applications.

### 2.1 Codes and standards

Relevant codes and standards that may apply to residential radiant applications are listed in Table 2-1, according to topic. While not all of these codes, standards or green building programs apply to all jurisdictions, contractors should still be familiar with the minimum design practices that they encourage. As an example, the 2009 International Residential Code requires that a Manual J heating load calculation be performed when sizing heating equipment for new residential construction and also identifies the insulation levels required for heated slabs.

Legend:

CSA B214 – Installation Code for Hydronic Heating Systems

ACI 318 – Building Code Requirements for Structural Concrete and Commentary

ASHRAE 90.1 – Energy Standard for Buildings Except Low-Rise Residential Buildings

ASHRAE 55 – Thermal Environmental Conditions for Human Occupancy

ASHRAE 189.1 – Standard for the Design of High Performance, Green Buildings

ASHRAE/ACCA 183 – Peak Cooling and Heating Load Calculations in Buildings Except Low-Rise Residential Buildings

IECC – International Energy Conservation Code

IMC – International Mechanical Code

IRC – International Residential Code

LEED – The United States Green Building Council’s Leadership in Energy and Environmental Design program, which serves as one of the most widely recognized green building programs

Manual J – Air Conditioning Contractors of America’s Manual J Residential Load Calculation

NGBS – National Green Building Standard

Residential Design Consideration	Up to 3 Stories				Multifamily over 3 Stories				All			
	IRC	NGBS	Manual J	CSA B214	ASHRAE 90.1	ASHRAE 189.1	ASHRAE / ACCA 183	IMC	IECC	ASHRAE 55	ACI 318	LEED
Loop balancing				X	X	X			X			
System controls	X	X		X	X	X			X			X
Credit for radiant energy savings		X			X	X			X			X
Distribution system installation or specification	X			X				X			X	
Insulation	X	X		X	X	X		X	X			
Load calculation	X	X	X		X	X	X	X	X			
Circulating pumps					X	X			X			
Radiant heating requirement for unenclosed spaces					X	X						
Snow melt	X			X	X	X			X			X
Designing for comfort				X		X				X		X
Peak load reduction						X						

Table 2-1 Radiant design considerations as addressed by residential national model codes, standards and green building programs. Check with your local jurisdiction for applicability.

## 2.2 System documentation and operational instructions

(CSA B214, Clause 4.6.2)

The installer shall ensure that the system documentation and manufacturer's operational instructions are left near the primary heating equipment or, if that is not practical, near the main electrical distribution panel, in order for service and maintenance personnel to have access to the documentation and instructions.

**Notes:**

- (1) *Examples of information that should be provided in the documentation of the system for hydronic space heating include*
- (a) *a room-by-room heat loss calculation in kW (Btu/h);*
  - (b) *the heat output of the heat-distribution unit in kW (Btu/h);*
  - (c) *the system design water temperatures in °C (°F);*
  - (d) *the pipe size in mm (nominal size NPS, in) and total length of piping in m (ft); and*
  - (e) *the system head loss and flow rates in kPa and L/s (psi and gpm).*
- (2) *Examples of information that should be provided in the documentation of the system for radiant heating include*
- (a) *a room-by-room heat loss calculation in kW (Btu/h);*
  - (b) *the floor area in m<sup>2</sup> (ft<sup>2</sup>);*

- (c) *the total usable panel area in m<sup>2</sup> (ft<sup>2</sup>);*
  - (d) *the heat output density in W/m<sup>2</sup> ((Btu/h)/ft<sup>2</sup>) of panel area;*
  - (e) *the radiant heating panel supply water temperature in °C (°F);*
  - (f) *the pipe size in mm (nominal size NPS, in), maximum spacing between the lengths of piping in mm (in), and total length of piping in m (ft);*
  - (g) *the minimum number of heating loops;*
  - (h) *the boiler supply water temperature in °C (°F);*
  - (i) *the auxiliary heat required in kW (Btu/h);*
  - (j) *the RSI value in m<sup>2</sup>•K/W (R-value) of the floor coverings;*
  - (k) *the RSI value m<sup>2</sup>•K/W (R-value) of the insulation under and at the edges of the radiant panel;*
  - (l) *the outdoor design temperature in °C (°F);*
  - (m) *the floor surface temperatures in °C (°F); and*
  - (n) *the system friction loss and flow rate in kPa and L/s (psi and gpm).*
- (3) *Additional information for documentation of the system is presented in Figures A.1 and A.2.*
- (4) *Attempts should be made to instruct the user in the safe and correct operation of the system.*<sup>16</sup>

16. ©CSA Group, B214-12. 2012. "Installation Code for Hydronic Heating Systems" Clause 4.6.2

The principles of radiant heating design for commercial, industrial and agricultural projects are similar to residential. However, the implementation of these principles can differ significantly when considering the scale, controls and heating systems used for these jobs. Additionally, radiant cooling has begun to see broader adoption in North America in the commercial market, especially in hot, dry climates. Advances in installation methods, like Viega's revolutionary Climate Mat, and an increasing focus on the design of energy-efficient buildings are increasing the frequency of radiant heating and cooling technologies in the commercial market.

Commercial applications include not only indoor installations that are paired with building floors, walls and ceilings but also outdoor applications such as turf conditioning and snow melting. Viega's Technical Services department is available to assist you with the design of your commercial radiant heating or cooling distribution system. Services offered for large commercial jobs (i.e., > 10,000 ft<sup>2</sup>) include:

- Climate Mat design and layout: CAD drawings of layouts, tubing dimensions, tubing spacing, Climate Mat configurations
- Manifold design and layout: CAD drawings of layouts, number of mats per manifold, manifold flow rates and supply temperatures to achieve design loads
- CAD drawings of layouts, tubing dimensions, tubing spacing, manifold flow rates and supply temperatures to achieve design loads
- Developing material lists
- Calculating pressure drop
- Technical support

Complete installation instructions for Climate Mat, including cross-sectional illustrations, layout planning guidance and installation tips, can be found in Appendix F.

### 3.1 Codes, standards and green building

States and local jurisdictions are placing an increasing emphasis on codes and standards related to energy efficiency. Table 3-1 contains a list of national model codes, standards and green building programs that address at least one radiant-conditioning-related topic. As an example, both ASHRAE 90.1 and the IECC address specific requirements for controls used in radiant snow melting systems.

Legend:

CSA B214 - Installation Code for Hydronic Heating Systems

ACI 318 - Building Code Requirements for Structural Concrete and Commentary

ASHRAE 90.1 - Energy Standard for Buildings Except Low-Rise Residential Buildings

ASHRAE 55 - Thermal Environmental Conditions for Human Occupancy

ASHRAE 189.1 - Standard for the Design of High-Performance, Green Buildings

ASHRAE/ACCA 183 - Peak Cooling and Heating Load Calculations in Buildings Except Low-Rise Residential Buildings

IECC - International Energy Conservation Code

IMC - International Mechanical Code

LEED - The United States Green Building Council's Leadership in Energy and Environmental Design program, which serves as one of the most widely recognized green building programs

Design Considerations	CSA B214	ASHRAE 90.1	ASHRAE 189.1	ASHRAE / ACCA 183	IMC	IIECC	ASHRAE 55	ACI 318	LEED
Loop balancing	X	X	X			X			
System controls	X	X	X			X			X
Credit for radiant energy savings		X	X			X			X
Distribution system installation or specification	X				X			X	
Insulation	X	X	X		X	X			
Load calculation		X	X	X	X	X			
Circulating pumps		X	X			X			
Radiant heating requirement for unenclosed spaces		X	X			X			
Snow melt	X	X	X			X			X
Designing for comfort	X		X				X		X
Peak load reduction			X						

Table 3-1 Radiant design considerations as addressed by commercial national model codes, standards and green building programs. Check with your local jurisdiction for applicability.

### 3.2 Insulation

Recommended minimum levels of slab insulation are given in Table 3-2 based on a location’s climate zone, which can be found in Figure 1-8. If radiant floor delivery temperatures are limited by the equipment type, higher levels of insulation can be specified to increase the heat transfer between the conditioned space and the slab. In all cases, a vapor barrier should be provided under slabs with ground contact for all indoor installations. Always provide full sub-slab insulation and adequate drainage where there is a high water table.

Application	Slab with Ground Contact, Perimeter Insulation by Climate Zone	Suspended Slab (e.g., between floors), Horizontal Insulation
Heating Only	CZ 1-2: R-7.5, 12-inch depth CZ 3: R-10, 24-inch depth CZ 4-5: R-15, 24-inch depth CZ 6-8: R-20, 48-inch depth	R-value that is 5 times the value of the floor covering’s R-value. See Table 3-3 for more detail on the back loss as a function of insulation below the suspended slab.
Cooling Only	R-5 where chilled slab abuts unconditioned space	Same as heating
Heating and Cooling	Same as heating	Same as heating

Table 3-2 Minimum recommended R-values for slab insulation of conditioned slabs. Perimeter insulation may be applied on the interior or exterior of the foundation. Perimeter insulation should be applied vertically or a combination of vertically and horizontally, when it extends to at least the depth of the slab. Listed depths are measured from the top of the slab.

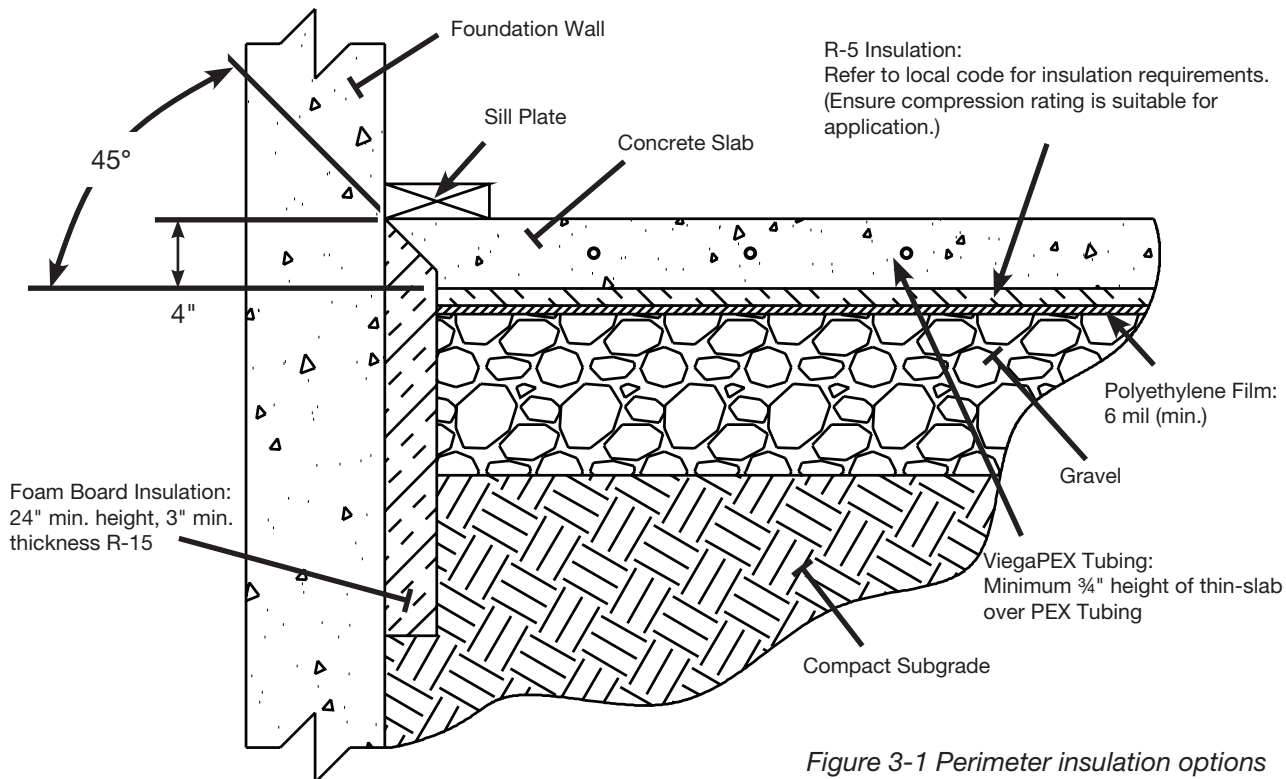


Figure 3-1 Perimeter insulation options

Insulation Below Suspended Slab (R-Value)	Floor Covering R-Value					
	0.25	0.5	1	1.5	2	2.5
	Suspended Slab, Back Loss in Heating					
0	44%	50%	58%	64%	69%	72%
2.5	22%	25%	32%	38%	42%	48%
5	14%	16%	22%	27%	30%	34%
7.5	10%	13%	17%	21%	24%	28%
10	8%	10%	14%	17%	20%	22%

Table 3-3 Suspended slab back losses as percent of total heat transfer from panel, assuming a mean heating water temperature of 120°F, and an air temperature above and below the suspended slab of 68°F.

**NOTE:**

For insulation requirements for Canada see Page 13 Section 1.3.3 of this manual.



### 3.3 Heating and cooling load calculations

For large commercial jobs, Viega assumes that the HVAC contractor has familiarity with conducting heating and cooling load calculations. When conducting a heating or cooling load calculation for a commercial space, incorporate the following ancillary loads and considerations as necessary:

- Ventilation air requirements – may vary with occupancy
- Infiltration and air tightness – construction details and operation of the building (e.g., regular opening of large bay doors) will impact sensible and latent loads
- Lighting – generally accounted for in heat load calculations, but consider impact of daylighting controls and interaction of skylights and other fenestration
- Equipment – refrigeration cases, cooking equipment, large compressors, industrial machinery, etc.
- Regular storage of hot or cold items
- Occupants

- Surfaces – because the transfer of radiant heat between surfaces is impacted by the emissivity of the surfaces, less heat will transfer between a radiant panel (e.g., radiant-heated floor) and a ceiling with a low emissivity coating. Advantages and disadvantages of varying surface emissivity can be explored through building energy simulations.

### 3.4 Installation methods

In general, commercial installation methods are similar to residential, when specifying ViegaPEX Barrier or FostaPEX for use with Climate Panel (top of subfloor and walls), Climate Trak (below subfloor), Snap Panel (in-slab), or simply laying and tying tubing to reinforcements within a slab. Complete installation instructions for these methods can be found in Appendices A, B and C.

Commercial installations may involve post-tension slabs, standard slabs or slabs on a suspended deck. Special considerations for installing radiant tubing in each of these scenarios are given in Table 3-4.

Installation Type	Considerations
Post-tension Slab	<ul style="list-style-type: none"> <li>• Minimum of ¾" concrete over tubing</li> <li>• The closer the tubing to the surface, the lower the water temperature for a given surface temperature</li> <li>• Must coordinate with tightening tendons (cables)</li> <li>• Tightening tendons should be sheathed and not in direct contact with tubing</li> </ul>
Standard Slab	<ul style="list-style-type: none"> <li>• Generally secured to rigid board insulation with foam staples</li> <li>• Zip-tie to wire mesh</li> <li>• Minimum of ¾" concrete over tubing</li> <li>• The closer the tubing to the surface, the lower the water temperature for a given surface temperature</li> <li>• Zip-tied to rebar layer closest to the surface unless dictated otherwise by structural design</li> </ul>
Suspended Deck	<ul style="list-style-type: none"> <li>• Zip-tie to wire mesh</li> <li>• Minimum of ¾" concrete over tubing</li> <li>• The closer the tubing to the surface, the lower the water temperature for a given surface temperature</li> <li>• Insulation below tubing (above or below deck)</li> </ul>

Table 3-4 Considerations for installation of radiant tubing in commercial slabs

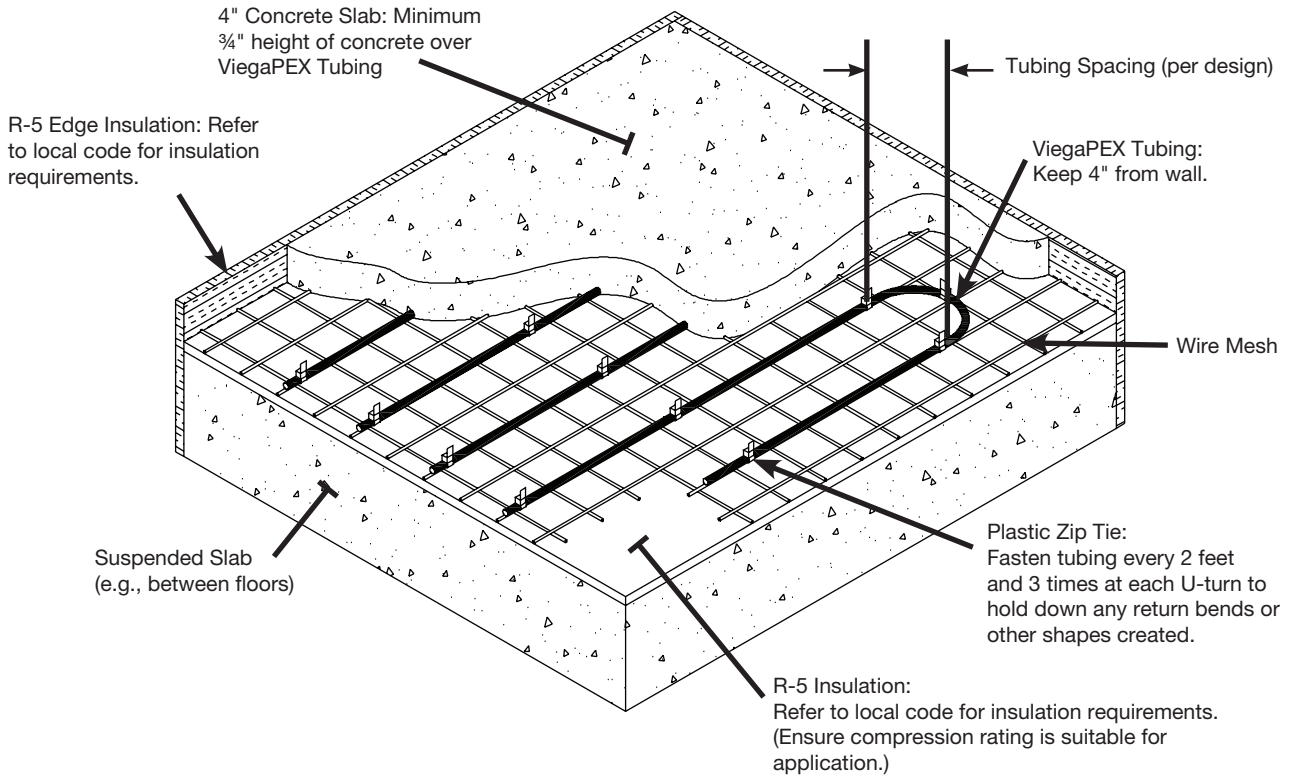


Figure 3-2a Section through concrete on suspended slab

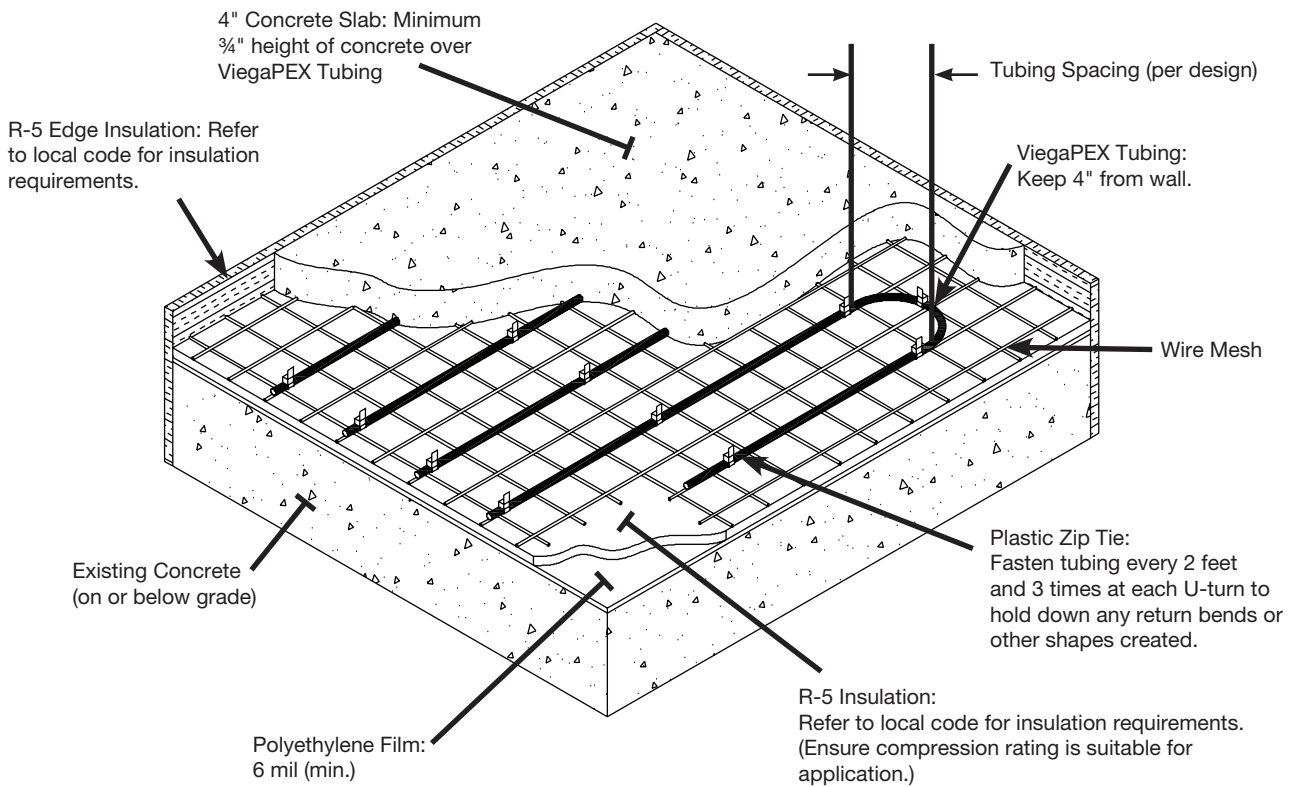


Figure 3-2b Section through concrete on existing concrete

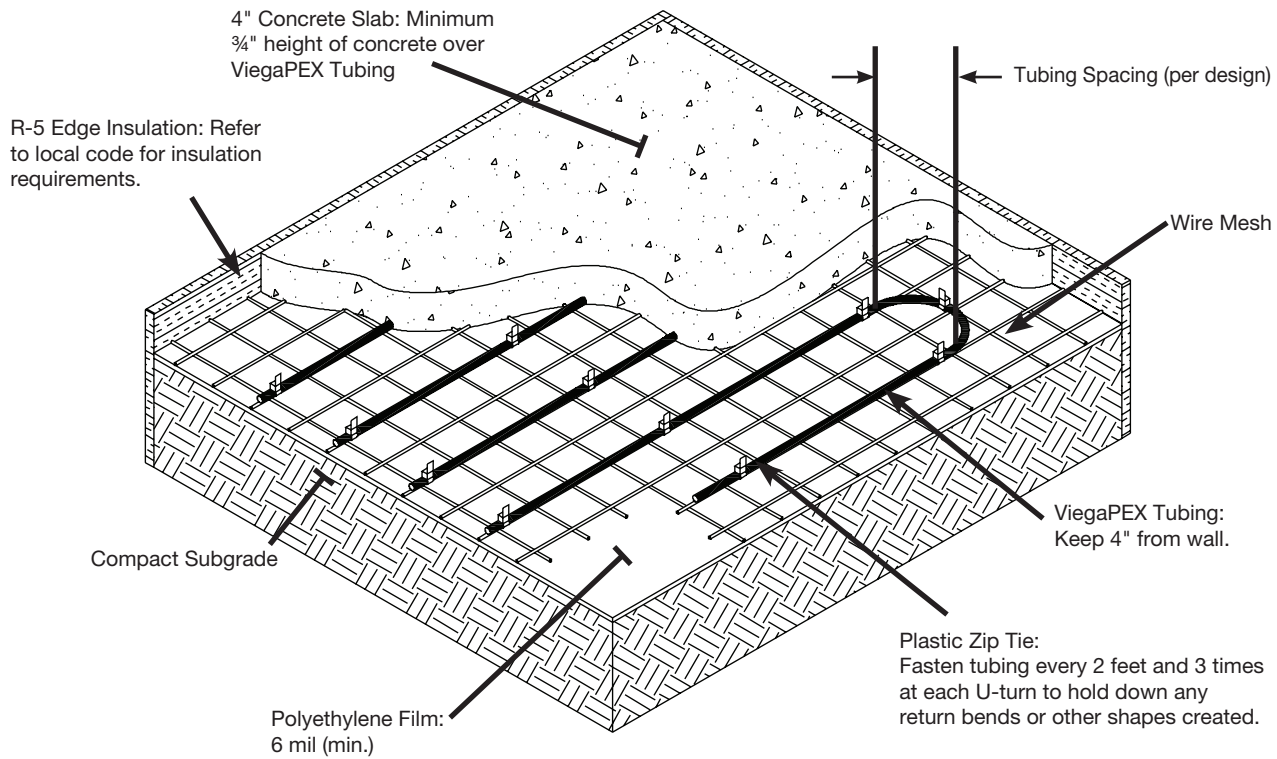


Figure 3-2c Section through concrete on concrete subgrade

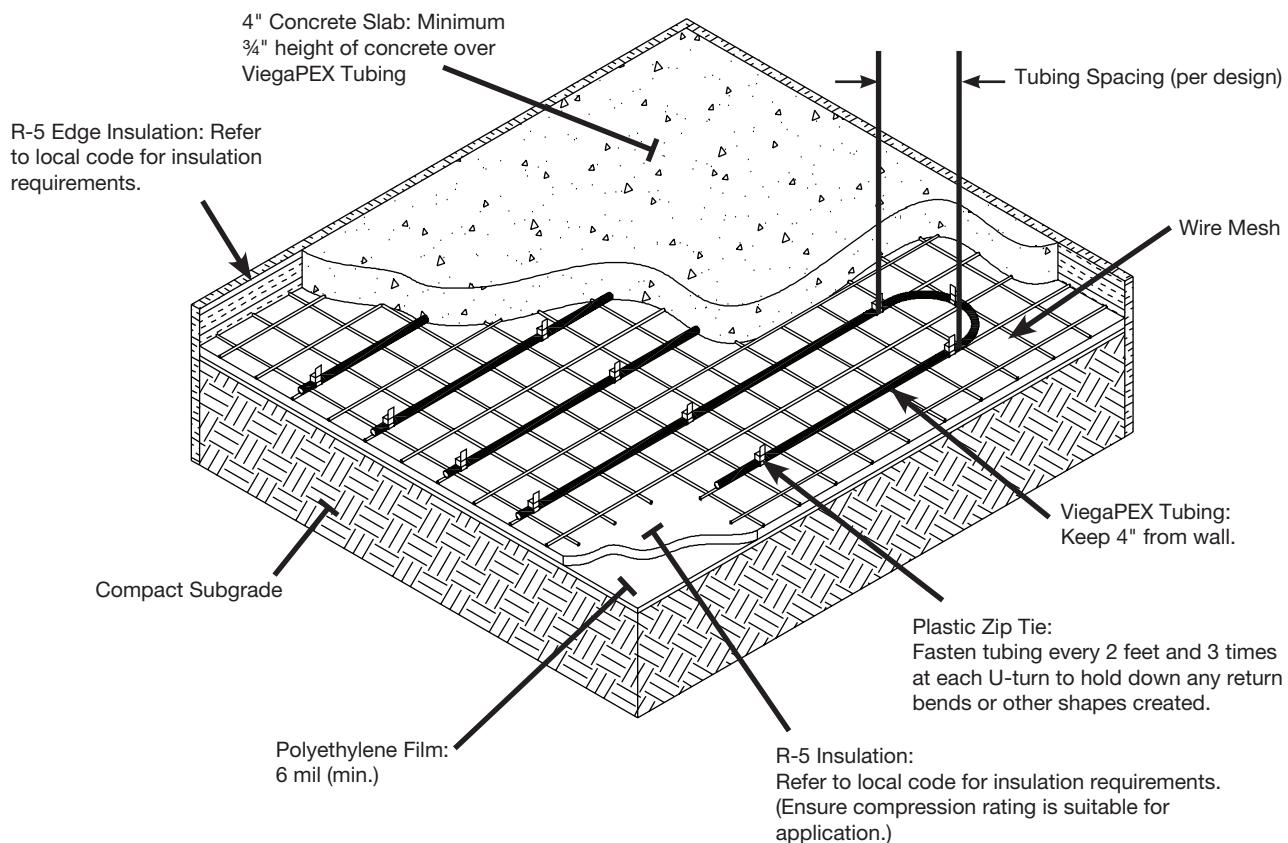


Figure 3-2d Section through concrete on compact subgrade

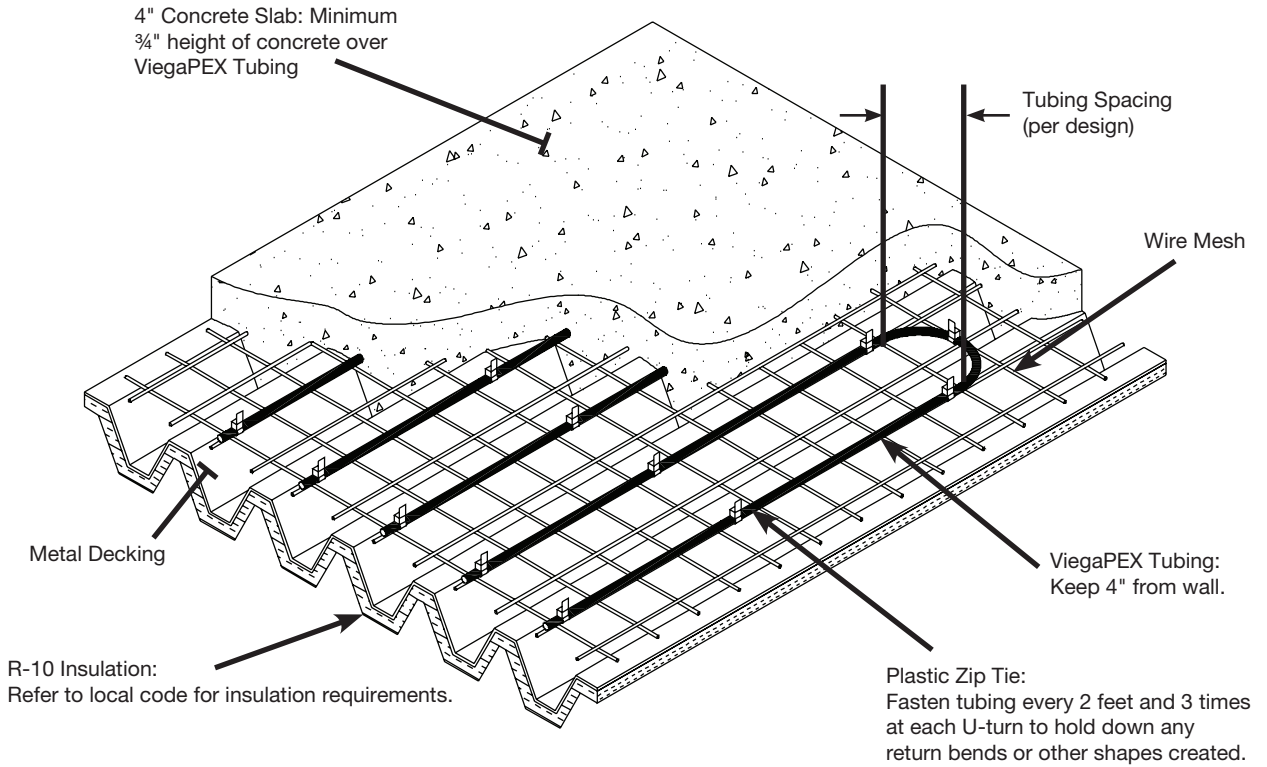


Figure 3-3a Section through concrete on metal decking

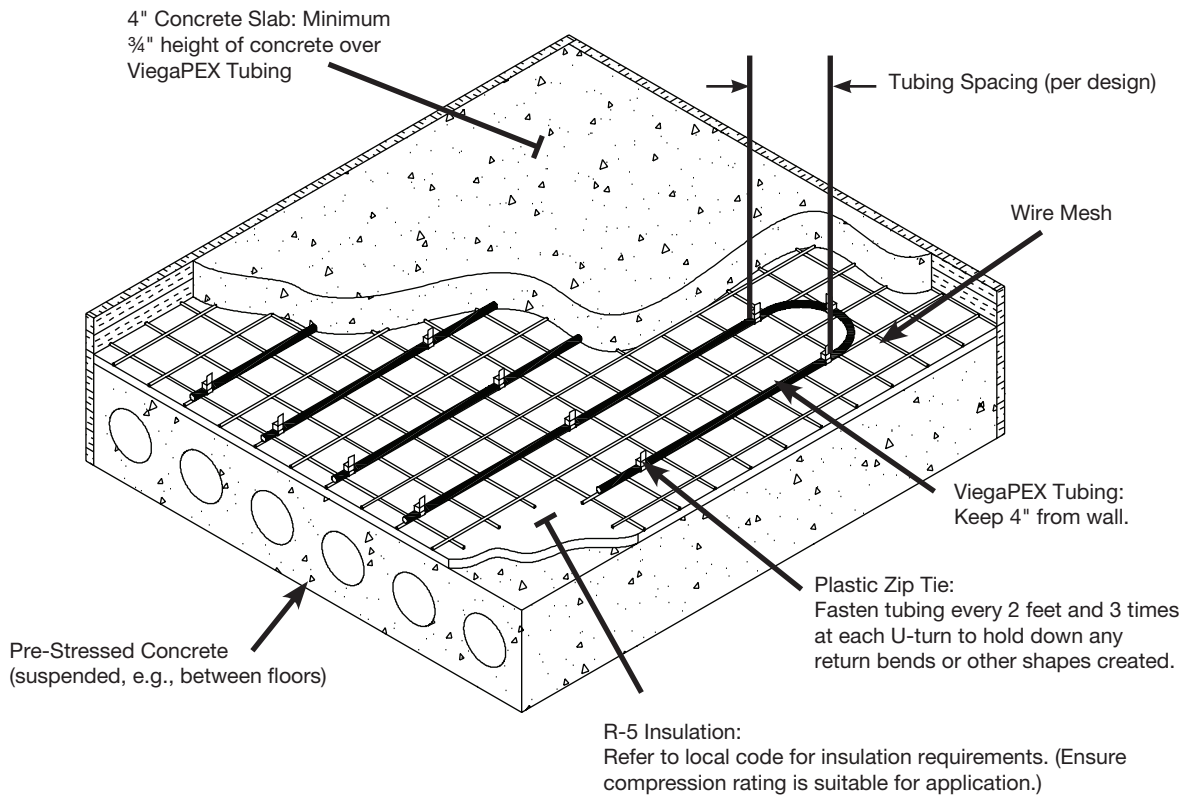


Figure 3-3b Section through concrete on pre-stressed decking

For installations > 10,000 ft<sup>2</sup> that have large, open spaces and simple geometry, Viega's Climate Mat can be specified to increase the affordability and labor-efficiency of the installation. Unlike typical radiant tubing installations, which require that individual lengths of tubing be extended and attached to a sub-base, Climate Mat is a tubing module that permits the installer to simply roll out as many as six equivalent lengths of tubing simultaneously.

Advantages over typical installations include:

- Reduced installation time
- Patent-pending tubing securement method guarantees desired tubing spacing
- Pre-pressurized tubing eliminates downtime
- Pre-engineered design takes the guesswork out of installation
- No balancing needed due to same circuit lengths

Typical applications include:

- Agricultural buildings
- Airports and hangars
- "Big box" retail
- Car dealerships
- Convention centers
- Garages
- Lobbies
- Museums
- Places of worship
- Snow melt
- Turf conditioning (e.g., dairy farms, athletic fields)
- Warehouses
- Office buildings
- Strip malls

While Climate Mat is made to cover large areas, you can still achieve a high degree of climate control in your spaces, since each module can be individually zoned. Individual zoning of mats is not necessary in most applications but may be desirable along perimeters in very cold climates or where there is a large amount of windows. For example, heating capacity of the Climate Mat is typically limited to ~35 Btu/hr•ft<sup>2</sup> in areas intended for human occupancy, but this may be increased to over 50 Btu/hr•ft<sup>2</sup> along the perimeter of a building.

Climate Mat is typically installed to provide floor heating and/or cooling but can also be installed in the ceiling or walls. Complete installation instructions for Climate Mat, including cross-sectional illustrations, layout planning guidance and installation tips, can be found in Appendix F. Appendix F addresses floor applications only; contact Viega if your application requires a ceiling or wall installation.

### 3.5 Commercial radiant heating

See Section 1, Principles of radiant heating design, for basic principles of heating that apply to commercial and residential installations. Considerations for special applications, such as turf conditioning, freezer slabs, hockey rinks, etc, are provided in Table 3-5 of this section.

When working with commercial jobs, there is greater opportunity for increasing system efficiency through supplying heat at lower temperatures. At lower supply temperatures, designers can take advantage of specifying high-efficiency or renewable-energy central heating plants. Options include: ground source heat pumps, solar water heating, waste heat capture and using one or more high-efficiency, modulating boilers. Pairing one or more of these systems with a constant- or variable-speed pump and modulating supply water temperature via a reset control will lead to a very efficient design that also reduces the likelihood of overshooting thermostat set point. (See Section 1.12, Controlling the system, for more information.) To maximize efficiency and comfort in a commercial heating system, specify variable-speed circulators and allow for variable temperature delivery with a reset control.

Application	Use	Target Water Temperature (°F)	Target Surface Temperature (°F)	Heat Rejection	Dehumidification*	Tubing Spacing (inches o.c.)	Comments
Turf Conditioning	Root zone heating; prevent root zone freezing	120 to 130	55 to 80	Climate dependent	NR	6 to 9	
Agricultural	Milk parlor and hot water heat	122 to 140	55 to 80	Waste heat from milk chiller	NR	6 to 18	Heat parlor areas and hot water with waste heat from milk chillers. Standard radiant design.
Hockey Rinks	Space heating with waste heat	90 to 130	60 space temp	Waste heat from chilled brine + compressor heat	R	6 to 9	Standard radiant design for locker rooms; set point control used to maintain surface temperature in seating areas
Greenhouse	Root zone heating	90 to 110	55 canopy temp (24" a.f.f.)	Solar or geothermal heat source	NR	12 to 18	Air temps can be lowered by 15°F
Freezer Slab	Soil frost & freeze protection	50 to 70	>32	Waste heat from refrigeration system (~7 to 10 Btu/ft <sup>2</sup> required)	NR	5	

Table 3-5 Special applications of radiant heating

### 3.6 Commercial radiant cooling

Radiant cooling systems operate by reducing the surface and air temperature within a space, which is referred to as “sensible cooling.” “Latent cooling” occurs when the heat content of air is reduced through condensation of the air’s vapor on a cool surface. To avoid condensation on radiant cooled surfaces, latent cooling should be provided by a supplemental forced-air cooling and/or dehumidification system. The use of radiant surfaces for sensible cooling combined with dedicated outdoor air systems for latent cooling and ventilation has shown great promise for energy savings. In fact, an article in the ASHRAE Journal projected more than 50% savings for a radiant cooled slab and dedicated outdoor air system versus a standard constant air volume cooling system.<sup>17</sup>

#### 3.6.1 Design temperatures

Cooling design temperatures are selected as a function of cooling load, occupant comfort and dewpoint temperature.

*Panel surface temperature:* Lower panel surface temperatures provide higher heat transfer when cooling a space. However, if surface temperatures drop below the space dewpoint, undesired condensation can occur. Another design parameter that limits the low end of the panel surface temperature is concern for occupant comfort. For example, to ensure that comfort levels are acceptable in occupied rooms, it is advisable to maintain floor surface temperature at or above 66°F. This temperature is the lowest temperature that has been shown to achieve a 10% predicted percentage dissatisfied (PPD) among occupants (or acceptable comfort for 90% of occupants), while maximizing heat transfer to the floor. Based on considerations for condensation and occupant comfort, it is advisable to maintain floor temperature above the higher of the dewpoint and 66°F.<sup>18</sup>

	Standard Efficiency CAV DX RTUs	High-Efficiency VAV DX RTUs	Radiant Floor-DOAS: Constant Flow – Variable Supply Temperature (reactive control)	Radiant Floor-DOAS: Variable Flow – Variable Supply Temperature (proactive control)
DX and chiller	189,855	125,866	41,365	32,916
Pumps	–	–	22,728	16,163
Fluid coolers	–	–	121,302	61,810
Fans	247,914	217,964	78,838	73,240
Total HVAC	437,769	343,830	264,233	184,130
Savings over CAV baseline (%)	0%	21%	40%	58%

Table 3-6 Modeled HVAC annual electrical energy consumption, based on an example big box retail store in Sacramento, CA<sup>19</sup>

17. Doebber, I., M. Moore, M. Deru. 2010. “Radiant Slab Cooling for Retail.” ASHRAE Journal 52(12):28-37.

18. In some cases, facilities have successfully specified floor surface temperatures of 64°F while maintaining acceptable levels of occupant comfort.

19. Doebber, I., M. Moore, M. Deru. 2010. “Radiant Slab Cooling for Retail.” ASHRAE Journal 52(12):28-37

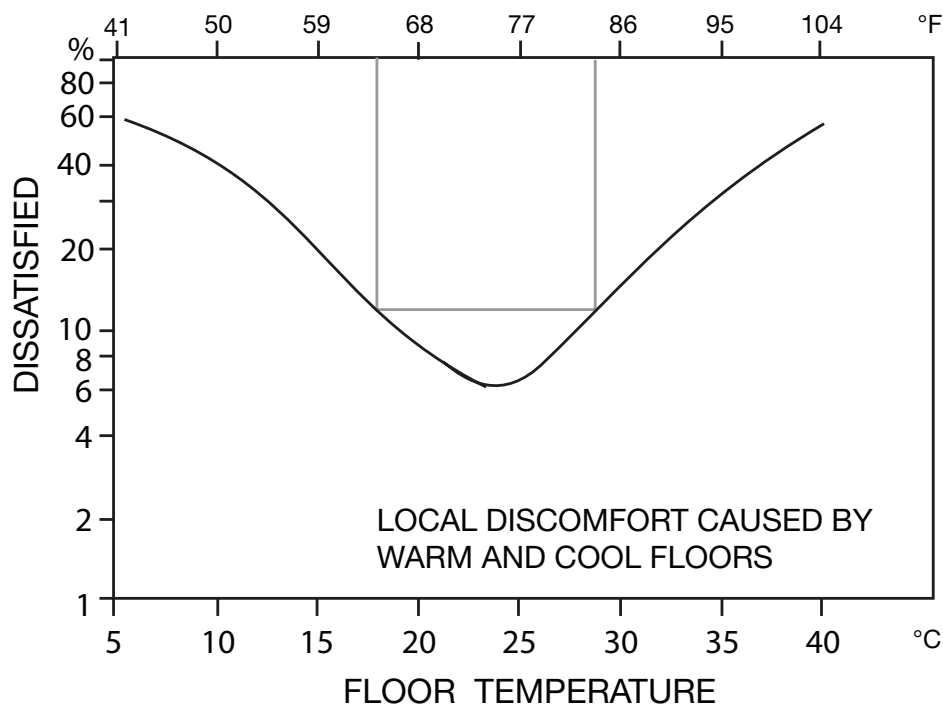


Figure 3-4 Percent persons dissatisfied (PPD) based on floor temperature. Note that a minimum of ~66°F is advisable to achieve 10 PPD<sup>20</sup>

**Dewpoint temperature:** When a surface temperature is below the dewpoint temperature of the surrounding air, condensation is likely to occur on the surface. Generally speaking, as the relative humidity of a space decreases, the dewpoint temperature also decreases. A lower dewpoint means a lower likelihood of condensation. If you know the relative humidity and drybulb temperature of a space, you can determine its dewpoint temperature through referencing a psychrometric calculator or a psychrometric chart.

Dewpoint temperature can be proactively controlled through providing dehumidification to a space, as explained in Section 3.6.3. To avoid condensation, the dewpoint should be controlled to remain lower than the supply temperature to a space.

**Temperature drop:** To support delivery of high supply temperatures, which can provide higher system efficiency, a temperature drop of 5 to 10°F is recommended for commercial cooling.

**Supply temperature:** In radiant cooling, it is advisable to maintain supply temperatures as high as possible while still meeting design load requirements for the space. Supplying higher temperatures to the zone permits increases in the efficiency of the cooling equipment and reduces the risk of condensation when the supply temperature is below the space dewpoint. The trade-offs for supplying higher temperatures are higher flow rates, higher head and potentially tighter spacing requirements for the tubing (e.g., 6" to 9"). Table 3-7 shows required mean cooling water temperatures as a function of floor covering R-value, thickness of concrete above the tubing, tubing spacing and targeted cooling capacity. Mean cooling water temperatures represent the average water temperature in a panel. Supply temperature can be calculated from the mean cooling water temperature using the following equation:

$$T_s = MCWT - \frac{\Delta T}{2}$$

where:

- T<sub>s</sub> = Supply temperature (°F)
- MCWT = Mean cooling water temperature (°F)
- ΔT = Temperature drop across the panel

20. ©ASHRAE BSR/ASHRAE Standard 55P, Thermal Environmental Conditions for Human Occupancy



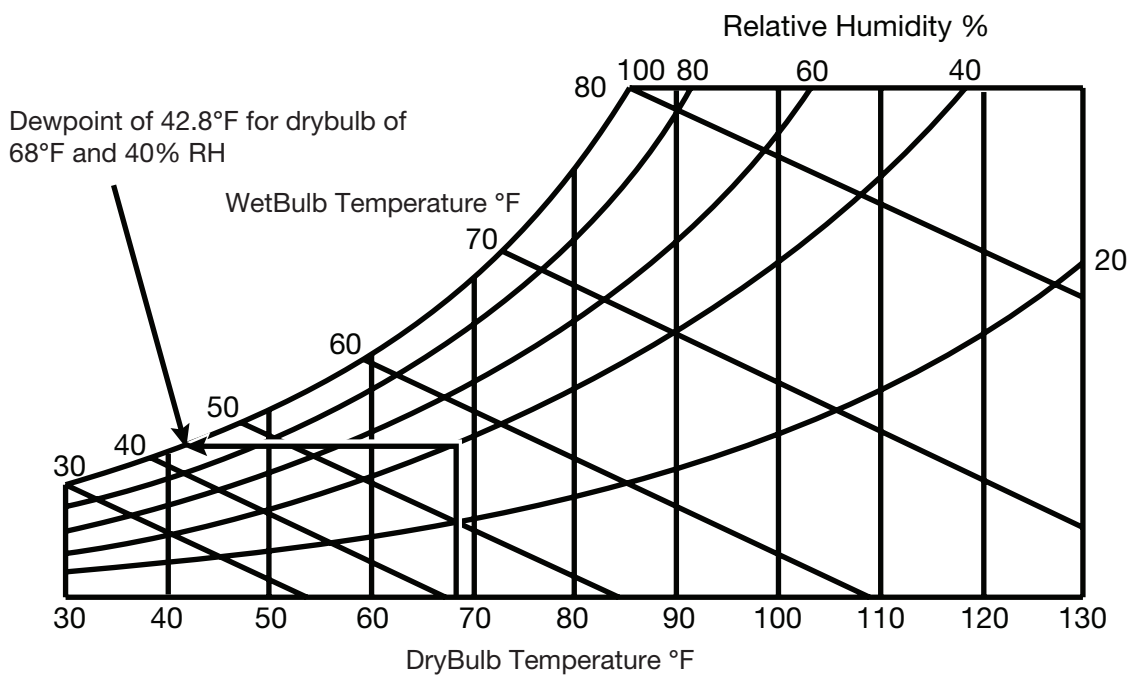


Figure 3-5 Use of a psychrometric chart to determine the dewpoint based on drybulb and relative humidity. To determine the dewpoint, find the drybulb temperature on the horizontal axis and then move up vertically until you reach the corresponding sloping relative humidity line. From this intersection, move horizontally to the left until you reach the end of the chart, where you will read the value of the dewpoint along the line labeled “wetbulb temperature.”

Legend for Table 3-7.

- Not recommended for spaces where the relative humidity exceeds 30% at 78°F drybulb.
- Not recommended for spaces where the relative humidity exceeds 40% at 78°F drybulb.
- Not recommended for spaces where the relative humidity exceeds 50% at 78°F drybulb.

Floor Covering R-Value (hr•ft <sup>2</sup> •°F/Btu)	Depth of Tubing in Concrete (Inches)	Tubing Spacing (Inches)	Cooling Provided (Btu/hr/ft <sup>2</sup> )				
			16	14	11	9	7
			Floor Surface Temperature (°F)				
			64	66	68	70	72
			Required MCWT (°F)				
0	0.75	6	58	61	64	67	69
		9	53	56	60	64	67
		12	47	51	56	60	64
	1.5	6	58	60	64	66	69
		9	54	58	61	65	68
		12	50	54	59	62	66
	3	6	55	58	62	65	68
		9	53	56	60	64	67
		12	50	54	58	62	66
	6	6	48	52	57	61	65
		9	46	51	56	60	64
		12	45	49	55	59	64
0.25	0.75	6	56	59	62	65	68
		9	53	56	60	64	67
		12	49	53	58	62	66
	1.5	6	54	58	61	65	68
		9	52	55	60	63	67
		12	49	53	57	61	65
	3	6	51	55	59	63	66
		9	49	53	58	62	66
		12	47	51	56	60	64
	6	6	44	48	54	59	63
		9	43	47	53	58	63
		12	41	46	52	57	62
Floor Covering R-Value (hr•ft <sup>2</sup> •°F/Btu)	Depth of Tubing in Concrete (Inches)	Tubing Spacing (Inches)	Cooling Provided (Btu/hr/ft <sup>2</sup> ), continued				
			16	14	11	9	7
			Floor Surface Temperature (°F)				
			64	66	68	70	72
			Required MCWT (°F)				
0.5	0.75	6	52	56	60	63	67
		9	50	53	58	62	66
		12	47	51	56	60	64
	1.5	6	50	54	59	62	66
		9	48	52	57	61	65
		12	45	50	55	59	64
	3	6	47	51	56	60	65
		9	45	50	55	59	64
		12	43	48	54	58	63
	6	6	40	45	51	56	61
		9	38	44	50	56	61
		12	37	42	49	55	60

Table 3-7 Required Mean Cooling Water Temperature (MCWT) to achieve target heat transfer as a function of tubing depth, spacing and floor covering R-value. Chart assumes 78°F room drybulb and average interior surface temperature (not counting the floor temperature), indoor conditions and no direct solar gain, 15% heat gain through the bottom of the slab and indoor surface emissivity of 0.9 (standard for most opaque surfaces). Higher cooling capacities are possible with direct solar gain.

### 3.6.2 Capacity

To determine the cooling capacity of a radiant slab for your application, refer to the cooling capacities provided in Table 3-8, which captures both the radiation and convection heat transfer from a surface in typical indoor applications (e.g., room temperature of 79°F and radiant panel surface temperature of 66°F). For operating temperatures other than these, you may calculate the cooling capacity by multiplying the combined radiative and convective heat transfer coefficient by the temperature difference between the room temperature and the radiant panel surface temperature.

Radiant Cooling Panel	Combined Radiative and Convective Heat Transfer Coefficient (Btu/hr/ft <sup>2</sup> /°F)
Floor	1.1
Wall	1.4
Ceiling	1.9

Table 3-8 Combined radiation and convection sensible heat transfer coefficient for radiant cooling applications. The coefficient may increase in the case of direct solar gains. Cooling capacity is based on a radiant panel surface temperature of 66°F and a room temperature of 79°F.

While Table 3-8 can be used to derive a rough estimate of the cooling capacity of a radiant panel, other factors to consider in making a final determination include:

- Surface emissivity: Radiant transfer of heat is reduced by surfaces with a low emissivity coating.
- Skylights: Floor areas that experience direct solar radiation may have a cooling capacity as high as 32 Btu/hr/ft<sup>2</sup>.<sup>21</sup>

Where the sensible cooling load exceeds the cooling capacity of the radiant cooling device, a common practice is to provide supplemental sensible cooling and latent cooling (dehumidification) through secondary systems, which are addressed in the Cooling equipment section.

#### 3.6.2.1 Floor coverings

To maximize cooling potential of radiant surfaces, it is important to minimize the covering R-value. Consider an unfinished or stained slab installation for floor applications, or if a floor covering must be installed, look for hard surfaces with low R-values. R-values of floor coverings over 0.25 are not recommended. Table 3-7 shows the effect of floor covering R-value on cooling capacity.

#### 3.6.2.2 Placement of tubing within the slab

Viega recommends that in-slab tubing be installed anywhere from the bottom of the slab to the midpoint of the slab. If specifying Climate Mat, installation is easiest when done directly over a sub-base (e.g., compacted sub-base, sub slab or subfloor). Installation of tubing within the middle of the slab will provide a slight improvement in cooling capacity but generally has less of an effect on the cooling capacity than selection of floor covering. In all cases, ensure that you have at least ¾" concrete coverage over the tubing for in-slab applications. Table 3-7 shows the effect of tubing depth on cooling capacity.

#### 3.6.3 Cooling equipment

##### Primary and Secondary Sensible

Radiant cooling lends itself to the use of relatively high system water temperatures, which increase options for specifying high-efficiency or renewable-energy equipment such as ground and air source heat pumps, indirect evaporative cooling and solar absorption cooling systems for sensible cooling. Further, air source heat pumps, indirect evaporative coolers and conventional chillers all operate more efficiently when outdoor temperatures are low, so off-peak cooling can be pursued as a strategy to reduce energy use, utility costs and peak load.

Where cooling loads exceed the capacity of radiant cooling surfaces, secondary sensible cooling may be provided by water to air heat exchangers such as VAV or Dedicated Outdoor Air Systems (DOAS). These systems can be used to supply and precondition required ventilation air. Further, if a design is able to decouple the radiant cooling system's cooling plant from the secondary sensible system, the radiant cooling system's cooling

21. Olesen, B.W. 2008. "Radiant floor cooling systems." ASHRAE Journal 50(9):16 – 22.

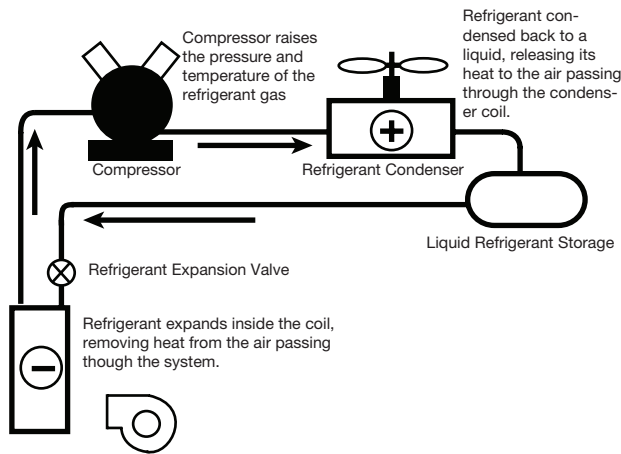
plant may be able to run at a higher efficiency by delivering its chilled water to the radiant panel at a higher supply temperature (i.e., 55 to 60°F) than would be required for a water to air heat exchanger (~45°F). Higher supply temperatures increase a radiant cooling system's efficiency by increasing the effective operating range for water-side economizing and by permitting a higher evaporative temperature for the chiller.<sup>22</sup>

*Latent cooling*

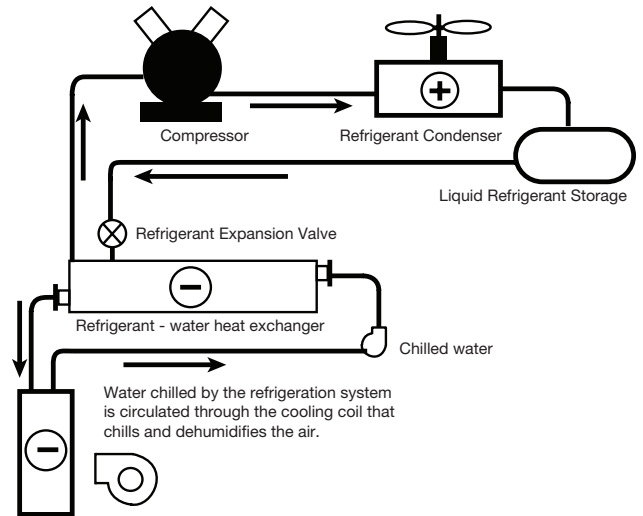
Controlling indoor humidity reduces the chance of undesired condensation on building surfaces, such as floors. Equipment options to satisfy latent loads and simultaneously control the dewpoint of a space include:

- Mechanical systems with refrigerant (direct expansion) or chilled water
- Desiccants - liquid or solid sorption

Mechanical dehumidifiers blow moisture-laden air over coils that contain chilled refrigerant or water at a temperature below the air's dewpoint. The moisture in the air condenses on the coil, resulting in an airstream that has lower moisture content and is at a lower drybulb temperature. If the drybulb temperature of this lower-humidity air is below design conditions, it may be reheated with waste heat from a refrigeration vapor compression cycle.



*Figure 3-6 Dehumidification with refrigerant. Refrigeration systems transfer heat from one airstream to another very efficiently, cooling one and heating the other. This is the basis for most cooling-based dehumidification systems.<sup>23</sup>*



*Figure 3-7 Rotating horizontal desiccant. Evaporating refrigerant can cool liquid rather than air. The liquid is then used to cool air. The design can cool air close to 32°F without freezing the condensate, and has the advantage of equalizing the load on the compressor and condenser when many different air streams must be cooled by a single refrigeration system.<sup>24</sup>*

Desiccants provide dehumidification through liquid or solid sorption. Liquid sorption conditioners use a working solution that is typically composed of lithium chloride or glycol, which has a very high affinity for water vapor. In solid sorption, humid air passes through an “active” desiccant. The lower vapor pressure of the active desiccant results in transfer of vapor from the air to the desiccant. The saturated desiccant is then heated to release the moisture into a separate air stream (the reactivation air) that has a lower vapor pressure than the desiccant.<sup>25</sup> A typical solid-sorption application is a rotating horizontal bed (Figure 3-8).

22. Doebber, I., M. Moore, M. Deru. 2010. “Radiant Slab Cooling for Retail.” ASHRAE Journal 52(12):28-37.  
 23. Harriman III, Lewis G. 1989. The Dehumidification Handbook (Second Edition) p. 24  
 24. Harriman III, Lewis G. 1989. The Dehumidification Handbook (Second Edition) p. 26  
 25. ASHRAE Handbook – HVAC Systems and Equipment. 2008.

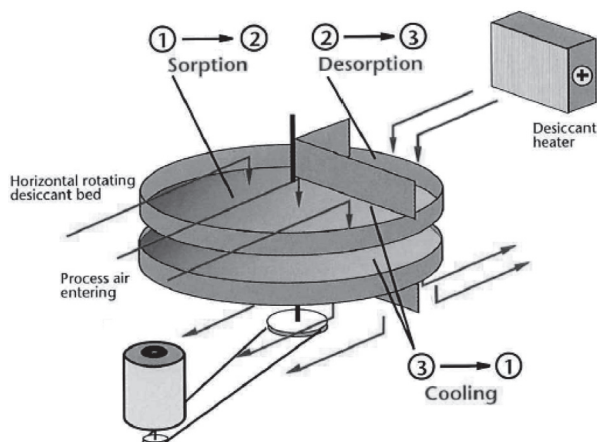


Figure 3-8. Rotating horizontal desiccant bed. Trays containing dry desiccant are slowly rotated between process and reactivation airstreams. Although care must be taken to avoid leakage between moist and dry airstreams, the design is inexpensive to produce.<sup>26</sup>

### 3.6.4 Cooling control strategies

Controls for radiant cooling systems should be specified with the objectives of reducing condensation potential, providing for occupant comfort and optimizing energy efficiency and equipment performance.

Condensation control for a radiant cooled slab is accomplished by controlling the space dewpoint through latent cooling and by ensuring that the slab surface temperature does not fall below the space dewpoint. To do this, exhaust high-humidity loads at their source, provide for dehumidification of air (latent cooling) and precise dewpoint control through supplementary cooling equipment, and install controls to keep the supply water temperature above the space dewpoint temperature by mixing or by bypassing the chiller when necessary.

Various control strategies for a sensible radiant cooling system are listed in Table 3-9.

Control Scenario	Advantages	Disadvantages
Fixed-speed pump, fixed water temp	Simple, reliable	Does not maximize energy efficiency
Variable-speed pump, fixed water temperature	Reduces pumping energy requirements by maintaining a constant system pressure as zones open or close	Does not maximize central plant efficiency
Fixed-speed pumps, variable water temperature	Improves efficiency of central plant by letting it operate over a broader range of temperatures	Does not maximize pumping efficiency
Variable-speed pumps, variable water temperature	Can minimize pumping energy requirements and maximize central plant efficiency	Can have higher first costs than other scenarios

Table 3-9

26 . Harriman III, Lewis G. 1989. The Dehumidification Handbook (Second Edition) p. 36

Control strategies for radiant cooling should also explore the thermal mass benefits of the slab. Opportunities exist for peak-shifting in radiant cooling, which can avoid high electricity charges in areas with time-of-use rates. Pre-cooling a slab in the morning during off-peak hours and then allowing the slab to “coast” through the peak period can not only provide cooling when electricity rates are low but also can take advantage of cooler ambient temperatures, which lead to higher operating efficiencies for cooling equipment. Studies have found that pre-cooling can reduce energy costs by 10-50% when a building operates under time-of-use utility tariffs, with peak demand reductions between 10 and 35%.<sup>27</sup> Under time-of-use tariffs, on-peak electricity costs can be twice that of off-peak electricity costs.

If pursuing a pre-cooling strategy, it is advisable to perform building energy simulations to gauge the dynamic response of the slab, considering comfort, condensation potential, energy performance and time-of-use utility rates. Typical response times are provided in Table 3-10. Controls should be provided to ensure that secondary sensible cooling systems are used to make up the difference between the instantaneous cooling load and radiant slab cooling capacity. Similarly, secondary sensible systems can be used to assist in reducing the overall response time of the primary radiant cooling system after a setback.

Room / Slab Start Temp	75°F	78°F
Slab Thickness	Estimated Time to Cool Down (hours)	Estimated Time to Cool Down (hours)
2"	5	6
4"	8	9
6"	12	15
8"	16	20

Table 3-10. Time required to cool down a slab to 63°F from a slab and space starting temperature of 75 or 78°F. Assumptions include: cooling equipment sized for 15 Btu/hr/ft<sup>2</sup>, distribution, heat gain from sub-slab of 20%, R-0 floor covering, ground temp/mass neglected.

### 3.7 Combination heating and cooling considerations

For systems that will provide both heating and cooling, installation of variable-speed pumps is recommended to facilitate matching design flow rates and loads. Sizing of equipment and components should accommodate the largest design load, whether heating or cooling. Insulation should be installed based on the requirements in heating mode.

Primary piping for heating and cooling systems may be either two pipe or four pipe. Two-pipe systems have one primary supply and one primary return for both the cooling plant and heating

plant. Switching between the heating plant and the cooling plant is accomplished by a two-position changeover valve (Figure 3-9). Four-pipe systems have separate supply and return primary piping for both the heating plant and the cooling plant. Shared piping between the cooling plant and heating plant in a four-pipe system may be controlled by three-way diverting valves (Figure 3-10).

A properly designed radiant heating and cooling system can offer excellent performance, comfort and energy efficiency in each season of the year and across a wide range of indoor and outdoor conditions.

27. ASHRAE. 2008. Handbook – HVAC Systems and Equipment. 50.14.

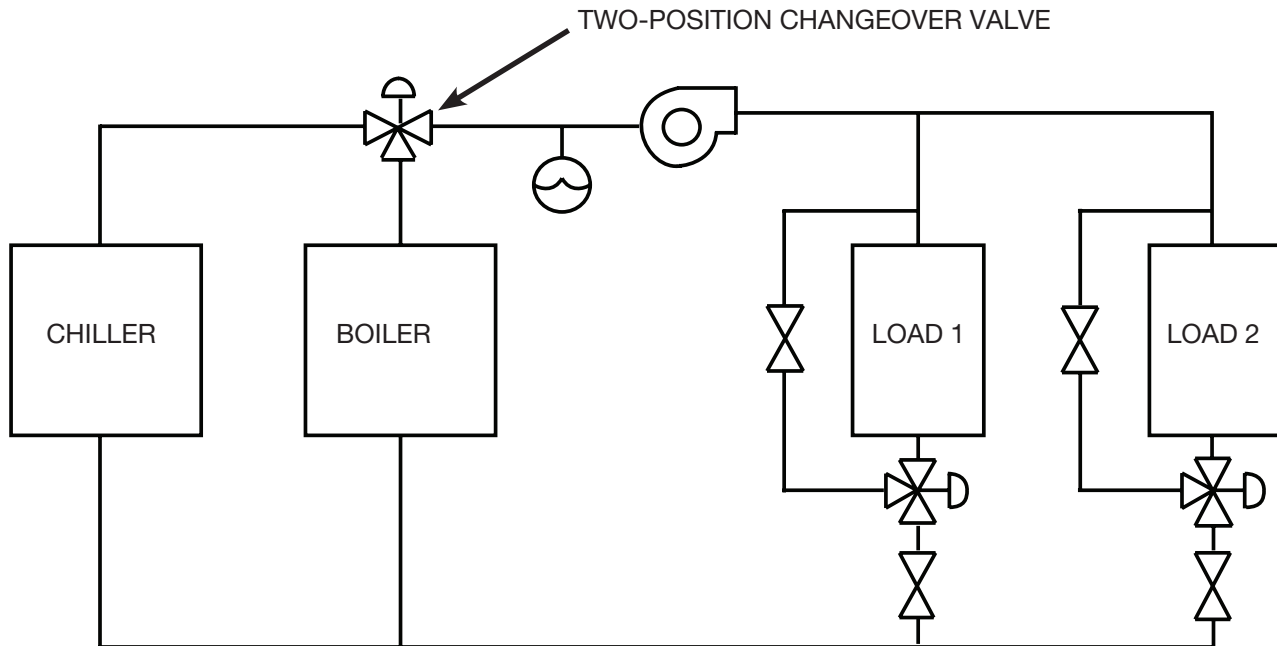


Figure 3-9 Conceptual diagram of a two-pipe system<sup>28</sup>

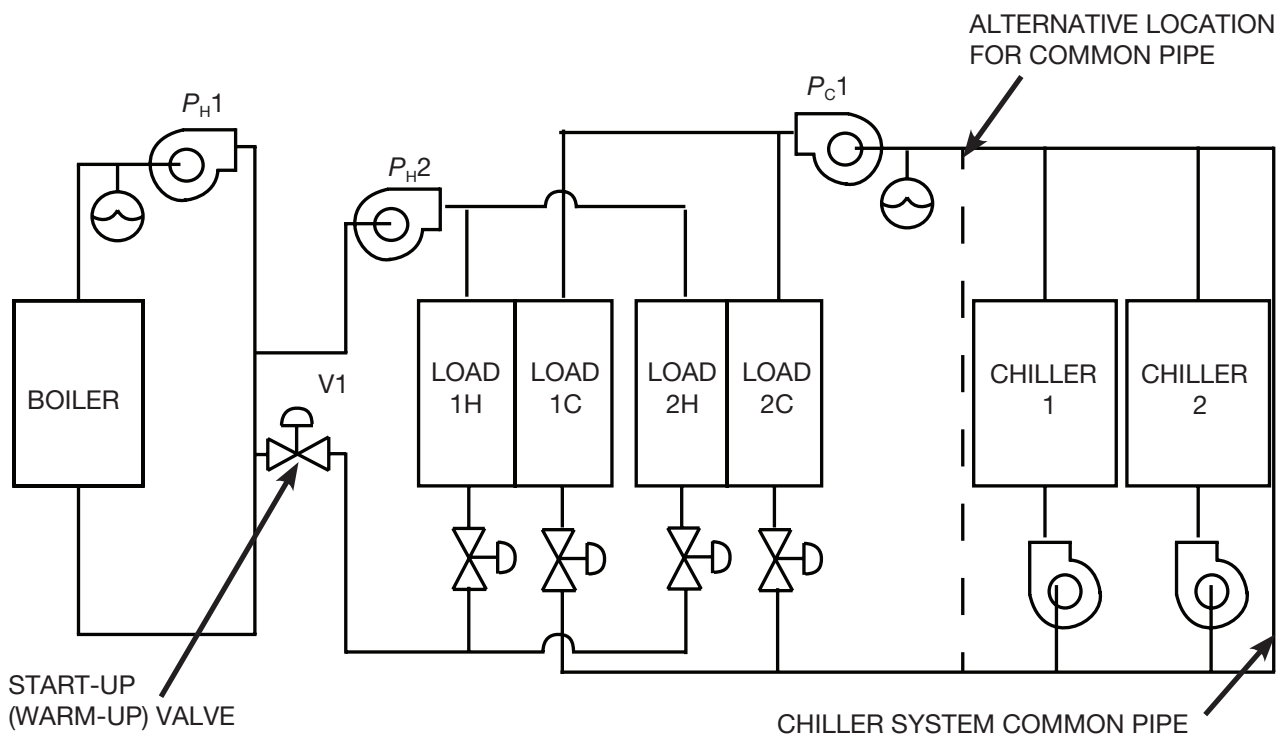


Figure 3-10 Conceptual diagram of a four-pipe<sup>29</sup>

28. ASHRAE. 2008. Handbook – HVAC Systems and Equipment. 12.19.

29. ASHRAE. 2008. Handbook – HVAC Systems and Equipment. 12.20.

## 4 Installation and Startup

A good design must be accompanied by thoughtful installation practices and proper startup procedures to ensure that the radiant system performs as specified.

### 4.1 Installation

General installation instructions are provided in this section, while specific installation instructions for applications like Snap Panel, Climate Mat, Climate Panel and Climate Trak are located in Appendices

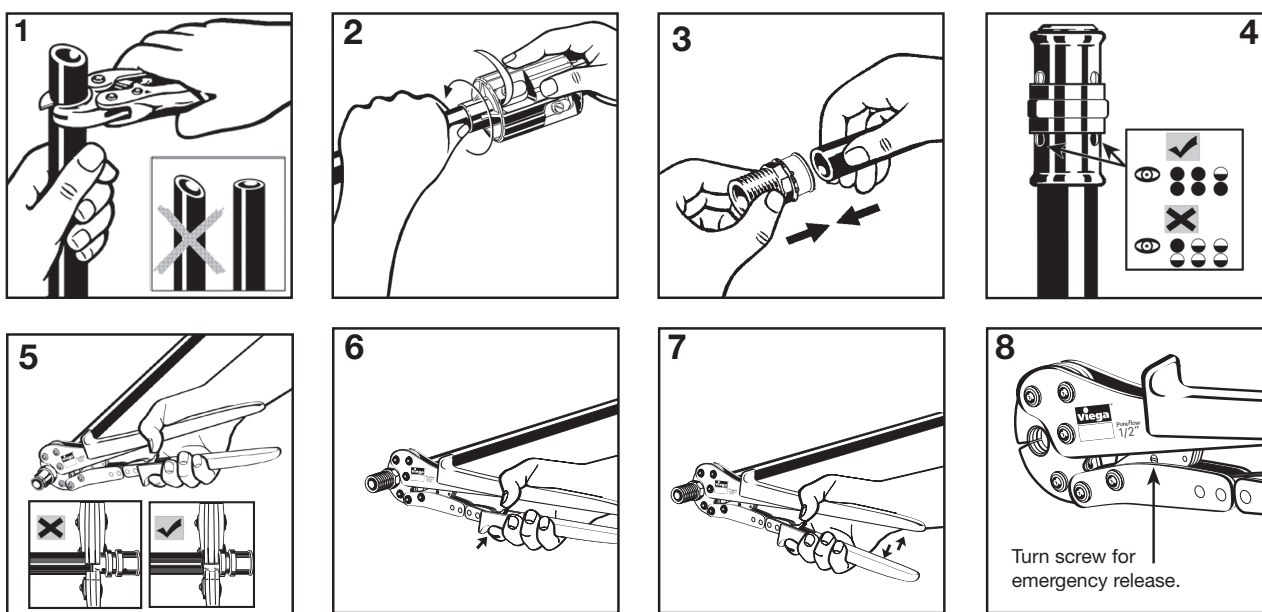
A-D. General installation instructions address the following topics:

- Connecting tubing
- Handling and protecting tubing
- Layout and fastening

#### 4.1.1 Connecting tubing

ViegaPEX Barrier tubing can be connected using a press or compression connection, while FostaPEX must use a press connection.

Follow these steps to perform a press connection with ViegaPEX Barrier or FostaPEX.

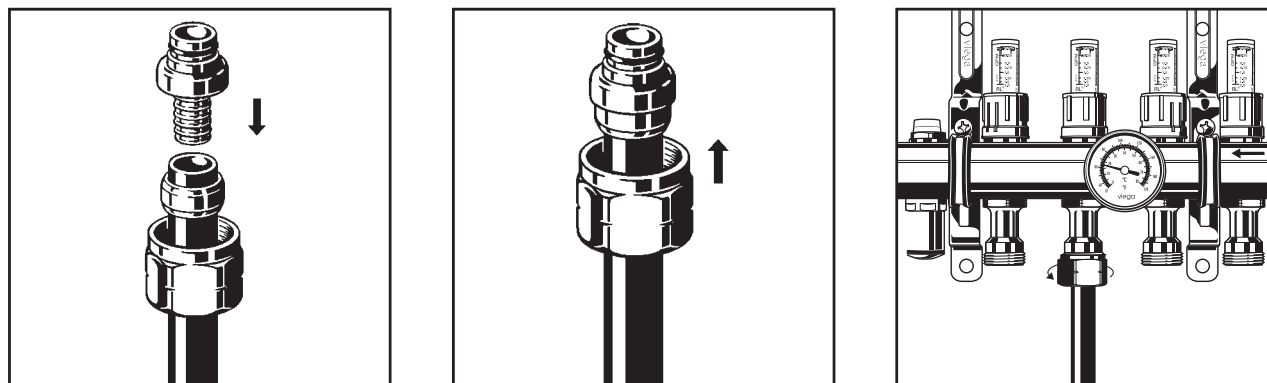


1. Square off tubing to proper length. Uneven, jagged or irregular cuts will produce unsatisfactory connections.
2. If using FostaPEX tubing, insert into prep tool, push and turn until no resistance is felt. If using ViegaPEX, continue to Step 3.
3. Insert PEX press fitting with attached sleeve into tubing and engage fully.
4. Ensure full tubing insertion at view holes in attached press sleeve. Full insertion means tubing must be completely visible in at least two view holes and partially visible in the one.
5. Position press tool perpendicular over press sleeve, resting it against the tool locator ring.  
Note: The tool locator ring must be in the factory-installed position while making a press to provide a consistent leakproof connection. It may be necessary to rotate the tool locator ring to avoid interference between the ring and tool.
6. Close handles, using trigger to reduce grip span if desired.
7. Extend handle and continue ratcheting until automatic tool release occurs at proper compression force.
8. **Warning:** The connection is not leakproof when the tool has been opened by emergency release. The tool locator ring must be present to ensure a proper PEX press connection.

Figure 4-1



For compression connections with ViegaPEX Barrier, follow these steps. Note that FostaPEX cannot be used when making compression connections.



1. Square off tubing to proper length. Slide compression nut up tubing and clip brass ferrule over tubing.

2. Slide tubing over end of SVC adapter, pushing it on fully until tubing is flush with shoulder of fitting.

3. Insert SVC adapter into the seat of the manifold and tighten the compression nut with a wrench. Retighten nut slightly after 30 minutes.

Figure 4.2 SVC Compression Fittings  $\frac{5}{16}$ " to  $\frac{3}{4}$ "

#### 4.1.2 Handling and protecting tubing

- Use tubing cutters for even, square cuts. Use a ratcheting cutter for FostaPEX.
- If a bronze PEX press coupling will be installed and encased in a thermal mass, it must be completely covered with Viega's coupling repair tape.
- Cover tubing with a protection sleeve when it is close to sharp objects.
- Protect tubing with proper guards where nailing is likely.
- Use bend supports in concrete. A bend support will help reduce possible damage to the tubing due to the different expansion and contraction rates of different materials.
- Minimize penetration of expansion joints in concrete (Figure 4-1). Any tubing that passes through concrete expansion joints must be protected with a protection sleeve for a minimum of 6" (15cm) on both sides of the joint. Cross-sections of sleeving at expansion joints are provided in Figure 4-3 and Figure 4-4.

##### 4.1.2.1 Slab joint tube protection

(CSA B214, Clause 17.4.4.2)

The tubing at the location of a control, expansion or construction joint in a concrete slab shall be protected by

- (a) a rigid sleeving material that covers the tubing for at least 300 mm (12 in) on either side of the joint;
- or

- (b) dipping the tubing below the slab.

Tubing installed below control joints in concrete slabs shall be secured at points 150 mm (5 in) on each side of the control joint.<sup>30</sup>

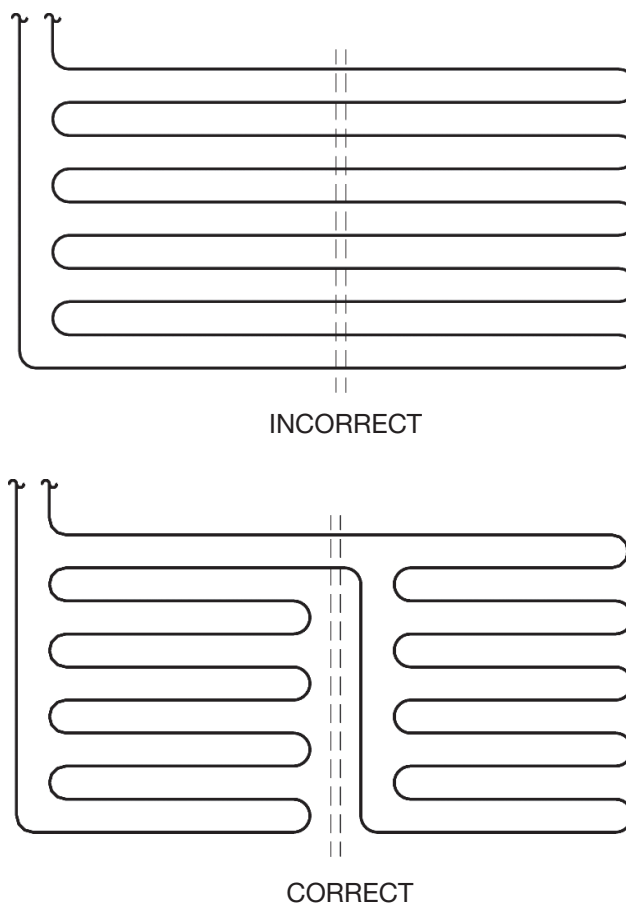


Figure 4-3 Minimize penetration of expansion joints

30. ©CSA Group, B214-12. 2012. "Installation Code for Hydronic Heating Systems" Clause 17.4.4.2

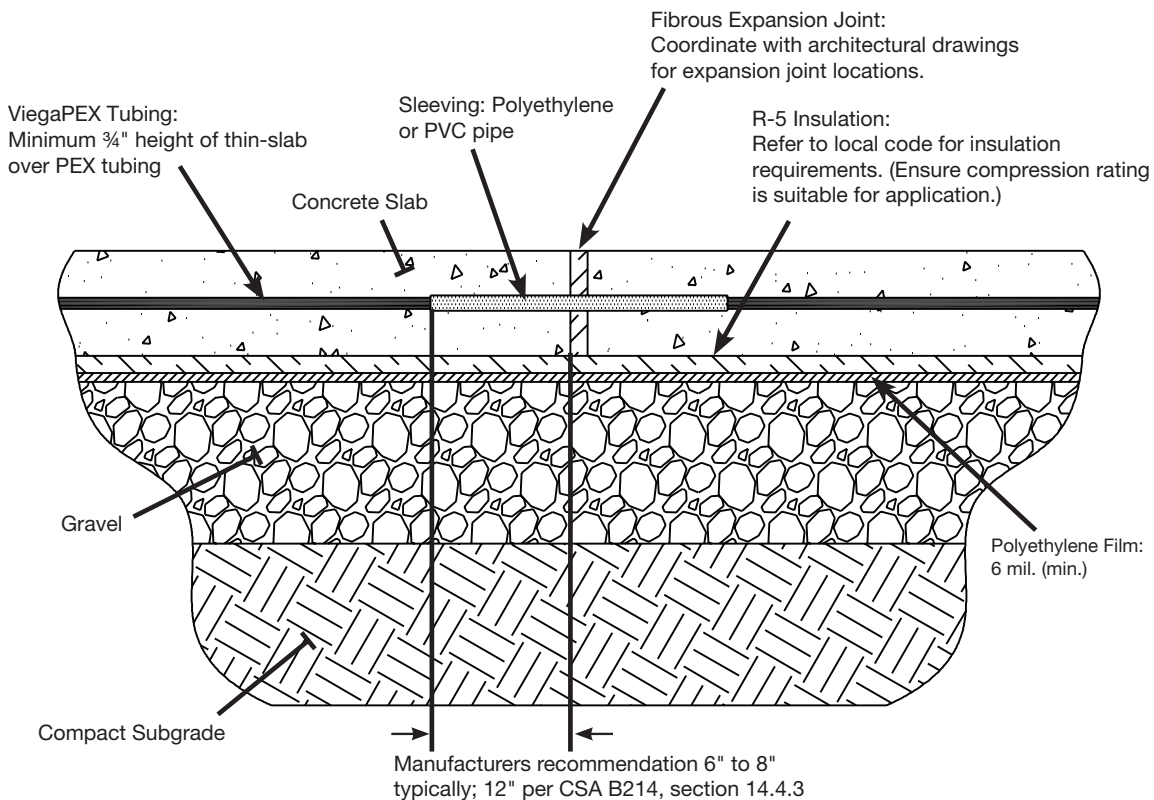


Figure 4-4a Section through fibrous expansion joint

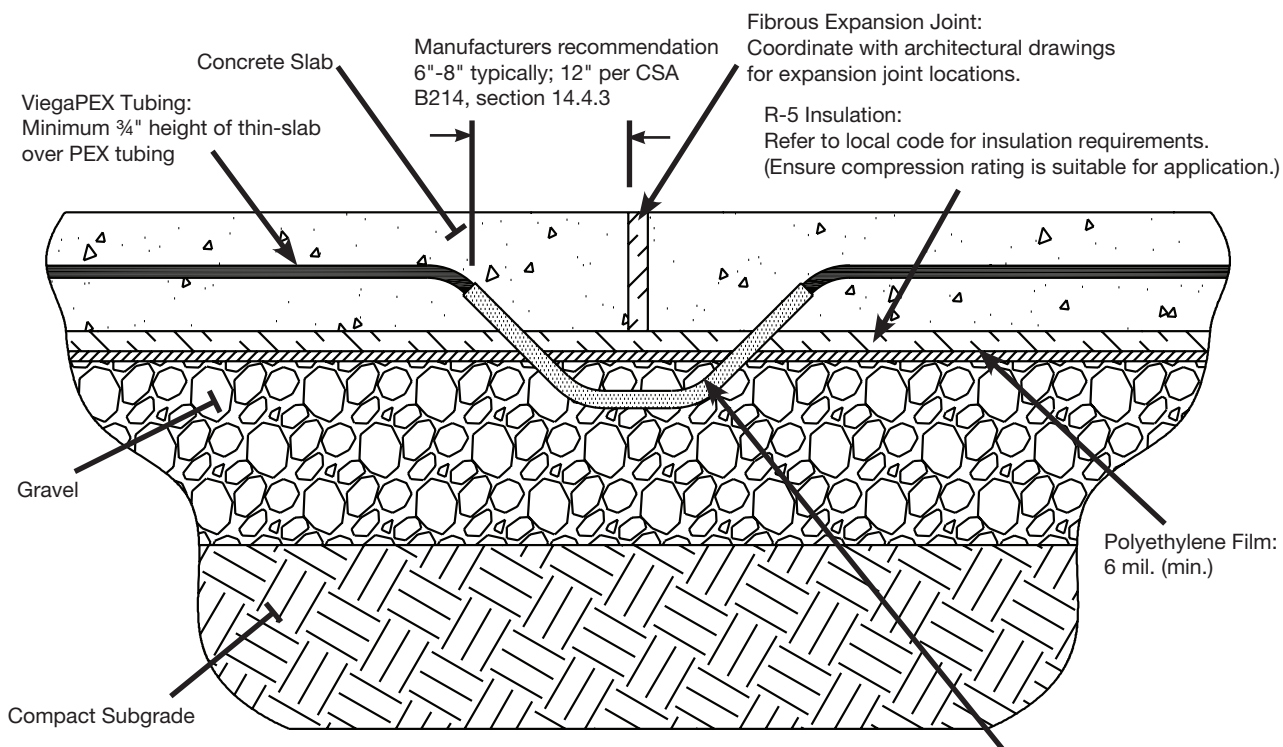


Figure 4-4b Section through metal expansion joint

Sleeve: Polyethylene or PVC pipe

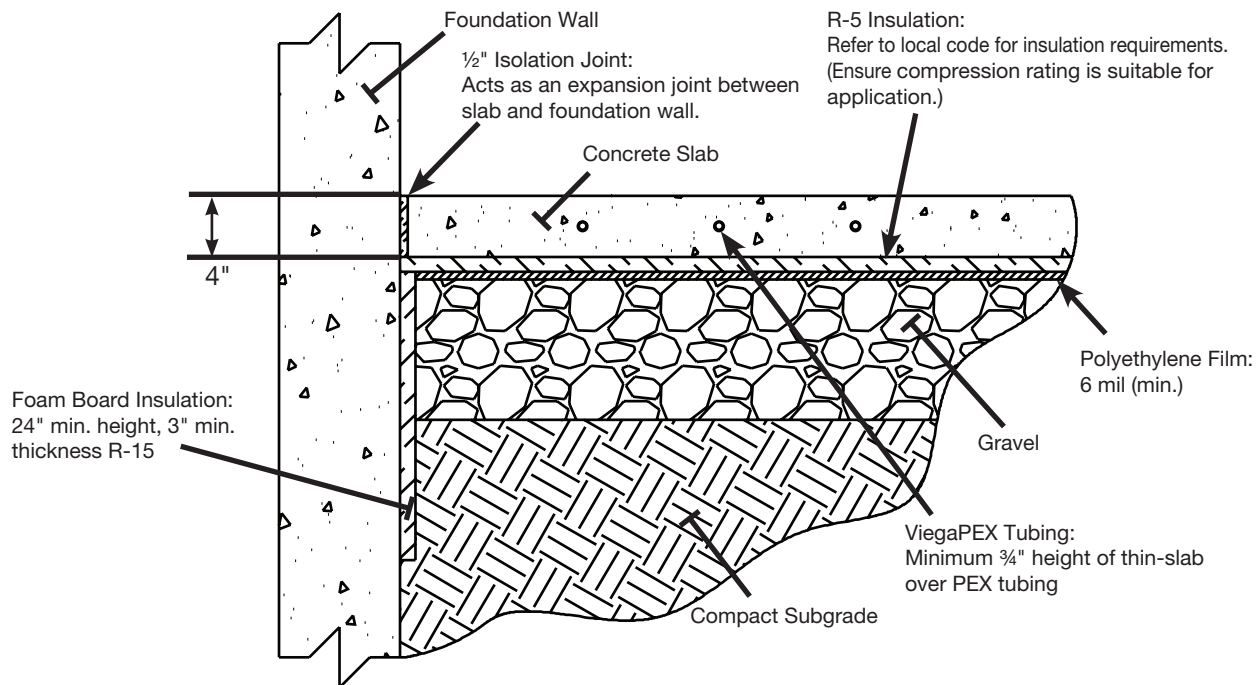


Figure 4-5 Foam board insulation serves as an expansion joint at the intersection of the slab and concrete foundation, preventing the slab from bonding to the foundation walls

### 4.1.3 Layout and fastening

Following these simple layout tips will improve the performance of your system.

- Run supply tubing into high heat loss areas first (e.g., closest to exterior walls, windows, sliders, etc.) and then into the interior of the room. The higher water temperatures at the outside wall will provide higher Btu output where it is needed.
- Keep tubing at least 4" (10 cm) from the edge of slabs, walls or other permanent objects.
- Avoid tubing in areas where food will be stored.
- Label tubing and record actual circuit lengths as it is installed.
- If there are areas with high pipe concentrations, insulate pipes if the thickness of the thermal mass can accommodate the buildup.
- The manifold should be securely mounted and should remain accessible. Viega recommends that power heads be mounted above the manifold, in an upright position.
- Slab-specific
  - Final grade should be accurately leveled and covered with a polyethylene film (6 mil. minimum).

- Chairs/bricks may be used to raise the wire mesh and tubing to the midpoint of the slab.
- The return bend can have a key hole shape to minimize the tubing spacing without kinking the tubing.
- Fasten tubing every two feet and three times at each U-turn to hold down any return bends or other shapes created.
- Do not cross tubing in a slab.

### 4.2 Startup

See Appendices A-D for materials sheets and detailed installation instructions for Climate Panel, In-Slab, Climate Trak and Climate Mat installation systems. Once the systems are installed, follow these steps for a successful startup:

1. Perform pressure test on ViegaPEX Barrier or FostaPEX tubing. Ensure that no leaks are present. Repair if necessary and retest.
2. Disconnect any temporary manifold(s) then mount new permanent manifold(s) and connect tubing. Ensure that the supplies and returns are connected to the corresponding manifold ports. Label circuits if they are serving different locations within the building.
3. Connect boiler supply and return piping to manifolds as well as installing any additional

- components (mixing devices, purge assembly, isolation valves, circulators, etc.).
4. Prior to purging secondary piping, manifolds and circuits, ensure that the boiler and associated primary piping have been purged of all air.
  5. Purge stations, manifolds and circuits according to manufacturers' instructions. Refer to PI (product information) sheets for hydronic mixing block, ProBloc and mixing stations.
  6. Ensure that all electronic components have been wired as per manufacturers' instructions. Refer to PI sheets for controls, etc.
  7. Utilize controls to activate system circulator(s) and relevant heating/cooling source(s). Ensure that heating supply temperature increases and that piping is not reversed.
  8. Run heating source (e.g., boiler) up to its maximum supply temperature to ensure proper function of internal temperature controls.
  9. Set mixing devices according to manufacturers' instructions. Refer to PI sheets for hydronic mixing block, ProBloc and mixing stations.
  10. Check that the controls are working properly. Refer to manufacturers' control instructions for more information (including but not limited to reset controls, thermostats, powerheads, zone controls, etc.).
  11. Ensure proper balancing of all circuits according to completed design calculations. Refer to PI sheets for instructions.

General information on these individual steps is provided in the following sections. For product-specific information, consult manufacturers' instructions (e.g., Viega PI sheets).

#### 4.2.1 Pressure testing and purging

Pressure testing and purging methods are similar across residential and commercial systems. Before the finish floor is installed in panel installations, and before and during the slab pour for in-slab installations, the radiant system must be pressure tested.

#### Pressure Testing

When conducting pressure testing, air or water may be used as the medium. To simplify leak detection if tubing is damaged, pressure should be maintained during concrete pour for in-slab systems and during the installation of any covering, such as flooring, gypsum wall board, pavers, etc, across all systems. The following pressure testing procedure is recommended by Viega. Check the local building codes for compliance or additional test requirements.

1. Double-check all connections to manifold to ensure proper seal.
2. Connect manifold pressurization kit (1) to any drain valve (2).
3. Pressurize the system to 100 psi to detect potential nail or screw penetrations.
4. The system should hold the 100 psi for a minimum of 1 hour prior to the installation of the tubing covering or slab. Note that the gauge will fluctuate to some extent with temperature change, with lower pressures expected as temperatures decrease.
  - a. For in-slab applications, retighten any tubing couplings located in the slab area after at least 12 hours of system pressurization. Maintain and monitor pressure until concrete has adequately cured.
  - b. For dry systems, the pressure test must be continued during installation up until the time that the system is put into operation.

**NOTE:** If the tubing becomes damaged during the installation, remove the damaged section of tubing and replace with repair coupling(s). After making an in-slab repair, be sure to protect the fitting(s) with repair coupling wrap prior to concealing the connection. See Appendix B.

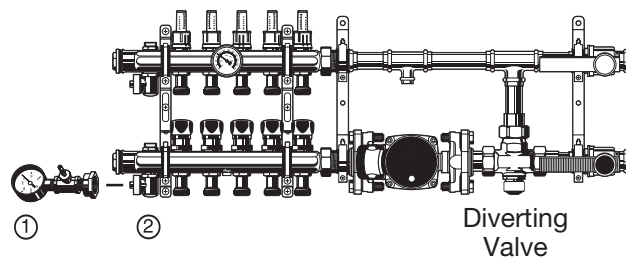


Figure 4-6 Mixing Station with manifold pressurization kit (1) and drain valve (2)

### Purging

Once tubing is filled with water, it must be protected from freezing. This can be done by waiting to purge and fill the tubing until the building is ready to be conditioned, or by using a glycol mixture within the tubing. Glycol mixtures may also be needed in systems that are not used year-round that may be exposed to freezing temperatures. Use of a glycol solution will impact the heat transfer capability of the fluid, so ensure that the design has accounted for this. See Section 5.13.1, Pressure testing, filling and purging, for more information on filling and purging a glycol solution.

The purging procedure varies based on availability of water. Assuming that water for filling and purging is provided by the primary piping makeup water system:

1. Remove the high-limit from any mixing valve. The high-limit can be reinstalled and reset after the purge is complete. For instructions on setting the high-limit, see Section 4.2.3.
2. With manifold connected, close all manifold circuit valves.
3. Close isolation ball valve on the return header.
4. Attach a drain hose to the return header drain valve.
5. Open circuit shutoff valves on supply and return headers for first circuit to purge and fill this circuit.
6. Once purge and fill for first circuit is complete, close circuit shutoff valves on supply and return headers.
7. Repeat steps 4 and 5 for each additional circuit, one at a time.
8. Once last circuit is purged and filled, close last circuit shutoff valve.
9. Open all circuit shutoff valves on supply and return headers.
10. Close drain valve.

Where water for filling and purging is not provided from primary piping:

1. Remove the high-limit from any mixing valve. The high-limit can be reinstalled and reset after the purge is complete. For instructions on setting the high-limit, see Section 4.2.3.
2. Close isolation ball valves on supply and return headers.
3. Connect fill hose/purge water source to drain valve on supply header.
4. Attach a drain hose to the return header drain valve.
5. Open drain valve on supply header to start water flow into supply header.
6. Steps 5 through 10 are the same as if water fill is from primary system.

**NOTE:** If the system must be purged again in the future for any reason, the high-limit must be reopened during purging for full flow.

### 4.2.2 Initial balancing

Many times it is not possible to design the system using equal circuit lengths, so the system must be balanced in order to ensure adequate flow to each circuit on a manifold. The exception to this is the Climate Mat, which is designed with circuits of equal lengths. For all other applications, refer to your design for detailed balancing flow rates.

Procedure:

1. Start with all valves wide open.
2. To decrease flow, turn the balancing valve clockwise in small increments.
3. Balancing is complete when design flow rates are achieved.

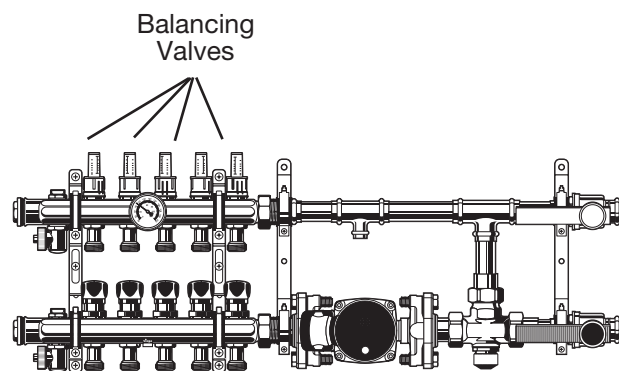


Figure 4-7 Locating balancing valves

### 4.2.3 Adjusting the high-limit

Limits should be set on the maximum supply water temperature to circuits based on design requirements. The Mixing Station is provided with a preinstalled temperature high-limit. This high-limit is installed into the 3-way valve to allow a maximum supply water temperature to be set. This high-limit must be unscrewed when purging the system and should then be set according to the instructions below.

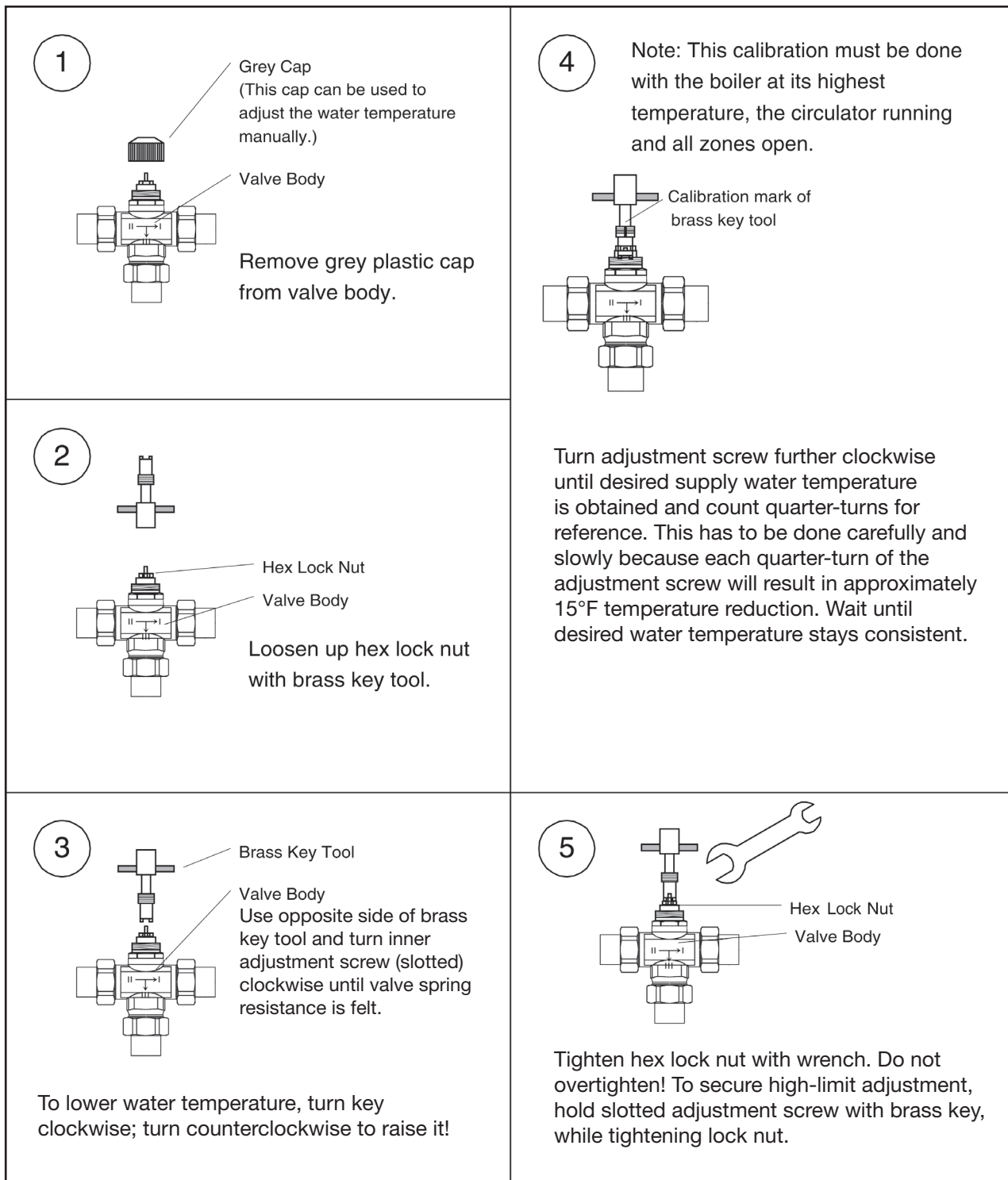


Figure 4-8 Adjusting the high-limit

#### 4.2.4 Considerations for slabs

##### *Warming Up the Slab*

When starting up an in-slab system in heating mode for the first time, it is best to warm the thermal mass up slowly to help prevent possible shock to the slab. In accordance with DIN 4725 section 4, Viega recommends:

- Start warmup after concrete has reached its final set (curing complete).
- Set supply water temperature to 77°F for the first three days.
- Increase supply water temperature to the set point in gradual increments for the next four days (maximum of a 50°F increase in a period of 24 hours).
- Slab warmup should follow the concrete manufacturer's recommendations.

##### *Testing for excessive moisture*

Prior to installing a floor covering on a radiant-heated slab, ensure that the slab has cured sufficiently. One easy way to confirm this is through a polyethylene film test:

Tape a one-foot square of 6 mil clear polyethylene film to slab, sealing all edges with plastic moisture-resistant tape. If, after 48 hours, there is no "clouding" or drops of moisture on the underside of the film, the slab can be considered dry enough for finish floor applications. Drying times vary considerably with location, season, interior temperature/humidity, etc. Follow the finish flooring manufacturer's recommendations.

#### 4.2.5 System documentation and operational instructions

(CSA B214, Clause 4.6.2)

The installer shall ensure that the system documentation and manufacturer's operational instructions are left near the primary heating equipment or, if that is not practical, near the main electrical distribution panel, in order for service and maintenance personnel to have access to the documentation and instructions.

##### **NOTES:**

- (1) Examples of information that should be provided in the documentation of the system for hydronic space heating include
  - (a) a room-by-room heat loss calculation in kW (Btu/h);
  - (b) the heat output of the heat-distribution unit in kW (Btu/h);
  - (c) the system design water temperatures in °C (°F);
  - (d) the pipe size in mm (nominal size NPS, in) and total length of piping in m (ft); and
  - (e) the system head loss and flow rates in kPa and L/s (psi and gpm).
- (2) Examples of information that should be provided in the documentation of the system for radiant heating include
  - (a) a room-by-room heat loss calculation in kW (Btu/h);
  - (b) the floor area in m<sup>2</sup> (ft<sup>2</sup>);
  - (c) the total usable panel area in m<sup>2</sup> (ft<sup>2</sup>);
  - (d) the heat output density in W/m<sup>2</sup> ((Btu/h)/ft<sup>2</sup>) of panel area;
  - (e) the radiant heating panel supply water temperature in °C (°F);
  - (f) the pipe size in mm (nominal size NPS, in), maximum spacing between the lengths of piping in mm (in), and total length of piping in m (ft);
  - (g) the minimum number of heating loops;
  - (h) the boiler supply water temperature in °C (°F);
  - (i) the auxiliary heat required in kW (Btu/h);
  - (j) the RSI value in m<sup>2</sup>K/W (R-value) of the floor coverings;
  - (k) the RSI value m<sup>2</sup>.K/W (R-value) of the insulation under and at the edges of the radiant panel;
  - (l) the outdoor design temperature in °C (°F);
  - (m) the floor surface temperatures in °C (°F); and
  - (n) the system friction loss and flow rate in kPa and L/s (psi and gpm).
- (3) Additional information for documentation of the system is presented in Figures A.1 and A.2.
- (4) Attempts should be made to instruct the user in the safe and correct operation of the system.<sup>31</sup>

31. ©CSA Group, B214-12. 2012. "Installation Code for Hydronic Heating Systems" Clause 4.6.2

Radiant snow melting can be desirable for residential, commercial and industrial applications. Benefits of snow melting include:

- Safety (insurance)
- Solves snow removal problems in critical areas (stairs, slopes, intersections, ramps, pavers)
- Reduced maintenance
- Prevents salt and other chemicals from entering the building
- Extends slab life
- May utilize wasted energy

**Residential:**

Snow melting in residential applications has gained widespread acceptance. A snow melting system can alleviate shoveling, plowing, sanding and salting. Typical application areas are driveways, walkways, patios and steps.



**Commercial:**

Snow melting in commercial applications reduces liability and improves accessibility. Clean sidewalks will attract customers and provide safety. Excellent choice under pavers (chemical melt aids, plowing, shoveling are difficult due to joints). Typical application areas are building entrances, parking ramps and lots.



**Industrial:**

Snow melting in industrial applications is used where safe, clean and easy access is critical. Typical application areas are hospital emergency entrances, helipads, loading docks and building entrances.



## 5.1 Selecting the design criteria level

The design criteria level should be selected based on the effectiveness that is expected from the customer. Higher levels provide higher performance, at the expense of higher first costs and operational costs. The expected performance at various levels is tied to confidence level and the snow-free area ratio.

- Snow-Free Area Ratio ( $A_r$ ) – The ratio of the surface area where no accumulation takes place during snowfall vs. the total area of the surface. For example, if there is a 1,000-ft<sup>2</sup> driveway that has approximately 500 ft<sup>2</sup> of area with no accumulation, the ratio would be calculated as follows:

$$A_r = \frac{\text{Snow free area}}{\text{Total surface area}} = \frac{500}{1,000} = 0.5$$

- Confidence Level – The percent of the hours of snowfall during a typical year that the snow-free area ratio is maintained.



Define customer's intention and expectation of the snow melting system to select the correct design criteria level.



**Levels:**

- Level 1 Residential
- Level 2 Residential/Commercial
- Level 3 Industrial/Critical

**Level 1**

- Area-free ratio 0 to 0.5
- Confidence level ~95%

Common applications

- Residential applications
- Driveways
- Sidewalks
- Hot tub areas



**Level 2**

- Area-free ratio 0.5 to 1
- Confidence level ~98%

Common applications:

- Commercial and light commercial apps.
- Public access areas to buildings
- Handicapped ramps
- Commercial stairways



**Level 3**

- Area-free ratio=1
- Confidence level ~98% to 99%

Common applications:

- Critical applications
- Hospital emergency ramps
- Access areas for emergency vehicles (fire stations, etc.)
- Areas deemed critical for public safety

## 5.2 Calculating the snow melting load

The methodology Viega recommends to calculate the snow melting load is based on that described in the 2008 ASHRAE Handbook – Systems and Equipment. Use Table 5-1 to find the heat flux output requirement in Btu/hr/ft<sup>2</sup>. The heat flux output requirement given in Table 5-1 values does not include back and edge heat losses, which must be accounted for separately to get the final heat output requirement (refer to Table 5-2 for back and edge loss multipliers).

Procedure:

1. Find the location of the snow melting system in the first column.
2. Determine the snow-free area ratio required.
3. Follow to the right and read the snow melting load under the column representing the appropriate confidence level.

Example:

Find the snow melting load for a Level 2 system in Boston, MA, with an area-free ratio of 1 and a 98% confidence level.

By referencing Table 5-1, determine that a 98% confidence level system with a snow-free area ratio of 1 in Boston will provide need to supply 202 Btu/hr/ft<sup>2</sup>, not including back and edge losses. A system with this area-free ratio and confidence level is expected to perform as follows in Boston:

- 100% of the surface area will be snow free 98% of the time snow is falling
- In a typical year in Boston, there are 112 snowfall hours, meaning that 100% of the surface area will be snow free for 109.8 hours of snowfall ( $98\% \times 112 = 109.8$  hours)

Of that remaining 2% of the snowfall hours, or approximately 2.2 hours:

- 1% of the snowfall time (that time between the 98% and 99% non-exceedance values given in Table 5-1), snow will accumulate on the slab to a thickness at which the snow blanket insulates the slab, but the thickness will not increase beyond that level. Snow melts on the underside of the blanket at the same rate at which the snow is falling: 1.1 hours of snowfall ( $1\% \times 112 = 1.1$  hours)
- For the last 1% of the snowfall time (that time between the 99% and 100% non-exceedance values given in Table 5-1), the system cannot keep up with the snowfall, and buildup may occur: 1.1 hours ( $1\% \times 112 = 1.1$  hours)

Location	Snowfall Hours per Year	Snow-Free Area Ratio $A_r$	Heat Fluxes Not Exceeded During Indicated Percentage of Snowfall Hours from 1982 through 1993, Btu/h-ft <sup>2</sup> <sup>D</sup>					
			75%	90%	95%	98%	99%	100%
Albany, NY	156	1	89	125	149	187	212	321
		0.5	60	86	110	138	170	276
		0	37	62	83	119	146	276
Albuquerque, NM	44	1	70	118	168	191	242	393
		0.5	51	81	96	117	156	229
		0	30	46	61	89	92	194
Amarillo, TX	64	1	113	150	168	212	228	318
		0.5	71	88	108	124	142	305
		0	24	46	62	89	115	292
Billings, MT	225	1	112	164	187	212	237	340
		0.5	64	89	102	116	128	179
		0	22	33	45	60	68	113
Bismarck, ND	158	1	151	199	231	275	307	477
		0.5	83	107	124	148	165	243
		0	16	30	39	60	73	180
Boise, ID	85	1	58	79	100	126	146	203
		0.5	38	52	66	80	89	164
		0	22	31	40	53	62	164
Boston, MA	112	1	96	137	165	202	229	365
		0.5	65	95	112	149	190	365
		0	37	75	93	121	172	365
Buffalo, NY	292	1	115	166	210	277	330	570
		0.5	68	97	127	164	188	389
		0	23	39	55	93	112	248
Burlington, VT	204	1	91	130	154	184	200	343
		0.5	58	78	92	113	128	343
		0	23	40	55	78	94	343
Cheyenne, WY	224	1	119	172	201	229	261	354
		0.5	70	97	111	132	149	288
		0	16	37	52	77	100	285
Chicago, IL, O'Hare International Airport	124	1	96	126	153	186	235	521
		0.5	58	77	94	113	137	265
		0	23	38	53	75	83	150
Cleveland, OH	188	1	85	124	157	195	230	432
		0.5	52	73	92	118	147	235
		0	23	37	47	69	92	225
Colorado Springs, CO	159	1	89	135	167	202	219	327
		0.5	57	82	99	124	140	218
		0	23	45	61	87	112	165
Columbus, OH, International Airport	92	1	71	101	123	149	175	328
		0.5	45	60	71	87	95	184
		0	15	30	45	60	62	135
Des Moines, IA	127	1	120	174	208	255	289	414
		0.5	74	102	120	149	180	310
		0	24	46	69	94	108	231
Detroit, MI, Metro Airport	153	1	92	130	156	192	212	360
		0.5	57	77	94	118	134	227
		0	23	38	47	75	89	194
Duluth, MN	238	1	123	171	201	238	250	370
		0.5	71	97	114	131	142	213
		0	22	32	46	68	77	196
Ely, NV	153	1	67	97	116	134	162	242
		0.5	44	66	83	111	129	241
		0	23	45	67	97	112	240
Eugene, OR	18	1	59	110	139	165	171	224
		0.5	47	77	93	119	122	164
		0	30	53	70	102	120	164
Fairbanks, AK	288	1	91	121	144	174	202	391
		0.5	52	68	78	94	108	200
		0	15	23	31	40	48	87
Baltimore, MD, BWI Airport	56	1	87	139	172	235	282	431
		0.5	69	108	147	200	238	369
		0	46	84	119	181	214	306
Great Falls, MT	233	1	123	171	193	233	276	392
		0.5	71	93	107	129	144	210
		0	17	31	45	60	75	143
Indianapolis, IN	96	1	95	134	158	194	215	284
		0.5	58	80	96	116	124	209
		0	23	38	52	83	99	209

Table 5-1. Frequencies of snow-melting surface heat fluxes at steady state conditions.<sup>a</sup>  
Does not include back and edge heat loss.<sup>32</sup>

a. Heat fluxes are at the snow-melting surface only. See text for calculation of back and edge heat loss fluxes.

b. Multiply values by 0.2931 to convert to W/ft<sup>2</sup>

32. ©ASHRAE Handbook -- Systems and Equipment. Chapter 50, Table 1. 2008.

Location	Snowfall Hours per Year	Snow-Free Area Ratio $A_r$	Heat Fluxes Not Exceeded During Indicated Percentage of Snowfall Hours from 1982 through 1993, Btu/h-ft <sup>2</sup> <sup>b</sup>					
			75%	90%	95%	98%	99%	100%
Lexington, KY	50	1	81	108	123	150	170	233
		0.5	49	65	74	85	95	197
		0	16	30	39	46	55	162
Madison, WI	161	1	99	138	164	206	241	449
		0.5	61	82	98	129	163	245
		0	23	39	60	91	113	194
Memphis, TN	13	1	106	141	172	200	206	213
		0.5	75	96	115	118	130	157
		0	40	75	76	90	97	123
Milwaukee, WI	161	1	101	135	164	196	207	431
		0.5	62	83	101	128	147	246
		0	23	46	68	98	120	239
Minneapolis-St. Paul, MN	199	1	119	169	193	229	254	332
		0.5	73	99	114	138	154	287
		0	23	45	61	91	113	245
New York, NY, JFK Airport	61	1	91	134	164	207	222	333
		0.5	63	93	118	145	164	325
		0	38	68	86	113	133	316
Oklahoma City, OK	35	1	117	168	215	248	260	280
		0.5	72	101	123	133	144	208
		0	24	46	68	78	113	190
Omaha, NE	94	1	108	148	189	222	259	363
		0.5	65	89	105	128	135	186
		0	23	38	60	90	100	136
Peoria, IL	91	1	95	139	166	201	227	436
		0.5	58	83	99	119	130	250
		0	23	38	53	76	92	228
Philadelphia, PA, International Airport	56	1	94	129	154	208	246	329
		0.5	65	90	112	162	185	267
		0	38	63	79	111	150	225
Pittsburgh, PA, International Airport	168	1	83	125	159	194	219	423
		0.5	51	75	94	111	129	216
		0	16	31	46	68	77	136
Portland, ME	157	1	120	168	195	234	266	428
		0.5	76	108	132	168	199	376
		0	39	67	90	130	152	324
Portland, OR	15	1	50	78	102	177	239	296
		0.5	39	55	81	114	130	199
		0	23	45	60	78	102	128
Rapid City, SD	177	1	139	203	252	312	351	482
		0.5	78	111	132	164	183	245
		0	16	30	38	53	65	179
Reno, NV	63	1	50	72	89	116	137	191
		0.5	36	55	75	105	115	172
		0	23	45	68	91	113	159
Salt Lake City, UT	142	1	52	77	89	110	120	171
		0.5	39	62	76	96	104	171
		0	30	60	75	89	104	171
Sault Ste. Marie, MI	425	1	112	153	183	216	249	439
		0.5	66	88	104	125	142	239
		0	23	37	47	68	83	188
Seattle, WA	27	1	56	107	138	171	205	210
		0.5	45	72	97	122	133	175
		0	37	52	75	96	123	151
Spokane, WA	144	1	67	98	116	141	159	227
		0.5	45	61	73	84	95	145
		0	23	37	45	54	67	112
Springfield, MO	58	1	110	155	179	215	224	292
		0.5	70	95	117	142	171	240
		0	32	54	76	115	129	227
St. Louis, MO, International Airport	62	1	97	147	170	193	227	344
		0.5	66	90	105	126	144	269
		0	31	53	68	97	104	194
Topeka, KS	61	1	102	153	192	234	245	291
		0.5	64	92	110	132	139	185
		0	23	39	52	68	84	167
Wichita, KS	60	1	115	163	209	248	285	326
		0.5	71	96	116	137	153	168
		0	24	45	57	75	83	158

Table 5-2. Frequencies of snow-melting surface heat fluxes at steady state conditions.<sup>a</sup> (Cont.)

Does not include back and edge heat loss.

a. Heat fluxes are at the snow-melting surface only. See text for calculation of back and edge heat loss fluxes.

b. Multiply values by 0.2931 to convert to W/ft<sup>2</sup>

### Back and Edge Heat Loss

Back and edge heat loss is the percentage of heat lost through the back and edge of the snow melt area. Back and edge heat losses may add up to 50% to the snow melting load, depending on:

- Construction
- Insulation
- Exposure
- Operating temperature
- Ground temperature

A minimum of R-5 insulation below the tubing and on the sides of the snow melt area is recommended to reduce back and edge heat losses and reduce response time. Outside of the slab, insulate all supply and return lines with pipe insulation.

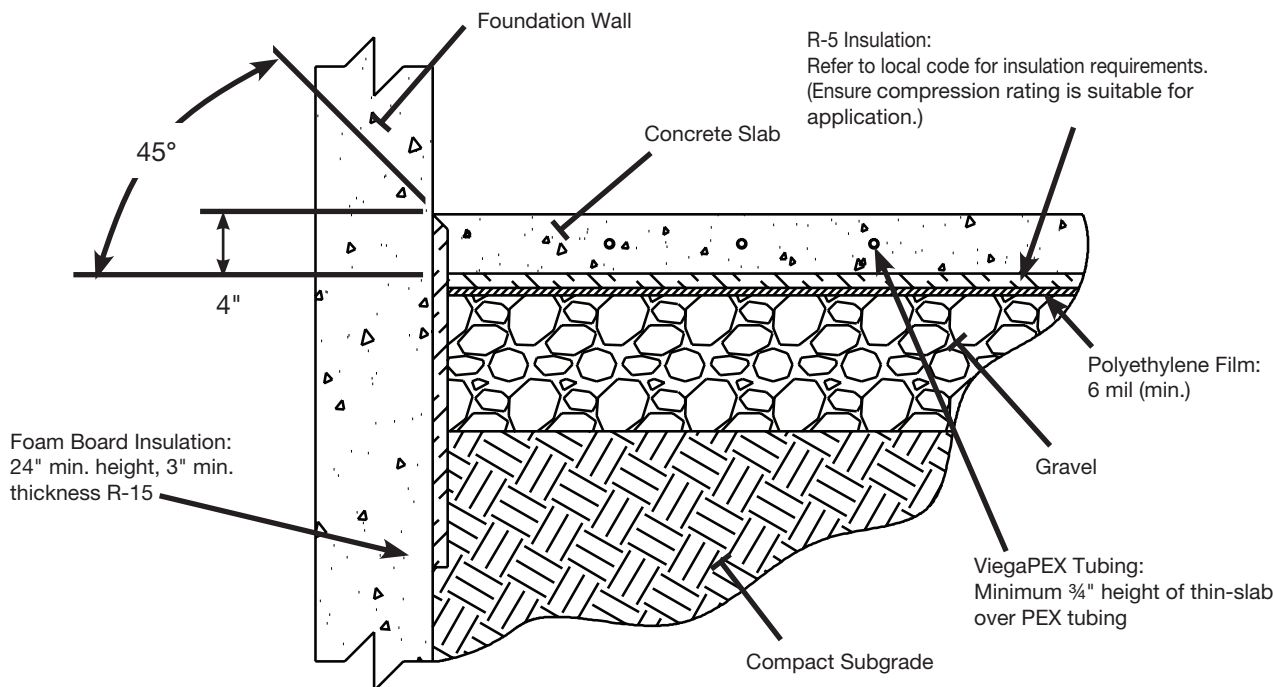


Figure 5-1 Minimum recommended insulation for snow melt systems. A polyethylene film is not recommended when pavers or other porous surfaces are installed.

Next, use the multipliers found in Table 5-3 to account for back and edge heat loss.

#### Procedure:

1. Use back and edge heat loss table to find the multiplier (based on the application).
2. Multiply the snow melting load (from Table 5-1) by the back and edge heat loss multiplier to calculate the design snow melting load.

#### Example:

Application: Full below but no edge insulation  
 % Increase multiplier: 10% (1.10)  
 Design snow melting load: 202 Btu/hr/ft<sup>2</sup> x 1.10 =  
 ~222 Btu/hr/ft<sup>2</sup>

Back and Edge Heat Loss	
Application	% Increase Multiplier
Full Below and Edge	5% (1.05)
Below and No Edge	10% (1.10)
Edge and None Below	15% (1.15)
No Insulation on Slab	30% (1.30)
Exposed Bridge	50% (1.50)

Table 5-3 Back and edge losses will increase with increasing tubing depth, soil conductivity, area-free ratio and decreasing insulation. Back and edge heat loss multipliers assume R-5 insulation where specified. Always ensure that the insulation's compressive strength is rated for the application.

### 5.3 Calculating the tubing spacing

Decreasing the tubing spacing will allow the snow melting system to operate at lower fluid temperatures while meeting the heat output requirements. Use Table 5-4 to identify recommended tubing spacing.

Procedure:

1. Find the tubing size in the first column of Table 5-4.
2. Follow to the right and read the recommended tubing spacing under the column representing the heat load.

Example:

Tubing size: 5/8"

Snow melting load: 200 Btu/hr/ft<sup>2</sup>

Recommended tubing spacing: 9"

#### NOTES:

- Space tubing 1" closer for each inch of concrete cover over 2".
- Space tubing 2" closer for each additional inch of pavers > 2 3/8" pavers.

- Space tubing 1" closer for asphalt applications.
- Minimum recommended spacing 6"

### 5.4 Calculating the glycol solution supply temperature

Use Table 5-5 to calculate the glycol solution supply temperature.

Procedure:

1. Find the snow melting load in the first column.
2. Follow to the right and read the recommended fluid supply temperature under the column representing the selected tubing spacing.

Example:

Snow melting load: 200 Btu/hr/ft<sup>2</sup>

Tubing spacing: 9"

Fluid supply temperature: 131°F

**NOTE:** Fluid supply temperature of 130°F is typical for snow melting applications.

Tubing Outer Size (in)	Max Circuit Length (ft)	Snow Melting Load (Btu/hr/ft <sup>2</sup> )				
		100	150	200	250	300
		Recommended Tubing Spacing (in)				
5/8"	200	12	12	9	6	6
3/4"	300	12	12	9	6	6

Table 5-4 Recommended tubing spacing and maximum circuit length as a function of snow melting load and tubing size.

Snow Melting Load (Btu/hr/ft <sup>2</sup> )	Tubing Spacing (in)		
	6	9	12
Fluid Supply Temperature (°F)			
100	100	100	103
150	100	106	128
200	108	131	N/A
250	133	N/A	N/A
300	158	N/A	N/A

Table 5-5 Recommended fluid supply temperature as a function of tubing spacing and snow melting load. Assumes a 30°F temperature drop across the system.

## 5.5 Selecting the percent glycol mixture

For typical freeze protection applications, Viega recommends using 40% propylene glycol, though a higher concentration may be required in your area. Ethylene glycol is compatible with ViegaPEX Barrier. Use Table 5-6 to determine the freezing point of the water/glycol mixture based on percent glycol by volume.

Glycol% (by volume)	0%	10%	20%	30%	40%	50%
Ethylene	32	25	16	3	-12	-35
Propylene	32	26	18	8	-7	-28

Table 5-6 Freezing point of the water/glycol mixture based on percent glycol by volume

### NOTE:

Automotive antifreeze is not recommended; the silicates in automotive antifreeze can coat and foul heat transfer surfaces and plug the system, reducing energy efficiency.

## 5.6 Sizing for flow rate, pressure drop and expansion

Glycol solutions have higher densities than water solutions, which means that to achieve equivalent heat flow, these systems must operate at a higher flow rate and pressure drop than would a system with the same piping layout that uses 100% water as the working fluid. The higher flow rate and pressure drop must be taken into account when sizing the glycol system's circulator pumps.

### 5.6.1 Glycol flow rate

To estimate the flow rate required in the glycol loop, you may use the following equation:

$$GPM = \left( \frac{\text{Total Design Heat Load (Btu/hr)}}{\Delta T \cdot 8.01 \cdot C_p \cdot P} \right)$$

where

$\Delta T$  is the system temperature drop from supply to return.

$c_p$  is the specific heat of the fluid, taken at the average of the supply and return temperature (Btu/lb/°F). For the specific heat of glycol solutions, see Table 5-7 for propylene glycol or Table 5-8 for ethylene glycol.

8.01 is a constant to convert between units.

$\rho$  is the density of the fluid, taken at the average of the supply and return temperature (lbs/ft<sup>3</sup>). For the density of glycol solutions, see Table 5-15 for propylene glycol or Table 5-16 for ethylene glycol.

Specific Heat of Propylene Glycol Solutions (Btu/lb/°F)									
Temperature (°F)	Propylene Glycol Concentration by Volume								
	10%	20%	30%	40%	50%	60%	70%	80%	90%
-30						0.741	0.680	0.615	0.542
-20					0.799	0.746	0.687	0.623	0.550
-10					0.804	0.752	0.693	0.630	0.558
0				0.855	0.809	0.758	0.700	0.637	0.566
10			0.898	0.859	0.814	0.764	0.707	0.645	0.574
20		0.936	0.902	0.864	0.820	0.770	0.713	0.652	0.583
30	0.966	0.938	0.906	0.868	0.825	0.776	0.720	0.660	0.591
40	0.968	0.941	0.909	0.872	0.830	0.782	0.726	0.667	0.599
50	0.970	0.944	0.913	0.877	0.835	0.787	0.733	0.674	0.607
60	0.972	0.947	0.917	0.881	0.840	0.793	0.740	0.682	0.615
70	0.974	0.950	0.920	0.886	0.845	0.799	0.746	0.689	0.623
80	0.976	0.953	0.924	0.890	0.850	0.805	0.753	0.696	0.631
90	0.979	0.956	0.928	0.894	0.855	0.811	0.760	0.704	0.639
100	0.981	0.959	0.931	0.899	0.861	0.817	0.766	0.711	0.647
110	0.983	0.962	0.935	0.903	0.866	0.823	0.773	0.718	0.656
120	0.985	0.965	0.939	0.908	0.871	0.828	0.779	0.726	0.664
130	0.987	0.967	0.942	0.912	0.876	0.834	0.786	0.733	0.672
140	0.989	0.970	0.946	0.916	0.881	0.840	0.793	0.740	0.680
150	0.991	0.973	0.950	0.921	0.886	0.846	0.799	0.748	0.688
160	0.993	0.976	0.953	0.925	0.891	0.852	0.806	0.755	0.696
170	0.996	0.979	0.957	0.929	0.896	0.858	0.812	0.762	0.704
180	0.998	0.982	0.961	0.934	0.902	0.864	0.819	0.770	0.712
190	1.000	0.985	0.964	0.938	0.907	0.869	0.826	0.777	0.720
200	1.002	0.988	0.968	0.943	0.912	0.875	0.832	0.784	0.729
210	1.004	0.991	0.971	0.947	0.917	0.881	0.839	0.792	0.737
220	1.006	0.994	0.975	0.951	0.922	0.887	0.845	0.799	0.745
230	1.008	0.996	0.979	0.956	0.927	0.893	0.852	0.806	0.753
240	1.011	0.999	0.982	0.960	0.932	0.899	0.859	0.814	0.761
250	1.013	1.002	0.986	0.965	0.937	0.905	0.865	0.821	0.769

Table 5-7 Specific heat of propylene glycol solutions<sup>33</sup>

33. ©ASHRAE Fundamentals, Chapter 31, 2009.



Specific Heat of Ethylene Glycol Solutions (Btu/lb/°F)									
Temperature (°F)	Ethylene Glycol Concentration by Volume								
	10%	20%	30%	40%	50%	60%	70%	80%	90%
-30					0.734	0.680	0.625	0.567	
-20					0.739	0.686	0.631	0.574	0.515
-10				0.794	0.744	0.692	0.638	0.581	0.523
0				0.799	0.749	0.698	0.644	0.588	0.530
10			0.849	0.803	0.754	0.703	0.651	0.595	0.538
20		0.897	0.853	0.808	0.759	0.709	0.657	0.603	0.546
30	0.940	0.900	0.857	0.812	0.765	0.715	0.664	0.610	0.553
40	0.943	0.903	0.861	0.816	0.770	0.721	0.670	0.617	0.561
50	0.945	0.906	0.864	0.821	0.775	0.727	0.676	0.624	0.569
60	0.947	0.909	0.868	0.825	0.780	0.732	0.683	0.631	0.576
70	0.950	0.912	0.872	0.830	0.785	0.738	0.689	0.638	0.584
80	0.952	0.915	0.876	0.834	0.790	0.744	0.696	0.645	0.592
90	0.954	0.918	0.880	0.839	0.795	0.750	0.702	0.652	0.600
100	0.957	0.922	0.883	0.843	0.800	0.756	0.709	0.659	0.607
110	0.959	0.925	0.887	0.848	0.806	0.761	0.715	0.666	0.615
120	0.961	0.928	0.891	0.852	0.811	0.767	0.721	0.673	0.623
130	0.964	0.931	0.895	0.857	0.816	0.773	0.728	0.680	0.630
140	0.966	0.934	0.898	0.861	0.821	0.779	0.734	0.687	0.638
150	0.968	0.937	0.902	0.865	0.826	0.785	0.741	0.694	0.646
160	0.971	0.940	0.906	0.870	0.831	0.790	0.747	0.702	0.654
170	0.973	0.943	0.910	0.874	0.836	0.796	0.754	0.709	0.661
180	0.975	0.946	0.913	0.879	0.842	0.802	0.760	0.716	0.669
190	0.978	0.949	0.917	0.883	0.847	0.808	0.766	0.723	0.677
200	0.980	0.952	0.921	0.888	0.852	0.813	0.773	0.730	0.684
210	0.982	0.955	0.925	0.892	0.857	0.819	0.779	0.737	0.692
220	0.985	0.958	0.929	0.897	0.862	0.825	0.786	0.744	0.700
230	0.987	0.961	0.932	0.901	0.867	0.831	0.792	0.751	0.708
240	0.989	0.964	0.936	0.905	0.872	0.837	0.799	0.758	0.715
250	0.992	0.967	0.940	0.910	0.877	0.842	0.805	0.765	0.723

Table 5-8 Specific heat of ethylene glycol<sup>34</sup>

34. ©ASHRAE Fundamentals, Chapter 31, 2009.

### 5.6.2 Glycol pressure drop

Determining the pressure drop in a snow melt system with a glycol solution is achieved in the same manner as for a 100% water system, except that different pressure drop charts must be used based on the % glycol solution. Pressure drop tables for piping using a glycol solution are provided below.

Circulators must be sized for the pressure drop that they will experience at their design flow rate. The first step in calculating the pressure drop associated with a circulator is identifying the network of piping and accessories (valves, fittings, mixing devices, expansion tanks, air separators, etc.) that corresponds with each circulator.

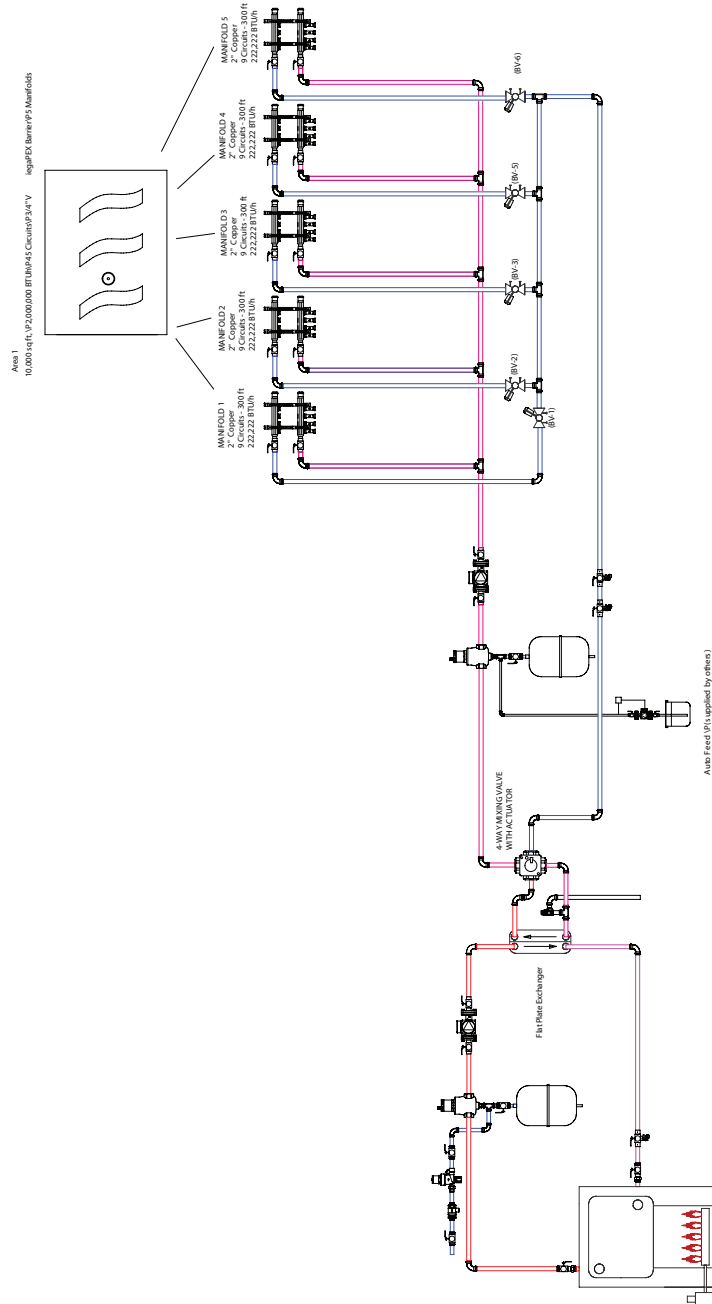


Figure 5-2 Snow melt piping configuration showing primary, secondary and panel piping associated with each circulator.

Once a circulator's network is identified, the basic theory for sizing the circulator is to size it for the maximum flow rate seen at the circulator's location and at the total pressure drop that the working fluid experiences across the circulator's network. When dealing with sections of parallel piping within a network, the maximum pressure drop seen through the parallel section is the greatest pressure drop of any one section. When dealing with series piping within a network, the maximum pressure drop seen through the series section is the sum of the pressure drop of the components in series.

To calculate the pressure drop in secondary and panel piping within a circulator's network, take the following steps:

- Determine the length of each panel piping circuit off each manifold within the circulator network.
- Using the pressure drop tables that correspond to the system's glycol content and tubing size, multiply the pressure drop per foot (obtained from the table using the circuit flow rate) by the circuit length. Because a manifold's circuits are in parallel, identify the circuit with the largest pressure drop at each manifold.
- To the largest circuit pressure drop at each manifold, add the pressure drop through the corresponding supply and return manifolds.
- For each manifold within the circulator network, add the pressure drop of the secondary supply and return piping located between the primary piping and the manifold. For series piping between the primary piping and manifold, add the pressure drop of adjacent sections of series piping. For parallel piping between the primary piping and manifold, select the maximum pressure drop of the parallel piping sections, and then add this to adjacent sections of series piping. The pressure drop is determined by using the appropriate pressure drop table corresponding to the system's glycol content and flow rate seen within the relevant section of secondary piping between the primary piping and the manifold.
- When calculating the pressure drop of the secondary piping, be sure to add the pressure drop of all associated valves, fittings, mixing devices and other piping accessories (expansion tanks, air separators, etc.) located within the relevant piping sections. As much as possible, during the

design phase, select valves and accessories with low pressure drop ratings to reduce the system pressure drop. For balancing valves, this means selecting units with high flow coefficients, also known as a "Cv" rating. For mixing valves, select a valve with a Cv rating that is as close as possible to the design flow rate through the valve. This will optimize performance of the valve (good control at reduced head). To determine the pressure drop associated with valves based on their Cv ratings, you may use the following equation:

$$\Delta P = \left( \frac{D}{62.4} \right) \cdot \left( \frac{f}{C_v} \right)^2$$

where

- $\Delta P$  = pressure drop across the valve in psi
- $D$  = density of the fluid at operating temperature (lb/ft<sup>3</sup>)
- 62.4 = density of water at 60°F (lb/ft<sup>3</sup>)
- $f$  = flow rate of fluid (gpm)
- $C_v$  = known Cv rating of the device (gpm)

If a manufacturer provides the pressure drop of an accessory in psi, you may convert the psi to feet of head with the following formula:

$$H = \frac{144 \cdot \Delta P}{D}$$

where

- $H$  is the "head loss," also known as pressure drop, of the accessory (feet of head)
- $\Delta P$  is the pressure drop (psi)
- $D$  is the density of the fluid at its corresponding temperature (lbs/ft<sup>3</sup>). If the fluid is water, or if the density of the fluid has already been accounted for elsewhere, you may use  $D=62.4$ .

- The secondary piping circulator should be sized to accommodate the secondary piping's maximum volumetric flow rate at the total pressure drop for the secondary and panel piping (calculated above).

Continue calculating the pressure drop in the primary piping:

- Determine the length of the primary piping. Be sure to include all piping between the heating source and secondary piping. For each pipe size in the primary piping system, use the pressure drop tables that correspond to the system's glycol content and flow rate, and multiply the pressure drop per foot (obtained from the table) by the equivalent length of each corresponding piping size.
- Add the pressure drop of all valves, fittings, heating source and other piping accessories (expansion tanks, air separators, etc.) located in the primary piping system.

The primary piping circulator should be sized to accommodate the primary system flow rate at the total pressure drop of the primary piping system (calculated above).

Example of how to use a pressure drop chart: Determine the pressure drop associated with 200 feet of 3/4" tubing at a maximum flow rate of 5 gpm for a 40% glycol solution:

1. Locate desired 5 gpm flow rate for the tubing on the left vertical axis of Table 5-9
2. Follow to the right until you reach the diagonal line corresponding to 3/4" tubing
3. Move down to the horizontal axis and read the pressure drop in feet of head per foot of tubing (0.2 feet of head per foot of tubing)
4. Multiply the pressure drop per foot by the length of tubing to find the feet of head for the circuit ( $0.2 \times 200 = 40$  feet of head)

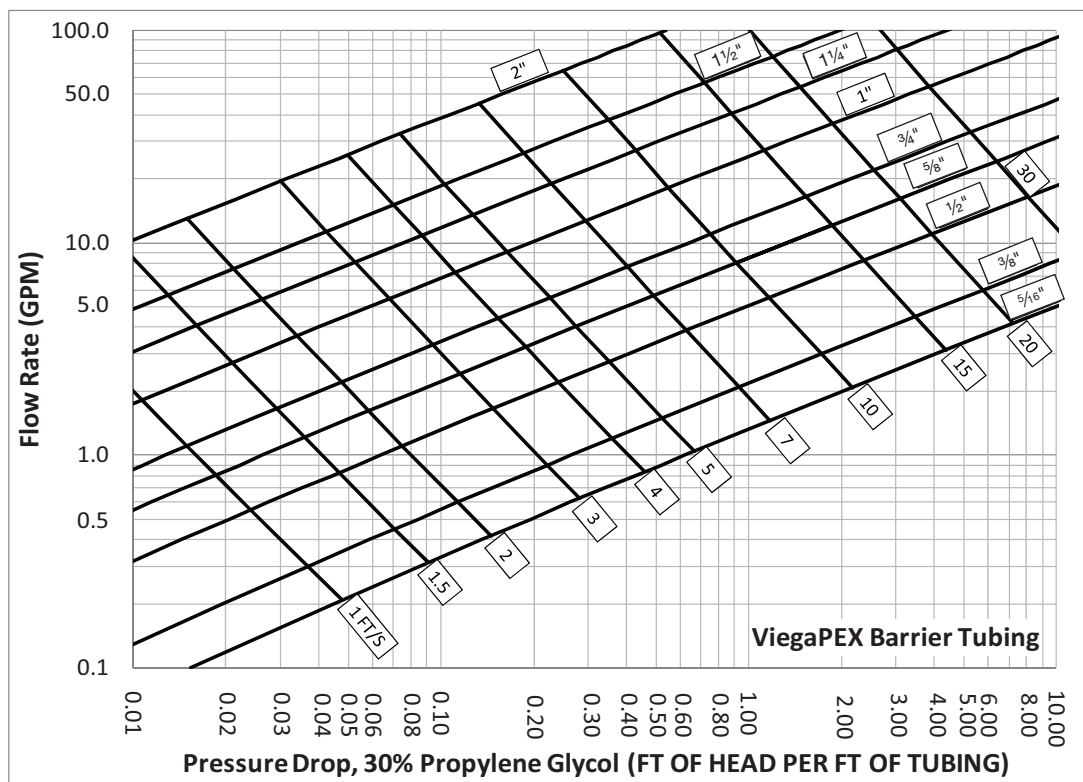


Table 5-9 Thirty percent propylene glycol pressure drop table for ViegaPEX Barrier tubing

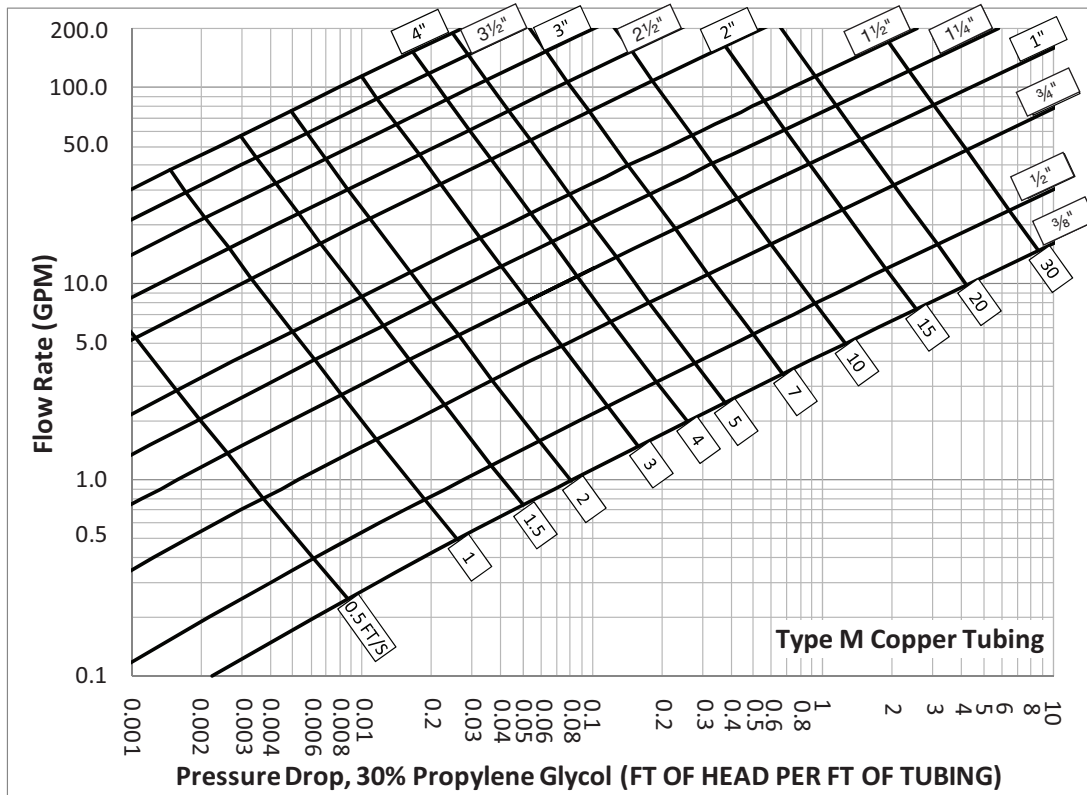


Table 5-10 Thirty percent propylene glycol pressure drop table for Type M copper tubing

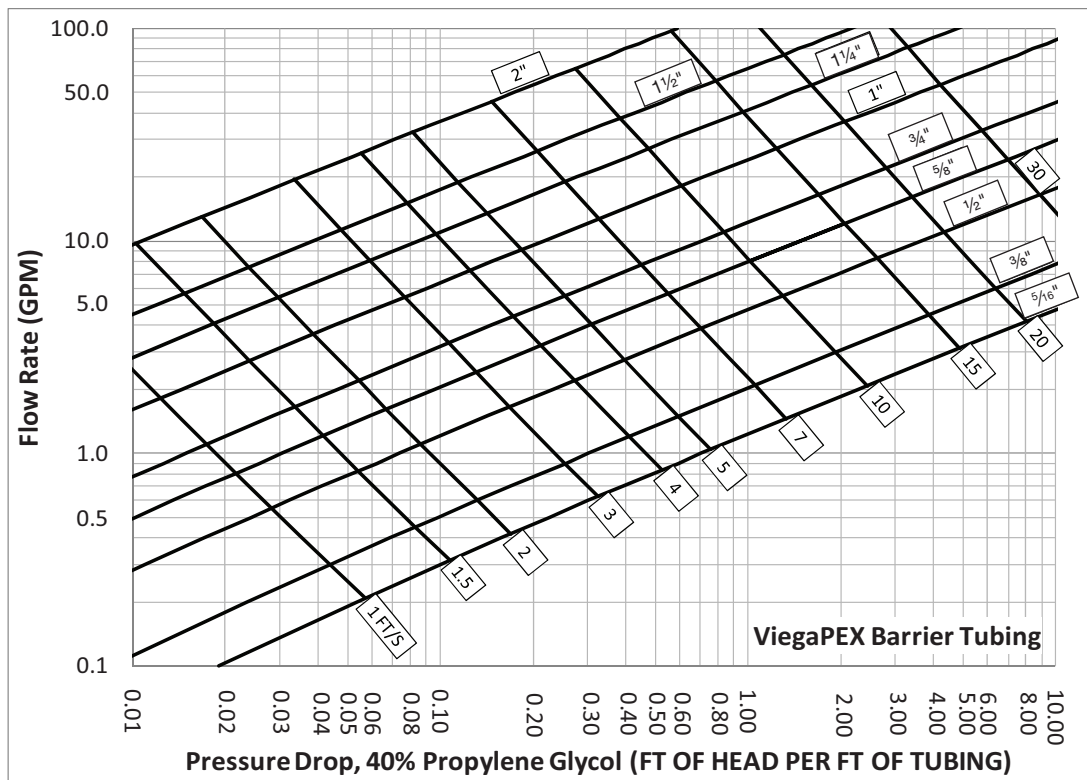


Table 5-11 Forty percent propylene glycol pressure drop table for ViegaPEX Barrier tubing

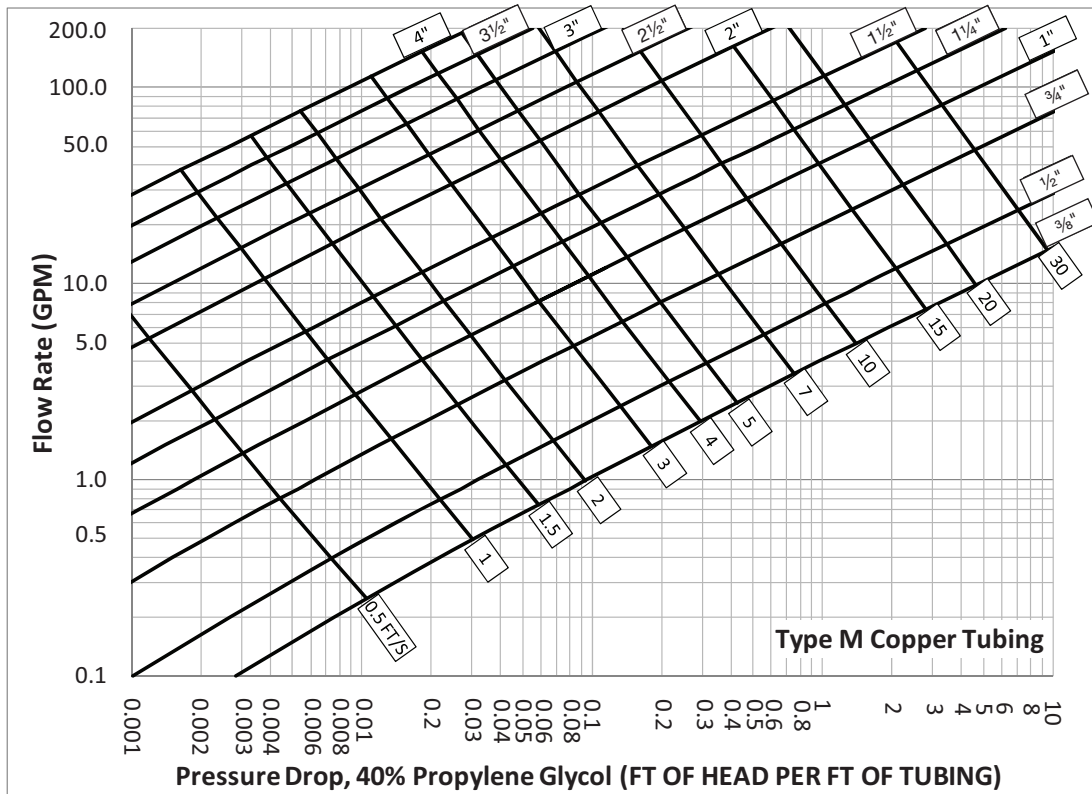


Table 5-12 Forty percent propylene glycol pressure drop table for Type M copper tubing

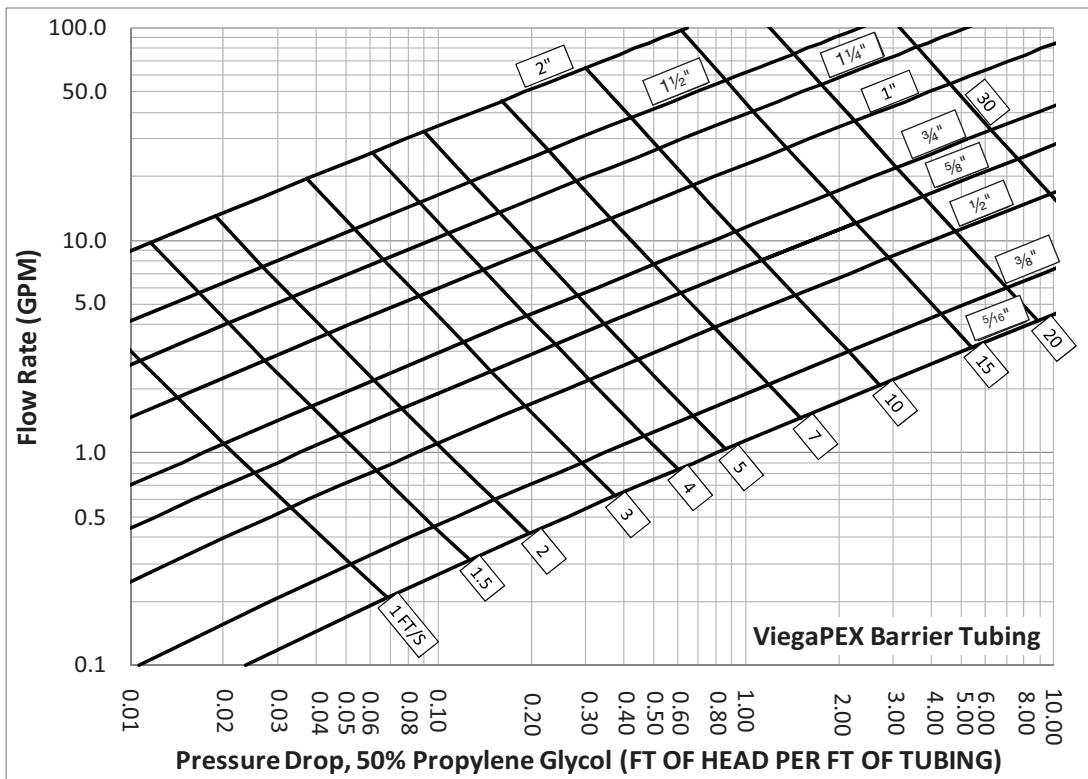


Table 5-13 Fifty percent propylene glycol pressure drop table for ViegaPEX Barrier tubing

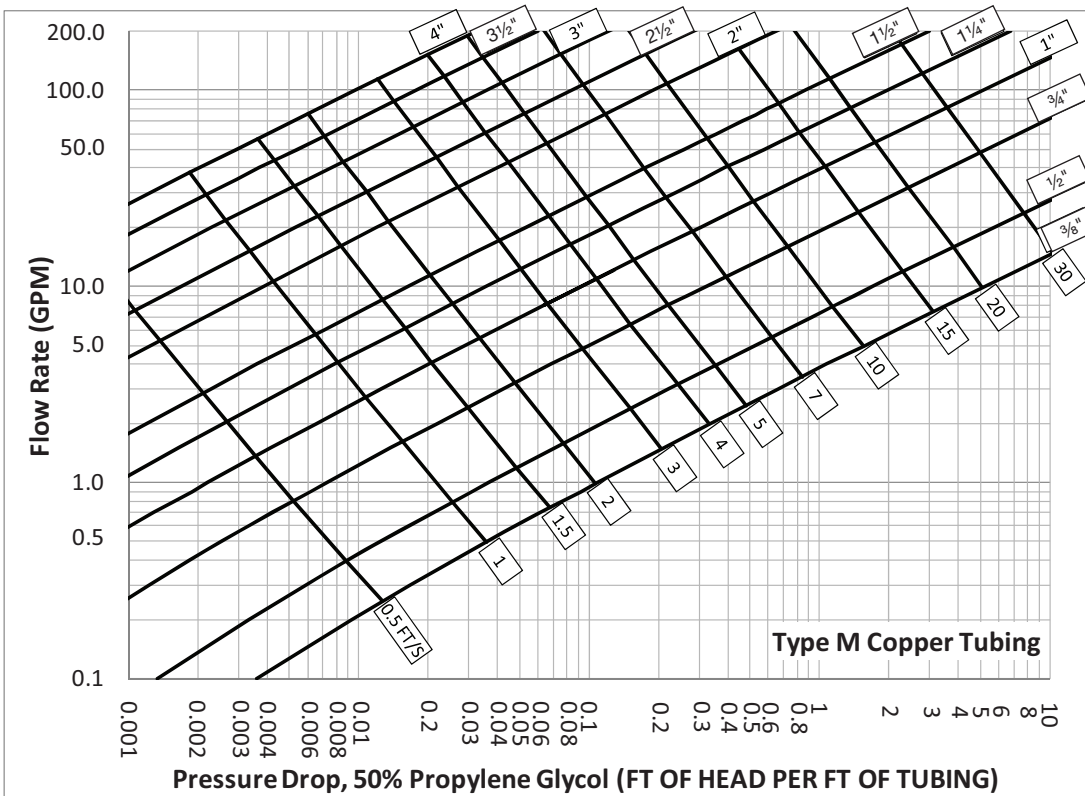


Table 5-14 Fifty percent propylene glycol pressure drop table for Type M copper tubing

### 5.6.3 Glycol expansion tank selection

Glycol solutions require larger expansion tanks than 100% water solutions. Expansion tanks for glycol solutions are typically at least 1.2x the size of those required for 100% water solutions. To size an expansion tank for a glycol solution, use the same equation that you would to size a 100% water solution. When using the following equation to size an expansion tank for a glycol solution, be sure to use the appropriate densities of the % glycol solution based on the type of glycol (i.e., propylene or ethylene), and the values provided in Table 5-15 and Table 5-16.

$$V_t = V_s \cdot \left( \frac{D_c}{D_h} - 1 \right) \cdot \left( \frac{P_{RV} + 9.7}{P_{RV} - P_a - 5} \right)$$

where

$V_t$  = minimum tank volume (gal)

$V_s$  = fluid volume in system (gal)

$D_c$  = density of the fluid at its initial start

temperature (lbs/ft<sup>3</sup>), whether water or glycol mix

$D_h$  = density of the fluid at its maximum operating

temperature (lbs/ft<sup>3</sup>), whether water or glycol mix

$P_a$  = air side pressurization on the opposite side of the bladder, typically set at 12 psi from factory (psi)

$P_{rv}$  = pressure relief valve setting in (psi)

Density of Propylene Glycol Solutions (lbs/ft <sup>3</sup> )										
Temperature (°F)	Propylene Glycol Concentration by Volume									
	0%	10%	20%	30%	40%	50%	60%	70%	80%	90%
-30							67.05	67.47	68.38	68.25
-20						66.46	66.93	67.34	68.13	68.00
-10						66.35	66.81	67.20	67.87	67.75
0					65.71	66.23	66.68	67.05	67.62	67.49
10				65.00	65.60	66.11	66.54	66.89	67.36	67.23
20			64.23	64.90	65.48	65.97	66.38	66.72	67.10	66.97
30		63.38	64.14	64.79	65.35	65.82	66.22	66.54	66.83	66.71
40	62.42	63.30	64.03	64.67	65.21	65.67	66.05	66.35	66.57	66.44
50	62.42	63.20	63.92	64.53	65.06	65.50	65.87	66.16	66.30	66.18
60	62.38	63.10	63.79	64.39	64.90	65.33	65.68	65.95	66.04	65.91
70	62.31	62.98	63.66	64.24	64.73	65.14	65.47	65.73	65.77	65.64
80	62.23	62.86	63.52	64.08	64.55	64.95	65.26	65.51	65.49	65.37
90	62.11	62.73	63.37	63.91	64.36	64.74	65.04	65.27	65.22	65.09
100	62.00	62.59	63.20	63.73	64.16	64.53	64.81	65.03	64.95	64.82
110	61.84	62.44	63.03	63.54	63.95	64.30	64.57	64.77	64.67	64.54
120	61.73	62.28	62.85	63.33	63.74	64.06	64.32	64.51	64.39	64.26
130	61.54	62.11	62.66	63.12	63.51	63.82	64.06	64.23	64.11	63.98
140	61.39	61.93	62.46	62.90	63.27	63.57	63.79	63.95	63.83	63.70
150	61.20	61.74	62.25	62.67	63.02	63.30	63.51	63.66	63.55	63.42
160	61.01	61.54	62.03	62.43	62.76	63.03	63.22	63.35	63.26	63.13
170	60.79	61.33	61.80	62.18	62.49	62.74	62.92	63.04	62.97	62.85
180	60.57	61.11	61.56	61.92	62.22	62.45	62.61	62.72	62.68	62.56
190	60.35	60.89	61.31	61.65	61.93	62.14	62.29	62.39	62.39	62.27
200	60.13	60.65	61.05	61.37	61.63	61.83	61.97	62.05	62.10	61.97
210	59.88	60.41	60.78	61.08	61.32	61.50	61.63	61.69	61.81	61.68
220		60.15	60.50	60.78	61.00	61.17	61.28	61.33	61.51	61.38
230		59.89	60.21	60.47	60.68	60.83	60.92	60.96	61.21	61.08
240		59.61	59.91	60.15	60.34	60.47	60.55	60.58	60.91	60.78
250		59.33	59.60	59.82	59.99	60.11	60.18	60.19	60.61	60.48

Table 5-15 Density of propylene glycol solutions at various concentrations and temperatures<sup>35</sup>

35. ©ASHRAE Fundamentals, Chapter 31, 2009.



Density of Ethylene Glycol Solutions (lbs/ft <sup>3</sup> )										
Temperature (°F)	Ethylene Glycol Concentration by Volume									
	0%	10%	20%	30%	40%	50%	60%	70%	80%	90%
-30						68.12	69.03	69.90	70.75	
-20						68.05	68.96	69.82	70.65	71.45
-10					67.04	67.98	68.87	69.72	70.54	71.33
0					66.97	67.90	68.78	69.62	70.43	71.20
10				65.93	66.89	67.80	68.67	69.50	70.30	71.06
20			64.83	65.85	66.80	67.70	68.56	69.38	70.16	70.92
30		63.69	64.75	65.76	66.70	67.59	68.44	69.25	70.02	70.76
40	62.42	63.61	64.66	65.66	66.59	67.47	68.31	69.10	69.86	70.59
50	62.42	63.52	64.56	65.55	66.47	67.34	68.17	68.95	69.70	70.42
60	62.38	63.42	64.45	65.43	66.34	67.20	68.02	68.79	69.53	70.23
70	62.31	63.31	64.33	65.30	66.20	67.05	67.86	68.62	69.35	70.04
80	62.23	63.19	64.21	65.17	66.05	66.90	67.69	68.44	69.15	69.83
90	62.11	63.07	64.07	65.02	65.90	66.73	67.51	68.25	68.95	69.62
100	62.00	62.93	63.93	64.86	65.73	66.55	67.32	68.05	68.74	69.40
110	61.84	62.79	63.77	64.70	65.56	66.37	67.13	67.84	68.52	69.17
120	61.73	62.63	63.61	64.52	65.37	66.17	66.92	67.63	68.29	68.92
130	61.54	62.47	63.43	64.34	65.18	65.97	66.71	67.40	68.05	68.67
140	61.39	62.30	63.25	64.15	64.98	65.75	66.48	67.16	67.81	68.41
150	61.20	62.11	63.06	63.95	64.76	65.53	66.25	66.92	67.55	68.14
160	61.01	61.92	62.86	63.73	64.54	65.30	66.00	66.66	67.28	67.86
170	60.79	61.72	62.64	63.51	64.31	65.05	65.75	66.40	67.01	67.58
180	60.57	61.51	62.42	63.28	64.07	64.80	65.49	66.12	66.72	67.28
190	60.35	61.29	62.19	63.04	63.82	64.54	65.21	65.84	66.42	66.97
200	60.13	61.06	61.95	62.79	63.56	64.27	64.93	65.55	66.12	66.65
210	59.88	60.82	61.71	62.53	63.29	63.99	64.64	65.24	65.81	66.33
220		60.57	61.45	62.27	63.01	63.70	64.34	64.93	65.48	65.99
230		60.31	61.18	61.99	62.72	63.40	64.03	64.61	65.15	65.65
240		60.05	60.90	61.70	62.43	63.10	63.71	64.28	64.81	65.29
250		59.77	60.62	61.40	62.12	62.78	63.39	63.94	64.46	64.93

Table 5-16 Density of ethylene glycol solutions at various concentrations and temperatures<sup>36</sup>

## 5.7 Selecting the circulator

Pump curves help you to select a circulator based on the feet of head expected at the design flow rate. The selected pump must have a capacity greater than or equal to the system flow rate and a head greater than or equal to the total system pressure drop. Derive the system flow rate from Section 5.6.1 and the pressure drop from Section 5.6.2. Once these two system characteristics are known, a pump curve can be used to identify the best match for the system. Follow the procedure below to select a pump sourced from Viega:

1. Locate the pressure drop on the left vertical axis.
2. Locate the total system flow rate on the bottom horizontal axis.
3. Follow to the intersection of both variables.
4. Select a pump with a curve just higher than this intersection. If there are multiple pumps with curves higher than this point, then consider selecting the pump with the lowest watts for the best energy performance. Large commercial and industrial applications may require larger pumps.

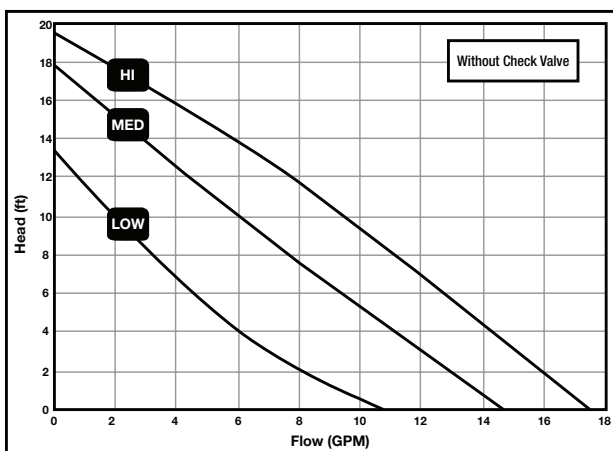


Figure 5-3a Pump curves

Stock Code	Speed	Amps	Watts	HP
12126	HI	0.75	87	1/25
	MED	0.66	80	1/25
	LOW	0.55	80	1/25

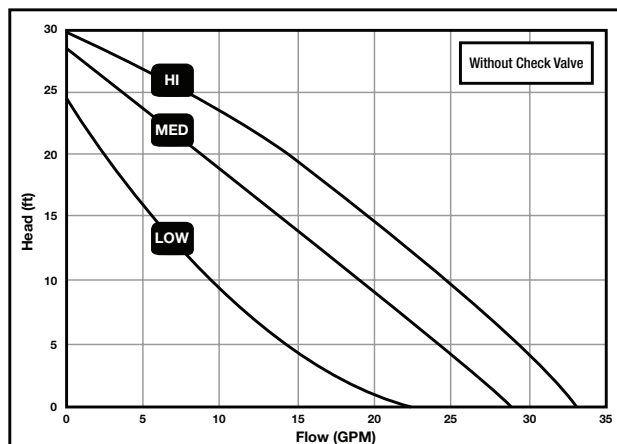


Figure 5-3b Pump curves

Stock Code	Speed	Amps	Watts	HP
12127	HI	1.8	197	1/6
	MED	1.5	179	1/6
	LOW	1.3	150	1/6

## 5.8 Approximating the operating cost

Use this equation to calculate the cost to use a snow melting system for 1 year:

$$O = \frac{A \times q_a \times F}{[1 - (B/100)] \times (n_b \times n_e)}$$

where

O = Operating cost (\$/yr)

A = Area (ft<sup>2</sup>)

q<sub>a</sub> = Annual heat flux requirement (Btu/ft<sup>2</sup>), refer to Table 5-1 or 5-2

F = Fuel cost (\$/Btu); useful conversions: 100,000 Btu/therm; 3,412 Btu/kWh; 91,500 Btu/gal propane; 138,700 Btu/gal fuel oil

B = Back and edge loss (% multiplier), refer to Table 5-3

n<sub>b</sub> = combustion efficiency of boiler, dimensionless

n<sub>e</sub> = energy distribution efficiency, dimensionless

**NOTE:** This calculation is sensitive to the proper construction and control of the snow melt system.

Example:

A = 2,000 ft<sup>2</sup>

q<sub>a</sub> = 7,694 Btu/ft<sup>2</sup> (in Boston)

F = assume \$0.80/therm; 100,000 Btu/therm

F = \$0.000008/Btu

B = 10%, assuming insulation below but no edge

n<sub>b</sub> = 0.85

n<sub>e</sub> = 0.90

Operating cost =

$$\frac{(2,000 \times 7,694 \times 0.000008)}{[1 - (10 \div 100)] \times 0.85 \times 0.90} = \$179/\text{yr}$$

Location	Time, h/yr		2% Min. Snow Temp., °F	Annual Energy Requirement per Unit Area at Steady-State Conditions <sup>a</sup> , Btu/ft <sup>2</sup>					
				System Designed for $A_r = 1$		System Designed for $A_r = 0.5$		System Designed for $A_r = 0$	
	Melting	Idling		Melting	Idling	Melting	Idling	Melting	Idling
Albany, NY	156	1,883	9.3	10,132	109,230	7,252	109,004	4,371	108,420
Albuquerque, NM	44	954	16.3	2,455	38,504	1,729	38,495	984	38,332
Amarillo, TX	64	1,212	6.8	5,276	62,557	3,314	62,136	1,357	61,170
Billings, MT	225	1,800	-10.8	17,299	116,947	10,526	111,803	3,716	91,360
Bismarck, ND	158	2,887	-8.8	16,295	207,888	9,321	201,565	2,300	157,503
Boise, ID	85	1,611	5.3	3,543	74,724	2,449	73,015	1,345	68,456
Boston, MA	112	1,273	16.3	7,694	77,992	5,455	77,907	3,218	77,747
Buffalo, NY	292	1,779	3.8	23,929	105,839	14,735	105,521	5,563	101,945
Burlington, VT	204	2,215	4.3	13,182	147,122	8,485	143,824	3,783	134,634
Cheyenne, WY	224	2,152	-15.8	20,061	126,714	11,931	125,635	3,782	120,915
Chicago, IL, O'Hare International Airport	124	1,854	3.8	8,501	116,663	5,402	112,763	2,252	100,427
Cleveland, OH	188	1,570	8.8	11,419	86,539	7,359	85,470	3,208	80,851
Colorado Springs, CO	159	1,925	-8.8	11,137	97,060	7,089	96,847	3,026	96,244
Columbus, OH, International Airport	92	1,429	12.8	4,581	71,037	2,972	68,002	1,367	62,038
Des Moines, IA	127	1,954	-1.8	10,884	128,140	6,796	125,931	2,654	116,545
Detroit, MI, Metro Airport	153	1,781	11.3	10,199	104,404	6,467	102,289	2,704	95,777
Duluth, MN	238	3,206	0.3	20,838	251,218	12,423	236,657	3,969	187,820
Ely, NV	153	2,445	13.3	7,421	141,288	5,268	139,242	3,098	136,920
Eugene, OR	18	481	15.8	841	17,018	634	16,997	429	16,992
Fairbanks, AK	288	4,258	-15.8	19,803	343,674	11,700	318,880	3,559	194,237
Baltimore, MD, BWI Airport	56	957	16.3	3,827	45,132	2,970	45,132	2,121	45,130
Great Falls, MT	233	1,907	-15.8	19,703	123,801	11,731	120,603	3,736	101,712
Indianapolis, IN	96	1,473	10.8	6,558	80,942	4,132	78,532	1,705	75,926
Lexington, KY	50	1,106	13.3	2,696	54,084	1,718	52,278	733	45,859
Madison, WI	161	2,308	5.3	11,404	149,363	7,279	147,112	3,094	140,108
Memphis, TN	13	473	12.8	1,010	21,756	691	21,518	373	21,102
Milwaukee, WI	161	1,960	7.3	11,678	127,230	7,564	123,960	3,431	119,945
Minneapolis-St. Paul, MN	199	2,513	0.3	16,532	183,980	10,325	178,495	4,097	166,921
New York, NY, JFK Airport	61	885	18.3	4,193	50,680	2,988	50,467	1,797	50,049
Oklahoma City, OK	35	686	6.8	2,955	40,957	1,850	39,725	741	38,308
Omaha, NE	94	1,981	-2.3	7,425	124,274	4,613	119,565	1,790	112,700
Peoria, IL	91	1,748	2.3	6,544	104,380	4,078	100,581	1,606	94,045
Philadelphia, PA, International Airport	56	992	18.3	3,758	50,494	2,669	50,412	1,588	50,203
Pittsburgh, PA, International Airport	168	1,514	9.3	10,029	79,312	6,350	77,750	2,626	72,361
Portland, ME	157	1,996	7.3	13,318	115,248	8,969	115,196	4,630	114,836
Portland, OR	15	329	21.8	623	13,399	464	13,194	310	12,918
Rapid City, SD	177	2,154	-4.8	16,889	137,523	9,738	135,024	2,535	106,102
Reno, NV	63	1,436	16.3	2,293	54,713	1,792	54,706	1,302	54,703
Salt Lake City, UT	142	1,578	16.3	5,263	70,254	4,271	69,927	3,286	69,927
Sault Ste. Marie, MI	425	2,731	-0.3	34,249	176,517	20,779	174,506	7,250	155,508
Seattle, WA	27	260	17.8	1,212	10,482	943	10,473	682	10,452
Spokane, WA	144	1,832	10.8	6,909	81,000	4,721	79,177	2,512	75,659
Springfield, MO	58	1,108	6.8	4,401	57,165	2,950	56,929	1,503	56,238
St. Louis, MO, International Airport	62	1,150	6.8	4,516	64,668	2,981	63,428	1,446	60,764
Topeka, KS	61	1,409	-1.8	4,507	75,598	2,821	74,028	1,126	68,402
Wichita, KS	60	1,223	0.3	4,961	69,187	3,106	67,828	1,229	60,991

Table 5-17 Annual snow melting energy requirements (Btu/ft<sup>2</sup>) by city and snow-free area ratio<sup>37</sup>

a. Does not include back and edge heat losses.

b. Multiply values by  $2.93 \times 10^{-4}$  to convert to kWh/ft<sup>2</sup>

37. ©ASHRAE Handbook -- Systems and Equipment. p.50.9. 2008.

## 5.9 Thermal mass considerations

Concrete, pavers or asphalt may be used in snow melting systems.

### Concrete

Refer to cement manufacturer for recommended compressive strength, slump, aggregate size and air content. Typical applications include:

- Compressive strength - 4,000 to 5,000 psi
- Slump - 3" max., 2" min.
- Typical 2" concrete above tubing

### Asphalt

- Hot asphalt can damage tubing (refer to cross sections for installation)
- Lower thermal conductivity than concrete
- Finest grade asphalt is best
- Stone diameter should not exceed 0.38"
- Typical 1½" sand bed above tubing
- Tubing should be secured to the insulation to prevent contact with the hot asphalt
- During installation, ensure that tubing temperature does not exceed 200°F

### Pavers

- Space tubing 2" closer for each additional inch of pavers > 2⅜" pavers
- Typical 1½" sand bed above tubing

## 5.10 Typical cross sections

Snow melt systems can be incorporated under asphalt, concrete, pavers or other porous or non-porous hardscapes. See Section 5.12.1 for typical cross sections.

## 5.11 Controls

When selecting control packages for snow melt systems, consideration must be given to piping configurations, mixing options, heat exchangers and control hardware.

### 5.11.1 Piping configurations

Piping for snow melting systems may be configured as follows:

1. Completely separate heating source from indoor heating piping
2. Thermally coupled to indoor heating piping through a heat exchanger (e.g., when the indoor system uses 100% water and the snow melt uses a glycol solution)

### 5.11.2 Mixing options

Each of these piping configurations requires some form of mixing or boiler modulation to ensure that design delivery temperatures to the snow melt area are achieved. Following are some of the most common options used to achieve the design supply temperature to a snow melt system:

- **Mixing Valve** – A mixing valve is controlled by an electronic actuator that receives a signal from a reset control. This control varies the temperature being supplied to the manifold by adjusting the amount of hot supply or cold return water that is permitted to flow through the valve. To optimize the performance of the mixing valve (accurate mixing and reduced head), select a mixing valve with a Cv rating that is as close as possible to the design flow through the valve. For snow melting applications, required flow rates may approach levels that trigger specification of large-diameter mixing valves. The reason for selecting a larger mixing valve in these applications is to maintain acceptable pressure drops through the valve. Select a mixing valve size based on Table 5-15. See Section 5.6.2 for more information on calculating the pressure drop associated with valves.

Viega's 3-Way Valves		
Size	Connection	Flow
¾"	NPT	5
1"	NPT	12
1¼"	NPT	19
1½"	NPT	29
2"	NPT	47

Viega's 4-Way Valves		
Size	Connection	Flow
¾"	NPT	7
¾"	Copper	3
1"	NPT	12
1"	Copper	7
1¼"	NPT	19
1¼"	Copper	14
1½"	NPT	29
2"	NPT	47

- **Diverting Valve** – A diverting valve is controlled by a non-electronic actuator that sends out a fixed water temperature. This control maintains a fixed water temperature by adjusting the volume of return water being diverted back into the supply stream.
- **Injection Mixing** – This variable temperature control option uses either a single-speed or variable-speed injection circulator that receives a signal from a reset control to vary the volume of hot water injected into secondary piping. These small injected amounts of hot water mix with the water in the secondary piping, increasing the temperature as needed. One advantage to using an injection mixing system is that a large amount of Btus can be carried using a relatively small diameter and a low-wattage circulator. Injection mixing can be a good solution on large systems with high flow requirements, since specifying a circulator instead of a mixing valve can avoid the extra head from the mixing valve. Remember, when selecting mixing balancing valves, choose valves with a high Cv rating. For mixing valves, select a valve with a Cv rating that is as close as possible to the design flow rate through the valve. This will optimize performance of the valve (good control at reduced head).
- **Modulating Heat Source** – The heat source is controlled by a reset control to vary the supply water temperature based upon the outdoor and/or indoor temperatures, thus potentially eliminating the need for additional mixing devices. Depending on the heat source type and manufacturer, modulation methods may vary. Multiple temperature systems may require secondary mixing in addition to boiler modulation. Based on large heat load requirements for snow melting systems, most snow melt systems will require a dedicated boiler. If low return water temperatures and high slab water temperatures are a concern, additional controls and mixing devices may have to be added.

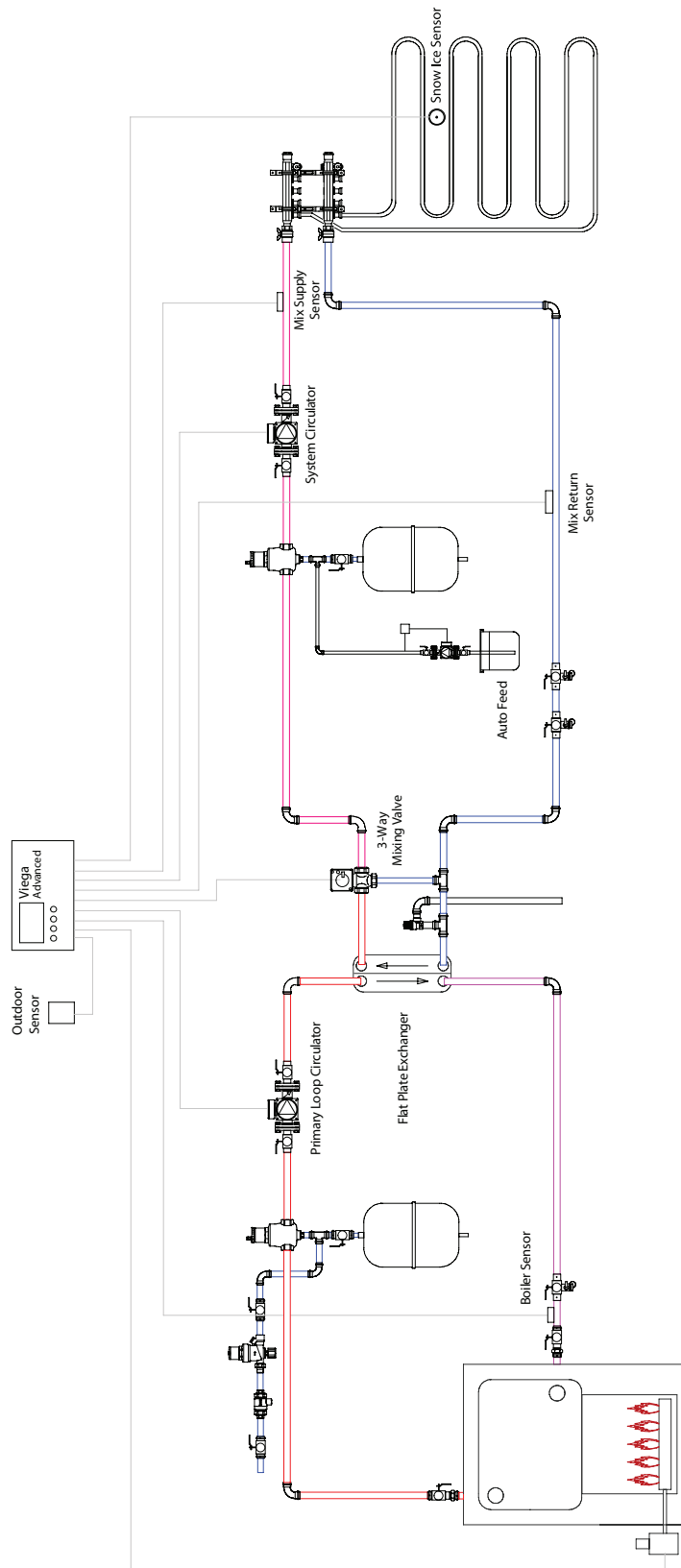
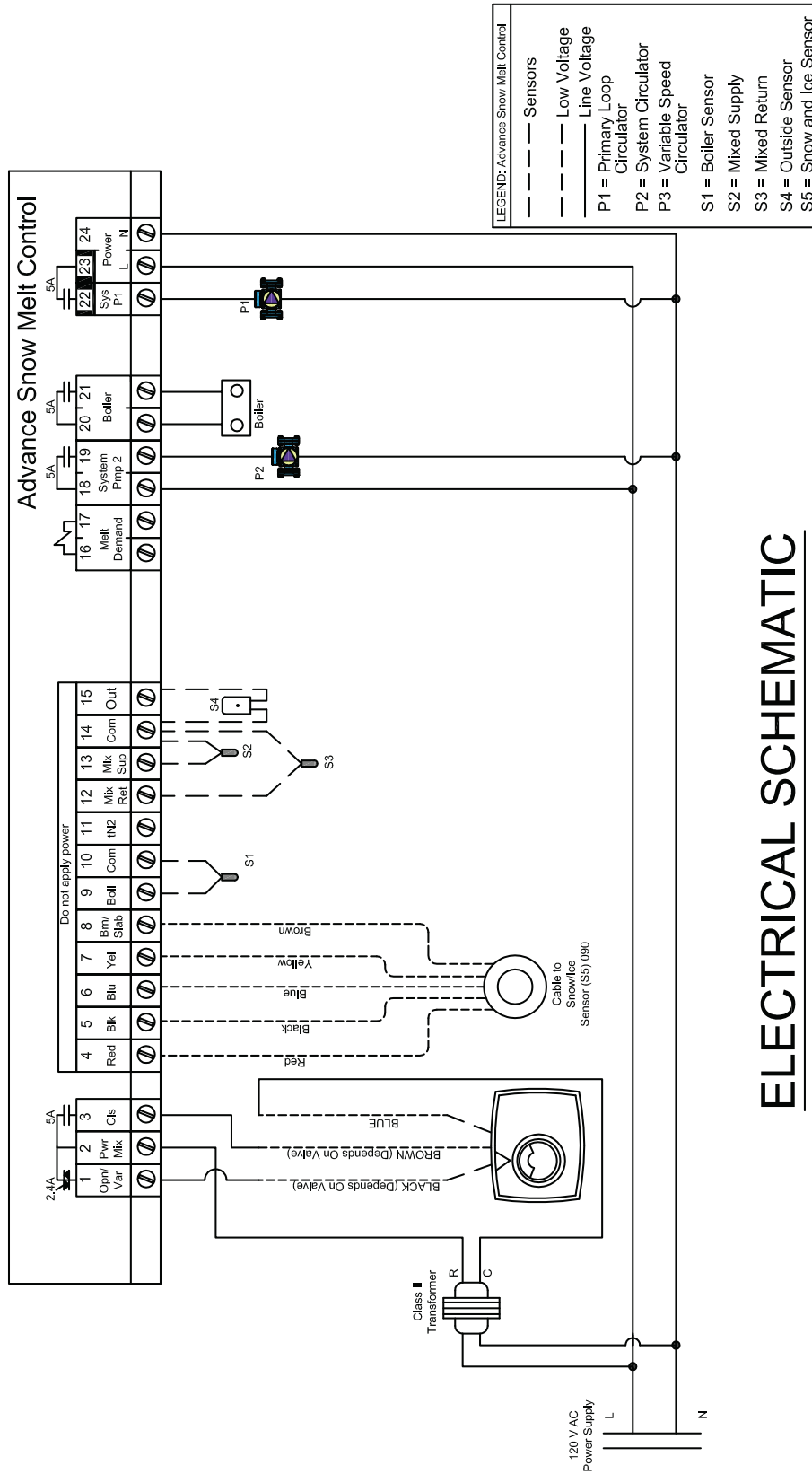


Figure 5-4 Piping diagram for typical application of a three-way mixing valve with electronic actuator. This diagram is representative only.



# ELECTRICAL SCHEMATIC

Figure 5-5 Wiring diagram for three-way mixing valve with electronic actuator

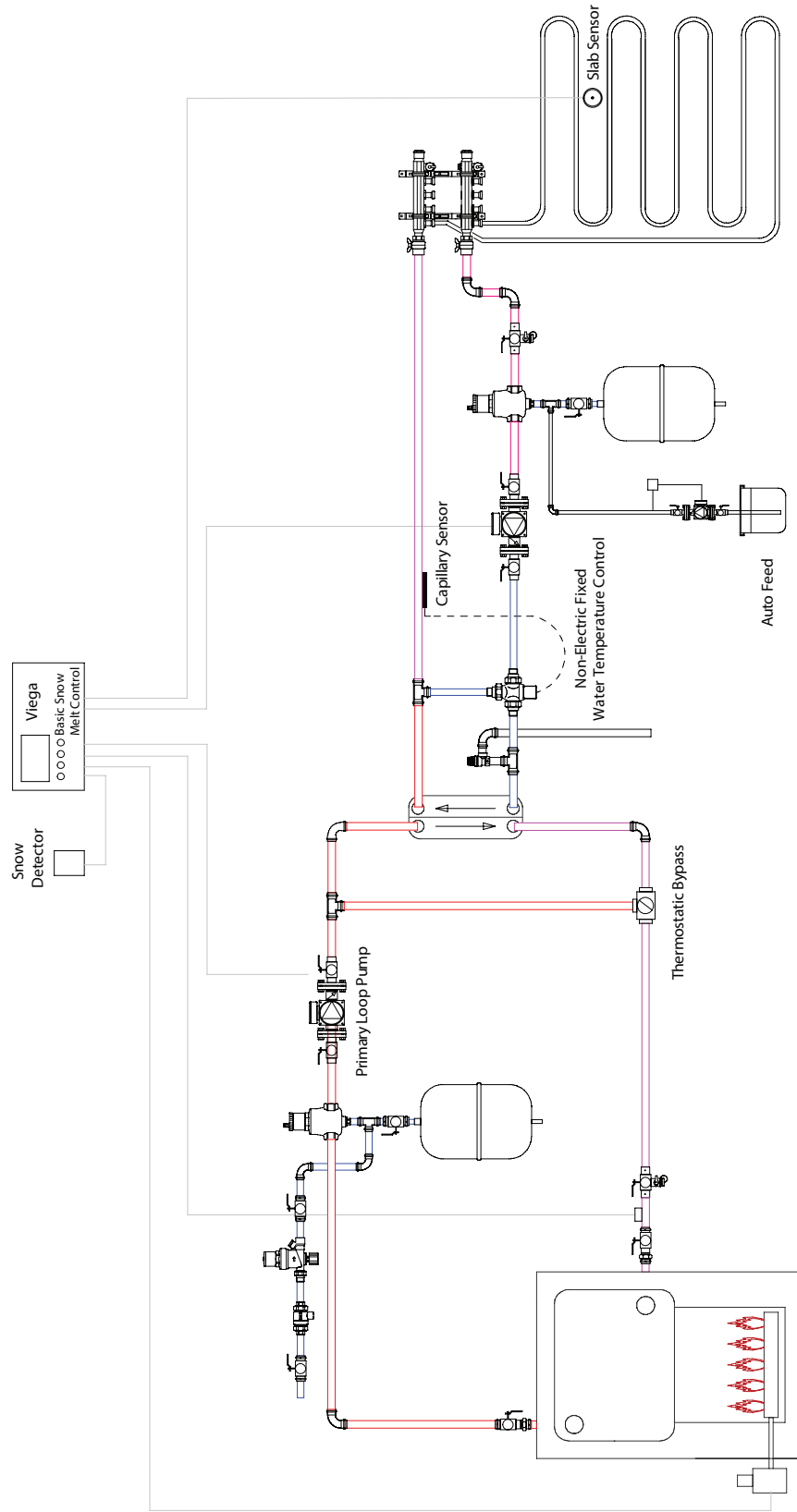


Figure 5-6 Piping diagram for diverting valve with non-electric control



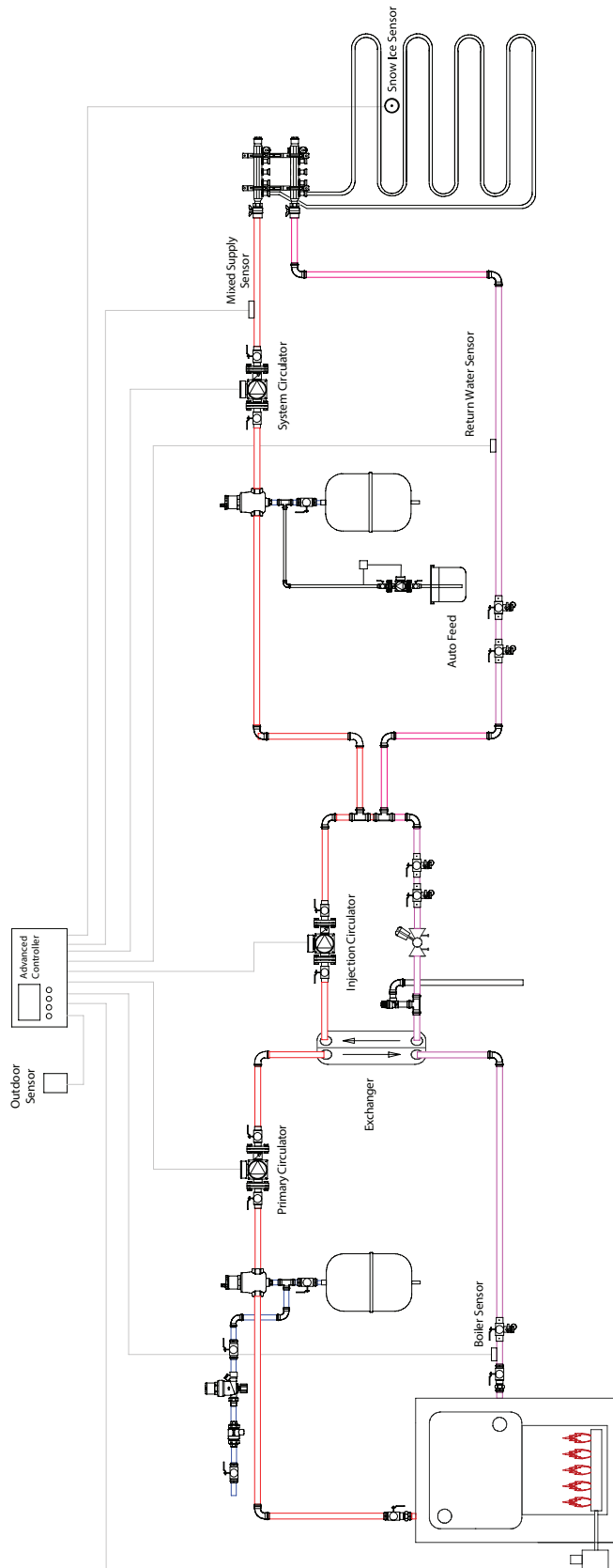
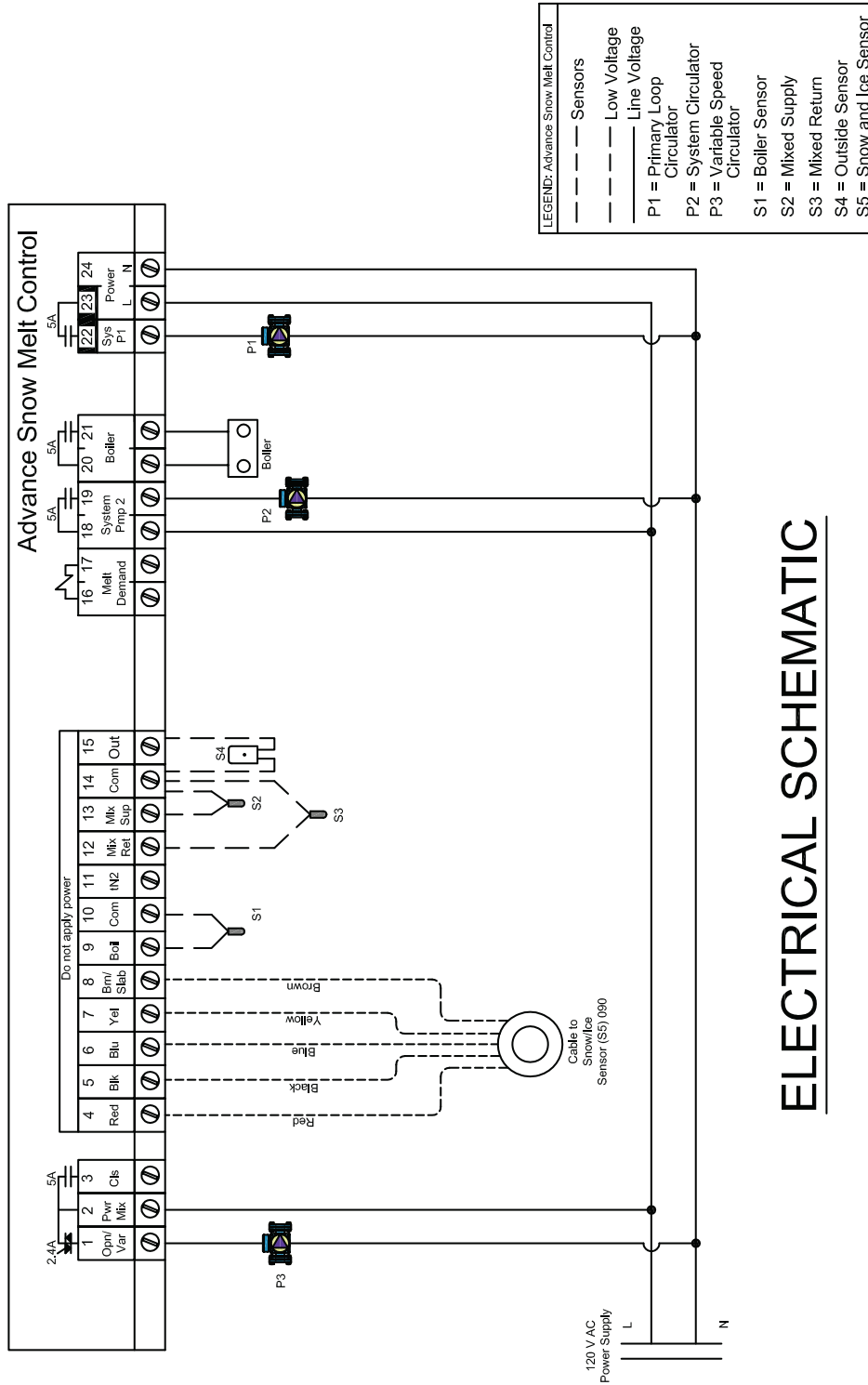


Figure 5-7 Piping diagram for typical injection mixing application with electronic control



# ELECTRICAL SCHEMATIC

Figure 5-8 Wiring diagram for an injection mixing valve

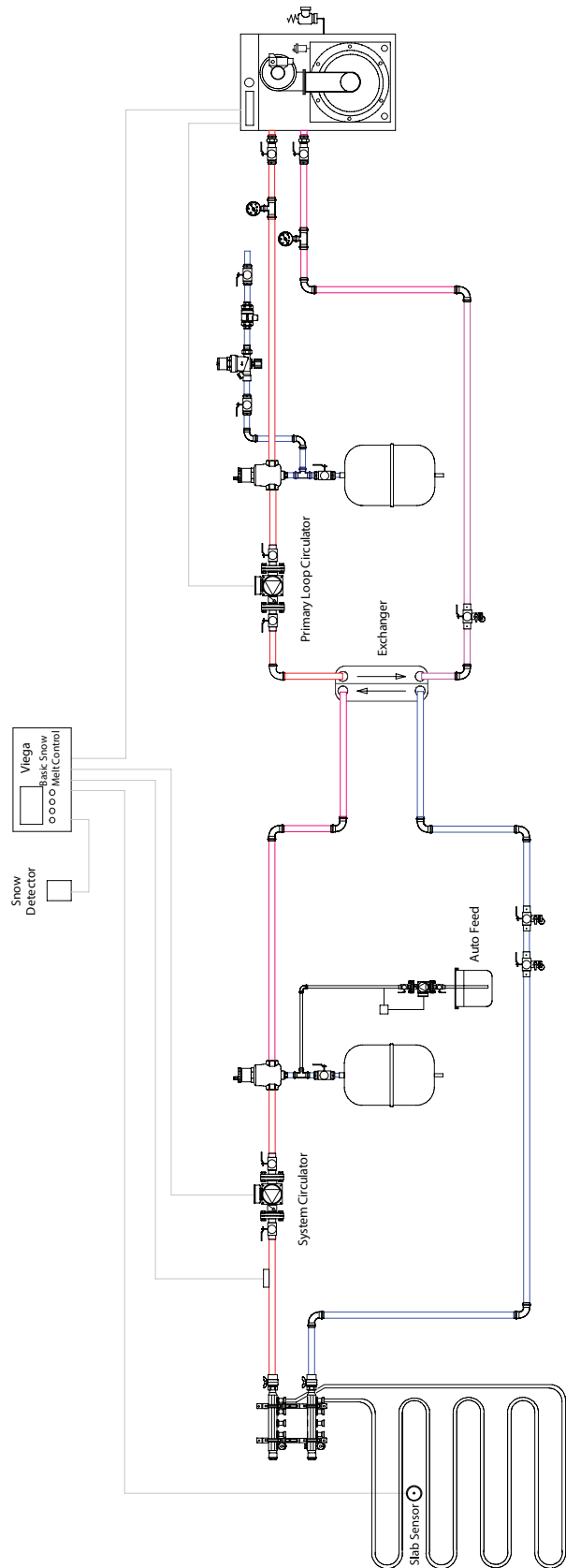


Figure 5-9 Modulating heat source

### 5.11.3 Selecting a heat exchanger

For systems that employ a heat exchanger, Viega's heat exchangers are very cost effective in snow melt systems and provide high outputs, fast response and separation of the fluids.

Use the following procedure to select a heat exchanger for a snow melt system. Procedure:

1. Determine the total Btu/hr required for the snow melt system.

2. Select the appropriate heat exchanger model from the table, based on the total Btu/hr required.
3. Check the total gpm required. If the gpm requirement of the snow melt system is greater than the gpm listed in the selection table, select a larger model to match the gpm and pressure drop needs, or install a bypass balancing valve. This will allow full flow and optimum pressure drop for the pump. This applies to the gpm on both boiler and glycol sides.

For snow melt system, 100°F in - 130°F out (40% P.G.) Connected to boiler, 180°F supply - 150°F return					
Viega Model	BTUH	Side A Boiler		Side B Snow Melt Circuit	
		GPM	PD (psi)	GPM	PD (psi)
22006 (¾" MPT)	125,000	8.6	2.9	9.0	3.1
22007 (1" MPT)	250,000	17.2	2.2	18.0	2.7
22008 (1¼" MPT)	500,000	34.4	2.8	36.1	3.6

Table 5-18

### 5.11.4 Control hardware

Viega provides a Basic Snow Melt Control and an Advanced Snow Melt Control. Select one of these controls based on the guidance in this section.

#### Basic Digital Snow Melt Control II

The Basic Digital Snow Melt Control II is typically used in small- to medium-size residential areas, driveways, walkways, patios and steps. The Basic Digital Snow Melt Control II is recommended under the following conditions:

- Economical system required
- Snow sensor cannot be mounted in thermal mass

#### NOTE:

Snow sensor should be located outside of slab in landscape area.

Features include:

- Automatic snow melt activation
- Slab high-limit
- Senses air temperature
- Senses falling snow
- Timer switch for manual override activation

#### Advanced Snow Melt Control

The Advanced Snow Melt Control is typically used in medium- to large-size residential, commercial and industrial areas, building entrances, parking ramps and lots, and emergency entrances. Use this control when accurate ice and snow detection is required. Features include:

- Slab protection (The control limits the rate at which heat can be applied to the slab through the ΔT Max setting.)
- Boiler protection
- Idling capability
- Cold weather cut-out
- Variable speed injection pump or floating action

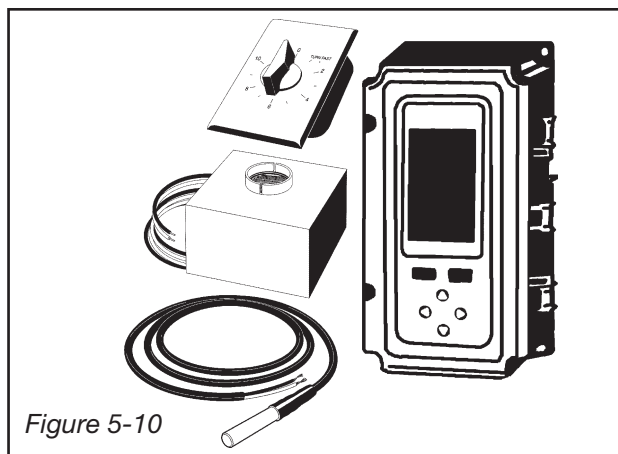


Figure 5-10

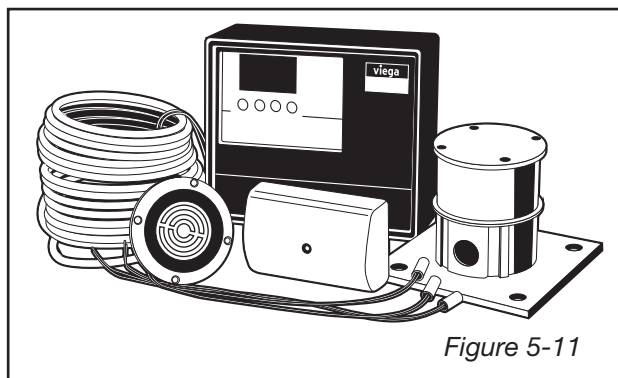


Figure 5-11

## 5.12 Planning and installation

### 5.12.1 Creating a material list

Use this worksheet to make an initial material list for the amount of tubing and fasteners needed. Then select one worksheet below to create a piping and control material list. These charts are intended for conceptual purposes; there may be variations in each job.

Equation: Snow melt area x multiplier = estimated amount

Example: For a snow melt area of 500 ft<sup>2</sup> with tubing at 9" spacing, the estimated amount is 500 x 1.5 = 750 ft. The fasteners required for the same area at 9" spacing are found as 500 x 0.75 = 375 pieces.

The number of circuits in the area will be covered in the following section. Installer's preference determines the choice of fasteners. (Use plastic zip ties for 3/4" tubing.)

Tubing (1/2" 5/8" 3/4")	Snow Melt Area (ft <sup>3</sup> )	Multiplier	Estimated Amount
6" Spacing		2.2	
9" Spacing		1.5	
12" Spacing		1.1	

Fasteners	Snow Melt Area (ft <sup>3</sup> )	Multiplier	Estimated Amount
6" Spacing		1.1	
9" Spacing		.75	
12" Spacing		.55	

*Table 5-19 Snow melt material list worksheet.  
Plastic fasteners that are supplied by Viega include zip ties, foam staples and U-channels.*

### 5.12.2 Layout planning

To avoid waste and to have equal circuit lengths, a carefully planned layout should be done. First, determine where the manifold should be installed. Remember the manifold must be accessible. When calculating the number of circuits, always round up. Keep the length of each circuit the same in the snow melt area.

Tubing Size	Max. Circuit Length (ft)
5/8"	200
3/4"	300

*Table 5-20 Maximum circuit lengths*

#### Maximum loop lengths

(CSA B214 Table 3)

Size mm (in)	Average active loop, m (ft)	Total loop m (ft)
PEX tubing		
16 (5/8)	68.6 (225)	76.2 (250)
19 (3/4)	91.4 (300)	99.1 (325)
25 (1)	137.2 (450)	144.8 (475)

*Table 5-21 Loop lengths for snow melt systems  
(See Clause 17.4.3.2)*

#### NOTES:

- 13 mm (1/2") tube should not be used. The total PEX loop lengths consist of two separate sections, the active loop and the leader length. The active loop is installed within the heated slab. The leader length is the total distance to and from the manifold and heated slab, including any vertical distances.
- The manifolds should be installed as close to the snow melt area as possible.

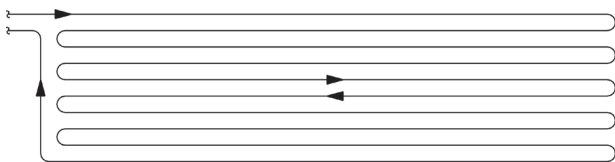
(CSA B214, Clause 17.4.3.2)

The maximum length of continuous tubing from a supply-and-return manifold arrangement shall not exceed the lengths specified by the manufacturer or, in the absence of manufacturer's specifications, the lengths specified in Table 3. Actual loop lengths shall be determined by spacing, flow rate, temperature and pressure drop, as specified in the system design.<sup>38</sup>

38. ©CSA Group, B214-12. 2012. "Installation Code for Hydronic Heating Systems" Table 3, Clause 17.4.3.2

Calculating number of circuits:  
 Total amount of tubing ÷ maximum circuit length =  
 # of circuits

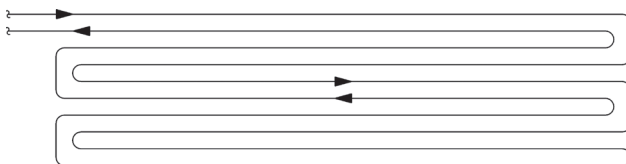
Serpentine  
 Used in level I and II applications



**Figure 5-12a**

Reverse return  
 Level I and II optional, recommended for Level III applications.

This pattern distributes heat more evenly and allows a lower thermal stress than a serpentine pattern. The reverse return installation procedure is more difficult and more time consuming than that of the serpentine pattern.



**Figure 5-12b**

When the tubing is installed within concrete, minimize penetration of joints. Any tubing that passes through expansion joints must be protected with protection sleeve for a minimum of 6" (15 cm) on both sides of the joint.

### 5.12.3 Installation

#### Step 1. Installing the Insulation

Insulation improves a snow melting system by decreasing the system's response time, downward heat loss and energy costs. When using foam board to insulate under slabs, weigh down the boards to prevent wind uplift. In some jobs this can be done by installing wire mesh as soon as foam boards are placed.

- Final grade should be accurately leveled.
- Cover grade with a polyethylene film (6 mil. minimum). This step is not recommended for paver or other porous surface applications.
- Install minimum R-5 insulation rated for required compressive strength and moisture resistance. Check local codes for additional requirements. **NOTE:** Outside of the heated surface area, insulate all supply and return lines with pipe insulation.

### 5.12.4 Slab joint tube protection

(CSA B214, Clause 17.4.4.2)

The tubing at the location of a control, expansion or construction joint in a concrete slab shall be protected by

- (a) a rigid sleeving material that covers the tubing for at least 300 mm (12 in) on either side of the joint;
- or
- (b) dipping the tubing below the slab.

Tubing installed below control joints in concrete slabs shall be secured at points 150 mm (5 in) on each side of the control joint.

#### Insulation

(CSA B214, Clause 17.4.4.4)

When a poured concrete snow melt system is installed in contact with the soil, insulation that complies with Clause 14.4.4.3 and has a minimum RSI value of 0.9 m<sup>2</sup>•K/W (R-value of 5 h•ft<sup>2</sup>•°F/Btu) shall

- (a) be placed between the concrete and the compacted grade;
- (b) extend as close as practical to the outside edges of the concrete; and
- (c) be placed on all vertical slab edges that are in contact with plants or landscaping.<sup>39</sup>

39. ©CSA Group, B214-12. 2012. "Installation Code for Hydronic Heating Systems" Clauses 17.4.4.2, 17.4.4.4

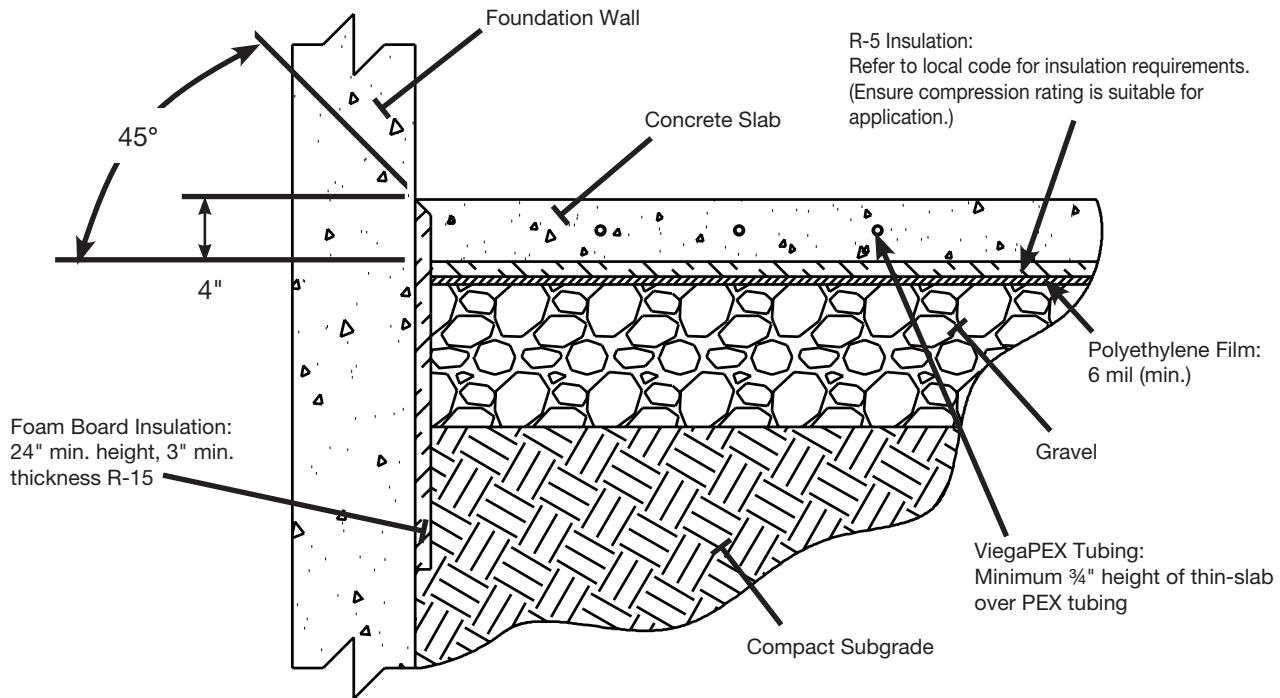


Figure 5-13 Cross section of insulation under concrete slab with snow melt

Step 2. Installing the tubing

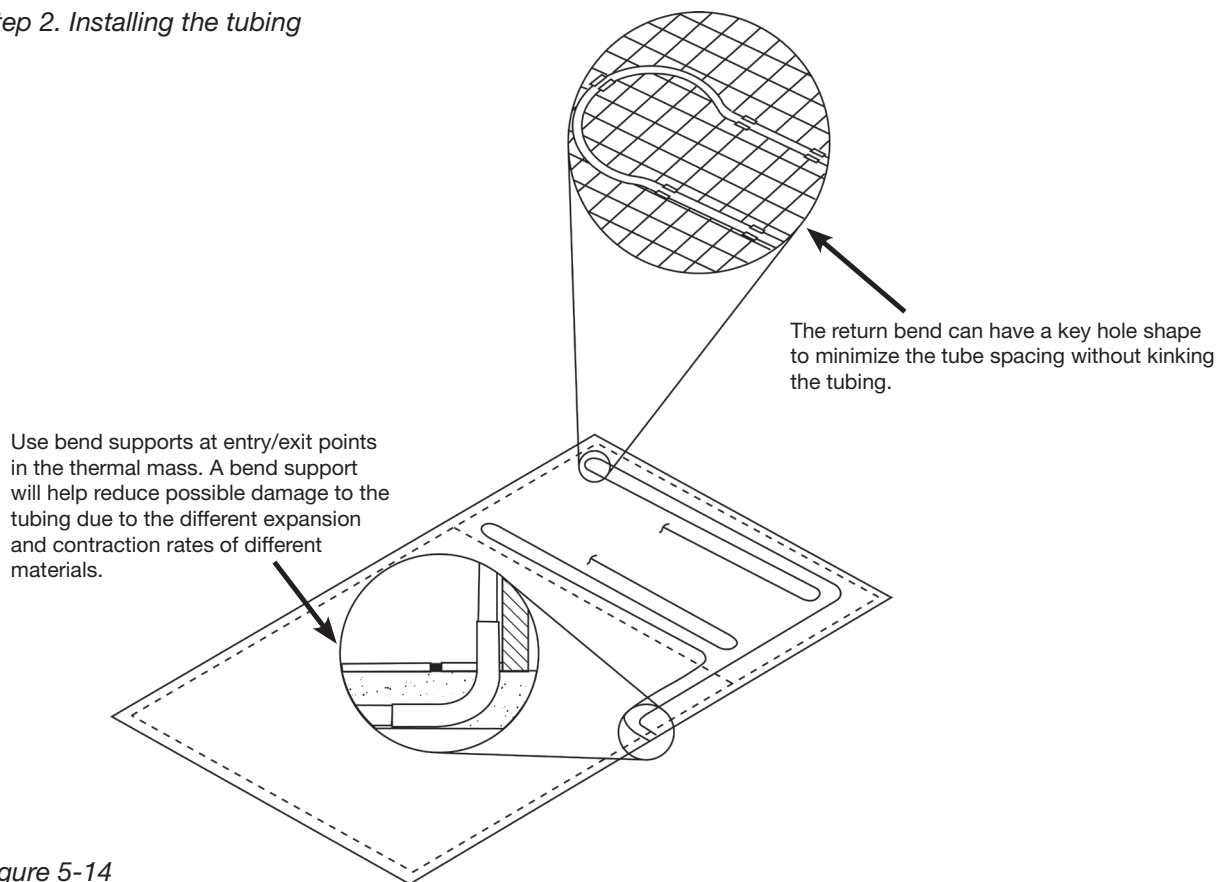


Figure 5-14

Special considerations for stairs and grades are given below.

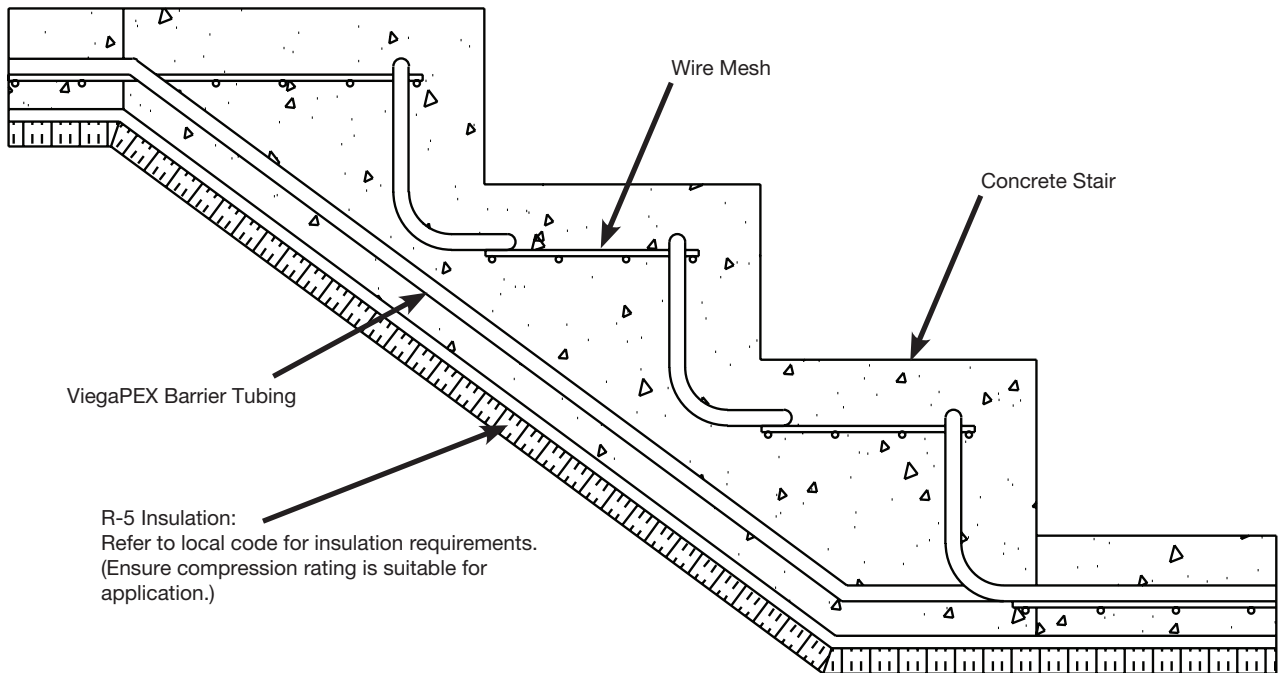


Figure 5-15a Section through concrete stairs

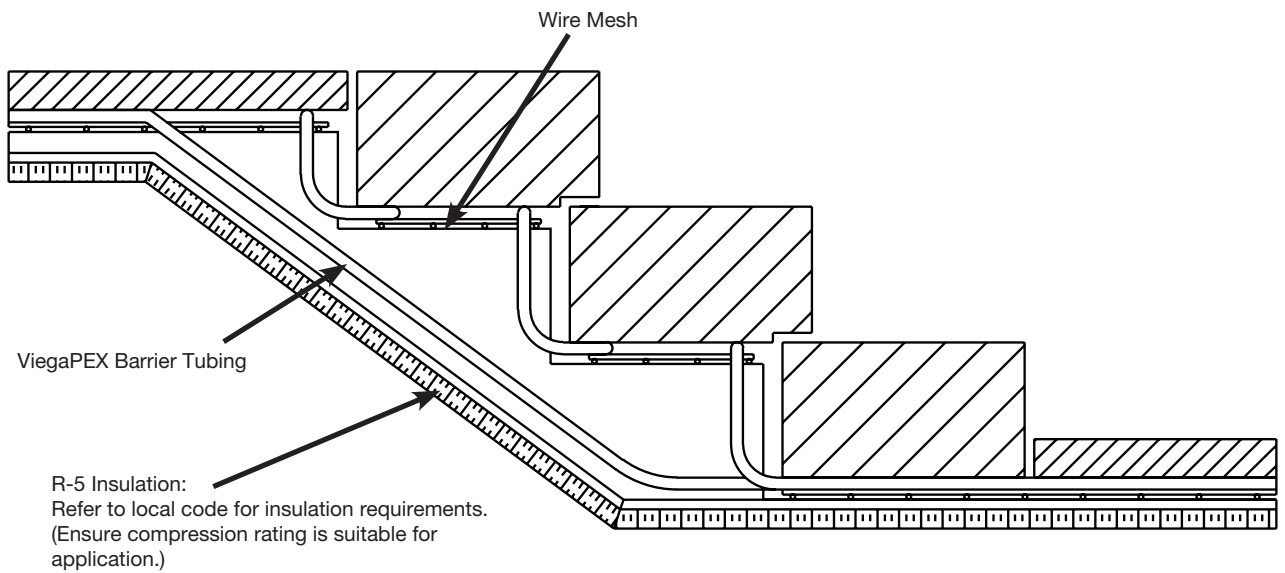


Figure 5-15b Section through stairs



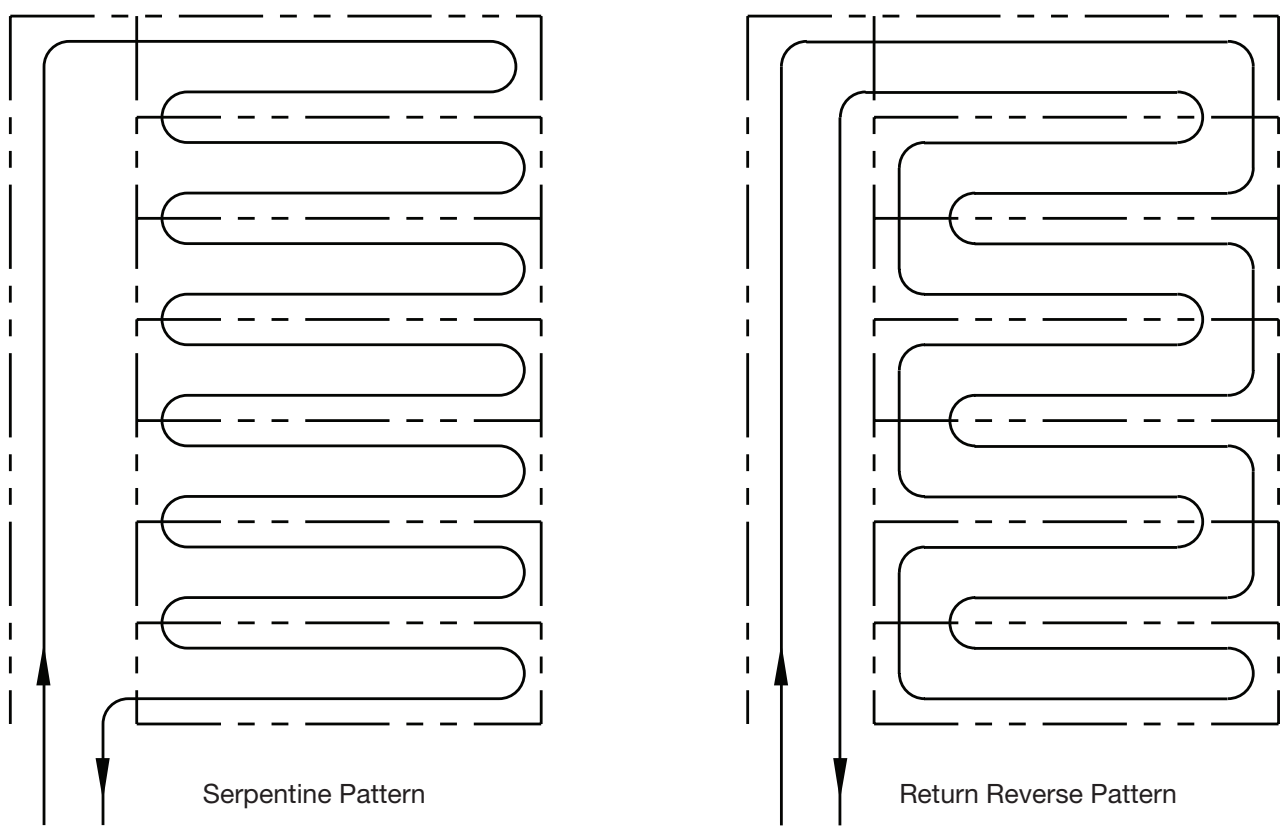
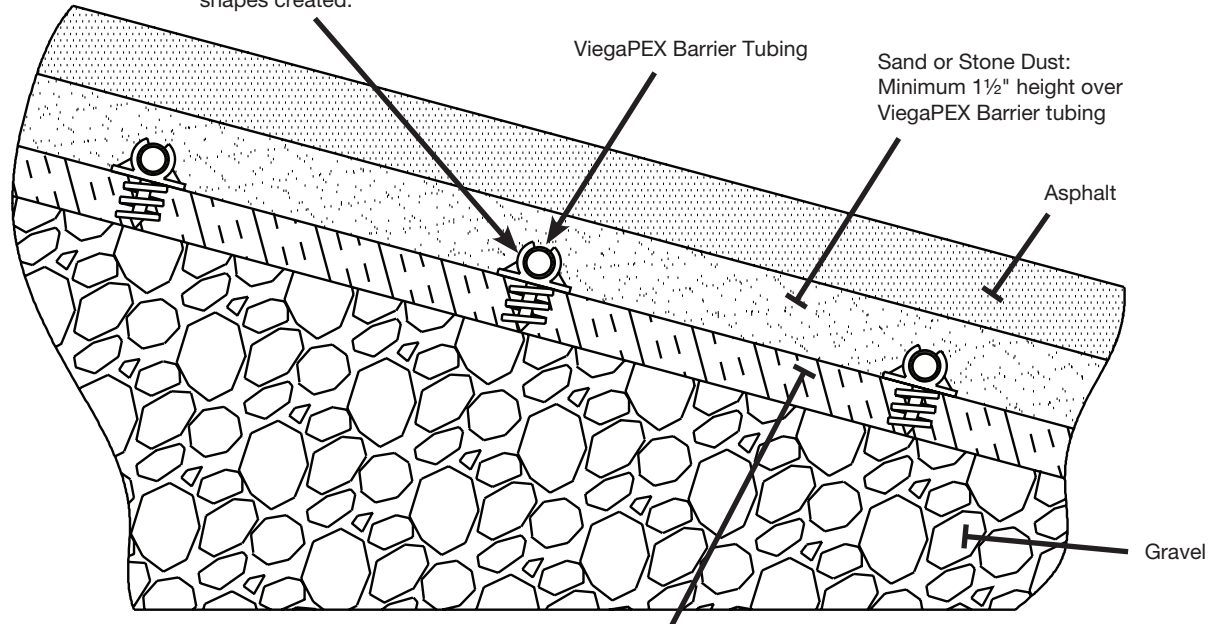


Figure 5-15c Stairs -- plain view

Plastic Clip for Foam Board:  
Fasten tubing every 2 feet and 3 times at each U-turn to hold down any return or other shapes created.



R-5 Insulation:  
Refer to local code for insulation requirements. (Ensure compression rating is suitable for application.)

Figure 5-15d Section through asphalt slope

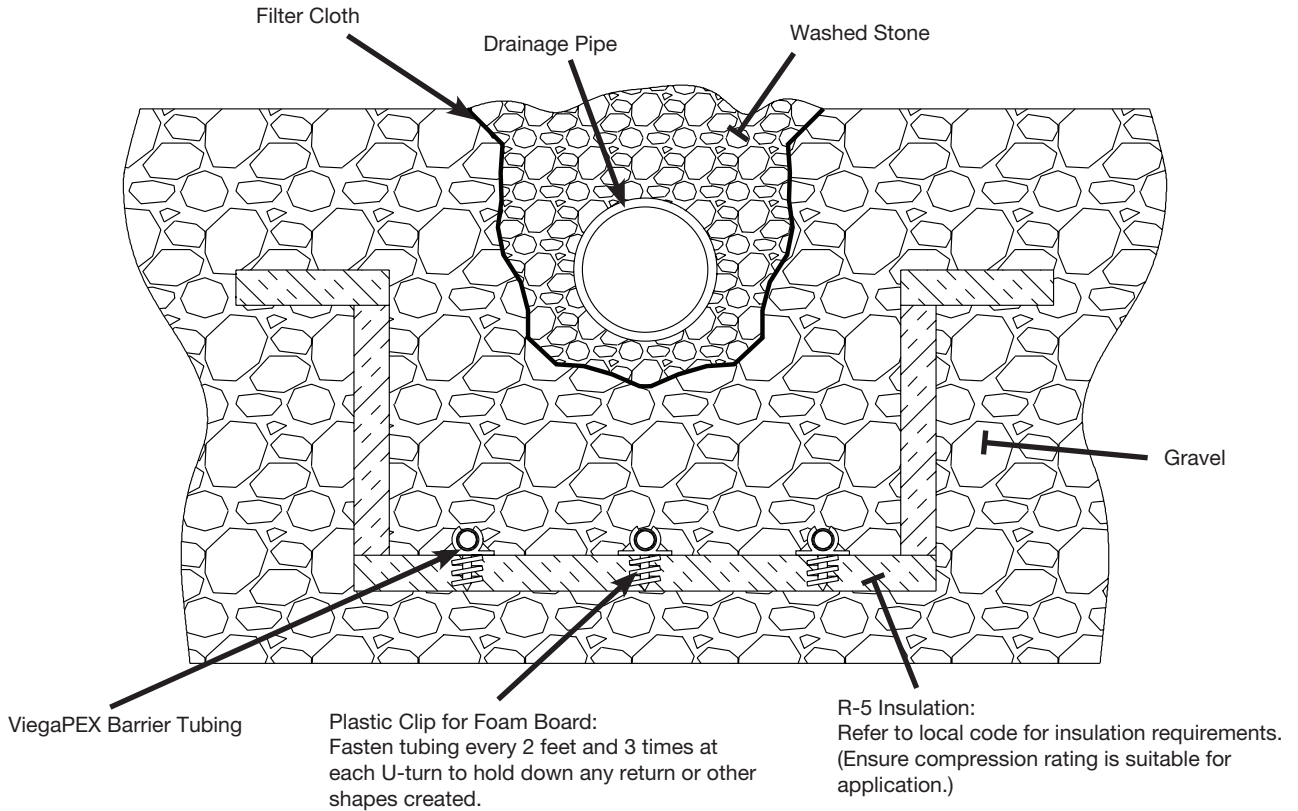


Figure 5-15e Section through drainage

### 5.13 Startup

Once the snow melt system is installed, startup involves the following steps:

1. Perform pressure test on ViegaPEX Barrier tubing. Ensure that no leaks are present. Repair if necessary and retest.
2. Disconnect any temporary manifold(s); then mount new permanent manifold(s) and connect tubing. Ensure that the supplies and returns are connected to the corresponding manifold ports. Label circuits if they are serving different locations within the system.
3. Connect boiler supply and return piping to manifolds as well as installing any additional components (mixing devices, purge assembly, isolation valves, circulators, etc.).
4. Prior to purging secondary piping, manifolds and circuits, ensure that the boiler and associated primary piping have been purged of all air.
5. Purge manifolds and circuits according to manufacturers' instructions. Refer to PI (product information) sheets for copper manifolds.
6. Ensure that all electronic components have been wired as per manufacturers' instructions. Refer to PI sheets for controls, etc.
7. Utilize controls to activate system circulator(s) and relevant heating source(s). Ensure that heating supply temperature increases and that piping is not reversed.
8. Run boiler up to maximum supply temperature to ensure proper function of internal temperature controls.
9. Set mixing devices according to manufacturers' instructions. Refer to PI sheets for mixing valves.
10. Check that the controls are working properly. Refer to manufacturers' control instructions for more information (including but not limited to snow melt controls, pumps, mixing valves, etc.).
11. Ensure proper balancing of all circuits according to completed design calculations. Refer to PI sheets for instructions.

General information on these individual steps is provided in the following sections. For product-specific information, consult manufacturers' instructions (e.g., Viega PI sheets).

### 5.13.1 Pressure testing, filling and purging

#### Pressure testing

When conducting pressure testing, air or water may be used as the medium. To simplify leak detection if tubing is damaged, pressure should be maintained during the installation of the surface to be heated (whether concrete, asphalt, pavers, etc.).

The following pressure testing procedure is recommended by Viega. Check the local building codes for compliance or additional test requirements.

1. Double-check all connections to manifold to ensure proper seal.
2. Connect manifold pressurization kit (1) to any drain valve (2).
3. Pressurize the system to 100 psi to detect potential nail or screw penetrations.
4. The system should hold the 100 psi for a minimum of 1 hour prior to the installation of the tubing covering or slab. Note that the gauge will fluctuate to some extent with temperature change, with lower pressures expected as temperatures decrease.
  - For in-slab applications, retighten any tubing couplings located in the slab area after at least 12 hours of system pressurization. Maintain and monitor pressure until concrete has adequately cured.

**NOTE:** If the tubing becomes damaged during the installation, remove the damaged section of tubing and replace with repair coupling(s). After making an in-slab repair, be sure to protect the fitting(s) with repair coupling wrap prior to concealing the connection. See Appendix B.

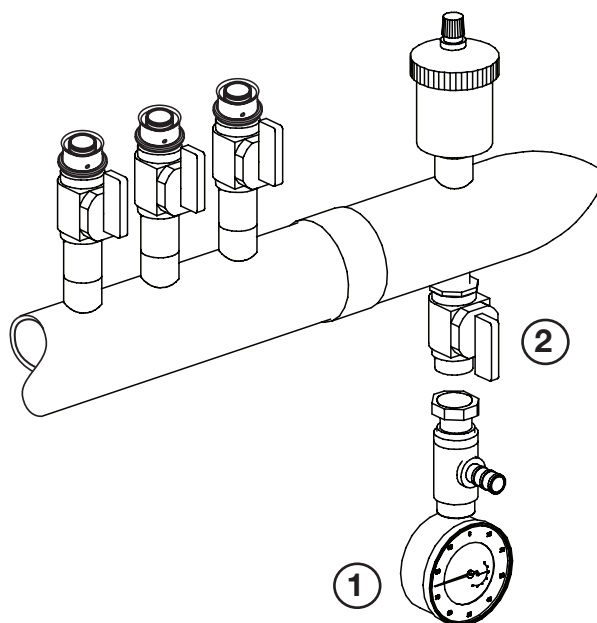


Figure 5-16 Copper Manifold with manifold pressurization kit (1) and drain valve (2)

#### Filling

The percent glycol solution will affect supply temperature, heat output, expansion tank size and circulator operation, so ensure that filling is done accurately. First, figure the capacity of the entire system in gallons to determine the required amount of glycol (% volume solution) from:

- Tubing (refer to data table)
- Boiler (from manufacturer)
- Additional tanks or reservoirs (from manufacturer)

Before injecting the glycol solution, thoroughly clean and flush the system.

The solution can be mixed outside the system in drums or barrels and then pumped in using a fill and purge kit (Figure 5-17) or some other suitable method.

- Mix solution at room temperature using water that is soft and low in chloride and sulfate ions.
- Watch air vents during filling to prevent loss of solution.
- To avoid dilution, the system and the cold water supply should not be permanently connected (so automatic fill valves are usually not used).

Size (in.)	O.D. (in.)	I.D. (in.)	Water Content (Gal/ft)
1/2	0.625	0.475	0.009
5/8	0.750	0.574	0.014
3/4	0.875	0.671	0.018
1	1.125	0.862	0.030

Table 5-22 ViegaPEX Barrier and FostaPEX tubing specifications

A system uses 10,000 ft of 5/8" ViegaPEX Barrier tubing and has 30 gallons of volume within the boiler and additional tanks and reservoirs.  
Water content:  $10,000 \times 0.014 + 30 = 170$  gal

% glycol mixture selected is 40%  
Glycol gallons required:  $0.40 \times 170 = 68$  gal

#### Purging

Once the pressure test has been successfully completed and the system is filled with glycol solution, follow these steps to purge the system.

1. Remove the high-limit from any mixing valve. The high-limit can be reinstalled and reset after the purge is complete. For instructions on setting the high-limit, see Section 4.2.3.
2. Close isolation ball valves on supply and return headers.
3. Connect fill hose/purge kit to drain valve on supply header.\*
4. Attach a drain hose to the return header drain valve.
5. Open drain valve on supply header to start water flow into supply header.
6. Once purge and fill for first circuit is complete, close circuit shutoff valves on supply and return headers.
7. Repeat steps 4 and 5 for each additional circuit, one at a time.
8. Once last circuit is purged and filled, close last circuit shutoff valve.
9. Open all circuit shutoff valves on supply and return headers.
10. Close drain valve.

**NOTE:** If the system must be purged again in the future for any reason, the high-limit must be reopened during purging for full flow.

\*Use of a fill and purge kit is recommended for snow melt systems. Building a fill and purge kit will allow the fill and purge process to be quick, efficient and easy. Figure 5-17 shows an economical kit (parts supplied by others).

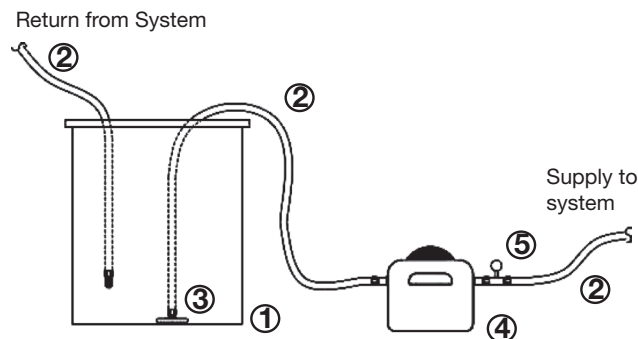


Figure 5-17 Example of a fill and purge kit

- Kit consists of:
- 1) Barrel (~35 gal)
  - 2) Double female hoses
  - 3) Foot valve
  - 4) Transfer pump
  - 5) Pressure gauge

#### 5.13.2 Initial Balancing

If the snow melt circuits are of different lengths, the system should be balanced in order to provide adequate flow to each circuit. Refer to your design for detailed balancing flow rates. Procedure:

##### Balancing Circuits

It is important to balance the circuits on the manifolds to ensure even distribution of the radiant heating. The fluid (water and glycol mix) flows in the path of least resistance. Longer circuit lengths cause higher pressure drops (resistance). The shutoff/balancing valves can equalize the pressure drop (resistance) in every circuit. For proper balancing see calculations and diagrams on the following page.

Circuit	Circuit Length	Number of Turns Open to Set Memory Spindle
1	250'	250/250 x 10 = 10 turns (fully open)
2	200'	200/250 x 10 = 8 turns
3	150'	150/250 x 10 = 5 turns
4	100'	100/250 x 10 = 4 turns

\* The number of full 360° turns open from a fully closed position

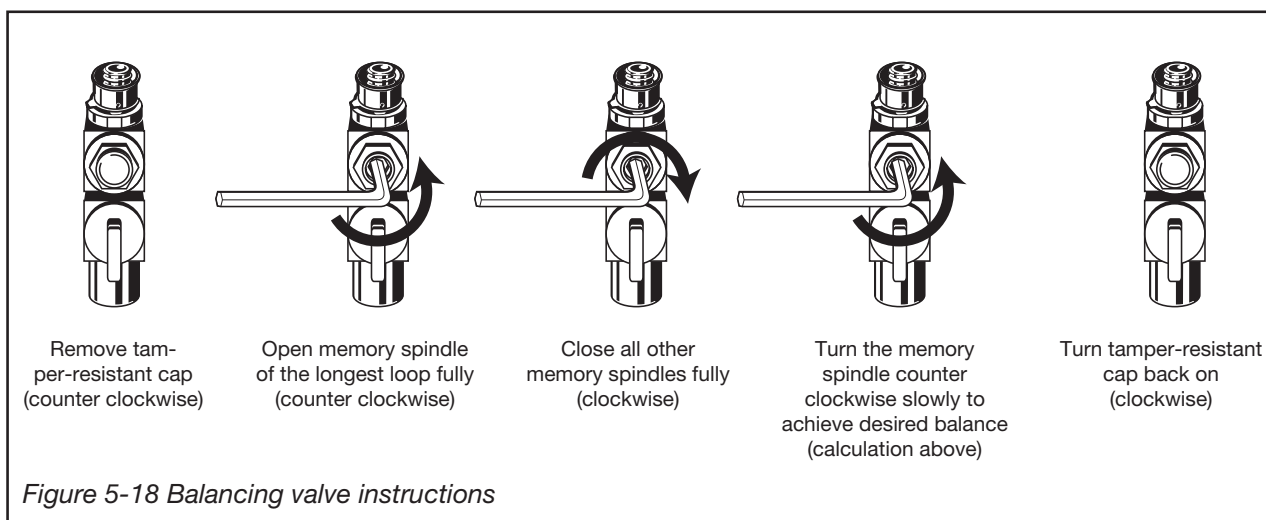
Circuit 1 is the longest at 250', so it is fully open (counter clockwise). Circuit 2 is 200', so divide 200' by 250', which equals 0.8. Then multiply 0.8 by 10, and the answer is 8. This represents the number of 360° turns open needed for proper balancing (counter clockwise).

$$\frac{\text{Circuit Length (ft)}}{\text{Longest Length (ft)}} \times 10 = \text{\# of Turns for Balancing*}$$

**NOTE:** Each 360° turn of the memory spindle restricts approximately 10% of flow.

### 5.14 Maintenance

Glycol solutions should be checked each year using a suitable refractometer to determine glycol concentration. Check the concentration of corrosion inhibitor periodically, following procedures recommended by the glycol manufacturer. Typically, glycol manufacturers offer a maintenance service for a reasonable cost.



## ViegaPEX Barrier Tubing


### Scope

This specification designates the requirements for ViegaPEX Barrier cross-linked polyethylene (PEX) tubing for use in hydronic heating and cooling systems. ViegaPEX Barrier includes an oxygen barrier layer that helps restrict the passage of oxygen through the wall of the tubing. All ViegaPEX is manufactured and tested to the requirements of ASTM F876, F877, CSA B137.5 and is CTS-OD (copper tube size outer dimension controlled) with an SDR - (standard dimension ratio) 9 wall thickness. ViegaPEX Barrier is compatible with both ViegaPEX Press fittings and F1807 PEX Crimp fittings. Viega has no control over the quality of other manufacturers, therefore, we do not extend any warranty to those components that are not supplied by Viega.

### Materials

ViegaPEX Barrier tubing is produced from cross-linkable, high-density polyethylene resin. This cross-linkable resin is produced by grafting organosilane molecules onto a base polyethylene chain. A catalyst that initiates the cross-linking process is blended with the resin before extrusion. Cross-linking is conducted after extrusion by exposing the tubing to heat and moisture (steam). ViegaPEX Barrier includes four (4) layers. The first layer is cross-linked, high-density polyethylene. The second layer is an adhesive for the third layer, the ethylene vinyl alcohol layer (EVOH oxygen barrier). The fourth layer is another thin layer of polyethylene, applied on the outside to protect the EVOH layer from damage. EVOH is highly resistant to the passage of oxygen.

### Marking and Certification

Tubing is marked with manufacturer, ViegaPEX Barrier, nominal size, rating, codes and standards, approvals, date, material code and location of production (i.e., xxxxFT Viega ViegaPEX Barrier 1/2" SDR-9 CTS PEX5306 100 PSI @ 180F [cNSF@us-pw-rfh ASTM F876/F877 CSA B137.5] FS/SD 25/50 CAN/ULC S102.2  ICC ES-PMG™-1015/1038 HUD MR 1276 Date Code Material Code MADE IN THE USA 0005FT. Tubing is third-party tested to the requirements of the stated ASTM and CSA standards. Tubing includes incremental footage markings to assist with loop layout. ViegaPEX Barrier tubing is certified to NSF 61 and 14 for use as part of, or connected to, a potable water system.

### Recommended Uses

Install ViegaPEX Barrier in accordance with installation manuals provided by manufacturer and applicable code requirements. Water or air can be used to pressure test the system. Please follow manufacturer's requirements on pressure and length of time. ViegaPEX Barrier comes with a 6-month UV protection. For information on the suitability for other applications, contact your Viega representative.

### Handling and Installation

ViegaPEX Barrier tubing is recommended for hydronic radiant heating, cooling and snow melting systems using water or a water/glycol mix as the heat transfer media. Tubing may be installed in concrete, gypsum-based lightweight concrete, sand, asphalt (in accordance with special guidelines) in or under wood flooring or behind wallboard or plaster. ViegaPEX Barrier may also be used as transfer lines for baseboard heating systems with a maximum operating temperature of 200°F @ 80 psi.

Property	ASTM Test Method	Typical Values	
		English Units	SI Units
Density	D 792	-	0.952 g/cc
Melt Index <sup>1</sup>	D 1238	-	0.7g/10 min
Flexural Modulus <sup>2</sup>	D 638	150,000 psi	1000 MN/m <sup>2</sup>
Tensile Strength @ Yield (2 in/min)	D 638	3,900 psi	26 MN/m <sup>2</sup>
Coefficient of Linear Thermal Expansion @ 68°F	D 696	9.2 x 10 <sup>-5</sup> /°F	1.4 x 10 <sup>-4</sup> /°C
Hydrostatic Design Basis @ 73°F (23°C)	D 2837	1,250 psi	8.6 MPA
Hydrostatic Design Basis @ 180°F (82°C)	D 2837	800 psi	5.5 MPA
Vicat Softening Point	D 1525	255°F	124°C
Thermal Conductivity	D 177	2.7 Btu/hr/ft <sup>2</sup> /°F	1.1 x 10 <sup>-3</sup> cal/sec/cm <sup>2</sup> /°C

1. Before Cross-linking  
2. 73°F

## Quality Assurance

ViegaPEX Barrier tubing is manufactured and tested to the requirements of ASTM F876, F877 and CSA B137.5. The degree of cross-linking of finished tubing is determined by method ASTM D2765.

## Certifications

**NSF-pw** - Tested for health effects to ANSI/NSF standard 61 and performance to ANSI/NSF standard 14.

**NSF-rfh** - Products meet all applicable performance requirements for a pressure rated floor heating application specified in NSF/ANSI Standard 14.

**PEX 5306** - Tested and listed to the NSF-pw (CL5) Chlorine resistance rating for an end use condition of 100% @ 140°F per ASTM F876, which is the highest Chlorine resistance rating available through ASTM. When the product is marked with the PEX 5306 NSF-pw (CL5) designation, it affirms the product is approved for use in continuous domestic hot water circulation systems with up to 140°F water temperatures.



- IAPMO Certified



- ICC ES-PMG™ 1015 Hydronic Piping



- NSF certified to CSA B137.5 (Canadian Standards Association)



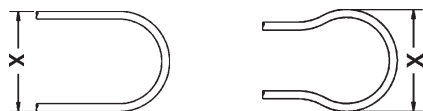
- Certified to ASTM E84 and CAN/ULC S102.2 FS/SD (25/50) (US & Canadian plenum rating)

- Certified to UL 263 & CAN/ULC S101 (US & Canadian Assembly Rating)

## Tube Spacing

When the tube spacing is less than the minimum recommended bending dimension, the loops ends should be swept out to at least the dimensions shown.

Otherwise, if tube spacing is equal or greater than “X,” a standard loop may be used.



Dimension X

Tubeing Size	With the Coil
5/16"	7"
3/8"	8"
1/2"	10"
5/8"	12"
3/4"	14"
1"	18"
1 1/4"	22"
1 1/2"	26"
2"	34"

## SDR-9 PEX Tubing ASTM F876/F877/CTS-OD SDR-9

Tubeing Size	O.D.	Wall Thickness	Nom. I.D.	Weight Per Ft	Vol. (gal.)/ 100 Ft
5/16"	.430±.003	.064+.010	0.292	.0340	0.34
3/8"	.500±.003	.070+.010	0.350	.0413	0.50
1/2"	.625±.004	.070+.010	0.475	.0535	0.92
5/8"	.750±.004	.083+.010	0.574	.0752	1.34
3/4"	.875±.004	.097+.010	0.671	.1023	1.82
1"	1.125±.005	.125+.010	0.862	.1689	3.04
1 1/4"	1.375±.005	.153+.015	1.053	.2523	4.52
1 1/2"	1.625±.006	.181+.019	1.243	.3536	6.30
2"	2.125±.006	.236+.024	1.629	.6026	10.8

NOTE: Dimensions are in English units. Tolerances shown are ASTM requirements. ViegaPEX is manufactured within these specifications.

ViegaPEX Barrier tubing is available in both straight lengths and coils.

## ViegaPEX Barrier Oxygen Permeation

All sizes have less than 0.1 gram/m<sup>3</sup>/day

Note: ViegaPEX Barrier tubing meets DIN 4726 requirements for oxygen tight pipes.

## Pressure Drop Table Expressed as psi/ft. SIZE

GPM	5/16"	3/8"	1/2"	5/8"	3/4"	1"	1 1/4"	1 1/2"	2"
.1	.002	.001							
.2	.009	.004	.001						
.3	.018	.008	.002	.001					
.4	.031	.013	.003	.001					
.5	.047	.020	.004	.002					
.6	.066	.027	.006	.003	.001				
.7	.088	.036	.008	.003	.002				
.8	.117	.047	.011	.004	.002				
.9	.156	.058	.013	.005	.002				
1	.206	.070	.016	.007	.003	.001			
1.5			.034	.014	.006	.002			
2			.058	.024	.011	.003			
3				.050	.023	.007			
4				.085	.039	.011			
6				.181	.082	.024			
8					.140	.041			
10					.211	.062	.023		
12					.296	.087	.032		
14							.042		
16							.053	.022	
18							.065	.027	
20							.078	.033	
22							.093	.039	
24							.108	.045	
26								.052	
28								.060	
30								.067	
32								.075	.021
34									.023
36									.026
38									.028
40									.031
45									.038
50									.046
55									.055
60									.064
65									.075
70									.085
75									.097

## FostaPEX High-Density Cross-linked Polyethylene (PEX)

### Scope

This material specification designates the requirements for Viega FostaPEX multilayer pressure pipe for hot and cold water distribution tubing and hydronic radiant heating applications. All FostaPEX tubing has a fully dimensioned inner PEX core to the copper tube size dimension (CTS), SDR-9 wall thickness and meets the respective requirements of ASTM Standard F876 and F877.

### Materials

The multi-layered construction of the FostaPEX tubing is made from one full dimensional inner PEX core with an aluminum and outer PE layer surrounding it. This construction allows the inner layer alone to meet all temperature and pressure requirements of the system. Using the prep tool to remove the outer layers allows the use of the standard PureFlow PEX Press fitting system.

### Marking and Certification

All FostaPEX tubing is marked with the name Viega as the manufacturer, nominal size, plastic tubing material designation code PEX 5006, Chlorine resistance rating NSF-pw (CL5), design pressure and temperature ratings, relevant ASTM standards, manufacturing date and production code, as well as the NSF-pw stamps indicating third-party certification by NSF International for meeting and exceeding performance and toxicological standards, as well as achieving the highest chlorine resistance rating in the PEX industry. NSF conducts random on-site inspections of Viega manufacturing facilities and independently tests FostaPEX tubing for compliance with physical, performance and toxicological standards. FostaPEX is also certified to meet the Uniform Plumbing Code, IAPMO UPC®, CSA (Canadian Standards Association) B137.5, the ICC (International Code Council) Evaluation Service, and HUD (Housing and Urban Development).

### Recommended Uses

FostaPEX tubing is intended and recommended for use in hot and cold potable water distribution systems and hydronic radiant heating and cooling systems. Like ViegaPEX Barrier, which has a barrier layer that resists the passage of oxygen through the wall of the tubing, the aluminum layer in FostaPEX offers even higher resistance to oxygen permeation in radiant heating applications. FostaPEX tubing can also be used in water service applications and is virtually impermeable to any soil contaminants. Design temperature and pressure ratings for FostaPEX are 160 psi @ 73°F, 100 psi @ 180°F, and 80 psi @ 200°F. For information on the suitability for other hot and cold water applications not listed here, consult with your Viega representative.

### Handling and Installation

FostaPEX cross-linked polyethylene tubing is tough yet flexible. The aluminum layer allows tubing to be bent into position and remain in position when released. However, use of these materials in hot and cold water distribution systems must be in accordance with good plumbing practices, applicable code requirements, and current installation practices available from Viega. FostaPEX is manufactured to meet written national standards. Contact a Viega representative or the applicable code enforcement bureau for information about approvals for specific applications.

Property	ASTM Test Method	Typical Values	
		English Units	SI Units
Density	D 792	–	0.944 g/cc
Melt Index <sup>1</sup> (190° C/2.16 kg)	D 1238	–	8.5g/10 min
Coefficient of Linear Thermal Expansion @ 68° F	D 696	1.3x10 <sup>-5</sup> in/in/°F	2.4x10 <sup>-5</sup> mm/mm/°C
Hydrostatic Design Basis @ 73°F (23°C)	D 2837	1250 psi	8.6 MPa
Hydrostatic Design Basis @ 180°F (82°C)	D 2837	800 psi	5.5 MPa

1. Before Cross-linking



### Quality Assurance

When the product is marked with the ASTM F876 designation, it affirms that the product was manufactured, inspected, sampled and tested in accordance with these specifications and has been found to meet the specified requirements.

### Certifications

**NSF-pw** - Tested for health effects to ANSI/NSF standard 61 and performance to ANSI/NSF standard 14.

**PEX 5006** - Tested and listed to the NSF-pw (CL5) Chlorine resistance rating for an end use condition of 100% @ 140°F per ASTM F876, which is the highest Chlorine resistance rating available through ASTM. When the product is marked with the PEX 5006 NSF-pw (CL5) designation, it affirms the product is approved for use in continuous domestic hot water circulation systems with up to 140°F water temperatures.



- **IAPMO Certified**



- **ICC ES-PMG™ 1038/1015**  
plumbing and heating systems



- **NSF certified to CSA B137.5**  
(Canadian Standards Association)

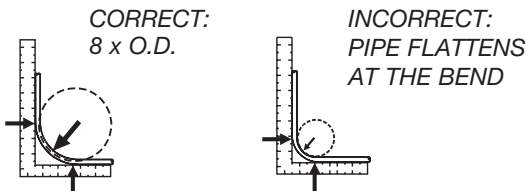


- **Certified to UL 263 & CAN/ULC S101**  
(US & Canadian fire resistance ratings)

- **Certified to ASTM E84 and CAN/ULC S102.2 FS/SD (25/50)** (U.S. & Canadian plenum rating)

**HUD** (Housing and Urban Development) - MR 1276

### Minimum Bend Radius



Note: FostaPEX tubing may be bent to a minimum of 3.5 x O.D. with use of a Viega pipe bender.

### Minimum Burst Pressure (PSI) Per ASTM F876/F877

SIZE	73°F (23°C)	180°F (82°C)
1/2"	480	215
5/8"	475	200
3/4"	475	210
1"	475	210

### Thermal Conductivity

SIZE	Btu/h/ft/°F	W(m.°C)
1/2"	.484	.838
5/8"	.516	.892
3/4"	.547	.946
1"	.711	1.230

### SDR-9 PEX Tubing ASTM F876/F877/CTS-OD SDR-9

Part No	Tubing Size	Wall O.D.	Nom. Thickness	I.D.	Weight Per Ft	Volume(Gal. Per 100 Ft)
35020	1/2"	0.625±.004	0.070+.010	0.475	.0600	0.92
35030	5/8"	0.750±.004	0.083+.010	0.574	.0900	1.34
35040	3/4"	0.875±.004	0.097+.010	0.671	.1200	1.82
35060	1"	1.125±.005	0.125+.013	0.863	.2000	3.04

NOTE: Dimensions are in English units. Tolerances shown are ASTM requirements. Viega FostaPEX is manufactured within these specifications. (These dimensions do not reflect the outer aluminum and PE layers.)

### Pressure Drop Table Expressed as PSI/ft. Pressure Drop

GPM	SIZE			
	1/2"	5/8"	3/4"	1"
1	.016	.007	.003	.001
1.5	.034	.014	.006	.002
2.2	.069	.034	.013	.004
2.5	.087	.043	.016	.005
3	.122	.050	.023	.007
3.5	.162	.080	.030	.009
4	.208*	.100	.039	.011
5	.314	.154	.059	.017
6	.440	.181	.082	.024
7	.586	.287	.109	.032
8		.368	.140	.041
9		.457	.174*	.051
10		.556	.211	.062
11			.252	.074
12			.296	.087
13			.343	.101
14				.116
15				.132*
16				.148
17				.166
18				.184
19				.204
20				.224
21				.245
22				.267

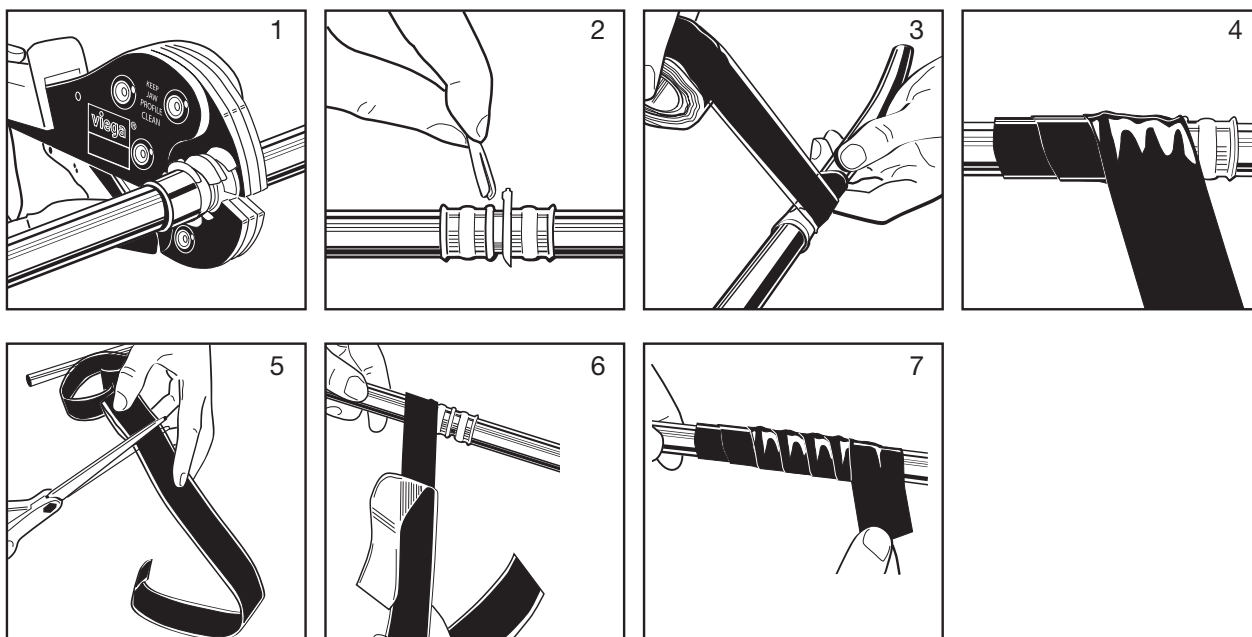
**EXAMPLE:** To calculate the pressure drop of a 1/2" line, 40 ft. long, with a 3 gpm flow rate, calculate .122 psi x 40 ft. = 4.9 psi pressure drop. Most plumbing codes require 8 psi residual pressure at the fixture. Refer to your local code requirements.

\*Indicates 8 fps maximum velocity required by some plumbing codes.

NOTE: Maximum flow for each size based on 12 FPS velocity.

PSI x 2.307 = head loss.

### ViegaPEX<sup>®</sup> Repair Coupling Wrap



1. Press fitting as per Viega's PEX Press Product Instructions.
2. Remove Tool Locator Rings to ensure a proper seal.
3. Leaving protective film in place, measure amount of tape required for sealing fitting by wrapping fitting completely.
4. Overlap by 1/2" to 1" to ensure proper seal
5. Cut required length of tape.
6. Carefully wrap fitting with tape, removing protective film as fitting is wrapped.
7. Completely cover fitting. The silicone will bond within 2 minutes and create a permanent bond within 24 hours.

**NOTE:** Concrete pour will not affect sealant's bonding process.

**A.1 Introduction**

The Climate Panel provides the installer with an installation method that is applicable to a wide array of configurations, including new and retrofit floors and walls. It may be installed over slabs or wood subfloors and can provide a more dynamic heating response than in-slab systems. Climate Panels are shipped in individual pieces or as Assembled Climate Panels (ACPs), which are preassembled, hinged modules of 6 individual Climate Panels that reduce installation time.

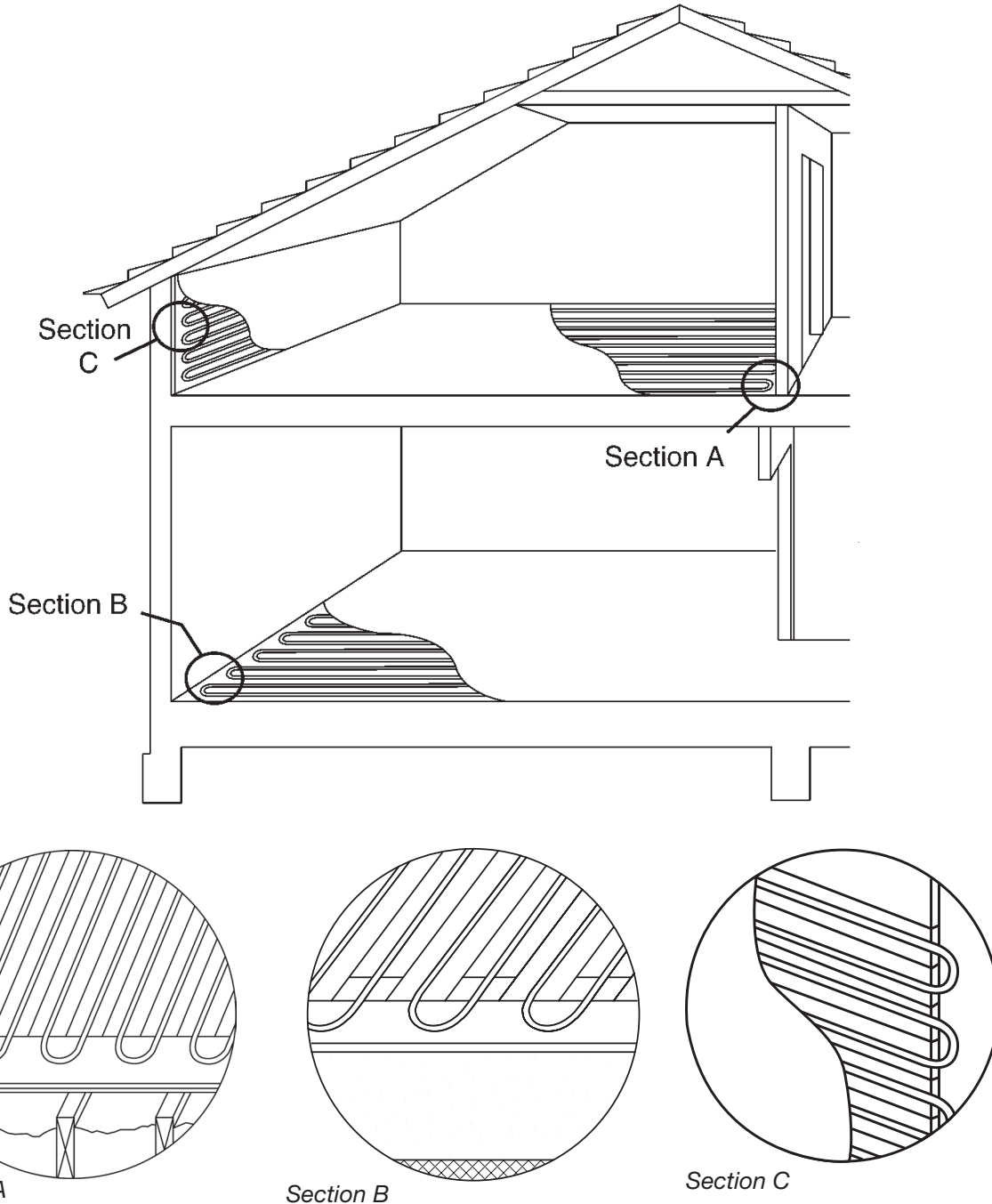
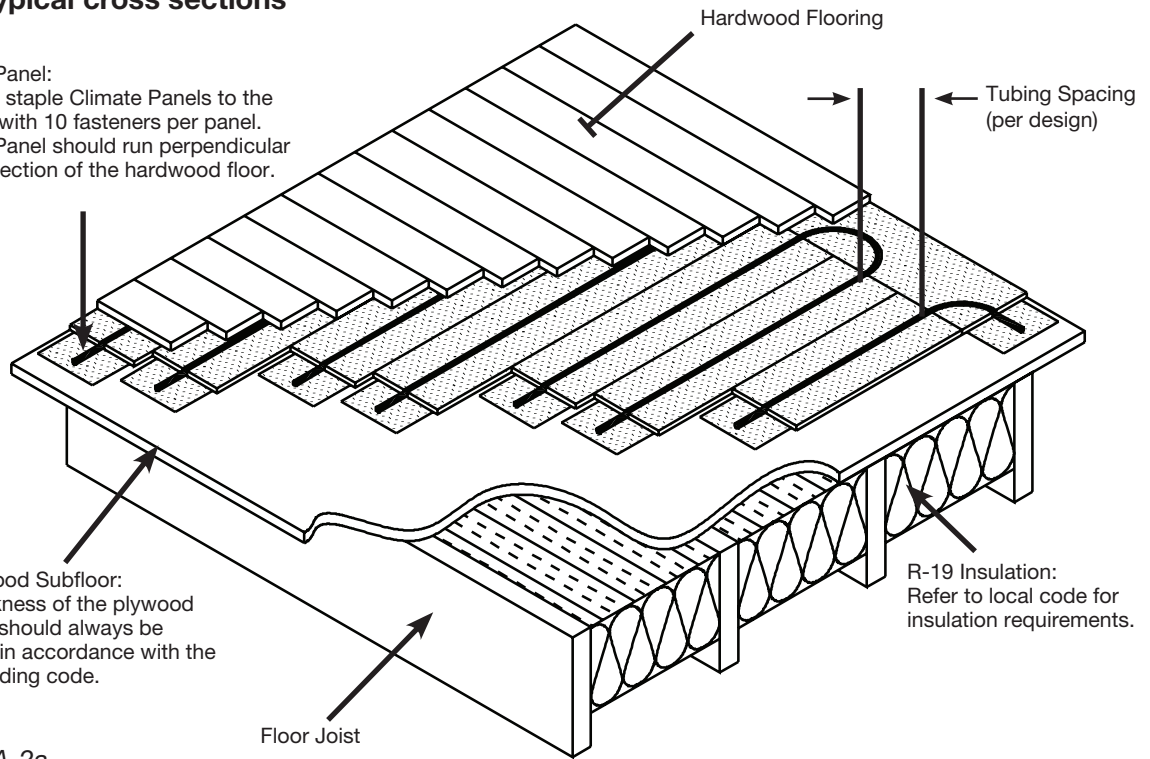


Figure A-1

## A.2 Typical cross sections

**Climate Panel:**  
Screw or staple Climate Panels to the subfloor with 10 fasteners per panel. Climate Panel should run perpendicular to the direction of the hardwood floor.

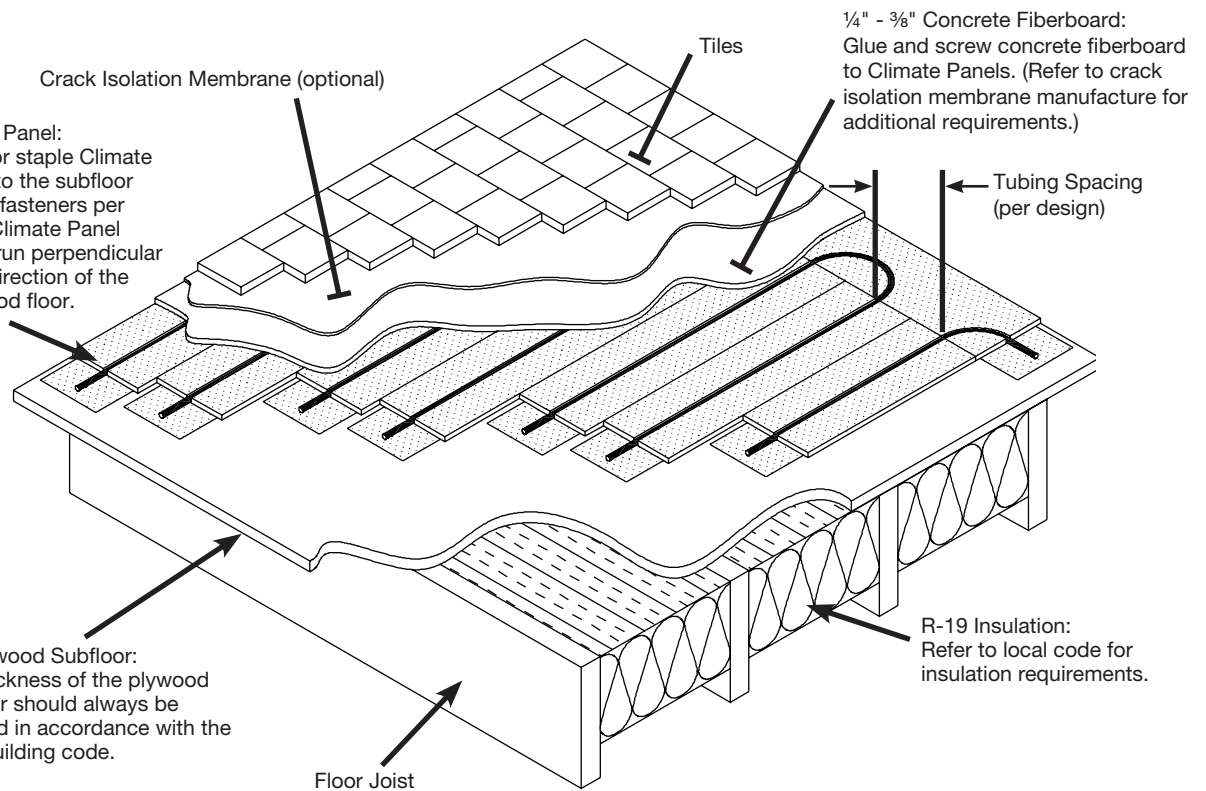
**3/4" Plywood Subfloor:**  
The thickness of the plywood subfloor should always be installed in accordance with the local building code.



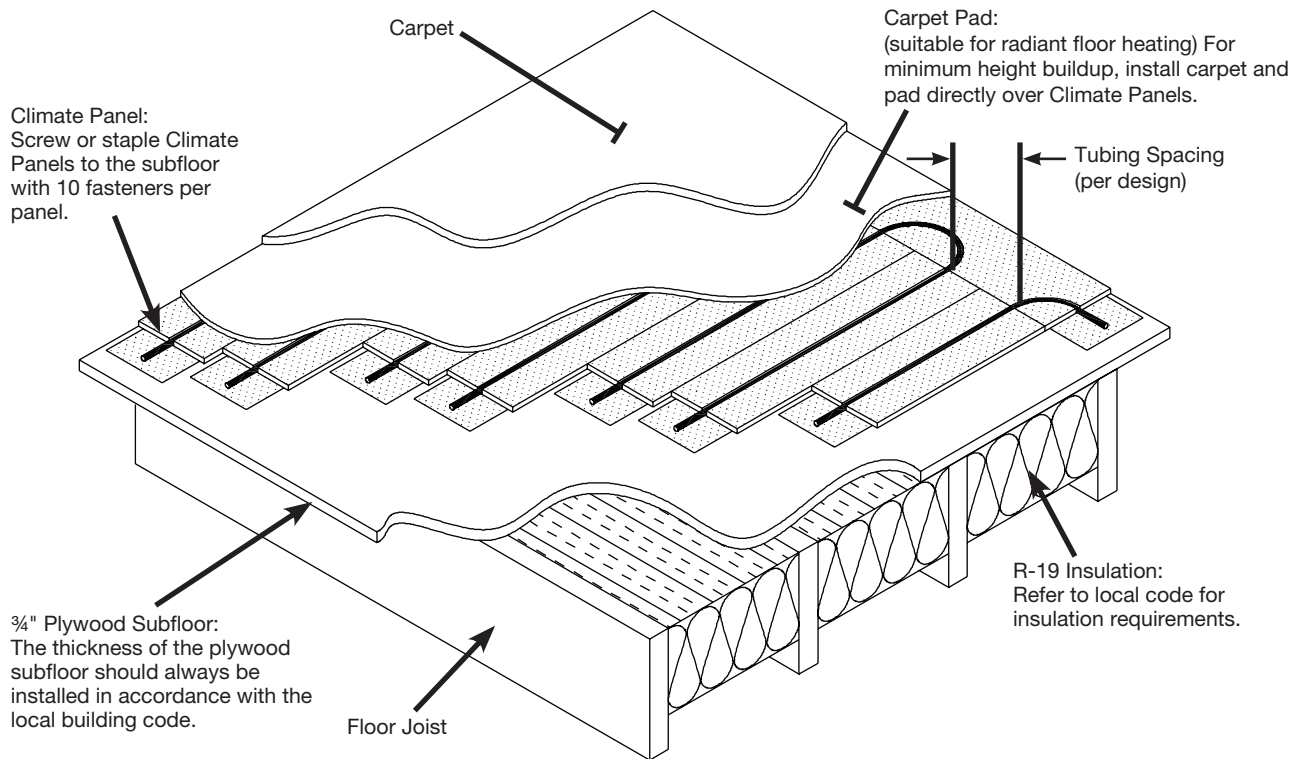
**Figure A-2a**  
*Section through Climate Panel installation above subfloor with hardwood finish floor*

**Climate Panel:**  
Screw or staple Climate Panels to the subfloor with 10 fasteners per panel. Climate Panel should run perpendicular to the direction of the hardwood floor.

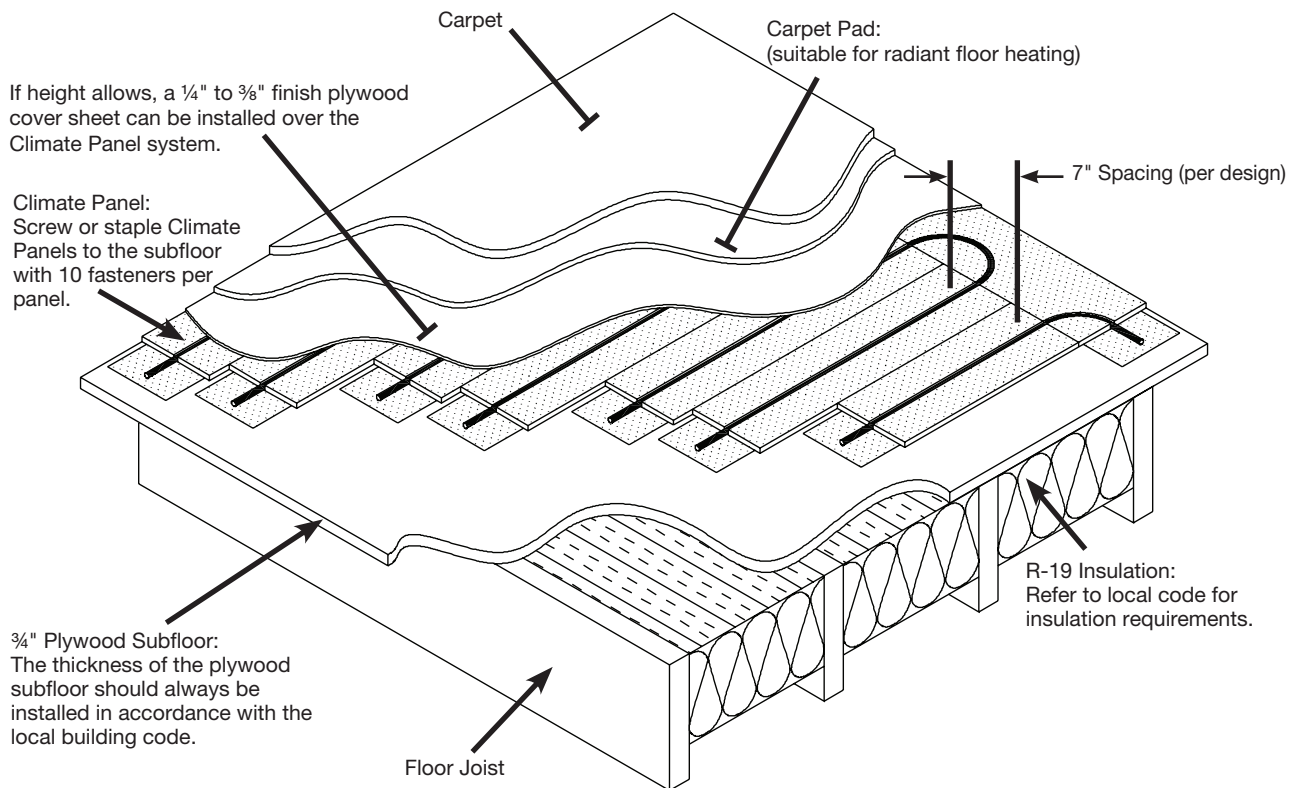
**3/4" Plywood Subfloor:**  
The thickness of the plywood subfloor should always be installed in accordance with the local building code.



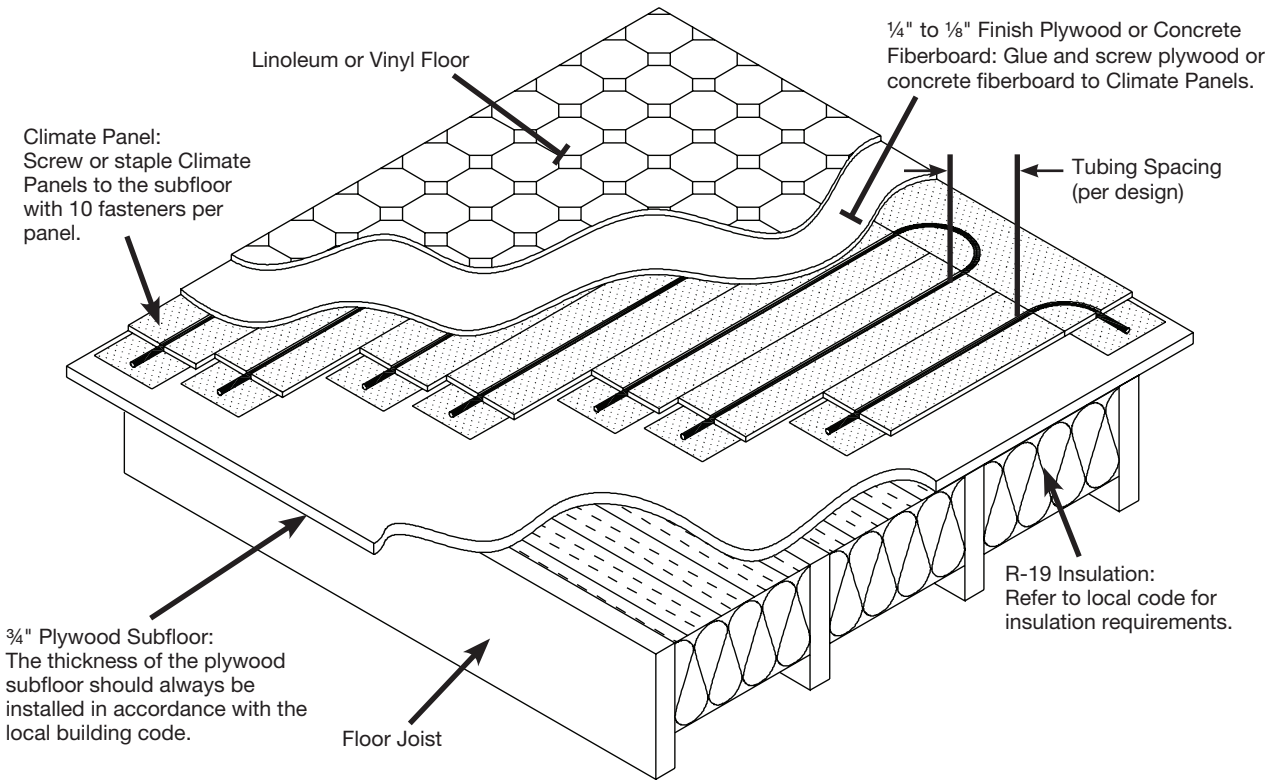
**Figure A-2b**  
*Section through Climate Panel installation above subfloor with tiles*



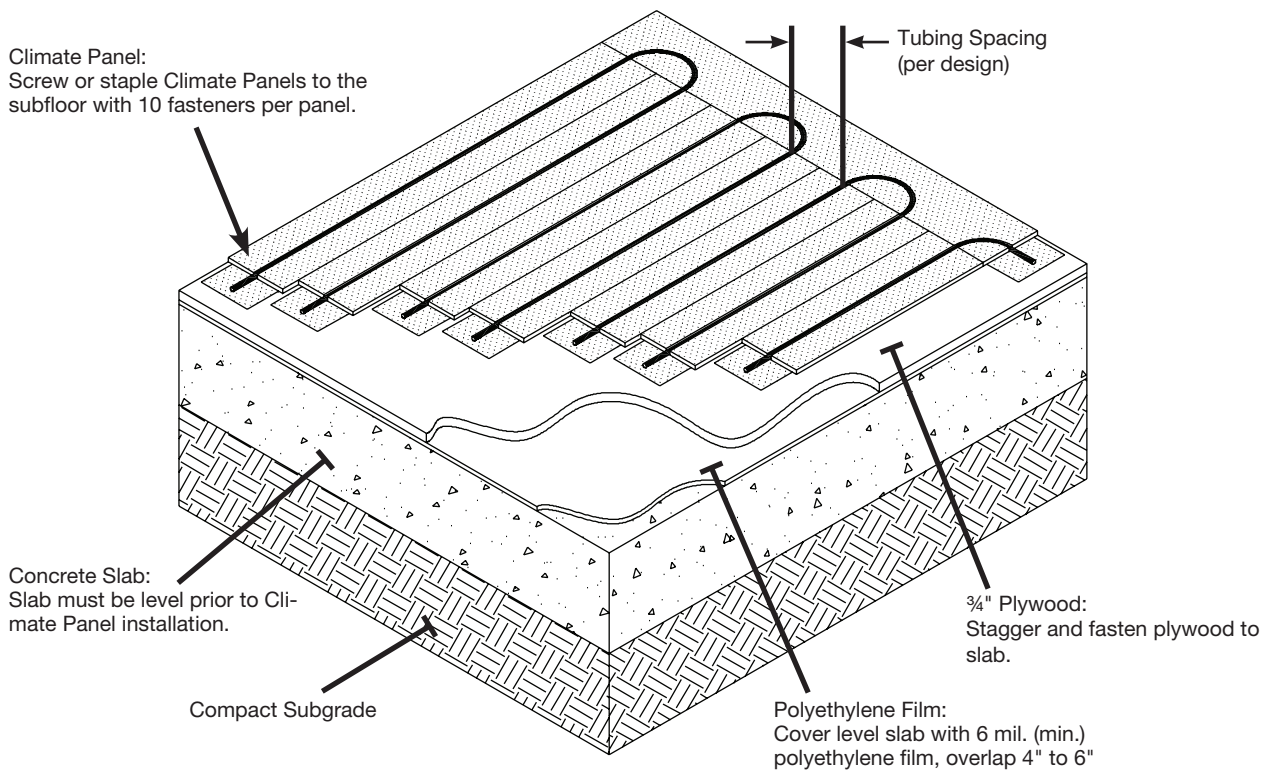
**Figure A-2c**  
Section through Climate Panel installation above subfloor with carpet



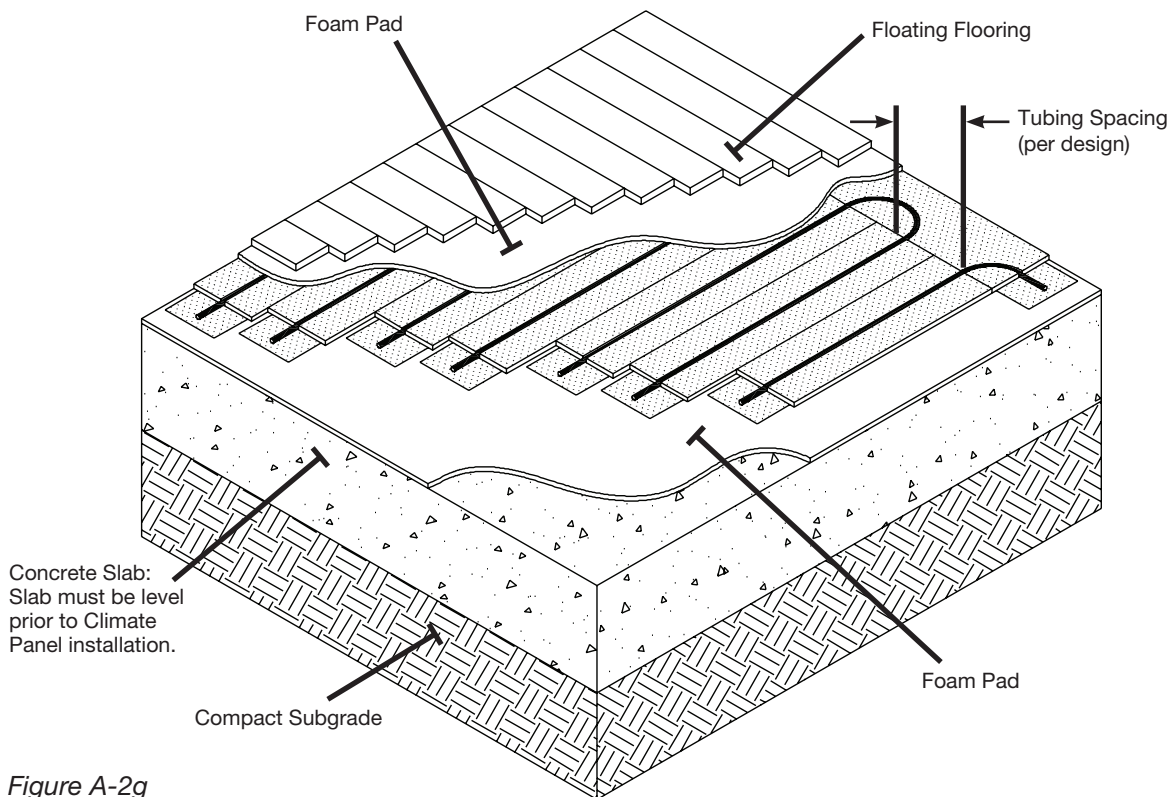
**Figure A-2d**  
Section through Climate Panel installation above subfloor with carpet and plywood cover sheet



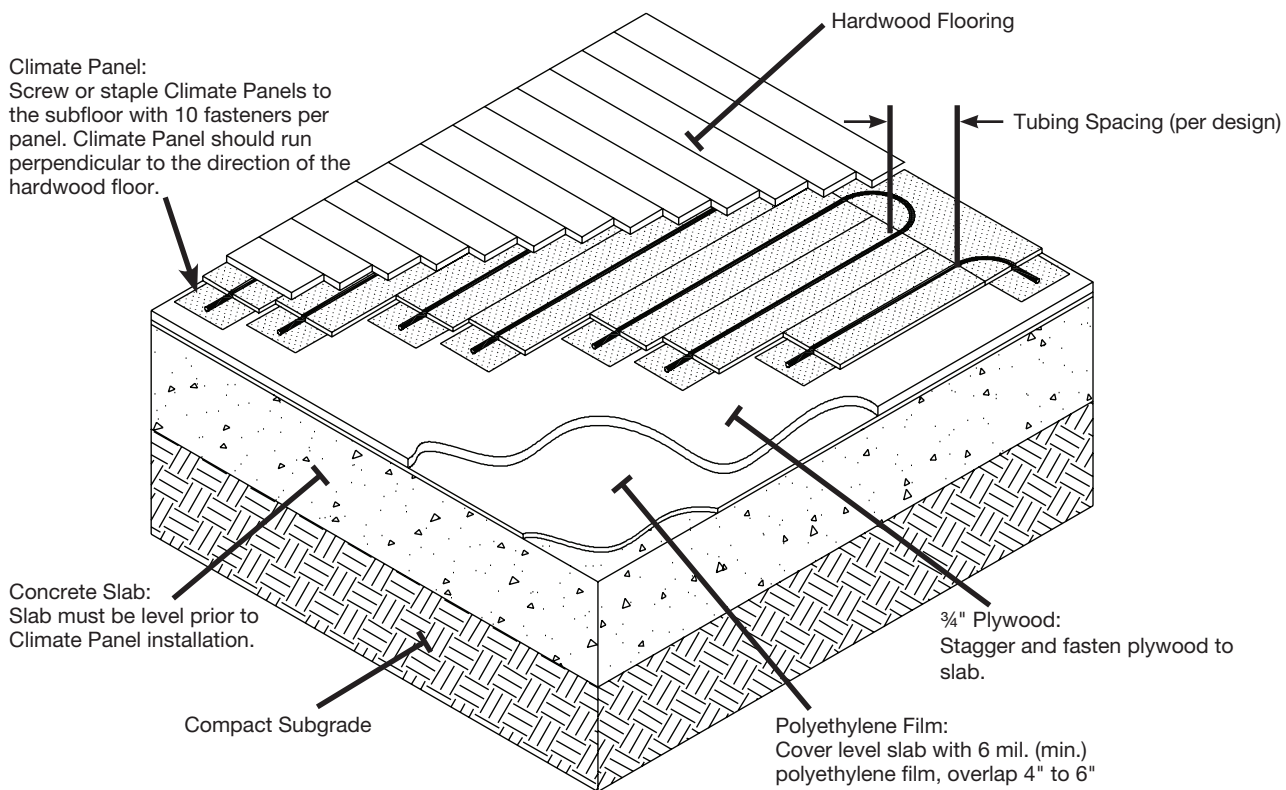
*Figure A-2e*  
*Section through Climate Panel installation above subfloor with linoleum or vinyl finish floor*



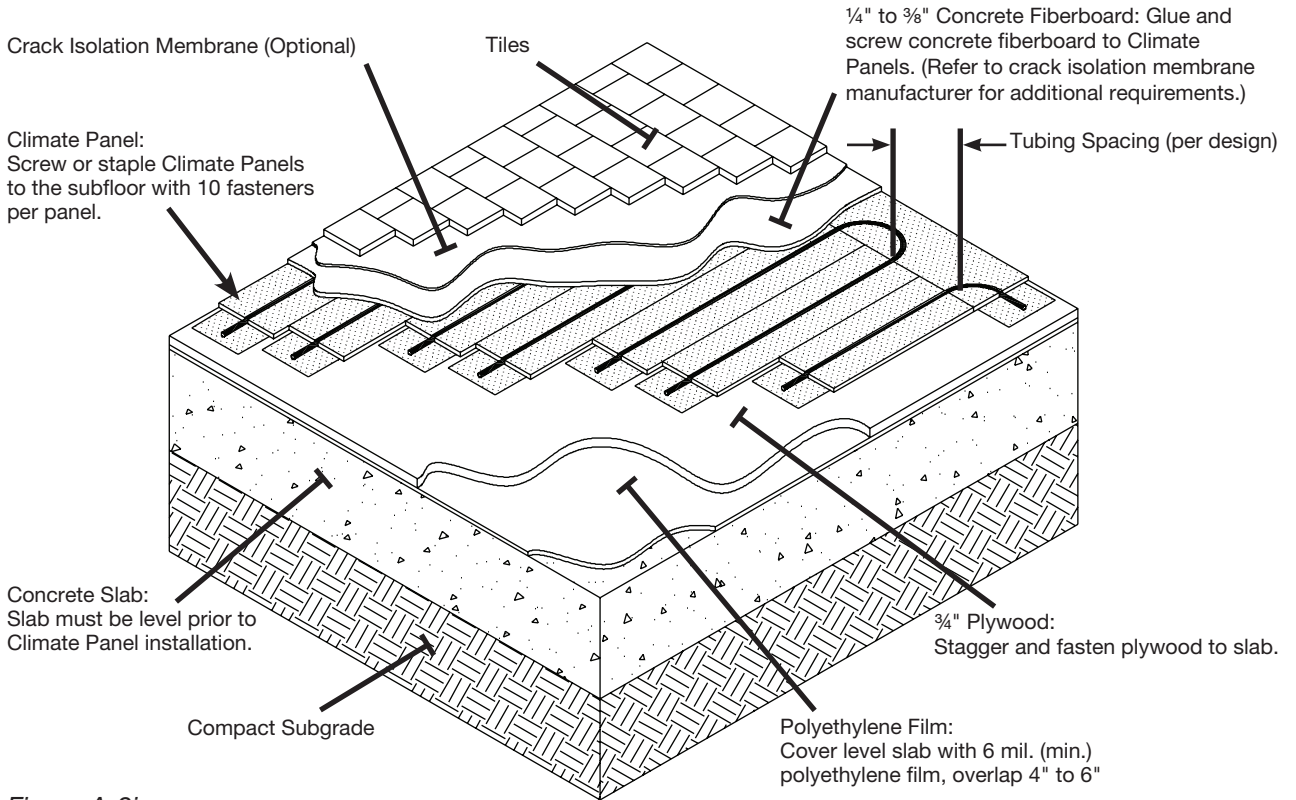
*Figure A-2f*  
*Section through Climate Panel installation on existing slab with plywood*



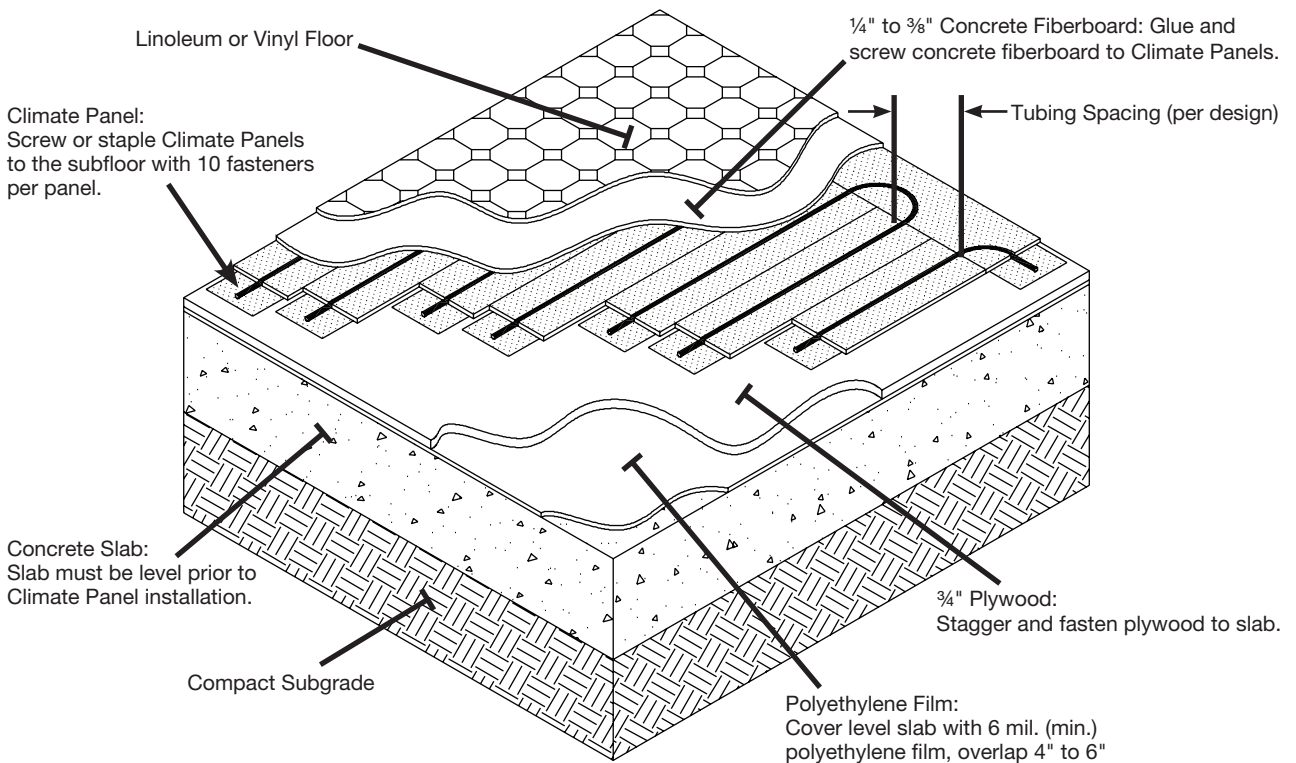
**Figure A-2g**  
Section through Climate Panel installation on existing slab with floating floor



**Figure A-2h**  
Section through Climate Panel installation on existing slab with hardwood finish floor

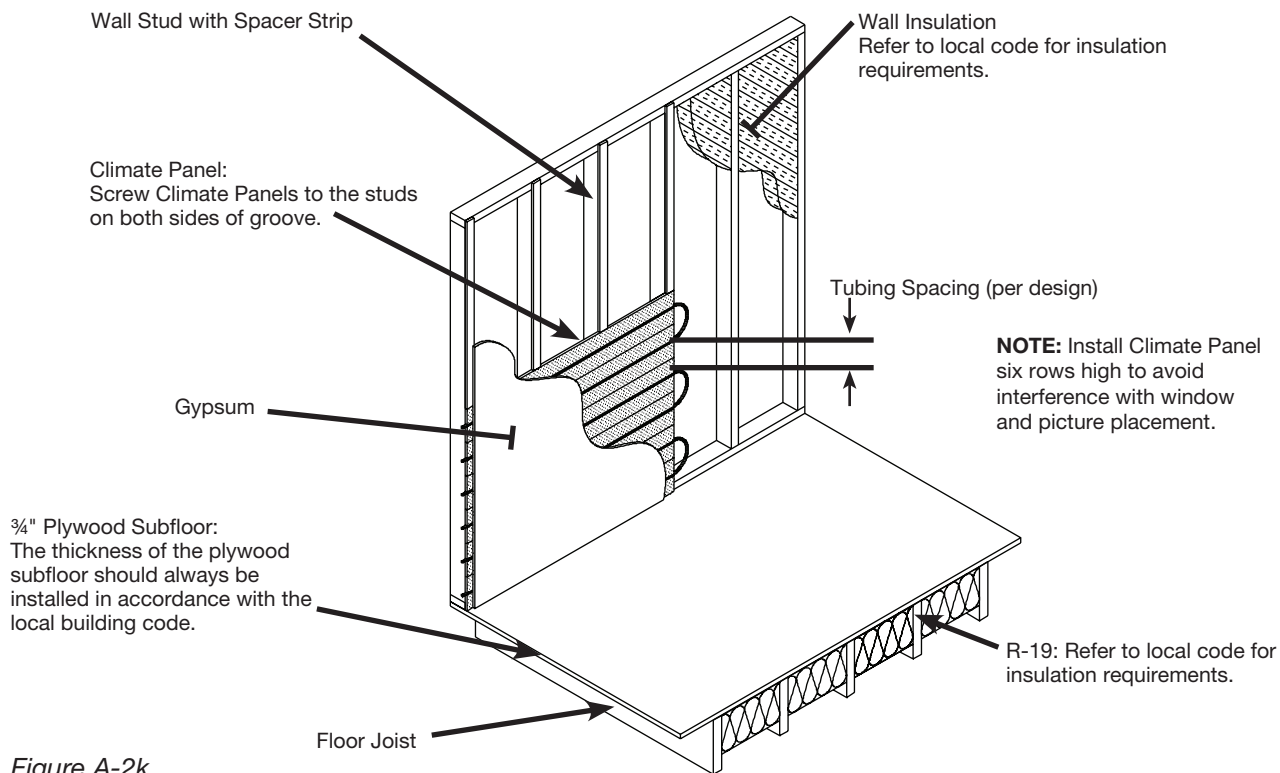


*Figure A-2i*  
Section through Climate Panel installation on existing slab with tiles

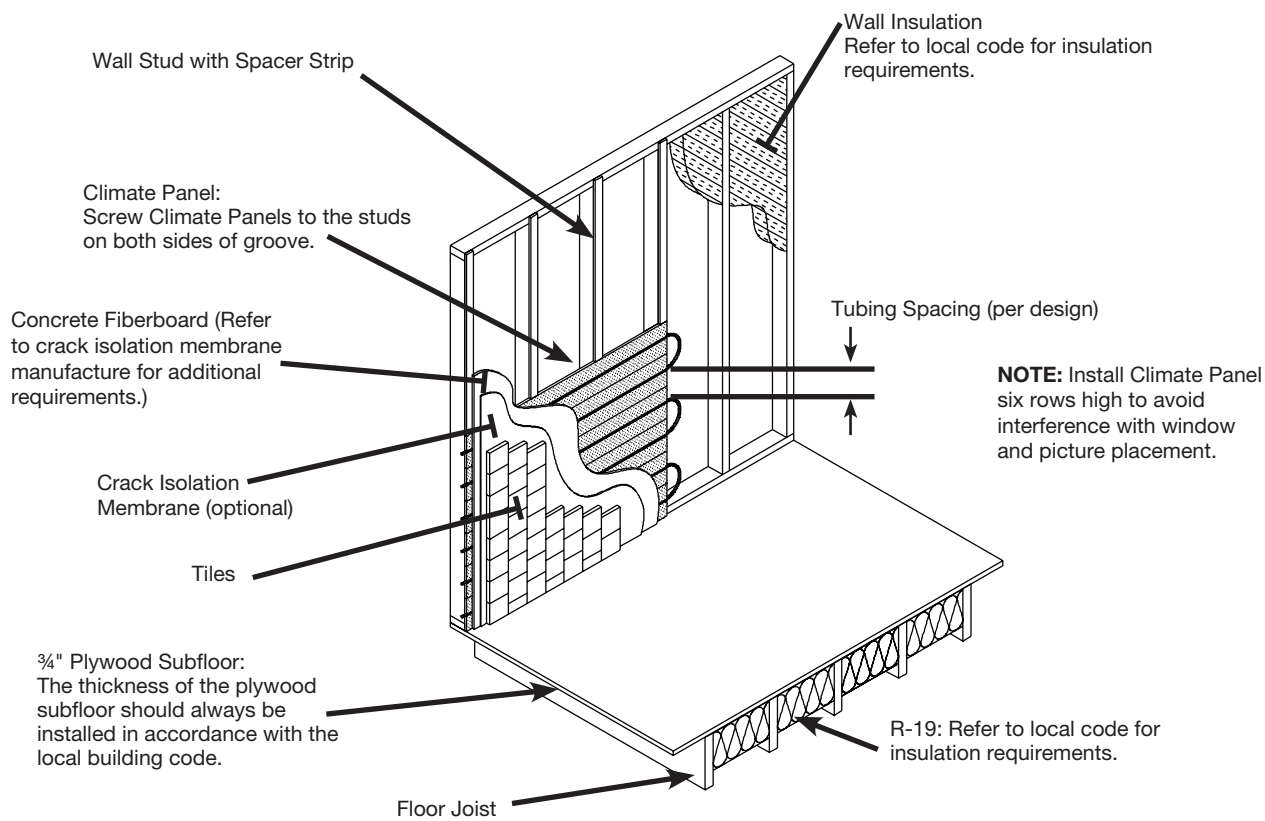


*Figure A-2j*  
Section through Climate Panel installation on existing slab with linoleum or vinyl finish floor





**Figure A-2k**  
*Section through Climate Panel installation in wall*



**Figure A-2l**  
*Section through Climate Panel installation in wall*

### A.3 Creating a material list

This chart is intended for conceptual purposes in developing an initial material list; there may be variations in each job. You may use Radiant Wizard to create a final material list.

Products		Net Heated Area (ft <sup>2</sup> )	Multiplier	Estimated Amount
Distribution System Tubing	<sup>5</sup> / <sub>16</sub> " ViegaPEX Barrier Tubing	7" Spacing	1.9	
		10" Spacing	1.4	
Fasteners	Screws		5.4	
	Staples		5.4	
Groove Tube Silicone			0.02	
Panels	7" Spacing		0.4	
	10" Spacing		0.3	
ACPs	7" Spacing		0.07	
	10" Spacing		0.05	
U-Turns			0.04	

**NOTES:** Tubing is sold in coils and fasteners in packages. Installer's preference determines the choice between staples and screws. Where multipliers are located in the table, multiply the net heated area by the corresponding multiplier to derive the estimated amount. For example, if ACPs are specified at 7" spacing for 1,000 ft<sup>2</sup> of net heated area, the estimated ACPs required are 1,000 x 0.07 = 70. Tubing multipliers include 10% overage for leaders.

### A.4 Layout planning

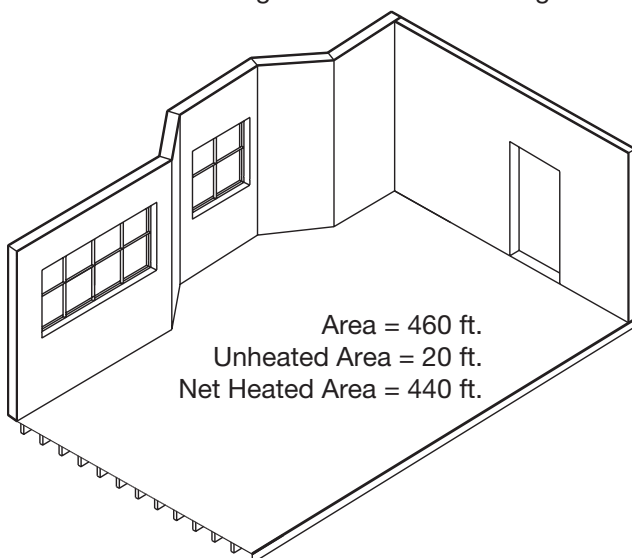
To avoid waste and to have equal circuit lengths, a carefully planned layout should be done.

First, determine where the manifold should be installed. Remember, the manifold must be accessible. When calculating number of circuits, always round up. Keep length of each circuit in the same room equal.

Maximum Circuit Length		
Tubing	25 Btu/h/ft. <sup>2</sup> or less	25-35 Btu/h/ft. <sup>2</sup>
<sup>5</sup> / <sub>16</sub> " ViegaPEX Barrier	250 feet	200 feet

Calculating number of circuits:

$$\text{Total amount of tubing} \div \text{maximum circuit length} = \# \text{ of circuits}$$



#### Maximum loop lengths (CSA B214 Table 1)

Nominal tube size, in	Maximum loop length, m (ft)
<sup>5</sup> / <sub>16</sub>	61 (200)

Table A-1 Maximum length of continuous tubing from a supply-and-return manifold arrangement (See Clause 14.3.2)

**NOTE:** Data for this table were compiled by the B214 Technical Committee and are based on manufacturers' recommendations and good engineering practice

CSA B214, Clause 14.3.2

The maximum length of continuous tubing from a supply-and-return manifold arrangement shall not exceed the lengths specified by the manufacturer or, in the absence of manufacturer's specifications, the lengths specified in Table 1. Actual loop lengths shall be determined by spacing, number of loops, and pressure drop requirements, as specified in the system design.<sup>40</sup>

Figure A-3 The remainder of this appendix will reference this sample room in developing layout and installation examples

40. ©CSA Group, B214-12. 2012. "Installation Code for Hydronic Heating Systems" Table 1, Clause 14.3.2

## A.5 Installation

Before you start the installation, ensure that you have the proper tools for the job.

### • Installation (Power Tools) •

1. Radial arm chop saw (12" recommended), optional sliding arm recommended also (less than 12" will not chop through the 7" ACPs or the 10" panels completely)
2. Skil saw or portable table saw - for ripping down panels
3. Staple gun with hose and compressor ( $\frac{7}{16}$ "- $\frac{1}{2}$ " crown by 1 $\frac{1}{4}$ " or 1 $\frac{1}{2}$ " ) staples
4. Alternative to the staple gun is a stand-up screw gun with self-feeding 1 $\frac{1}{4}$ " to 1 $\frac{3}{4}$ " screws (depending upon the application)
5. Battery-operated screw gun - for clips, touchups, hanging manifolds and blocks to hold tubing down at floor penetration
6. Drill with bit kit - hole saw kit
7. Saw - for opening base of wall or cutting through plates to run multi-tubing lines through

### • Installation (Hand Tools) •

1. Tape measure (recommended one per person)
2. Chalk line
3. Utility knives - for cutting aluminum sheets and nipping corners
4. Hammer - for hammering down staples that were not fully embedded, miscellaneous uses
5. Rubber mallet
6. Caulking gun
7. Tubing cutter
8. Chisel - to clean up floor penetration holes to create a ramp-like drop
9. Adjustable wrench

### • Pre/Post Installation •

1. Shop-Vac - for cleaning out grooves before silicone and tubing are installed
2. Broom - for pre-installation cleanup of areas

### • Miscellaneous •

1. Saw horses - to make table for chop saw
2. Portable lights
3. Extension cords
4. Calculator (recommended)
5. Permanent Marker - allows for more visible markings on dusty floors or concrete
6. Knee pads - recommended wearing when installing tubing into tracks
7. Decoiler

**Step 1:**  
Decide the proper direction of the Climate Panels.

*Tile finish floor*

If tiles will be installed over the Climate Panels, run the panels perpendicular to the floor joists. This stiffens the floor for a more stable tile installation. Aligning the ends of each panel to lie on a joist is optional, but will allow fasteners to attach panels, subfloor and joists together.

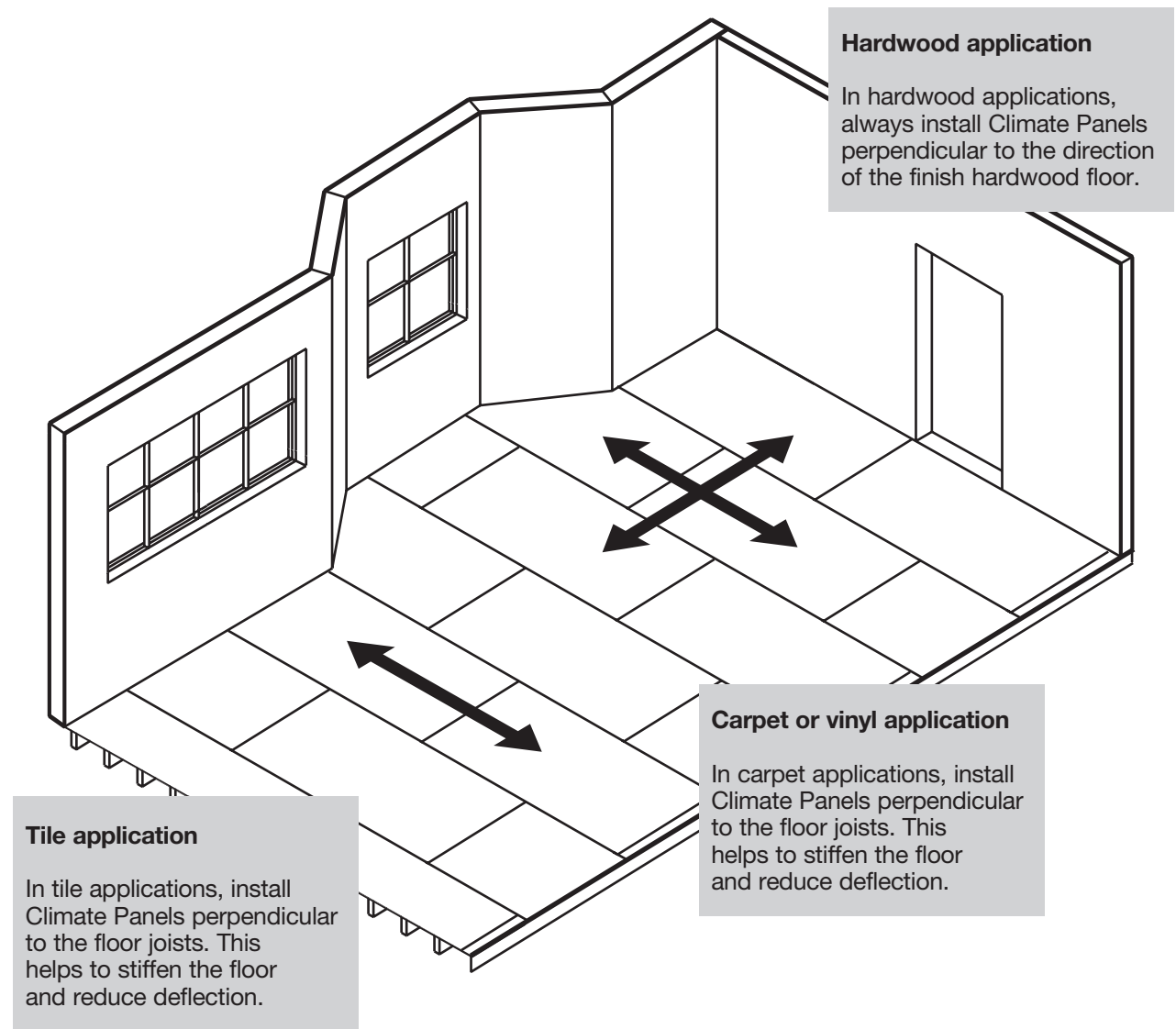
*Carpet or vinyl finish floor*

If the finish floor will be carpet, linoleum or vinyl, the direction of the Climate Panels is not critical.

Where possible, running the panels perpendicular to the floor joists will strengthen the floor and reduce deflection.

*Hardwood finish floor*

Where hardwood flooring will be installed over the Climate Panel system, always run the panels perpendicular to the direction of the hardwood planks (regardless of the joist direction). This will keep tubing visible during floor nailing and reduce the possibility of accidental tubing puncture.

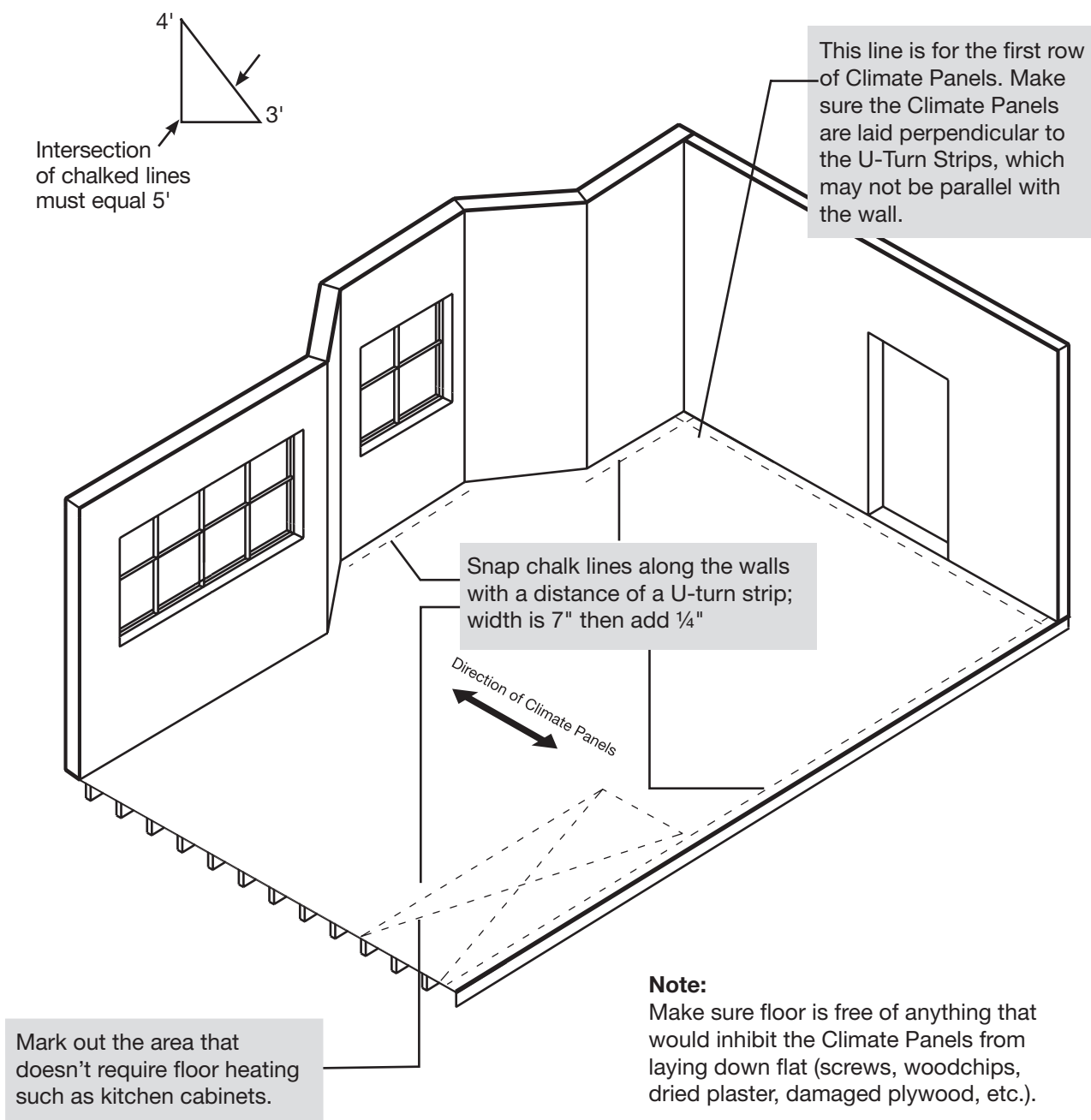


**Step 2:**

Because most rooms are not perfectly square, lines need to be chalked to ensure proper layout of the Climate Panels.

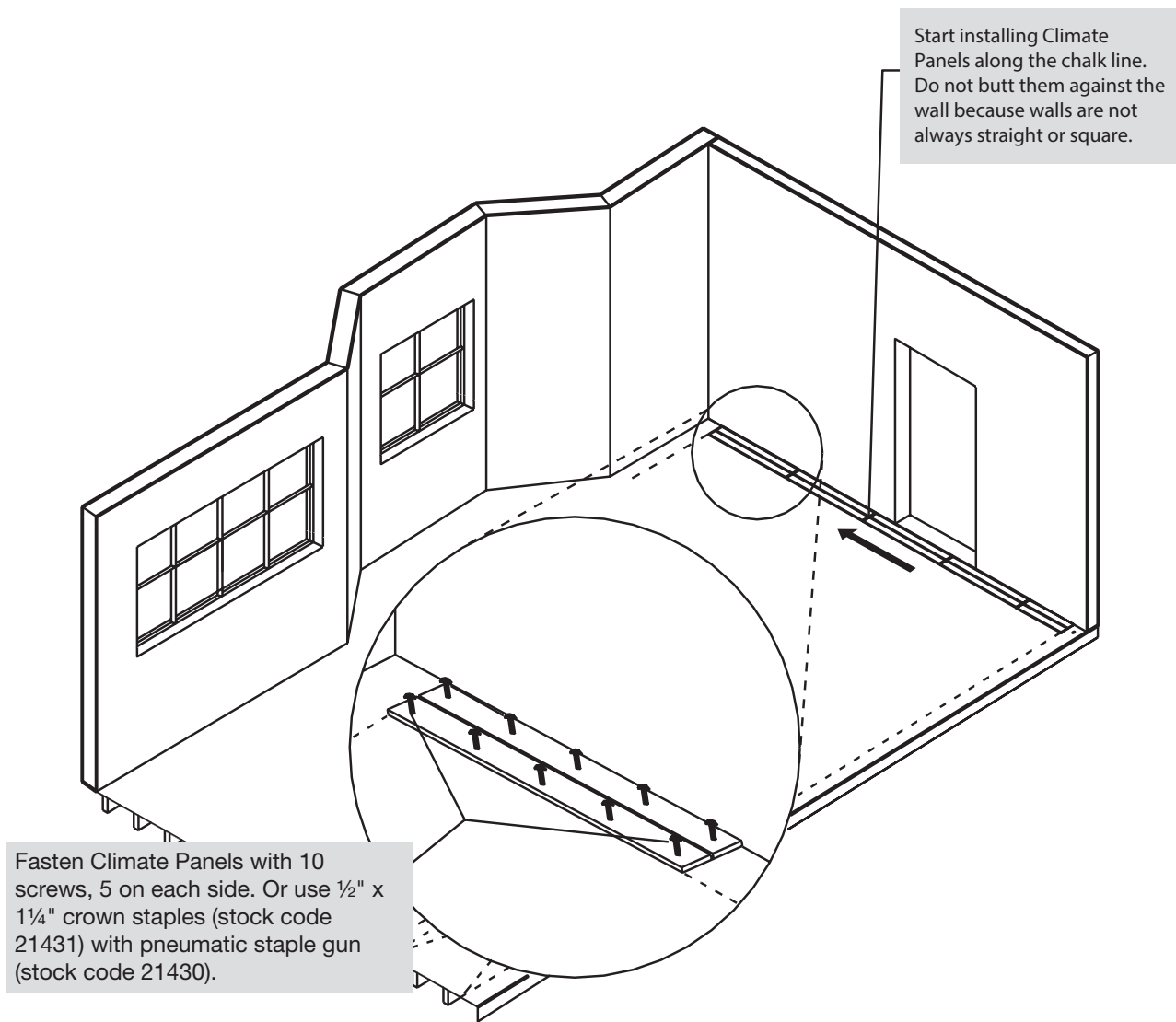
Begin by chalking a line along the wall where the first row of panels will be laid out. The line should be 7¼" from the wall.

Next, chalk lines along the walls where the U-turn strips will be laid out. One way to ensure that the chalk lines are perpendicular to each other is to use the right triangle rule ( $a^2+b^2=c^2$ ) also known as the 3, 4, 5 triangle.



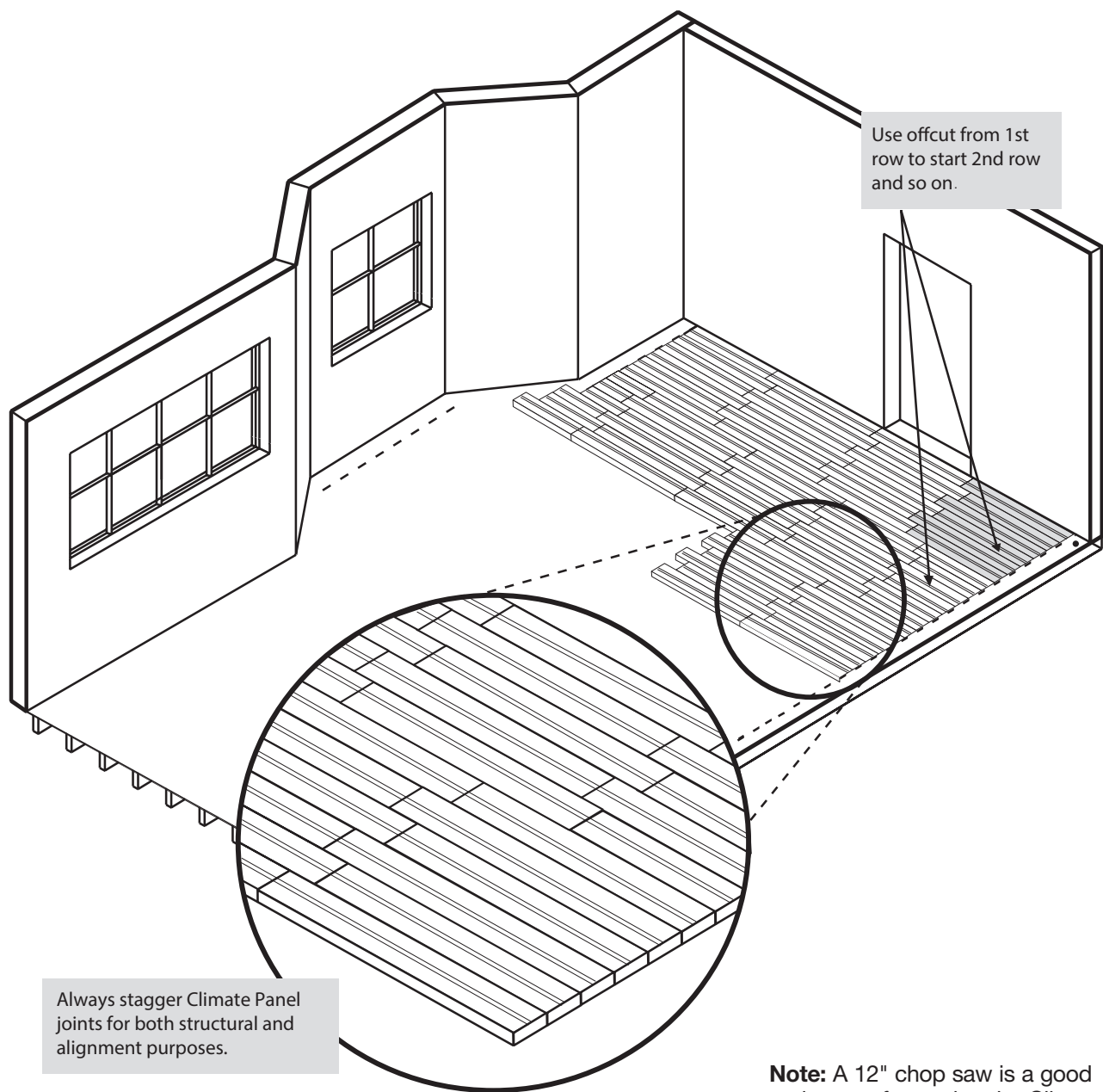
*Step 3:*  
Start installing the Climate Panels.

Begin laying out panels along chalked line. Use single panels to ensure they are lined up with the line. This row will act as a guide for the ACPs laid down afterward, allowing for faster installation. Be sure to fasten down row of single panels before you begin to lay out the ACPs.

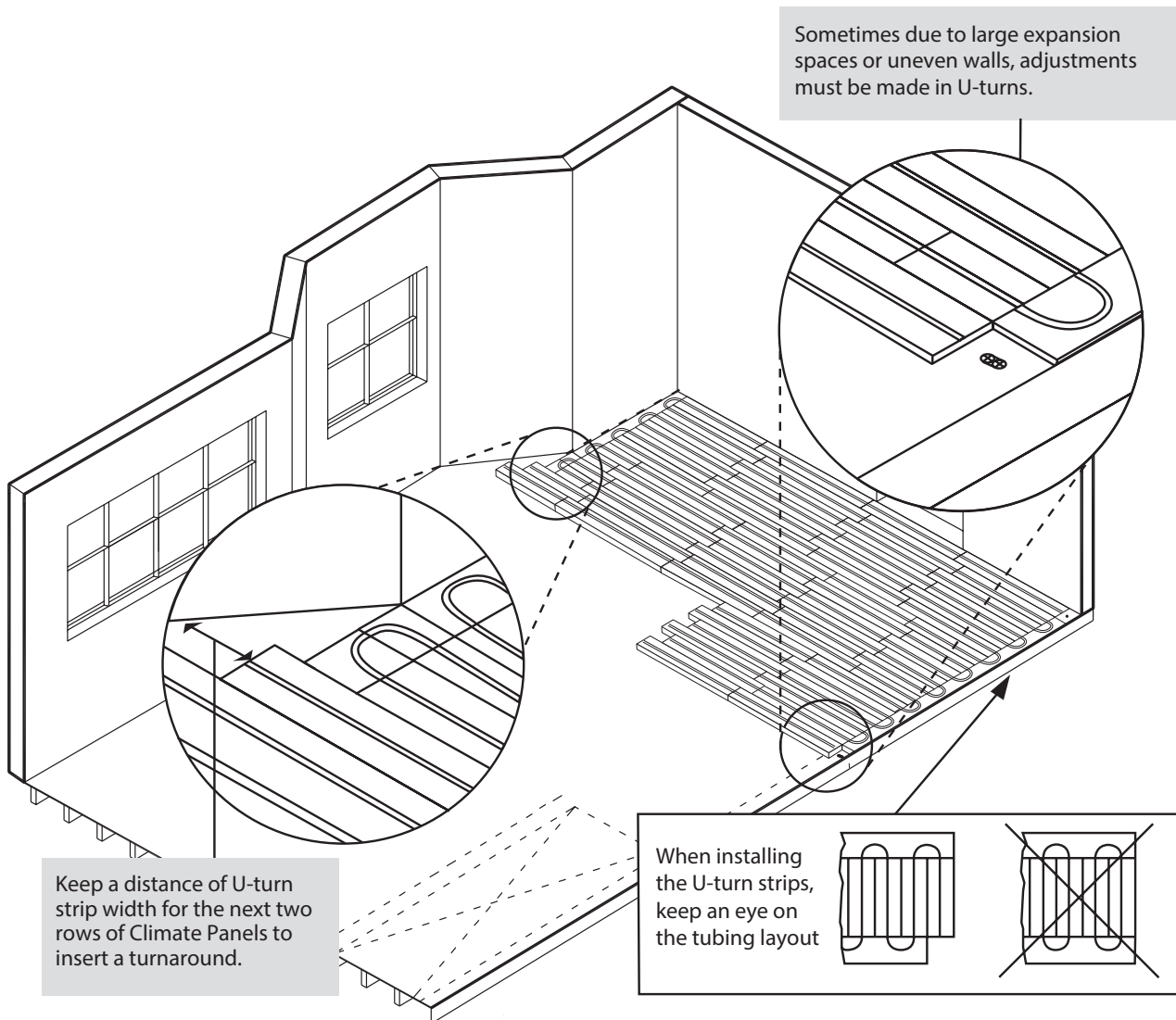


**Step 4:**  
Stagger the Climate Panels.

To begin ACP installation, cut an unopened bundle in half to create a straight edge to begin with. Be sure the ACP is completely flush with the first row already fastened down before you begin to fasten the ACPs. After the first row of ACPs has been laid out, begin to stagger seams.



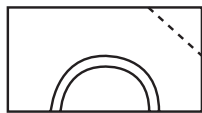
**Step 5:**  
 Install the Climate Panels then the U-turn strips. When laying down U-turn strips, be sure to first put down the aluminum sheets provided in each U-turn bundle. After the aluminum is laid out, align U-turn strips up with the correct tracks and fasten.



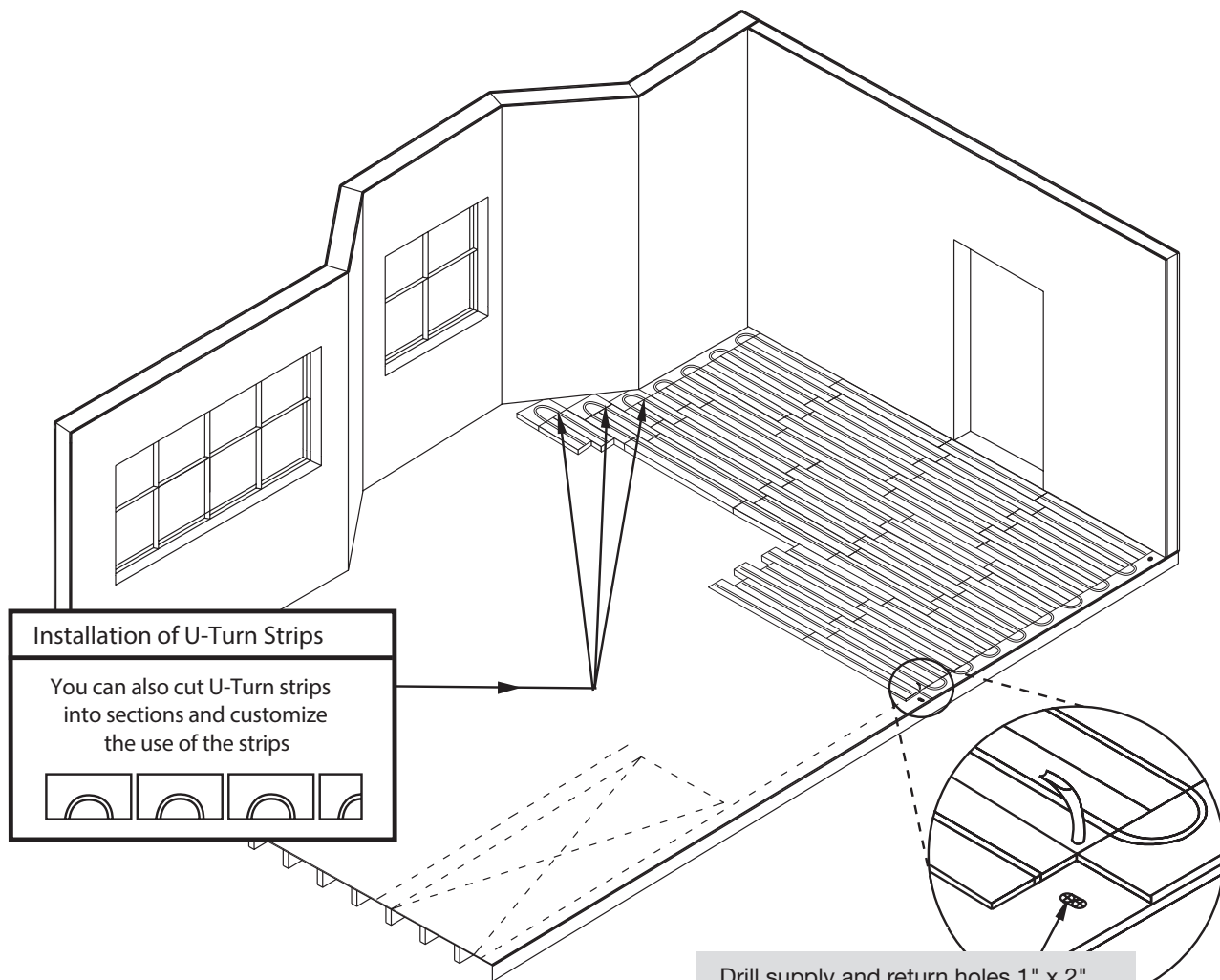
**Note:** A utility knife is a good tool to use for trimming the aluminum sheets needed under turnarounds (score, bend, break).



**Step 6:**  
Install the Climate Panels then  
the U-turns.



Cut turnaround pieces in area shown at the same angle as the wall to maximize heated area while minimizing the area that needs to be filled in, especially along the exterior walls.



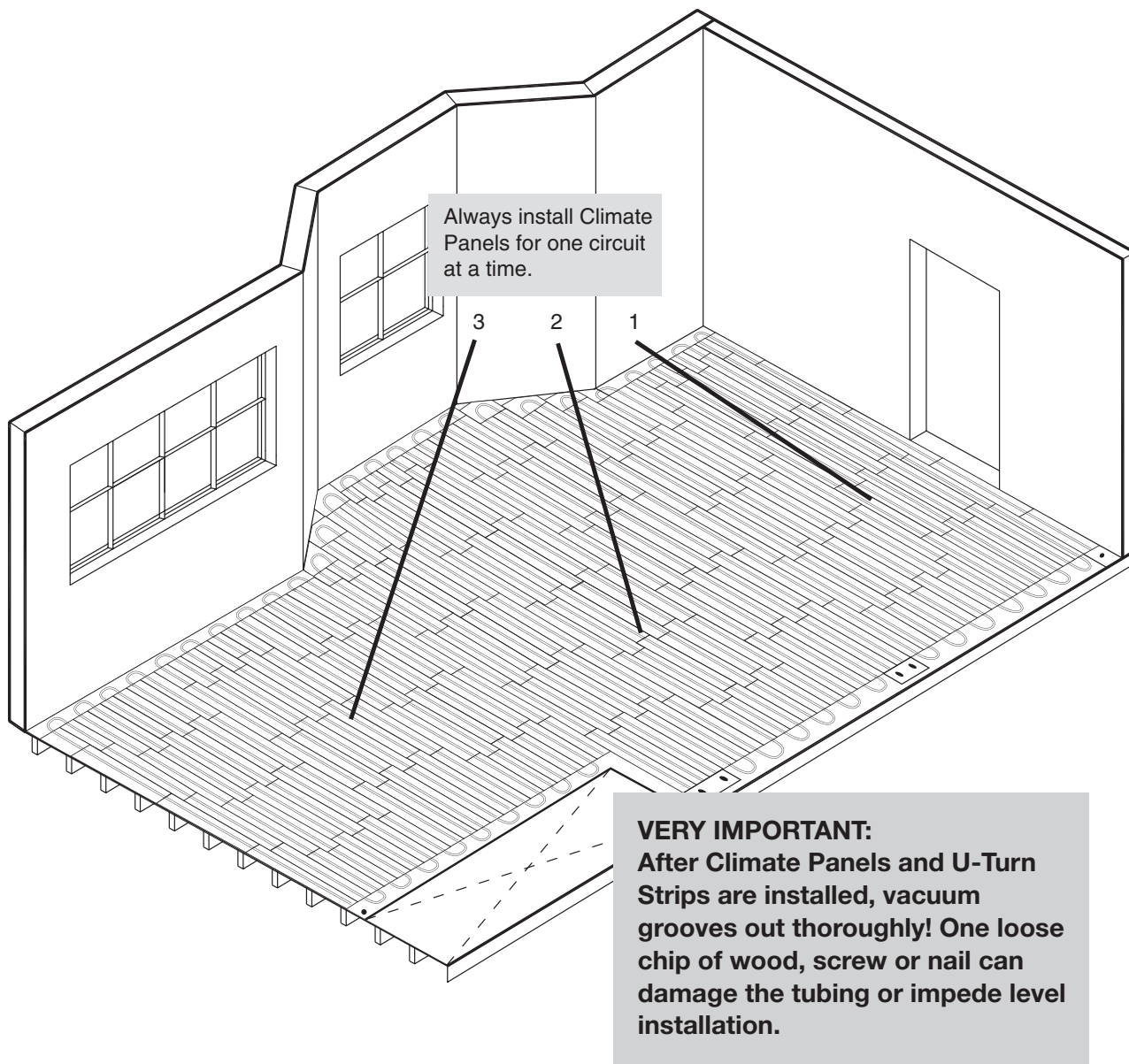
**Installation of U-Turn Strips**

You can also cut U-Turn strips into sections and customize the use of the strips

Drill supply and return holes 1" x 2" long. After the holes are drilled, use a chisel (if needed) to create a smooth ramp-like surface in which the plastic elbow sleeve with clip (stock code 15104) is to be inserted.

*Step 7:*  
Install the Climate Panels one circuit at a time.

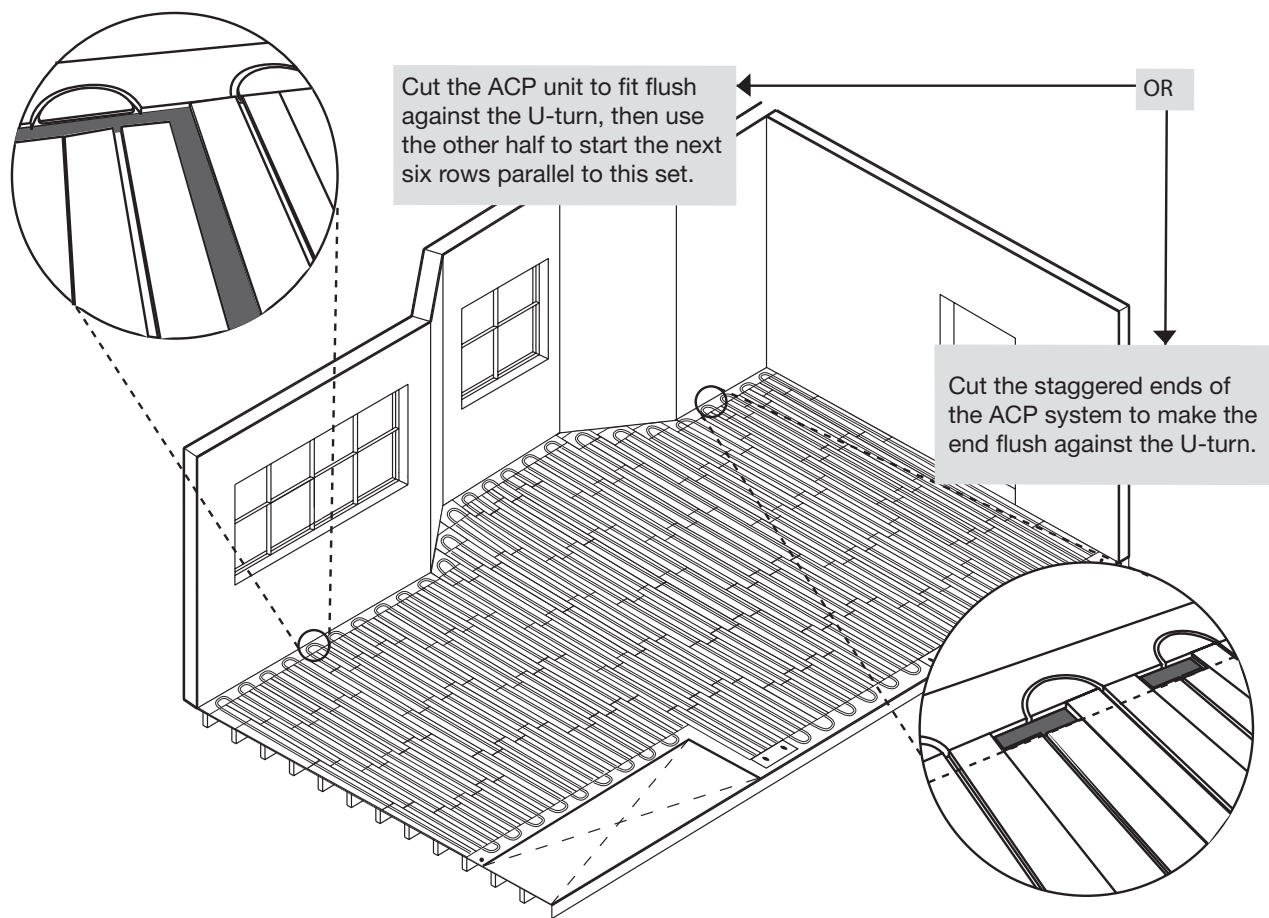
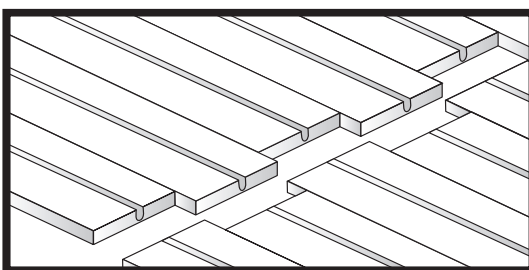
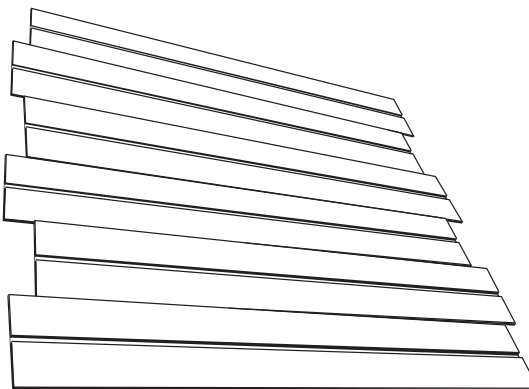
To minimize the chance of damaging the tubing while installing, use a utility knife to nip any corners at turnarounds that did not line up perfectly.



The assembled Climate Panel (ACP) system serves two important functions:

1. The ACP units are a time- and labor-saving device. The hinged units of six panels can be spread out and interlocked quickly, dramatically decreasing installation time when installed over a plywood subfloor.
2. The ACP system can be installed over existing concrete slabs as a floating floor system.

\*When floating the panels, tape joints in between ACPs.



**Step 8:**  
After Climate Panels and U-turn strips are installed, vacuum groove out thoroughly just prior to installing tubing.

If trapped in the groove, any debris, screws, nails, etc, will damage the tubing and keep it from lying flush with the top surface. When penetrating the floor, use a plastic elbow sleeve:

1. Figure the leader length of the supply line to the manifold area.
2. Feed leader length through plastic elbow sleeve. (Be careful not to scratch the tubing in the process.)

**NOTE:** Feed the tubing through an unsecured plastic elbow sleeve.

3. Feed the leader length through the floor.
4. Secure the fastener clip to the floor.

Directly before installing tubing into the Climate Panels, run a  $\frac{3}{16}$ " to  $\frac{1}{4}$ " bead of Viega's Groove Tube silicone into the panel grooves.

- Guaranteed not to damage PEX tubing or aluminum, the Groove Tube is strongly recommended.
- Do not use anything but 100% silicone rated for 180°F.
- Do not use caulking or any other type of sealant or adhesive.

**Installers: Since silicone becomes tacky in 8 to 10 minutes, it is recommended that silicone is applied only to a section that can be covered in this amount of time.**



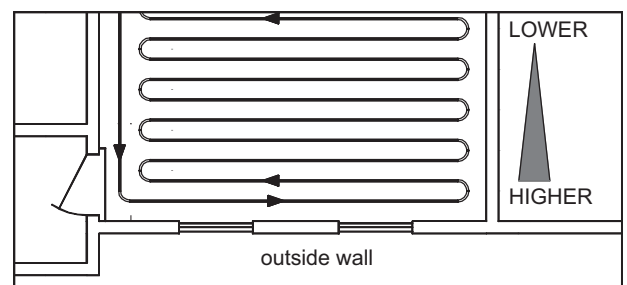
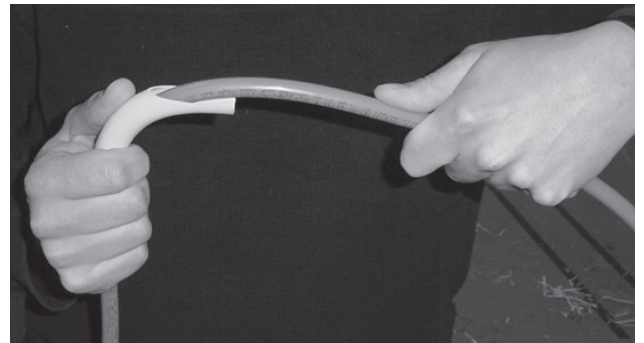
Directly after the Groove Tube silicone installation (before it cures), walk tubing off a decoiler into the Climate Panel groove.

- Do not let silicone set up before tubing is inserted.

**NOTE:** It is imperative to make sure tubing is completely in its tracks before silicone hardens. Tubing may have to be hammered in using a rubber mallet or a pneumatic soft-tipped palm hammer.

Run supply tubing from manifold supply valves into high heat loss areas first (e.g. closest to exterior walls, windows, sliders, etc.) and then into the interior of the room.

This will provide more Btu output where it is needed due to higher water temperatures. Continue the circuits, laying them out in the same direction toward the interior of the room.



## B.1 Introduction

In-slab systems are an excellent choice for garages, workshops, basements, thin-slab installations and any other application where slabs are 10,000 ft<sup>2</sup> or less. For larger installations, consider specification of Climate Mat.

## B.2 Typical cross sections

Installers may select from a variety of fasteners when installing in-slab systems, including Rapid Grid, Snap Panel, wire mesh clips, plastic zip ties, U-channels, plywood staples and foam staples. Typical cross sections are shown below.

In-slab systems must maintain at least ¾" of concrete between the top of the tubing and the top of the slab. If installing tubing in a thin-slab, the minimum depth of the slab must be at least 1½". Be sure to coordinate with the person responsible for control cuts or joints to prevent tubing from being damaged after the pour, if the tubing is to be set high in the slab.

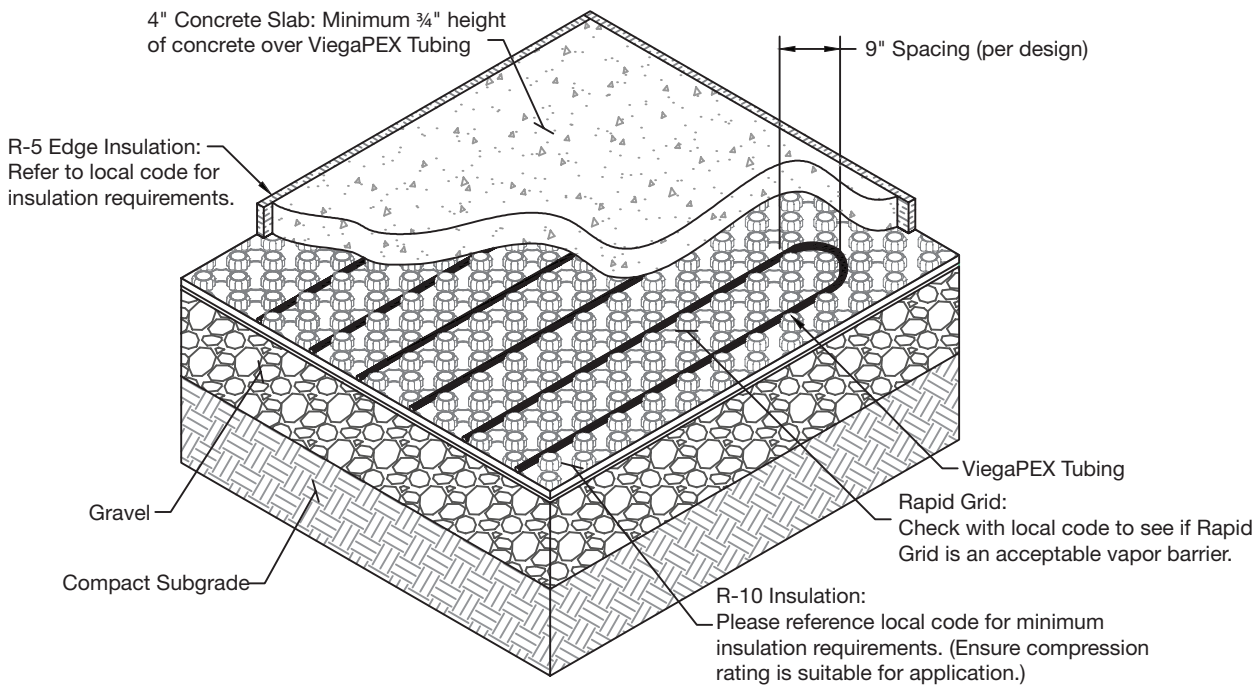
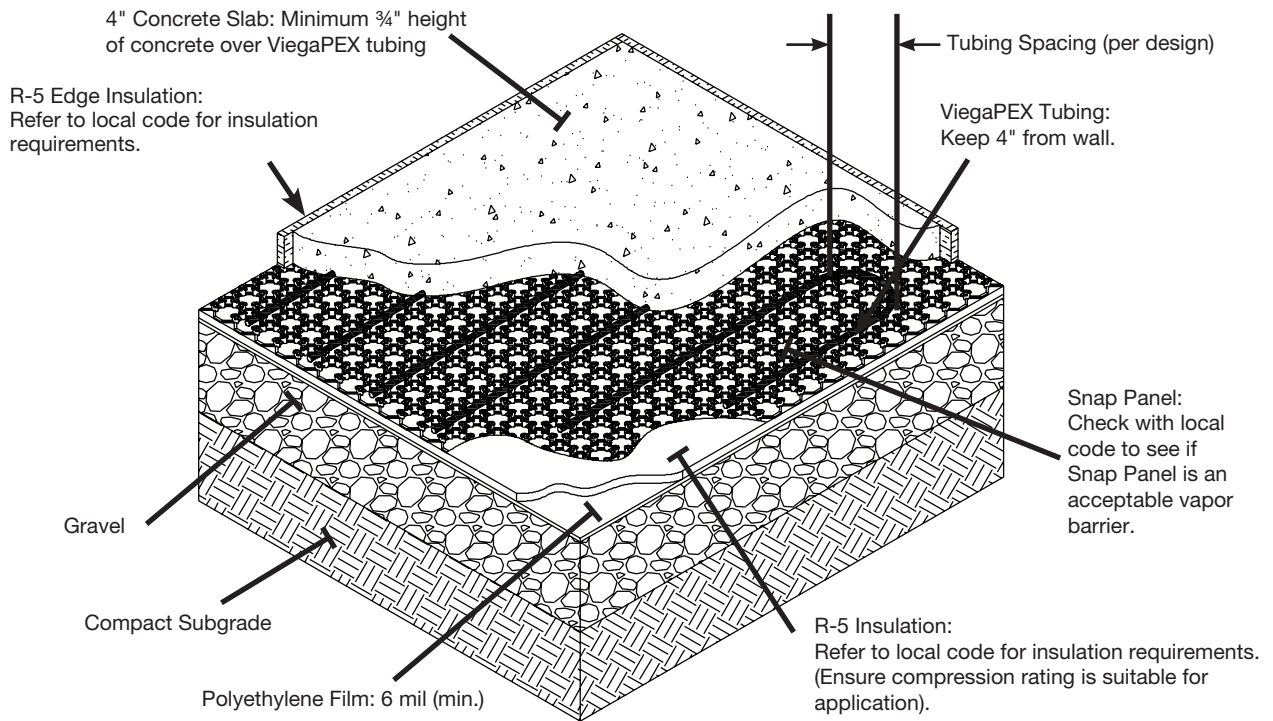
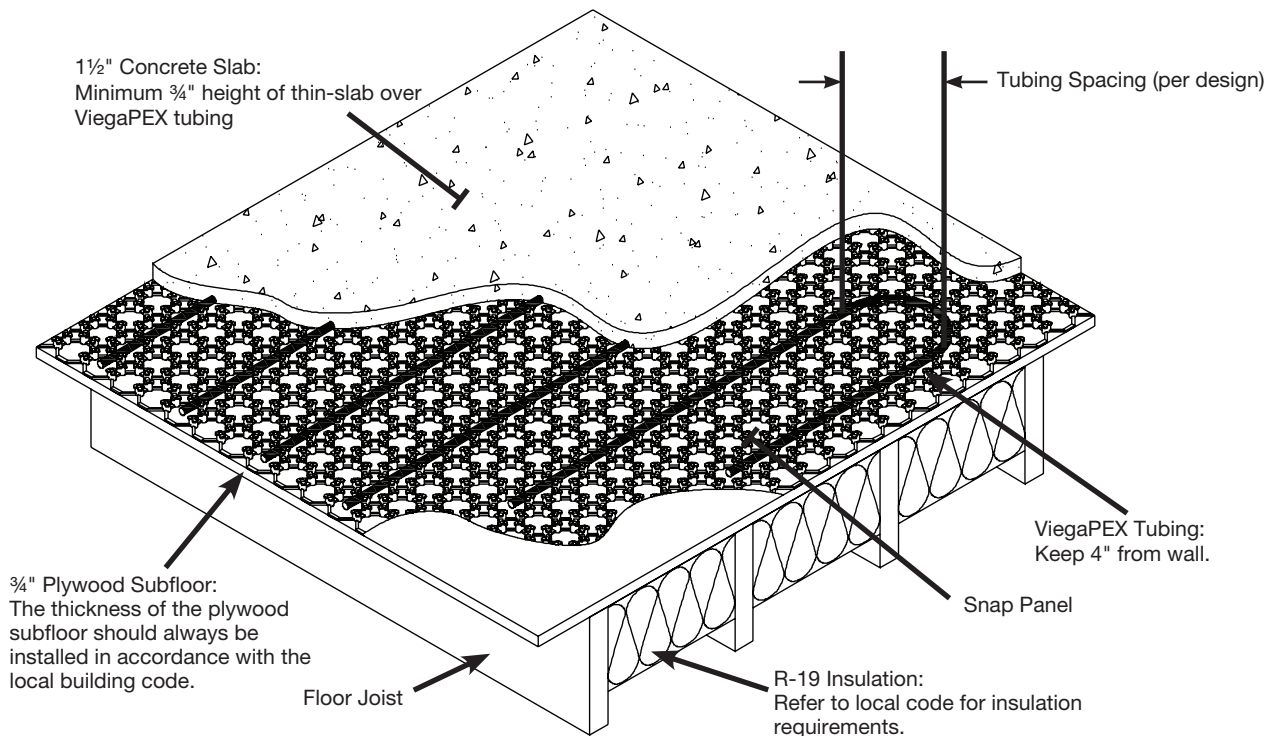


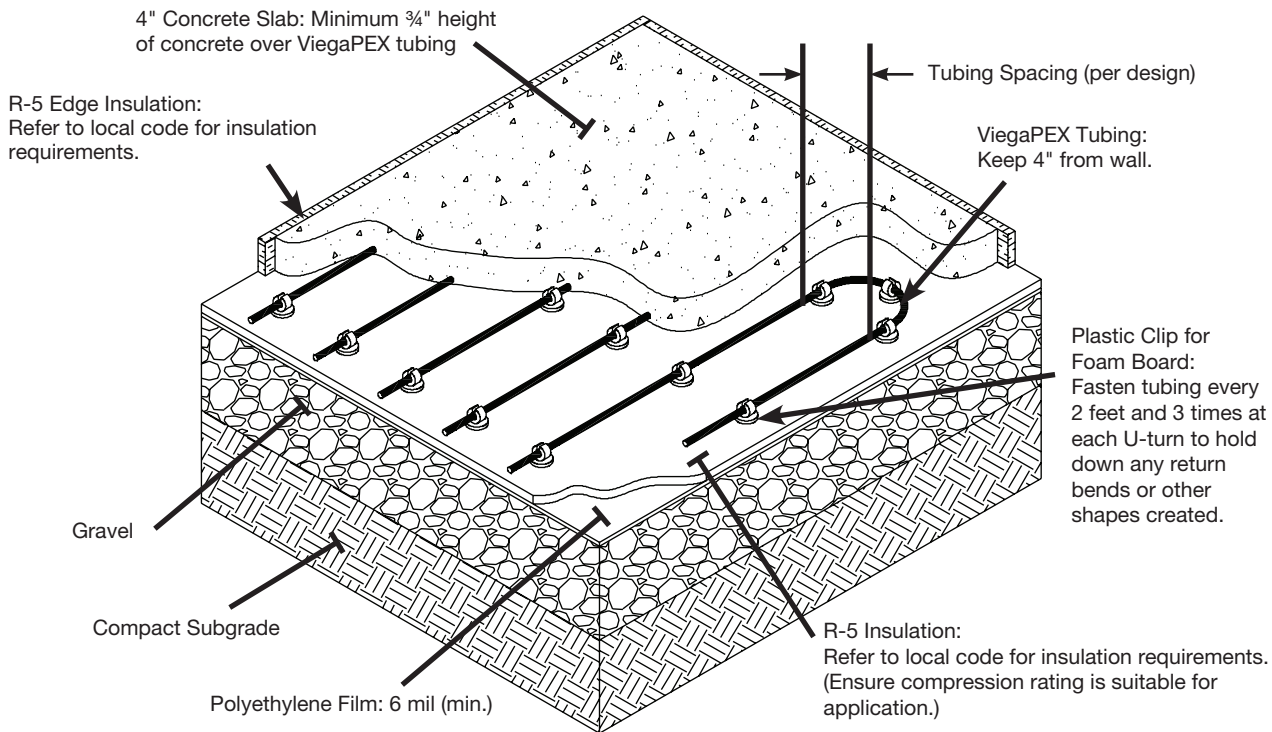
Figure B-1a  
Section through slab on or below grade installation using Rapid Grid



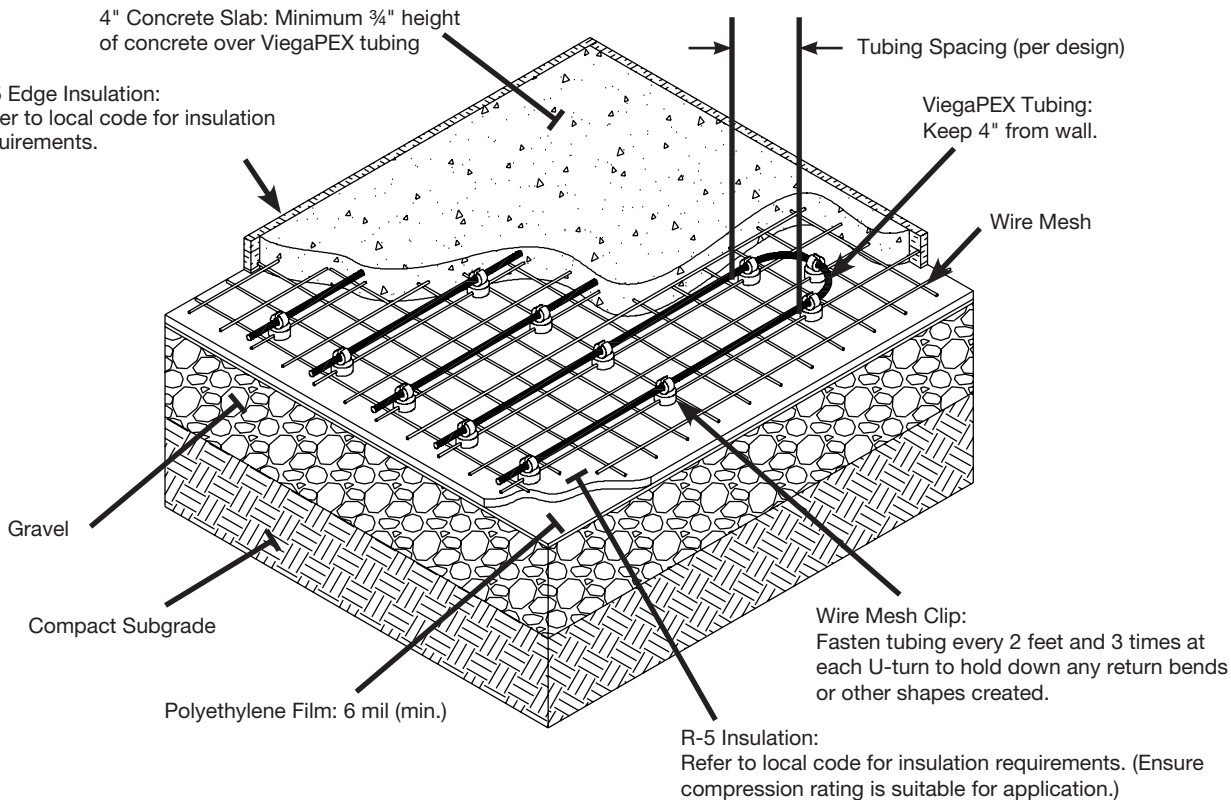
**Figure B-1b**  
Section through slab on or below grade installation using Snap Panel



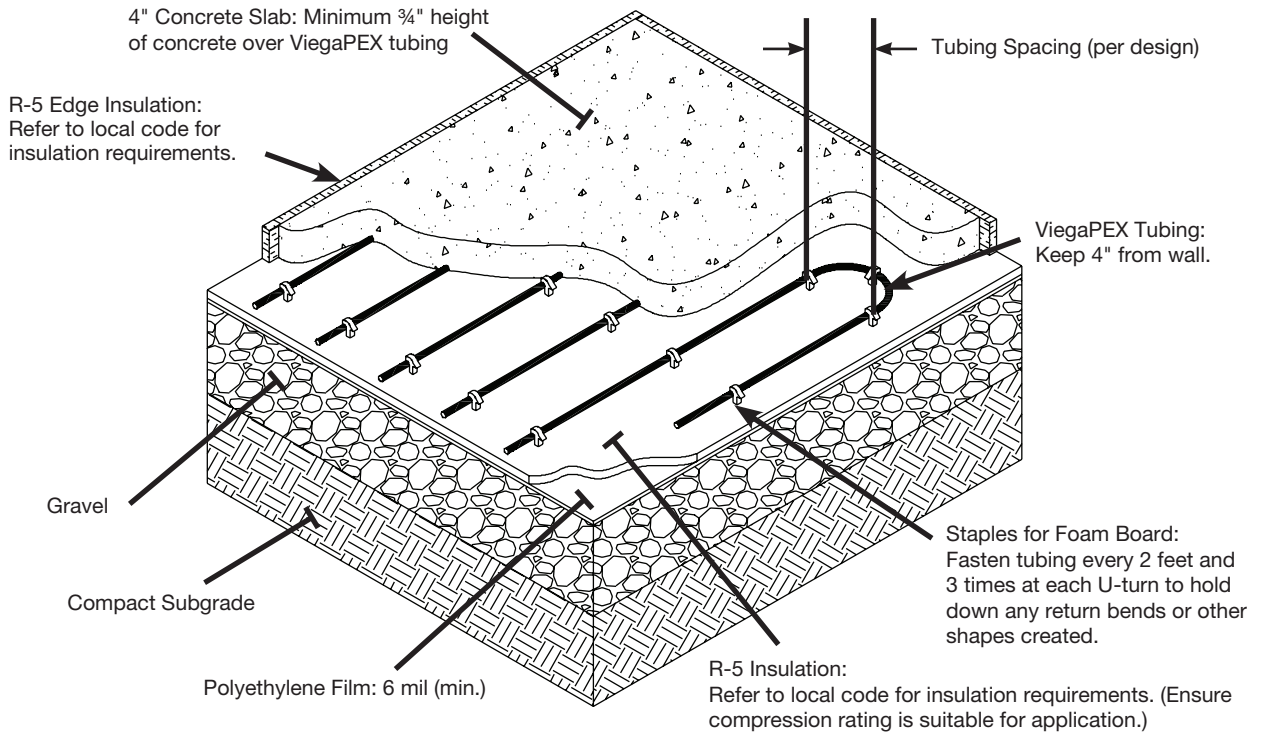
**Figure B-1c**  
Section through thin-slab installation using Snap Panel



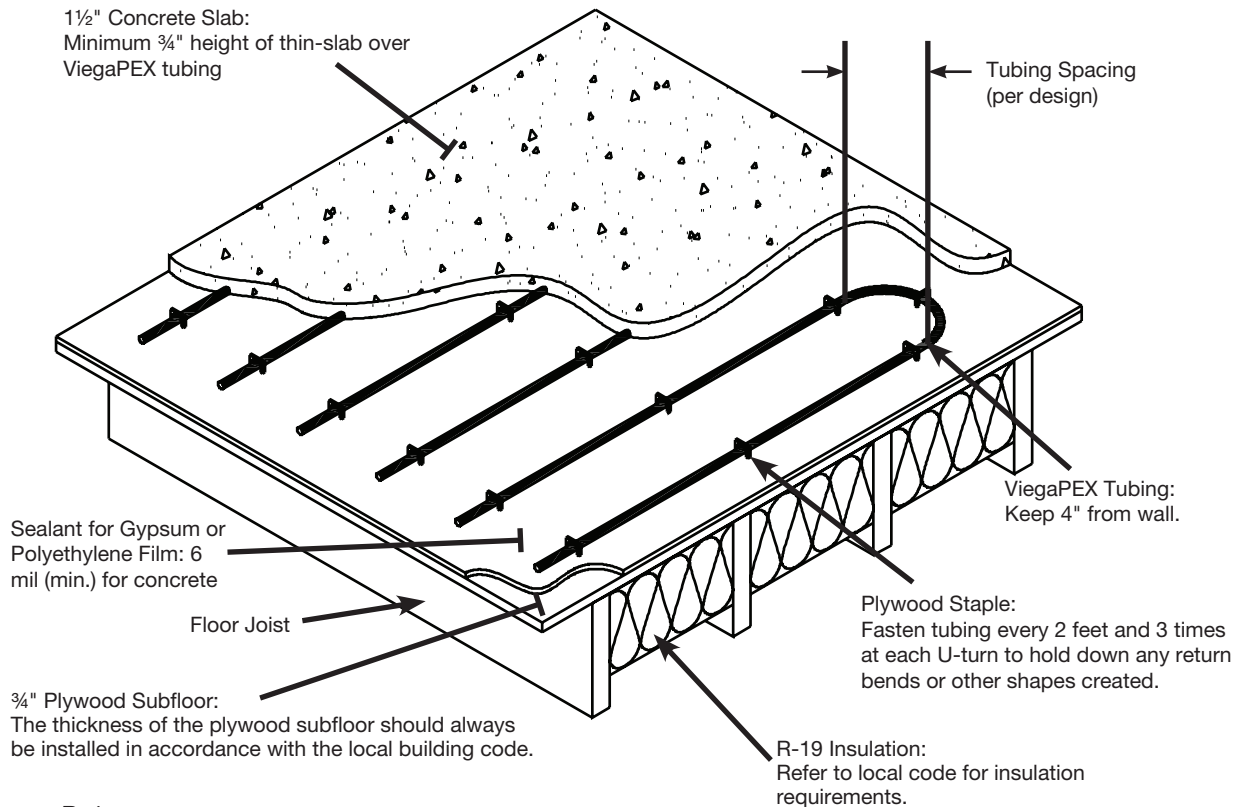
**Figure B-1d**  
Section through slab on or below grade installation using foam board clips



**Figure B-1e**  
Section through slab on or below grade installation using wire mesh clips

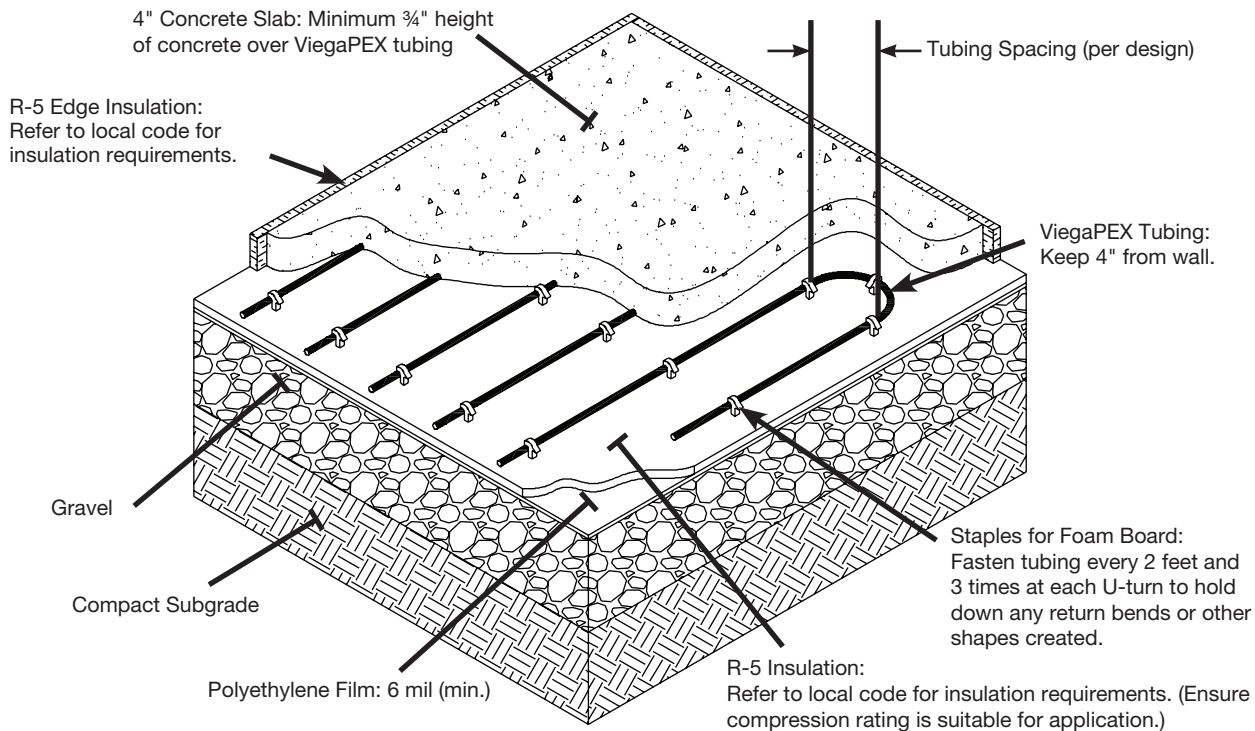


**Figure B-1f**  
Section through slab on or below grade installation using foam board staples

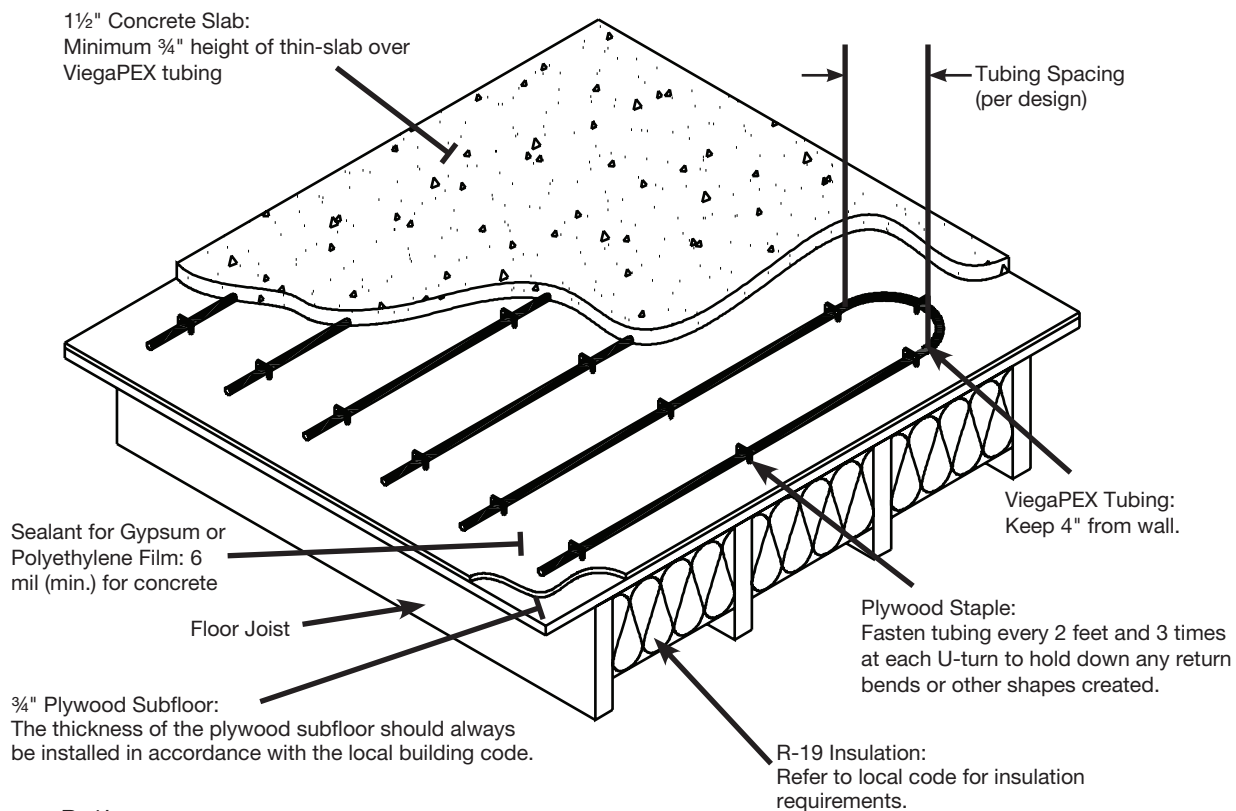


**Figure B-1g**  
Section through thin-slab installation using plywood staples

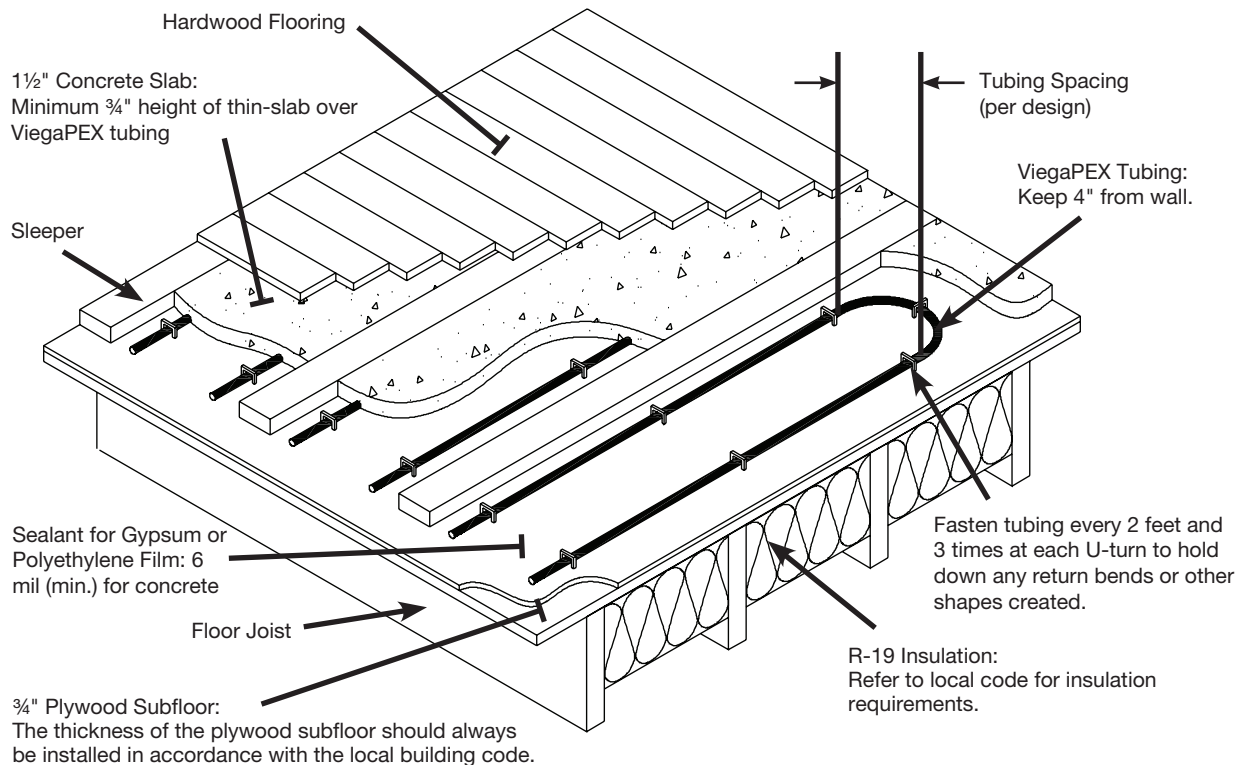




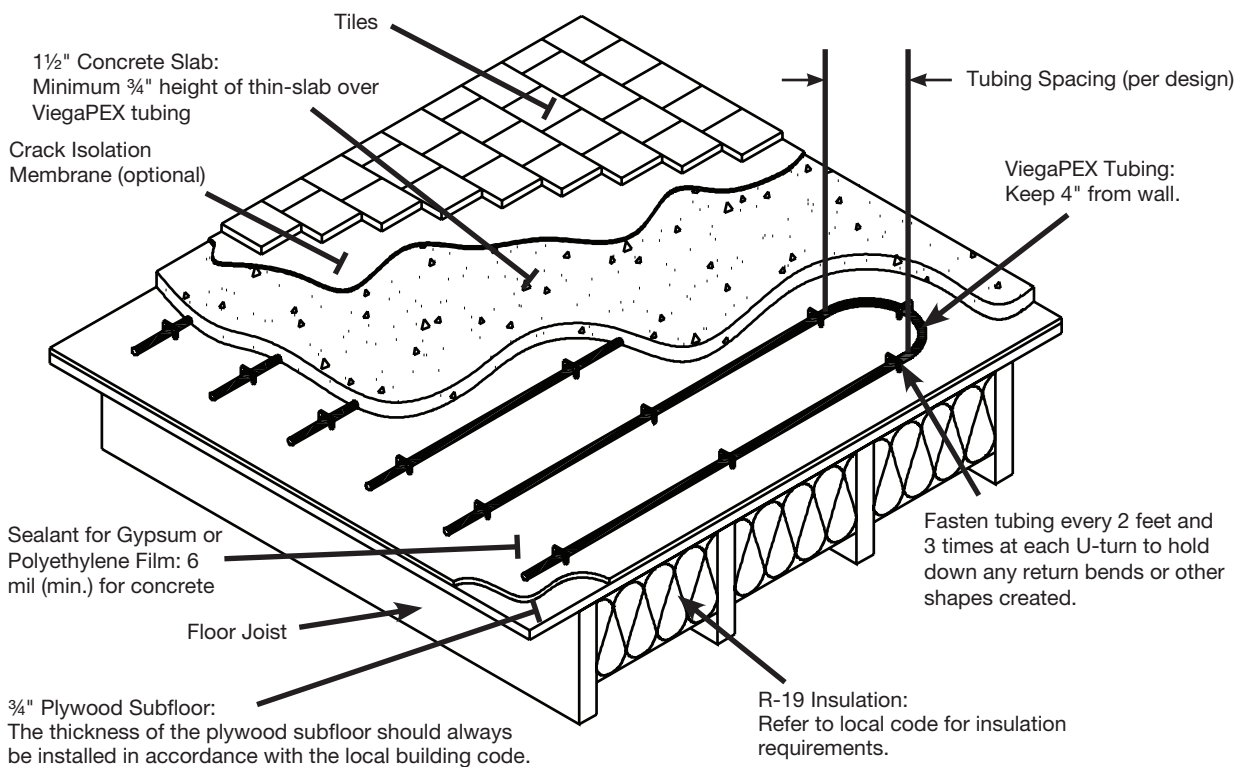
**Figure B-1h**  
Section through slab on or below grade installation using foam board staples



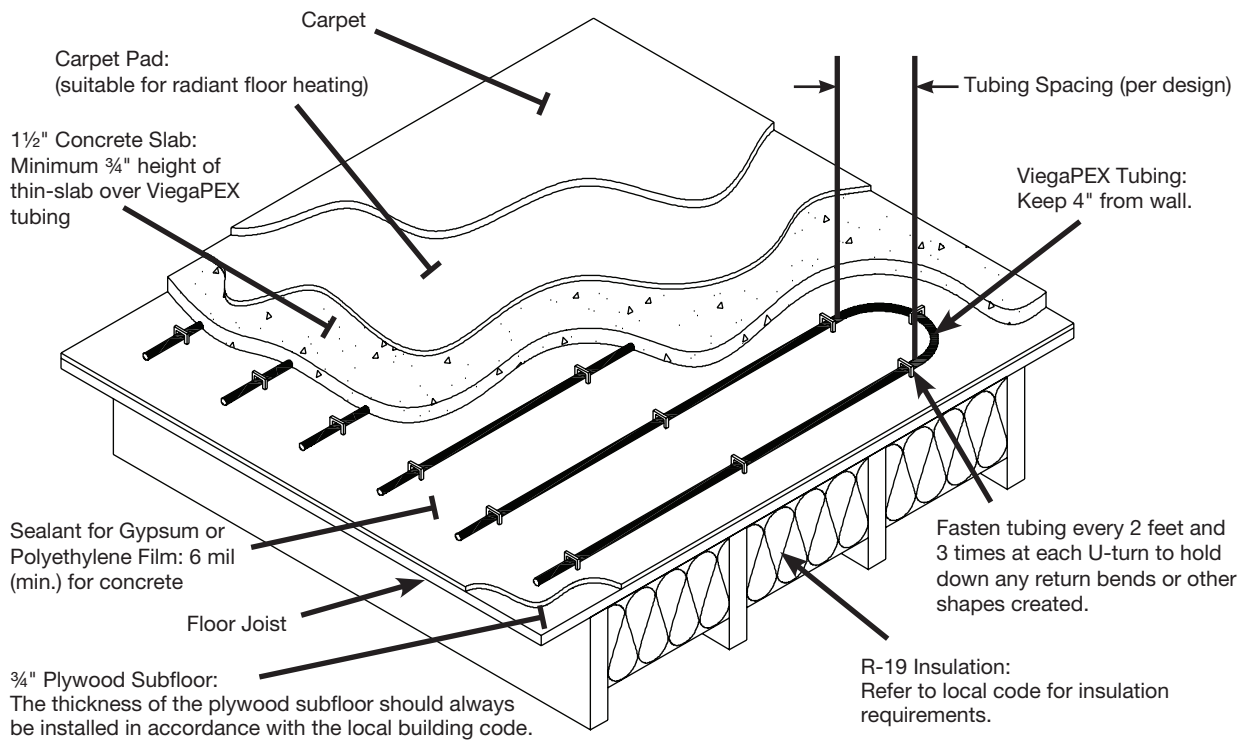
**Figure B-1i**  
Section through thin-slab installation using plywood staples



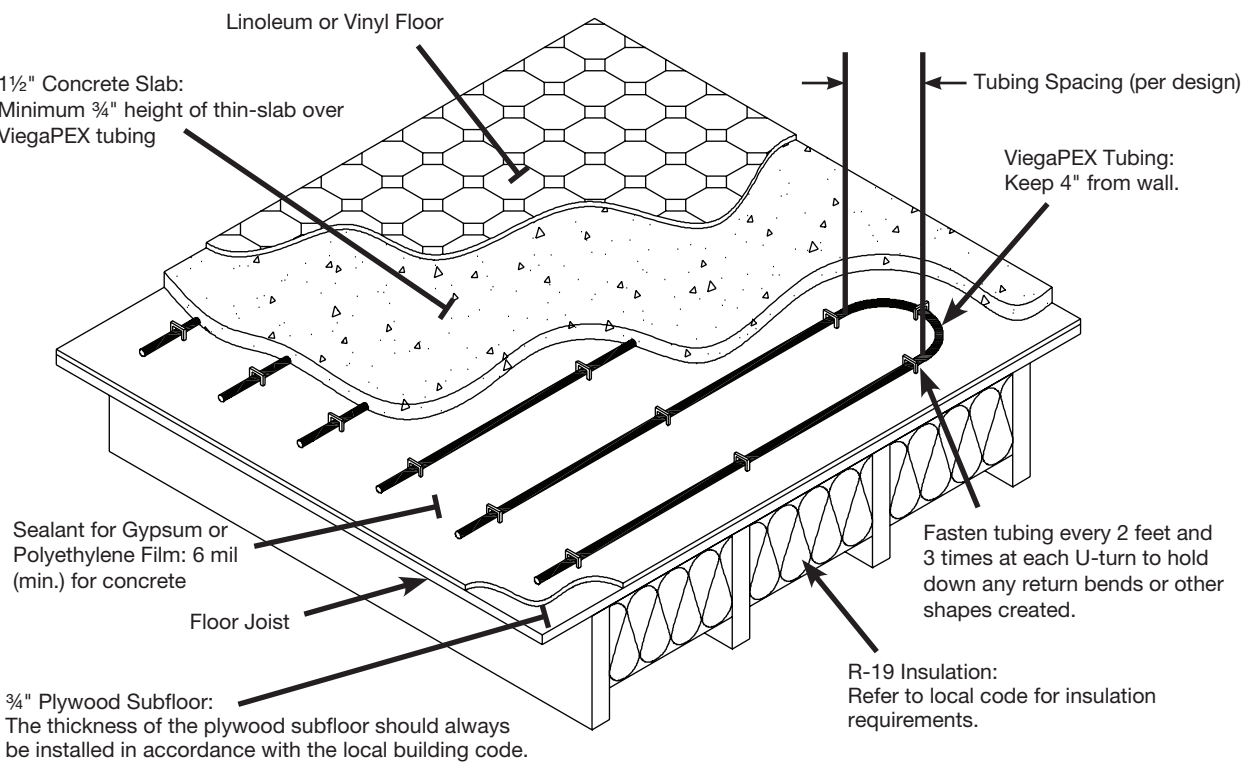
**Figure B-1j**  
Section through thin-slab installation with hardwood floor



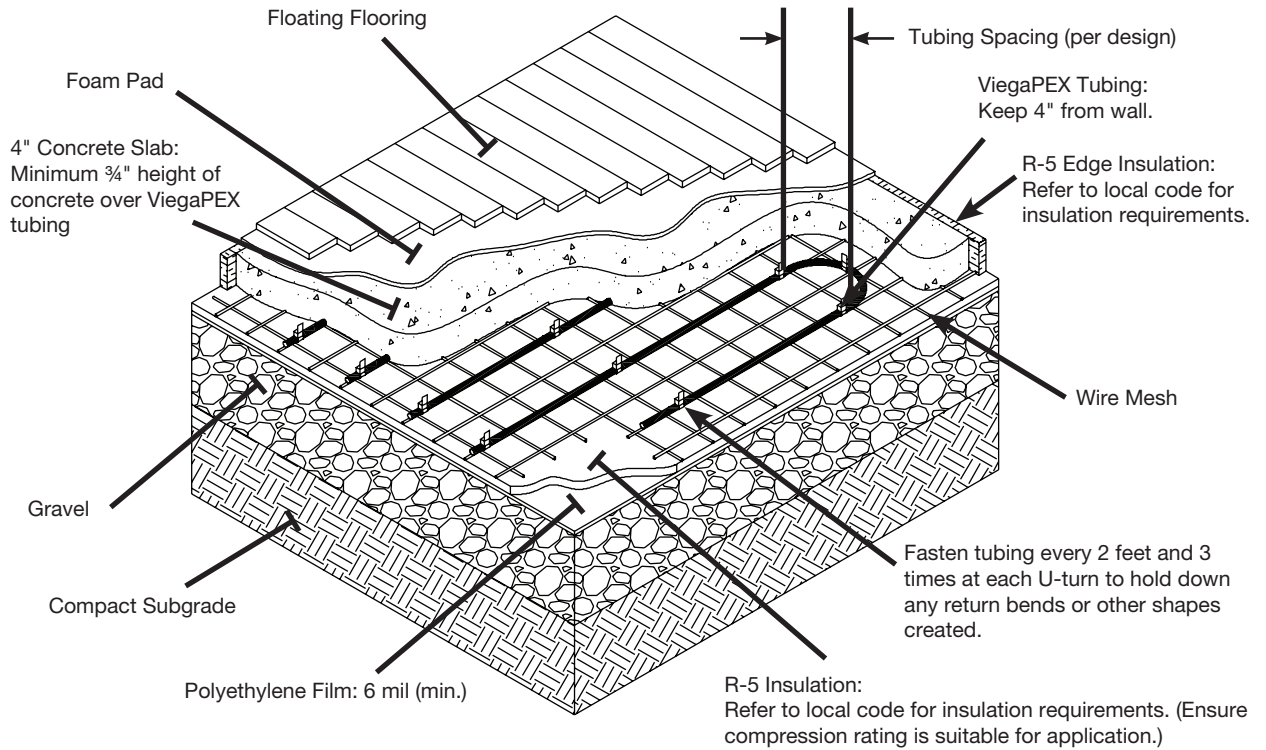
**Figure B-1k**  
Section through thin-slab installation with tiles



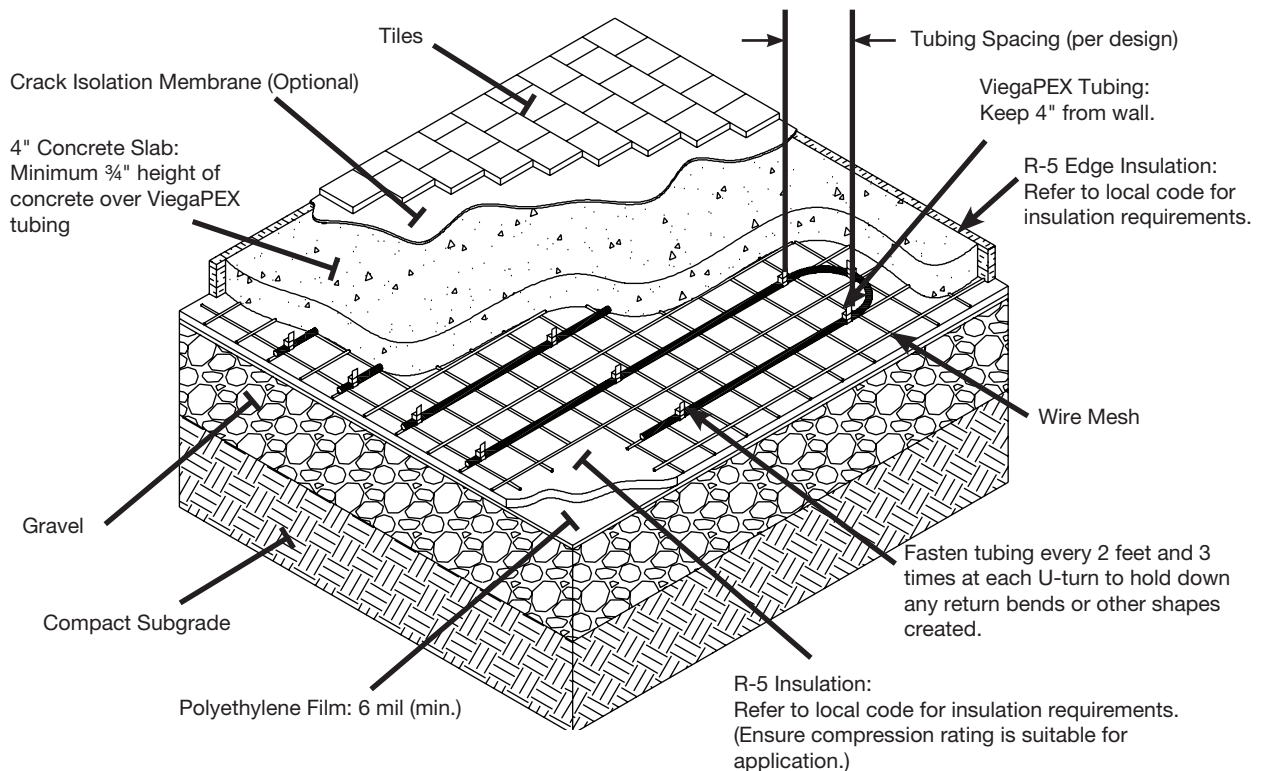
**Figure B-11**  
Section through thin-slab installation with carpet



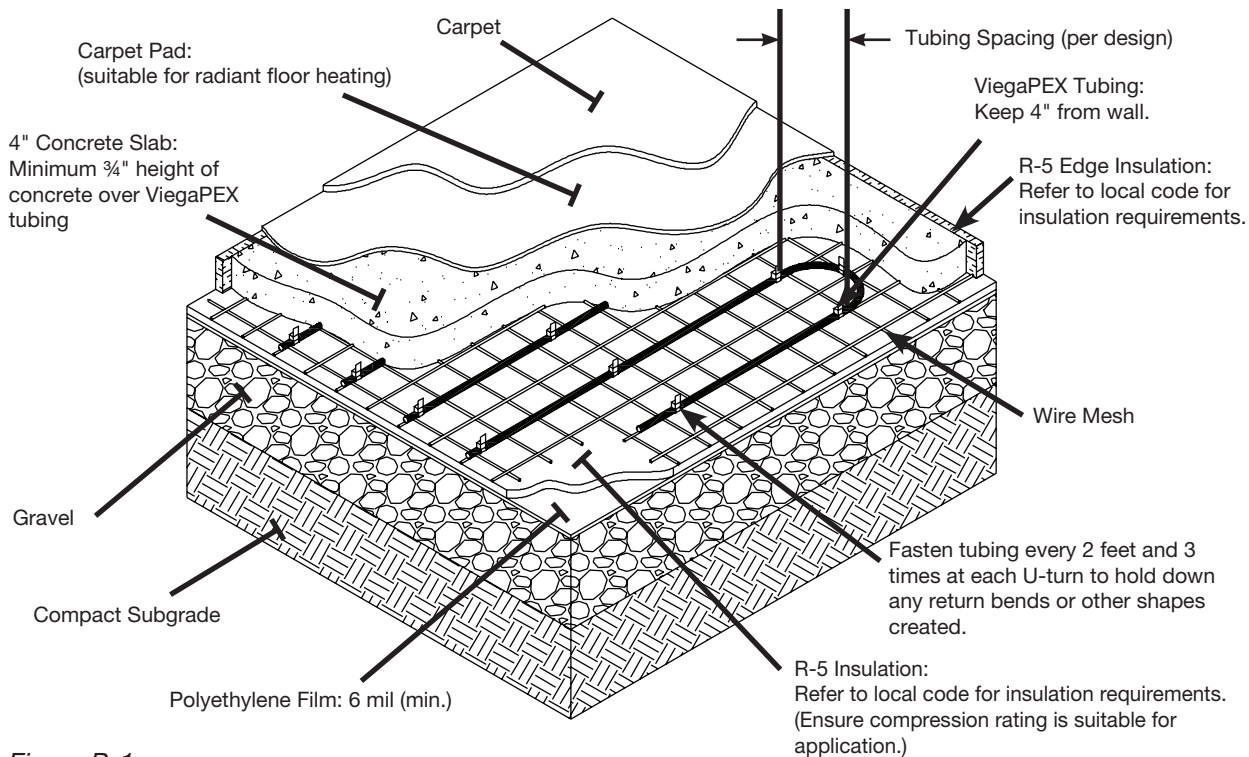
**Figure B-1m**  
Section through thin-slab installation with linoleum or vinyl finish floor



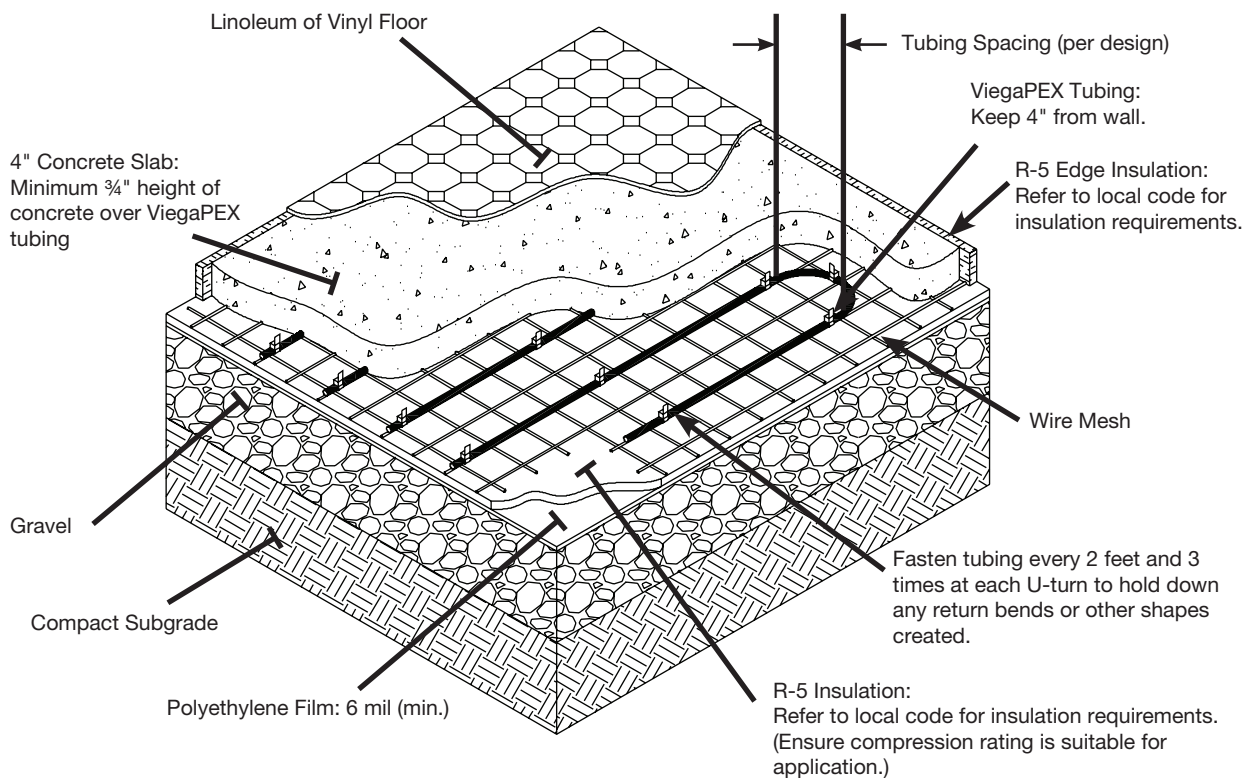
**Figure B-1n**  
Section through slab on or below grade installation with floating floor



**Figure B-1o**  
Section through slab on or below grade installation with tiles



**Figure B-1p**  
Section through slab on or below grade installation with carpet



**Figure B-1q**  
Section through slab on or below grade installation with linoleum or vinyl finish floor

### B.3 Creating a material list

The chart below is intended for conceptual purposes in developing an initial material list; there may be variations in each job. You may use Radiant Wizard to create a final material list.

#### Suspended Slabs and Thin Slab

<ul style="list-style-type: none"> <li>• Calculate the net heated area.</li> <li>• Use charts to make an initial materials list for the net area to be heated.</li> </ul>	Concrete System Tubing Estimator			
	ViegaPEX Barrier / FostaPEX Tubing	Net. Heated Area	Multiplier	Estimated Amount
	6" Spacing		2.2	
	9" Spacing		1.5	
	12" Spacing		1.1	
ViegaPEX Barrier or FostaPEX Tubing 1/2", 5/8", 3/4"				

Various Fasteners Available <ul style="list-style-type: none"> <li>• Plastic Clip for Foam Board</li> <li>• Wire Mesh Clip</li> <li>• Zip Ties</li> <li>• Wire Staples</li> <li>• Foam Staples</li> </ul>	Concrete System Material List Estimator			
	Fasteners	Net. Heated Area	Multiplier	Estimated Amount
	6" Spacing		1.1	
	9" Spacing		.75	
	12" Spacing		.55	
Fasten tubing every two feet and three times at U-turn bend				

<ul style="list-style-type: none"> <li>• Calculate the net heated area.</li> <li>• Use charts to make an initial materials list for the net area to be heated.</li> <li>• Rapid Grid panels are sold in packages of eight. (stock code # 15216)</li> </ul>	Rapid Grid Material List Estimator			
	Rapid Grid	Net. Heated Area	Multiplier	Estimated Amount
	Rapid Grid		.125	
	6" Spacing		2.2	
	9" Spacing		1.5	
	12" Spacing		1.1	
3/8", 1/2", 5/8" ViegaPEX Barrier or 1/2" FostaPEX				

<ul style="list-style-type: none"> <li>• Calculate the heated area.</li> <li>• Use charts to make an initial materials list for the net area to be heated.</li> <li>• Snap Panels are sold in packages of 18. (stock code # 15211)</li> <li>• Snap Panel buttons are available to attach product to foam insulation. (stock code # 15213)</li> </ul>	Snap Panel Material List Estimator			
	Snap Panel	Net. Heated Area	Multiplier	Estimated Amount
	Snap Panel		.08	
	6" Spacing		2.2	
	9" Spacing		1.5	
	12" Spacing		1.1	
1/2" ViegaPEX Barrier only				

**NOTES:** Where multipliers are located in the table, multiply the net heated area by the corresponding multiplier to derive the estimated amount. For example, if ViegaPEX Barrier is specified at 6" on center for 1,000 ft<sup>2</sup> of net heated area, the estimated amount of tubing required is 1,000 x 2.2 = 2,200 ft. Tubing multipliers include 10% overage for leaders.

## B.4 Layout planning

To avoid waste and to have equal circuit lengths, a carefully planned layout should be done. First, determine where the manifold should be installed. Remember the manifold must be accessible. When calculating the number of circuits, always round up. Keep the length of each circuit in the same room equal. For tubing layout around joints in concrete, refer to Section 4.1.2, Handling and protecting tubing.

Maximum Circuit Length		
Tubing	≤ 25 Btus / (hr x ft <sup>2</sup> )	≥ 25 Btus / (hr x ft <sup>2</sup> )
3/8"	300'	250'
1/2"	400'	350'
5/8"	500'	450'
3/4"	600'	750'

Table B.1 Calculating number of circuits:

Total amount of tubing ÷ maximum circuit length = # of circuits

### Maximum loop lengths

(CSA B214 Table 1)

Nominal tube size, in	Maximum loop length, m (ft)
3/8	76 (250)
1/2	91 (300)
5/8	122 (400)
3/4	152 (500)

Table B.2 Maximum length of continuous tubing from a supply-and-return manifold arrangement (See Clause 14.3.2.)

**Note:** Data for this table were compiled by the 8214 Technical Committee and are based on manufacturers' recommendations and good engineering practice.<sup>41</sup>

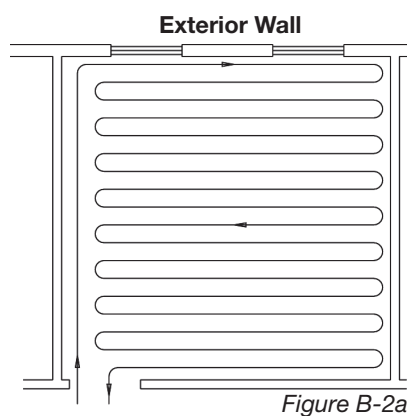


Figure B-2a  
One-Wall Serpentine  
Room has one exterior wall

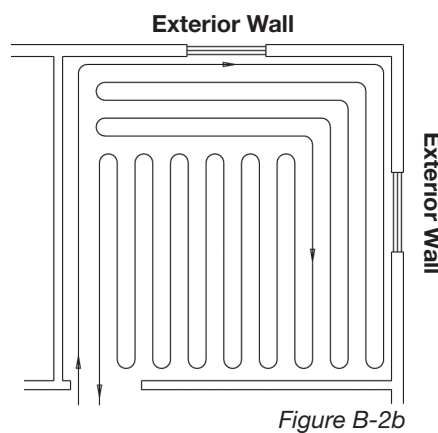


Figure B-2b  
Two-Wall Serpentine  
Room has two exterior walls

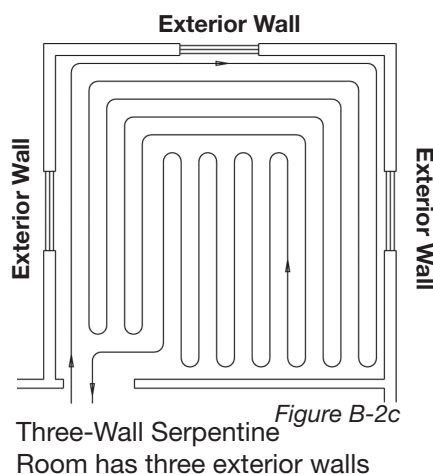


Figure B-2c  
Three-Wall Serpentine  
Room has three exterior walls

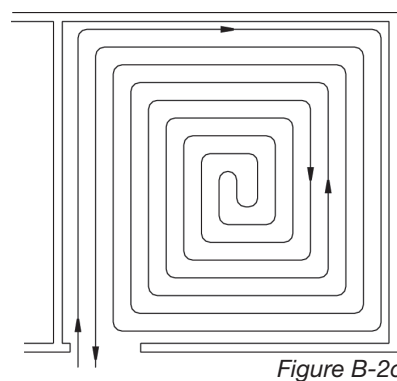


Figure B-2d  
Counter Flow  
Room has no exterior walls

Figure B-2  
Circuit layout patterns for hydronic radiant floor heating

41. ©CSA Group, B214-12. 2012. "Installation Code for Hydronic Heating Systems" Table 1

## B.5 Installation

### Step 1. Installing the insulation

Ensure that adequate insulation is installed under the slab and at the perimeter, as required based on the job's climate zone. See Section 2.2 for residential recommendations and Section 3.2 for commercial recommendations. When using foam board to insulate under slabs, weigh down the boards to prevent wind uplift. In some jobs this can be done by installing wire mesh as soon as foam boards are placed.

### Step 2. Installing the tubing

Fasten tubing every two feet and three times at each U-turn to hold down any return bends or other shapes created. It is helpful to mark out portions of each circuit directly on the insulation using spray paint.

Cross-sections of tubing protection methods at control and expansion joints in concrete may be found in Section 4.1.2, Handling and protecting tubing.

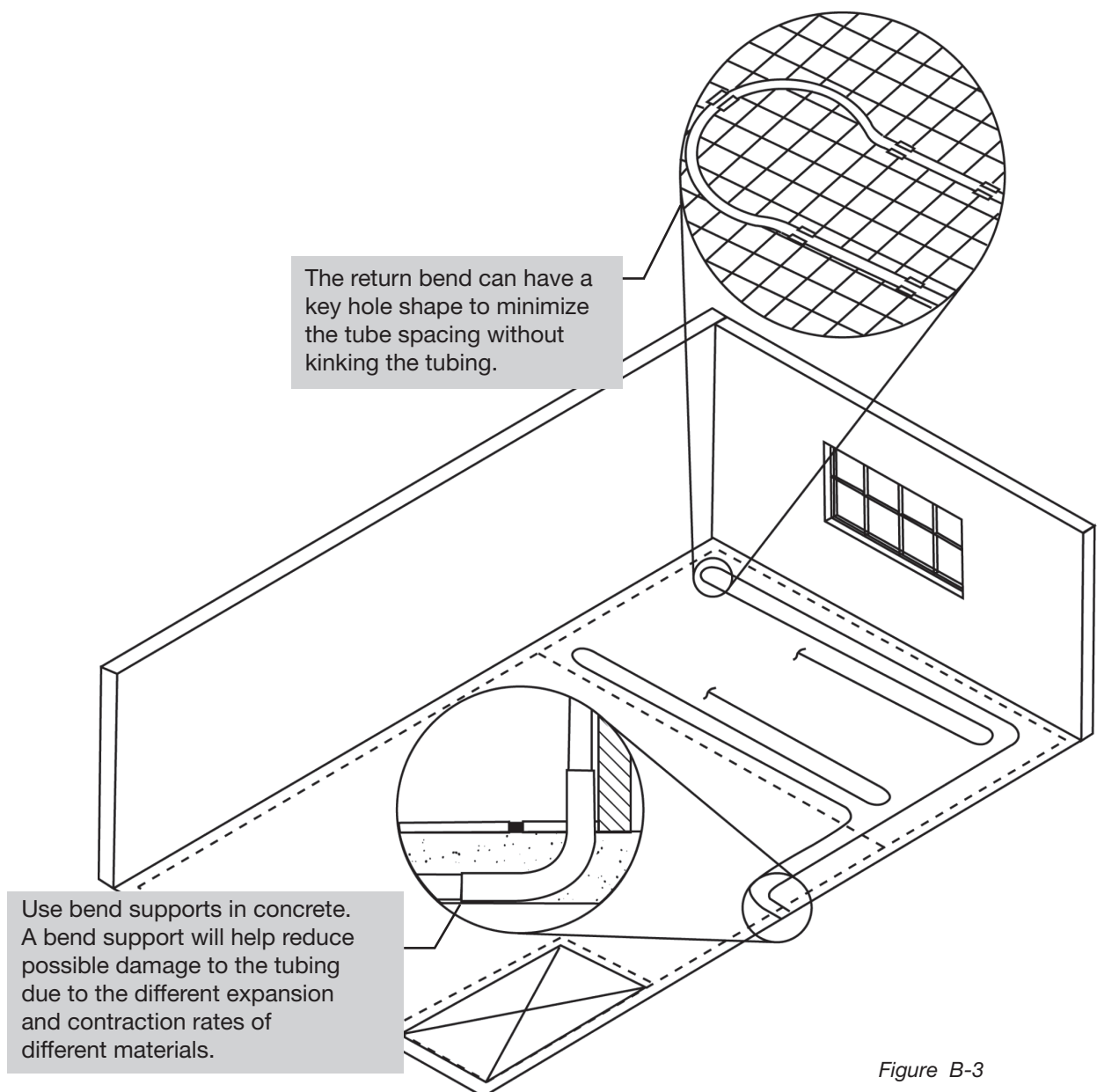


Figure B-3



### B.5.1 Rapid Grid considerations

#### Installation of the Rapid Grid panel

1. Using a box cutter or key hole saw, remove the tongue portion of the interlock from both the 4' and 2' dimensions; every time a panel touches a concrete wall the tongue should be removed so that a full 2" of insulation is in contact with the concrete.
2. Place a full panel in the upper left corner of the north wall; it is usually easiest to work from left to right.
3. Place the next panel to the right of the first panel so that it locks into the groove; the 4' dimension should be at the bottom (horizontally) and the 2' to the right (vertically).
4. Move along the first row, filling in the panels and interlocking them together.
5. Upon reaching the east wall, measure and cut the final panel to fill that row.
6. When starting the next row, begin by installing the remnants of the final panel from the previous row; this is done to eliminate waste as well as to keep the seams from lining up. If there are no remains from the previous row, a panel can be cut in half to start the next row.
7. Continue filling the rows in this manner until the floor is covered with panel.

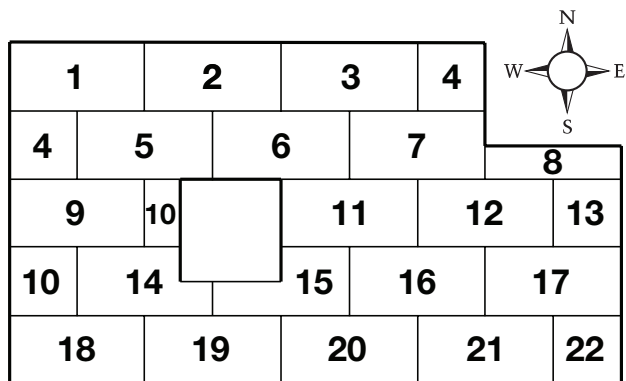


Figure B-4

#### Installing the tubing in the panel

Review your radiant design to find the proper spacing for the tubing. To ensure that the runs are properly spaced, count the number of knobs and flats in between the tubing and multiply by 3. For example, in Figure B-5 the spacing would be 9".

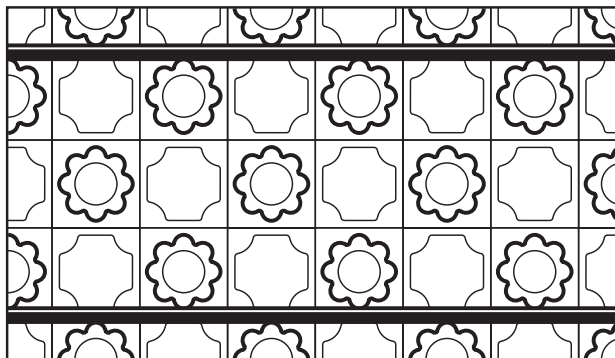


Figure B-5

The minimum spacing should be 6" on center and increase incrementally by 3" ( 6, 9, 12 ...)

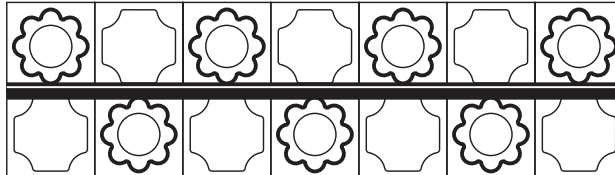


Figure B-6

1. Place the tubing between the knobs.
2. Using your hand or foot, push the tubing in between knobs.

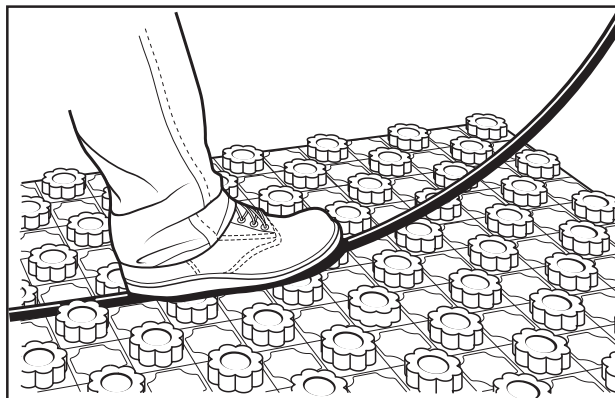


Figure B-7

3. Make sure the tubing is fully inserted in the panel and seated against the upper knobs before making a corner or beginning or continuing a run.

**NOTE:** The use of foam staples is not required for the installation of tubing in this product. However, you may find them useful in preventing the tubing from lifting at offsets or return bends. Foam staples can be installed by hand or with the use of a Viega foam staple gun. Both lengths of Viega staples (part number 15313 or 15312) are compatible with Rapid Grid.

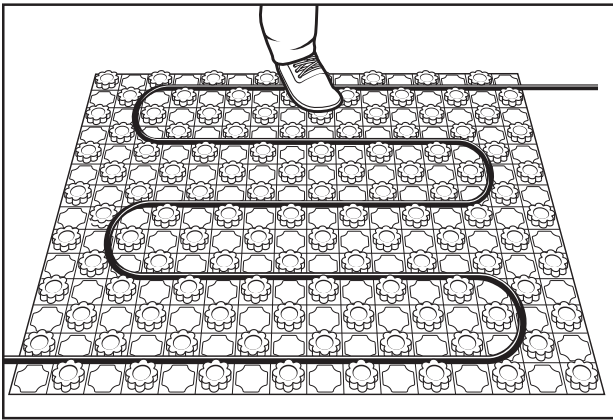


Figure B-8

4. Continue installing the tubing until the entire area has been completed.
5. The tubing should start and end at the manifold location.

**NOTE:** If concrete is not poured immediately upon installation of Rapid Grid, care should be taken to protect the products from lifting due to adverse weather conditions. This can be done by adding temporary weighting to the perimeter of the floor area. Caution should be taken as to not damage the tubing or Rapid Grid panels.

### B.5.2 Snap Panel considerations

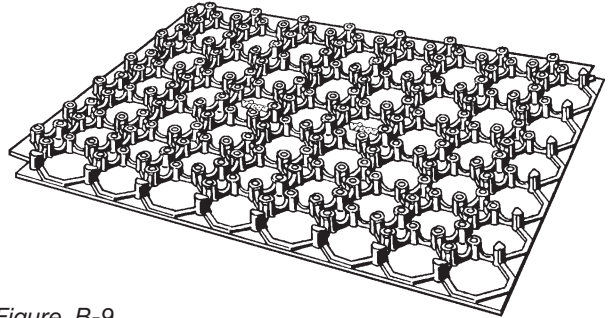


Figure B-9

#### Applications

Viega Snap Panel is a plastic grid fastening system that accepts 1/2" ViegaPEX Barrier tubing for slab and lightweight concrete pour radiant applications. The unique grid pattern allows for tubing to be laid out in both straight and diagonal directions.

#### Features

- Lightweight, making it easy to install
- Can be used with all types of insulation
- If installed properly can serve as a vapor barrier
- Easily cut with utility knife
- Compatible with 1/2" ViegaPEX Barrier tubing
- Spacing 6", 9", 12", etc., on 3" intervals

#### Material

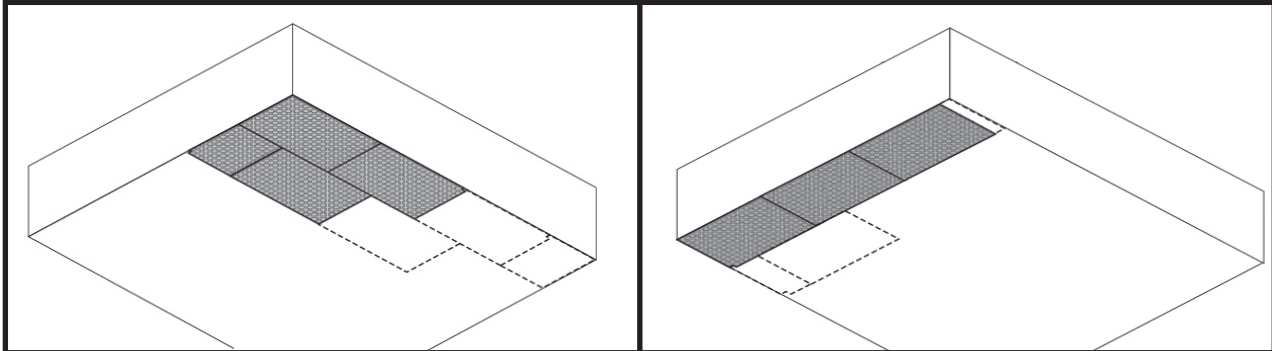
High-density polystyrene  
 Compressive strength 1,250 psf  
 Dimensions 3'x 5'x 1"  
 Spacing in between fasteners 3"

#### Specifications

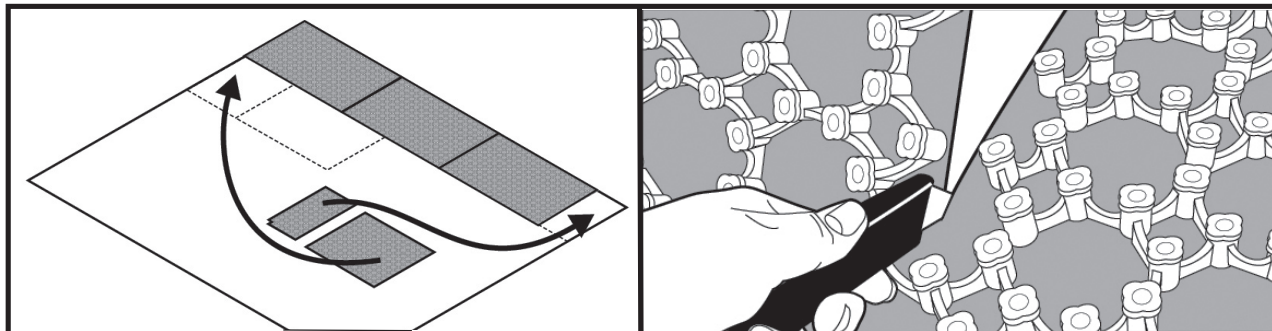
Individual: 1 panel (15 sq. ft.)  
 3' x 5' x 1"  
 3.4 lbs

Packaging: 18 panels (240 sq. ft.)  
 61" x 38" x 8"  
 61.2 lbs/pkg

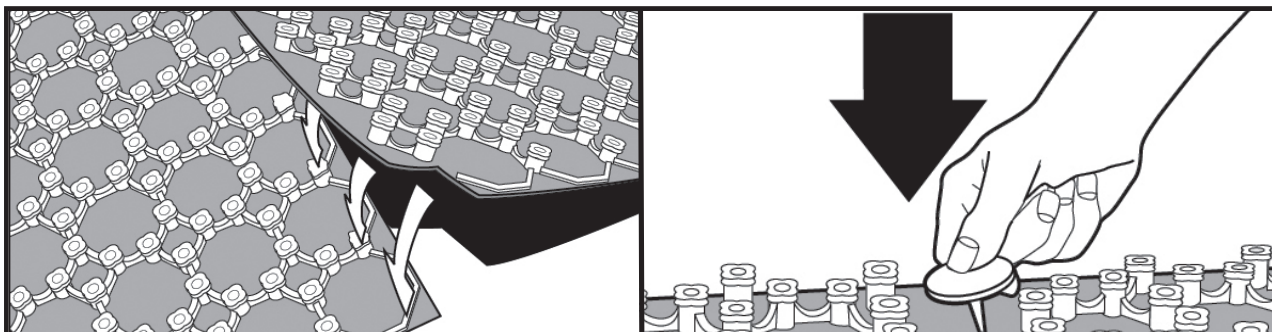
**Installation**



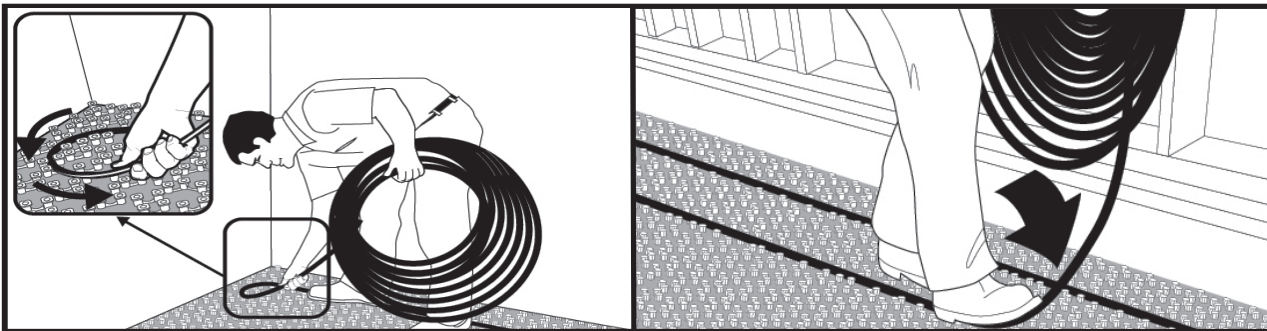
**Step 1.** Snap Panel can be installed in any orientation. The illustrations above show Snap Panels being installed in two different manners; either is correct. Snap Panel should be run in the direction that creates less cutting waste.



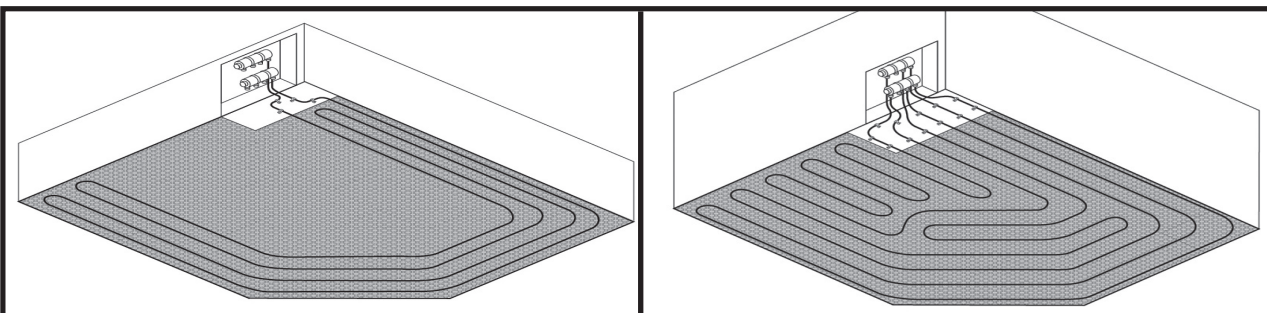
**Step 2.** Offset Snap Panel seams to help lock the floor together and prevent shifting while installing the ViegaPEX Barrier tubing. Use a utility knife to cut panels.



**Step 3.** Overlap the Snap Panel edges to use as a vapor barrier. Snap Panel buttons are used to lock the panels together.



**Step 4.** ½" ViegaPEX Barrier tubing can be walked into the Snap Panel. Tubing can be installed in any direction in multiples of 3".



**Step 5.** Start by installing tubing on the perimeter of the room. If there are any exterior walls, start in those areas first. Work the loops inward and back to the manifold.

**NOTE:** If concrete is not to be poured immediately upon installation of Snap Panel, care should be taken to protect the installation from lifting due to adverse weather conditions. This can be done by adding temporary weighting to the perimeter of the floor area. Caution should be taken as to not damage the tubing or Snap Panel.

*Step 3. Considerations for thin-slabs*

Some installation methods call for the thin-slab to be constructed before any exterior walls or interior partitions are erected. To prevent bonding, all edges of the base plates that will be in contact with the concrete slab should be coated with a suitable release agent compatible with PEX tubing.

*Concrete thin-slabs*

The following may be added to the mixture for flowability and reduced shrinkage to minimize cracking: super plasticizer, water-reducing agent and fiberglass reinforcing.

*Gypsum thin-slabs*

Gypsum thin-slabs are usually installed after the walls have been closed in with drywall or other finish materials. The highly flowable gypsum

mix fills in any gaps between the drywall and the subflooring, reducing air leakage and sound transmission under walls.

*Step 4. Pressurizing the tubing*

Follow the instructions in Section 4.2.1 for pressure testing the tubing. All tubing must be pressure tested prior to and during pour.

*Step 5. Warming up the slab*

Follow the instructions in Section 4.2.4 for warming up the slab.

*Step 6. Testing the concrete for excessive moisture*

Follow the instructions in Section 4.2.4 for ensuring that the slab is sufficiently dry prior to applying finish flooring.

## C.1 Overview

Climate Traks and Heat Transfer Plates are designed for retrofit applications or in applications where the buildup above the subfloor is a concern. These types of applications are not the most efficient kind of radiant heating systems but deliver the comfort of having warm floors and full radiant heating throughout the house. Both methods utilize ViegaPEX Barrier tubing and attach directly to the underside of the subfloor. This is a fast, lightweight application to install and provides the comfort of radiant heat the homeowner is looking for.

### Climate Trak:

1. Heavier aluminum than the Heat Transfer Plates
2. Fastest installation time (does not require Groove Tube)
3. Easiest to install (Traks and tubing are installed separately, so there is no struggling with the tubing while the fastening is being done)
4. Predrilled holes for ease of fastening with screws
5. Comes in 4' or 8' long Traks that also help with installation time
6. Snap-in groove for tubing maximizes contact between the aluminum and the PEX tubing for efficient heat transfer

### Heat Transfer Plates:

1. Made from thinner, more flexible aluminum than the Climate Traks
2. Comes in 19" long by 5" wide plates
3. Requires a small bead of Groove Tube down the channel where the tubing is run right before installation

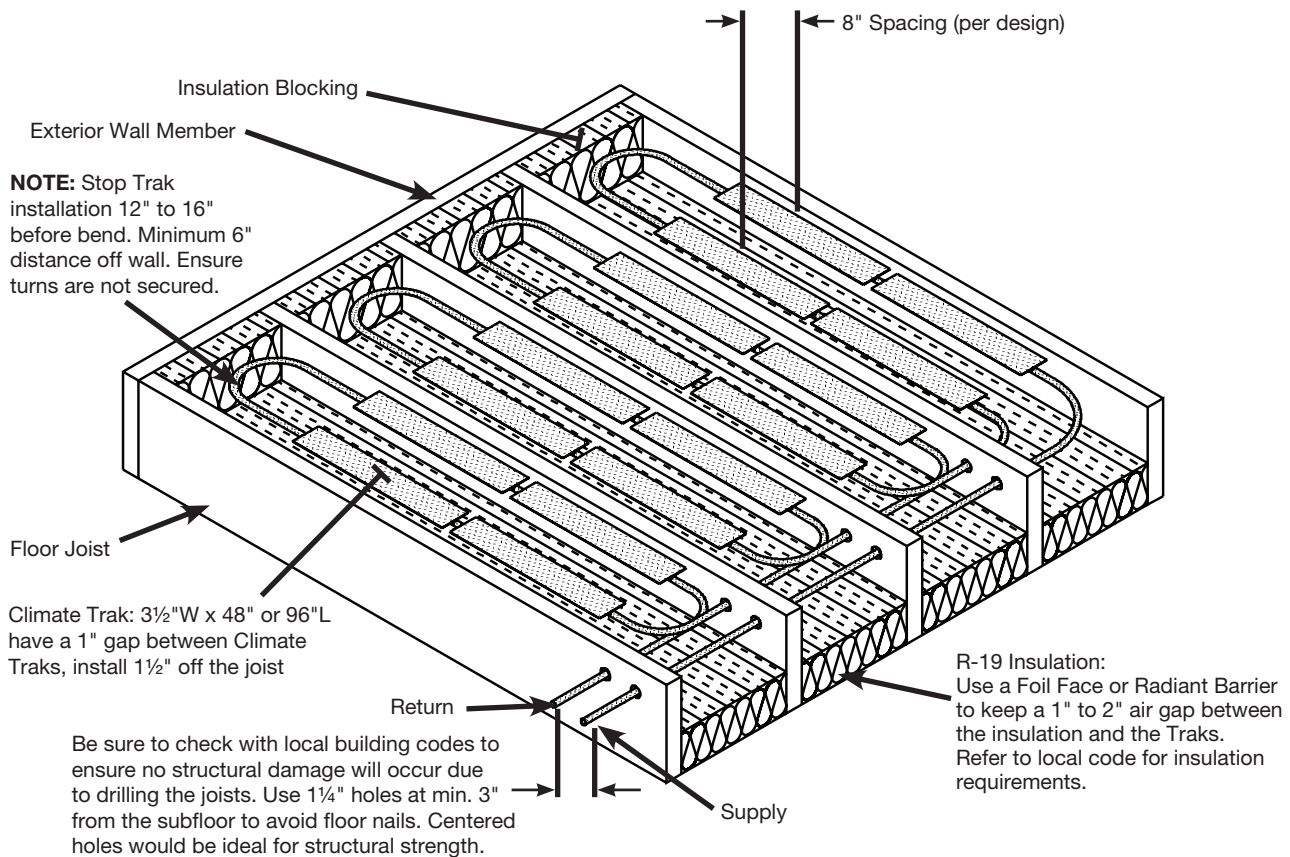


Figure C-1a  
Section through joist with Climate Trak

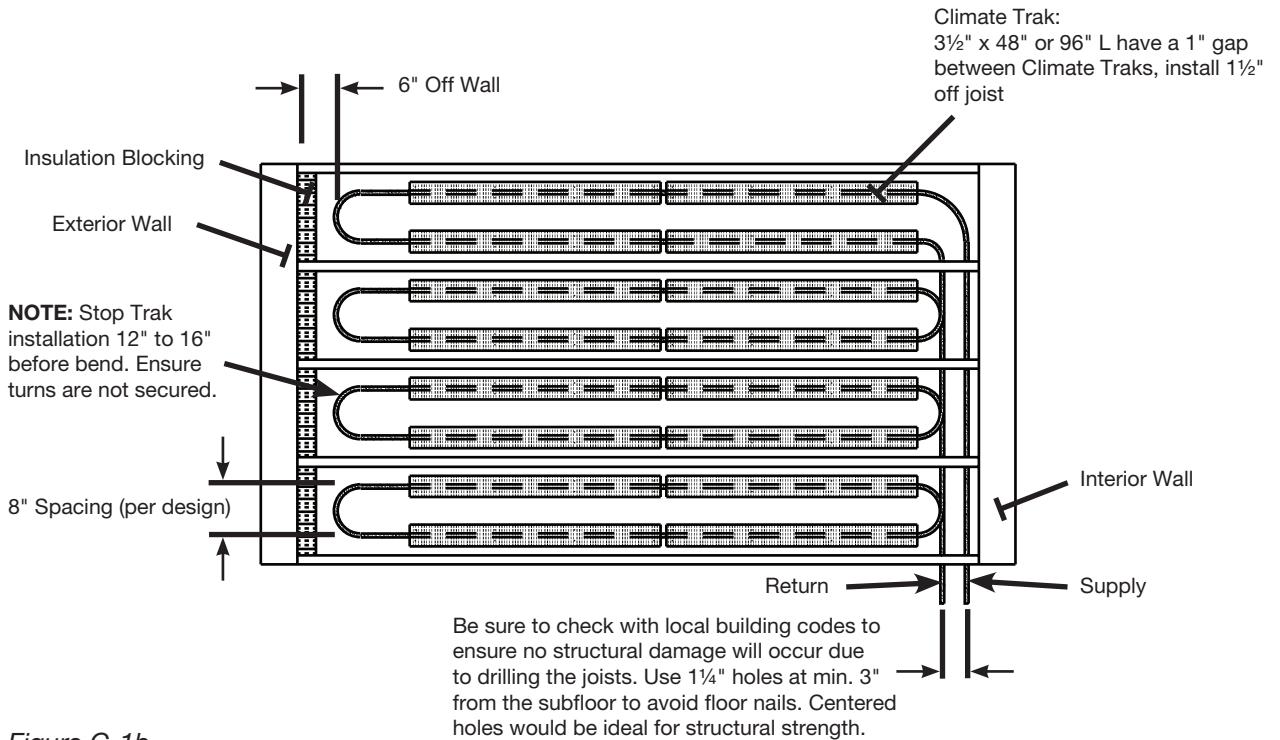


Figure C-1b  
Joist space layout -- Climate Trak

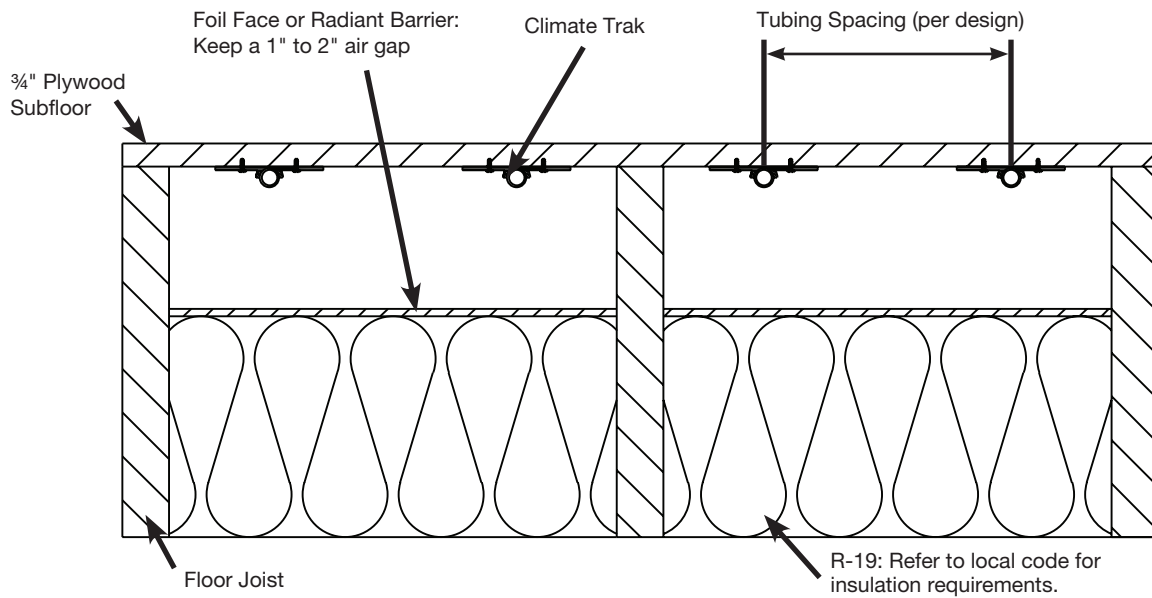


Figure C-1c  
Joist space section -- Climate Trak

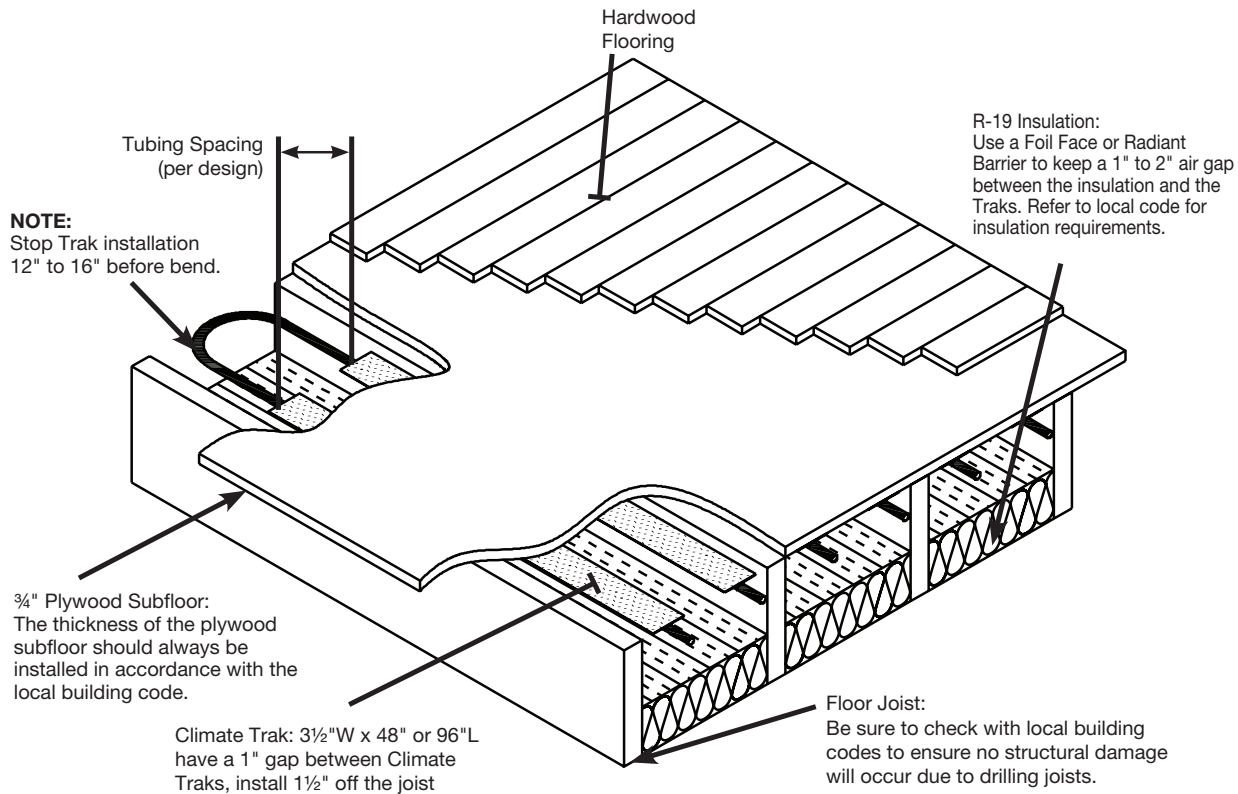


Figure C-1d  
Section through Climate Trak installation with hardwood finish floor

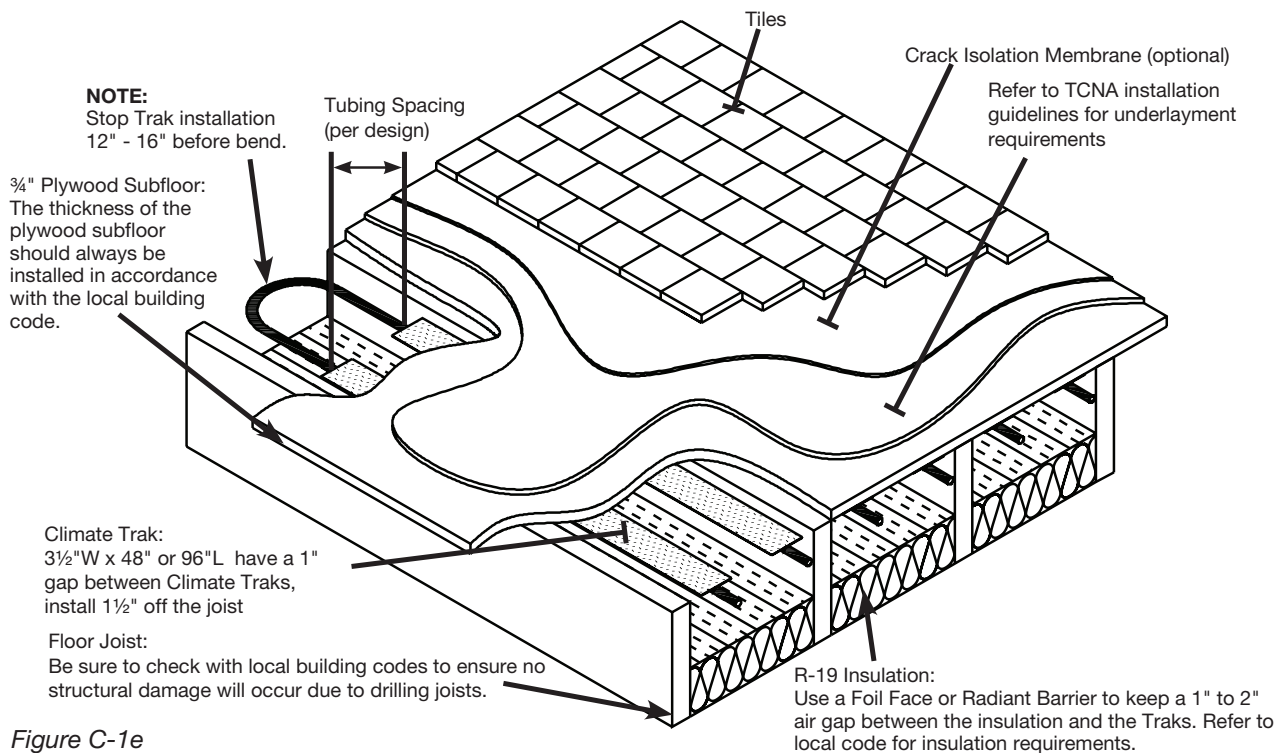
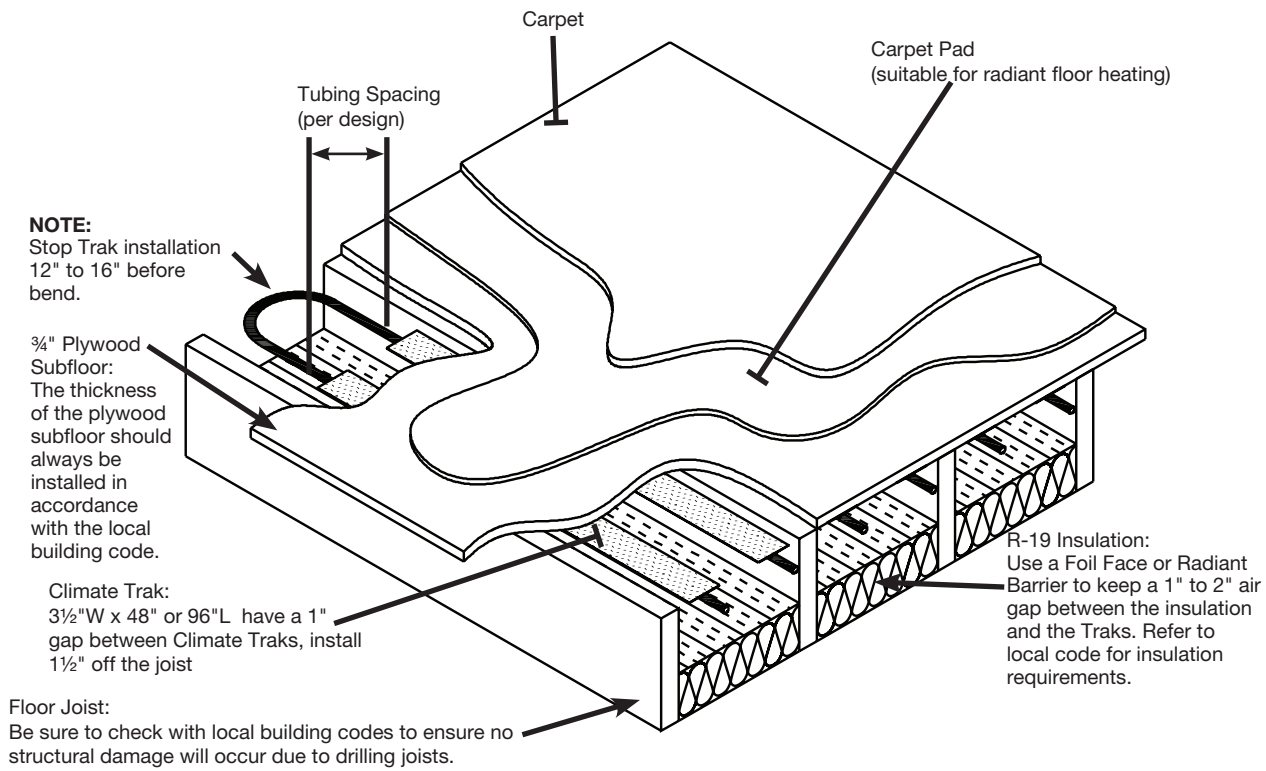
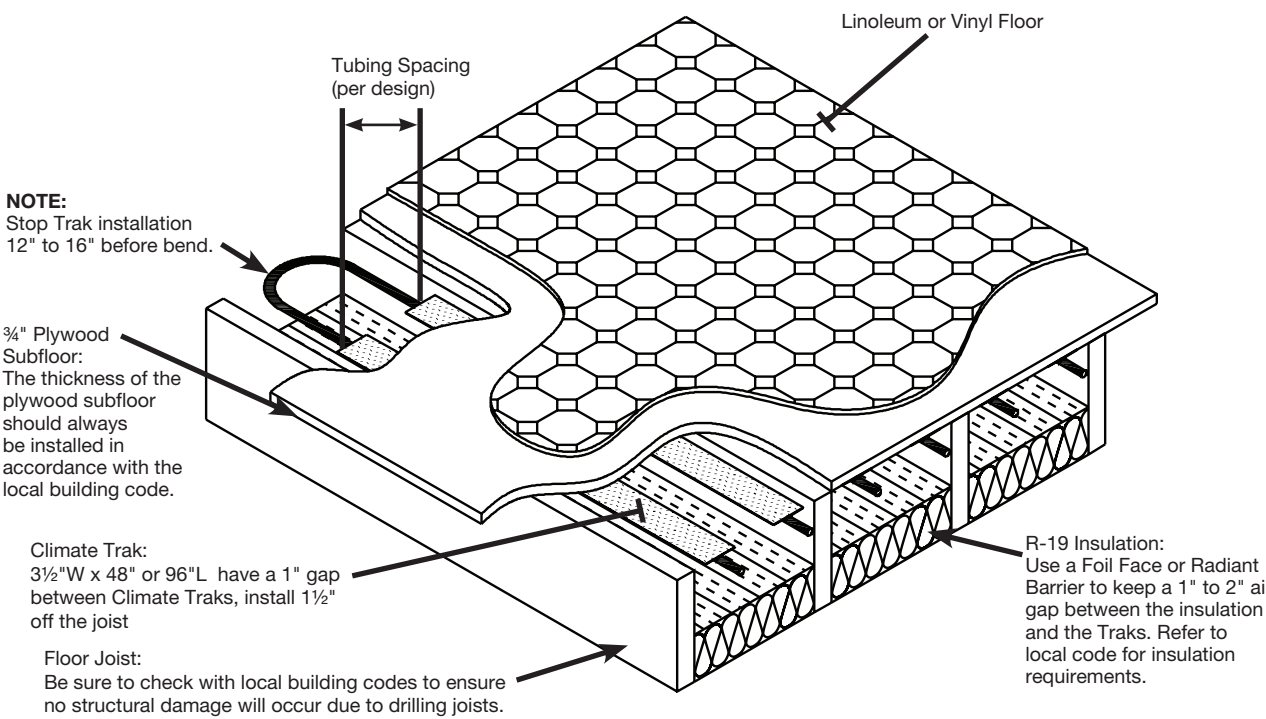


Figure C-1e  
Section through Climate Trak installation with tiles



**Figure C-1f**  
*Section through Climate Trak installation with carpet*



**Figure C-1g**  
*Section through Climate Trak installation with linoleum or vinyl finish floor*



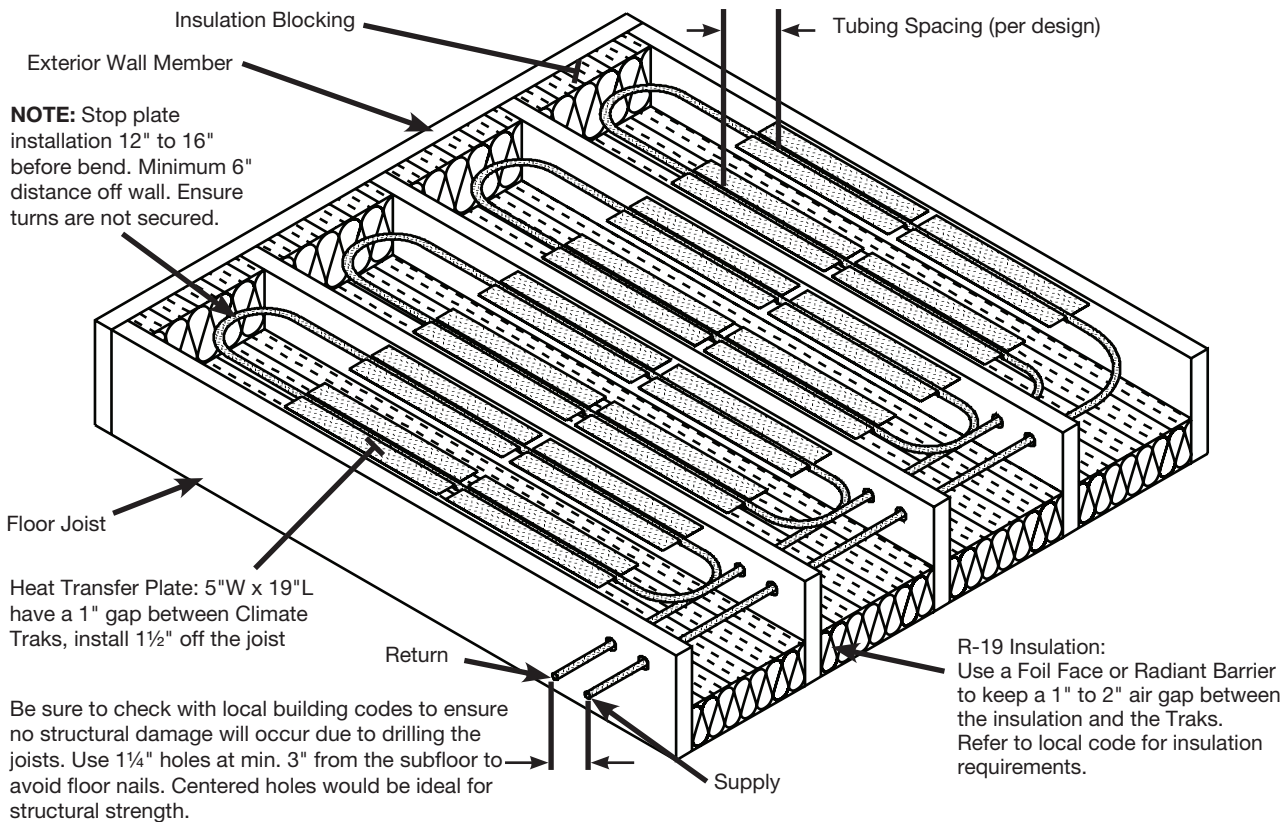


Figure C-1h  
Section through joist with heat transfer plate

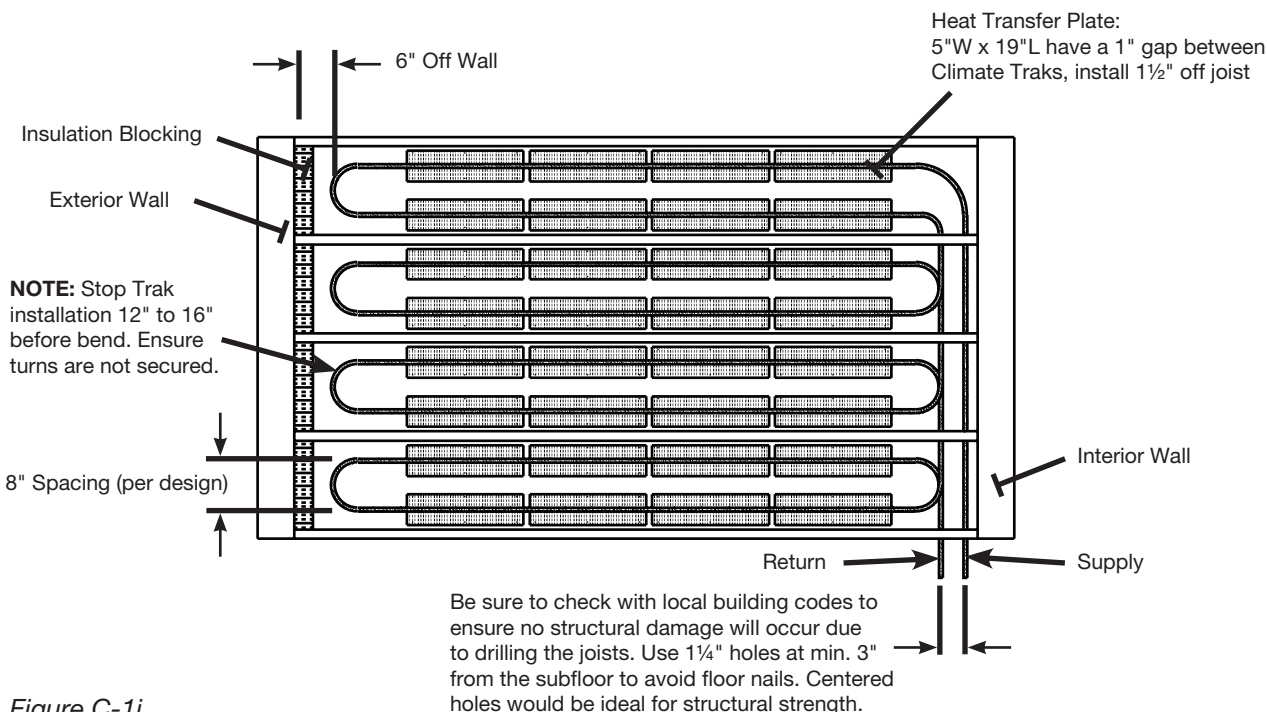
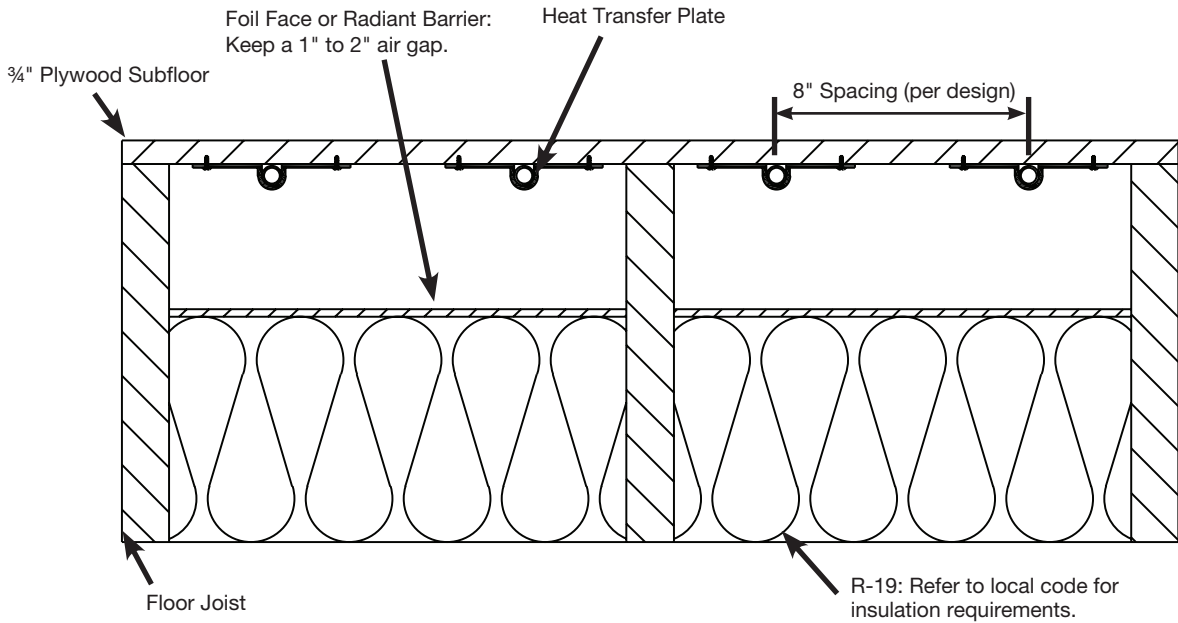
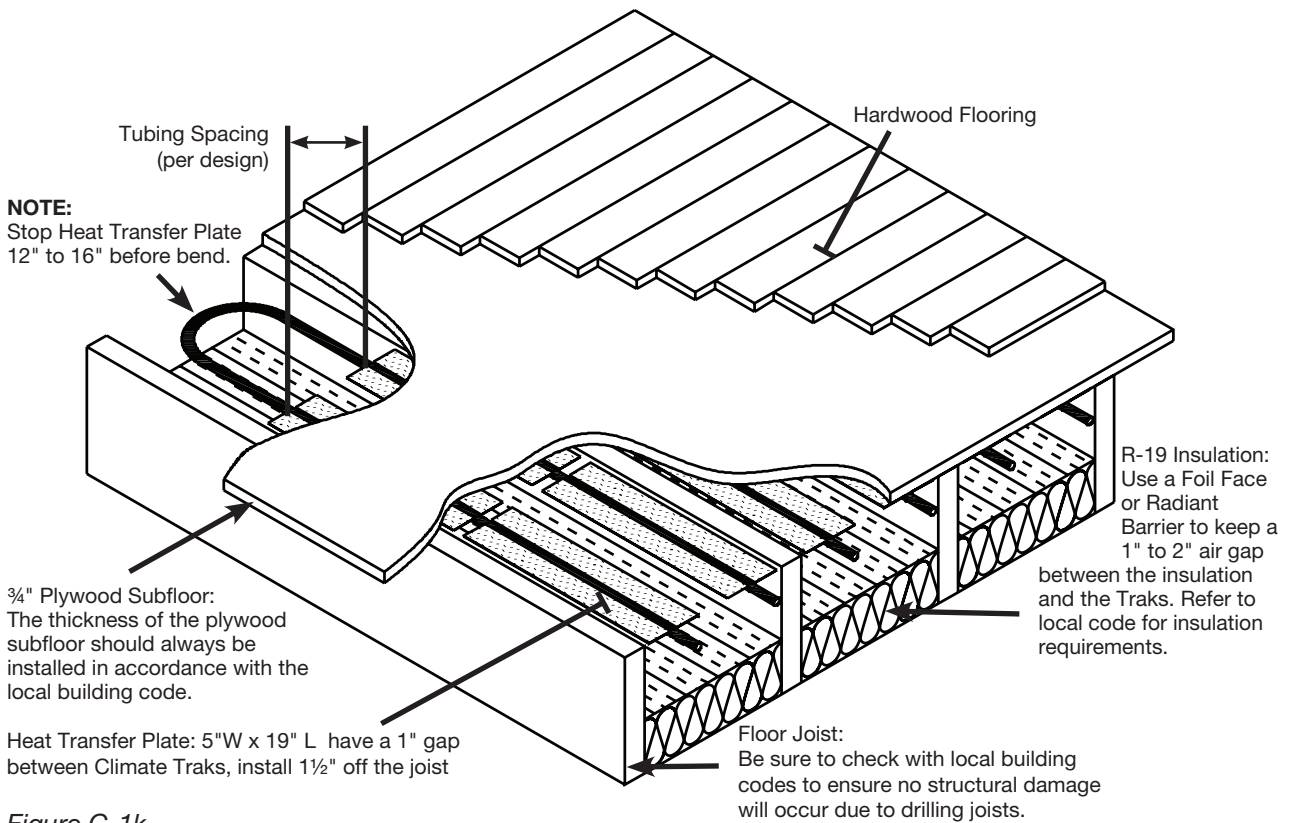


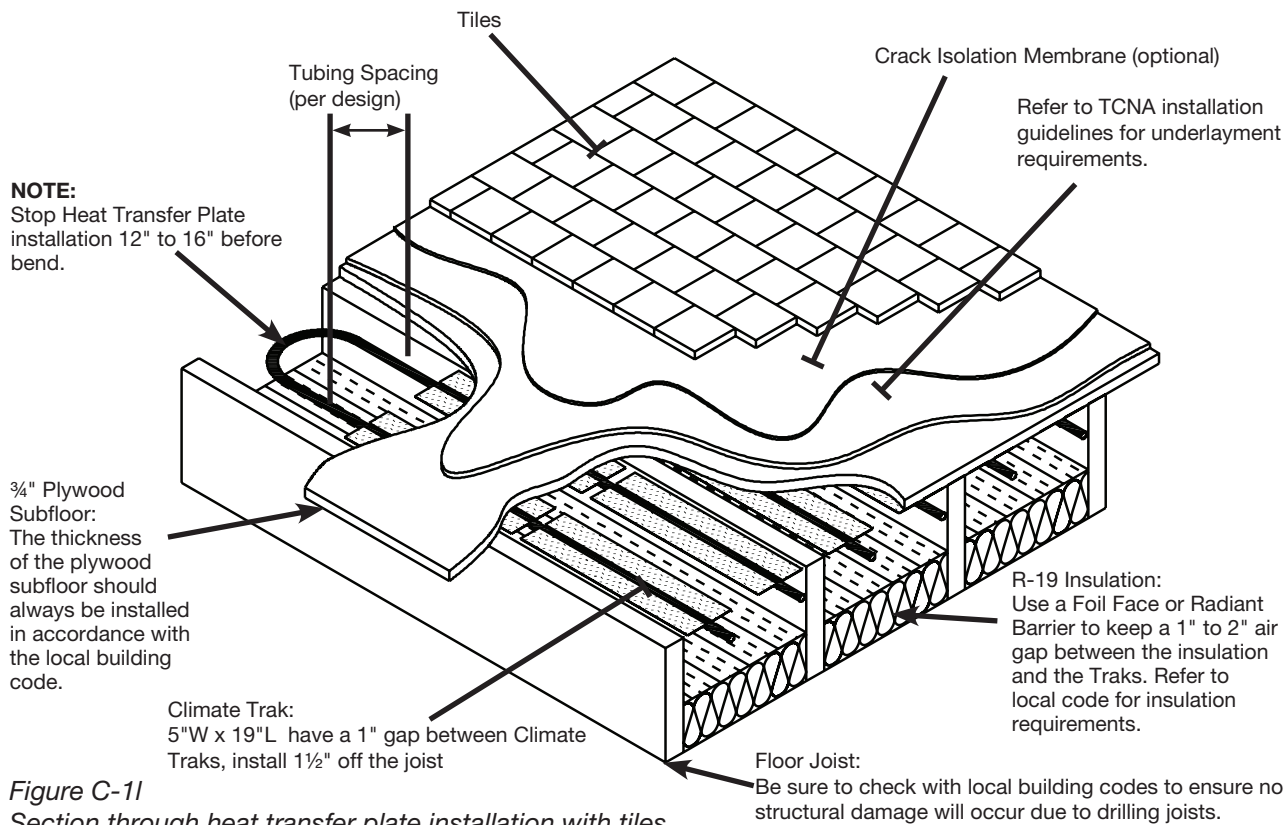
Figure C-1i  
Joist space layout - heat transfer plate



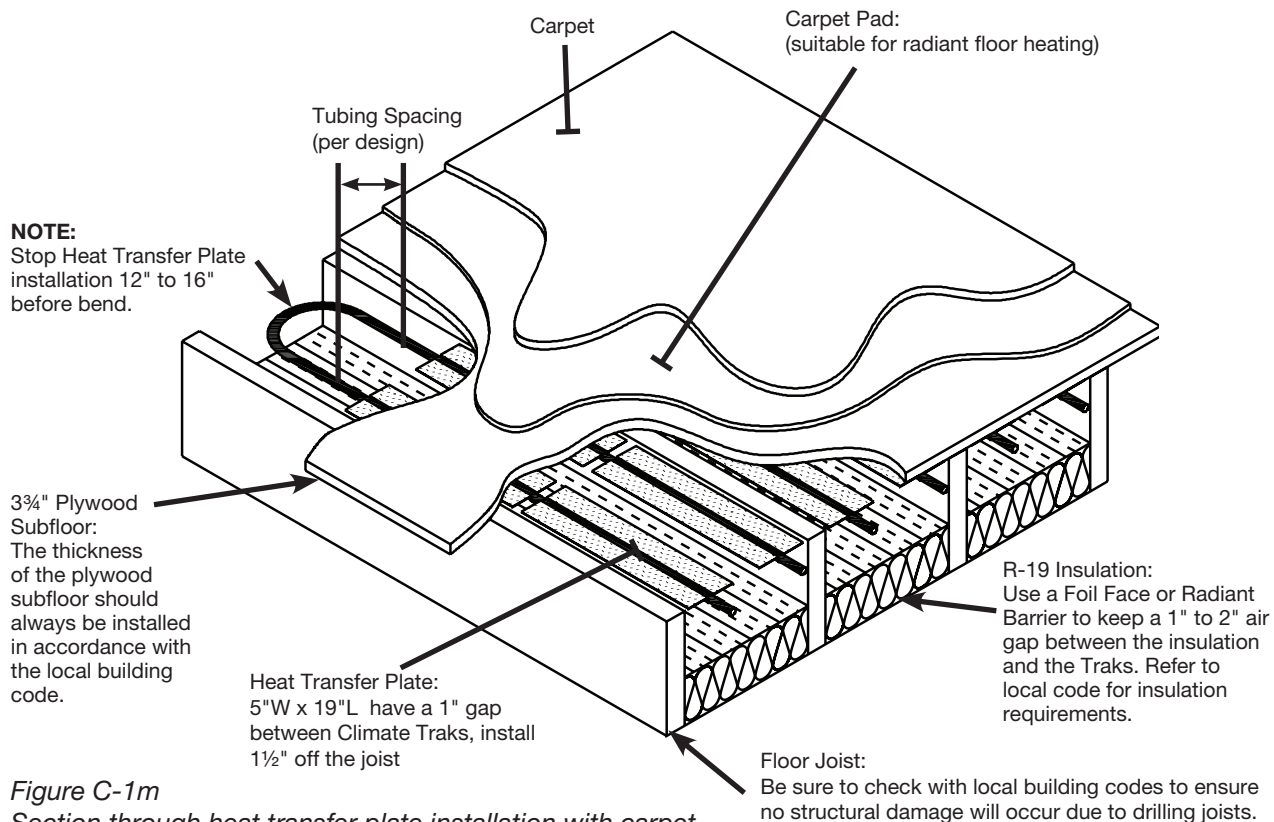
**Figure C-1j**  
Joist space section — heat transfer plate



**Figure C-1k**  
Section through heat transfer plate installation with hardwood finish floor



**Figure C-11**  
Section through heat transfer plate installation with tiles



**Figure C-1m**  
Section through heat transfer plate installation with carpet

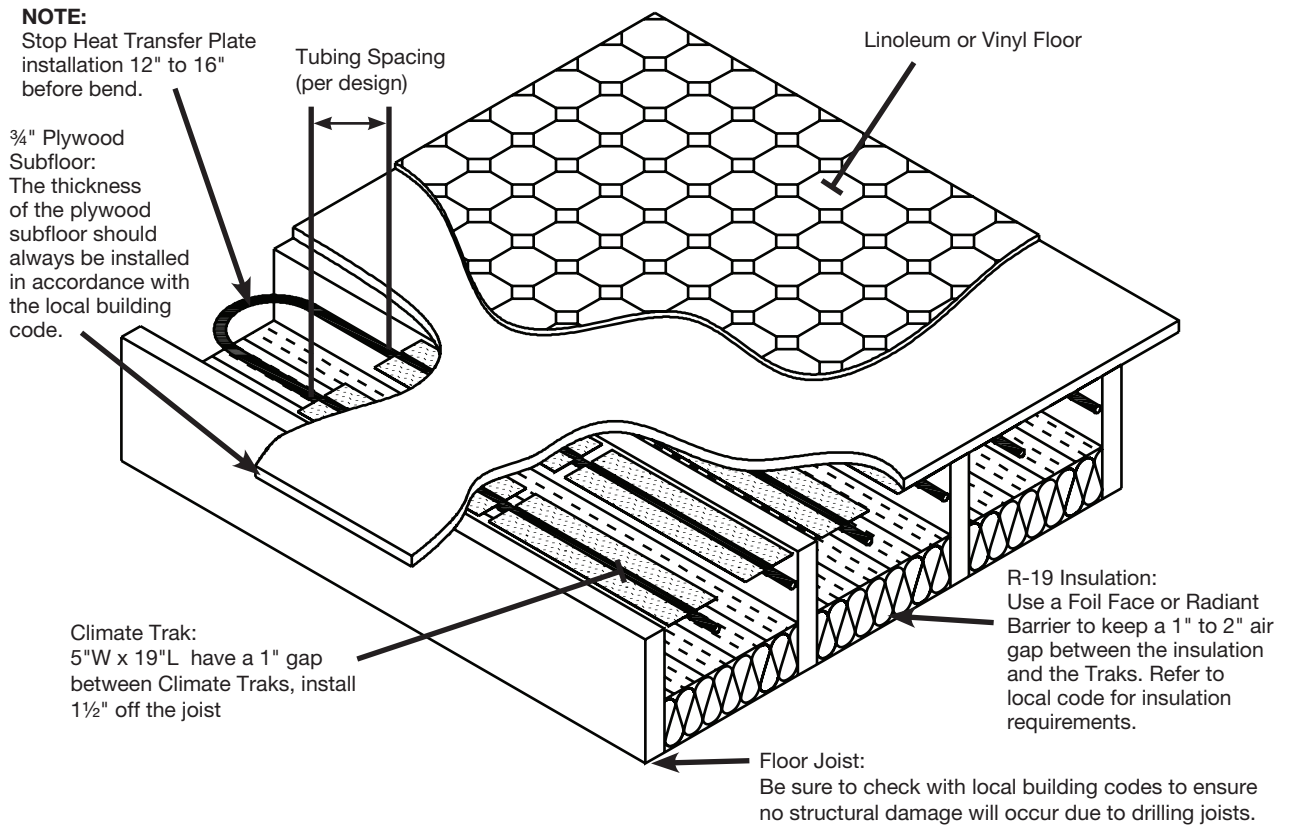


Figure C-1n  
Section through heat transfer plate installation with linoleum or vinyl finish floor

## C.2 Creating a material list

This chart is intended for conceptual purposes in developing an initial material list; there may be variations in each job. You may use Radiant Wizard to create a final material list.

Products		Net Heated Area (ft <sup>2</sup> )	Multiplier	Estimated Amount
Distribution System Tubing	ViegaPEX Barrier 3/8" or 1/2"		2.2	
			1.7	
			1.5	
			1.1	
			0.85	
			0.75	
Fasteners	Screws		4.6	
	Staples		4.6	
Groove Tube Silicone (Heat Transfer Plates Only)			0.02	
Climate Traks	6" Spacing	4' Plate	0.47	
		8' Plate	0.23	
	8" Spacing	4' Plate	0.35	
		8' Plate	0.18	
	9" Spacing	4' Plate	0.31	
		8' Plate	0.16	
	12" Spacing	4' Plate	0.23	
		8' Plate	0.12	
	16" Spacing	4' Plate	0.18	
		8' Plate	0.09	
18" Spacing	4' Plate	0.16		
	8' Plate	0.08		
Heat Transfer Plates	6" Spacing		0.92	
	8" Spacing		0.70	
	9" Spacing		0.62	
	12" Spacing		0.47	
	16" Spacing		0.35	
	18" Spacing		0.31	

**NOTES:** Tubing is sold in coils and fasteners in packages. Where multipliers are located in the table, multiply the net heated area by the corresponding multiplier to derive the estimated amount. Use the Maximum Circuit Length Table to calculate the number of circuits required for the net heated area. Tubing multipliers include 10% overage for leaders.

Maximum Circuit Length		
Tubing Diameter	≤25 Btu/ft <sup>2</sup>	26-35 Btu/ft <sup>2</sup>
3/8"	300	250
1/2"	400	350

Example:

Net Heated Area = 1,500 ft<sup>2</sup>

Calculating Number of Traks

8' Climate Traks 8" O.C.

# of Traks = 1,500 ft<sup>2</sup> x .18

# of Traks = 270

- Sold in packages of 20: (round up to order 14 boxes)

Calculating Amount of Tubing

Amount of Tubing = 1,500 ft<sup>2</sup> x 1.7

Amount of Tubing = 2,550 ft

Calculating Number of Circuits (≤25 Btu/ft<sup>2</sup>)

Amount of Tubing = 2,550 ft

2550 ft/400 ft = 6.375

# of 1/2" circuits = 7

### Maximum circuit lengths

(CSA B214 Table 1, see Clause 14.3.2)

Nominal tube size, in	Maximum loop length, m (ft)
3/8	76 (250)
1/2	91 (300)

Table C-1. Maximum length of continuous tubing from a supply-and-return manifold arrangement (See Clause 14.3.2.)

**Note:** Data for this table were compiled by the 8214 Technical Committee and are based on manufacturers' recommendations and good engineering practice.

CSA B214, Clause 14.3.2

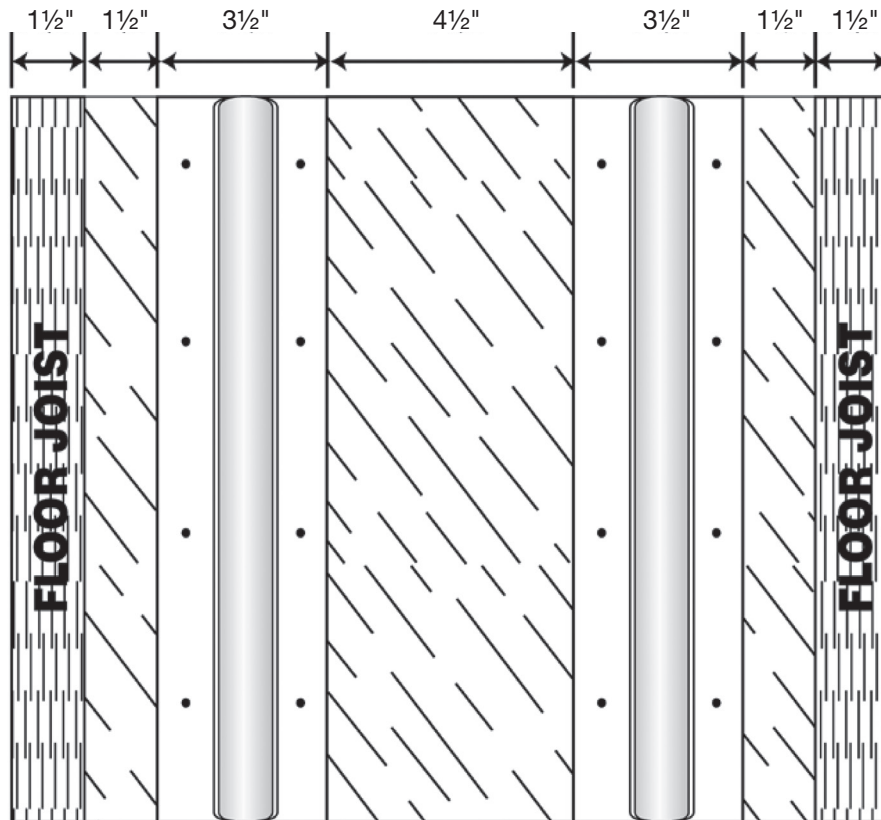
The maximum length of continuous tubing from a supply-and-return manifold arrangement shall not exceed the lengths specified by the manufacturer or, in the absence of manufacturer's specifications, the lengths specified in Table 1. Actual loop lengths shall be determined by spacing, number of loops, and pressure drop requirements, as specified in the system design.<sup>42</sup>

42. ©CSA Group, B214-12. 2012. "Installation Code for Hydronic Heating Systems" Table 1, Clause 14.3.2

### C.3 Layout planning

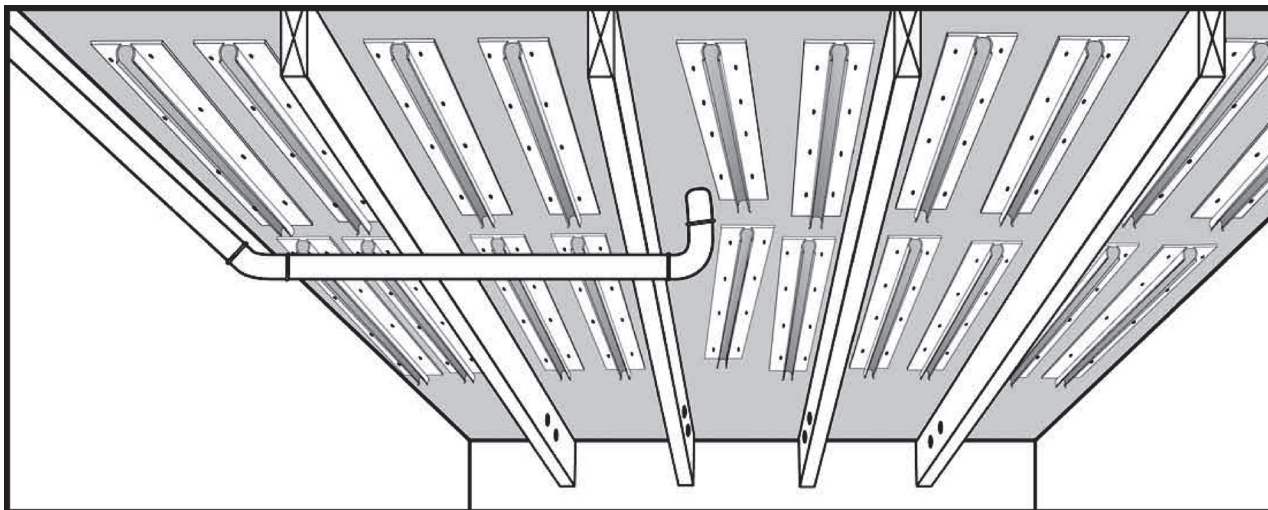
Place the Traks for the most even heat distribution.

Dimensions in drawing are based on standard 2"x8", 2"x10" or 2"x12" floor joists on 16" centers. Adjust spacing as needed when using engineered joists or different spacing.



#### *Avoiding obstructions*

It is important not to install the Traks around objects that will restrict the tubing from being installed into the Traks. In the example below, if the Traks were run on the inside of the dropping pipe, you would find that the tubing would be unable to be snapped in. This is why the Traks are shown going to the outside of the dropping pipe.



## C.4 Installation

Before you start the installation, ensure that you have the proper tools for the job.

### • Installation (Power Tools) •

1. Staple gun with swivel connected hose (staples  $\frac{7}{16}$ " to  $\frac{1}{2}$ " crown by  $\frac{3}{4}$ " to 1")
2. Compressor (1.5-2 hp)
3. Radial arm chop saw - for cutting Traks
4. Right-angle drill with bit kit (1 $\frac{1}{4}$ ") - for drilling joists
5. Palm hammer (medium plastic hammer tip)
6. Screw gun ( $\frac{3}{4}$ " to 1" tech screws)
7. Nail grinder (4 $\frac{1}{2}$ ")

### • Installation (Hand Tools) •

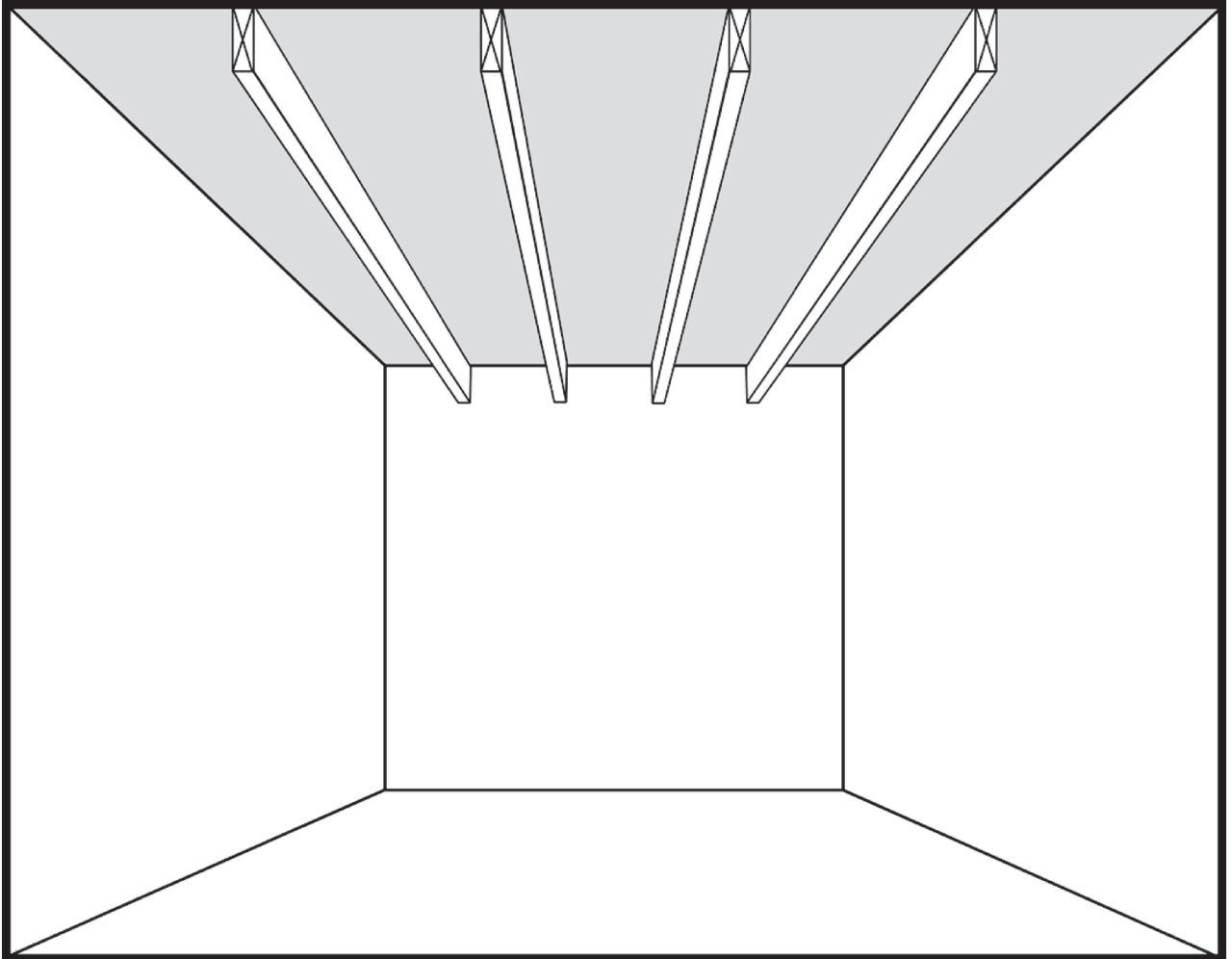
1. Tape measure (recommended 1 per person)
2. Heavy-duty nail cutter - for cleaning joists
3. Rubber mallet - for snapping tubing into Climate Traks
4. Decoiler
5. Hammer - for bending nails, miscellaneous
6. Chalk line - for chalking joists for hole or plate placement
7. Wrench - for manifold connections
8. Tubing cutter
9. Utility knives - for deburring and opening boxes
10. Caulking gun

### • Miscellaneous •

1. Safety glasses (highly recommended)
2. Earplugs
3. Rolling scaffolding or sheet-rocker stilts or ladders
4. Lights (especially in basement applications)
5. Broom

*Step 1: Clearing the bays*

If support crosses can be easily removed, take them out to clear bays for easier installation of the plates and Traks. If crosses are unable to be removed, DO NOT drop tubing below them and resume on the other side; install both plates and tubing above crosses so that no area is lost. Nails must be removed from bays; cut them, grind them or carefully bend them over. Be careful not to damage the finished floor above. (When cutting nails, be sure to wear safety glasses. ⚠)

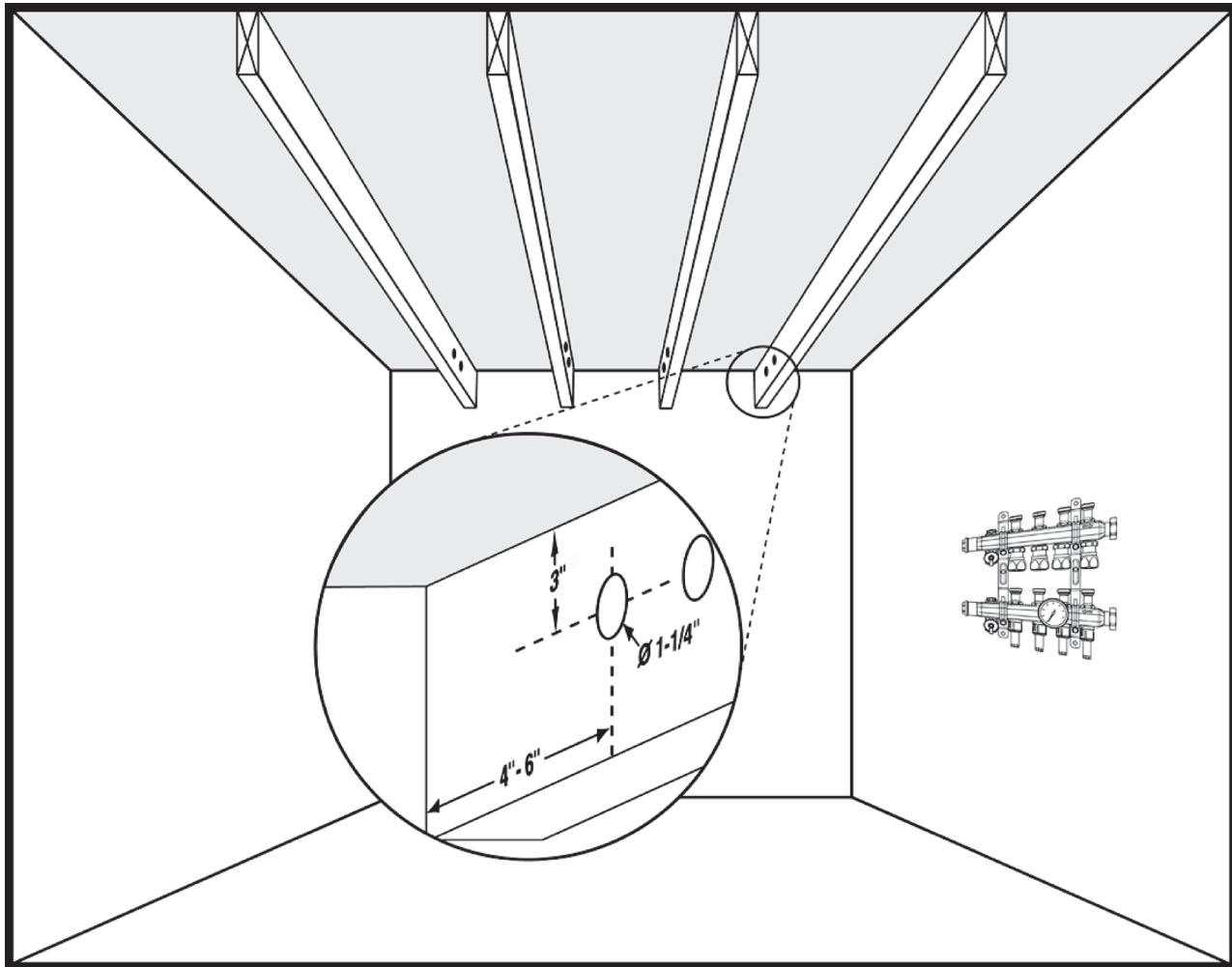




*Step 2: Drilling tubing holes*

Determine where the manifold will be located and which end of the bays the tubing will be returning down. Use a right-angle drill with a 1/4" bit to drill a series of holes through each floor joist on the return end. Keep holes at least 3" from the subfloor to avoid floor nails. To maintain structure integrity it is recommended to drill the holes in the center of the floor joist.

Map out the circuits and determine which bays go to which circuits. Be careful not to exceed maximum circuit length for the size of tubing you are using (3/8" - 300 ft., 1/2" - 400 ft.).

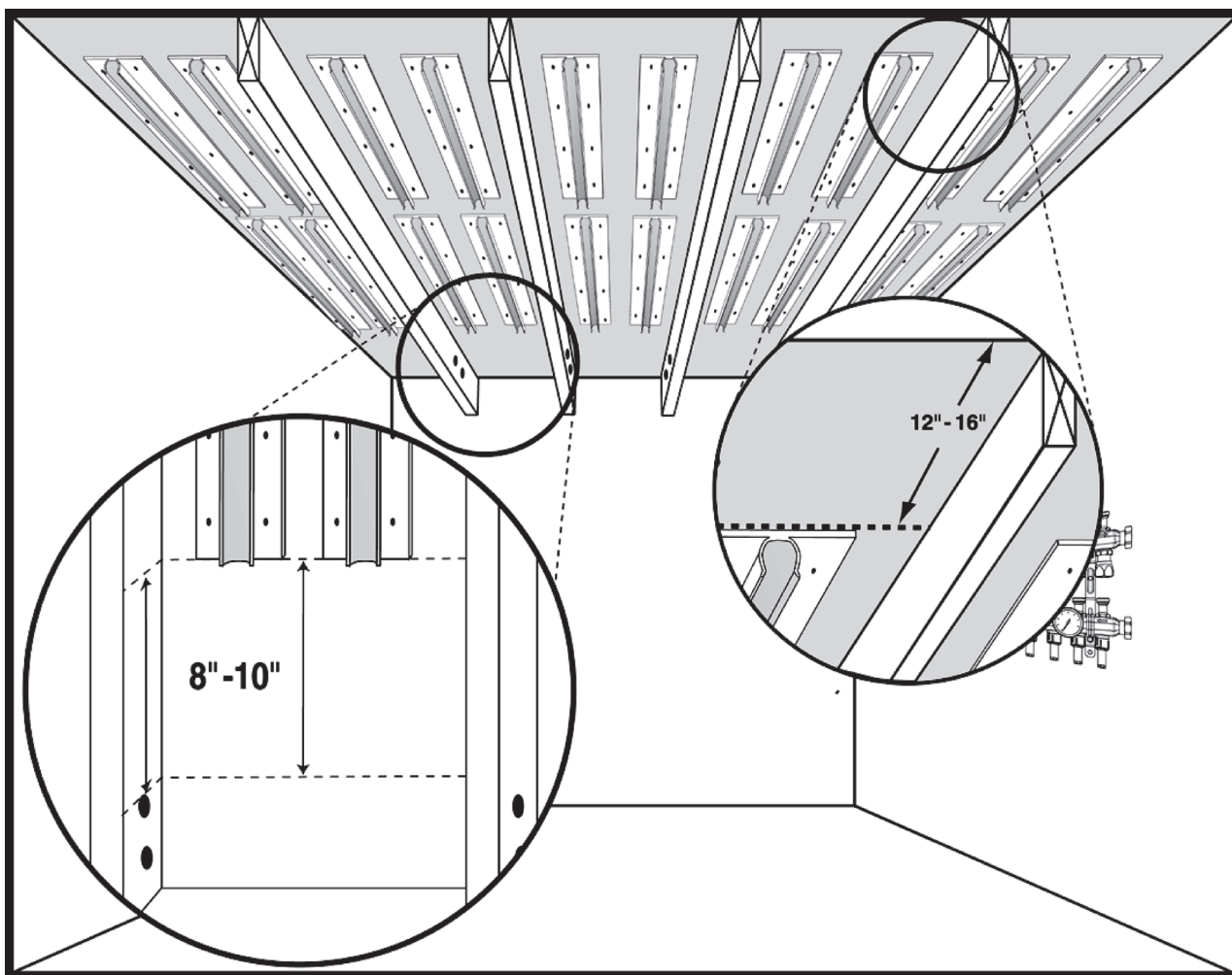


**NOTE:** Be sure to check with local building codes to ensure no structural damage will occur with drilling the joists.

*Step 3: Attaching the Traks/plates*

Start attaching the Traks via staples or zip screws (staples  $\frac{7}{16}$ " to  $\frac{1}{2}$ " crown by  $\frac{3}{4}$ " to 1", depending upon subfloor thickness; putting in 18 to 20 staples for an 8-ft. piece and 10 to 12 staples for a 4-ft. piece; zip screws  $\frac{3}{4}$ " to 1", depending on subfloor thickness). Begin attaching Traks 8" to 10" from the closest hole that was drilled to allow ample room for tubing to turn. Continue to install Traks the entire length of the bay (or to where desired circuit ends), keeping the space in between Traks to around 1". Stop Trak installation 12" to 16" short of where you want circuit to end (e.g., wall, main beam, room above) to allow for a non-stressful loop. *When stapling up Traks, be sure to keep staple gun square to avoid staple deflection.*

*Safety glasses and ear protection are recommended.* 

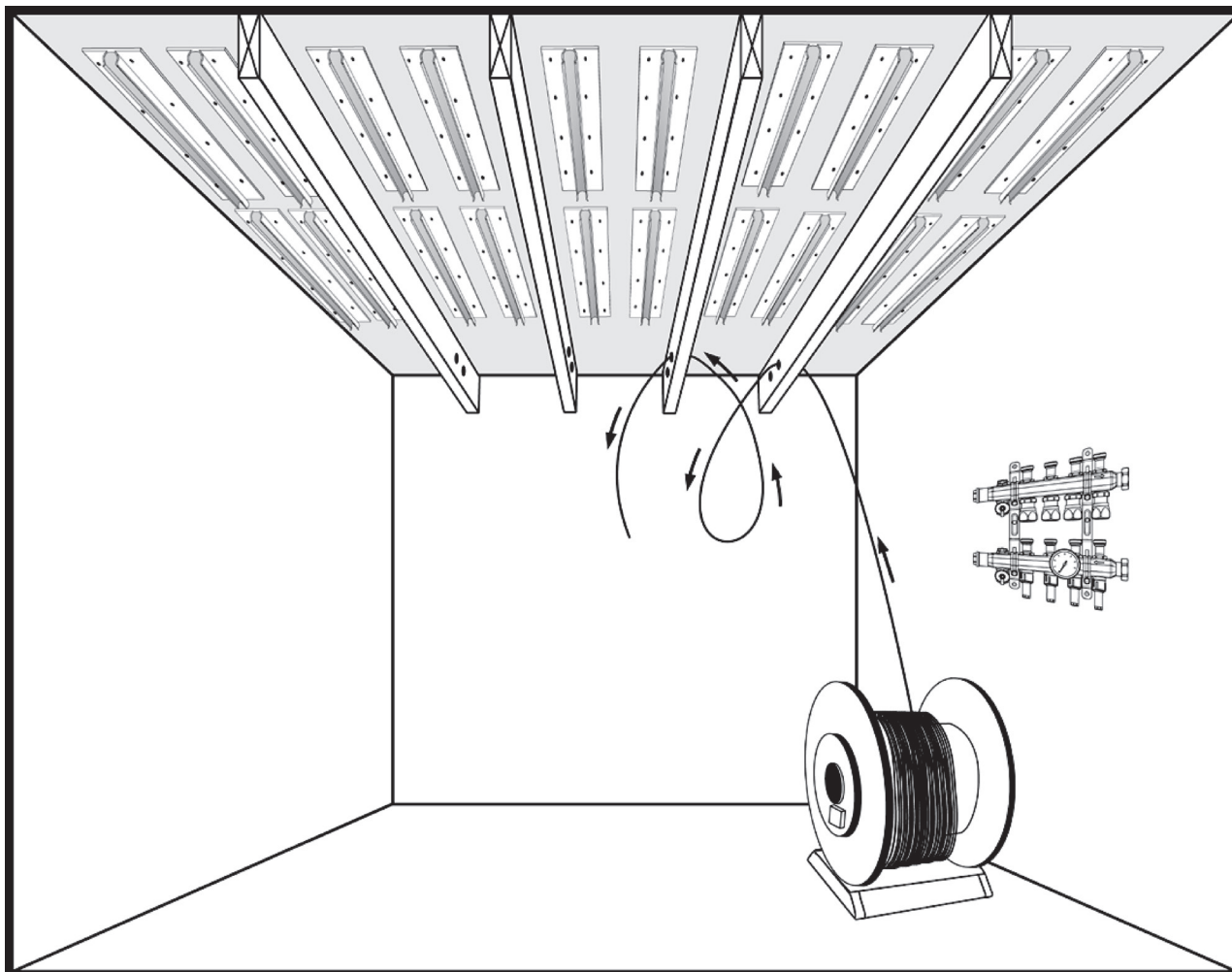


**NOTE:** Traks should be attached as flush as possible to the subfloor for best heat transfer.

**NOTE:** When Traks are cut, be sure to debur them to avoid any tubing damage.

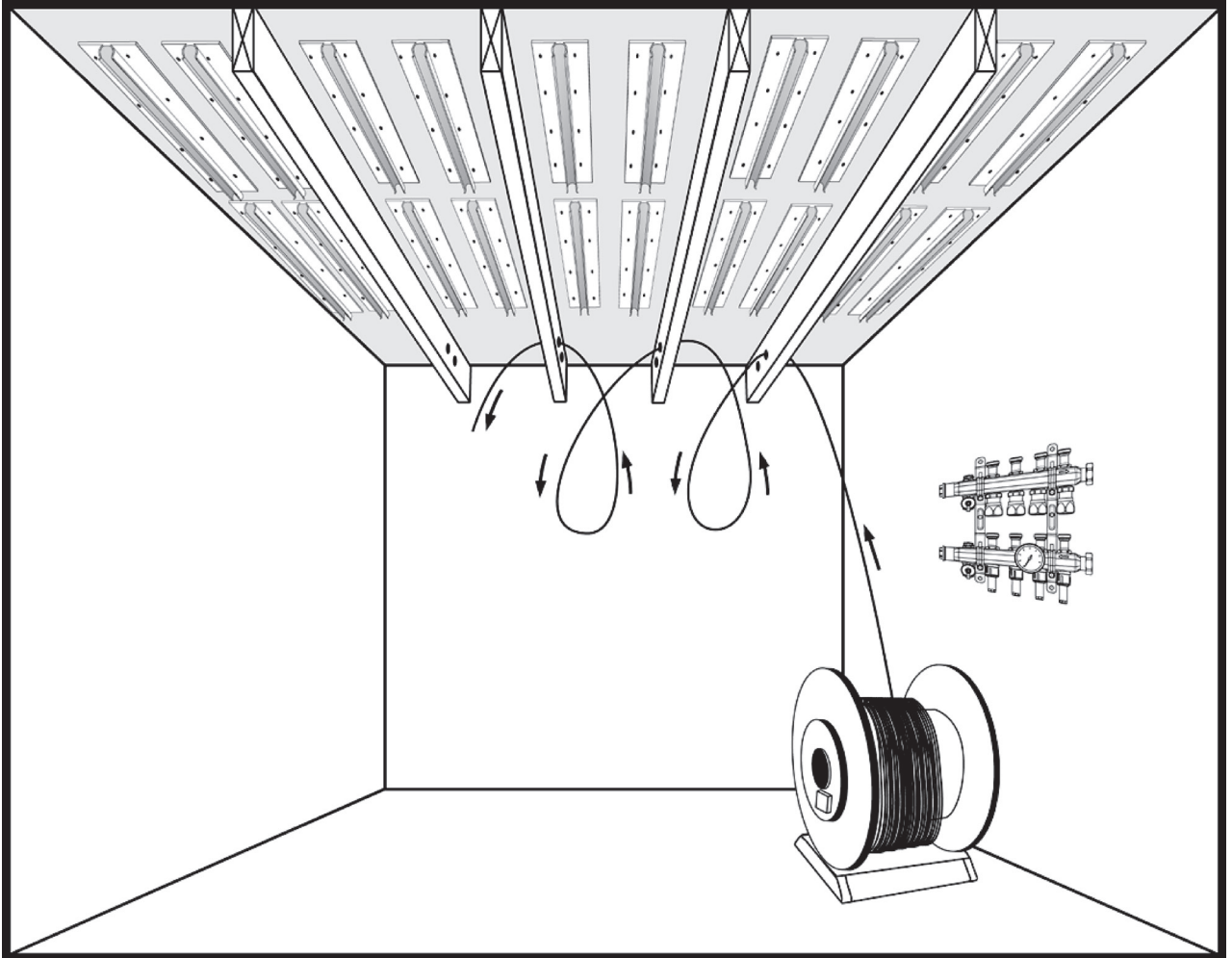
#### Step 4: Installing the tubing

Begin to make non-stressful (teardrop) type loops for each of the bays, keeping loops small and manageable.



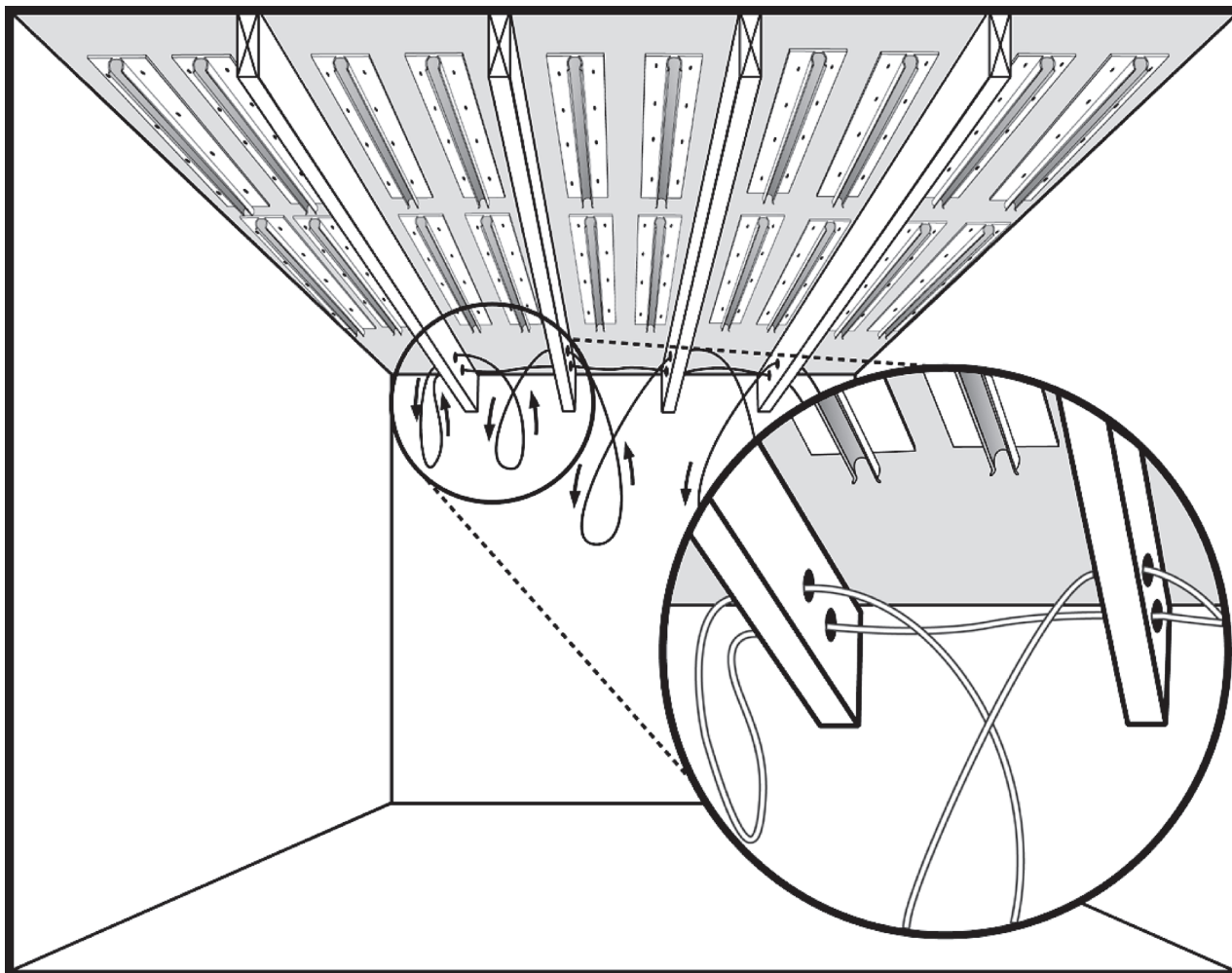
*Step 5: Installing the tubing*

Continue making the “teardrop” loops, being sure not to install any of the tubing into the Traks yet. Keep loops fairly small and manageable to prevent twisting while keeping the loops easy to transfer tubing through.



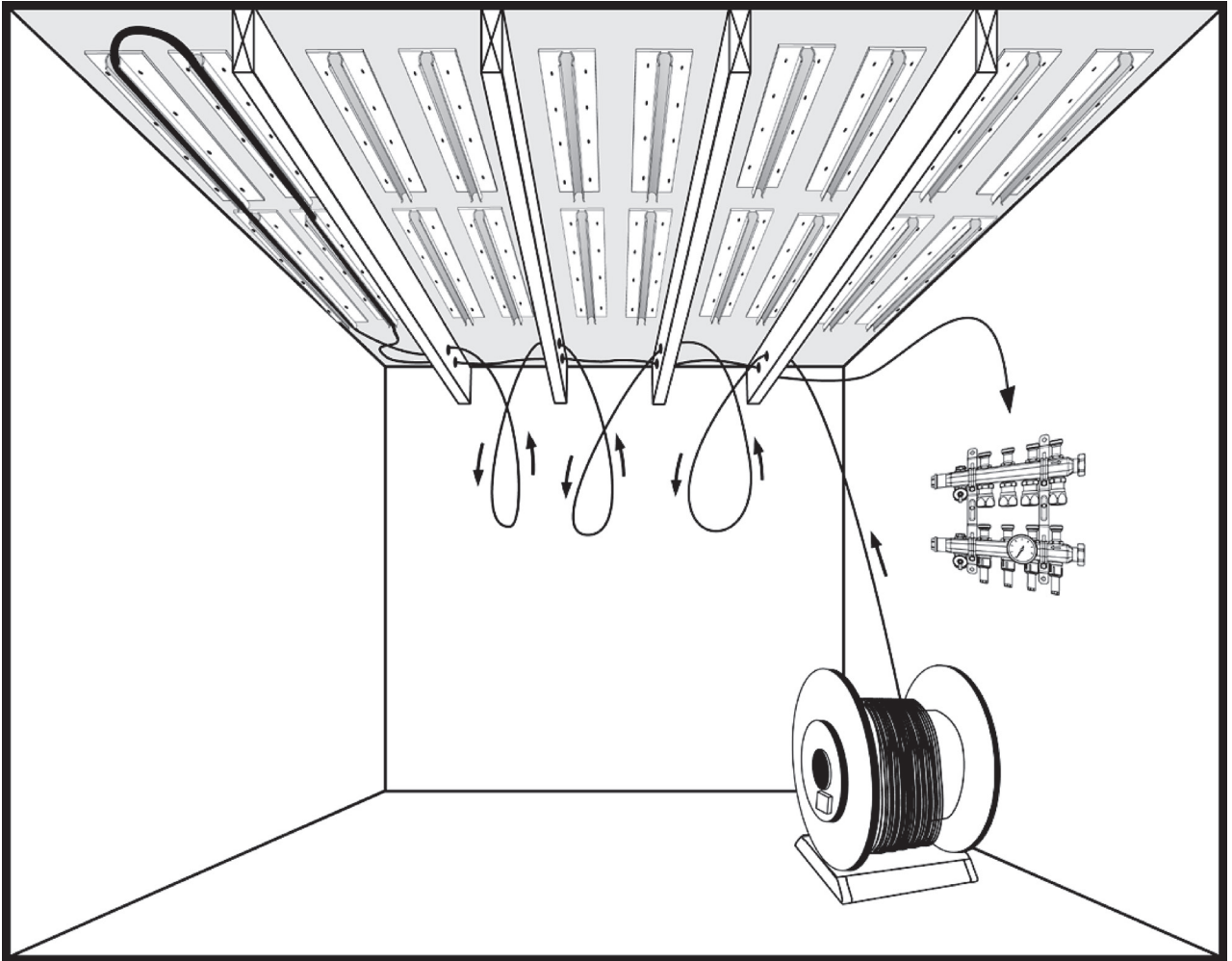
### Step 6: Installing the tubing

Transfer tubing from the decoiler through loops until there is enough tubing to fill the final bay and make the run back to the manifold using the second set of drilled holes.



*Step 7: Installing the tubing*

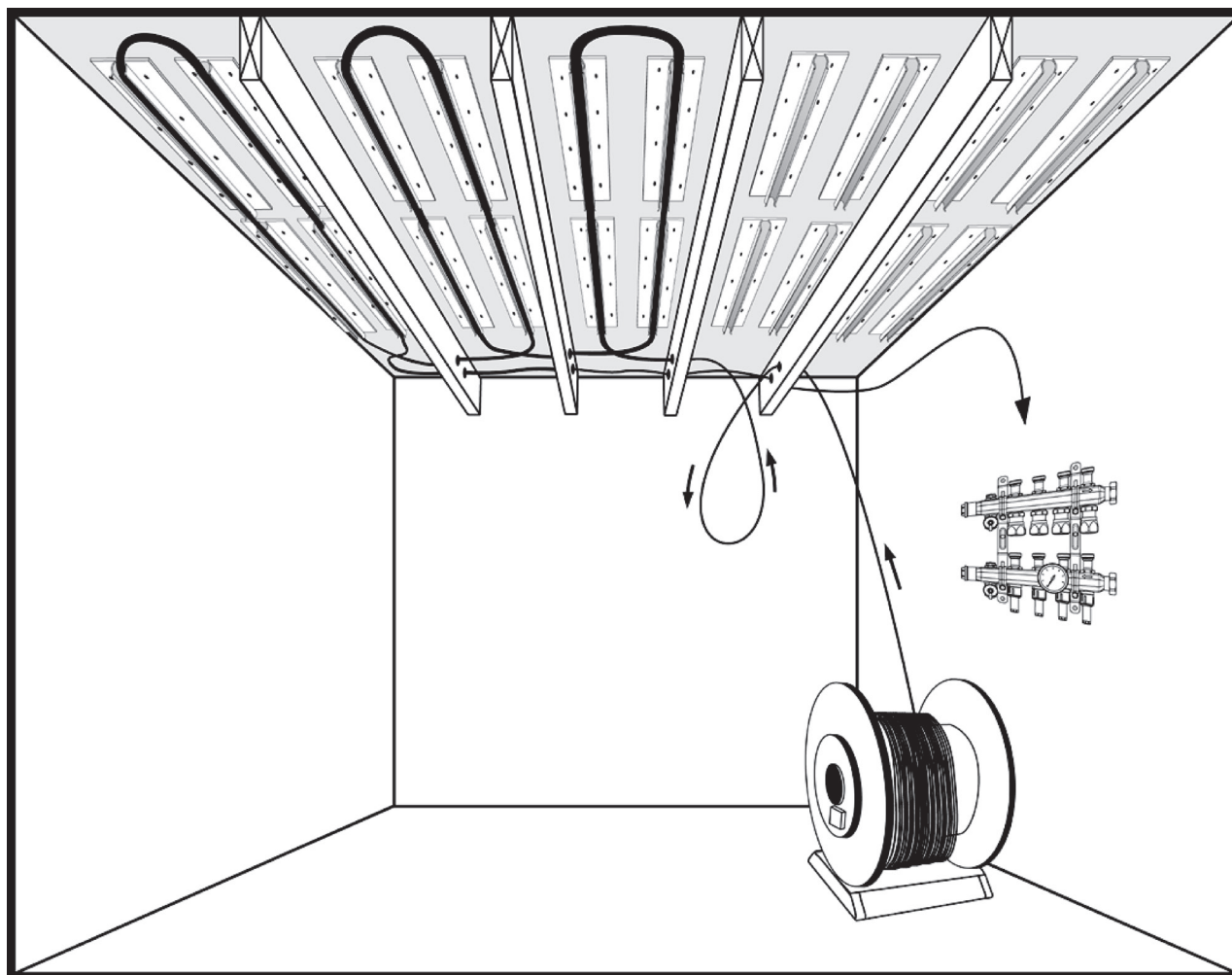
Once the final bay is installed, transfer tubing from coil to fill next bay and so on.



**NOTE:** Tubing can be installed into Traks using a rubber mallet or a palm hammer with a medium plastic tip.

*Step 8: Installing the tubing*

Continue transferring the tubing through the loops, finishing one bay at a time.



### Step 9: Insulation

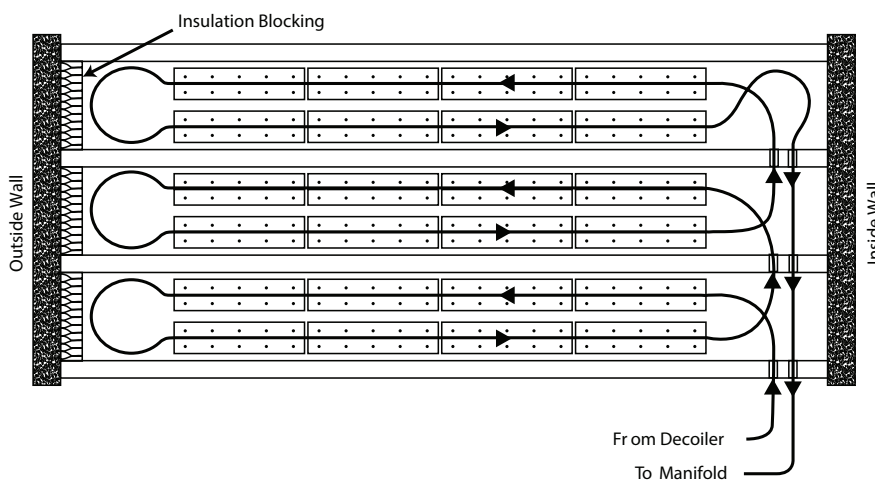
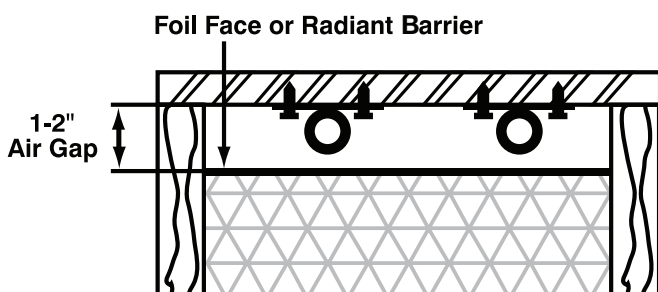
Insulation should always be used in a staple-up radiant installation. Ideally there should be a 1" to 2" air gap in between the insulation and the Traks/plates.

However, the air gap should only be left if that space is considered a dead air space (absolutely no air current through it, whether it be from an outside wall, from below or through holes in the subfloor).

To create a dead air space, begin by insulating the outside ends of the joist bays with a separate piece of insulation (insulation blocking) between the top of the foundation and the bottom of the subfloor to keep cold air from entering through sills and outside walls.

Any air current through this space will decrease the performance of the system and the insulation. By insulating outside walls, sealing any large gaps in the subfloor and ensuring that the insulation is tight against the joist, this will create a situation where the air gap is beneficial to the performance of the system.

If a dead air space is unable to be achieved, then the insulation should be pushed up lightly against the Traks/plates.



**NOTE:** When using expanding foam insulation on and around the PEX tubing, please contact the manufacturer of the foam or Viega for PEX compatibility issues. Some foams may cause excessive heat if installed improperly. This excessive heat may cause damage to the PEX.

43. ©CSA Group, B214-12. 2012. "Installation Code for Hydronic Heating Systems" Clause 14.5.4



Climate Mat is a module of pre-configured, scalable and pre-pressurized circuits of ViegaPEX Barrier tubing that rolls out easily, allowing installers to cover large areas of flooring faster and more efficiently than traditional floor systems. Climate Mat is provided for commercial applications of 10,000 ft<sup>2</sup> or greater.

### D.1 Components

Each Climate Mat is composed of ViegaPEX Barrier tubing arranged in a serpentine pattern. Climate Mats generally have up to six circuits, each with a supply and return that are connected to a temporary/test header. “Spacer strips,” plastic cross-braces installed at the factory, are connected to the tubing at 4-foot intervals with clips to maintain consistent tubing spacing. Spacer strips have pre-formed holes that facilitate attachment to the sub-base with nails, staples or zip ties. Leaders are the lengths of tubing that connect temporary headers to the first spacer strip in a mat. Integral sheaths provide permanent protection for the leaders where they penetrate the slab. Temporary headers are shipped with a Schrader valve to maintain pressurization during the concrete pour.

## D.2 Planning the installation

### D.2.1 Preparing the site

1. Compact the sub-base where necessary.
2. Install vapor barrier if specified. Viega recommends installing a vapor barrier on all heating and cooling installations.
3. Install insulation if specified.
4. Install wire mesh if specified. Though wire mesh is not required for Climate Mat installations, it can be helpful for securing Climate Mat leaders near manifolds.
5. Where specified, re-bar or other slab enforcement may be installed prior to or after the installation of Climate Mat, depending on the slab design and construction schedule, though it is generally easier to sequence the installation of slab reinforcement after the Climate Mat is installed.
6. Remove any unintentional obstructions and construction waste.

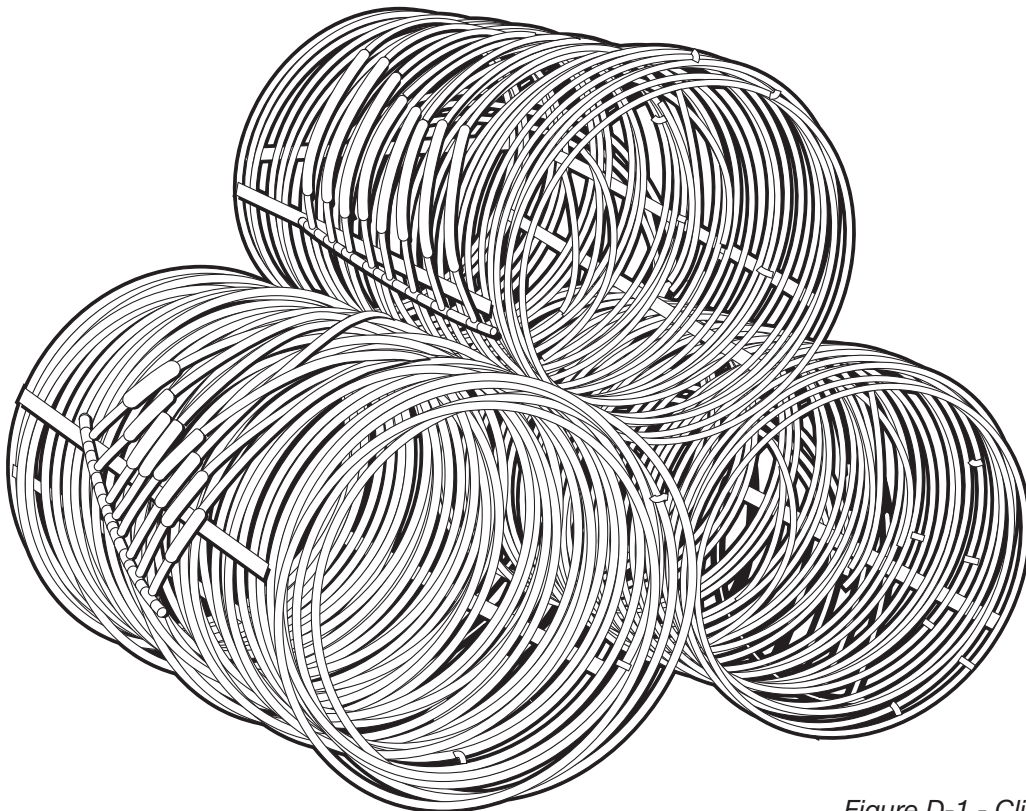
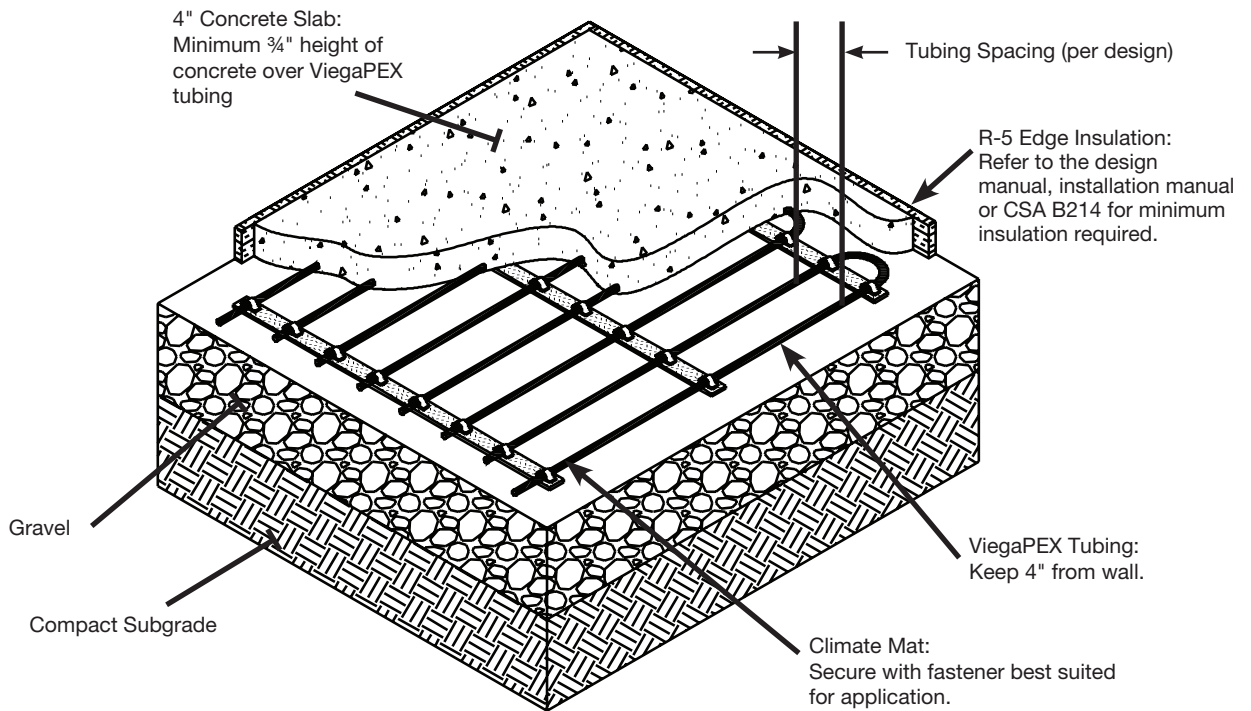
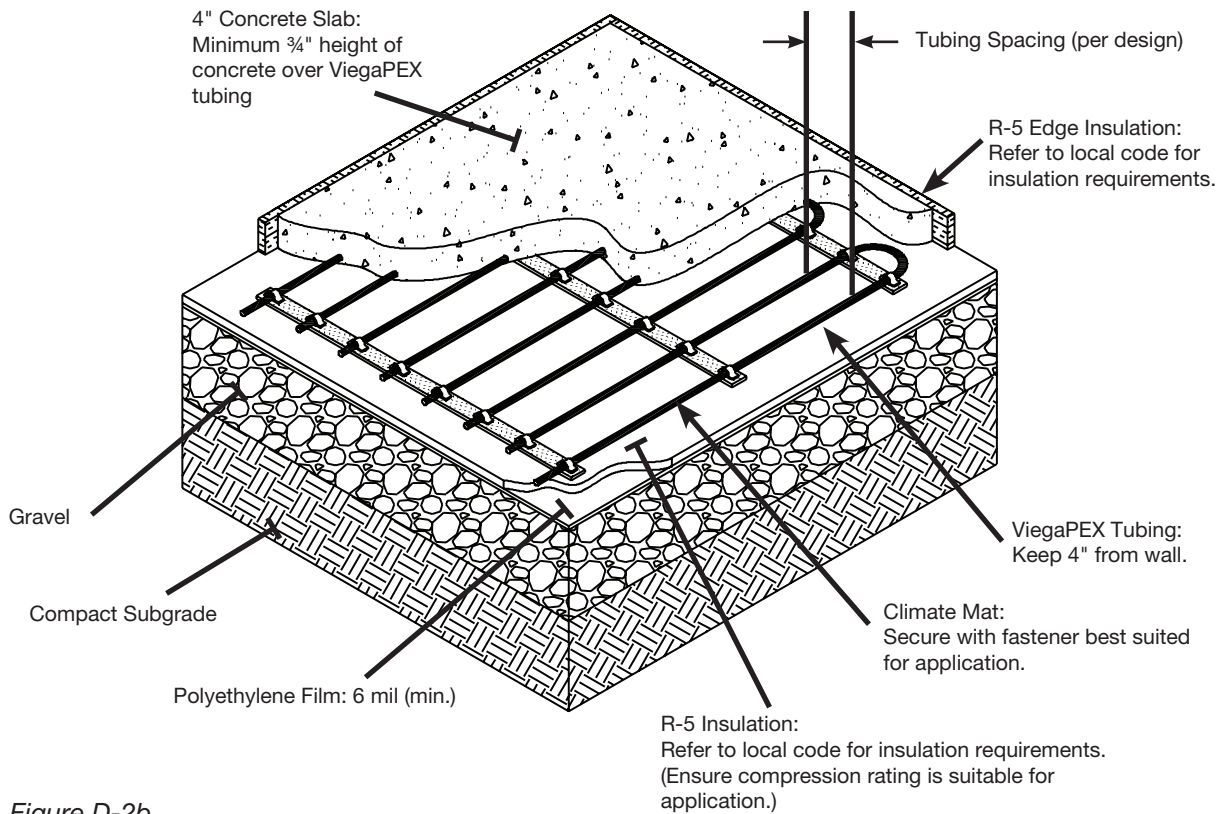


Figure D-1 - Climate Mat



*Figure D-2a*  
Section through Climate Mat on existing slab



*Figure D-2b*  
Section through Climate Mat on existing slab

### D.2.2 Off-loading and storing the mats

Climate Mats are typically delivered to the site stacked vertically on a pallet, and wrapped in cardboard and plastic shrink wrap for protection during shipping. Unload the mats with care, and ensure that all tubing and fittings are stored in a flat, dry, well-ventilated location that is protected from UV exposure. UV exposure must never exceed 6 months.

All Climate Mat assemblies are pressure tested prior to shipment and remain under a static internal pressure of ~20 psig during shipping. (Actual gauge pressure will vary with site elevation.) Upon receipt of the Climate Mat, inspect each assembly for damage, and verify pressure retention. Examine each Climate Mat for damage. Do not install any defective or damaged products.

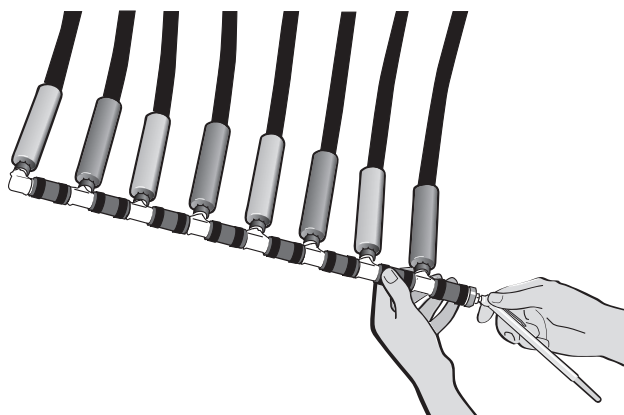


Figure D-3 Using pressure gauge

### D.2.3 Layout and staging

Each Climate Mat delivery is provided with a design layout that details the location of each manifold and its corresponding Climate Mats. If you did not receive a Climate Mat design layout, contact Viega Technical Support. Each Climate Mat is shipped with a label that provides the specifications for that mat.

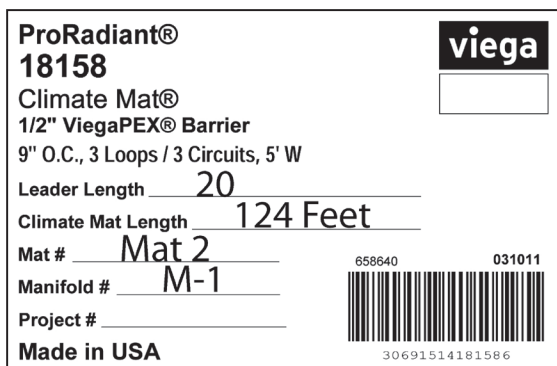


Figure D-4 Climate Mat label

Prior to placing the Climate Mats, it is advisable to measure and mark the location on the sub-base of the first spacer strip for each Climate Mat. This location can be determined from the design layout provided by Viega. Also, to keep the Climate Mats straight and square during installation, the installer may find it useful to mark the sub-base to indicate the position for the outer tube of each Climate Mat.

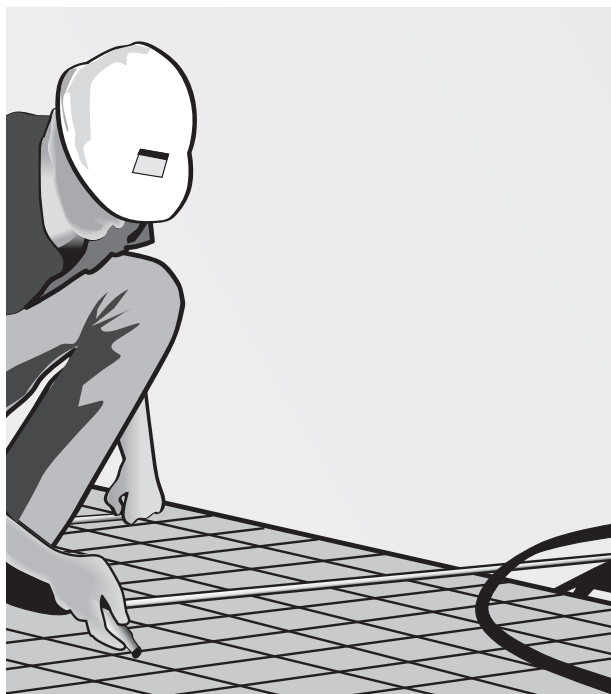


Figure D-5 Measuring the location for the first spacer strip

Using the layout provided by Viega, identify the designated manifold locations and the Climate Mats that correspond with these manifolds. To move the Climate Mat off the pallet, two installers can carry and place the rolled mat into position. During placement, avoid dragging or rolling the Climate Mat across long distances. When it's time for installation, Climate Mats will be unrolled away from the manifolds, with the Climate Mat's temporary headers placed near the manifold location.

Heavy equipment must not be operated on top of the tubing, so consider this when determining how many Climate Mats to roll out at any one time. For example, if the concrete installation will require heavy equipment to be driven on the sub-base, the Climate Mats will need to be rolled out in stages. In this case, the number of Climate Mats that can be installed at any one time will depend on the length of the chute from the concrete trucks, which is generally less than 20 feet. Leave at least one foot of clearance between the concrete pour and the edge of the Climate Mat to ensure that you can easily roll out subsequent sections without interference from concrete over-pour. Once the heavy concrete pour and screed equipment has moved a sufficient distance, subsequent Climate Mats may be unrolled and secured.

If a concrete pump, boom and hose are used to install the concrete, you can generally avoid heavy equipment on the substrate. In this case, it may be possible to roll and anchor all of the Climate Mats prior to the pour.

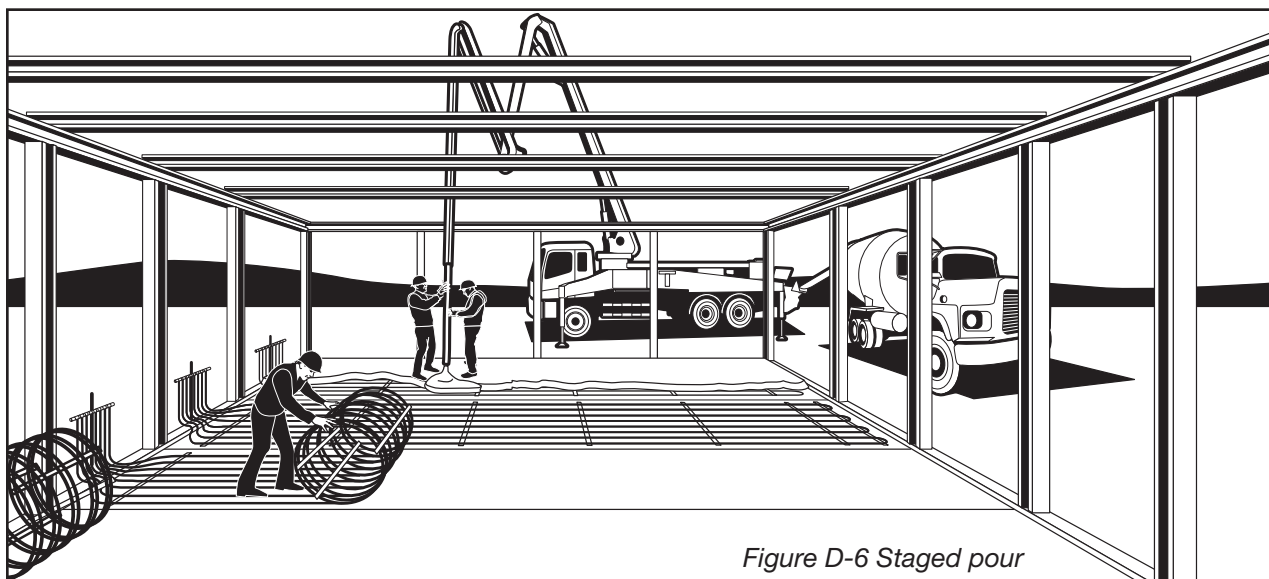


Figure D-6 Staged pour

#### D.2.4 Items needed for installation

Before starting the installation, ensure that the following tools and materials are on site to help the process go smoothly:

- Tubing cutters and ViegaPEX Barrier Press Tool
- ViegaPEX Barrier Press couplings
- Repair tape to wrap repair ViegaPEX Barrier Press couplings in-slab
- Fasteners for securing clip strips and leaders to sub-base, wire mesh or re-bar
- Fasteners for securing Climate Mat leaders near manifolds
- Tools for installing fasteners
- Air compressor for adding extra pressure to Climate Mats if necessary

#### D.3 Installing the Climate Mat

##### D.3.1 Precautions during installation

While it is acceptable to walk on the Climate Mat, do not operate heavy equipment (including lifts, vehicles, concrete buggies, wheelbarrows, etc.) on the tubing prior to installing concrete over the tubing. Avoid exposure of the tubing to harmful substances and conditions such as excessive heat, sharp objects and excessive UV light (i.e., exposure over 6 months). When bending sections of tubing, do not bend beyond the maximum bend radius. (See Appendix A for bend radius of tubing.) Tubing must be sleeved at all concrete penetrations. Climate Mat is shipped with slab penetration sleeves installed on all leaders for this purpose. When securing tubing, use plastic zip ties, plastic clips or clamps approved by Viega. Never use metallic clips or straps to secure tubing.

### D.3.2 Repairing tubing

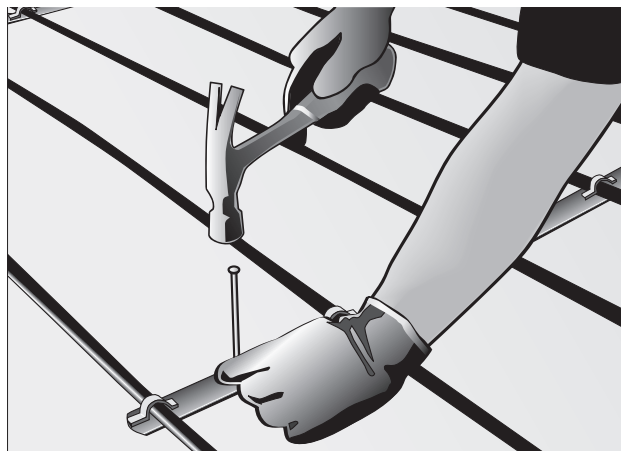
If tubing is kinked or punctured, it can be easily and effectively repaired on-site. Tubing punctures must be repaired using ViegaPEX press couplings. To comply with the Viega Climate Mat warranty, in-slab couplings must be wrapped with repair coupling wrap to protect the fittings from exposure to concrete. A small tubing puncture may be repaired with only one coupling, if there is sufficient slack in the undamaged tubing that can be pulled from the nearest U-bend. Otherwise, the repair will require two couplings and a length of ViegaPEX Barrier tubing of the same outer diameter as the Climate Mat. See Appendix B for instructions on in-slab repairs.

### D.3.3 Fastening the Climate Mat

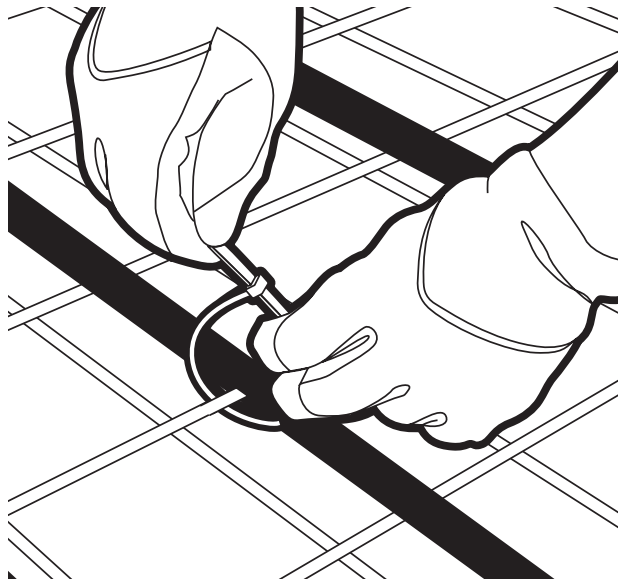
Determine the distance from the control line indicated on the design layout to the first spacer strip location. Secure the first spacer strip to the sub-base or wire mesh near the manifold location. Fully unroll the Climate Mat and pull it hand-tight to ensure that it is straight and square. Attach the last spacer strip to the sub-base or wire mesh, and then go back and anchor each spacer strip with at least two fasteners. Fastening methods will vary depending on the sub-base.

Fasten leaders at two-foot intervals between the first spacer strip and the manifold. If attaching leaders to wire mesh or rebar, use zip ties. For other applications, use foam staples or other appropriate fasteners. When anchoring leaders back to the manifold location, maintain uniform spacing of the tubing as much as possible.

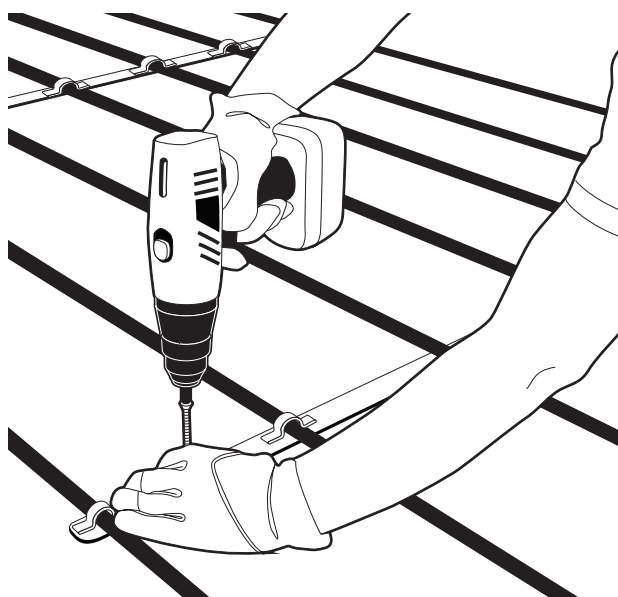
Tie off the temporary header so that it is not in the way when the slab is poured.



*Figure D-7 Fastening to a compacted sub-base: Use at least two 6" landscaping nails to anchor each spacer strip.*



*Figure D-8 Fastening to rebar or wire mesh: Climate Mat can also be secured to wire mesh or rebar with zip ties.*



*Figure D-9 Fastening to an existing slab: Climate Mat may be nailed or screwed to a sub-slab for a thin-slab application.*

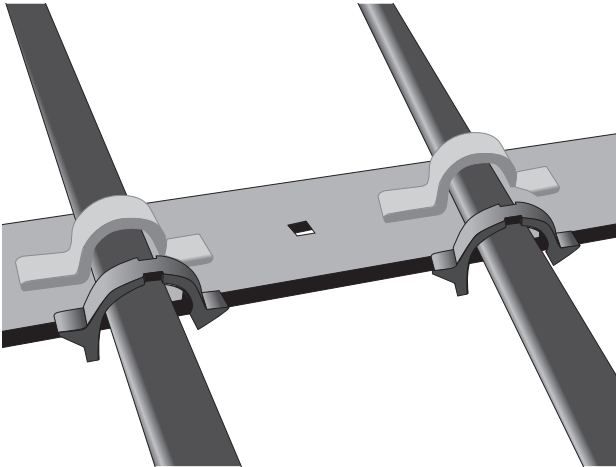


Figure D-10 Fastening to foam insulation: Use at least two foam staples to anchor each spacer strip. Staple tubing close to each spacer strip.

#### D.3.4 Getting around obstacles

The Climate Mat layout supplied by Viega will seek to avoid large obstacles as much as possible. However, slab penetrations due to structural, electric or plumbing components are almost inevitable. Where necessary, remove the tubing from the spacer strip to spread the tubing around obstacles. If this does not lend sufficient clearance, spacer strip(s) may be cut or removed to give you more flexibility.

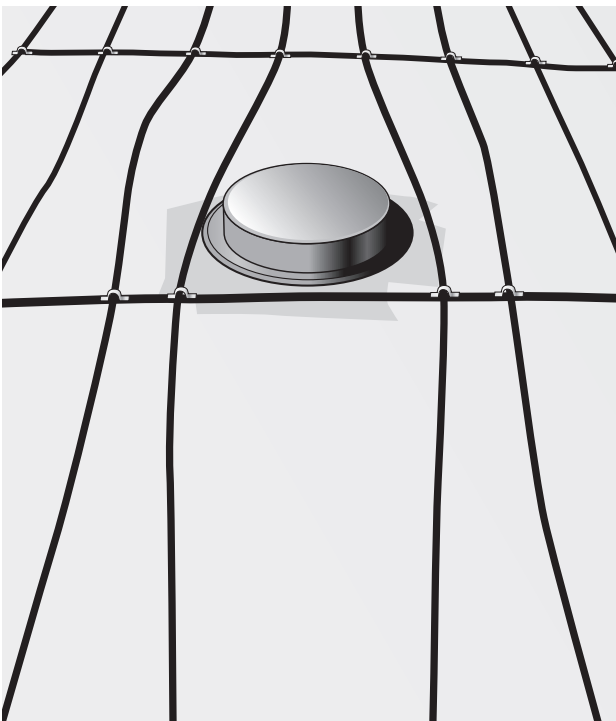


Figure D-11 Re-routed tubing

#### D.3.5 Sleeving expansion joints and slab penetrations

Tubing must be sleeved at all concrete expansion joints and slab penetrations. For the penetration of leaders at manifold locations, slide each leader's factory-installed sleeve until it is in position. For expansion joints and slab penetrations, see Section 4.1.2, Handling and protecting tubing.

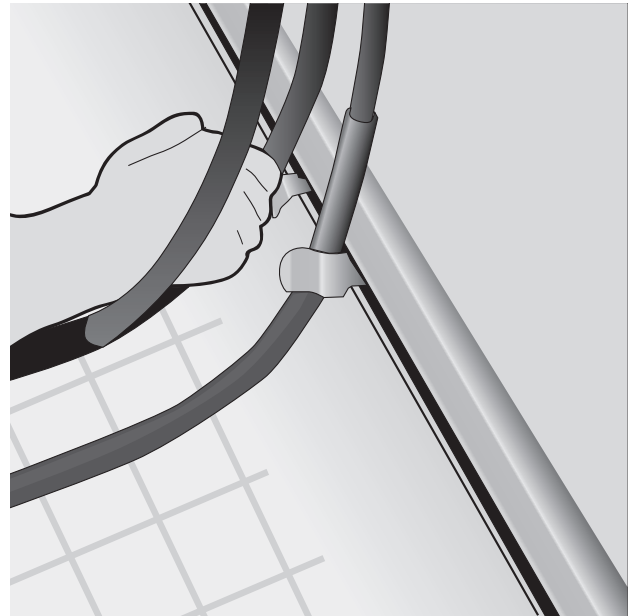


Figure D-12 Sleeves around tubing penetrations near manifold

#### D.3.6 Pouring the concrete

Prior to the concrete pour, pressurize each Climate Mat to 100 psi of air through the Schrader valve on the temporary header. Keep the Climate Mats under pressure for the duration of the concrete pour. Check with local code to determine if there are pressurization requirements that exceed this recommendation, and if so, ensure that local code is followed. In absence of local code pressurize the system for a minimum of one hour. Frequently confirm throughout the pour that tubing integrity is maintained.

Inform the concrete crews and truck operators that dump chutes must never come into contact with the tubing, which could otherwise be damaged. As much as possible, avoid the application of high-pressure, pumped concrete directly to the spacer strips, which could become dislodged if the pressure is too high.

At least  $\frac{3}{4}$ " of concrete should be maintained between the top of the Climate Mat and the top of the slab. If shelving or other slab anchors will be installed after the concrete slab is poured, ensure that the slab and anchors will be designed to leave at least  $\frac{3}{4}$ " clearance between the top of the Climate Mat and the bottom of any anchor pilot holes. If installing Climate Mat in a gypsum concrete slab (e.g. slab on slab), the minimum slab depth must be at least  $1\frac{1}{2}$ ".

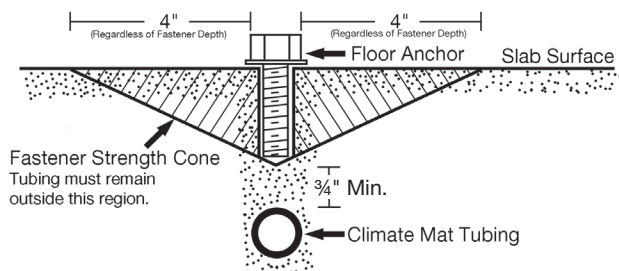


Figure D-13 Minimum  $\frac{3}{4}$ " of concrete between anchor bolt hole and Climate Mat. Strength cone diagram showing tube placement

### D.3.7 Connecting to permanent manifolds

Permanent manifolds can be installed when the Climate Mats are installed or later in the construction process after the slab has cured. Manifold locations are designated on the Viega design layout for each project. Ensure that manifolds are in locations that will remain easily accessible (e.g., behind a panel or door). Manifolds must be protected from freezing temperatures, so sufficient insulation must be provided.

Using a valve stem removal chuck, remove the inner stem of the Schrader valve to release air pressure from the mats. With a tubing cutter, trim the Climate Mat leaders squarely to the proper length at the manifold location, and discard the temporary header. To maintain the product warranty, use only Viega manifolds and fittings to connect the Climate Mat leaders to the manifolds. Viega recommends a shutoff valve at each circuit for isolation. In addition, each manifold should have an isolation ball valve on the supply and return headers. Climate Mat leaders are color coded to help you distinguish between supply and return. Ensure that all of the manifolds are connected with the same color scheme for supply and return throughout the installation.

## D.4 Startup

### D.4.1 Purging procedure

See Section 4.2.1, Pressure testing and purging, for the recommended purging procedure.

### D.4.2 Warming up the slab

Follow the instructions in Section 4.2.4 for warming up the slab.

### D.4.3 Testing the concrete for excessive moisture

Follow the instructions in Section 4.2.4 for ensuring that the slab is sufficiently dry prior to applying finish flooring.

## D.5 Viega Manifold Cabinet

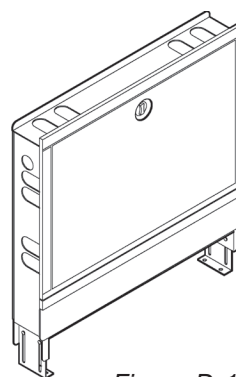


Figure D-14

Viega's Manifold Cabinet is designed to house our  $1\frac{1}{4}$ " stainless steel manifolds and 1" copper manifolds. The Viega Manifold Cabinet may also be used with zone controls and powerheads in some applications. See the charts below for dimensional information.

### Product Overview

- Recess mount
- Adjustable wall depth ( $4\frac{1}{2}$ " to 6")
- 20-gauge galvanized sheet metal construction (1 mm)
- Epoxy polyester powder coating
- Open bottom for easy connection of tubing
- Available with standard knob or optional lock and key (lock and key stock code: 15217)
- Adjustable legs (0 to  $3\frac{1}{4}$ ")
- When using stock code # 15802 the use of two locks is necessary

Manifold Cabinet Dimensions		
Stock Code	Outside Dimension W x H x D	Inside Dimension W x H x D
15800	22 <sup>5</sup> / <sub>8</sub> " x 31 <sup>1</sup> / <sub>4</sub> " x 4 <sup>1</sup> / <sub>2</sub> "	21" x 28" x 4 <sup>1</sup> / <sub>2</sub> "
15801	28 <sup>5</sup> / <sub>8</sub> " x 31 <sup>1</sup> / <sub>2</sub> " x 4 <sup>1</sup> / <sub>2</sub> "	27" x 28" x 4 <sup>1</sup> / <sub>2</sub> "
15802	46" x 31 <sup>1</sup> / <sub>4</sub> " x 4 <sup>1</sup> / <sub>2</sub> "	45" x 28" x 4 <sup>1</sup> / <sub>2</sub> "

Table D-1

1-1/4" Stainless Steel Manifold Dimensional Information							
Stock Code	Interior box dimension	Exterior box dimension	1/4" stainless steel manifold with no accessories	1/4" stainless steel manifold with ball valve set	1/4" stainless steel manifold with ball valve set and adapters for flow through	1/4" stainless steel manifold with no accessories and Zone Control	1/4" stainless steel manifold with ball valve set and Zone Control
15800	21"	22 <sup>5</sup> / <sub>8</sub> "	2-6 outlet manifold	2-5 outlet manifold	2-4 outlet manifold	2 outlet manifold	N/A
15801	27"	28 <sup>5</sup> / <sub>8</sub> "	2-9 outlet manifold	2-8 outlet manifold	2-7 outlet manifold	2-4 outlet manifold	2-3 outlet manifold
15802	45"	46"	2-12 outlet manifold	2-12 outlet manifold	2-12 outlet manifold	2-12 outlet manifold	2-12 outlet manifold

**NOTES:** If use of a zone control is necessary, hold the manifold to one side and install the zone control vertically on the other side of the manifold cabinet. Use of a zone control in the manifold cabinet is not compatible with flow-through applications.

Table D-2

1" Copper Manifold Dimensional Information				
Stock Code	Interior box dimension	Exterior box dimension	1" copper manifold with no accessories	1" copper manifold with ProPress ball valve and end cap
15800	21"	22 <sup>5</sup> / <sub>8</sub> "	2, 3, 4 outlet manifold	N/A
15801	27"	28 <sup>5</sup> / <sub>8</sub> "	2, 3, 4 outlet manifold	2, 3, 4 outlet manifold
15802	45"	46"	2, 3, 4 and 12 outlet manifold	2, 3, 4 and 12 outlet manifold

**NOTES:** Copper manifolds are available in 2, 3, 4 and 12 outlet configurations. Manifold brackets are sold separately for copper manifolds.

Table D-3



## Appendix G R-values of coverings

	1/8"	1/4"	3/8"	1/2"	5/8"	3/4"	7/8"	1"
<b>Building Board</b>								
Gypsum or Plaster Board	0.11	0.23	0.32	0.45	0.56	0.68	0.79	0.90
Plywood	0.16	0.31	0.47	0.62	0.77	0.93	1.09	1.24
Particleboard, low density	0.18	0.35	0.53	0.71	0.88	1.06	1.23	1.41
Particleboard, medium density	0.13	0.27	0.40	0.53	0.66	0.80	0.93	1.06
Particleboard, high density	0.11	0.21	0.32	0.43	0.53	0.64	0.74	0.85
Waferboard	0.20	0.40	0.60	0.80	0.99	1.19	1.39	1.59
Wood subfloor	0.16	0.31	0.47	0.62	0.78	0.93	1.09	1.24
Cement board	0.03	0.06	0.09	0.12	0.15	0.18	0.21	0.24
<b>Tile</b>								
Ceramic Tile	0.02	0.03	0.05	0.07	0.08	0.10	0.12	0.13
Marble	0.01	0.01	0.02	0.03	0.03	0.04	0.04	0.05
Granite	0.01	0.02	0.03	0.04	0.05	0.06	0.07	0.08
Slate	0.01	0.03	0.04	0.05	0.06	0.08	0.09	0.10
Linoleum or Vinyl	0.05	0.10	0.15	0.20	0.25	0.30	0.35	0.40
Rubber, hard	0.12	0.24	0.36	0.48	0.60	0.72	0.84	0.96
Cork Tile	0.28	0.56	0.84	1.12	1.40	1.68	1.96	2.24
<b>Carpet Pad</b>								
Waffled Sponge Rubber	0.20	0.41	0.61	0.81	1.01	1.22	1.42	1.62
Synthetic Jute	0.43	0.86	1.28	1.71	2.14	2.57	2.99	3.42
Bonded Urethane, 4-lb Density	0.52	1.05	1.57	2.09	2.61	3.14	3.66	4.18
Bonded Urethane, 8-lb Density	0.55	1.10	1.65	2.20	2.75	3.30	3.85	4.40
Prime Urethane, 2.2-lb Density	0.54	1.08	1.61	2.15	2.69	3.23	3.76	4.30
<b>Carpet</b>								
Acrylic Level Loop	0.52	1.04	1.56	2.08	2.60	3.12	3.64	4.16
Acrylic Level Loop w/Foam Back	0.51	1.02	1.53	2.04	2.55	3.06	3.57	4.08
Acrylic Plush	0.43	0.86	1.29	1.72	2.15	2.58	3.01	3.44
Polyester Plush	0.48	0.96	1.44	1.92	2.40	2.88	3.36	3.84
Nylon Level Loop	0.68	1.36	2.04	2.72	3.40	4.08	4.76	5.44
Nylon Plush	0.26	0.52	0.78	1.04	1.30	1.56	1.82	2.08
Nylon Shag	0.27	0.54	0.81	1.08	1.35	1.62	1.89	2.16
Nylon Saxony	0.44	0.88	1.32	1.76	2.20	2.64	3.08	3.52
Wool Plush	0.55	1.10	1.65	2.20	2.75	3.30	3.85	4.40
<b>Hardwood</b>								
Ash	0.15	0.30	0.45	0.60	0.75	0.90	1.05	1.20
Beech	0.12	0.24	0.36	0.48	0.60	0.72	0.84	0.96
Cherry	0.15	0.30	0.45	0.60	0.75	0.90	1.05	1.20
Elm	0.14	0.28	0.42	0.56	0.70	0.84	0.98	1.12
Maple	0.13	0.26	0.39	0.52	0.65	0.78	0.91	1.04
Oak	0.15	0.30	0.45	0.60	0.75	0.90	1.05	1.20
Cedar	0.23	0.46	0.69	0.92	1.15	1.38	1.61	1.84
Fir	0.15	0.30	0.45	0.60	0.75	0.90	1.05	1.20
Hemlock	0.18	0.36	0.54	0.72	0.90	1.08	1.26	1.44
Pine	0.20	0.40	0.60	0.80	1.00	1.20	1.40	1.60
Redwood	0.20	0.40	0.60	0.80	1.00	1.20	1.40	1.60
Spruce	0.20	0.40	0.60	0.80	1.00	1.20	1.40	1.60
<b>Engineered Flooring</b>								
Laminated Parquet Flooring	0.11	0.23	0.34	0.45	0.57	0.68	0.79	0.91

Table E-1

## Appendix H Btu output tables

This appendix contains charts that show the relationship between heating load supplied by radiant floors (Btu/hr/ft<sup>2</sup> of floor area) and the supply water temperature to the floor, based on the R-value of floor coverings. Tables are provided for floor applications (thin-slab, slab on grade, Climate Panels, Climate Trak and Heat Transfer Plates). To use the tables, follow this procedure:

1. Determine the floor type and tubing spacing.
2. Determine the finish floor's (e.g., carpet and pad, hardwood, ceramic tile, etc.) R-value (R<sub>ff</sub>).
3. Select the appropriate Btu output table based on the floor type.
4. Determine the upward heat flux (q<sub>u</sub>), based on the average water temperature in the tubing at the design load (T<sub>w</sub>).

### Example

Floor type: Thin-slab, 6" o.c. spacing

Finish floor R-value: R<sub>ff</sub> = 0.5 hr\*ft<sup>2</sup>\*°F/Btu

Average water temperature in the tubing at the design load: T<sub>w</sub> = 110°F

Upward heat flux: q<sub>u</sub> = 31.1 Btu/hr/ft<sup>2</sup>

Thin-Slab Upward Heat Flux (Btu/hr/ft <sup>2</sup> )															
T <sub>w</sub> (°F)	R <sub>ff</sub> =0			R <sub>ff</sub> =0.5			R <sub>ff</sub> =1.0			R <sub>ff</sub> =1.5			R <sub>ff</sub> =2.0		
	6" o.c.	9" o.c.	12" o.c.	6" o.c.	9" o.c.	12" o.c.	6" o.c.	9" o.c.	12" o.c.	6" o.c.	9" o.c.	12" o.c.	6" o.c.	9" o.c.	12" o.c.
80	14.4	11.6	11.5	8.9	7.9	7.8	6.5	5.9	5.3	5.2	4.8	4.3	4.2	4.0	3.7
85	20.4	16.5	16.3	12.6	11.2	11.1	9.2	8.3	7.5	7.3	6.8	6.1	6.0	5.6	5.3
90	26.4	21.3	21.1	16.3	14.5	14.3	11.9	10.8	9.7	9.5	8.8	7.9	7.7	7.3	6.8
95	32.4	26.2	25.9	20.0	17.8	17.6	14.6	13.2	11.9	11.6	10.8	9.7	9.5	8.9	8.4
100	38.4	31.0	30.7	23.7	21.1	20.8	17.3	15.7	14.1	13.8	12.8	11.5	11.2	10.6	9.9
105	44.4	35.9	35.5	27.4	24.4	24.1	20.0	18.1	16.3	15.9	14.8	13.3	13.0	12.2	11.5
110	50.4	40.7	40.3	31.1	27.7	27.3	22.7	20.6	18.5	18.1	16.8	15.1	14.7	13.9	13.0
115	56.4	45.6	45.1	34.8	31.0	30.6	25.4	23.0	20.7	20.2	18.8	16.9	16.5	15.5	14.6
120	62.4	50.4	49.9	38.5	34.3	33.8	28.1	25.5	22.9	22.4	20.8	18.7	18.2	17.2	16.1
125	68.4	55.3	54.7	42.2	37.6	37.1	30.8	27.9	25.1	24.5	22.8	20.5	20.0	18.8	17.7
130	74.4	60.1	59.5	45.9	40.9	40.3	33.5	30.4	27.3	26.7	24.8	22.3	21.7	20.5	19.2
135	80.4	65.0	64.3	49.6	44.2	43.6	36.2	32.8	29.5	28.8	26.8	24.1	23.5	22.1	20.8
140	86.4	69.8	69.1	53.3	47.5	46.8	38.9	35.3	31.7	31.0	28.8	25.9	25.2	23.8	22.3
145	92.4	74.7	73.9	57.0	50.8	50.1	41.6	37.7	33.9	33.1	30.8	27.7	27.0	25.4	23.9
150	98.4	79.5	78.7	60.7	54.1	53.3	44.3	40.2	36.1	35.3	32.8	29.5	28.7	27.1	25.4
155	104.4	84.4	83.5	64.4	57.4	56.6	47.0	42.6	38.3	37.4	34.8	31.3	30.5	28.7	27.0
160	110.4	89.2	88.3	68.1	60.7	59.8	49.7	45.1	40.5	39.6	36.8	33.1	32.2	30.4	28.5

Table F-1 Upward heat flux (q<sub>u</sub>) for a thin-slab, given as a function of finished floor R-value (R<sub>ff</sub>), tubing spacing (6, 9 or 12" on center) and average water temperature in tubing (T<sub>w</sub>). Assumes 68°F room temperature and adequate insulation.

Slab on Grade Upward Heat Flux (Btu/hr/ft <sup>2</sup> )															
T <sub>w</sub> (°F)	R <sub>ff</sub> =0			R <sub>ff</sub> =0.5			R <sub>ff</sub> =1.0			R <sub>ff</sub> =1.5			R <sub>ff</sub> =2.0		
	6" o.c.	9" o.c.	12" o.c.	6" o.c.	9" o.c.	12" o.c.	6" o.c.	9" o.c.	12" o.c.	6" o.c.	9" o.c.	12" o.c.	6" o.c.	9" o.c.	12" o.c.
80	13.6	12.0	10.6	8.5	8.0	7.4	6.4	6.0	5.6	5.0	4.8	4.6	4.1	4.0	3.8
85	19.2	17.0	15.0	12.1	11.4	10.5	9.0	8.5	8.0	7.1	6.8	6.5	5.8	5.6	5.4
90	24.9	22.0	19.4	15.6	14.7	13.6	11.7	11.0	10.3	9.2	8.8	8.4	7.5	7.3	7.0
95	30.5	27.0	23.8	19.2	18.1	16.7	14.3	13.5	12.7	11.3	10.8	10.3	9.2	8.9	8.6
100	36.2	32.0	28.2	22.7	21.4	19.8	17.0	16.0	15.0	13.4	12.8	12.2	10.9	10.6	10.2
105	41.8	37.0	32.6	26.3	24.8	22.9	19.6	18.5	17.4	15.5	14.8	14.1	12.6	12.2	11.8
110	47.5	42.0	37.0	29.8	28.1	26.0	22.3	21.0	19.7	17.6	16.8	16.0	14.3	13.9	13.4
115	53.1	47.0	41.5	33.4	31.5	29.1	24.9	23.5	22.1	19.7	18.8	17.9	16.0	15.5	15.0
120	58.8	52.0	45.9	36.9	34.8	32.2	27.6	26.0	24.4	21.8	20.8	19.8	17.7	17.2	16.6
125	64.4	57.0	50.3	40.5	38.2	35.3	30.2	28.5	26.8	23.9	22.8	21.7	19.4	18.8	18.2
130	70.1	62.0	54.7	44.0	41.5	38.4	32.9	31.0	29.1	26.0	24.8	23.6	21.1	20.5	19.8
135	75.7	67.0	59.1	47.6	44.9	41.5	35.5	33.5	31.5	28.1	26.8	25.5	22.8	22.1	21.4
140	81.4	72.0	63.5	51.1	48.2	44.6	38.2	36.0	33.8	30.2	28.8	27.4	24.5	23.8	23.0
145	87.0	77.0	67.9	54.7	51.6	47.7	40.8	38.5	36.2	32.3	30.8	29.3	26.2	25.4	24.6
150	92.7	82.0	72.3	58.2	54.9	50.8	43.5	41.0	38.5	34.4	32.8	31.2	27.9	27.1	26.2
155	98.3	87.0	76.7	61.8	58.3	53.9	46.1	43.5	40.9	36.5	34.8	33.1	29.6	28.7	27.8
160	104.0	92.0	81.1	65.3	61.6	57.0	48.8	46.0	43.2	38.6	36.8	35.0	31.3	30.4	29.4

Table F-2 Upward heat flux ( $q_u$ ) for a slab on grade, given as a function of finished floor R-value ( $R_{ff}$ ), tubing spacing (6, 9 or 12" on center) and average water temperature in tubing ( $T_w$ ). Assumes 68°F room temperature and adequate insulation.

Climate Trak or Heat Transfer Plates Upward Heat Flux (Btu/hr/ft <sup>2</sup> ) for Tubing Spacing of 8" o.c.						
T <sub>w</sub> (°F)	R <sub>ff</sub> =0	R <sub>ff</sub> =0.5	R <sub>ff</sub> =1.0	R <sub>ff</sub> =1.5	R <sub>ff</sub> =2.0	
80	6.2	5.0	4.1	3.5	3.1	
85	8.8	7.1	5.8	4.9	4.4	
90	11.4	9.2	7.5	6.4	5.7	
95	14.0	11.3	9.2	7.8	7.0	
100	16.6	13.4	10.9	9.3	8.3	
105	19.2	15.5	12.6	10.7	9.6	
110	21.8	17.6	14.3	12.2	10.9	
115	24.4	19.7	16.0	13.6	12.2	
120	27.0	21.8	17.7	15.1	13.5	
125	29.6	23.9	19.4	16.5	14.8	
130	32.2	26.0	21.1	18.0	16.1	
135	34.8	28.1	22.8	19.4	17.4	
140	37.4	30.2	24.5	20.9	18.7	
145	40.0	32.3	26.2	22.3	20.0	
150	42.6	34.4	27.9	23.8	21.3	
155	45.2	36.5	29.6	25.2	22.6	
160	47.8	38.6	31.3	26.7	23.9	

Table F-3 Upward heat flux ( $q_u$ ) for floor using Climate Trak or Heat Transfer Plates, given as function of finished floor R-value ( $R_{ff}$ ), tubing spacing (8" on center) and average water temperature in tubing ( $T_w$ ). Assumes 68°F room temperature and adequate insulation.

Climate Panel Upward Heat Flux (Btu/hr/ft <sup>2</sup> )								
T <sub>w</sub> (°F)	R <sub>ff</sub> =0.5		R <sub>ff</sub> =1.0		R <sub>ff</sub> =1.5		R <sub>ff</sub> =2.0	
	7" o.c.	10" o.c.	7" o.c.	10" o.c.	7" o.c.	10" o.c.	7" o.c.	10" o.c.
80	5.8	5.4	4.9	4.6	4.0	3.7	3.1	2.9
85	8.2	7.7	7.0	6.5	5.6	5.3	4.4	4.1
90	10.6	9.9	9.0	8.4	7.3	6.8	5.7	5.3
95	13.0	12.2	11.1	10.3	8.9	8.4	7.0	6.5
100	15.4	14.4	13.1	12.2	10.6	9.9	8.3	7.7
105	17.8	16.7	15.2	14.1	12.2	11.5	9.6	8.9
110	20.2	18.9	17.2	16.0	13.9	13.0	10.9	10.1
115	22.6	21.2	19.3	17.9	15.5	14.6	12.2	11.3
120	25.0	23.4	21.3	19.8	17.2	16.1	13.5	12.5
125	27.4	25.7	23.4	21.7	18.8	17.7	14.8	13.7
130	29.8	27.9	25.4	23.6	20.5	19.2	16.1	14.9
135	32.2	30.2	27.5	25.5	22.1	20.8	17.4	16.1
140	34.6	32.4	29.5	27.4	23.8	22.3	18.7	17.3
145	37.0	34.7	31.6	29.3	25.4	23.9	20.0	18.5
150	39.4	36.9	33.6	31.2	27.1	25.4	21.3	19.7
155	41.8	39.2	35.7	33.1	28.7	27.0	22.6	20.9
160	44.2	41.4	37.7	35.0	30.4	28.5	23.9	22.1

Table F-4 Upward heat flux ( $q_u$ ) for a floor using Climate Panel, given as function of finished floor R-value ( $R_{ff}$ ), tubing spacing and average water temperature in tubing ( $T_w$ ). Assumes 68°F room temperature and adequate insulation.

**Air Changes:** The rate of air leakage into a building: One air change per hour means the entire volume of air in the building is replaced with outside air each hour.<sup>44</sup>

**Btu, British Thermal Unit:** The amount of energy required to raise one pound of water by one degree Fahrenheit.<sup>44</sup>

**Cavitation:** The formation of vapor pockets when the pressure on a liquid drops below its vapor pressure. Cavitation is very undesirable in circulators.<sup>44</sup>

**Constant Circulation:** Pump is active throughout entire heating or cooling season to maintain constant flow through heated area. Temperature is controlled by resetting the water temperature to match the desired output.

**Circuit (a.k.a Loop):** A portion of a radiant panel typically consisting of PEX tubing that runs to and from a manifold. The circuit may be one of many circuits in a zone or could be a zone itself.

**Dead Heading:** An undesirable operating condition in which a circulator is running, but all flow through it is blocked.<sup>44</sup>

**Delta T ( $\Delta T$ ):** Temperature Difference

**Design Temperature:**

Indoor Design Temperature: The designed indoor temperature for a given space

Outdoor Design Temperature: The set of temperature, humidity and wind conditions that is used to estimate the heating and cooling loads for a dwelling

**Direct Return:** Parallel piping in which the first branch connected on the supply is also the first branch connected on the return. This may require balancing valves to ensure each parallel branch receives balanced flow.

**Feet of Head:** The common English units of expressing the head energy of a fluid. The units of feet represent the total mechanical energy content of each pound of fluid and are derived from simplifying the units of FT•lb/lb.<sup>44</sup>

**Fixed Flow Rate:** Occurs when a circulator operates at a single speed setting, which only

deviates when the circulator turns on or off.

**Fixed Temperature Setting:** Occurs when a radiant heating or cooling source's supply temperature is at a single temperature setting, which only deviates when the heating or cooling source turns on or off.

**Flow Rate:** The volumetric rate of flow of a fluid. For liquids it is often expressed in units of gallons per minute (gpm). For gases, it is often expressed in units or cubic feet per minute (cfm).<sup>44</sup>

**Flow Velocity:** The speed of an imaginary fluid particle at some point in a piping system. Common English units for flow velocity are feet per second.<sup>44</sup>

**F-Value:** Heat loss per foot of exposed edge per degree of indoor-outdoor temperature difference. F-values depend on slab R-value, the amount of edge insulation (when installed), the placement of the insulating material and the resistance of the soil path.

**Heat Loss:** The rate of heat lost through a panel or building from inside to out.

**Hydraulic Separation:** A design objective in a radiant piping system that permits greater temperature and flow control across circuits through the use of closely spaced tees, a low loss header or a hydraulic separator.

**Hydronic:** Of, or relating to, or being a system of heating or cooling that involves transfer of heat by a circulating fluid (as water or vapor) in a closed system of pipes.<sup>45</sup>

**Infiltration:** The unintentional leakage of outside air into a heated space.<sup>44</sup>

**Infiltration Explanations:**

**Tight:** All structural panels, corners, cracks, joints and penetrations are sealed by meticulous workmanship using some combination of air barrier (film), taping, packing and caulking. Window and door assemblies are rated at less than 0.25 CFM per running foot of crack at 25 mph (wind speed). Bath exhaust fans, kitchen exhaust fans and dryer vents are equipped with backdraft dampers. The home does not have ceiling recessed light fixtures or, if so, there is a negligible amount of leakage around the fixture. No combustion equipment

44. From SIEGENTHALER. Modern Hydronic Heating, 3E. © 2012 Delmar Learning, a part of Cengage Learning, Inc.

Reproduced by permission. [www.cengage.com/permissions](http://www.cengage.com/permissions)

45. ©2013 Merriam-Webster, Inc. "Hydronic." Retrieved December 2013 from <http://www.merriam-webster.com/dictionary/hydronic>.

(furnaces, water heaters, dryers, etc.) contained within the conditioned space or, if so, they are to be of the direct-vent variety. The house does not have powerful range hoods (i.e., 150 CFM or greater). (A high-power hood that has its own source of makeup air is acceptable.) Fireplaces, if any, receive combustion air from the outdoors and have tight glass doors.

**Semi-Tight:** Envelope conditions are approximately between Tight and Average

**Average:** All structural panels, corners, cracks, joints and penetrations reasonably sealed by adequate workmanship using some combination of air barrier (film), taping, packing and caulking. Window and door assemblies rated between 0.25 and 0.50 CRM per running foot of crack at 25 mph (wind speed). All bath exhaust fans, kitchen exhaust fans and dryer vents are equipped with backdraft dampers. The home does not use ceiling and recessed light fixtures or, if so, there is a minor amount of leakage around the fixture. No envelope openings (per National Fuel Gas Code) are required for combustion air. The house does not have powerful range hoods (i.e., 150 CFM or greater). (A high-power hood that has its own source of makeup air is acceptable.) Fireplaces, if any, receive combustion air from the indoors but have tight glass doors and a chimney damper.

**Semi-Loose:** Envelope conditions are approximately between Average and Loose

**Loose:** There has been no effort or inadequate effort (regarding methods, materials and workmanship) to seal the structural panels, the associated corner, cracks, joints and penetrations and/or there is a large amount of ceiling recessed light fixture (or light-can) leakage. Window and door assemblies are not rated, or are rated at more than 0.50 CRM per running foot of crack at 25 mph (wind speed). Some, or all, of the bath exhaust fans, kitchen exhaust fans and dryer vents are not equipped with back draft dampers. Envelope openings (per National Fuel Gas Code) are required for combustion air. Powerful range hoods (i.e., 150 CFM or greater) used that do not have their own source of makeup air require powered air-makeup, an open window for makeup air or a negative pressure relief. Fireplaces, if any, receive combustion air from the indoors and do not have glass doors or chimney dampers.

**Mean Cooling Water Temperature:** Average of supply and return water temperatures at the radiant panel.

**Mean Radiant Temperature:** The effective, overall temperature of those surfaces to or from which a radiant panel may emit or receive heat in the form of radiation. This temperature also takes into account the inclination of the surfaces with respect to the radiant panel, through a term called the “angle factor.” For typical indoor applications, the indoor ambient drybulb temperature can be used as a proxy for the mean radiant temperature. When there are large deviations in emissivity and temperature across the surfaces seen by a radiant panel, calculation of the MRT by a more specific method may be required. (See ASHRAE Fundamentals 2009, Chapter 9, for more information.)

**Outdoor Reset Control:** A control method that increases the water temperature in a hydronic system as the outdoor temperature drops.<sup>44</sup>

**Panel Piping:** Piping that is used within the radiant emitter.

**Parallel Piping:** Piping that has two or more branches tied into a common supply and common return.

**Primary Piping:** Piping that carries fluid from the heating or cooling source to secondary piping, panel piping or a radiant emitter.

**Radiant Panel:** PEX tubing consisting of a dry or wet mass flooring system using any number of attachment methods.

**Reverse Return:** Parallel piping in which the first branch connected on the supply is also the last branch connected on the return. This can aid in providing balanced flow throughout each parallel branch.

**R-Value of a Material:** A value indicating the thermal resistance of the material. The greater the R-value, the slower heat will conduct through the material, all other conditions being equal.<sup>44</sup>

---

**Secondary Piping:** Piping that is either directly connected to primary piping or originates off manifolds fed by primary piping, but is not located within a radiant emitter.

**Series Piping:** Piping that connects manifolds or radiant emitters from end-to-end, creating one continuous loop.

**Snow-Free Area Ratio (Ar):** The ratio of the surface area where no accumulation takes place during snowfall versus the total area of the surface.

**Snow-Melt Confidence Level:** The percent of the hours of snowfall during a typical year that the snow-free area ratio is maintained.

**U-Value:** U-value (or U-factor) is a measure of the rate of heat loss or gain through a construction of materials. The lower the U-factor, the greater the material's resistance to heat flow and the better the insulating value. U-value is the inverse of R-value.

**Variable Flow Rate:** Occurs when a circulator operates at multiple speed settings.

**Variable Temperature Setting:** Occurs when a radiant heating or cooling source's supply temperature is delivered at multiple settings.

**Zone:** An area of a building for which space conditioning is controlled by a single thermostat.<sup>44</sup>

**Excerpts from CSA Group, B214-12**

With the permission of the Canadian Standards Association (operating as CSA Group), material is reproduced from CSA Group standard, B214-12, "Installation Code For Hydronic Heating Systems" which is copyrighted by CSA Group, 5060 Spectrum Way, Suite 100, Mississauga ON, L4W 5N6. This material is not the complete and official position of CSA Group on the referenced subject, which is represented solely by the standard in its entirety. While use of the material has been authorized, CSA is not responsible for the manner in which the data is presented, nor for any interpretations thereof. For more information or to purchase standards from CSA Group, please visit <http://shop.csa.ca/> or call 1-800-463-6727.

**Excerpts from NRC**

With the permission of the National Research Council of Canada (NRC), material is reproduced from NRC, "National Energy Code of Canada for Buildings 2011" Articles 3.2.2.2., 3.2.3.1. and 3.2.4.1., Subsection 3.3.1. and Figure A-1.1.4.1.(1) in Appendix A of Division B which is copyrighted by NRC, 1200 Montreal Road, Ottawa, Canada, K1A 0R6. This material is not the complete and official position of NRC on the referenced subject, which is represented solely by the standard in its entirety. While use of the material has been authorized, NRC is not responsible for the manner in which the data is presented, nor for any interpretations thereof.





## Viega LLC

100 N. Broadway, 6<sup>th</sup> Floor  
Wichita, KS 67202

Phone: 1-800-976-9819

Fax: 1-316-425-7618

[www.viega.us](http://www.viega.us)

This document subject to updates. For the most current Viega technical literature please visit [www.viega.us](http://www.viega.us).  
Click Services -> Click Electronic Literature Downloads -> Select Product Line -> Select Desired Document

©2015, Viega®, ProPress®, MegaPress®, SeaPress®, ProGeo® and FostaPEX®, are registered trademarks of Viega GmbH & Co. KG. Smart Connect®, ManaBloc® and Radiant Wizard® are registered trademarks of Viega LLC. ViegaPEX™, is a trademark of Viega GmbH & Co. KG. MiniBloc™, ProRadiant™, Zero Lead™, PolyAlloy™, SmartLoop™, are trademarks of Viega LLC. RIDGID® is a registered trademark of RIDGID, Inc. LoopCAD® is a registered trademark of Avenir Software Inc.

