

# ARGCO

1	TWO PIECE PENDANT ESCUTCHEONS
2	TWO PIECE RECESSED ESCUTCHEONS
2	ONE PIECE ESCUTCHEONS
2	HEADGUARDS
3	CORROSION RESISTANT ESCUTCHEONS
4-5	WALL PLATES
6-7	REPLACEMENT ESCUTCHEONS
8-9	ALARM PRODUCTS
10	HEADBOXES
10	GAUGES
10-14	SPRINKLER ID SIGNS



800-854-1015

[www.argco.com](http://www.argco.com)



**FIRE SPRINKLER SPECIALTIES**

## TWO PIECE ADJUSTABLE STEEL ESCUTCHEONS

### 1-A CUPS PENDANT



#### All Cups Interchangeable with Skirts

**General Character:**  
Type 1010-1018 mild steel  
0.40 - 0.42 mm thick  
1/2" and 3/4" IPS

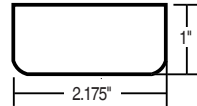

**Short Cup**  
45-10-031 1/2" IPS  
45-10-032: 3/4" IPS

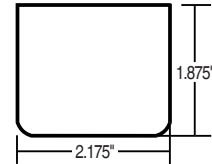

**Standard Cup**  
45-10-001 1/2" IPS  
45-10-002: 3/4" IPS

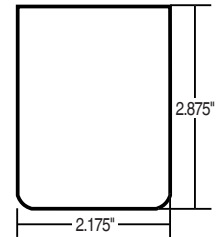

**Extra Long Cup**  
45-10-003EL: 1/2" IPS

### 1-B SKIRTS PENDANT

#### All skirts Interchangeable with cups

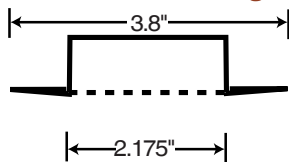

**Flush Skirt**  
adjustable 1/4" to 3/4"  
with short cup  
1/4" to 1-5/8" with standard cup  
(45-10-051)

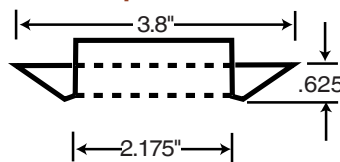

**Short Taper Skirt**  
adjustable 3/4" to 1"  
with short cup  
3/4" to 1-7/8" with standard cup  
(45-10-061)

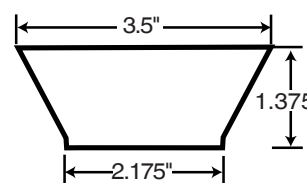

**Standard 401 Style Skirt**  
adjustable to 2" to 3"  
with standard cup  
(45-10-041)

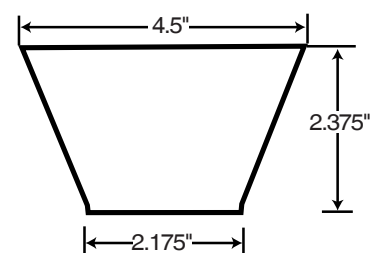

**Extra Deep Skirt**  
adjustable 3" to 5"  
with standard cup  
(45-10-047)

### 1-C 2 PC. EXTENDED ESCUTCHEON

#### Adjustable 2-7/8" to 4-7/8"



Type 1010-1018 mild steel  
0.40 - 0.42 mm thick

(45-10-280)

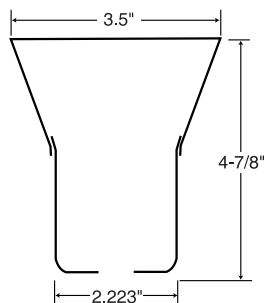
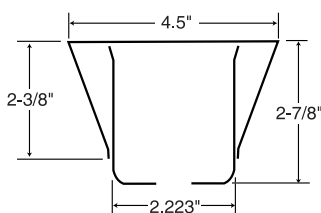

### 1-D 3 PC. EXTENDED ESCUTCHEON



1010-1018 mild steel  
0.40 - 0.42 mm thick  
1/2" and 3/4" ips

#### Four Models, adjustable from:

- 4" to 5-1/4" deep: 45-10-010
- 6" to 7-1/4" deep: 45-10-012
- 8" to 9-1/4" deep: 45-10-014
- 10" to 11-1/4" deep: 45-10-016

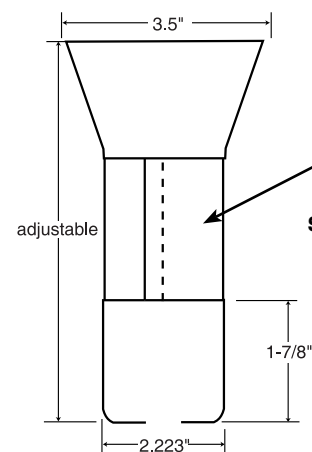

Split tube allows installation after standard cup is installed.

# STEEL ESCUTCHEONS CONT.

## 2-A TWO PIECE RECESSED ESCUTCHEON



General Character:  
Type 1010-1018 mild steel 0.40 - 0.42 mm thick  
1/2" and 3/4" IPS

Corrosion resistant aluminum & stainless steel also available

Chrome Plated, White, Brass, Antique Brass, Off-White, Black

**Standard**  
3/4" Adjustment  
45-10-071: 1/2" IPS  
45-10-075: 3/4" IPS

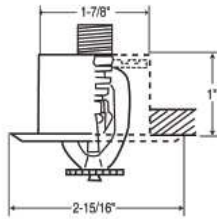

**Large**  
(1-1/4" Adjustment)  
45-10-081: 1/2" IPS  
45-10-085: 3/4" IPS

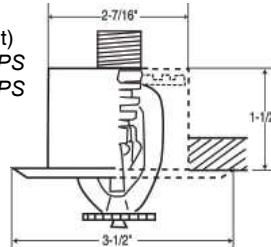

**Short**  
1/2" Adjustment  
45-10-068: 1/2" IPS  
45-10-065: 3/4" IPS

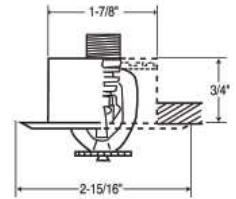

## 2-B ONE PIECE CANOPIES

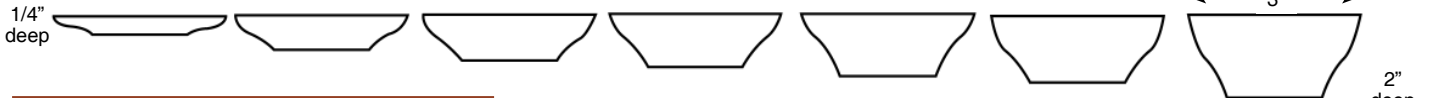

45-15-020 1/4" deep x 1/2" IPS  
45-15-021 1/4" deep x 3/4" IPS  
45-15-023 1/2" deep x 1/2" IPS  
45-15-024 1/2" deep x 3/4" IPS  
45-15-025 3/4" deep x 1/2" IPS  
45-15-026 3/4" deep x 3/4" IPS

45-15-027 1" deep x 1/2" IPS  
45-15-028 1" deep x 3/4" IPS  
45-15-029 1-1/4" deep x 1/2" IPS  
45-15-030 1-1/4" deep x 3/4" IPS  
45-15-031 1-1/2" deep x 1/2" IPS  
45-15-032 1-1/2" deep x 3/4" IPS

45-15-033 1-3/4" deep x 1/2" IPS  
45-15-034 1-3/4" deep x 3/4" IPS  
45-15-038 2" deep x 1/2" IPS  
45-15-039 2" deep x 3/4" IPS

## HEADGUARDS

FOR PROTECTION OF SPRINKLER HEADS IN INDUSTRIAL APPLICATIONS (storage racks, low drops, etc.)

### 2-C ONE PIECE DOUBLE HOOK HEADGUARD

Heavy wire construction with latch hooks, exposed for easy installation

Available with spot welded 4-1/2" baffle plate

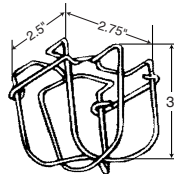

45-30-100: 1/2" IPS  
45-30-103: 3/4" IPS  
45-30-104: with baffle plate available chrome plated or white

### 2-D TWO PIECE UNIVERSAL HEADGUARD

Red Powder Coated

45-30-150: 1/2" IPS  
45-30-157: 3/4" IPS  
45-30-153: baffle plate

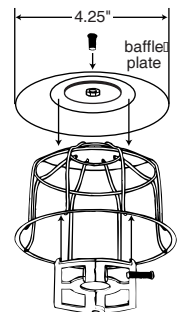
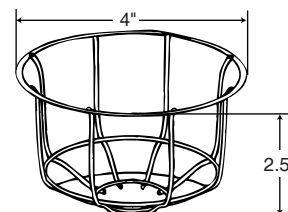

### 2-E HEAT COLLECTOR

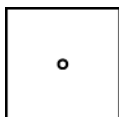

12" x 12" with 1/2" IPS hole  
.040 Aluminum  
Powder coated white

45-30-158

800-854-1015

www.argco.com

FAX 760-727-3270

## CORROSION RESISTANT SPRINKLER HEAD ESCUTCHEONS

### 3-A PLASTIC TWO PIECE PENDANT



STANDARD 401 STYLE  
Corrosion resistant - great for outdoor applications  
Stock Finishes:  
chrome plated and white

1/2" IPS

45-25-090

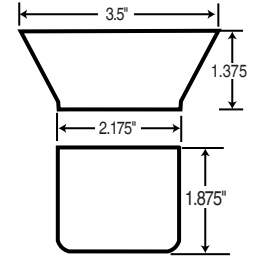

### 3-B PLASTIC 1 PC. 5/8" DEEP

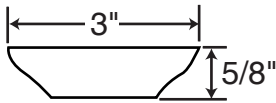

Corrosion resistant plastic

Stock Finishes:  
chrome plated and white

1/2" ips

45-25-092

### 3-C PLASTIC ROD BUTTON



Made from Injection Molded Plastic  
For 3/8" threaded rod

Stock Finishes:  
chrome plated and white

45-15-505

### 3-D ALUMINUM & STAINLESS STEEL TWO PIECE ESCUTCHEON

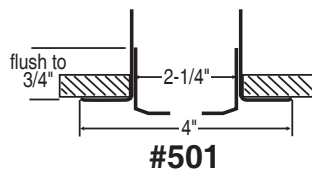
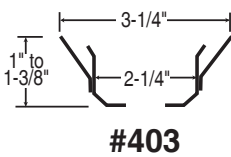
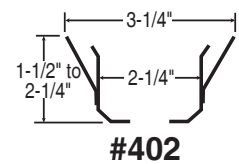
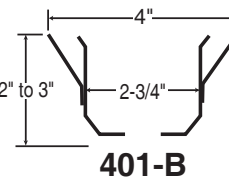
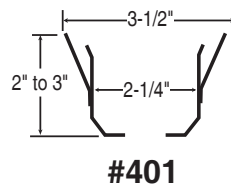
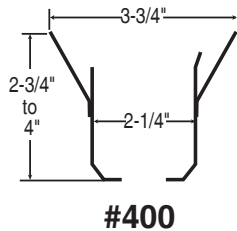
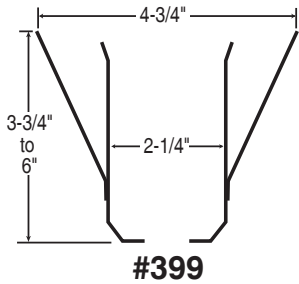

Part Number	DESCRIPTION	CEILING COVERAGE	ADJUSTABLE DEPTH
45-25-280	2 pc #399	4-3/4"	3-3/4" - 6"
45-25-282	2 pc #400	3-3/4"	2-3/4" - 4"
45-25-286	2 pc Flush/Recessed (501)	4"	Flush to 3/4" recessed
45-25-288	2 pc Standard Pendant (401)	3-1/2"	2" - 3"
45-25-290	2 pc. (401B) with 3-1/4" lg. dia.	4"	2" - 3"
45-25-292	2 pc. 402	3-1/4"	1-1/2" - 2-1/4"
45-25-294	2 pc 403	3-1/4"	1" - 1-3/8"

Stock Finishes: polished aluminum, stainless steel

### 3-E ALUMINUM & STAINLESS STEEL ONE PIECE ESCUTCHEON

**One Piece Escutcheon  
Up to 2" deep**

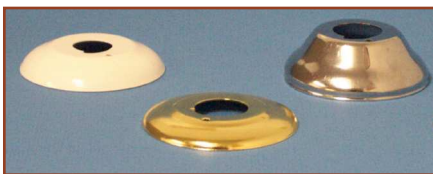

3" coverage - 1/4" to 2" depth

specify 1/2" or 3/4" IPS

(45-25-271 thru 279)

**One Piece Extended  
Escutcheon  
(Up to 15" deep)**

From 3" to 15" deep

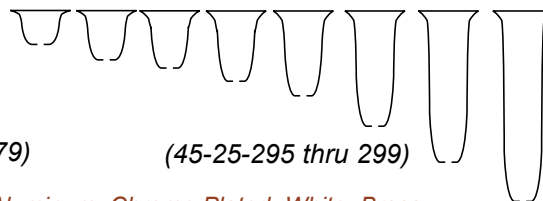

(45-25-295 thru 299)

Finishes: Polished Aluminum, Chrome Plated, White, Brass



# WALL PLATES

## 4-A HEAVY GAUGE STEEL SPLIT RING F/C PLATE



Hinged floor and ceiling plate with spring steel inserts and positive locking tabs

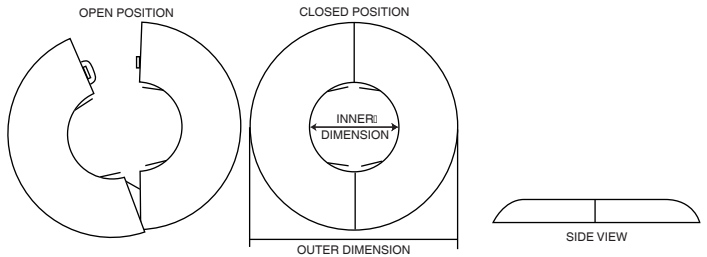

Available 1/4" to 10" ips and 3/8" to 4" cps

For inner and outer dimensions, see pricing page

Stock finish: chrome plated

45-20-113	1/4" IPS & 3/8" CPS
45-20-114	3/8" IPS & 1/2" CPS
45-20-100	1/2" IPS & 3/4" CPS
45-20-101	3/4" IPS
45-20-102	1" IPS
45-20-116	1" CPS
45-20-117	1-1/4" CPS
45-20-103	1-1/4" IPS & 1-1/2" CPS
45-20-104	1-1/2" IPS
45-20-105	2" IPS
45-20-119	2" CPS

45-20-106	2-1/2" IPS
45-20-120	2-1/2" CPS
45-20-107	3" IPS
45-20-121	3" CPS
45-20-107A	3-1/2" IPS & 4" CPS
45-20-108	4" IPS
45-20-109	5" IPS
45-20-123	5" CPS
45-20-110	6" IPS
45-20-124	6" CPS

45-20-111	8" IPS
45-20-125	8" CPS (ALUMINUM)
45-20-112	10" IPS
45-21-113	12" IPS (ALUMINUM)
45-21-114	14" IPS (ALUMINUM)
45-21-115	15" IPS (ALUMINUM)
45-21-116	16" IPS (ALUMINUM)
45-21-118	18" IPS (ALUMINUM)

## 4-B LIGHT GAUGE STEEL SPLIT RING F/C PLATE



Hinged with springs for easy installation & centering on pipe

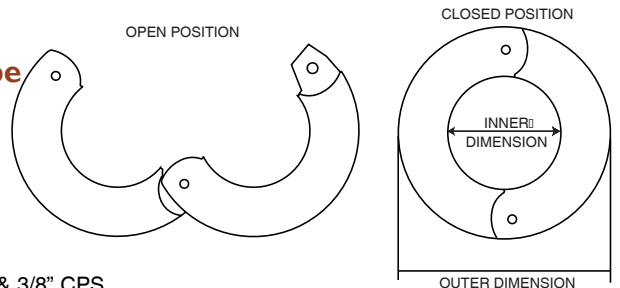

Available 3/8" to 2" ips and 3/8" to 1-1/2" cps

For inner & outer dimensions see pricing page

Stock finish: chrome plated

45-20-211	1/4" IPS & 3/8" CPS
45-20-212	3/8" IPS & 1/2" CPS
45-20-200	1/2" IPS & 3/4" CPS
45-20-201	3/4" IPS
45-20-202	1" IPS
45-20-214	1" CPS

45-20-203	1-1/4" IPS & 1-1/2" CPS
45-20-215	1-1/4" CPS
45-20-204	1-1/2" IPS
45-20-216	1-1/2" CPS
45-20-205	2" IPS

## 4-C PLASTIC SPLIT RING F/C PLATE

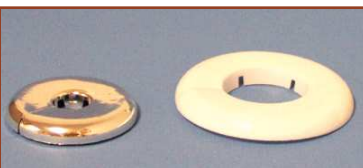

Tough, durable plastic

Non-breakable

100 % Rust Proof

Simply Bend Open...



...and Snap Closed!

45-25-301	3/8" IPS & 1/2" CPS
45-25-100	1/2" IPS & 3/4" CPS
45-25-101	3/4" IPS
45-25-102	1" IPS
45-25-302	1" CPS
45-25-103	1-1/4" IPS & 1-1/2" CPS
45-25-303	1-1/4" CPS
45-25-104	1-1/2" IPS

45-25-105	2" IPS
45-25-304	2" CPS
45-25-106	2-1/2" IPS
45-25-107	3" IPS
45-25-108	4" IPS
45-25-109	5" IPS
45-25-110	6" IPS
45-25-111	8" IPS

Stock finishes: chrome plated and white

## 4-D ALUM. /STAINLESS STEEL

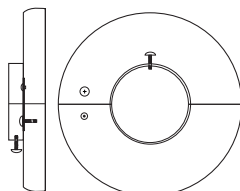

Split Ring With Set Screw  
Corrosion resistant floor & ceiling plate

Available 3/8" to 18" IPS and CPS

45-19-205 thru 234

## 4-E ALUM./STAINLESS STEEL

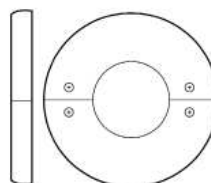

Split Ring

Corrosion resistant floor & ceiling plate

Available 3/8" to 18" IPS and CPS

45-21-098 thru 118



# ARGCO



## SOLID FORGED WALL PLATES

### 5-A CHROME PLATED FORGED BRASS WALL PLATES

Heavy duty solid forged brass with beautiful chrome plating and set screw

**CHROME PLATED**

PART #	SIZE	I.D.	O.D.
45-19-002CP	1/2" IPS		
45-19-003CP	3/4" IPS		
45-19-005CP	1" IPS	2-7/16"	3-3/4"
45-19-010CP	1-1/4" IPS	1-11/16"	4"
45-19-115CP	1-1/2" IPS	1-15/16"	4-1/4"
45-19-120CP	2" IPS	2-7/16"	4-11/16"
45-19-125CP	2-1/2" IPS	2-15/16"	5-1/2"
45-19-130CP	3" IPS	3-5/8"	6"
45-19-135CP	4" IPS	4-9/16"	7-1/16"
45-19-140CP	6" IPS	6-3/4"	9-3/4"



### 5-B RETROFIT SPLIT-TABBED CHROME PLATED WALL PLATES

Heavy duty chrome plated forged brass split with locking tabs and set screw

Fits around existing pipe

**CHROME PLATED**

PART #	SIZE	I.D.	O.D.
45-18-002	1/2" IPS		
45-18-003	3/4" IPS		
45-18-005	1" IPS	2-7/16"	3-3/4"
45-18-010	1-1/4" IPS	1-11/16"	4"
45-18-015	1-1/2" IPS	1-15/16"	4-1/4"
45-18-020	2" IPS	2-7/16"	4-11/16"
45-18-025	2-1/2" IPS	2-15/16"	5-1/2"
45-18-030	3" IPS	3-5/8"	6"
45-18-035	4" IPS	4-9/16"	7-1/16"
45-18-040	6" IPS	6-3/4"	9-3/4"



### 5-C FORGED BRASS WALL PLATES

Heavy duty forged brass with set screw

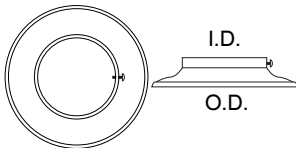

PART #	SIZE	I.D.	O.D.
45-19-005BR	1" IPS	2-7/16"	3-3/4"
45-19-010BR	1-1/4" IPS	1-11/16"	4"
45-19-115BR	1-1/2" IPS	1-15/16"	4-1/4"
45-19-120BR	2" IPS	2-7/16"	4-11/16"
45-19-125BR	2-1/2" IPS	2-15/16"	5-1/2"
45-19-130BR	3" IPS	3-5/8"	6"
45-19-135BR	4" IPS	4-9/16"	7-1/16"
45-19-140BR	6" IPS	6-3/4"	9-3/4"



### 5-D GALVANIZED FORGED STEEL WALL PLATES

Heavy duty forged steel with set screw

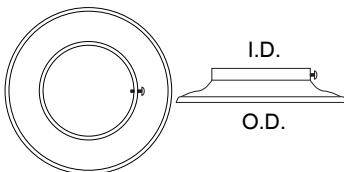

PART #	SIZE	I.D.	O.D.
45-19-005	1" IPS	2-7/16"	3-3/4"
45-19-010	1-1/4" IPS	1-11/16"	4"
45-19-115	1-1/2" IPS	1-15/16"	4-1/4"
45-19-120	2" IPS	2-7/16"	4-11/16"
45-19-125	2-1/2" IPS	2-15/16"	5-1/2"
45-19-130	3" IPS	3-5/8"	6"
45-19-135	4" IPS	4-9/16"	7-1/16"
45-19-140	6" IPS	6-3/4"	9-3/4"



**ARGCO**  
**Escutcheon SPECIALISTS**

OVER 50 STYLES OF FIRE SPRINKLER/PIPING ESCUTCHEONS & WALL PLATES IN SIX DIFFERENT FINISHES. MANUFACTURED FROM STAMPED STEEL, PLASTIC, ALUMINUM, STAINLESS STEEL, FORGED STEEL AND BRASS. ONE PIECE ESCUTCHEONS 1/4" TO 18" DEEP; TWO & THREE PIECE ADJUSTABLE ESCUTCHEONS - RECESSED TO 13" DEEP. SPLIT & TABBED REPLACEMENT ESCUTCHEONS AND WALL PLATES.

# REPLACEMENT FIRE SPRINKLER ESCUTCHEONS

Replace that old, rusty, beat up escutcheon with ARGCO's split replacement escutcheons

**There is no reason to drain your system!**

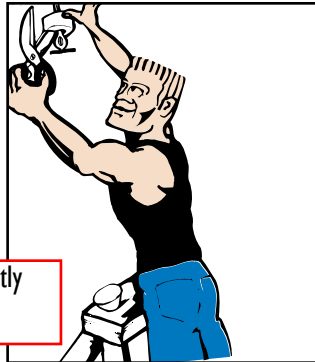

Just cut off your unsightly old escutcheon...

...open your new cup...

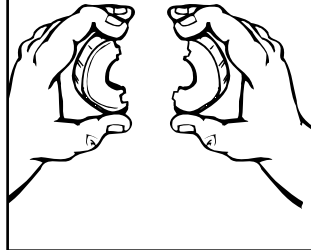

...and snap it around the sprinkler head, and slide on new skirt.

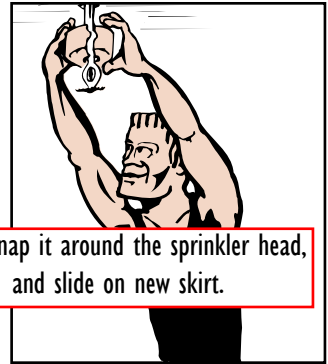

## 6-A TWO PIECE SPLIT CUP ESCUTCHEON

401 Style deep cup split & tabbed.

To be used with all four skirts  
1010-1018 mild steel  
0.40 - 0.42 mm thick

Cup

Side View

Top View

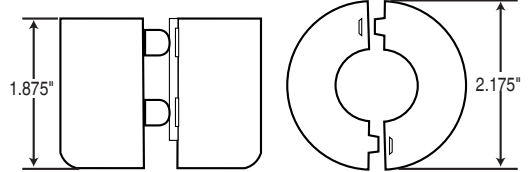

Stock finishes:

chrome plated & white  
**Adjustable depths from 1/4" to 4"**  
**with one of four different skirts**

Tired of your skirts falling off?  
Cut off cup and use our product...  
we guarantee a tight skirt!

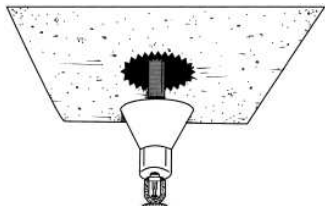

Cut your drop too long exposing pipe?

Use our extra deep skirt and tube extender

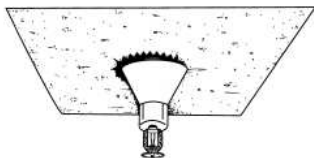

Ceiling hole too large or off-center?

Use our Kydex Split ring to conceal any cutting errors



FLUSH  
ADJUSTABLE  
1/4" TO 1-5/8"  
(45-20-257)

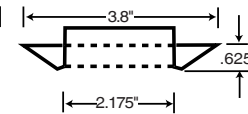
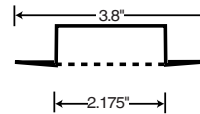

SHORT  
TAPER  
ADJUSTABLE  
3/4" TO 1-7/8"  
(45-20-256)

Skirts

STANDARD  
401  
ADJUSTABLE  
2" TO 3"  
(45-20-255A)

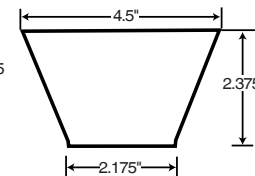
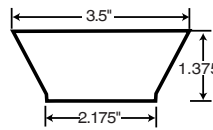

EXTRA  
DEEP  
ADJUSTABLE  
3" TO 4"  
(45-20-258)

## 6-B SPLIT TUBE CUP EXTENDER

**Extend your escutcheons from 4" to 11-1/4"!**

Easily Installs between cup and skirt



1010-1018 mild steel  
0.40 - 0.42 mm thick

Stock finishes:  
chrome plated & white

45-10-009: 4" TO 5-1/4" deep  
45-10-011: 6" top 7-1/4" deep  
45-10-013: 8" to 9-1/4" deep  
45-10-015: 10" to 11-1/4" deep

## 6-C KYDEX SPLIT RING

Conceal oversized holes & cutting errors in ceiling tile

Fire resistant plastic 1/32" thick

Simply flex open and install around existing sprinkler drop.

Custom sizes available

45-15-500

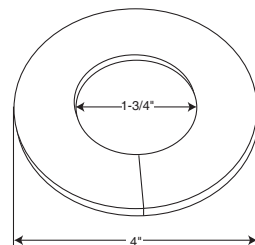

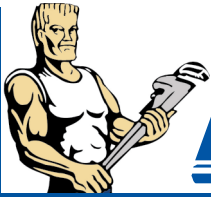

# ARGCO



## REPLACEMENT FIRE SPRINKLER ESCUTCHEONS

### 7-A TWO PIECE SPLIT RECESSED



Standard Recessed Escutcheon (3/4" Adjustment)

Two piece split cup opens then fastens around pipe ...skirt fits around cup

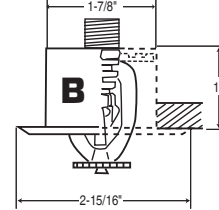
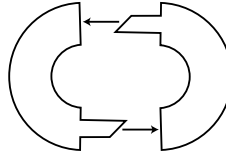

010-1018 mild steel  
0.40 - 0.42 mm thick

1/2" ips

Stock finishes:  
white & chrome plated  
(45-20-259)

### 7-B ONE PIECE SPLIT ESCUTCHEON



Top View

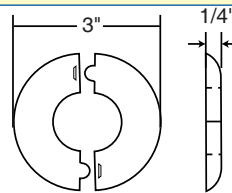

Side View

Shallow one piece split and tabbed canopy.

Stock finishes:  
white & chrome plated

45-20-250: 1/2" IPS  
45-20-251: 3/4" IPS

## CORROSION RESISTANT REPLACEMENT ESCUTCHEONS

### 7-C PLASTIC 1 PIECE SPLIT SCUTCH

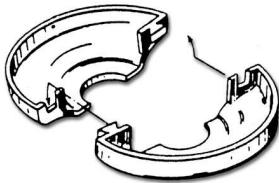

Stock finishes: white & chrome plated  
45-20-253: 5/8" deep  
45-20-254: 1/4" deep

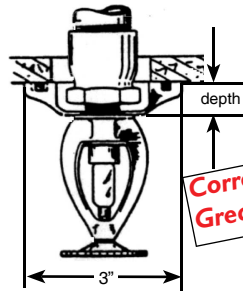

Corrosion Resistant Plastic  
Great for outdoor use!

### 7-C PLASTIC SHIM RING

Adds 1/8" or 1/4" depth to  
One piece canopies

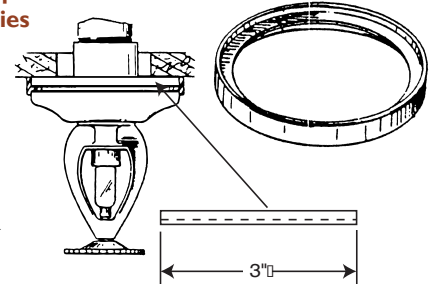

Finishes: white & chrome plated  
(45-20-252)

### 7-D ALUMINUM SPLIT CUP FLUSH / RECESSED ESCUTCHEON

Cup split across bottom and on one side.

Cup opens then closes around pipe, skirt fits over cup

1/2" or 3/4" ips

Stock finish: polished aluminum & white  
(45-20-268)

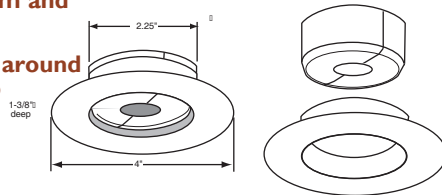

### 7-E ALUMINUM PENDANT ESCUTCHEON

Cup split across bottom & on one side.

Opens then closes around pipe... skirt fits over cup

Stock finish: polished aluminum & white  
45-20-261 - 1/4" deep  
45-20-263 - 1/2" deep  
45-20-265 - 3/4" deep  
25-20-267 - 1" deep

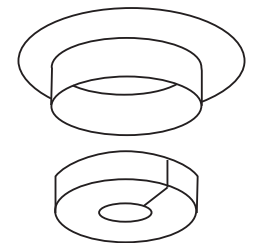

### 7-F ALUMINUM SPLIT CUP (401) PENDANT ESCUTCHEON

401 Style deep split cup & skirt

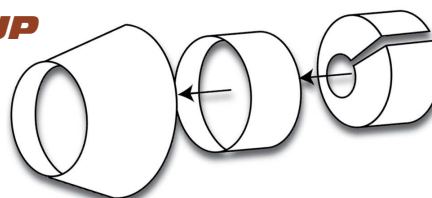

2-3" Adjustable Pendant

Stock finish: polished aluminum  
Available: chrome plated & white

(45-20-269)



# ALARM PRODUCTS

## 8-A FIRE ALARM BELLS



- Two wire, 120 and 24 volt
- Indoor and outdoor installation
- Weatherproof Backbox

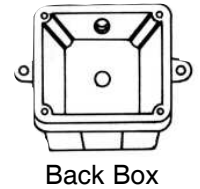
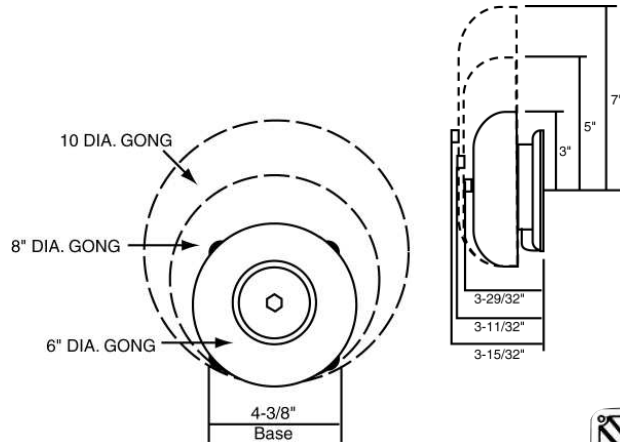

RATING VOLTAGE	6" GONG SIZE		8" GONG SIZE		10" GONG SIZE	
	Rated Current	Sound Level at 1 Meter	Rated Current	Sound Level at 1 Meter	Rated Current	Sound Level at 1 Meter
6VDC	250mA	95dB	250mA	95dB	250mA	95dB
12VDC	180mA	95dB	180mA	95dB	180mA	96dB
24VDC	100mA	95dB	100mA	95dB	100mA	96dB
120VAC	25mA	95dB	25mA	95dB	25mA	98dB
220VAC	20mA	95dB	20mA	95db	20mA	97dB

65-15-100	10" (120 V AC)
65-15-103	8" (120 V AC)
65-15-105	6" (120 V AC)
65-15-110	10" (24 V DC)
65-15-112	6" (24 V DC)
65-15-120	back box

## 8-B FIRE ALARM BELL ACCESSORIES

### FIRE ALARM BELL SIGNS



.020 Aluminum  
Red Aluminum with White Copy

6" Round  
(50-10-172)



9" x 7"  
(50-10-171)

### FIRE ALARM BELL PROTECTORS



Heavy wire construction  
One size fits 6", 8" and 10" Bells

45-30-200 - Red  
45-20-205 - Chrome

## 8-C WHEELOCK® HORNS AND STROBES

### Series MT Multitone Appliances



MT4 115 VAC  
Strobe/Horn

- 8 Field selective alarm tones
- Up to 100 dBA at 40 mA
- High or standard sound output selection
- 12, 24, VDC and 115 VAC models

wheelock, INC.

Approvals include ADA/UL 1971/ NFPA Applications, FCC Part 15, European Community (CE), New York (MEA), California State Fire Marshal (CSFM), Chicago (BFP) and Pending: (FM) on all models. Variety of candela ratings including 15, 15/75, 30, 75, 100, 110, and 117cd



MT 115 R Horn



Weatherproof Back Box

Part #	Model	Input Voltage	Rated Candela	Ave. Strobe Current
65-16-124	MT-24-SLM-VFR Strobe/Horn	24	15/75	.138
65-15-126	MT4-115R Horn Only	--	--	---
65-15-125	MT4-115-WH-VFR	115 VAC	15	.060

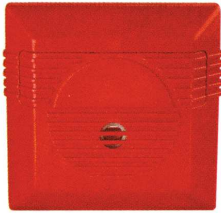
**ALARM PRODUCTS**
**9-A WHEELOCK® HORNS, STROBES & CHIMES**
**Series NS/NH Horn Strobe Appliances**

NH (65-16-100)



NS/NS4 (65-16-100)

- Low Current
- Zero Inrush
- 2 Selectable tones and dB levels
- Continuous Code 3
- Universal Mounting Plate
- 15 Strobe Candela

- 2 versions available:
  - 2-wire for both horn & strobe
  - 4-wire model
- Non-Sync or Sync, in one Product.
- NH (horn only) with all Service NS horn options
- 12 volt and 24 volt available
- Available in Red or White

wheelock, inc.

**Series AS Audible Strobe Signals & AH Audible Appliances**

AS Strobe (65-16-110)



AH-WP (65-16-123)

- 2-wire for both audible and strobe
- Low Current
- Zero Inrush
- Continuous or Temporal Code 3 (selectable)
- 3 selectable dBA levels
- 15/75 Strobe Candela

- Non Sync or Sync, in one product. (Synchronization requires SM or DSM module)
- Universal Mounting Plate
- AH (audible only) with all Series AS audible options.
- 12 volt and 24 volt available

wheelock, inc.

**RS Wall Strobe**

RSS-241575W-FR (65-16-140)

- Low Current Draw-reduces power consumption and wiring costs
- Patented Mounting Plate for single gang, double gang, 4" square, or backbox for surface mounting
- 24 volt input
- 15/75 Strobe Candela
- .065 average current

**MIZ Mini Horn**

MIZ-24-W

- High Sound Output
- Low Current Draw
- Easy installation
- 24 volt input
- .065 average current

(65-16-130)

**CH Chime/Strobe**

CH70 Chime Strobe

- High Sound Output
- Low Current Draw
- Easy installation
- 115 VAC volt input
- 15 Strobe Candela
- .060 average current

(65-16-150)

**Approvals** include ADA/UL 1971/NFPA Applications, FCC Part 15, European Community (CE), New York (MEA), California State Fire Marshal (CSFM), Chicago (BFP) and Pending: (FM) on all models, except CH70.

Variety of candela ratings including 15, 15/75, 30, 75, 100, 110, and 117cd

**9-B Sync Modules**

- Synchronization temporal sound pattern (with series AS/AH and Series NS/NH)
- Synchronized strobe flash (with Series AS, NS, SL, SLM, and all Series RSS strobes)
- Compatible with all standard fire alarm control panels

(65-16-160)

Model	Input Voltage	Ave. Current @12 or 24 VDC
SM-12/24-R	12	.014
	24	.025
DSM-12/24-R	12	.020
	24	.038

**9-C PowerPath Notification Appliance Circuit**

- Power Limited Outputs-switch selectable for 12 or 24 VDC
- Compatible with 12 or 24 VDC Control Panels and either Class A or Class B NAC circuits
- Provides 6 AMPS of continuous current

(65-16-170)

**Input Voltage/Current**

<b>PS-12/24-6</b>	120 VAC, 60 Hz; 2.15 amps
Output NAC Circuits	<b>Output Voltage/Current</b>
Four (4) Class "B" or	12/24 VDC @2 amps per circuit
Two (2) Class "A"	6 amps maximum available
<b>Standby Time</b>	<b>Input NAC Circuits</b>
24 hours with up to 5 minutes @ 6 amps of alarm	2
or	
60 hours with up to 5 minutes @ 6 amps of alarm	
<b>Standby Current</b>	<b>Maximum Loop Resistance</b>
62mA	100 OHMS

**9-D VoiceLink System**
**Audio and Fire Evacuation**

- Multi-Message record and playback systems
- Fire/Security/Public Address/Applications
- Custom Made

# FIRE SPRINKLER SPECIALTIES

## 10-A SPARE HEADBOXES



**3 Head Box**

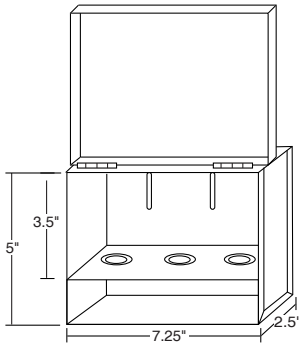

(65-10-152)

**12 Head Box**

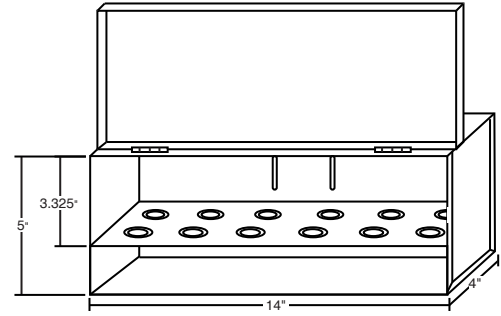

(65-10-150)

**6 Head Box**

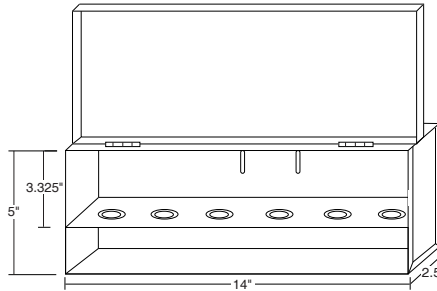

(65-10-151)

**6 Large Head Box**

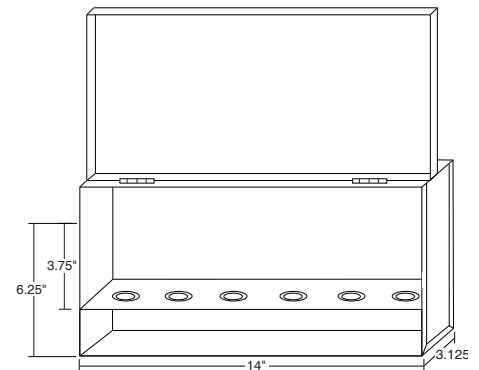

(65-10-151A)

All boxes are made out of heavy gauge steel

Knockouts and shelf to accommodate any 1/2" or 3/4" heads

All-welded construction and full length hinge

Powder coated red enamel

Slotted for easy mounting with screws, rivets or strapping.

## GAUGES

### 10-B 4" Fire Sprinkler Pressure Gauges



- 65-10-161: 0-300 PSI water
- 65-10-163: 0-300 PSI air
- 65-10-160: 0-300 PSI air/water
- 65-10-162: 0-80-250 PSI air w/retard
- 65-10-179: 0-600 PSI water
- 65-10-180: 0-300 psi glycerine filled (2-1/2") NON-UL

**personalization available in quantities of 100 or more**

Available with Plastic Back or Steel Back.

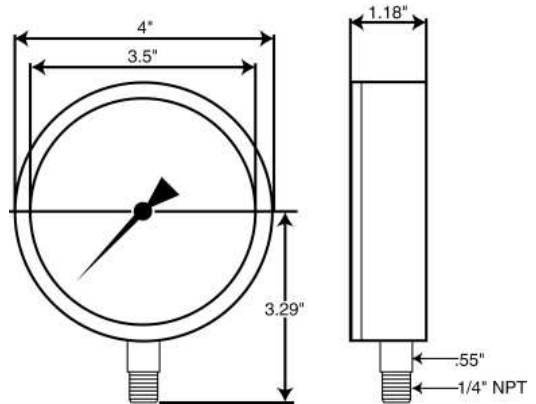

Fire Sprinkler Gauge Kit: Includes 1/4" 3 way valve, 1/4" x 4" nipple and 1/4" plug

### 10-C 2" Pressure Gauges



- 65-10-185: 100 psi
- 65-10-186: 200 psi
- 65-10-187: 300 psi

Available with Plastic Back

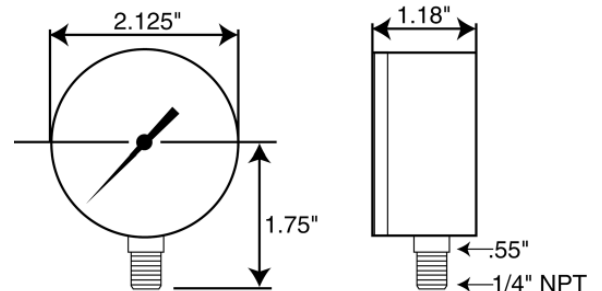



# ARGCO



## SPRINKLER IDENTIFICATION SIGNS

### 11-A 6"x 2" ALUMINUM SPRINKLER IDENTIFICATION SIGNS

All signs .020 Aluminum - Available as generic signs or personalized

<b>AIR CONTROL</b> 50-10-010	<b>COMBINATION STANDPIPE</b> 50-10-088	<b>FIRE DEPARTMENT CONNECTION</b> 50-10-189	<b>IN THIS BUILDING</b> 50-10-250	<b>OPEN SPRINKLER CONTROL</b> 50-10-300	<b>TEST &amp; DRAIN</b> 50-10-355
<b>AIR LINE</b> 50-10-020	<b>CONTROL VALVE</b> 50-10-100	<b>FIRE SPRINKLER ALARM</b> 50-10-220	<b>IN THIS SECTION</b> 50-10-260	<b>OPEN SPRINKLER DRAIN</b> 50-10-310	<b>TEST VALVE</b> 50-10-380
<b>ALARM LINE</b> 50-10-030	<b>DO NOT CLOSE</b> 50-10-129	<b>FIRE SPRINKLER PIPE</b> 50-10-221	<b>LOW POINT DRAIN</b> 50-10-275	<b>OPEN VALVE</b> 50-10-312	<b>WATER MOTOR LINE</b> 50-10-390
<b>ALARM TEST</b> 50-10-040	<b>DRAIN</b> 50-10-130	<b>FIRE SPRINKLER CONTROL VALVE</b> 50-10-224	<b>MAIN CONTROL</b> 50-10-280	<b>SPRINKLER</b> 50-10-317	<b>WET STANDPIPE</b> 50-10-400
<b>ANTI-FREEZE SYSTEM</b> 50-10-045	<b>DRAIN VALVE</b> 50-10-140	<b>FIRE SPRINKLER VALVE</b> 50-10-225	<b>MAIN DRAIN</b> 50-10-290	<b>SPRINKLER VALVE ROOM</b> 50-10-340	<b>WET STANDPIPE SHUTOFF</b> 50-10-420
<b>AUTOMATIC SPRINKLER SHUTOFF</b> 50-10-050	<b>DRY STANDPIPE</b> 50-10-150	<b>FIRE SPRINKLER RISER INSIDE</b> 50-10-228	<b>NORMALLY CLOSED</b> 50-10-293	<b>STANDPIPE SYSTEM</b> 50-10-350	
<b>AUXILIARY DRAIN</b> 50-10-070	<b>ENTIRE SYSTEM</b> 50-10-160	<b>INSPECTORS TEST</b> 50-10-270	<b>OPEN SPRINKLER</b> 50-10-297		

.020 Aluminum • Holes drilled in corners • Zinc Plated Sign Chain Available

### 11-B IDENTIFICATION DECALS

White Vinyl Decals with Bright Red Print • Available as generic signs or personalized

<b>AIR CONTROL</b> 50-20-010	<b>ANTI-FREEZE SYSTEM</b> 50-20-045	<b>FIRE EXTINGUISHER</b> 50-20-200	<b>INSPECTORS TEST</b> 50-20-270	<b>TEST &amp; DRAIN</b> 50-20-355
<b>AIR LINE</b> 50-20-020	<b>AUXILIARY DRAIN</b> 50-20-070	<b>FIRE DEPARTMENT VALVE</b> 50-20-201	<b>MAIN CONTROL</b> 50-20-280	<b>WATER MOTOR LINE</b> 50-20-390
<b>ALARM LINE</b> 50-20-030	<b>CONTROL VALVE</b> 50-20-100	<b>FIRE HOSE</b> 50-20-205	<b>MAIN DRAIN</b> 50-20-290	<b>SPRINKLER</b> ← 50-20-541
<b>ALARM TEST</b> 50-20-040	<b>DRAIN VALVE</b> 50-20-140	<b>FIRE SPRINKLER PIPE</b> 50-20-221	<b>OPEN SPRINKLER CONTROL</b> 50-20-300	<b>SPRINKLER</b> → 50-20-542
	<b>FIRE PROTECTION</b> 8" x 2" 50-20-219		<b>SPRINKLER</b> 50-20-317	<b>SPRINKLER</b> → 50-20-410

### 11-C 6"x 4" ALUMINUM SPRINKLER IDENTIFICATION SIGNS

	<b>COMBINATION STANDPIPE SHUTOFF</b> 50-10-090	<b>FIRE DEPARTMENT CONNECTION</b> 50-10-190	<b>FIRE DEPARTMENT CONNECTION AUTOMATIC SPRINKLER</b> 50-10-191	<b>FIRE DEPARTMENT CONNECTION (STANDPIPE)</b> 50-10-215	<b>WET STANDPIPE SHUT-OFF</b> 50-10-410	<b>WET STANDPIPE CONTROL</b> 50-10-411
--	---	--	--	--	--	---

800-720-2746

www.argco.com

FAX 760-631-2287

# SPRINKLER IDENTIFICATION SIGNS

## 12-A 5" x 7" HYDRAULIC SYSTEM SIGNS

Bright Red Background with White Copy and Boxes  
Available in Three different styles:

- .020 Aluminum with holes drilled in corners (50-10-240)
- Vinyl with adhesive back (50-20-240)
- Embossible silver foil with adhesive back (50-30-240)

Also available with custom personalization.

**HYDRAULIC-SYSTEM**

This building is protected by a Hydraulically Designed Automatic Sprinkler System

Location

No. of Sprinklers

Basis of Design

1. DENSITY  GPM/SQ.FT.

2. DESIGNED AREA OF DISCHARGE  SQ.FT.

System Demand

1. GPM DISCHARGE  GPM

2. RESIDUAL PRESSURE AT THE BASE OF THE RISER  PSI

generic

**HYDRAULIC-SYSTEM**

This building is protected by a Hydraulically Designed Automatic Sprinkler System

Location

No. of Sprinklers

Basis of Design

1. DENSITY  GPM/SQ.FT.

2. DESIGNED AREA OF DISCHARGE  SQ.FT.

System Demand

1. GPM DISCHARGE  GPM

2. RESIDUAL PRESSURE AT THE BASE OF THE RISER  PSI

**tyco** Fire & Security **Grinnell Fire Protection**

personalized

## 12-B 9" x 7" ALUMINUM SPRINKLER IDENTIFICATION SIGNS



50-10-120



50-10-171



50-10-351



50-10-322

Zinc-Plated Sign Chain  
100 ft. box  
(50-99-100)



## 12-C MISCELLANEOUS ALUMINUM SPRINKLER SIGNS



8" x 3" 5010214



8" x 3" 5010227



8" x 3" 5010081

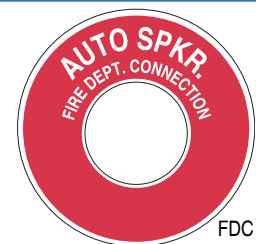

FDC Wallplate  
cast aluminum: 6510330  
plastic: 6510340



12" x 6" 50-10-329



12" x 6" 5010061



6" Round  
Aluminum Bell Sign  
5010172



Cast Aluminum 8" x 4" 50-10-195



12" x 4" 5010217



24" x 12" 5010342



# ARGCO



## SPRINKLER IDENTIFICATION SIGNS CONT.

### 13-A 12"x 10" ALUMINUM SPRINKLER ID SIGNS

<p><b>AUTOMATIC SPRINKLER IN GARAGE ONLY</b></p>	<p><b>AUTOMATIC SPRINKLER IN BASEMENT ONLY</b></p>	<p><b>AUTOMATIC SPRINKLER SHUT-OFF VALVE LOCATED ___ FT. OPPOSITE THIS SIGN</b></p>	<p><b>AUTOMATIC SPRINKLER SHUT-OFF</b></p>
50-10-046	50-10-047	50-10-048	50-10-060
<p><b>SIAMESE CONNECTION FOR FIRE DEPT.</b></p>	<p><b>SPRINKLER CONTROL VALVE</b></p>	<p><b>SPRINKLER FIRE ALARM</b></p>	<p><b>SPRINKLERS THROUGHOUT BUILDING</b></p>
50-10-315	50-10-323	50-10-331	50-10-333
<p><b>STANDPIPE</b></p>	<p><b>STANDPIPE SHUT-OFF</b></p>		
50-10-345	50-10-360		

## IDENTIFICATION SIGNS • SERVICE DECALS • INSPECTION TAGS

### 13-B INSPECTION TAGS & DECALS

All tags and decals available Generic or Personally customized with your company's name, logo, address and phone

- White Vinyl Decals with Bright Red Copy
- Card stock with choice of paper color and ink color

5 Yr. Tag  
(50-40-270)

**INSPECTION TAG!**  
DO NOT REMOVE!  
BY ORDER OF:  
THE STATE FIRE MARSHAL

1	2	3	4	5	6	7	8	9	10	11	12	13	14	15	16	17	18	19	20	21	22	23	24	25	26	27	28	29	30	31	32	33	34	35	36	37	38	39	40	41	42	43	44	45	46	47	48	49	50
---	---	---	---	---	---	---	---	---	----	----	----	----	----	----	----	----	----	----	----	----	----	----	----	----	----	----	----	----	----	----	----	----	----	----	----	----	----	----	----	----	----	----	----	----	----	----	----	----	----

Signature \_\_\_\_\_

Two sizes:  
5-1/2" x 2-5/8"  
and  
6-1/4" x 3-1/8"

Quarterly  
Tag  
(50-40-271)

**INSPECTION TAG**

WET SYSTEM <input type="checkbox"/>	DELUGE VALVE <input type="checkbox"/>
DRY SYSTEM <input type="checkbox"/>	ANTI-FREEZE <input type="checkbox"/>
	PRE-ACTION VALVE <input type="checkbox"/>
VALVE SERIAL NO. _____	
STATIC WATER PSI _____	
RESIDUAL WATER PSI _____	
DO ALARMS OPERATE _____	
AIR PRESSURE _____	
TRIP TIME (SEC) _____	
WATER FLOW TIME (SEC) _____	
LOW POINTS DRAINED _____	
WATER SUPPLY OPEN _____	
ANTI-FREEZE TEMP. RATING _____	
NUMBER OF LOW POINTS TO BE DRAINED _____	
INSPECTION MADE AND WITNESSED BY _____	
DATE & M.P.# _____	MADE BY _____
	WITNESSED BY _____

7-3/4" x 3-3/4"

**DO NOT REMOVE  
YEARLY and MONTHLY  
INSPECTION TAG**

\_\_\_\_\_ does not assume any responsibility for failure to operate as such; failures may be due to causes beyond our control such as malicious tampering and/or clerical failure to perform required modifications/inadequate heat for wet systems, etc.

The sprinkler system has been placed back into service with the control valves in operational condition by \_\_\_\_\_ and hence forth the owner is responsible for further "care and maintenance" as described in NFPA 13A and NFPA 25.

back side

6-1/4" x 3-1/4"

**DO NOT REMOVE!**  
BY ORDER OF:  
THE STATE FIRE MARSHAL

<input type="checkbox"/> Sprinkler System	<input type="checkbox"/> Storage Tanks
<input type="checkbox"/> Standpipe & Hose	<input type="checkbox"/> Spray System
<input type="checkbox"/> Fire Main	<input type="checkbox"/> Foam/Water System
<input type="checkbox"/> Fire Pump	<input type="checkbox"/> Valves & Fiac Dept. Connection

WORK PERFORMED BY: \_\_\_\_\_

NAME: (print) \_\_\_\_\_

SIGNATURE \_\_\_\_\_

DATE: \_\_\_\_\_

INSPECTOR LISTING# \_\_\_\_\_

QUARTERLY  ANNUAL  3 YEAR  5 YEAR

NEW SYSTEM  REPAIR/REPLACE  MAINTENANCE

For more information see the inspection report.

Florida Tag  
(50-41-275)

# PERSONALIZED SIGNS & DECALS



## A Great Way to Advertise Right on the Jobsite

Put your Company Name & Logo on your ID signs, Service Decals, Inspection Tags, Bell signs, FDC Wallplates, Gauges, even on your Ball Valve handles!

ARGCO's art department can take your personalized artwork and recreate it on your signs - Custom to your specs.

**Aluminum Signs:**  
Powder coated .040 Aluminum  
6" x 2" ID signs  
5" x 7" HydraCalc,  
9" x 7" Fire Alarm, Valve signs  
...and much more!

**Decals:**  
Vinyl Decals with several sizes and your choice of colors

**Inspection Tags:**  
Print on both sides, your choice of color

**Fire Alarm Bell Signs**  
Your Company Logo, Name and phone number right on the bell sign.

...And Much, Much More!



## SPRINKLER STOP™

Protect your building from fire and water damage.

Shut off accidentally activated sprinkler heads before fire crews arrive without shutting down system... protecting the rest of your building!

- Stop the flow of water without shutting down the entire system.
- Designed to fit recessed and pendant style fire sprinklers...including residential heads!
- ESFR head adapter available.
- Beveled rubber stopper completely stops water flow from sprinkler head orifice
- Easily fits into spare sprinkler head box.
- 6-3/4" long & weighs 10 ounces.

Lock into place...



...rotate handle until beveled rubber stopper seals sprinkler orifice



## piringtools

Along with this great line of Fire Sprinkler Specialties, ARGCO has it's own line of PT® Piping Tools and Replacement parts.

- Pipe Wrenches
- Roll Groovers
- Pipe Cutting Tools
- Pipe Stands
- Holesaws
- Press-Fitting Tools
- Threading Dies
- Saws, Bits, Blades
- Hydrostatic Test Pumps
- Hole Drilling Tools
- Shop Supplies
- Piping Chemicals

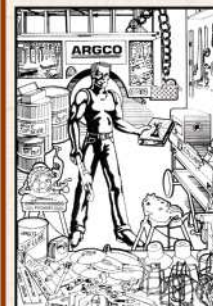

Call for your free Pipingtools® catalog, or log onto pipingtools.com for details



800-854-1015

www.argco.com

FAX 760-727-3270

# argco.com

## Easy on-line shopping 24 hours a day

ARGCO - Microsoft Internet Explorer

File Edit View Favorites Tools Help

Back Forward Stop Home Search Favorites



Address http://www.argco.com/cgi-bin/item/index.html

# ARGCO

Log-in and purchase any ARGCO item with our secured shopping cart

Maintain your account, Track an order

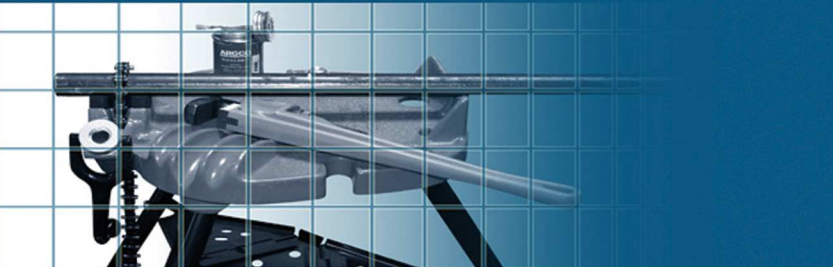
HOME | LOGIN | YOUR CART | CHECK OUT | SERVICE | ABOUT US



EXPLORE ARGCO	REFERENCE
Fire Sprinkler Specialties	Piping Tools
Fire Equipment	Boiler Specialties
Valves	Plumbing Specialties
Piping Chemicals	Shop Supplies
Hangers & Fasteners	ARGCO Specials
	Tech Data
	MSDS
	Credit Application
	View Catalogs

Get technical information or product MSDS

Download a catalog



### hangers & fasteners



### piping chemicals



### gasket & boiler specialties



### valves

### fire equipment

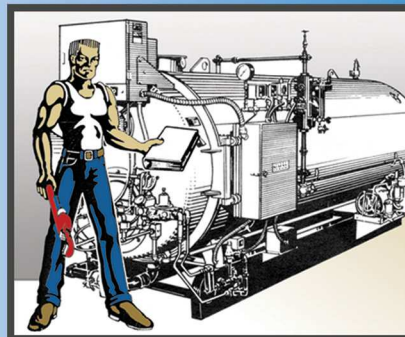

### piping tools

800-854-1015



www.argco.com