

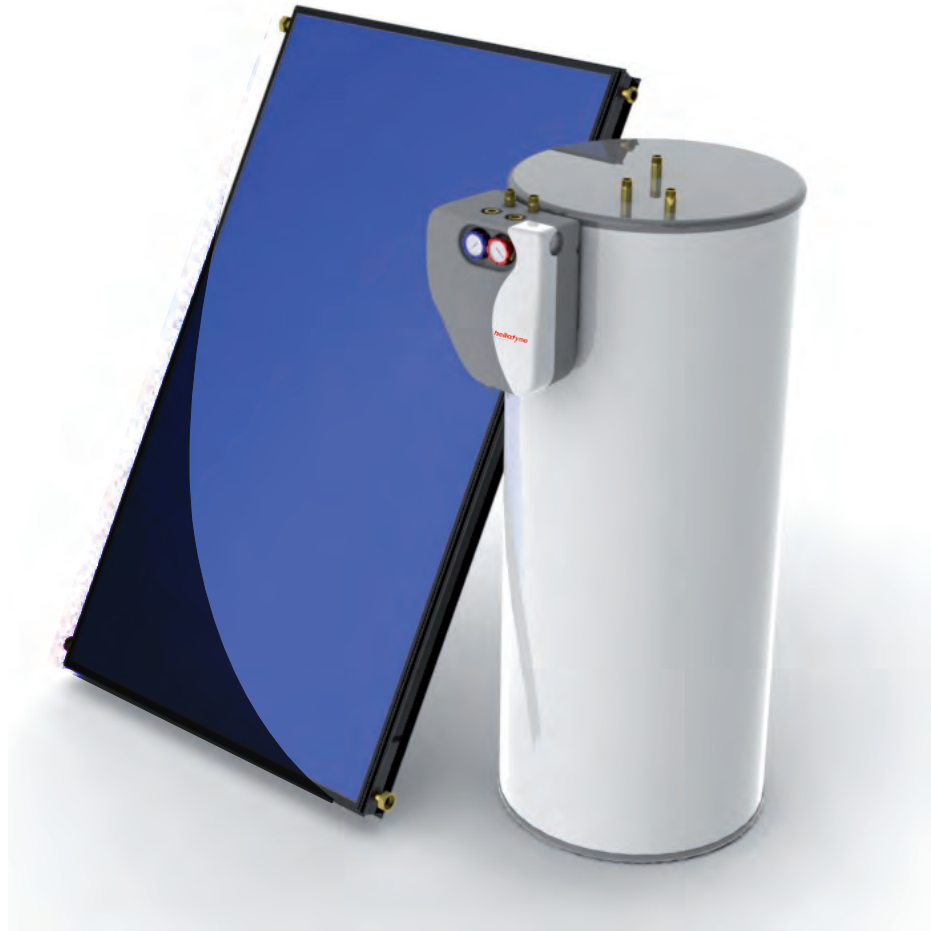



INSTALLATION GUIDE

HPAS SYSTEMS

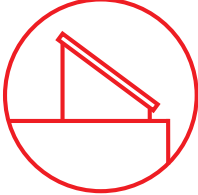
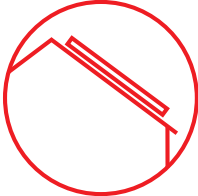

REV 2.0

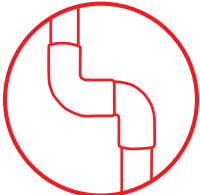
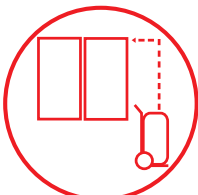
EXCELLENCE
BY DESIGN

1. PREPARATIONS	3-9
2. GOBI INSTALLATION	
	10-11
	12-13
3. HPAS INSTALLATION	
	14-15
4. PIPING	
	16-18
5. COMMISSIONING	
	19-20
6. O & M	
	21

1. PREPARATIONS

1.0. For service, contact Heliodyne: (888)878-8750

1.0.0. Safety Guidelines

Carefully review all instructions in this manual for installation and use. Do not modify Gobi Collectors or HPAS under any circumstances; use only as designed. Install all components in an accessible location for servicing and maintenance. This manual and its content are integral parts of both the HPAS and Gobi Solar Collector warranties. Noncompliance with these guidelines will void all warranties.

Follow all local building codes and regulations, as well as these industry accepted guidelines and standards:

BUILDING	USEC, UBC, UPC, NRCA
ASHRAE	Solar Energy Equipment
NFPA 70	National Electric Code
ASCE 7-05	Minimum Design Loads for Buildings & Other Structures

1.0.1. Collector Storage and Handling

Keep collectors covered when storing.

Avoid lifting collectors by the headers. Take care not to scratch the tempered solar glass; follow the glass breakage guidelines at the end of this manual in case of breakage.

Gobi collectors nest and lock into each other for horizontal transportation. Do not transport Gobi upside down or standing on a side.

1.0.2. Collector Installation

Make a site visit prior to installation to verify adequate installation conditions:

- Collector sun exposure, especially during crucial solar hours of 10AM – 2PM. Take into consideration deciduous tree shading, structures, chimneys, etc.
- Use a minimum tilt of 10° in mild areas and 30° in areas with snow.
- Orient collectors within 20° of true South (in North latitudes); use internet maps rather than compass readings for verification.
- Ideal collector tilt for hot water production is equal to site latitude. For space heating combination systems, use tilt equal to latitude plus 15°. Heliodyne recommends a standard of 35° for hot water and 45° for space heating, regardless of location. Use racks only when necessary, as variation up to 15° can have only small effects on performance.
- For tank integrated tank heat exchanger systems, avoid banking of snow and ice below or on the collectors.
- Never mount Gobi collectors horizontally in a drainback system.
- Heliodyne recommends 6-12" of flex tubing before any rigid copper lines to allow for thermal expansion in the copper tubing.

1.0.3. Minimum Heat Storage and Backup Capacity

A minimum of 1.5 – 2.0 gallons of liquid heat storage per square foot of Gobi collector (e.g., 60 – 80 gallons per Gobi 410) is recommended.

Minimize stagnation (no load, no flow) conditions on peak output days by using appropriate system sizing and maximizing year round usage. For design assistance, contact Heliodyne.

Ensure the backup heating capacity is properly sized to produce hot water for installation site on days of little or no solar energy production. Use only ASHRAE 90.2 compliant storage tanks and heaters with R-16 or higher.

1.0.4. Equipment for Installation

For a complete and functional SHW system, ensure the following equipment is ready for installation at the job site:

- OG-100 Certified Gobi Solar Collectors
- HPAS Heat Transfer Appliance (HPAS)
- Rack or Flush mount hardware kit
- Appropriate roof penetration hardware and sealant
- Copper tubing and supports, type M or L for collector / heat transfer appliance connections, adapters, elbows and fittings.

- 96/4 Tin/Silver solder
- Non-foam based, closed cell insulation (Armaflex); R2.6 minimum
- UV resistant covering or coating for outdoor exposed insulation
- Isolation valves, tempering valve, air vent
- Storage tank with adequate volume for collectors installed
- Connections for storage tank (flexible or otherwise)
- FOR INTEGRATED TANK HEAT EXCHANGER SYSTEMS:
 - Dyn-O-Flo HD high temperature propylene glycol or equal
 - Properly sized expansion tank with at least 17% of system fluid volume in acceptance volume
 - Filling valves and filling pump system

1.0.5. Tools

Heliodyne collectors and heat transfer appliances do not require any special tools. Never use plumbing wrenches on hex connections. Always tighten the bolts rather than the nuts. Aside from using the standard plumbing tools (torch, pipe cutter, etc.) the following tools and sizes are used in Heliodyne equipment:

- 9/16" wrench / socket for 3/8" - 16 bolts and nuts
- 3/4" wrench / socket for 1/2" - 13 hanger bolts and nuts
- Adjustable hex wrench for 1.25" thru 1.875" hex sizes
- Phillips screw driver (for tank sensor installation)
- 1/4" drill bit for 3/8" lag screws
- 3/8" drill bit for 1/2" lag screws

1.0.6. Safety & Equipment

Working on roof tops and other elevated collector installation sites as well as using flames can be dangerous; use extreme caution and follow all local codes and good safety practices when installing. Heliodyne is not responsible for job safety nor any accidents that may occur, and always recommends:

- Safety glasses
- Roof harness
- Scaffolding rather than ladders
- Solder in well ventilated areas

1.0.7. OG-300 & FSEC Certified Systems

Installers: check box next to system installed (if applicable)

AC SYSTEMS		SRCC
<input type="checkbox"/>	HPAS 1 406 G 65 AC S Z	2010137A
<input type="checkbox"/>	HPAS 1 406 G 75 AC S Z	2010137B
<input type="checkbox"/>	HPAS 1 408 G 65 AC S Z	2010137C
<input type="checkbox"/>	HPAS 1 408 G 75 AC S Z	2010137D
<input type="checkbox"/>	HPAS 1 410 G 65 AC S Z	2010137E
<input type="checkbox"/>	HPAS 1 410 G 75 AC S Z	2010137F
<input type="checkbox"/>	HPAS 2 406 G 65 AC S Z	2010137G
<input type="checkbox"/>	HPAS 2 406 G 75 AC S Z	2010137H
<input type="checkbox"/>	HPAS 2 408 G 65 AC S Z	2010137I
<input type="checkbox"/>	HPAS 2 408 G 75 AC S Z	2010137J
<input type="checkbox"/>	HPAS 1 406 G 55 AC D Z	2010138A
<input type="checkbox"/>	HPAS 1 406 G 75 AC D Z	2010138B
<input type="checkbox"/>	HPAS 1 408 G 55 AC D Z	2010138C
<input type="checkbox"/>	HPAS 1 408 G 75 AC D Z	2010138D
<input type="checkbox"/>	HPAS 1 410 G 55 AC D Z	2010138E
<input type="checkbox"/>	HPAS 1 410 G 75 AC D Z	2010138F
<input type="checkbox"/>	HPAS 2 406 G 75 AC D Z	2010138G
<input type="checkbox"/>	HPAS 2 406 G 110 AC D Z	2010138H
<input type="checkbox"/>	HPAS 2 408 G 75 AC D Z	2010138I
<input type="checkbox"/>	HPAS 2 408 G 110 AC D Z	2010138J

The solar energy system described in this Manual, when properly installed and maintained, meets or exceeds the minimum standards established by the SRCC. This certification does not imply endorsement or warranty of this product by SRCC.

1.1. Technical Specifications for Gobi

DIM	DESCRIPTION	UNITS	GOBI 406	GOBI 408	GOBI 410	
L	Length	inch	81.56	97.56	121.56	
W	Width		47.56			
T	Thickness		2.75			
H	Header Length		76.88	92.88	116.88	
M	Header Width		50.25			
A	Aperture Length		79.25	95.25	119.25	
	Aperture Width		45.25			
P	Plate Length		78.0	94.0	118.0	
	Plate Width		46.25			
D	Flashing Base		0.61			
F	Flashing Header		1.93			
L x W	Gross Area		ft ²	26.94	32.22	40.15
A _L x A _W	Net Area		ft ²	24.90	29.93	37.47
g	Dry Weight	lb.	74	102	127	
G	Full Weight	lb.	80	108	135	
V	Volume	Gal.	0.6	0.7	0.8	
-	Max Pressure	PSI	150 (10 Bar)			
-	Test Pressure	PSI	300 (20 Bar)			
-	Stag. Temp.	°F	397.6 (203 °C)			

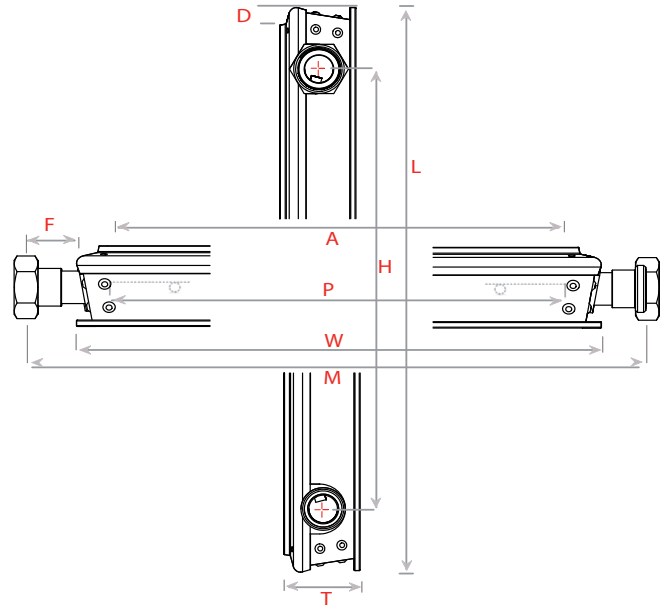

1.2. Flow and Pressure Loss¹

RECOMMENDED DESIGN FLOW RATES WITH GLYCOL ²		
GOBI 406	GOBI 408	GOBI 410
0.85 Gal / min	1.0 Gal / min	1.25 Gal / min

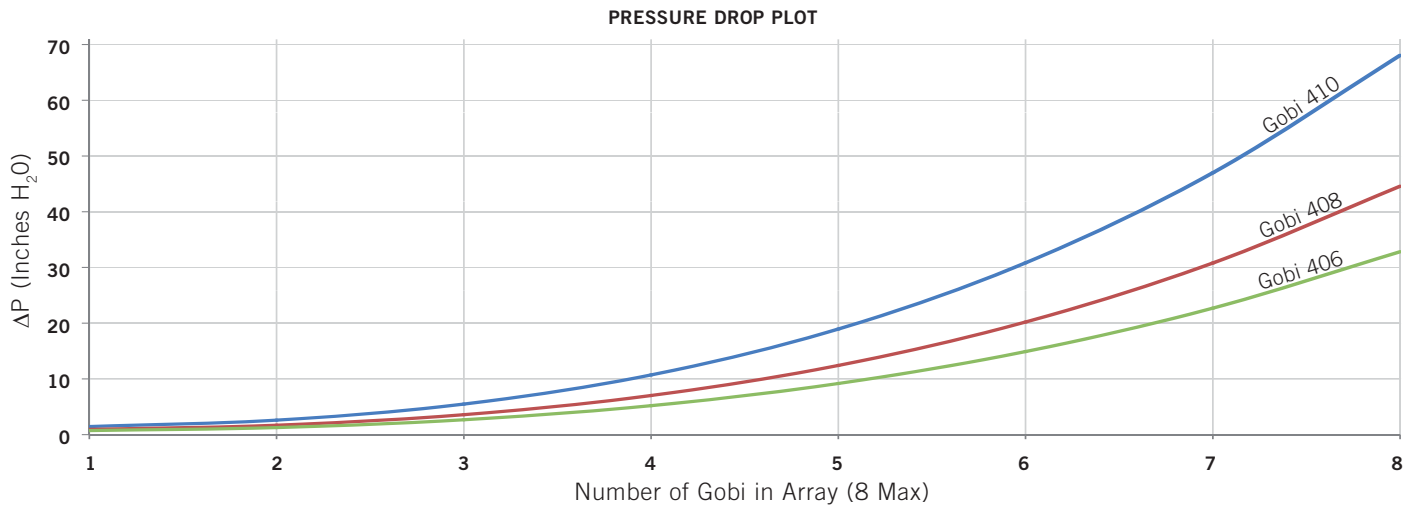

¹ Losses calculated at recommended Gobi design flow rates for 50/50 propylene glycol / water solution.

² Minimum flow rates shown. Do not exceed recommended flow rates by more than three (3) times.

1.3. Gobi Orientation and Plumbing
1.3.0. Tilt, Azimuth and Orientation

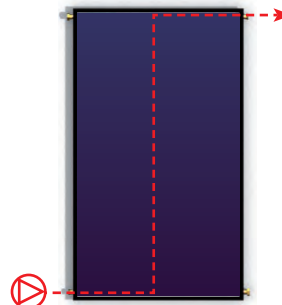
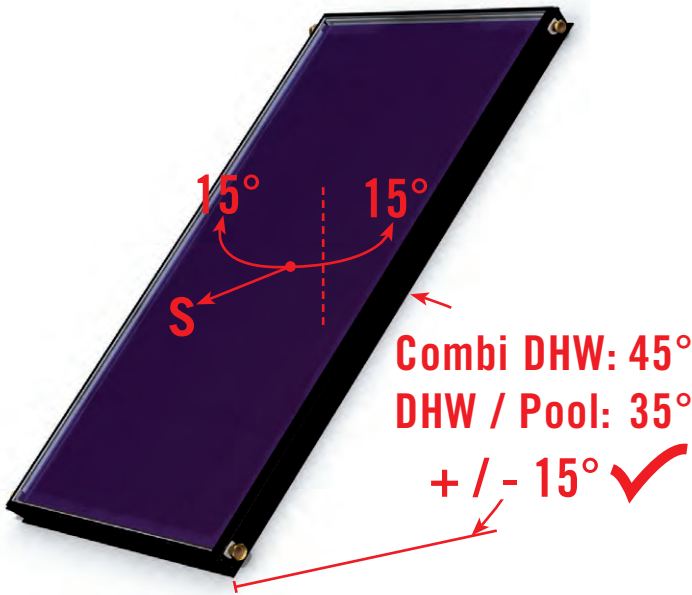

Helio-Pak ✓
HPAS ✓
Drain Back ✓

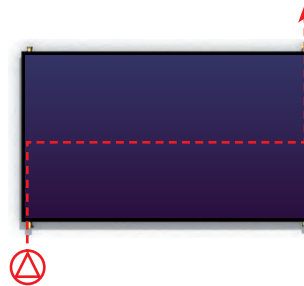

Helio-Pak ✓
HPAS ✓
Drain Back ✗

1.3.1. DOS-Disc Assembly & Requirements

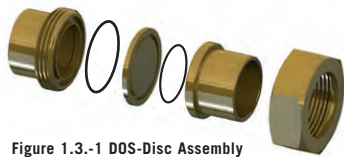

Figure 1.3.-1 DOS-Disc Assembly
 1".....50013
 3/4".....50014
 1/2".....50016

→ 2x



Figure 1.3.-2 Two DOS-Discs Per Vertical Array

OR



Figure 1.3.-3 Two DOS-Discs Per Horizontal Collector

1.3.2. Supply and Return Connections, Unused Connection Capping

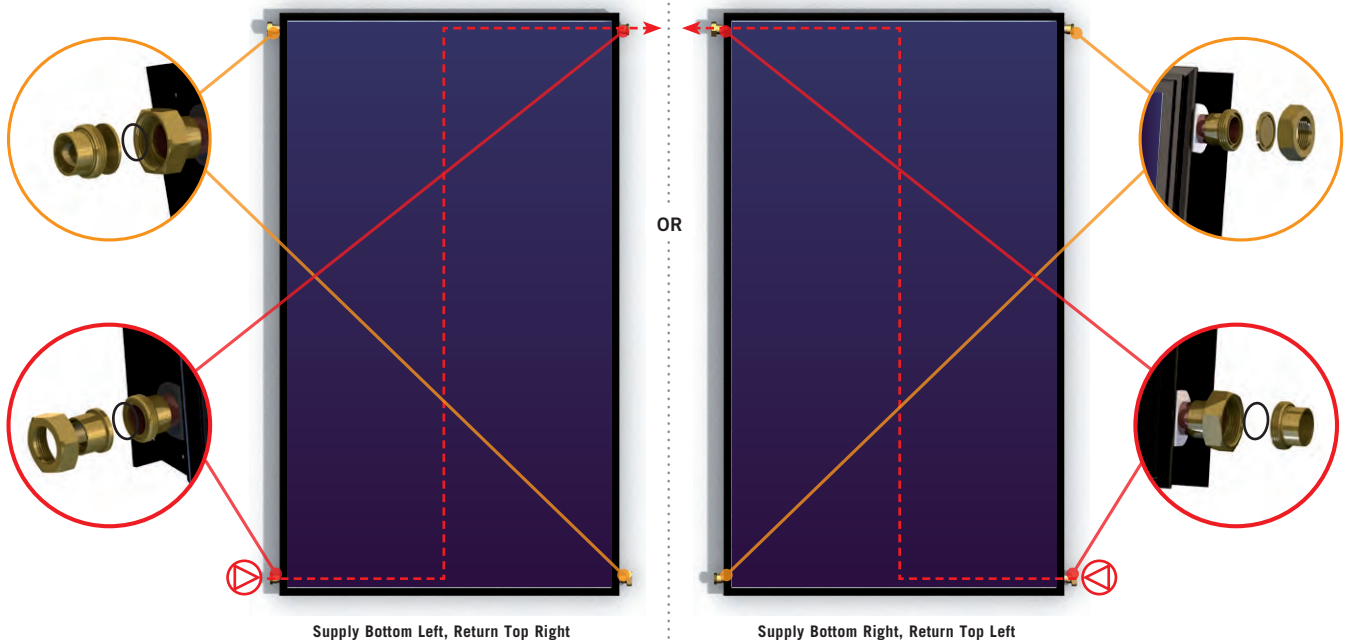

Supply Bottom Left, Return Top Right

Supply Bottom Right, Return Top Left

1.4. HPAS Heat Transfer Appliance

Insulated solar hot water system, for use with an integrated tank heat exchanger and propylene glycol / water, with prewired control and sensors, and hot / cold temperature and pressure indication. For indoor installation.

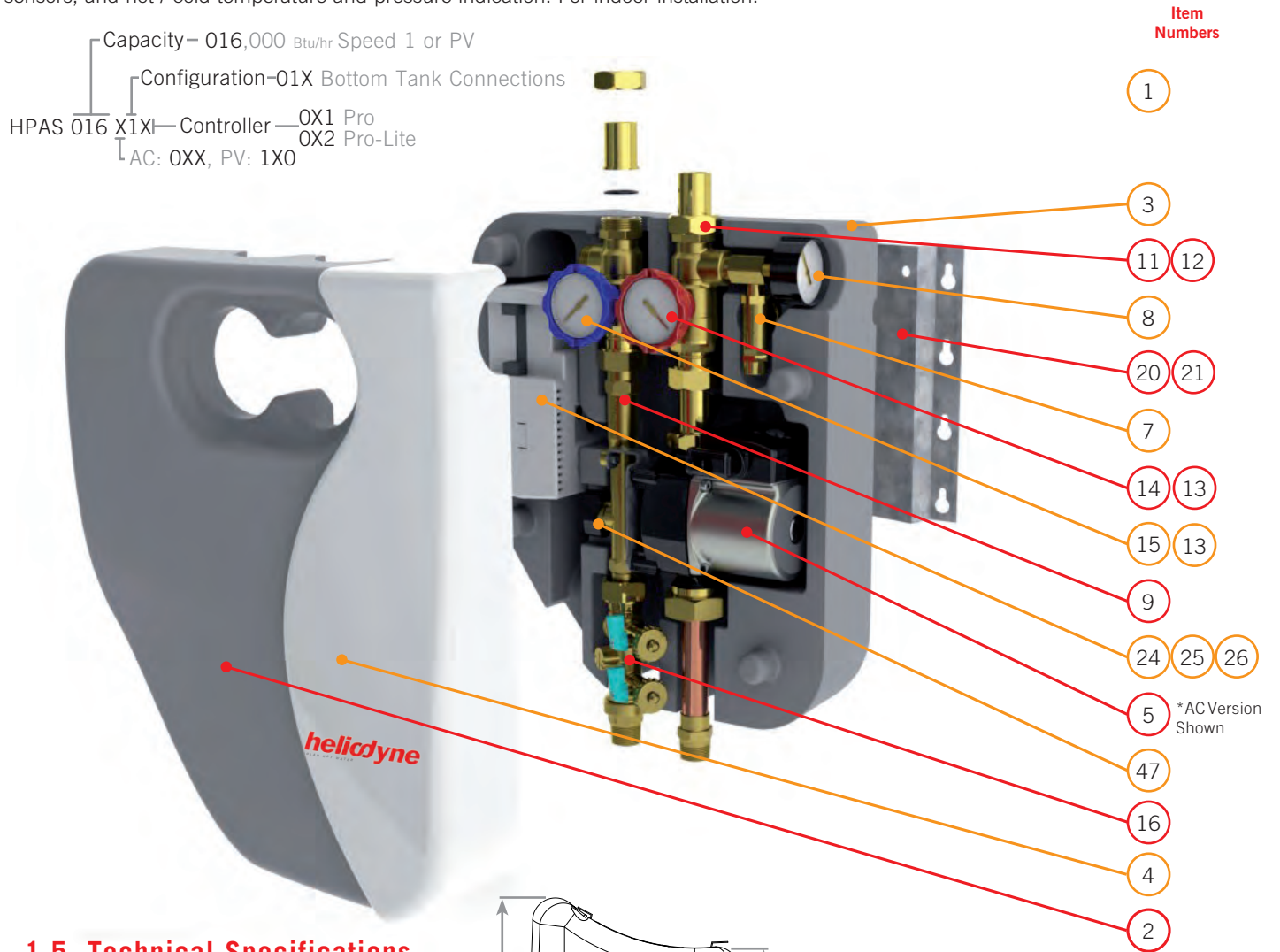

1.5. Technical Specifications

Maximum Operating Conditions	150 psig / 275 °F
Heat Transfer Fluid	Water (Open Loop) 40-50% Dyn-O-Flo HD and Water (Closed Loop)
Top Connections	3/4" (7/8" ID) Solder Connections to DOS O-Ring
Bottom HX Connections	3/4" Male NPT Fittings
Pressure Relief	Barbed Hose Connection (For 1/4" ID Hose)
Gaskets, O-Rings	EPDM / BUNA-N, VITON
Insulation	EPP Foam (Casing)
Thermal Conductivity	0.25 Btu-in / hr-ft ² -°F (0.036 W/m-K)

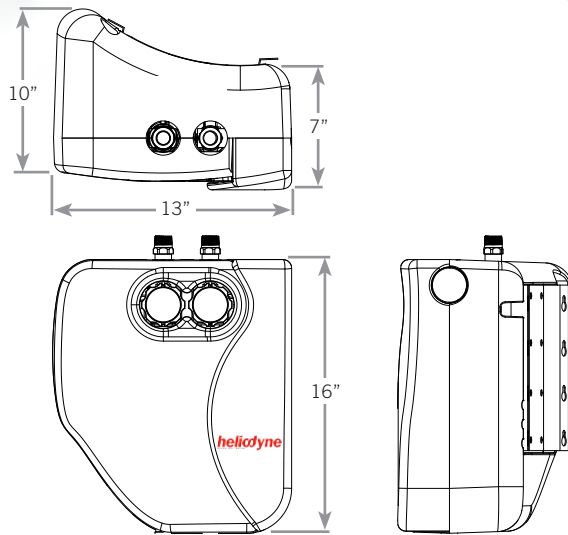

Figure 1B-1: HPAS Dimensions

1.6. HPAS Replacement Parts

1.6.0. HPAS Spare Parts Table (To purchase contact Heliodyne)

ITEM	CODE	PART NUMBER	DESCRIPTION	QUANTITY
1	HPAS 016 011 HPAS 016 012	51291 51290	HPAS heat transfer appliance with filling valve, bottom connections, and either Pro or Pro-Lite Controller	1
2	HPAS Foam Front	21435	Front insulation casing	1
3	HPAS Foam Back	21436	Back insulation casing	1
4	Acrylic Cover	21442	Front white acrylic cover with logo	1
5	AC: UPS 15-58 CiL2 PV: Laing DC-5	23098 23103	Composite volute circulation pump, 3-speed 20 Watt Photovoltaic driven pump	1
7	PRV	23001	150 psig, 1/4" NPT pressure only relief valve	1
8	PGauge	21214	Back entry pressure gauge, 0-160 psi	1
9	HPAS 2-40FloCast	21750	Bronze flow casting, with flow meter input	1
11	DOS Combo Nut ¹	21729	DOS System Nut for combo flange attachment	2
12	DOS Combo Flange ¹	21743	DOS System solder flange, 7/8" ID	2
and	DOS Combo O-Ring ¹		DOS System Combo Valve O-Ring	2
13	Combo Gasket	21186	EPDM gasket for combo valves	3
14	Combo Valve: Hot	23090	Hot combination valve: check, ball, temperature	1
15	Combo Valve: Cold	23091	Cold combination valve: check, ball, temperature	1
16	Combo Valve: Fill	23092	Filling valve	1
20	HPAS Bracket	21204	HPAS Bracket	1
21	X Mount	21453	Tank / Wall Mounting Bracket	
22	Mtg Screws	21194	1/4 - 20 x 1" Self-tapping screws for tank mount	4
24	Elec. Box - bot	21198	HPAS / HPAK electrical box - bottom	1
25	Elec. Box - top	21197	HPAS / HPAK electrical box - top	1
26	Delta- T	21153 21270	Delta - T Pro-Lite or Delta - T Pro	1
29	SENS 000 001	23029	10,000 Ohm Thermistor Sensors	2
47	Grundfos VFS 2-40	23086	Grundfos vortex flow and temperature sensor, standard	1
59	EX-2	23030	2 Gallon expansion tank for integrated heat exchanger systems	-
Optional Equipment (Not Included in HPAS Package)				
60	EX-2 Mount	23097	Expansion tank wall mounting bracket	-
61	ZZZZ 000 003	23020	Tempering valve, 3/4" sweat	1
62	AV700	23021	Air vent for filling, 1/2" Male NPT	1
63	SENS 000 002	23025	Sensor wire	-
64	DFLO 001 000	23040	Dyn-O-Flo HD propylene glycol concentrate	-
65	ZZZZ 000 005	23023	Tank bypass valve	1
66	ITLS 000 002	50064	Collector loop filling station	-
67	ITLS 000 001	50078	Propylene glycol test kit	-
68	DOS Tank Dielectric	50016	Brass DOS tank dielectric union with O-ring, 1"C x 3/4" NPT	1 / Nipple

¹The Compression Ring and Nut Combo Valve Versions are not compatible with the DOS System Combo Valves.

1.6.1. Tempering Valve

Install a tempering valve to prevent scalding; the solar storage can reach temperatures of 180°F or higher. Some areas may require a rated Anti-Scald valve.

61

For dual tank systems with a gas backup, install the tempering valve before the gas water heater and after installing the solar storage tank, to avoid a service call for high limit fuse replacement. For dual tank systems with an electric tank, the tempering valve may be installed before or after the tank. For instantaneous water heaters as backup, consult the manufacturer for the recommended method of tempering or bypass of solar heated water into the heater.

1.6.2. System Overheat Protection and Operation of Pressure Relief Valve

7

The HPAS comes with a preinstalled pressure only relief valve, nonadjustable and pre-set at 150 psig. A 1/4" barbed hose fitting is supplied for routing relief fluid to a drain or retaining vessel. THIS VALVE DOES NOT REPLACE A PROPERLY SIZED T&P VALVE ON EACH STORAGE TANK. Open loop systems have little stagnation protection, because of the street pressure operation. For best results, install a Delta-T Pro controller and operate vacation mode for long absent periods.

For integrated heat exchanger systems, an expansion tank is necessary; contact Heliodyne. The acceptance volume of the expansion tank should be large enough to store up to 17 – 20% of the total collector system fluid volume. With these safety precautions, and high temperature Dyn-O-Flo HD propylene glycol, the system can stagnate for short periods. If extended periods (2 weeks or more) are expected, install a Delta-T Pro with the proper vacation setting. Additionally, the system should never have less than 1.5 gallons of storage for each square foot of collector surface area.

1.6.3. Operation of Combo Valves

The combo valves are integrated check and ball valves, with temperature gauges. Check valves on both supply and return prevent reverse thermosiphoning. Cracking pressure (minimum fluid flow pressure) of the check valves is 0.30 psi. The valves can be operated by turning the plastic handles clockwise, with note taken of the position of the slots on the handles, indicating valve position as pictured in figures 1.6.3.-1 – 3 below. To ensure proper compression fitting seals, clean and round copper tubing must be used. Use a counter wrench on the hex provided to fully torque compression nut fittings. Bush up or down as necessary for proper flow rates.

14

15

During operation, the hot temperature gauge should read in the range of 10-20°F higher than the cold gauge, depending on system flow rate..

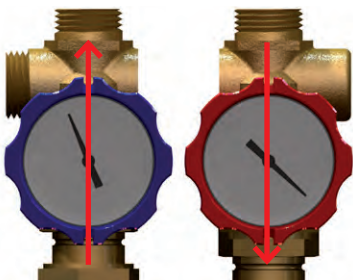

Figure 1.6.3.-1: Ball Valves Open (Operation Position)

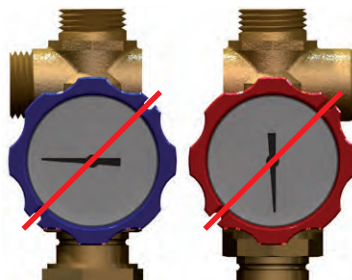

Figure 1.6.3.-2: Check Valves Open (Fluid Servicing)

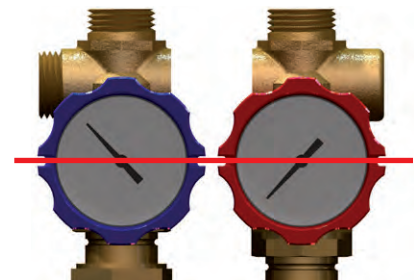

Figure 1.6.3.-3: Ball Valves Closed

1.6.4. Operation of Filling Valve

The filling valve integrates three gate valves into one. The green handles operate the inlet and outlet of the valve, while the drain fitting on the side enables either filling or system operation. Always fill the system in the direction of the flow path.

If not using a Heliodyne filling station, hose adapters are included with the kit.

16

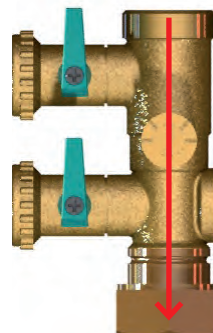

Figure 1.6.4.-1: Drain Fitting Open (Operation Position)

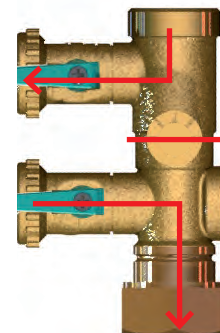

Figure 1.6.4.-2: Drain Fitting Closed (Fluid Servicing)

1.6.5. Solar Control and HPAS electrical

THE ELECTRICAL INSTALLATION SHOULD BE PERFORMED BY AN AUTHORIZED PROFESSIONAL. FOLLOW ALL LOCAL REGULATIONS AND CODES WHEN INSTALLING WIRE, FUSES, GROUNDING, ETC. PROTECT THE HPAS FROM OVERCURRENT. BEFORE ANY ELECTRICAL WORK IS DONE, ENSURE THE HPAS LINE CORD IS DISCONNECTED FROM THE ELECTRICAL SOURCE. FOR PV POWERED SYSTEMS, MAKE SURE PV PANEL IS COVERED UNTIL SYSTEM IS READY FOR OPERATION. REFER TO THE CONTROL MANUAL SHIPPED WITH SYSTEM.

Item Numbers

24

25

26

Both the HPAS models come with the basic internal electrical wiring already completed. For simple DHW operation, the installer only needs to plug in the HPAS line cord into a nearby 120 VAC, 60 Hz grounded wall outlet and wire the storage and collector sensor appropriately. The control comes prewired with two sensor lines. Use 22 AWG or larger cable if the sensor lines need to be extended. Connect the sensors to wire using non-metal wirenuts, or other corrosion resistant connection method.

If attaching additional sensors or wiring, such as for the Pro models, remove the top cover of the electrical box and make the appropriate connections.

1.6.6. Grundfos VFS Flow Sensor

The HPAS Pro and Pro-Lite models come with a digital vortex flow and temperature sensor pre-installed and wired to the Delta-T pro control. No adjustment is necessary. See the Delta-T Pro Manual for further explanation.

47

1.6.7. Pump Operation

Only for: DC Operated Systems

The PV driven pump is also regulated by a 12 VDC version of our DTT-84. This enables the well known differential, high limit and freeze recirc modes (freeze only with a battery array installed with the PV module). Because of the limited size of these pumps, they cannot handle as much collector surface as the AC versions. See the pump table at right for operation characteristics. All HPAS PV versions are supplied with one 20W, 12 VDC PV module.

HPAS Model	016 1X0
Recommended Flow Rate (GPM)	MAX
Max Gobi Surface Area (Ft ²)	80
Max Piping Resistance (Ft H ₂ O)	4

Table 1.6.7.-1a: HPAK Piping Recommendations

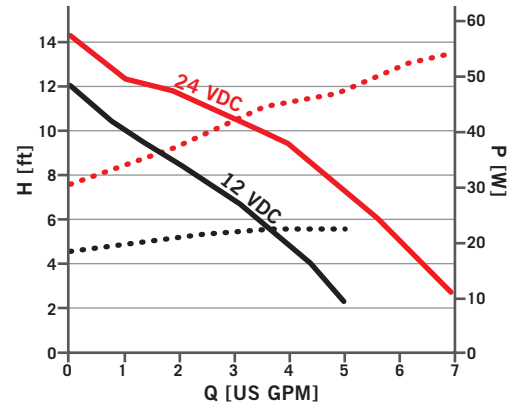

Table 1.6.7.-2a: Laing DC-5 BT Performance

5

Only for: AC Operated Systems

The Grundfos UPS 15-58 CiL2 circulation pump is an FDA tested and approved composite volute three speed pump; it comes prewired, set at speed 2. Depending on Gobi surface area installed, the speed may need to be adjusted by rotating the switch to desired speed. Use Table 1.6.7.-1b for pipe size, collector surface and speed reference. Table 1.6.7.-2b shows the pump performance.



Figure 1.6.7.-1: Grundfos UPS 15-58 CiL2 Pump

HPAS Model	016 OXX
Recommended Flow Rate (GPM)	3-6
Max Gobi Surface Area (Ft ²)	192
Recommended Pump Speed	1-3
Max Piping Resistance (Ft H ₂ O)	4

Table 1.6.7.-1b: HPAK Piping Recommendations

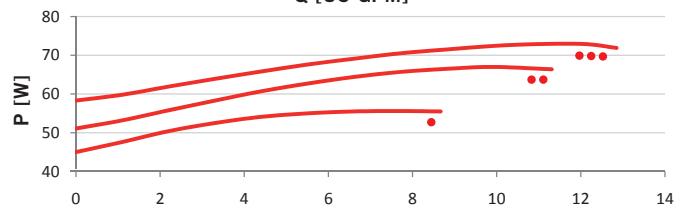
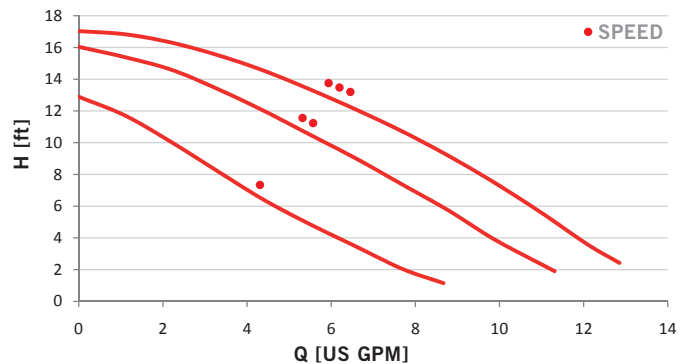

Table 1.6.7.-2b: UPS 15-58 CiL2 Performance

2. MOUNTING HARDWARE

2.0. Rack Mounting Overview



*002B Shown

*All fasteners are black oxide coated; they are shown in silver here for clarity

2.0.0. RACK 000 00X Components and Leg Assembly



3.0.1. RACK Replacement Parts

ITEM	CODE	PART NUMBER	DESCRIPTION	QUANTITY
1	CLIP 000 000B	40082-B	Gobi Rail Clamp, 3/8-16 x 1" SS Serrated Flange Bolt & Nut (set of 4)	1 / Gobi
2	RAIL 001 000B RAIL 002 000B	40092-B 40090-B	2x51" Gobi Mounting Rail with end caps, 1xCLIP 000 000B set 2x102" Gobi Mounting Rail with end caps, 2xCLIP 000 000B set	See Note 1
3	RACK 000 000B RACK 000 001B RACK 000 002B RACK 000 003B	40083-B 40081-B 40080-B 40093-B	Commercial Rack Mount, 4" Front Leg, 47" Rear Leg Flat Roof Rack Mount, 4" Front Leg, 47" Rear Leg Flat Roof Rack Mount, 8" Front Leg, 47" Rear Leg Flat Roof Rack Mount, 4" Front Leg, 67" Rear Leg	# Gobi + 1 ⁴
4	RAIL 000 001	40089	Splice Kit for Joining Rails (Includes 2 for upper and 2 for lower rail)	1 Kit

¹. Order minimum quantity of rails that will accommodate number of collectors in array.

². RACK 000 00X Kits require field assembly.

³. Racks are not for tilts greater than 45°

⁴. May not be appropriate for site penetration and or loading conditions. Consult a structural engineer for advice on proper securing hardware for your installation.

2.1. Rack Installation

2.1.0. Rack Leg Spacing

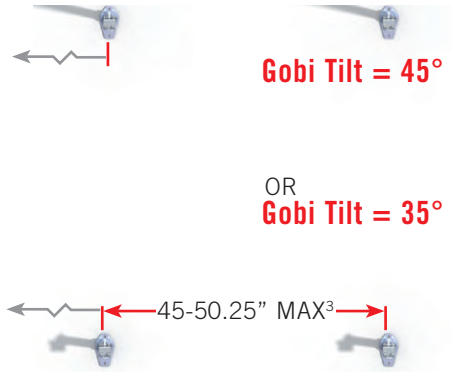

Gobi Tilt = 45°

OR
Gobi Tilt = 35°

RACK 000 000: 43.0"
RACK 000 001: 43.3"
RACK 000 002: 38.7"
RACK 000 003: 61.3" (Gobi 410)

RACK 000 000: 61.8"
RACK 000 001: 61.4"
RACK 000 002: 55.3"
RACK 000 003: 87.5" (Gobi 410)

$$\frac{\text{(Rear Leg Height - Front Leg Height)}}{\tan(\text{Gobi Tilt Angle})}$$

1. Spacing for tilt is independent of collector size.
2. For other tilts the distance between front and rear mounting points =
3. When using rail splices, space rack legs to ensure splices line up with legs (sec 2.1.4).

2.1.1. Rack Foot Mounting

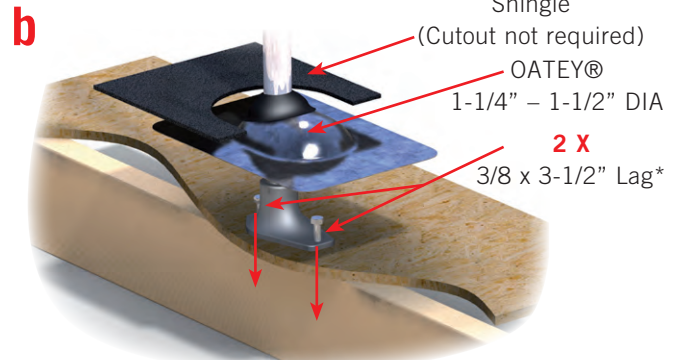
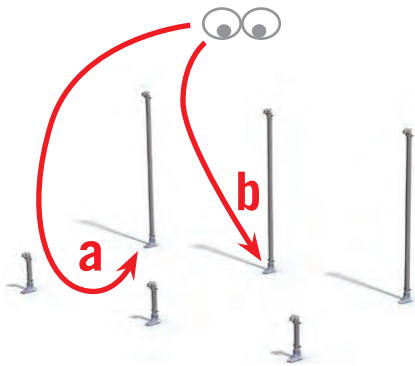

*While lag screws are provided with most kits, consult the American Wood Council NDS 2005 for proper lag screw specifications, or verify with a certified structural engineer, for each specific roof site. Heliodyne is not responsible for mounting anchor integrity.

2.1.2. Rail / Clip Mounting

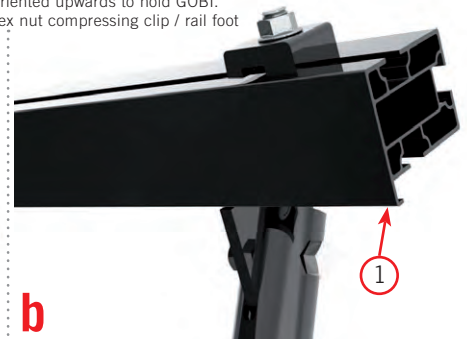
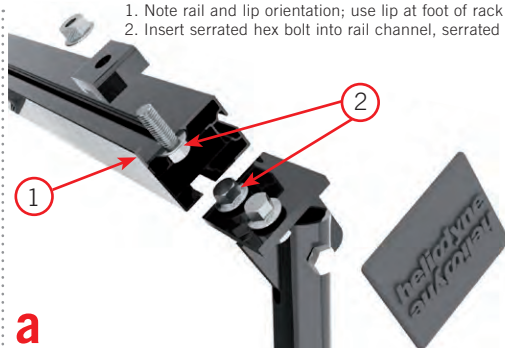
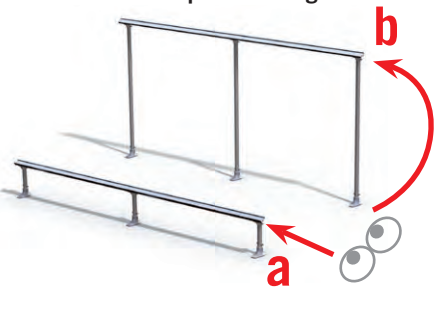

1. Note rail and lip orientation; use lip at foot of rack oriented upwards to hold GOBI.
2. Insert serrated hex bolt into rail channel, serrated hex nut compressing clip / rail foot.

2.1.3. Collector Mounting

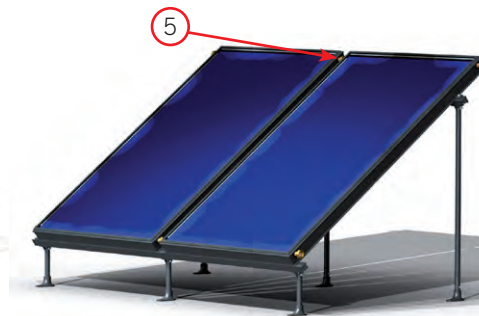

3. Brace rails for first collector
4. Place first collector and install all (4) Heliodyne Clips. Tighten bolts on Heliodyne Clips to engage locking serrated flange nut.
5. Insert O-rings, tighten Unions. Take care not to crimp O-ring. Do not use thread lock or sealants

2.1.4. Rail Splice (optional)

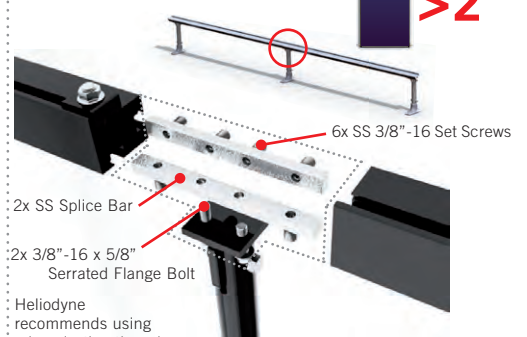

Heliodyne recommends using a long lasting thread locker, such as Loctite 277, on rail splice kits.

2.2. Flush Mounting Overview

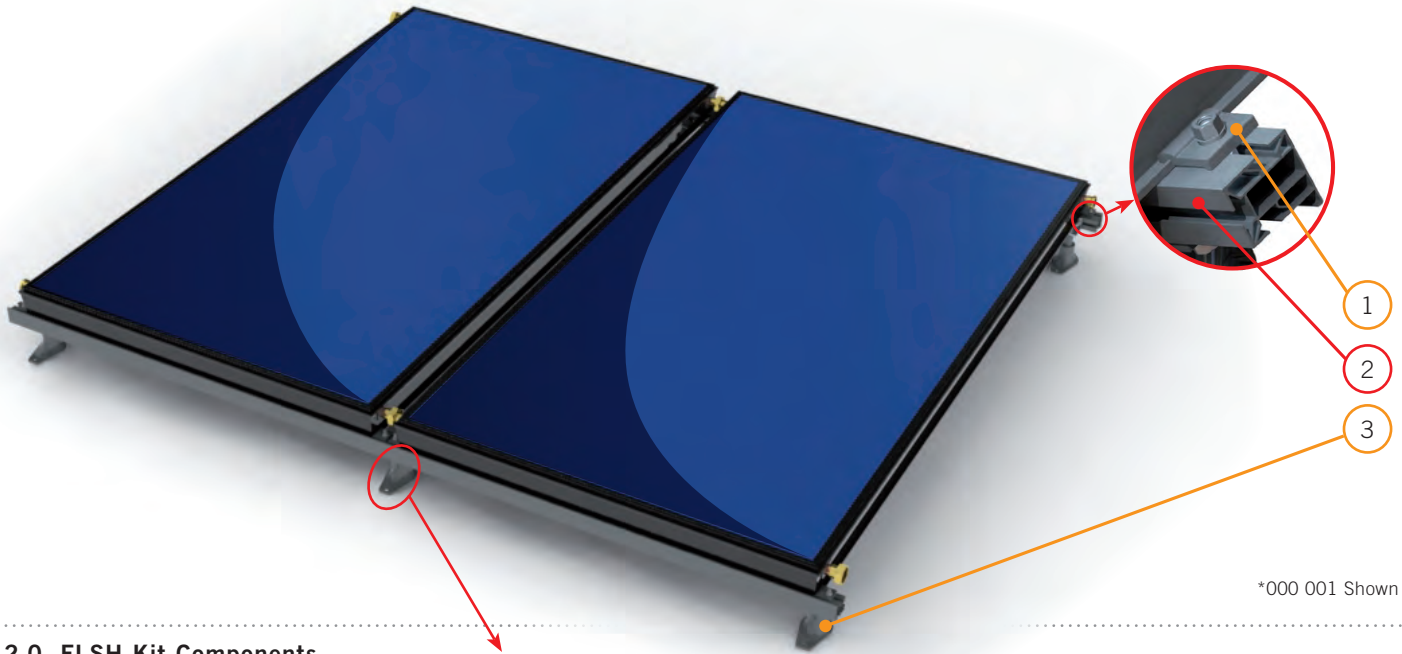

*000 001 Shown

2.2.0. FLSH Kit Components



¹May be substituted with integrated washer head bolt without notice

2.2.1. Flush Replacement Parts

ITEM	CODE	PART NUMBER	DESCRIPTION	QUANTITY
1	CLIP 000 000	40082	Helio-Clamp, 3/8-16 x 3/4 SS Bolt, Flange Nut (set of 4)	1 / Gobi
2	RAIL 001 000	40092	2 x 1 Collector Mounting Rail - 51"	See Note 1
	RAIL 002 000	40090	2 x 2 Collector Mounting Rail - 102", 2 x CLIP 000 000 set	
3	FLSH 001 000	40087	1 Collector Mounting Kit	# Gobi + 1
	FLSH 000 000	40084	Shingle Mount Hanger Bolt Kit	
	FLSH 000 001	40085	Shingle Mount Flange Kit	
	FLSH 000 002	40086	Tile Mount Kit	
4	RAIL 000 001	40089	Splice Kit for Joining Rails	1 Kit

2.3. Flush Installation

2.3.0. Flush Foot Spacing

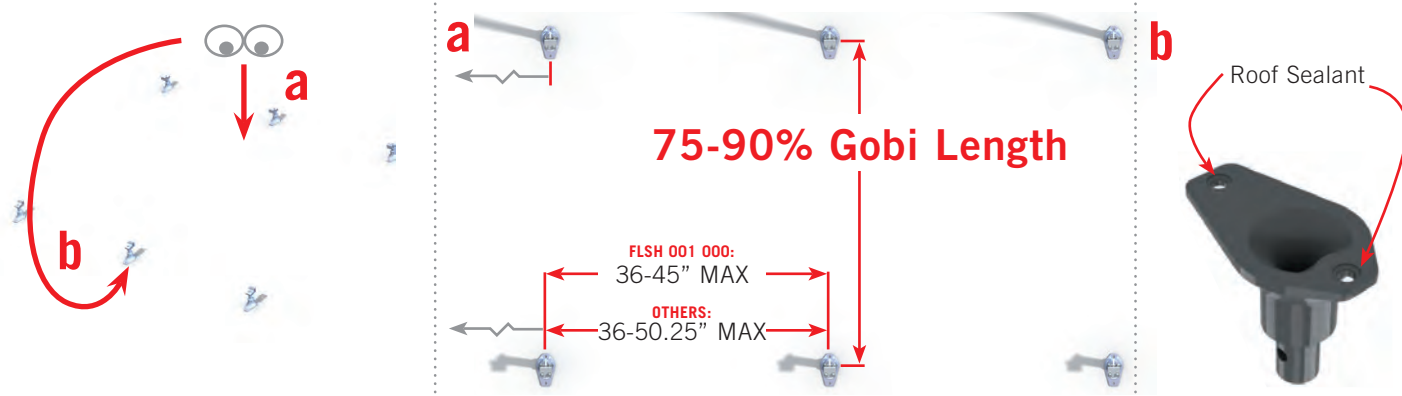

2.3.1. Hanger Bolt Mounting²

1. Locate a rafter and drill a 3/8" hole for lag portion add roof sealant; use two flange nuts backed against each other to lag bolt into roof
2. Use one flange nut face down for compression seal.
3. Thread on 2nd nut with flange upwards, then Clip or "L" bracket, then third flange nut and tighten.

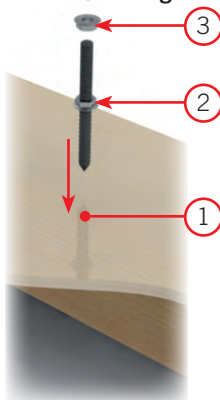

2.3.2. Flange Mounting²

1. Locate a rafter and use flange as template to drill two 3/8" holes for lag screws; add roof sealant to holes and flange.
2. Lag in screws.
3. Place OATEY 1-1/4" flashing over flange.
4. Replace shingle over flashing; follow best roofing practices to ensure seal.

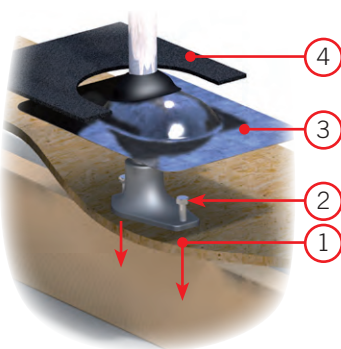

2.3.3. Tile Mounting²

1. Remove tiles. Locate a rafter and use tile bracket as template to drill three 3/8" holes for lag screws; add roof sealant to holes.
2. Lag in screws.
3. Replace tiles over bracket; follow best roofing practices to ensure seal.

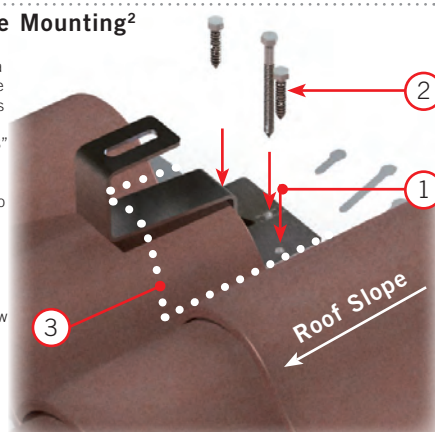

2.3.4. Rail Mounting



1. With bolts, flange nuts and washers installed, slide all "L" brackets onto each rail into approximate position of hanger bolts, flash flange or tile bracket; ensure the washer is on the inside of the rail flange for proper strength.
2. Insert "L" bracket onto each mount.
3. Tighten all nuts and bolts for proper strength.

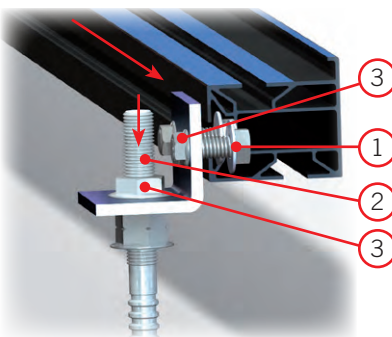

2.3.5. Collector Mounting

1. Before placing collectors, slide all clamp bolts and washers into approximate position on rails. Ensure washer is inside the rail channel for proper strength.

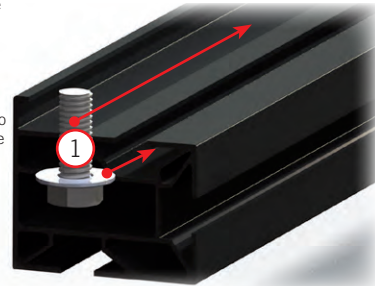

2.3.6. Rail Splice (optional)

Heliodyne recommends using a long lasting thread locker, such as Loctite 277, on rail splice kits.

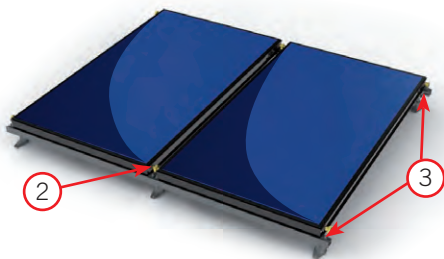
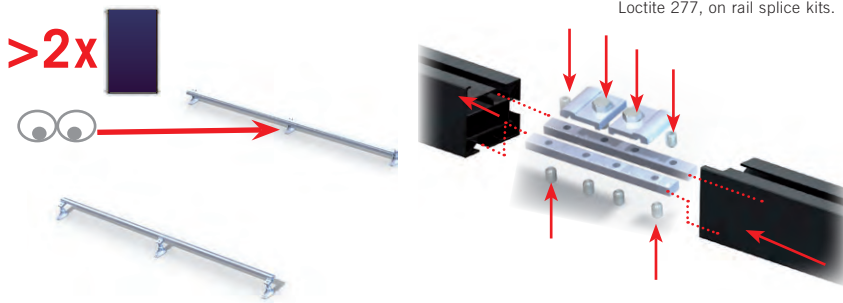

2. Place collectors. Insert O-rings, tighten Unions. Take care not to crimp O-ring. Do not use thread lock or sealants.
3. Place Heliodyne Clamps, and thread flanged nuts on exposed bolts and tighten securely.

²While lag screws are provided with most kits, consult the American Wood Council NDS 2005 for proper lag screw specifications, or verify with a certified structural engineer, for each specific roof site. Heliodyne is not responsible for mounting anchor integrity.

3. HPAS INSTALLATION

3.0. HPAS Connections and Hydraulic Schematic

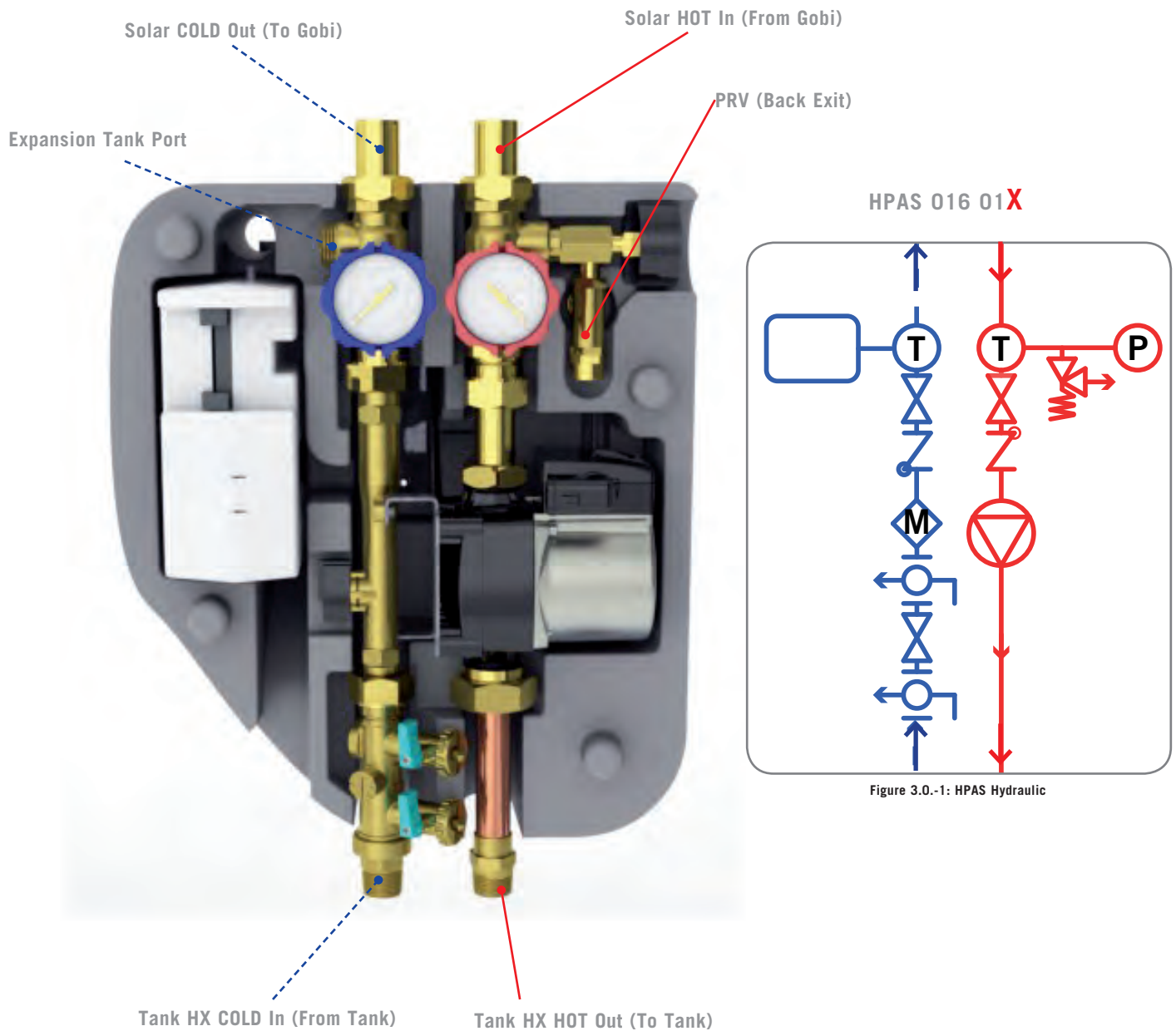

Figure 3.0.-1: HPAS Connections

3.1. Sensor Installation

HPAS's come with the necessary sensors pre-wired into the control; for more information see the separate control manual. The controls require at least one tank sensor: on the bottom of the storage tank; the top tank sensor is optional. Most solar storage tanks have a stud near the bottom for placement. If a specific area is not available, attach to a metal drain, disconnected lower element, or use the cold in for lower tank sensor; use the hot out for a top tank sensor. The collector sensor must go on the outlet header of the array.

3.3.0. Storage Sensor Panel Removal and Installation



3.3.1. Collector Sensor Installation

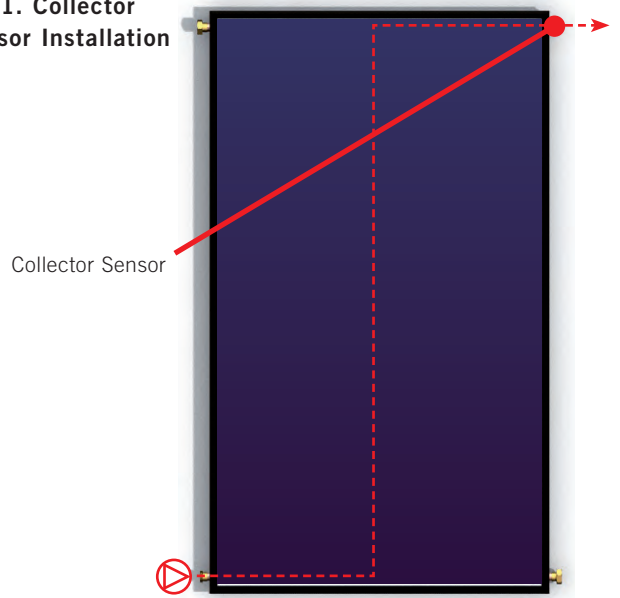

3.2. HPAS Tank Mounting

Use the self-tapping screws provided with the HPAS to mount the X-Bracket to the storage tank (or wall nearby) as shown in figure 3.4-1, then hang the HPAS on the studs of the X-Bracket. Use a level for straightness; the studs in the X-Bracket should be approximately two inches below the top of the tank, to align with the top of the HPAS foam.

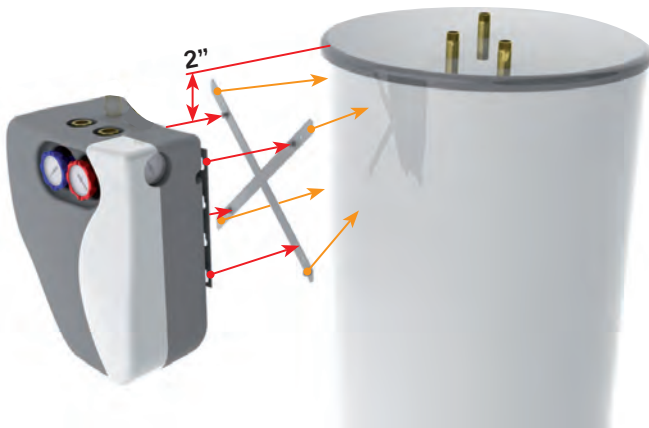
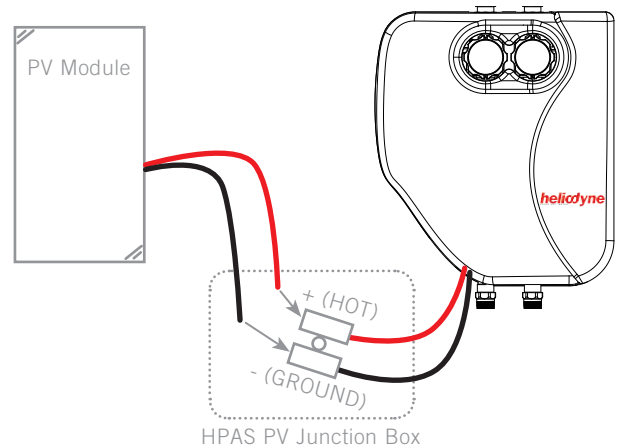

Figure 3.4.-1: HPAS Tank Mounting

3.3. Only for DC Operated Systems - HPAS PV Module Mounting

For PV powered systems, the module needs to be mounted on the collector array. Refer to the installation instructions included with the PV Module Mounting Kit.









Always keep the panel covered until the system is ready for operation. Connect the PV module wiring to the connections extended from the controller box. Take care to preserve polarity.



4. PIPING

4.0. Connect the HPAS to the Tank

Insulate all hot water piping, as well as the final five feet of cold water storage inlet piping to a minimum R2.6. To enable backup heat during solar system maintenance, isolation and shut off valves must be installed as recommended in installation schematics below. Use dielectric unions when connecting piping to the storage tank nipples.

- Normally Open / Isolation  10 Air Vent
- Combo Valve*: Cold  11 Collector Sensor
- Flow & Temp Meter (Pro)  12 Gobi Collector
- Filling Valve  13 Combo Valve*: Hot
- Collector Pump  14 150 psi PRV
- Tank Sensor  15 Pressure Gauge
- Normally Open Valve  16 P & T Valve
-  8 HX Solar Storage
-  9 Tempering Valve

*A combo valve is an integrated temperature gauge, ball and check valve. The ball valve can be operated as described in the components section 1.6.3 above and is normally open.

Install ball valves accordingly so the solar system can be isolated from the backup system during service, while still allowing the backup to provide hot water to the fixtures.

It is also good practice to install a bypass valve, or series of valves to make it possible to bypass the backup heater entirely during the summer time when no backup is necessary.

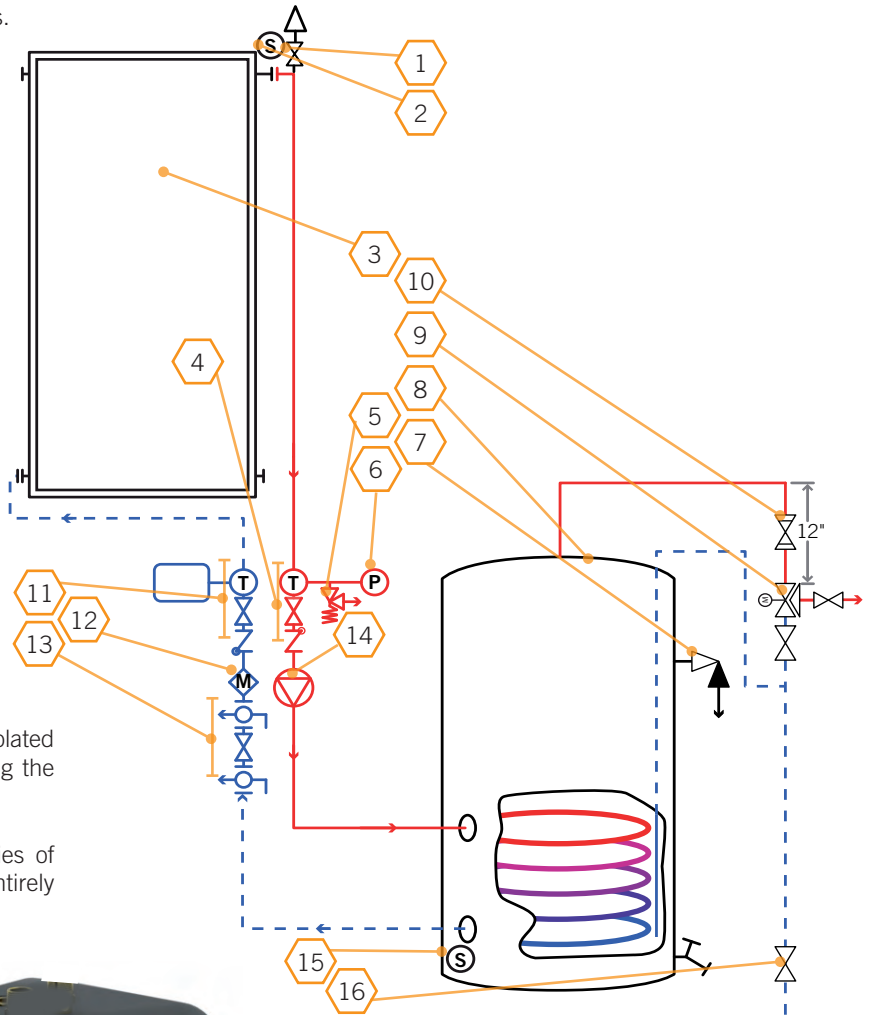
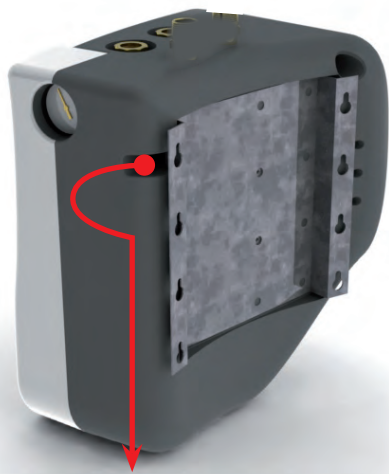

Figure 4.0.-1: Typical HPAS Installation Schematic

4.1. Connect the PRV to Hose for Drain

The PRV comes with a barbed hose fitting to attached a 1/4" ID hose for funneling glycol to a bucket or drain, in the rare even of release. Since this is not part of a pressurized system, there is no need to use expensive copper; PEX or other high temperature suitable plastics are okay here only (if code allows).

In the even of a pressure release, contact Heliodyne to discuss expansion tank sizing.





4.2. Additional Tank Schematics

If your tank is not here, contact Heliodyne with questions. In accordance with SRCC standard OG-300, all piping and valves must be labeled. Attach the waterproofed labels provided with this manual to the appropriate components using zip-ties.

During solar system maintenance, turn the isolation valves to the opposite operation to allow the backup to maintain hot water and avoid service interruption.

In the summer months when the backup is not needed, additional energy can be saved by disabling and bypassing the backup.

-  Normally Open Isolation Valve
-  Normally Closed Isolation Valve

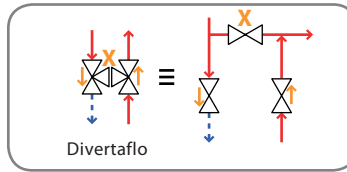

Summer Bypass: OFF

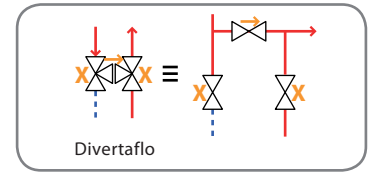

Summer Bypass: ON

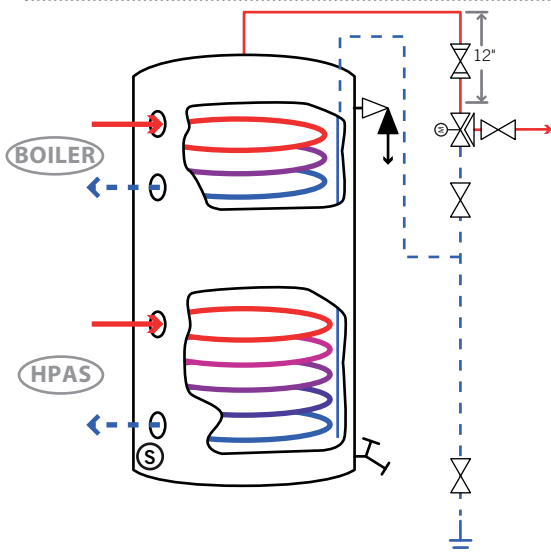

Figure 4.2-1: Dual Coil Tank: Boiler Backup

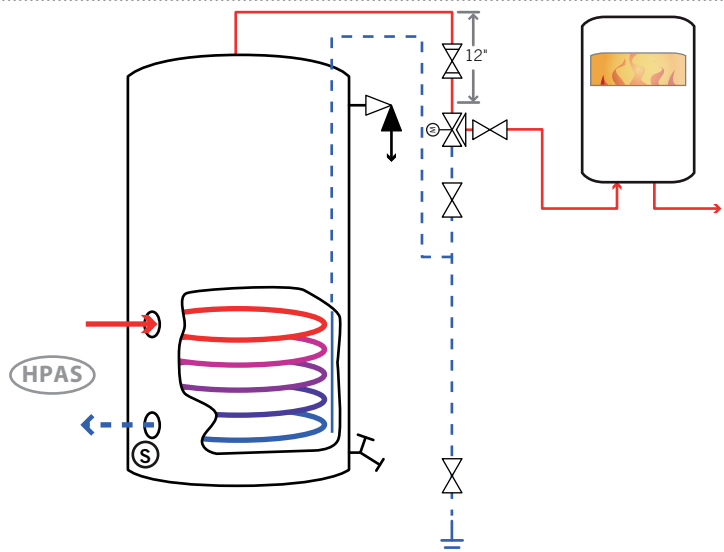

Figure 4.2-2: Single Solar Coil, On Demand Backup

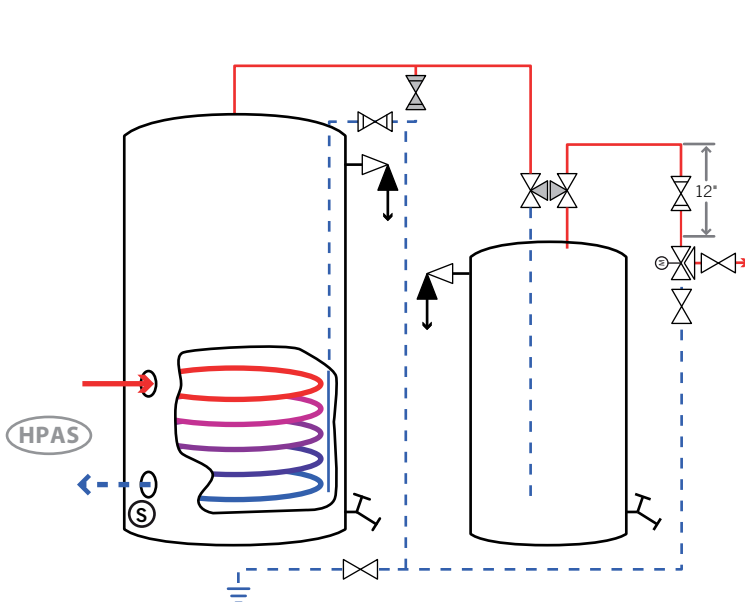

Figure 4.2-3: Single Solar Coil, Electric Backup Tank

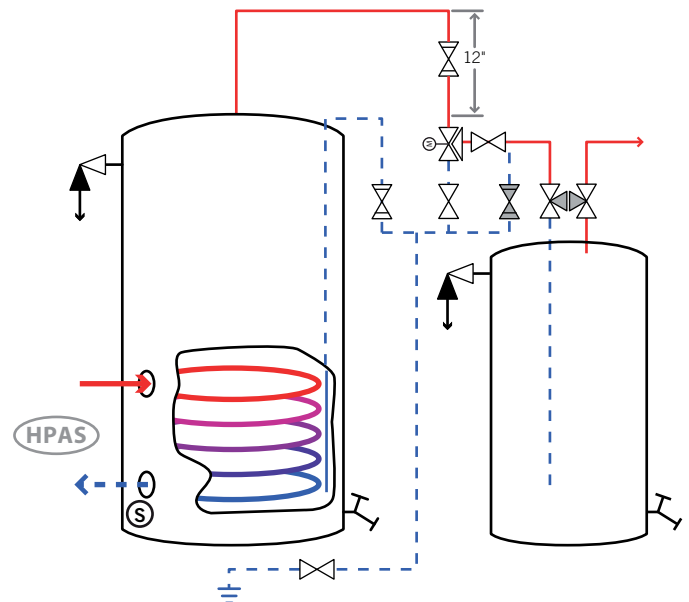
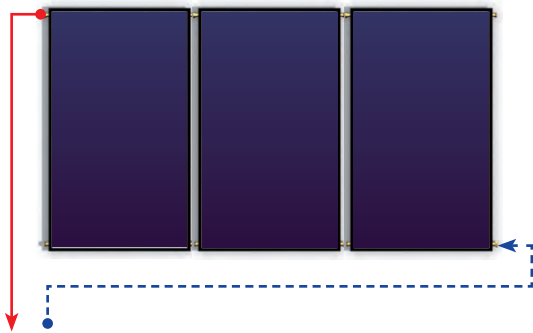

Figure 4.2-4: Single Solar Coil, Gas Backup Tank

4.3. Gobi Collector Plumbing

Use only copper piping on the collector loop, solder to appropriate conditions in technical specifications. Always plumb in reverse return with the longest line the cold, or use automatic balancing valves. Insulate piping for least losses; use rubber based insulation with environment protection or Solar Pipe from Heliodyne. Gobi collectors can be put in portrait arrays of up to eight. Install bleed vents for filling at local high points. Use pipe supports in accordance with local codes, and ensure these supports do not compress the insulation.

4.3.0. Portrait Single Collector or Array



4.3.1. Single Horizontal Collector

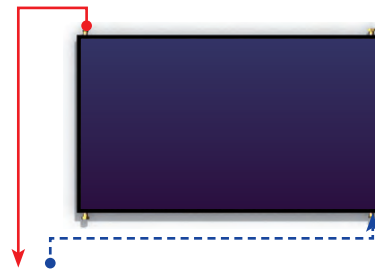

4.3.2. Multiple Horizontal Collectors

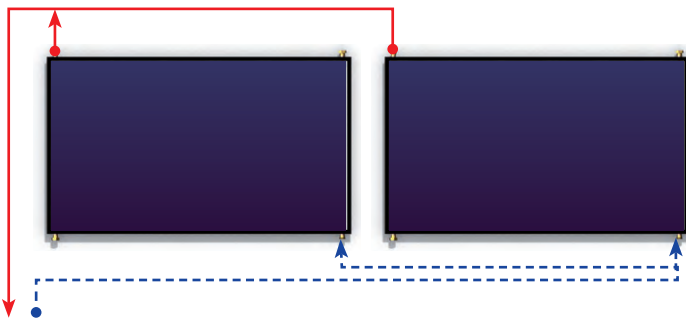

4.3.3. Multiple Vertically Aligned Portrait Arrays

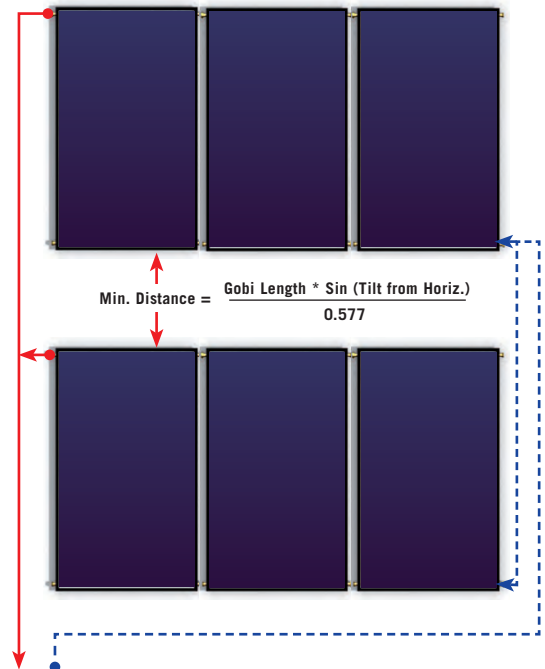

4.3.3. Multiple Horizontally Aligned Portrait Arrays

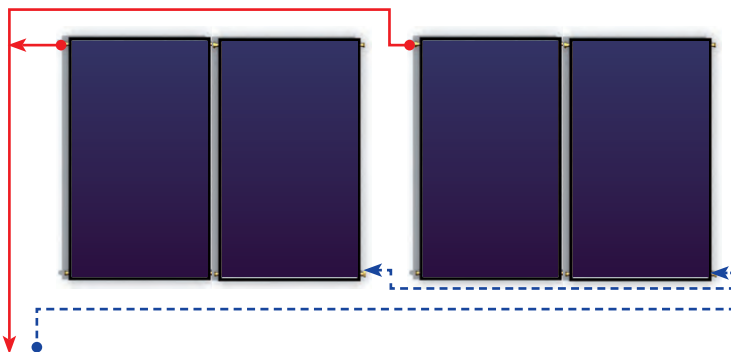

5. COMMISSIONING

5.0. Getting the Site Ready for Installation

Below are several key points to ensure a successful HPAS installation.

- The HPAS comes with 120VAC circulator and controller. All high-power connections prewired and supplied from the 8' power cord. Ensure there is an appropriate voltage outlet close enough by to power the unit. Never use extension cords
- Position the HPAS unit on the tank such that any initial filling or maintenance can be performed easily.
- Position the tank in such that the drain and T & P valve can be accessed if necessary.
- If the HPAS being installed has compression rings and fittings for the solar connections, ensure the 3/4" copper tubing being used is super round and clean. The compression nut must be carefully threaded on to avoid cross threading. The compression seal requires a stout torque on the nut for a proper seal - always use a counter wrench.
- If the HPAS being installed has the new DOS system with O-Ring, remove the O-Ring prior to soldering to avoid damage. Use a heat guard to protect the heat sensitive EPP foam insulation around the HPAS.
- The expansion tank comes with a 15" stainless steel flex hose for connection between the HPAS and the expansion tank. The flex hose has gaskets to ensure an easier, water tight seal. DO NOT OVER TIGHTEN, as this can damage the gasket and prevent sealing.
- The tank heat exchanger connections are 3/4" female tapered pipe thread. Always use Teflon tape or some other thread sealant to achieve a water tight seal. Always use a counter-wrench when torquing these connections.
- The pressure relief valve comes with a plastic hose barb. Because the release is at atmosphere, if code allows, a simple plastic hose can be fitting on and run to a container for later use in refilling. Do not route the fluid into the drain. The fluid exiting will be very hot and should be routed to a location away from harm.

5.1. Installation Overview: Basic Steps

1. Start by installing the collectors and roughing in the piping / sensors into the HPAS / Tank room. Seal all roof penetrations.
 2. [New Tanks] Position the tank as desired and brace or strap as code requires.
 3. Install the HPAS on the tank; leave it unplugged.
 4. Finish running the collector piping to the HPAS collector connections.
 5. Run piping from the HPAS tank HX connections to the appropriate connections on the solar tank.
- If tank is empty:**
6. Disable any back up heating unit.
 7. Turn off the mains water supply.
 8. Bleed out the cold and hot water pressure by opening up a sink or bathtub at the lowest point in the house.
 9. Route the cold mains water supply into the solar storage tank.
 10. Route the hot from the solar storage tank to the appropriate supply line [single tank system] or to the back up heating unit [solar tank with back up].
 11. Turn the mains water supply back on and fill the storage tank and back up.
 12. Isolate the solar system from the hot water supply.
 13. Enable the back up heating unit - fixtures should now be able to draw hot water again.
 14. Isolate the expansion tank and pressurize the Collector / HPAS loop with the mains water supply and inspect for leaks.
 15. Flush out the collector loop with the mains water supply.
 16. Enable the expansion tank.
 17. Fill and pressurize the system with PG mixture.
 18. Plug in the HPAS.
 19. Set the control to manual ON; purge the air from the system: run the system with the air vent open and allow it collect solar energy and heat up (increasing the system temperature will bring air out of solution for purging).
 20. Top off the system with any remaining fluid to bring it back to the final pressure.
 21. Close any air vents and open any bypass or solar system isolation valves.
 22. Check sensors, flow meter and circulator for proper operation. Change any controller settings as necessary per the controller manual and finally set the controller to Auto.
 23. Check in with the system minimum once per year for maintenance.

5.2. Clean and Pressure Test the Collector Loop

Before filling the collector loop with heat transfer fluid (water for open loop, Dyn-O-Flo HD mixture in closed loop), pressure test the collector loop to check for soldering leaks and proper joint mates. Remove or isolate the expansion tank before pressure testing. Fill the collector loop with water using the site hose and pressurize up to mains pressure; the filling station can also be used. Heliodyne recommends pressure testing up to at least 100 psig. Monitor the pressure gauge for drops in pressure, inspect all joints. Heliodyne recommends monitoring the pressure for a few hours.

After pressure testing, flush the system with water, or a 1-2% solution of TSP and water. Flushing can be done easiest using the filling valve installed between the collector and HPAS (for either open or closed loop) and a filling station.

5.3. Calculate System Fluid Volume and Necessary Glycol Concentration

Find the total fluid capacity by adding in the volume of the collectors, HPAS, and supply and return lines. With the total volume, use the equation below to find out necessary gallons of glycol. Glycol concentration should be 40 – 60% for proper inhibitor concentration, regardless of required freeze protection. A higher concentration than is required for freeze protection is recommended in case of errors in fluid calculation.

$$\text{Gallons of Dyn-O-Flo HD} = \text{Desired Concentration (\%)} * \text{Total System Fluid (gal.)} / 100$$

SYSTEM COMPONENT	FLUID CAPACITY (GAL.)
GOBI 406 001 & 002	0.75
GOBI 408 001 & 002	0.83
GOBI 410 001 & 002	0.95
HPAS 016 000 & 001	0.15

ASTM B88 COPPER TUBING	GALLONS / 100'
Type M 1/2" (5/8" OD)	1.32
Type M 3/4" (7/8" OD)	2.68
Type M 1" (1-1/8" OD)	4.54
Type M 1-1/4" (1-3/8" OD)	6.80

5.4. Final Fill and Commissioning

The system can be filled easily with a filling pump from Heliodyne or manually. Consult the manual with the filling pump for operation. Take care to use mineral spring water or good quality tap water and only fill system when collector is cold. See installation notes at the end of this manual for water requirements. Air vents or bleed vents at the high points in the system help rid the system of air during filling only. If using any type of automatic air vent, close vent after filling is complete as vents are not suitable for glycol systems, or systems without continuously replaced fluids.

For use with a pump, connect pump supply hose to position 3 at right, and return hose to position 2. Turn 1 so slot is horizontal, forcing return fluid out of 2. Turn on pump to begin filling. After fluid begins to return back into tank from 2, close off valve at 2 and open 1. System will pressurize rapidly; monitor gauge and close off valve at 3 when system reaches 40 – 60 psi. Turn off pump. Close off any bleed or air vents and run system throughout the day. Check after a day cycle to ensure the cold pressure of the system is at around 30 psig when cold. If further pressurization is necessary, hook up pump supply to 3, turn pump on, open valve and pressurize back up. For manual fill, pour in proper glycol and water mixture with a funnel into the top unused header connection of Gobi. Pressurize with house water using the valve at position 3; follow pressure guidelines as above. Hose nipples are provided, pre-set into the foam next to the fill valve.

After filling, ensure the controller has the correct freeze protection settings (see accompanying manual for further detail). Plug in the power cord (or uncover the PV module) and set the controller to run in "Auto".

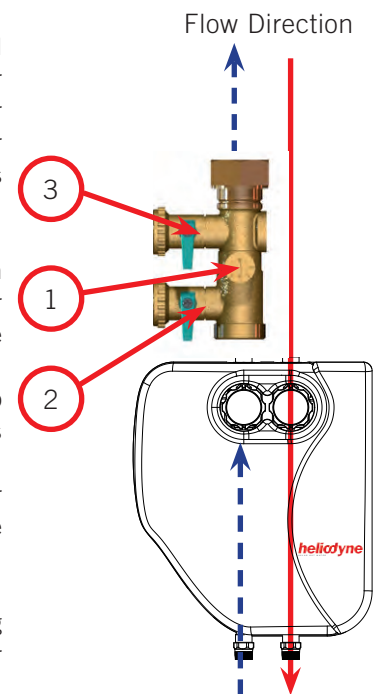

Figure 5.2.-1: Fill Valve Operation

6. O&M

6.0. Annual Operational Checks and Troubleshooting

Every year the solar system should be checked to ensure optimal performance; these annual checks performed by a qualified professional should not take the place of good operation overview by the systems owner. Annually or more often, the following content should be verified.

All Systems:

6.0.0. Check the collector pump for operation

- With proper operation, the hot or red gauge should read 10-20°F hotter than the blue gauge.
- With a temperature difference greater than 20°F, set the pump speeds to a higher level. For a difference less than 10°F, set the pump speeds to a lower level.
- Loud operation or squealing means air in the system, follow filling guidelines for re-pressurization.
- No temperature difference could mean a pump failure, test pump supply voltage at pump electrical box, listen and feel for OP.
- No temperature difference could also mean a diptube wasn't installed correctly, or at the right length. Review tank schematics in this manual for proper length.
- The hot and cold ball valves could be turned incorrectly; ensure the slots on the top and bottom of the plastic red or blue colored handle are aligned vertically.
- The filling valve bypass could be turned incorrectly; ensure the slot aligns vertically.

6.0.1. Check the control and sensors

- Ensure the sensors are giving proper readings by either viewing the software in the Delta-T Pro, or using a multimeter to measure resistance. See the control manual for further details.
- Check wiring to ensure it is undamaged and continuous.

6.0.2. Check pressure gauge

- Pressure gauge on HPAS should be no less than 30 psig when system is cold. Follow filling guidelines for re-pressurization.
- Inspect system for leaks.

6.0.3. Check expansion tank pressure

- The expansion tanks have a shraeder valve (like a bicycle tube valve) for pressurization; it should be charged with approximately 25 psig.

6.0.4. Check the glycol color, concentration and pH.

- Heliodyne has glycol testing kits that perform the required analysis. Review the data sheet for Dyn-O-Flo HD in this manual for proper levels.
- Glycol should be a bright green color; anything else needs to be replaced. Use only Dyn-O-Flo HD or equivalent.

6.1. Maintenance

To replace parts on the HPAS, close the hot and cold ball valves for servicing equipment underneath them such as pump, heat exchanger, flow sensor, etc, and turn off the water supply to the storage tank. For servicing PRV, pressure gauge, expansion tank or collectors and piping, the system should be drained in the direction of flow via the fill valve. If the fluid is good, drain it to a bucket for reuse. Estimated time per component: 1-2 hours.

To replace any of the combo valves, unscrew appropriate valve, and replace gasket with valve; torque connections to 30 lb-ft. Estimated time: 2 hours.

To service a pump, the motor housing only needs replacing, as volutes have no moving parts. Disconnect electricity from HPAS, then disconnect the pump wiring with the spring clamps. Unscrew the four allen-keyed bolts and replace motor and electrical connections. Torque bolts to 80 lb-in. Estimated time: 2 hours

To service the controller, disconnect the electricity from the unit and remove the box housing, unplug all connections and power wiring, and replace the board. After reinstalling a new controller, test operation by turning the control on manually. Estimated time: 1 hour.

Close Ball Valves: Rotate 90° CW

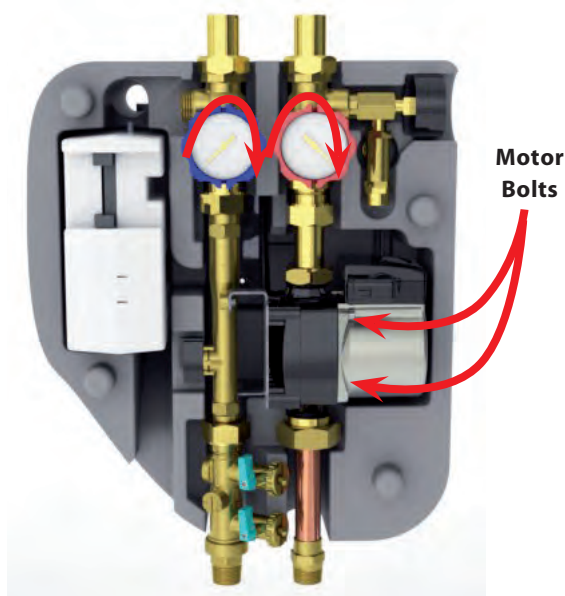

heliodyne
SOLAR HOT WATER

7. DYN-O-FLO HD

7.0. General Dyn-O-Flo HD Notes

Dyn-O-Flo HD is a 100% concentrate inhibited propylene glycol and is recommended for use in applications where low acute oral toxicity is important or where incidental contact with drinking water is possible. Extra strength corrosion inhibitors in the HD fluid are formulated for high temperature use, resulting in reduced maintenance and longer inhibitor life in most applications. Freeze tolerance limits are based on an assumed set of environmental conditions.

7.0.0. Use Directions

- Do not use full strength.
- Recommended concentration is 40 – 60%.
- Dilute with good quality soft water. If the tap water has more than 25 ppm of chloride or sulfate ions, or more than 50 ppm of calcium or magnesium, use mountain spring water.
- Do not use zinc or galvanized components in contact with the fluid.
- System preparation: Flush thoroughly with water (use 1 – 2% TSP) and circulate without adding heat, before introducing the operating fluid.
- Fluid Introduction: Please see the Helio-Pak systems Manuals for filling, venting and priming.
- Maintenance: The fluid should be checked periodically for pH, which should not drop below 8, and reserve alkalinity, which should stay greater than zero at all times.
- Flush thoroughly before replacing with new mix.
- The Dyn-O-Flo HD has an operating temperature range of -50 – 325 °F.

7.0.1. Specifications

- *Specific Gravity:* 1.053 – 1.063
- *Propylene Glycol:* 94%
- *Inhibitor Concentration by Weight:* 6%, inhibitors and water
- *Dye:* Bright yellow
- *Suspended Solids:* substantially free
- *Reserve Alkalinity:* 15 mL

7.0.2. Values at 50% Concentration

The listed values are typical of a 50% by volume aqueous solution at 120° F and should not be regarded as specifications.

- *pH:* 9.5 – 10.5
- *Specific Heat:* 0.842 BTU / lb °F
- *Freezing Point:* -30 °F
- *Burst Protection:* < -60 °F
- *Viscosity:* 2.36 Cps

7.0.3. First Aid

While essentially non-irritating, absorbing or toxic, Dyn-O-Flo HD heat transfer fluid should be kept away from children and be treated with care. In case of physical contact, follow these directions:

- *Eyes:* Flush with plenty of water
- *Skin:* Wash off with flowing water
- *Ingestion:* Induce vomiting and consult a physician
- *Inhalation:* Remove to fresh air, consult physician.

Notice to Physician: No specific antidote. Supportive care based on judgment of physician.

7.0.4. Handling

- *Exposure Guidelines:* Propylene glycol: AIHA WEEL is 50 ppm total, 10 mg / m³ aerosol only.
- *Ventilation:* Good general ventilation should be sufficient for most conditions.
- *Respiratory Protection:* No respiratory protection should be needed.
- *Skin Protection:* For brief contact, no precautions other than cleaning of body and covering. Use impervious gloves when prolonged or frequently repeated contact occurs.
- *Eye Protection:* Use safety glasses.
- *Spills:* Cover with absorbent material, soak up and seep into bag.
- *Disposal:* Discharge into sanitary sewers only with the explicit pre-approval of the local waste water facility. Any disposal practice must be in compliance with federal, state, provincial and local laws and regulations. Check with the appropriate agencies.

7.0.5. Maintenance

The glycol / water mix should be tested periodically for freeze protection and pH. Empty the system and flush thoroughly before replacing with a fresh mix when the pH drops below 8, or reserve alkalinity approaches zero.

8. SYSTEM NOTES & WARRANTY

8.0. System Notes

Installation and service should be performed by qualified personnel only. Always follow the most recent version of the Heliodyne Collector Installation and Maintenance Guidelines for collector installation.

8.0.0. System Fluid Information

Always use copper tubing for collector supply and return connections. Black iron pipe can also be used, with proper dielectrics. Never use galvanized pipe or plastic based products, such as PEX.

For closed loop operation, use only Dyn-O-Flo HD heat transfer fluid with good quality water mixture: min 40% HD mixture, max 60% HD mixture. Do not use distilled water. Good quality water: chlorides and sulfates must be less than 25 ppm; calcium and magnesium must be less than 50 ppm (as calcium carbonate, with hardness less than 100 ppm). If unsure, use bottled mountain spring water.

Rinse system with 1 – 2% mixture of trisodium phosphate and water. Remove the expansion tank for testing only, and pressure test system with water before filling.

Maintain minimum operating pressure of 30psig when system is cold to avoid pump cavitation. If using an air vent during filling, ensure it is closed during system operation.

8.0.1. Safety Precautions

Follow all local codes and regulations. All equipment should be grounded for protection against lightning.

It is the installer's responsibility to ensure all the codes and inspections are carried out and that he or she is fully versed in these guidelines.

Work should only be performed on the HPAS and system when it is disconnected from the power supply.

When creating and repairing roof penetrations, ensure final seal disallows any unwanted animal or creature intrusion, and the integrity of the structure is not compromised. Penetrations through fire-rated assemblies must not reduce fire resistance capacity below code.

8.0.2. Components

Place the HPAS and tank in a non-freezing environment.

Building materials adjacent to solar components must not be exposed to elevated temperatures produced by the solar system.

Solder suitable for 400°F and 150 psig must be used: 96/4 Tin / Silver is recommended.

Use non-plastic pipe insulation, such as Armaflex.

Route the pressure relief port on the HPAS to drain to avoid accidental scalding in case of release.

8.0.3. Description Of Product and Operation

The HPAS is a fully automatic solar energy heat transfer appliance. The controller senses the collector and storage temperatures and powers both circulation pumps when the collector has achieved enough temperature over the solar storage tank. See the Delta-T and Delta-T Pro manuals for full descriptions of operation and functions.

8.0.4. Commissioning

After the system is filled, it is normal for the initial pressure to drop as air comes out of solution. Repressurize the system to ensure at least 30psig when cold. Ensure the control has appropriate freeze protection settings (if applicable) and the tank high limit has been set at a temperature at or below the tank manufacturer's recommendation.

8.1. Warranty

HELIODYNE, shall provide a warranty for defects in compliance with the purchased goods delivered after 3/1/2009. This warranty applies to the first retail buyer and to any subsequent owners. Product shall be free from defects in material and workmanship, malfunctions and failure to perform, under normal use, service and maintenance, provided that said products have been installed in accordance with HELIODYNE's Installation Instructions. The warranty term for each product shall begin on the date of installation and remain active for the period of time as specified and applicable for each individual product.

The HCOM, HPAK, HFLO, HPAS Products and their variants.

- Five (5) year limited warranty (parts only, no labor, no shipping) from date of installation when installed with HELIODYNE Collectors.
- Three (3) year limited warranty (parts only, no labor, no shipping) on Integrated Electronics (such as controller, pumps, sensors, etc.)
- In the event that the Product is installed with another brand of collector, or any equipment other than HELIODYNE collectors, then the period of time shall be one (1) year from date of installation for Product and Electronics.

The GOBI Collectors and their variants.

- Ten (10) year limited warranty (parts only, no labor, no shipping) from date of installation.

The DELTA-T Products and their variants.

- Three (3) year limited warranty (parts only, no labor, no shipping) from the date of installation. In the event that evidence cannot be provided to indicate the date of installation, then the warranty period shall begin on the date the product was manufactured.

Objects are warranted at HELIODYNE's discretion by repair of the object of purchase or replacement of defective parts, exchange or reduction of price. The right of the contractor to convert objects is ceded by common consent. Replaced parts become the property of HELIODYNE. Wages and costs spent on shipping, installation and disassembly must be covered by the client. This provision similarly applies to all warranty agreements. It is at HELIODYNE's discretion to replace defective goods with similar, faultless goods. In this case, any rights to cancel the agreement cease. The client expressly waives the right for it and its legal successors to assert claims for damages or loss of profit (including without limitation special, indirect, loss of use, contingent, or consequential damages) due to defects or nonconformity in the purchased good. The warranty set forth above constitutes the sole and exclusive remedy against HELIODYNE for the furnishing of any nonconforming or defective goods. THE ABOVE WARRANTY IS EXPRESSLY IN LIEU OF ALL OTHER WARRANTIES, EXPRESS OR IMPLIED, INCLUDING WITHOUT LIMITATION ANY WARRANTY AS TO MERCHANTABILITY OR FITNESS FOR A PARTICULAR USE OR PURPOSE.

If the Product contains a defect that cannot be repaired after a reasonable number of attempts to do so, you, the buyer, may elect either a refund of its purchase price, or a replacement without charge. A replacement may consist of a new or factory rebuilt product of at least the same quality. A new warranty shall apply to any replacement.

Claims on warranty will only be admitted and considered if they are announced in writing immediately after the defect was first noticed. Oral communication or communication by telephone is not sufficient. To obtain service on the Product, notify Heliodyne Customer Service by email at sales@heliodyne.com, or by letter to **4910 Seaport Ave., Richmond, CA, 94804**. Provide proof of purchase and date.

Should service be requested and no defect found in the Product, then a reasonable charge will be made for the service.

In no event shall HELIODYNE be liable for the following:

- Conditions resulting from a defect in a component or part that does not make up the HELIODYNE Product.
- Conditions resulting from a significant departure from Heliodyne's Installation Instructions.
- Conditions resulting from any misuse, abuse, negligence, weather damage, accident or alteration.
- Consequential damages such as: damage to your property, loss of time, inconvenience or loss of use of the Product or any incidental expenses resulting from any breach of the express warranty. Conditions that may occur in the normal operation of the Product shall not be invoked by HELIODYNE to reduce or defeat the coverage of this warranty.

HELIODYNE's liability under this warranty shall be in lieu of all warranties of fitness and in lieu of all warranties of merchantability. Heliodyne shall not be liable for any incidental or consequential damages covered by a defective product. The maximum liability under this warranty shall not exceed the contract price of the Product. Some states do not allow the exclusion or limitations of incidental or consequential damages, and some states do not allow limitations on implied warranties, such as that of fitness and of merchantability. Therefore the above exclusions and limitations do not apply to you.

The warranty excludes damage caused by force majeure and malfunction that are due to improper assembly, and/or product installation. HELIODYNE is not liable for possible costs resulting from defects. In order for HELIODYNE to accept liability:

- Installation must have been carried out by a licensed specialized company (heating contractor or plumber) following the version of installation instructions in force;
- HELIODYNE or its representative was given the opportunity to check complaints on site immediately after any defect occurred;
- Confirmation exists that the system was commissioned properly and that the system was checked and maintenance was performed annually by a specialized company licensed for this purpose. The warranty agreed by HELIODYNE is only valid for their clients.

This warranty gives you specific legal rights, and you may also have other rights, which vary from state to state. Unless otherwise explicitly agreed in writing, it is understood that these are the only written warranties given by HELIODYNE, and HELIODYNE neither assumes nor authorizes anyone to assume for it any other obligation or liability in connection with the Product.

Heliodyne, Inc. • 4910 Seaport Avenue • Richmond, CA 94804
T: 510.237.9614 • F: 510.237.7018
www.heliodyne.com
Sales Inquiries: sales@heliodyne.com
Information and Support: info@heliodyne.com