



# LIST PRICE BOOK

January 2, 2018



Ask for Quality ▲ Ask for AMTROL®

## Value Added Freight Programs

### Part of the Amtrol Advantage™

Amtrol has a variety of unique and flexible freight programs designed to fit the way you do business. From a low \$3,000 Full Freight Allowed (FFA) policy, to our Pallet Freight, Fast Four™ and Quick Ship (QS) services, ordering from Amtrol has never been easier.

#### **\$3,000 Full Freight Allowed (FFA): Any Mix of Products**

- Any order attaining \$3,000 Net qualifies for FFA shipment.
- Combine Residential and Commercial products.
- Program applies to Wholesale customers for models in the US List Price Book.
- AK, HI destinations receive freight to the nearest port within the 48 contiguous states.
- Requests for partial shipments below \$3,000 are subject to prepay and add.

#### **Pallet Freight Program: Ships in Three Days**

- Full pallet quantities of Therm-X-Trol® ST-5 (75 ea.) and ST-12 (48 ea.), Therm-X-Span® T-5 (75 ea.) and T-12 (48 ea.) and Extrol® EX-15 (75 ea.) and EX-30 (48 ea.).
- Orders received by 12:00 PM EST ship FFA in three business days within the 48 contiguous states.



#### **Fast Four™ Master Packs: Small Quantities Ship in One Day**

- Four-packs of Therm-X-Trol ST-5 and ST-12, Therm-X-Span T-5 and T-12 and Extrol EX-15 and EX-30.
- Orders received by 12:00 PM EST ship FFA in one business day via UPS Ground within the 48 contiguous states.



#### **Quick Ship (QS) Program: Ships Next Day**

- Select Well-X-Trol®, Therm-X-Trol, Therm-X-Span, Extrol, Fill-Trol®, BoilerMate® and HydroMax® models listed with QS next to the lead time will ship within one business day (no need to call to check inventory).
- Add 3% to order net and specify Quick Ship service.

#### **Terms and Conditions**

- All pricing and information contained within the Amtrol 2018 List Price Book is subject to Amtrol's Terms and Conditions. To access a complete copy of the Terms and Conditions, please visit [www.amtrol.com](http://www.amtrol.com).

#### **Standard Leadtimes: Orders May Ship Early Unless Specified**

- Standard leadtime is in working days.
- \$30,000 orders and above require a minimum 10-day standard leadtime.
- Longest model standard leadtime applies to entire order.
- Large orders may be subject to longer leadtimes

All dimensions and weights listed are approximate.



# Contents

## RESIDENTIAL PRODUCTS

|   |              |
|---|--------------|
| <b>Air Purgers, Vents &amp; Valves</b> .....                                | <b>13</b>    |
| AIR PURGERS.....  | 13           |
| AIR VENTS.....  | 13           |
| MIXING VALVES.....  | 13           |
| TANK SERVICE CHECK VALVE.....   | 13           |
| <b>Expansion Tanks - Hydronic</b> .....                                     | <b>12-13</b> |
| EX MODELS: EXTROL® INLINE BOILER SYSTEM EXPANSION TANKS.....                | 12           |
| EX PACKAGES: EXTROL COMBINATION KITS.....                                   | 12           |
| FT MODELS: FILL-TROL® TANKS AND AUTOMATIC FILL VALVES.....                  | 12           |
| FT PACKAGES: FILL-TROL COMBINATION KITS.....                                | 12           |
| SX MODELS: EXTROL VERTICAL BOILER SYSTEM EXPANSION TANKS.....               | 12           |
| RX MODELS: RADIANT EXTROL® HEATING SYSTEM EXPANSION TANKS.....              | 13           |
| SE MODELS: CLOSED-LOOP SOLAR EXTROL® EXPANSION TANKS.....                   | 13           |
| <b>Expansion Tanks - Water Heater</b> .....                                 | <b>10</b>    |
| ST MODELS: THERM-X-TROL® INLINE THERMAL EXPANSION TANKS, 5-Year Warranty..  | 10           |
| ST MODELS: THERM-X-TROL VERTICAL THERMAL EXPANSION TANKS.....               | 10           |
| T MODELS: THERM-X-SPAN® INLINE THERMAL EXPANSION TANKS, 1-Year Warranty.... | 10           |
| <b>Hot Water Makers®</b> .....  | <b>14-15</b> |
| BOILERMATE® INDIRECT-FIRED WATER HEATERS.....                               | 14           |
| HOT WATER MAKER REPLACEMENT PARTS.....                                      | 14           |
| HYDROMAX® INDIRECT-FIRED WATER HEATERS.....                                 | 14           |
| PREMIER HOT WATER STORAGE TANKS.....  | 15           |
| PREMIER™ INDIRECT-FIRED WATER HEATERS.....                                  | 15           |
| <b>Pressure Boosters</b> .....  | <b>9</b>     |
| HP SERIES BOOSTER SYSTEM REPLACEMENT PARTS.....                             | 9            |
| RP MODELS: AMTROL PRESSURISER® CITY WATER PRESSURE BOOSTER SYSTEMS....      | 9            |
| <b>Retention Tanks - Epoxy-Lined</b> .....                                  | <b>8</b>     |
| ERTG MODELS: EPOXY-LINED REPLACEMENT FOR GALVANIZED TANKS, DESERT TAN..     | 8            |
| <b>Reverse Osmosis Storage Tanks</b> .....                                  | <b>7</b>     |
| RO MODELS: REVERSE OSMOSIS STORAGE TANKS.....                               | 7            |
| <b>Tube Straps &amp; Hangers</b> .....                                      | <b>11</b>    |
| <b>Water Hammer Arrestors</b> .....   | <b>10</b>    |
| <b>Well Tank Controls &amp; Accessories</b> .....                           | <b>8</b>     |
| DIGITAL PRESSURE CONTROL.....   | 8            |
| DURABASE® TANK SPACER.....  | 8            |
| PUMP MOUNTING STAND.....  | 8            |
| TOUCH-UP PAINT.....   | 8            |
| <b>Well Tanks, 125 PSI, 5-Year Warranty</b> .....                           | <b>6-7</b>   |
| CH MODELS: CHAMPION® VERTICAL STAND, DARK BLUE.....                         | 6            |
| WF MODELS: WEL-FLO® VERTICAL STAND, LIGHT GRAY.....                         | 6            |
| PL MODELS: PRO-LINE® VERTICAL STAND, TAN.....                               | 7            |
| <b>Well-X1® System Well Tank &amp; Digital Control</b> .....                | <b>6</b>     |
| WX1 MODELS: READY-TO-RUN WITH GUARDIAN CP® DIGITAL PRESSURE CONTROL....     | 6            |
| <b>Well-X-Trol® Well Tanks, 150 PSI, 7-Year Warranty</b> .....              | <b>4-6</b>   |
| WX MODELS: VERTICAL STAND.....  | 4            |
| WX MODELS: VERTICAL STAND WITH PRO ACCESS®.....                             | 4            |
| WX MODELS: HORIZONTAL.....  | 5            |
| WX MODELS: INLINE.....  | 5            |
| WX MODELS: VERTICAL WITH DURABASE® COMPOSITE STAND.....                     | 5            |
| WX MODELS: WALL HUNG WITH VFD CONTROL BRACKET.....                          | 5            |
| WX MODELS: UNDERGROUND.....   | 6            |

Letters A-K denote product categories.

Prices and contents are subject to change without notice.

Visit [www.amtrol.com](http://www.amtrol.com) to download the most current version of the List Price Book.

## COMMERCIAL PRODUCTS

|   |              |
|---|--------------|
| <b>Air &amp; Dirt Separators &amp; Inline Air Purgers</b> .....                   | <b>22</b>    |
| AIR & DIRT SEPARATORS, ASME.....  | 22           |
| INLINE AIR PURGERS.....   | 22           |
| <b>Air Separators</b> .....   | <b>20</b>    |
| TANGENTIAL AIR SEPARATORS, LESS STRAINER, ASME.....                               | 20           |
| <b>Air Separators &amp; Purgers</b> .....   | <b>21</b>    |
| TANGENTIAL AIR SEPARATORS, WITH STRAINER, ASME.....                               | 21           |
| <b>Air Vents &amp; Plain Steel Tanks</b> .....                                    | <b>23</b>    |
| AC MODELS: PLAIN STEEL COMPRESSION TANKS, ASME.....                               | 23           |
| HIGH CAPACITY AIR VENT.....   | 23           |
| <b>Chilled Water Buffer Tanks</b> .....   | <b>24</b>    |
| CWBT MODELS: CHILLED WATER BUFFER TANKS, ASME.....                                | 24           |
| <b>Commercial Accessories</b> .....   | <b>34</b>    |
| REPLACEMENT BLADDERS.....   | 34           |
| <b>Extrol® Bladder Tanks</b> .....  | <b>18-19</b> |
| L MODELS: FULL ACCEPTANCE BLADDER, TOP CONNECTION, ASME.....                      | 18           |
| LBC MODELS: PARTIAL ACCEPTANCE BLADDER, BOTTOM CONNECTION, ASME.....              | 19           |
| <b>Extrol® Diaphragm Tanks</b> .....  | <b>16-17</b> |
| AX MODELS: HORIZONTAL DIAPHRAGM TYPE, ASME.....                                   | 16           |
| AX-V MODELS: VERTICAL DIAPHRAGM TYPE, ASME.....                                   | 17           |
| <b>Fire Protection Products</b> .....   | <b>32</b>    |
| FPT MODELS: FIRE-X-TROL® SPRINKLER SYSTEM EXPANSION TANKS, 175 PSI.....           | 32           |
| SPT MODELS: SURGE-TROL® SPRINKLER SYSTEM SURGE SUPPRESSORS, 275 PSI..             | 32           |
| <b>Hot Water Buffer Tanks</b> .....   | <b>25</b>    |
| HWBT MODELS: HOT WATER BUFFER TANKS, ASME.....                                    | 25           |
| <b>Shock Suppressors &amp; Commercial Accessories</b> .....                       | <b>33</b>    |
| AC MODELS: PLAIN STEEL COMPRESSION TANKS, ASME.....                               | 33           |
| D MODELS: DIATROL® SHOCK SUPPRESSORS, 250 PSI, ASME.....                          | 33           |
| HIGH CAPACITY AIR VENT.....   | 33           |
| <b>Therm-X-Trol® Bladder Tanks</b> .....  | <b>27-28</b> |
| ST-C (ASME) and ST (NON-ASME) MODELS: FULL ACCEPTANCE BLADDER.....                | 27           |
| ST-CL (ASME) and ST-L (NON-ASME) MODELS: PARTIAL ACCEPTANCE BLADDER.....          | 28           |
| <b>Therm-X-Trol® Diaphragm Tanks</b> .....  | <b>26</b>    |
| ST MODELS: DIAPHRAGM TYPE, ASME.....  | 26           |
| <b>Well-X-Trol® Bladder Tanks</b> .....   | <b>30-31</b> |
| WX-C (ASME) and WX (NON-ASME) MODELS: FULL ACCEPTANCE BLADDER.....                | 30-31        |
| WX-CL (ASME) and WX-L (NON-ASME) MODELS: PARTIAL ACCEPTANCE BLADDER, 125 PSI..... | 31           |
| <b>Well-X-Trol® Diaphragm Tanks</b> .....   | <b>29</b>    |
| WX-C (ASME) and WX (NON-ASME) MODELS: DIAPHRAGM TYPE.....                         | 29           |
| <b>Index</b> .....  | <b>35-37</b> |
| <b>Frequently Used Part Numbers</b> .....   | <b>38-39</b> |
| <b>Quick Sizing</b> .....   | <b>40</b>    |
| <b>Notes</b> .....  | <b>41-42</b> |
| <b>Warranty</b> .....   | <b>43</b>    |

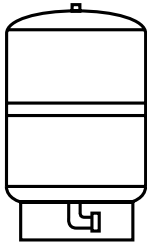
**WX MODELS: VERTICAL STAND**
**A**

**QUICK SHIP ELIGIBLE**

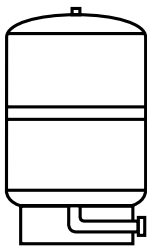
| Model Number | Description  | Volume (Gal) | Max Acceptance Factor | Shipping Dimensions (In) |    |    | Shipping Weight (Lbs) | UPC 642031 | Standard Leadtime (Days) | List Price (USD) |
|--------------|--------------|--------------|-----------------------|--------------------------|----|----|-----------------------|------------|--------------------------|------------------|
|              |              |              |                       | L                        | W  | H  |                       |            |                          |                  |
| WX-201       | BLUE         | 14           | 0.81                  | 15                       | 15 | 25 | 25                    | 644411     | 5                        | \$372.00         |
| WX-202       | BLUE         | 20           | 0.57                  | 15                       | 15 | 32 | 32                    | 644442     | 5 QS                     | \$458.00         |
| WX-202XL     | BLUE         | 26           | 0.44                  | 15                       | 15 | 39 | 39                    | 644503     | 5                        | \$483.00         |
| WX-203       | BLUE         | 32           | 0.35                  | 15                       | 15 | 47 | 47                    | 644572     | 5 QS                     | \$781.00         |
| WX-205       | BLUE         | 34           | 1.00                  | 22                       | 22 | 30 | 57                    | 644657     | 5 QS                     | \$855.00         |
| WX-250       | BLUE         | 44           | 0.77                  | 22                       | 22 | 36 | 65                    | 644718     | 5 QS                     | \$991.00         |
| WX-251       | BLUE         | 62           | 0.55                  | 22                       | 22 | 47 | 87                    | 644770     | 5 QS                     | \$1,171.00       |
| WX-255       | BLUE         | 81           | 0.41                  | 22                       | 22 | 57 | 109                   | 644862     | 5 QS                     | \$1,258.00       |
| WX-252       | BLUE (TALL)  | 86           | 0.39                  | 22                       | 22 | 62 | 107                   | 644831     | 5 QS                     | \$1,507.00       |
| WX-302       | BLUE (SHORT) | 86           | 0.54                  | 26                       | 26 | 47 | 106                   | 644947     | 5 QS                     | \$1,390.00       |
| WX-350       | BLUE         | 119          | 0.39                  | 26                       | 26 | 62 | 146                   | 645005     | 5 QS                     | \$1,980.00       |
| WX-201-T     | TAN          | 14           | 0.81                  | 15                       | 15 | 25 | 25                    | 645081     | 5                        | \$372.00         |
| WX-202-T     | TAN          | 20           | 0.57                  | 15                       | 15 | 32 | 32                    | 644459     | 5                        | \$458.00         |
| WX-202XL-T   | TAN          | 26           | 0.44                  | 15                       | 15 | 39 | 39                    | 644510     | 5                        | \$483.00         |
| WX-203-T     | TAN          | 32           | 0.35                  | 15                       | 15 | 47 | 47                    | 644589     | 5                        | \$781.00         |
| WX-205-T     | TAN          | 34           | 1.00                  | 22                       | 22 | 30 | 57                    | 644664     | 5                        | \$855.00         |
| WX-250-T     | TAN          | 44           | 0.77                  | 22                       | 22 | 36 | 65                    | 644725     | 5                        | \$991.00         |
| WX-251-T     | TAN          | 62           | 0.55                  | 22                       | 22 | 47 | 87                    | 644787     | 5                        | \$1,171.00       |
| WX-255-T     | TAN          | 81           | 0.41                  | 22                       | 22 | 57 | 109                   | 644879     | 5                        | \$1,258.00       |
| WX-302-T     | TAN          | 86           | 0.54                  | 26                       | 26 | 47 | 106                   | 644954     | 5                        | \$1,390.00       |
| WX-350-T     | TAN          | 119          | 0.39                  | 26                       | 26 | 62 | 146                   | 645012     | 5                        | \$1,980.00       |
| WX-201-G     | GRAY         | 14           | 0.81                  | 15                       | 15 | 25 | 25                    | 650634     | 5                        | \$372.00         |
| WX-202-G     | GRAY         | 20           | 0.57                  | 15                       | 15 | 32 | 32                    | 646132     | 5                        | \$458.00         |
| WX-202XL-G   | GRAY         | 26           | 0.44                  | 15                       | 15 | 39 | 39                    | 646149     | 5                        | \$483.00         |
| WX-203-G     | GRAY         | 32           | 0.35                  | 15                       | 15 | 47 | 47                    | 646156     | 5                        | \$781.00         |
| WX-205-G     | GRAY         | 34           | 1.00                  | 22                       | 22 | 30 | 57                    | 646163     | 5                        | \$855.00         |
| WX-250-G     | GRAY         | 44           | 0.77                  | 22                       | 22 | 36 | 65                    | 646170     | 5                        | \$991.00         |
| WX-251-G     | GRAY         | 62           | 0.55                  | 22                       | 22 | 47 | 87                    | 646187     | 5                        | \$1,171.00       |
| WX-255-G     | GRAY         | 81           | 0.41                  | 22                       | 22 | 57 | 109                   | 646194     | 5                        | \$1,258.00       |
| WX-302-G     | GRAY         | 86           | 0.54                  | 26                       | 26 | 47 | 106                   | 646200     | 5                        | \$1,390.00       |
| WX-350-G     | GRAY         | 119          | 0.39                  | 26                       | 26 | 62 | 146                   | 646217     | 5                        | \$1,980.00       |

**WX MODELS: VERTICAL STAND WITH PRO ACCESS®**
**A**

|            |      |     |      |    |    |    |     |        |   |            |
|------------|------|-----|------|----|----|----|-----|--------|---|------------|
| WX-202PA   | BLUE | 20  | 0.57 | 15 | 15 | 32 | 33  | 644473 | 5 | \$491.00   |
| WX-202XLP  | BLUE | 26  | 0.44 | 15 | 15 | 39 | 40  | 644541 | 5 | \$518.00   |
| WX-203PA   | BLUE | 32  | 0.35 | 15 | 15 | 47 | 48  | 644602 | 5 | \$841.00   |
| WX-205PA   | BLUE | 34  | 1.00 | 22 | 22 | 30 | 59  | 644688 | 5 | \$919.00   |
| WX-250PA   | BLUE | 44  | 0.77 | 22 | 22 | 36 | 67  | 644749 | 5 | \$1,063.00 |
| WX-251PA   | BLUE | 62  | 0.55 | 22 | 22 | 47 | 88  | 644800 | 5 | \$1,255.00 |
| WX-255PA   | BLUE | 81  | 0.41 | 22 | 22 | 57 | 111 | 644893 | 5 | \$1,347.00 |
| WX-302PA   | BLUE | 86  | 0.54 | 26 | 26 | 47 | 108 | 644978 | 5 | \$1,486.00 |
| WX-350PA   | BLUE | 119 | 0.39 | 26 | 26 | 62 | 148 | 645036 | 5 | \$2,115.00 |
| WX-202PA-T | TAN  | 20  | 0.57 | 15 | 15 | 32 | 33  | 644480 | 5 | \$491.00   |
| WX-202XLP  | TAN  | 26  | 0.44 | 15 | 15 | 39 | 40  | 644558 | 5 | \$518.00   |
| WX-203PA-T | TAN  | 32  | 0.35 | 15 | 15 | 47 | 48  | 644619 | 5 | \$841.00   |
| WX-205PA-T | TAN  | 34  | 1.00 | 22 | 22 | 30 | 59  | 644695 | 5 | \$919.00   |
| WX-250PA-T | TAN  | 44  | 0.77 | 22 | 22 | 36 | 67  | 644756 | 5 | \$1,063.00 |
| WX-251PA-T | TAN  | 62  | 0.55 | 22 | 22 | 47 | 88  | 644817 | 5 | \$1,255.00 |
| WX-255PA-T | TAN  | 81  | 0.41 | 22 | 22 | 57 | 111 | 644909 | 5 | \$1,347.00 |
| WX-302PA-T | TAN  | 86  | 0.54 | 26 | 26 | 47 | 108 | 644985 | 5 | \$1,486.00 |
| WX-350PA-T | TAN  | 119 | 0.39 | 26 | 26 | 62 | 148 | 645043 | 5 | \$2,115.00 |
| WX-202PA-G | GRAY | 20  | 0.57 | 15 | 15 | 32 | 33  | 646224 | 5 | \$491.00   |
| WX-202XLP  | GRAY | 26  | 0.44 | 15 | 15 | 39 | 40  | 646231 | 5 | \$518.00   |
| WX-203PA-G | GRAY | 32  | 0.35 | 15 | 15 | 47 | 48  | 646248 | 5 | \$841.00   |
| WX-205PA-G | GRAY | 34  | 1.00 | 22 | 22 | 30 | 59  | 646255 | 5 | \$919.00   |
| WX-250PA-G | GRAY | 44  | 0.77 | 22 | 22 | 36 | 67  | 646262 | 5 | \$1,063.00 |
| WX-251PA-G | GRAY | 62  | 0.55 | 22 | 22 | 47 | 88  | 646279 | 5 | \$1,255.00 |
| WX-255PA-G | GRAY | 81  | 0.41 | 22 | 22 | 57 | 111 | 646286 | 5 | \$1,347.00 |
| WX-302PA-G | GRAY | 86  | 0.54 | 26 | 26 | 47 | 108 | 646293 | 5 | \$1,486.00 |
| WX-350PA-G | GRAY | 119 | 0.39 | 26 | 26 | 62 | 148 | 646309 | 5 | \$2,115.00 |

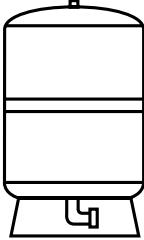
**WX MODELS: VERTICAL WITH DURABASE® COMPOSITE STAND**
**A**

| Model Number  | Description | Volume (Gal) | Max Acceptance Factor | Shipping Dimensions (In) |    |    | Shipping Weight (Lbs) | UPC 642031 | Standard Leadtime (Days) | List Price (USD) |            |
|---|-------------|--------------|-----------------------|--------------------------|----|----|-----------------------|------------|--------------------------|------------------|------------|
|   |             |              |                       | L                        | W  | H  |                       |            |                          |                  |            |
|  | WX-201D     | BLUE         | 14                    | 0.81                     | 15 | 15 | 25                    | 25         | 645159                   | 5                | \$372.00   |
|   | WX-202D     | BLUE         | 20                    | 0.57                     | 15 | 15 | 32                    | 32         | 645173                   | 5                | \$458.00   |
|   | WX-202XLD   | BLUE         | 26                    | 0.44                     | 15 | 15 | 39                    | 39         | 645210                   | 5                | \$483.00   |
|   | WX-203D     | BLUE         | 32                    | 0.35                     | 15 | 15 | 47                    | 47         | 645241                   | 5                | \$781.00   |
|   | WX-205D     | BLUE         | 34                    | 1.00                     | 22 | 22 | 30                    | 57         | 645289                   | 5                | \$855.00   |
|   | WX-250D     | BLUE         | 44                    | 0.77                     | 22 | 22 | 36                    | 65         | 645319                   | 5                | \$991.00   |
|   | WX-251D     | BLUE         | 62                    | 0.55                     | 22 | 22 | 47                    | 87         | 645340                   | 5                | \$1,171.00 |
|   | WX-255D     | BLUE         | 81                    | 0.41                     | 22 | 22 | 57                    | 109        | 645371                   | 5                | \$1,258.00 |
|   | WX-302D     | BLUE         | 86                    | 0.54                     | 26 | 26 | 47                    | 106        | 645418                   | 5                | \$1,390.00 |
|   | WX-350D     | BLUE         | 119                   | 0.39                     | 26 | 26 | 62                    | 146        | 645449                   | 5                | \$1,980.00 |
| WX-201D-T   | TAN         | 14           | 0.81                  | 15                       | 15 | 25 | 25                    | 645166     | 5                        | \$372.00         |            |
| WX-202D-T   | TAN         | 20           | 0.57                  | 15                       | 15 | 32 | 32                    | 645197     | 5                        | \$458.00         |            |
| WX-202XLD-T   | TAN         | 26           | 0.44                  | 15                       | 15 | 39 | 39                    | 645227     | 5                        | \$483.00         |            |
| WX-203D-T   | TAN         | 32           | 0.35                  | 15                       | 15 | 47 | 47                    | 645258     | 5                        | \$781.00         |            |
| WX-205D-T   | TAN         | 34           | 1.00                  | 22                       | 22 | 30 | 57                    | 645296     | 5                        | \$855.00         |            |
| WX-250D-T   | TAN         | 44           | 0.77                  | 22                       | 22 | 36 | 65                    | 645326     | 5                        | \$991.00         |            |
| WX-251D-T   | TAN         | 62           | 0.55                  | 22                       | 22 | 47 | 87                    | 645357     | 5                        | \$1,171.00       |            |
| WX-255D-T   | TAN         | 81           | 0.41                  | 22                       | 22 | 57 | 109                   | 645388     | 5                        | \$1,258.00       |            |
| WX-302D-T   | TAN         | 86           | 0.54                  | 26                       | 26 | 47 | 106                   | 645425     | 5                        | \$1,390.00       |            |
| WX-350D-T   | TAN         | 119          | 0.39                  | 26                       | 26 | 62 | 146                   | 645456     | 5                        | \$1,980.00       |            |
| WX-201D-G   | GRAY        | 14           | 0.81                  | 15                       | 15 | 25 | 25                    | 648686     | 5                        | \$372.00         |            |
| WX-202D-G   | GRAY        | 20           | 0.57                  | 15                       | 15 | 32 | 32                    | 648693     | 5                        | \$458.00         |            |
| WX-202XLD-G   | GRAY        | 26           | 0.44                  | 15                       | 15 | 39 | 39                    | 648709     | 5                        | \$483.00         |            |
| WX-203D-G   | GRAY        | 32           | 0.35                  | 15                       | 15 | 47 | 47                    | 648716     | 5                        | \$781.00         |            |
| WX-205D-G   | GRAY        | 34           | 1.00                  | 22                       | 22 | 30 | 57                    | 648723     | 5                        | \$855.00         |            |
| WX-250D-G   | GRAY        | 44           | 0.77                  | 22                       | 22 | 36 | 65                    | 648730     | 5                        | \$991.00         |            |
| WX-251D-G   | GRAY        | 62           | 0.55                  | 22                       | 22 | 47 | 87                    | 648747     | 5                        | \$1,171.00       |            |
| WX-255D-G   | GRAY        | 81           | 0.41                  | 22                       | 22 | 57 | 109                   | 648754     | 5                        | \$1,258.00       |            |
| WX-302D-G   | GRAY        | 86           | 0.54                  | 26                       | 26 | 47 | 106                   | 648761     | 5                        | \$1,390.00       |            |
| WX-350D-G   | GRAY        | 119          | 0.39                  | 26                       | 26 | 62 | 146                   | 648778     | 5                        | \$1,980.00       |            |

**WX MODELS: INLINE**
**A**

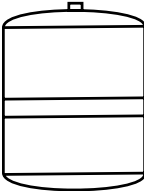
|   |          |      |      |      |    |    |    |    |        |      |          |
|---|----------|------|------|------|----|----|----|----|--------|------|----------|
| <br><b>QUICK SHIP ELIGIBLE</b> | WX-101   | BLUE | 2.0  | 0.45 | 8  | 8  | 13 | 5  | 644053 | 5 QS | \$116.00 |
|   | WX-102   | BLUE | 4.4  | 0.55 | 11 | 11 | 15 | 9  | 644084 | 5 QS | \$158.00 |
|   | WX-103   | BLUE | 7.6  | 0.43 | 11 | 11 | 22 | 15 | 644114 | 5 QS | \$258.00 |
|   | WX-104   | BLUE | 10.3 | 1.00 | 15 | 15 | 18 | 20 | 644145 | 5    | \$287.00 |
|   | WX-200   | BLUE | 14.0 | 0.81 | 15 | 15 | 22 | 22 | 644169 | 5    | \$305.00 |
|   | WX-101-G | GRAY | 2.0  | 0.45 | 8  | 8  | 13 | 5  | 646118 | 5    | \$116.00 |
|   | WX-102-G | GRAY | 4.4  | 0.55 | 11 | 11 | 15 | 9  | 646125 | 5    | \$158.00 |
|   | WX-103-G | GRAY | 7.6  | 0.43 | 11 | 11 | 22 | 15 | 650603 | 5    | \$258.00 |
|   | WX-104-G | GRAY | 10.3 | 1.00 | 15 | 15 | 18 | 20 | 650610 | 5    | \$287.00 |
|   | WX-200-G | GRAY | 14.0 | 0.81 | 15 | 15 | 22 | 22 | 650627 | 5    | \$305.00 |

**WX MODELS: HORIZONTAL**
**A**

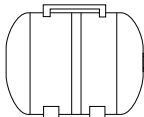
|   |          |                      |      |      |    |    |    |    |        |   |          |
|---|----------|----------------------|------|------|----|----|----|----|--------|---|----------|
|  | WX-102PS | BLUE WITH PUMP STAND | 4.4  | 0.55 | 15 | 11 | 12 | 13 | 644190 | 5 | \$240.00 |
|   | WX-105PS | BLUE WITH PUMP STAND | 5.3  | 0.80 | 18 | 11 | 12 | 15 | 644220 | 5 | \$313.00 |
|   | WX-110PS | BLUE WITH PUMP STAND | 7.4  | 0.56 | 23 | 11 | 12 | 18 | 649102 | 5 | \$315.00 |
|   | WX-200PS | BLUE WITH PUMP STAND | 14.0 | 0.81 | 22 | 15 | 16 | 29 | 644268 | 5 | \$548.00 |
|   | WX-202PS | BLUE WITH PUMP STAND | 20.0 | 0.57 | 30 | 15 | 16 | 35 | 649119 | 5 | \$687.00 |
|   | WX-202H  | BLUE W/O PUMP STAND  | 20.0 | 0.57 | 30 | 15 | 16 | 33 | 644299 | 5 | \$483.00 |

**WX MODELS: WALL HUNG WITH VFD CONTROL BRACKET**
**A**

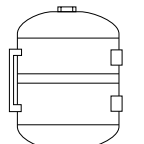
|   |           |                       |     |      |    |    |    |    |        |   |          |
|---|-----------|-----------------------|-----|------|----|----|----|----|--------|---|----------|
|  | WX-102VFD | BLUE WITH VFD BRACKET | 4.4 | 0.55 | 15 | 11 | 12 | 13 | 649454 | 5 | \$277.00 |
|---|-----------|-----------------------|-----|------|----|----|----|----|--------|---|----------|

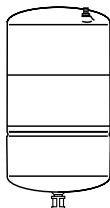
**WX MODELS: UNDERGROUND**
**A**

| Model Number | Description        | Volume (Gal) | Max Acceptance Factor | Shipping Dimensions (In) |    |    | Shipping Weight (Lbs) | UPC 642031 | Standard Leadtime (Days) | List Price (USD) |
|--------------|--------------------|--------------|-----------------------|--------------------------|----|----|-----------------------|------------|--------------------------|------------------|
|              |                    |              |                       | L                        | W  | H  |                       |            |                          |                  |
| WX-200UG     | SPECIAL UG COATING | 14           | 0.81                  | 15                       | 15 | 23 | 22                    | 644312     | 5                        | \$473.00         |
| WX-202UG     | SPECIAL UG COATING | 20           | 0.57                  | 15                       | 15 | 30 | 30                    | 644336     | 5                        | \$682.00         |
| WX-250UG     | SPECIAL UG COATING | 44           | 0.77                  | 22                       | 22 | 33 | 60                    | 644367     | 5                        | \$1,323.00       |
| WX-251UG     | SPECIAL UG COATING | 62           | 0.55                  | 22                       | 22 | 44 | 83                    | 644381     | 5                        | \$1,573.00       |

## Well-X1® System Well Tank & Digital Control

**WX1 MODELS: READY-TO-RUN WITH GUARDIAN CP® DIGITAL PRESSURE CONTROL**
**A**

|          |      |    |      |    |    |    |     |        |    |            |
|----------|------|----|------|----|----|----|-----|--------|----|------------|
| WX1-250D | BLUE | 44 | 0.77 | 22 | 22 | 44 | 80  | 650238 | 10 | \$1,544.00 |
| WX1-251D | BLUE | 62 | 0.55 | 22 | 22 | 55 | 103 | 650221 | 10 | \$1,726.00 |
| WX1-302D | BLUE | 86 | 0.54 | 26 | 26 | 55 | 134 | 650214 | 10 | \$1,945.00 |

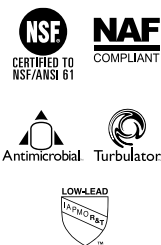

**Pallet Quantity:** WX-101: 75, WX-102: 48, WX-103: 32, WX-104 & WX-200: 18  
 WX-102-PS: 32, WX-105-PS: 72, WX-110PS: 32, WX-200-PS: 18, WX-202PS: 18  
 WX-200UG & WX-202UG: 18, WX-250UG & WX-251UG: 4  
 WX-201 and WX-202: 18, WX-202XL & WX-203: 9, WX-205 through WX-350: 4

**Connection:** Stainless Steel: WX-101 through WX-103, WX-102PS through WX-110PS: 3/4" NPTM, WX-104, WX-200, WX-200PS, WX-202PS and WX-202H: 1" NPTM, WX-200UG, WX-202UG and WX-201 through WX-203: 1" NPTF, WX-205 through WX-350, WX250UG and WX-251UG: 1-1/4" NPTF

**Factory Precharge:** All WX and WX1 Models: 38 PSI

**Working Pressure:** All WX and WX1 Models: except WX-252: 150 PSI; WX252: 100 PSI

**Warranty:** All WX Models: 7-Year Limited; WX1: 7-Year Limited (Tank), 2-Year Limited (Control).

## Well Tanks, 125 PSI, 5-Year Warranty

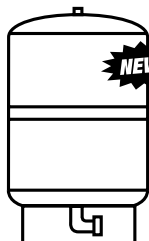
**CH MODELS: CHAMPION® VERTICAL STAND, DARK BLUE**
**A**

| Model Number | Description | Volume (Gal) | Max Acceptance Factor | Shipping Dimensions (In) |    |    | Shipping Weight (Lbs) | UPC 642031 | Standard Leadtime (Days) | List Price (USD) |
|--------------|-------------|--------------|-----------------------|--------------------------|----|----|-----------------------|------------|--------------------------|------------------|
|              |             |              |                       | L                        | W  | H  |                       |            |                          |                  |
| CH-14        | CH3001      | 14           | 0.81                  | 15                       | 15 | 25 | 22                    | 530295     | 10                       | \$340.00         |
| CH-20        | CH4202      | 20           | 0.57                  | 15                       | 15 | 32 | 28                    | 529329     | 10                       | \$443.00         |
| CH-26        | CH6000      | 26           | 0.44                  | 15                       | 15 | 39 | 34                    | 550798     | 10                       | \$469.00         |
| CH-32        | CH8003      | 32           | 0.35                  | 15                       | 15 | 47 | 40                    | 530318     | 10                       | \$757.00         |
| CH-34        | CH8205      | 34           | 1.00                  | 22                       | 22 | 30 | 50                    | 530332     | 10                       | \$831.00         |
| CH-44        | CH10050     | 44           | 0.77                  | 22                       | 22 | 36 | 57                    | 530257     | 10                       | \$959.00         |
| CH-62        | CH12051     | 62           | 0.55                  | 22                       | 22 | 47 | 75                    | 530264     | 10                       | \$1,131.00       |
| CH-81        | CH17255     | 81           | 0.41                  | 22                       | 22 | 57 | 92                    | 550705     | 10                       | \$1,217.00       |
| CH-86        | CH17002     | 86           | 0.54                  | 26                       | 26 | 47 | 99                    | 530271     | 10                       | \$1,345.00       |
| CH-119       | CH22050     | 119          | 0.39                  | 26                       | 26 | 62 | 133                   | 530288     | 10                       | \$1,918.00       |

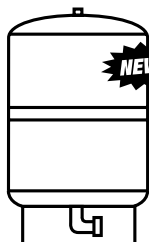
**WF MODELS: WEL-FLO® VERTICAL STAND, LIGHT GRAY**
**A**

|        |       |     |      |    |    |    |     |        |    |            |
|--------|-------|-----|------|----|----|----|-----|--------|----|------------|
| WF-14  | WF45  | 14  | 0.81 | 15 | 15 | 25 | 22  | 406736 | 10 | \$340.00   |
| WF-20  | WF60  | 20  | 0.57 | 15 | 15 | 32 | 28  | 406767 | 10 | \$443.00   |
| WF-26  | WF80  | 26  | 0.44 | 15 | 15 | 39 | 34  | 550828 | 10 | \$469.00   |
| WF-32  | WF100 | 32  | 0.35 | 15 | 15 | 47 | 40  | 406620 | 10 | \$757.00   |
| WF-34  | WF110 | 34  | 1.00 | 22 | 22 | 30 | 50  | 406637 | 10 | \$831.00   |
| WF-44  | WF140 | 44  | 0.77 | 22 | 22 | 36 | 57  | 406651 | 10 | \$959.00   |
| WF-62  | WF200 | 62  | 0.55 | 22 | 22 | 47 | 75  | 406675 | 10 | \$1,131.00 |
| WF-81  | WF255 | 81  | 0.41 | 22 | 22 | 57 | 92  | 550675 | 10 | \$1,217.00 |
| WF-86  | WF260 | 86  | 0.54 | 26 | 26 | 47 | 99  | 406699 | 10 | \$1,345.00 |
| WF-119 | WF360 | 119 | 0.39 | 26 | 26 | 62 | 133 | 406705 | 10 | \$1,918.00 |

## PL MODELS: PRO-LINE® VERTICAL STAND, TAN A

| Model Number | Description | Volume (Gal)    | Max Acceptance Factor | Shipping Dimensions (In) |    |    | Shipping Weight (Lbs) | UPC 642031 | Standard Leadtime (Days) | List Price (USD) |            |
|--------------|-------------|-----------------|-----------------------|--------------------------|----|----|-----------------------|------------|--------------------------|------------------|------------|
|              |             |                 |                       | L                        | W  | H  |                       |            |                          |                  |            |
|              | PL-14       | CA3001          | 14                    | 0.81                     | 15 | 15 | 25                    | 22         | 409935                   | 10               | \$340.00   |
|              | PL-20       | CA4202          | 20                    | 0.57                     | 15 | 15 | 32                    | 28         | 409942                   | 10               | \$443.00   |
|              | PL-26       | CA6000          | 26                    | 0.44                     | 15 | 15 | 39                    | 34         | 550804                   | 10               | \$469.00   |
|              | PL-32       | CA8003          | 32                    | 0.35                     | 15 | 15 | 47                    | 40         | 409959                   | 10               | \$757.00   |
|              | PL-34       | CA8205          | 34                    | 1.00                     | 22 | 22 | 30                    | 50         | 400024                   | 10               | \$831.00   |
|              | PL-44       | CA10050         | 44                    | 0.77                     | 22 | 22 | 36                    | 57         | 399984                   | 10               | \$959.00   |
|              | PL-62       | CA12051         | 62                    | 0.55                     | 22 | 22 | 47                    | 75         | 399991                   | 10               | \$1,131.00 |
|              | PL-81       | CA17255         | 81                    | 0.41                     | 22 | 22 | 57                    | 92         | 550712                   | 10               | \$1,217.00 |
|              | PL-86       | CA17002 (SHORT) | 86                    | 0.54                     | 26 | 26 | 47                    | 99         | 660008                   | 10               | \$1,345.00 |
|              | PL-119      | CA22050         | 119                   | 0.39                     | 26 | 26 | 62                    | 133        | 400017                   | 10               | \$1,918.00 |



**Pallet Quantity:** 14 & 20 Gal: 18, 26 & 32 Gal: 9, 34 through 119 Gal: 4  
**Connection:** Stainless Steel: 14 through 32 Gal: 1" NPTF, 34 through 119 Gal: 1-1/4" NPTF  
**Factory Precharge:** All CH, WF & PL Models: 38 PSI  
**Working Pressure:** CH, WF & PL: 125 PSI  
**Warranty:** All CH, WF & PL Models: 5-Year Limited



## Reverse Osmosis Storage Tanks

### RO MODELS: REVERSE OSMOSIS STORAGE TANKS A

| Model Number | Description | Color | PSI    | Other            | Total Volume (Gal) | Connection Size (In) | Shipping Weight (Lbs) | UPC 642031 | Standard Leadtime* (Days) | List Price (USD) |  |
|--------------|-------------|-------|--------|------------------|--------------------|----------------------|-----------------------|------------|---------------------------|------------------|--|
|              |             |       |        |                  |                    |                      |                       |            |                           |                  |  |
| RO-2         | 140-653     | BLUE  | 20 PS  | PLASTIC STAND    | 2                  | 1/4                  | 5                     | 123077     | 10                        | \$180.00         |  |
| RO-3         | 140S723     | WHITE | 5 PSI  | PLASTIC STAND    | 3                  | 1/4                  | 7                     | 462855     | 10                        | \$163.00         |  |
| RO-3         | 140S725     | WHITE | 5 PSI  | BUMP BASE        | 3                  | 1/4                  | 7                     | 578808     | 10                        | \$163.00         |  |
| RO-4         | 141S343     | BLUE  | 5 PSI  | PLASTIC STAND    | 4                  | 1/4                  | 9                     | 462862     | 10                        | \$245.00         |  |
| RO-4         | 141S344     | WHITE | 5 PSI  | PLASTIC STAND    | 4                  | 1/4                  | 9                     | 462879     | 10                        | \$245.00         |  |
| RO-4         | 141S351     | WHITE | 5 PSI  | BUMP BASE        | 4                  | 1/4                  | 9                     | 527165     | 10                        | \$245.00         |  |
| RO-4         | 141S352     | BLUE  | 5 PSI  | BUMP BASE        | 4                  | 1/4                  | 9                     | 528179     | 10                        | \$245.00         |  |
| RO-10        | 143-132     | BLUE  | 5 PSI  | PLASTIC STAND    | 10                 | 3/4                  | 20                    | 129116     | 10                        | \$467.00         |  |
| RO-14        | 143-198     | BLUE  | 15 PSI |                  | 14                 | 3/4                  | 24                    | 129710     | 10                        | \$499.00         |  |
| RO-14        | 143-293     | BLUE  | 15 PSI |                  | 14                 | 1/4                  | 24                    | 391490     | 10                        | \$499.00         |  |
| RO-20PA      | 144-251     | BLUE  | 15 PSI | PRO ACCESS® CONN | 20                 | 3/4                  | 32                    | 563026     | 10                        | \$603.00         |  |
| RO-20        | 144-120     | BLUE  | 15 PSI |                  | 20                 | 3/4                  | 32                    | 130716     | 10                        | \$563.00         |  |
| RO-34PA      | 147-220     | BLUE  | 15 PSI | PRO ACCESS CONN  | 34                 | 1-1/4                | 61                    | 563033     | 10                        | \$1,129.00       |  |
| RO-34        | 147-47      | BLUE  | 15 PSI |                  | 34                 | 1-1/4                | 61                    | 138293     | 10                        | \$1,056.00       |  |
| RO-44PA      | 147-221     | BLUE  | 15 PSI | PRO ACCESS CONN  | 44                 | 1-1/4                | 86                    | 563040     | 10                        | \$1,220.00       |  |
| RO-44        | 147-69      | BLUE  | 15 PSI |                  | 44                 | 1-1/4                | 86                    | 138422     | 10                        | \$1,130.00       |  |
| RO-86PA      | 150-86      | BLUE  | 15 PSI | PRO ACCESS CONN  | 86                 | 1-1/4                | 123                   | 563057     | 10                        | \$1,828.00       |  |
| RO-86        | 150-6       | BLUE  | 15 PSI |                  | 86                 | 1-1/4                | 123                   | 139931     | 10                        | \$1,713.00       |  |
| RO-119PA     | 151-57      | BLUE  | 15 PSI | PRO ACCESS CONN  | 119                | 1-1/4                | 166                   | 563064     | 10                        | \$2,605.00       |  |

\*Order quantities over 100 each require a 15 day lead time



**Pallet Quantity:** RO-2: 75, RO-3: 60, RO-4: 48, RO-10 through 20: 18, RO-34 through 119: 4  
**Connection:** Stainless Steel  
**Warranty:** 5-Year Limited

## ERTG MODELS: EPOXY-LINED REPLACEMENT FOR GALVANIZED TANKS, DESERT TAN

**A**

| Model Number | Description | Volume (Gal) | Shipping Dimensions (In) |    |    | Shipping Weight (Lbs) | UPC 642031 | Standard Leadtime (Days) | List Price (USD) |
|--------------|-------------|--------------|--------------------------|----|----|-----------------------|------------|--------------------------|------------------|
|              |             |              | L                        | W  | H  |                       |            |                          |                  |
| ERTG-12A     |             | 12           | 12                       | 12 | 26 | 31                    | 684790     | 10                       | \$320.00         |
| ERTG-21A     |             | 21           | 16                       | 16 | 27 | 45                    | 684806     | 10                       | \$334.00         |
| ERTG-30A     |             | 30           | 16                       | 16 | 39 | 60                    | 684813     | 10                       | \$416.00         |
| ERTG-42TA    | TALL        | 42           | 16                       | 16 | 53 | 77                    | 684820     | 10                       | \$380.00         |
| ERTG-42SA    | SHORT       | 42           | 20                       | 20 | 36 | 70                    | 684837     | 10                       | \$401.00         |
| ERTG-82A     |             | 82           | 20                       | 20 | 64 | 112                   | 684844     | 10                       | \$555.00         |
| ERTG-120A    |             | 120          | 24                       | 24 | 66 | 142                   | 684851     | 10                       | \$734.00         |
| ERTG-220A    |             | 220          | 30                       | 30 | 78 | 346                   | 636249     | 10                       | \$1,850.00       |
| ERTG-315A    |             | 315          | 36                       | 36 | 78 | 453                   | 684868     | 10                       | \$2,578.00       |

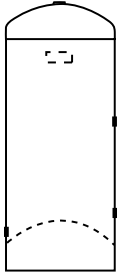
**Warranty:** 3-Year Limited

## Well Tank Controls & Accessories

### DIGITAL PRESSURE CONTROL

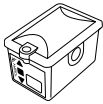

|          |                                       |   |   |   |   |        |   |          |
|----------|---------------------------------------|---|---|---|---|--------|---|----------|
| 146-832  | GUARDIAN CP® DIGITAL PRESSURE CONTROL | 4 | 8 | 4 | 2 | 639889 | 1 | \$245.00 |
| 146-2350 | EXTERNAL GROUNDING KIT                | 2 | 2 | 2 | 1 | 638748 | 5 | \$80.50  |

### DURABASE® TANK SPACER



|             |  |    |    |   |   |        |   |         |
|-------------|--|----|----|---|---|--------|---|---------|
| DURABASE-15 | FITS AMTROL 15" STEEL STAND MODELS       | 16 | 16 | 6 | 2 | 648433 | 5 | \$27.20 |
| DURABASE-22 | FITS AMTROL 22" & 26" STEEL STAND MODELS | 23 | 23 | 7 | 3 | 648440 | 5 | \$35.40 |

### PUMP MOUNTING STAND



|        |                          |   |    |   |   |              |   |         |
|--------|--------------------------|---|----|---|---|--------------|---|---------|
| UNVDKT | UNIVERSAL VERTICAL TANKS | 8 | 10 | 3 | 3 | 049708018405 | 5 | \$54.10 |
|--------|--------------------------|---|----|---|---|--------------|---|---------|

### TOUCH-UP PAINT

|         |                                |   |   |   |   |        |   |         |
|---------|--------------------------------|---|---|---|---|--------|---|---------|
| 140-127 | WELL-X-TROL® BLUE 4.5 OZ SPRAY | 2 | 2 | 4 | 1 | 121486 | 5 | \$29.70 |
|---------|--------------------------------|---|---|---|---|--------|---|---------|

**Warranty:** Guardian CP: 2-Year Limited, All Well Tank Accessories: 1-Year Limited



## RP MODELS: AMTROL PRESSURISER® CITY WATER PRESSURE BOOSTER SYSTEMS D

| Model Number | Description           | Volume (Gal) | Shipping Dimensions (In) |    |    | Shipping Weight (Lbs) | UPC 642031 | Standard Leadtime (Days) | List Price (USD) |
|--------------|-----------------------|--------------|--------------------------|----|----|-----------------------|------------|--------------------------|------------------|
|              |                       |              | L                        | W  | H  |                       |            |                          |                  |
| RP-10HP      | 2201-37 10 GPM SYSTEM | 14           | 17                       | 17 | 30 | 50                    | 574732     | 5                        | \$1,631.00       |
| RP-15HP      | 2201-39 15 GPM SYSTEM | 20           | 17                       | 17 | 38 | 55                    | 574886     | 5                        | \$1,750.00       |
| RP-25HP      | 2201-28 25 GPM SYSTEM | 34           | 22                       | 22 | 39 | 90                    | 499295     | 5                        | \$2,569.00       |

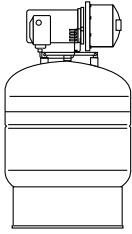



## HP SERIES BOOSTER SYSTEM REPLACEMENT PARTS I

|          |                                      |    |  |  |  |    |        |   |            |
|----------|--------------------------------------|----|--|--|--|----|--------|---|------------|
| 245-59   | PUMP RP-10HP                         |    |  |  |  | 23 | 593467 | 1 | \$1,163.00 |
| 245-60   | PUMP RP-15HP                         |    |  |  |  | 23 | 593474 | 1 | \$1,163.00 |
| 245-61   | PUMP RP-25HP                         |    |  |  |  | 23 | 593481 | 1 | \$1,163.00 |
| 2201R37  | TANK RP-10                           | 14 |  |  |  | 25 | 618634 | 1 | \$794.00   |
| 2201R39  | TANK RP-15                           | 20 |  |  |  | 33 | 618658 | 1 | \$824.00   |
| 2201R28  | TANK RP-25                           | 34 |  |  |  | 61 | 618719 | 1 | \$1,088.00 |
| 2201N002 | SHAFT SEAL KIT - All Models          |    |  |  |  | 1  | 447371 | 1 | \$38.70    |
| 2201N003 | IMPELLER RP-10                       |    |  |  |  | 1  | 447418 | 1 | \$130.00   |
| 2201N020 | IMPELLER RP-15                       |    |  |  |  | 1  | 447425 | 1 | \$111.00   |
| 2201N021 | IMPELLER RP-25                       |    |  |  |  | 1  | 447432 | 1 | \$120.00   |
| 2201N006 | O-RING REBUILD KIT - All Models      |    |  |  |  | 1  | 447401 | 1 | \$95.80    |
| 2201N010 | PUMP VENTURI - All Models            |    |  |  |  | 1  | 466655 | 1 | \$85.10    |
| 2201N022 | PUMP GUIDE VANE - All Models         |    |  |  |  | 1  | 447449 | 1 | \$73.50    |
| 113-3    | GUARDIAN CP® UPGRADE KIT             |    |  |  |  | 2  | 645654 | 1 | \$442.00   |
| 146-832  | GUARDIAN CP DIGITAL PRESSURE CONTROL |    |  |  |  | 2  | 639899 | 1 | \$245.00   |

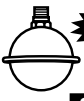

**Pallet Quantity:** RP-10HP through RP-25HP: 4  
**Connection:** Stainless Steel: RP-10HP through RP-25HP: 1-1/4" NPTF In, 1" NPTF Out  
**Warranty:** RP-10HP through RP-25HP: 2-Year Limited, Guardian CP: 2-Year Limited, All Replacement Parts: 1 Year Limited

**ST MODELS: THERM-X-TROL® INLINE THERMAL EXPANSION TANKS, 5-Year Warranty**
**B**

| Model Number  | Description                  | Volume (Gal) | Max Acceptance Volume (Gal) | Shipping Dimensions (In) |     |    | Shipping Weight (Lbs) | UPC 642031 | Standard Leadtime (Days) | List Price (USD) |
|---|------------------------------|--------------|-----------------------------|--------------------------|-----|----|-----------------------|------------|--------------------------|------------------|
|   |                              |              |                             | L                        | W   | H  |                       |            |                          |                  |
|  <b>NEW!</b>               | ST-1 140P01 MATTE TAN        | —            | —                           | 3.4                      | 3.4 | 4  | 1                     | 679932     | 5 QS                     | \$27.50          |
|   | ST-5 140N43 HIGH-GLOSS TAN   | 2.0          | 0.9                         | 8                        | 8   | 13 | 5                     | 395665     | 5 QS                     | \$80.00          |
|   | ST-8 140N738 HIGH-GLOSS TAN  | 3.2          | 1.9                         | 9                        | 9   | 15 | 7                     | 551405     | 5                        | \$93.60          |
|   | ST-12 141N43 HIGH-GLOSS TAN  | 4.4          | 3.2                         | 11                       | 11  | 15 | 9                     | 395672     | 5 QS                     | \$107.00         |
|  <b>QUICK SHIP ELIGIBLE</b> | ST-5-FF 140N43-FF FAST FOUR  | 2.0          | 0.9                         | 17                       | 17  | 13 | 20                    | 639349     | 1FF                      | \$320.00         |
| <b>FAST FOUR</b>  | ST-12-FF 141N43-FF FAST FOUR | 4.4          | 3.2                         | 24                       | 24  | 17 | 36                    | 639370     | 1FF                      | \$428.00         |
| <b>NEW!</b>   | <i>4PC MASTER PACK</i>       |              |                             |                          |     |    |                       |            |                          |                  |

**ST MODELS: THERM-X-TROL VERTICAL THERMAL EXPANSION TANKS**
**B**

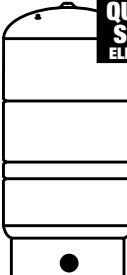
| Model Number  | Description         | Volume (Gal) | Max Acceptance Volume (Gal) | Shipping Dimensions (In) |    |    | Shipping Weight (Lbs) | UPC 642031 | Standard Leadtime (Days) | List Price (USD) |
|---|---------------------|--------------|-----------------------------|--------------------------|----|----|-----------------------|------------|--------------------------|------------------|
|   |                     |              |                             | L                        | W  | H  |                       |            |                          |                  |
|  <b>QUICK SHIP ELIGIBLE</b> | ST-25V 143N164 TAN  | 10.3         | 10.3                        | 15                       | 15 | 19 | 23                    | 395689     | 5 QS                     | \$314.00         |
|   | ST-30V 143N273 TAN  | 14.0         | 11.3                        | 15                       | 15 | 24 | 25                    | 395696     | 5                        | \$384.00         |
|   | ST-42V 144N177 TAN  | 20.0         | 11.4                        | 15                       | 15 | 32 | 33                    | 395702     | 5                        | \$458.00         |
|   | ST-60V 147N130 TAN  | 34.0         | 34.0                        | 22                       | 22 | 30 | 61                    | 395719     | 5                        | \$592.00         |
|   | ST-80V 147N131 TAN  | 44.0         | 33.9                        | 22                       | 22 | 36 | 69                    | 395726     | 5                        | \$813.00         |
|   | ST-180V 148N118 TAN | 62.0         | 34.1                        | 22                       | 22 | 47 | 92                    | 395733     | 5                        | \$979.00         |
|   | ST-200V 149-166 TAN | 81.0         | 33.2                        | 22                       | 22 | 56 | 103                   | 633552     | 5                        | \$1,033.00       |
|   | ST-210V 150N32 TAN  | 86.0         | 46.4                        | 26                       | 26 | 47 | 123                   | 395740     | 5                        | \$1,112.00       |

**T MODELS: THERM-X-SPAN® INLINE THERMAL EXPANSION TANKS, 1-Year Warranty**
**B**

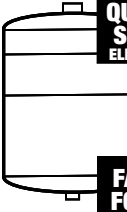
| Model Number  | Description                   | Volume (Gal) | Max Acceptance Volume (Gal) | Shipping Dimensions (In) |    |    | Shipping Weight (Lbs) | UPC 642031 | Standard Leadtime (Days) | List Price (USD) |
|---|-------------------------------|--------------|-----------------------------|--------------------------|----|----|-----------------------|------------|--------------------------|------------------|
|   |                               |              |                             | L                        | W  | H  |                       |            |                          |                  |
|  <b>QUICK SHIP ELIGIBLE</b> | T-5 140-735 LIGHT PRIMER TAN  | 2.0          | 0.9                         | 8                        | 8  | 13 | 5                     | 548498     | 5 QS                     | \$47.50          |
|   | T-12 141-363 LIGHT PRIMER TAN | 4.4          | 3.2                         | 11                       | 11 | 15 | 9                     | 560889     | 5 QS                     | \$60.40          |
|   | T-5-FF 140-735-FF FAST FOUR   | 2.0          | 0.9                         | 17                       | 17 | 13 | 20                    | 639356     | 1FF                      | \$191.00         |
| <b>FAST FOUR</b>  | T-12-FF 141-363-FF FAST FOUR  | 4.4          | 3.2                         | 24                       | 24 | 17 | 36                    | 639387     | 1FF                      | \$242.00         |
|   | <i>4PC MASTER PACK</i>        |              |                             |                          |    |    |                       |            |                          |                  |

## Water Hammer Arrestors

**WATER HAMMER ARRESTORS (SHOCK SUPPRESSORS)**
**K**

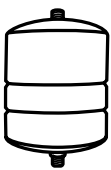
| Model Number  | Description                | Volume (Gal) | Shipping Dimensions (In) |   |    | Shipping Weight (Lbs) | UPC 642031 | Standard Leadtime (Days) | List Price (USD) |
|---|----------------------------|--------------|--------------------------|---|----|-----------------------|------------|--------------------------|------------------|
|   |                            |              | L                        | W | H  |                       |            |                          |                  |
|  <b>Mini-Trol®</b> | 513P01 MINI-TROL COMPOSITE | Size A       | 4                        | 4 | 5  | 1                     | 670137     | 5                        | \$47.80          |
|  <b>Diatrol®</b>   | 537-1 DIATROL #537         | 0.8          | 6                        | 6 | 9  | 3                     | 202932     | 5                        | \$142.00         |
|   | 541-1 DIATROL #541         | 1.0          | 6                        | 6 | 12 | 5                     | 203564     | 5                        | \$211.00         |



**Pallet Quantity:** ST-5 & T-5: 75, ST-8: 60, ST-12 & T-12: 48  
ST-25V, 30V & 42V: 18, ST-60V through ST-210V: 4

**Connection:** ST-1: 1/2" NPTM w/Stainless Steel Waterway; Stainless Steel: ST-5 through ST-12 & T-5 through T-12: 3/4" NPTM, ST-25V through ST-42V: 3/4" NPTF, ST-60V through ST-210V: 1-1/4" NPTF, Mini-Trol: 1/2" NPTM  
Diatrol: Stainless Steel NPTM; 537: 3/4"; 541: 1"

**Warranty:** ST-1 through ST-12 & ST-25V: 5-Year Limited, ST-30V through ST-210V: 1-Year Limited, T-5 & T-12: 1-Year Limited, Mini-Trol & Diatrol: 5-Year Limited

**Maximum Operating Temp:** ST-1: 140°F Intermittent; ST-5 through ST-210V: 200°F; Therm-X-Span and Diatrol: 200°F; Mini-Trol: 180°F Intermittent.  
**Maximum Working Pressure:** 150 PSI

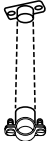

## TUBE HANGERS: 601 SERIES

| Model Number  | Description | Case Qty        |    | Shipping Weight (Lbs) | UPC 642031 | Standard Leadtime (Days) | List Price (USD) |
|---|-------------|-----------------|----|-----------------------|------------|--------------------------|------------------|
|  | 601-1       | 1/2" DIAMETER   | 10 |                       | 1          | 208897                   | \$23.00          |
|   | 601-2       | 3/4" DIAMETER   | 10 | Sold in full          | 1          | 208934                   | \$28.80          |
|   | 601-3       | 1" DIAMETER     | 10 | case quantities       | 1          | 208941                   | \$33.00          |
|   | 601-4       | 1-1/4" DIAMETER | 10 | only                  | 1          | 208958                   | \$39.10          |
|   | 601-5       | 1-1/2" DIAMETER | 10 |                       | 1          | 208965                   | \$43.00          |
|   | 601-6       | 2" DIAMETER     | 10 |                       | 1          | 208972                   | \$45.80          |

## INSO-LINE STRAP HANGERS: 602 SERIES, 6" LENGTH

|   |       |                 |    |                 |   |        |         |
|---|-------|-----------------|----|-----------------|---|--------|---------|
|  | 602-1 | 1/2" DIAMETER   | 25 | Sold in full    | 3 | 209016 | \$87.50 |
|   | 602-3 | 3/4" DIAMETER   | 25 | case quantities | 3 | 209115 | \$89.90 |
|   | 602-5 | 1" DIAMETER     | 25 | only            | 3 | 209139 | \$92.00 |
|   | 602-7 | 1-1/4" DIAMETER | 25 |                 | 4 | 209153 | \$95.40 |

## INSO-LINE STRAP HANGERS: 602 SERIES, 12" LENGTH

|   |       |                 |    |                 |   |        |          |
|---|-------|-----------------|----|-----------------|---|--------|----------|
|  | 602-2 | 1/2" DIAMETER   | 25 | Sold in full    | 4 | 209054 | \$102.00 |
|   | 602-4 | 3/4" DIAMETER   | 25 | case quantities | 4 | 209122 | \$102.00 |
|   | 602-6 | 1" DIAMETER     | 25 | only            | 4 | 209146 | \$105.00 |
|   | 602-8 | 1-1/4" DIAMETER | 25 |                 | 4 | 209160 | \$106.00 |

## NATICK STRAP HANGERS: 603 SERIES, 6" LENGTH

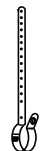
|  |       |                 |    |                 |   |        |         |
|--|-------|-----------------|----|-----------------|---|--------|---------|
|  | 603-1 | 1/2" DIAMETER   | 25 | Sold in full    | 2 | 209474 | \$49.10 |
|  | 603-3 | 3/4" DIAMETER   | 25 | case quantities | 2 | 209641 | \$49.60 |
|  | 603-5 | 1" DIAMETER     | 25 | only            | 3 | 209726 | \$49.90 |
|  | 603-7 | 1-1/4" DIAMETER | 25 |                 | 3 | 209900 | \$50.50 |

## NATICK STRAP HANGERS: 603 SERIES, 12" LENGTH

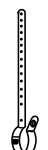
|   |       |                 |    |                 |   |        |         |
|---|-------|-----------------|----|-----------------|---|--------|---------|
|  | 603-2 | 1/2" DIAMETER   | 25 | Sold in full    | 3 | 209542 | \$61.10 |
|   | 603-4 | 3/4" DIAMETER   | 25 | case quantities | 4 | 209719 | \$61.50 |
|   | 603-6 | 1" DIAMETER     | 25 | only            | 4 | 209825 | \$62.00 |
|   | 603-8 | 1-1/4" DIAMETER | 25 |                 | 4 | 210012 | \$62.30 |

## GLIDE CLIPS: 604 SERIES

|   |       |                 |    |                 |   |        |         |
|---|-------|-----------------|----|-----------------|---|--------|---------|
|  | 604-1 | 1/2" DIAMETER   | 10 | Sold in full    | 1 | 210234 | \$25.10 |
|   | 604-2 | 3/4" DIAMETER   | 10 | case quantities | 1 | 210241 | \$27.00 |
|   | 604-3 | 1" DIAMETER     | 10 | only            | 1 | 210258 | \$33.90 |
|   | 604-4 | 1-1/4" DIAMETER | 10 |                 | 1 | 210265 | \$38.40 |

## VAN HANGERS: 606 SERIES

|   |       |               |    |                 |   |        |         |
|---|-------|---------------|----|-----------------|---|--------|---------|
|  | 606-2 | 1/2" DIAMETER | 20 | Sold in full    | 2 | 210494 | \$39.10 |
|   | 606-3 | 3/4" DIAMETER | 20 | case quantities | 2 | 210500 | \$41.80 |
|   | 606-4 | 1" DIAMETER   | 20 | only            | 2 | 210517 | \$45.80 |

## TUBE STRAPS: 608 SERIES

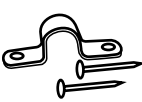
|   |       |                 |     |                 |   |        |         |
|---|-------|-----------------|-----|-----------------|---|--------|---------|
|  | 608-4 | 1/2" DIAMETER   | 100 | Sold in full    | 2 | 210760 | \$23.70 |
|   | 608-6 | 3/4" DIAMETER   | 50  | case quantities | 1 | 210777 | \$15.80 |
|   | 608-7 | 1" DIAMETER     | 50  | only            | 2 | 210784 | \$16.90 |
|   | 608-8 | 1-1/4" DIAMETER | 50  |                 | 2 | 210791 | \$22.30 |

**Hardware:** Strap Hangers, Glide Clips & Tube Straps include copper-clad nails.  
 Tube Hangers & Van Hangers include copper-clad wood screws.

**Warranty:** 1-Year Limited

**EX MODELS: EXTROL® INLINE BOILER SYSTEM EXPANSION TANKS**
**B**

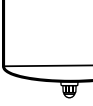
| Model Number   | Description | Volume (Gal) | Max Acceptance Volume (Gal)  | Shipping Dimensions (In) |      |    | Shipping Weight (Lbs) | UPC 642031 | Standard Leadtime (Days) | List Price (USD) |      |          |
|--|-------------|--------------|------------------------------|--------------------------|------|----|-----------------------|------------|--------------------------|------------------|------|----------|
|  |             |              |                              | L                        | W    | H  |                       |            |                          |                  |      |          |
|  <b>QUICK SHIP ELIGIBLE</b>      | EX-15       | 101-1        | MODEL #15                    | 2.0                      | 1.0  | 8  | 8                     | 13         | 5                        | 112743           | 5 QS | \$60.80  |
|  | EX-30       | 102-1        | MODEL #30                    | 4.4                      | 2.5  | 11 | 11                    | 15         | 9                        | 113061           | 5 QS | \$74.60  |
|  | EX-60       | 103-1        | MODEL #60                    | 7.4                      | 2.5  | 11 | 11                    | 23         | 14                       | 113221           | 5 QS | \$138.00 |
|  | EX-90       | 112-1        | MODEL #90                    | 14.0                     | 11.3 | 15 | 15                    | 21         | 23                       | 115287           | 5 QS | \$228.00 |
|  <b>NEW!</b><br><b>FAST FOUR</b> | EX-15-FF    | 101-1-FF     | FAST FOUR<br>4PC MASTER PACK | 2.0                      | 1.0  | 17 | 17                    | 13         | 20                       | 639363           | 1 FF | \$243.00 |
|  | EX-30-FF    | 102-1-FF     | FAST FOUR<br>4PC MASTER PACK | 4.4                      | 2.5  | 24 | 24                    | 17         | 36                       | 639394           | 1 FF | \$299.00 |

**SX MODELS: EXTROL VERTICAL BOILER SYSTEM EXPANSION TANKS**
**B**

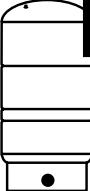
| Model Number   | Description | Volume (Gal) | Max Acceptance Volume (Gal) | Shipping Dimensions (In) |      |    | Shipping Weight (Lbs) | UPC 642031 | Standard Leadtime (Days) | List Price (USD) |      |          |
|--|-------------|--------------|-----------------------------|--------------------------|------|----|-----------------------|------------|--------------------------|------------------|------|----------|
|  |             |              |                             | L                        | W    | H  |                       |            |                          |                  |      |          |
|  <b>QUICK SHIP ELIGIBLE</b> | SX-30V      | 118-27       | STAND MODEL                 | 14                       | 11.3 | 15 | 15                    | 24         | 25                       | 118967           | 5 QS | \$278.00 |
|  | SX-40V      | 118-78       | STAND MODEL                 | 20                       | 11.3 | 15 | 15                    | 32         | 33                       | 119896           | 5    | \$296.00 |
|  | SX-60V      | 118-79       | STAND MODEL                 | 32                       | 11.3 | 15 | 15                    | 48         | 43                       | 119902           | 5 QS | \$416.00 |
|  | SX-90V      | 118-153      | STAND MODEL                 | 44                       | 34.0 | 22 | 22                    | 36         | 69                       | 118714           | 5 QS | \$757.00 |
|  | SX-110V     | 118-154      | STAND MODEL                 | 62                       | 34.0 | 22 | 22                    | 47         | 92                       | 118721           | 5    | \$891.00 |
|  | SX-130V     | 149-165      | STAND MODEL                 | 81                       | 34.0 | 22 | 22                    | 56         | 103                      | 633583           | 5    | \$919.00 |
|  | SX-160V     | 118-155      | STAND MODEL                 | 86                       | 46.0 | 26 | 26                    | 47         | 123                      | 118738           | 5    | \$947.00 |

**EX PACKAGES: EXTROL COMBINATION KITS**
**B**

|   |             |       |                                 |     |     |    |    |    |    |        |   |          |
|---|-------------|-------|---------------------------------|-----|-----|----|----|----|----|--------|---|----------|
|  <b>NEW!</b> | EX-1500-100 | 105-1 | EX-15 WITH 1" PURGER & VENT     | 2.0 | 1.0 | 8  | 8  | 15 | 10 | 113382 | 5 | \$107.00 |
|   | EX-1500-125 | 105-2 | EX-15 WITH 1-1/4" PURGER & VENT | 2.0 | 1.0 | 8  | 8  | 15 | 10 | 113412 | 5 | \$107.00 |
|   | EX-3000-100 | 106-1 | EX-30 WITH 1" PURGER & VENT     | 4.4 | 2.5 | 11 | 11 | 19 | 14 | 113504 | 5 | \$120.00 |
|   | EX-3000-125 | 106-2 | EX-30 WITH 1-1/4" PURGER & VENT | 4.4 | 2.5 | 11 | 11 | 19 | 14 | 113528 | 5 | \$120.00 |

**FT MODELS: FILL-TROL® TANKS AND AUTOMATIC FILL VALVES**
**B**

|  |           |         |                        |      |      |    |    |    |    |        |      |          |
|--|-----------|---------|------------------------|------|------|----|----|----|----|--------|------|----------|
|  <b>QUICK SHIP ELIGIBLE</b><br><b>NEW!</b> | FT-109    | 109-1   | FILL-TROL TANK & VALVE | 2.0  | 1.0  | 8  | 8  | 15 | 6  | 114198 | 5 QS | \$112.00 |
|  | FT-110    | 110-1   | FILL-TROL TANK & VALVE | 4.4  | 2.5  | 11 | 11 | 17 | 10 | 114525 | 5 QS | \$130.00 |
|  | FT-111    | 111-1   | FILL-TROL TANK & VALVE | 7.4  | 2.5  | 11 | 11 | 25 | 15 | 114914 | 5    | \$198.00 |
|  | FT-112    | 112-2   | FILL-TROL TANK & VALVE | 14.0 | 11.3 | 15 | 15 | 23 | 24 | 115300 | 5    | \$261.00 |
|  | FT-15     | 109-133 | FILL-TROL TANK ONLY    | 2.0  | 1.0  | 8  | 8  | 13 | 5  | 114310 | 5    | \$74.40  |
|  | FT-30     | 110-002 | FILL-TROL TANK ONLY    | 4.4  | 2.5  | 11 | 11 | 15 | 9  | 114488 | 5    | \$90.00  |
|  | FT-109-15 | 109-15  | FILL-TROL VALVE ONLY   | -    | -    | -  | -  | -  | 1  | 370143 | 5    | \$55.80  |

**FT PACKAGES: FILL-TROL COMBINATION KITS**
**B**

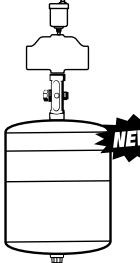
|  |            |        |                                  |     |     |    |    |    |    |        |   |          |
|--|------------|--------|----------------------------------|-----|-----|----|----|----|----|--------|---|----------|
|  <b>NEW!</b> | FT-109-100 | 109-9  | FT-109 WITH 1" PURGER & VENT     | 2.0 | 1.0 | 8  | 8  | 19 | 10 | 114433 | 5 | \$153.00 |
|  | FT-109-125 | 109-10 | FT-109 WITH 1-1/4" PURGER & VENT | 2.0 | 1.0 | 8  | 8  | 19 | 10 | 114204 | 5 | \$153.00 |
|  | FT-110-100 | 110-9  | FT-110 WITH 1" PURGER & VENT     | 4.4 | 2.5 | 11 | 11 | 23 | 14 | 114600 | 5 | \$170.00 |
|  | FT-110-125 | 110-10 | FT-110 WITH 1-1/4" PURGER & VENT | 4.4 | 2.5 | 11 | 11 | 23 | 14 | 114532 | 5 | \$170.00 |
|  | FT-111-125 | 111-4  | FT-111 WITH 1-1/4" PURGER & VENT | 7.4 | 2.5 | 11 | 11 | 31 | 18 | 114938 | 5 | \$236.00 |

**RX MODELS: RADIANT EXTROL® HEATING SYSTEM EXPANSION TANKS**
**B**

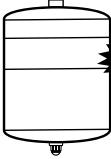
| Model Number  | Description | Volume (Gal) | Max Acceptance Volume (Gal) | Shipping Dimensions (In) |    |    | Shipping Weight (Lbs) | UPC 642031 | Standard Leadtime (Days) | List Price (USD) |          |
|---|-------------|--------------|-----------------------------|--------------------------|----|----|-----------------------|------------|--------------------------|------------------|----------|
|   |             |              |                             | L                        | W  | H  |                       |            |                          |                  |          |
|  <b>NEW!</b> | RX-15       | 140-705      | 2.0                         | 0.9                      | 8  | 8  | 13                    | 5          | 413291                   | 5                | \$83.80  |
|   | RX-30       | 141-305      | 4.4                         | 3.2                      | 11 | 11 | 15                    | 9          | 413307                   | 5                | \$103.00 |
|   | RX-60       | 143-381      | 10.3                        | 10.3                     | 15 | 15 | 19                    | 23         | 600035                   | 5                | \$232.00 |

**SE MODELS: CLOSED-LOOP SOLAR EXTROL® EXPANSION TANKS**
**B**

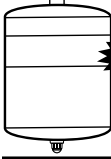
| Model Number  | Description | Volume (Gal) | Max Acceptance Volume (Gal) | Shipping Dimensions (In) |    |    | Shipping Weight (Lbs) | UPC 642031 | Standard Leadtime (Days) | List Price (USD) |          |
|---|-------------|--------------|-----------------------------|--------------------------|----|----|-----------------------|------------|--------------------------|------------------|----------|
|   |             |              |                             | L                        | W  | H  |                       |            |                          |                  |          |
|  <b>NEW!</b> | SE-15       | 104-001      | 2.0                         | 1.0                      | 8  | 8  | 13                    | 5          | 633880                   | 10               | \$66.30  |
|   | SE-30       | 104-002      | 4.4                         | 2.5                      | 11 | 11 | 15                    | 9          | 633897                   | 10               | \$81.10  |
|   | SE-60       | 104-003      | 7.4                         | 2.5                      | 11 | 11 | 23                    | 14         | 633903                   | 10               | \$182.00 |

**Pallet Quantity:** EX-15: 75, EX-30: 48, EX-60: 32, EX-90: 18, Combination Packages: Same as base model  
 SX-30V & SX-40V: 18, SX-60V: 9, SX-90V through SX-110V: 4, RX-15: 75, RX-30: 48, RX-60: 18  
 SE-15: 75, SE-30: 48, SE-60: 32

**Connection:** Steel: EX-15 through EX-90: 1/2" NPTM, SX-30V through SX-60V: 1" NPTF, SX-90V through SX-160V: 1-1/4" NPTF, SE-15 through SE-60: 1/2" NPTM  
 Brass: FT Models: 1/2" NPTF  
 Stainless Steel: RX-15 through RX-30: 1/2" NPTM, RX-60: 3/4" NPTF

**Warranty:** EX, FT, RX & SE Models: 5-Year Limited, SX Models: 1-Year Limited

**Maximum Operating Temp:** Extrol, Fill-Trol: 240° F, Radiant Extrol: 200° F, Solar Extrol: Intermittant 250° F, Continuous 225° F  
**Maximum Working Pressure:** 100 PSI



## Air Purgers, Vents & Valves

**AIR VENTS**
**H**

| Model Number  | Description | Shipping Dimensions (In) |                               |   | Shipping Weight (Lbs) | UPC 642031 | Standard Leadtime (Days) | List Price (USD) |   |         |
|---|-------------|--------------------------|-------------------------------|---|-----------------------|------------|--------------------------|------------------|---|---------|
|   |             | L                        | W                             | H |                       |            |                          |                  |   |         |
|  | 700-QC      | 700-QC                   | FLOAT VENT, 1/8" QUICK-CHANGE | 2 | 2                     | 4          | 0.5                      | 591982           | 5 | \$14.00 |
|   | 701-C       | 701-30                   | FLOAT VENT, 1/4" CONNECTION   | 2 | 2                     | 4          | 0.5                      | 389473           | 5 | \$14.00 |
|   | 700-C       | 700-30                   | FLOAT VENT, 1/8" CONNECTION   | 2 | 2                     | 4          | 0.5                      | 389466           | 5 | \$12.70 |

**AIR PURGERS**
**C**

|   |       |                        |    |   |   |    |        |   |          |
|---|-------|------------------------|----|---|---|----|--------|---|----------|
|  | 443-1 | CAST AIR PURGER 1"     | 6  | 3 | 4 | 4  | 193117 | 5 | \$26.30  |
|   | 444-1 | CAST AIR PURGER 1-1/4" | 6  | 3 | 4 | 4  | 193148 | 5 | \$26.30  |
|   | 445-1 | CAST AIR PURGER 1-1/2" | 8  | 4 | 5 | 9  | 193186 | 5 | \$60.00  |
|   | 446-1 | CAST AIR PURGER 2"     | 8  | 4 | 5 | 10 | 193223 | 5 | \$66.40  |
|   | 447-1 | CAST AIR PURGER 2-1/2" | 10 | 5 | 6 | 19 | 193254 | 5 | \$150.00 |
|   | 448-1 | CAST AIR PURGER 3"     | 10 | 5 | 6 | 20 | 193261 | 5 | \$186.00 |

**TANK SERVICE CHECK VALVE**
**C**

|   |         |                                  |   |   |   |     |        |   |         |
|---|---------|----------------------------------|---|---|---|-----|--------|---|---------|
|  | 140-470 | SERVICE CHECK, 1/2" QUICK CHANGE | 1 | 1 | 1 | 0.1 | 603487 | 5 | \$13.60 |
|---|---------|----------------------------------|---|---|---|-----|--------|---|---------|

**MIXING VALVES**
**C**

|   |       |   |   |   |   |   |        |   |          |
|---|-------|---|---|---|---|---|--------|---|----------|
|  | 420-1 | 1/2" DOMESTIC WATER MIXING VALVE 110-170F | 2 | 2 | 4 | 1 | 190819 | 5 | \$90.50  |
|   | 421-1 | 3/4" DOMESTIC WATER MIXING VALVE 110-170F | 2 | 2 | 4 | 1 | 190888 | 5 | \$100.00 |
|   | 420-6 | MIXING VALVE REPLACEMENT CARTRIDGE        | - | - | - | 1 | 190826 | 5 | \$27.60  |

**Case Qty:** Air Vents: 24, 443 & 444 Purgers:12  
**Purges Vent Tpng:** 443 through 445: 1/8" NPT, 446: 1/2" NPT, 447 & 448: 3/4" NPT  
**Purges Exp Tpng:** 443 through 448: 1/2" NPT  
**Warranty:** 1-Year Limited

## HYDROMAX® INDIRECT-FIRED WATER HEATERS

**G**

**QUICK SHIP ELIGIBLE**

| Model Number | Description | Coil       | Control             | Color | Volume (Gal) | Shipping Dimensions (In) |    |    | Shipping Weight (Lbs) | UPC 642031 | Standard Leadtime (Days) | List Price (USD) |
|--------------|-------------|------------|---------------------|-------|--------------|--------------------------|----|----|-----------------------|------------|--------------------------|------------------|
|              |             |            |                     |       |              | L                        | W  | H  |                       |            |                          |                  |
| HM-41Z       | 2783Z01-8   | 140MBH TOP | MECHANICAL          | BLACK | 41           | 22                       | 22 | 55 | 124                   | 653000     | 5 QS                     | \$1,683.00       |
| HM-41ZDW     | 2800Z01-8   | 140MBH TOP | MECHANICAL DBL WALL | BLACK | 41           | 22                       | 22 | 55 | 134                   | 659842     | 5                        | \$2,263.00       |
| HM-41L       | 2783L01-8   | 140MBH TOP | ENER-G-NET™         | BLACK | 41           | 22                       | 22 | 55 | 124                   | 654168     | 5                        | \$1,798.00       |
| HM-41LDW     | 2800L01-8   | 140MBH TOP | ENER-G-NET DBL WALL | BLACK | 41           | 22                       | 22 | 55 | 134                   | 659859     | 5                        | \$2,378.00       |
| HM-80Z       | 2782Z01-8   | 140MBH TOP | MECHANICAL          | BLACK | 80           | 26                       | 26 | 62 | 180                   | 654007     | 5                        | \$2,273.00       |
| HM-80ZDW     | 2801Z01-8   | 140MBH TOP | MECHANICAL DBL WALL | BLACK | 80           | 26                       | 26 | 62 | 190                   | 659835     | 5                        | \$2,853.00       |
| HM-80L       | 2782L01-8   | 140MBH TOP | ENER-G-NET          | BLACK | 80           | 26                       | 26 | 62 | 180                   | 654199     | 5                        | \$2,391.00       |
| HM-80LDW     | 2801L01-8   | 140MBH TOP | ENER-G-NET DBL WALL | BLACK | 80           | 26                       | 26 | 62 | 190                   | 659828     | 5                        | \$2,971.00       |

**HM MODELS**

## BOILERMATE® INDIRECT-FIRED WATER HEATERS

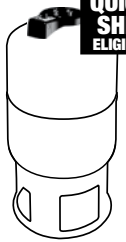
**G**

**QUICK SHIP ELIGIBLE**

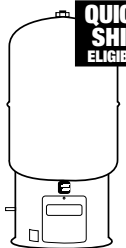
|            |            |                     |               |      |    |    |    |    |     |        |       |            |
|------------|------------|---------------------|---------------|------|----|----|----|----|-----|--------|-------|------------|
| CH-41Z-B   | 2703Z01-6  | 100MBH TOP          | MECHANICAL    | BLUE | 41 | 22 | 22 | 48 | 124 | 632951 | 10 QS | \$1,526.00 |
| CH-41Z-R   | 2703Z01-1  | 100MBH TOP          | MECHANICAL    | RED  | 41 | 22 | 22 | 48 | 124 | 632937 | 10    | \$1,526.00 |
| CH-41Z-G   | 2703Z01-5  | 100MBH TOP          | MECHANICAL    | GRAY | 41 | 22 | 22 | 48 | 124 | 630773 | 10    | \$1,526.00 |
| CH-41ZDW-B | 2703DW01-6 | 100MBH TOP DBL WALL | MECHANICAL    | BLUE | 41 | 22 | 22 | 48 | 134 | 646040 | 10    | \$1,914.00 |
| CH-41ZDW-R | 2703DW01-1 | 100MBH TOP DBL WALL | MECHANICAL    | RED  | 41 | 22 | 22 | 48 | 134 | 646033 | 10    | \$1,914.00 |
| CH-41ZDW-G | 2703DW01-5 | 100MBH TOP DBL WALL | MECHANICAL    | GRAY | 41 | 22 | 22 | 48 | 134 | 646026 | 10    | \$1,914.00 |
| CH-41ZCT-B | 2703Z02-6  | 100MBH TOP          | CONSTANT TEMP | BLUE | 41 | 22 | 22 | 51 | 127 | 637376 | 15    | \$1,969.00 |
| CH-41ZCT-R | 2703Z02-1  | 100MBH TOP          | CONSTANT TEMP | RED  | 41 | 22 | 22 | 51 | 127 | 638243 | 15    | \$1,969.00 |
| CH-41ZCT-G | 2703Z02-5  | 100MBH TOP          | CONSTANT TEMP | GRAY | 41 | 22 | 22 | 51 | 127 | 638236 | 15    | \$1,969.00 |

**CH MODELS**

**QUICK SHIP ELIGIBLE**

|            |            |                        |            |      |    |    |    |    |     |        |       |            |
|------------|------------|------------------------|------------|------|----|----|----|----|-----|--------|-------|------------|
| CH-80Z-B   | 2702Z01-6  | 100MBH TOP             | MECHANICAL | BLUE | 80 | 26 | 26 | 49 | 180 | 636324 | 10    | \$2,175.00 |
| CH-80Z-R   | 2702Z01-1  | 100MBH TOP             | MECHANICAL | RED  | 80 | 26 | 26 | 49 | 180 | 636300 | 10    | \$2,175.00 |
| CH-80Z-G   | 2702Z01-5  | 100MBH TOP             | MECHANICAL | GRAY | 80 | 26 | 26 | 49 | 180 | 635969 | 10    | \$2,175.00 |
| CH-80ZDW-B | 2702DW01-6 | 100MBH TOP DBL WALL    | MECHANICAL | BLUE | 80 | 26 | 26 | 49 | 190 | 646071 | 10    | \$2,724.00 |
| CH-80ZDW-R | 2702DW01-1 | 100MBH TOP DBL WALL    | MECHANICAL | RED  | 80 | 26 | 26 | 49 | 190 | 646057 | 10    | \$2,724.00 |
| CH-80ZDW-G | 2702DW01-5 | 100MBH TOP DBL WALL    | MECHANICAL | GRAY | 80 | 26 | 26 | 49 | 190 | 646064 | 10    | \$2,724.00 |
| WH-41Z-B   | 2704Z37-6  | 100MBH BOTTOM          | MECHANICAL | BLUE | 41 | 22 | 22 | 48 | 134 | 600998 | 10 QS | \$1,526.00 |
| WH-41Z-R   | 2704Z37-1  | 100MBH BOTTOM          | MECHANICAL | RED  | 41 | 22 | 22 | 48 | 134 | 577252 | 10    | \$1,526.00 |
| WH-41Z-G   | 2704Z81    | 100MBH BOTTOM          | MECHANICAL | GRAY | 41 | 22 | 22 | 48 | 134 | 557469 | 10    | \$1,526.00 |
| WH-41L-B   | 2704E67-6  | 100MBH BOTTOM          | DIGITAL    | BLUE | 41 | 22 | 22 | 48 | 134 | 929623 | 10 QS | \$1,657.00 |
| WH-41L-R   | 2704E67-1  | 100MBH BOTTOM          | DIGITAL    | RED  | 41 | 22 | 22 | 48 | 134 | 577269 | 10    | \$1,657.00 |
| WH-41L-G   | 2704E80    | 100MBH BOTTOM          | DIGITAL    | GRAY | 41 | 22 | 22 | 48 | 134 | 557452 | 10    | \$1,657.00 |
| WH-41ZDW-B | 2704Z1014  | 100MBH BOTTOM DBL WALL | MECHANICAL | BLUE | 41 | 22 | 22 | 48 | 144 | 629630 | 10    | \$1,914.00 |
| WH-41ZDW-G | 2704Z86    | 100MBH BOTTOM DBL WALL | MECHANICAL | GRAY | 41 | 22 | 22 | 48 | 144 | 576101 | 10    | \$1,914.00 |
| WH-41LDW-B | 2704E1015  | 100MBH BOTTOM DBL WALL | DIGITAL    | BLUE | 41 | 22 | 22 | 48 | 144 | 629647 | 10    | \$2,048.00 |
| WH-41LDW-G | 2704E87    | 100MBH BOTTOM DBL WALL | DIGITAL    | GRAY | 41 | 22 | 22 | 48 | 144 | 576118 | 10    | \$2,048.00 |

**WH MODELS**

## HOT WATER MAKER REPLACEMENT PARTS

**I**
**CONTROLS**

|          |   |            |        |   |          |
|----------|---|------------|--------|---|----------|
| 2704-093 | AQUASTAT: RESIDENTIAL 150F, ALL EXC WH-10           | MECHANICAL | 390028 | 1 | \$129.00 |
| 2775-454 | AQUASTAT: COMMERCIAL 180F, ALL EXC WH-10            | MECHANICAL | 519658 | 1 | \$174.00 |
| 2770-133 | AQUASTAT: 150F, WH-10                               | MECHANICAL | 343475 | 1 | \$129.00 |
| 940R101  | DIGITAL CONTROL REPLACEMENT & UPGRADE, WH, TD & WHS | DIGITAL    | 654144 | 1 | \$312.00 |
| 940R2    | ENER-G-NET DIGITAL CONTROL ONLY                     | DIGITAL    | 654069 | 1 | \$307.00 |
| 2704-259 | DIGITAL TEMPERATURE SENSOR ONLY (THERMISTOR)        | DIGITAL    | 432650 | 1 | \$40.20  |
| 2704-392 | AQUASTAT RETROFIT KIT, WH                           | MECHANICAL | 466846 | 1 | \$259.00 |
| 2704-487 | AQUASTAT RETROFIT KIT W/RELAY, WH                   | MECHANICAL | 611888 | 1 | \$296.00 |
| 2775-455 | AQUASTAT RETROFIT KIT, WHS                          | MECHANICAL | 519726 | 1 | \$259.00 |
| 2775-768 | AQUASTAT RETROFIT KIT W/RELAY, WHS                  | MECHANICAL | 611857 | 1 | \$296.00 |
| 2704-529 | UNIVERSAL 10K DIGITAL TEMP SENSOR KIT               | DIGITAL    | 651044 | 1 | \$42.10  |

**HEAT EXCHANGER COILS**

|           |                                       |        |   |            |
|-----------|---------------------------------------|--------|---|------------|
| 2700-5000 | WH MODELS (ALL EXCEPT WH-7C)          | 534095 | 1 | \$1,126.00 |
| 2700-5001 | WH-7C & WHS-C COMMERCIAL MODELS       | 534101 | 1 | \$1,360.00 |
| 2700-5002 | WH-DW DBL-WALL MODELS (EXCEPT WH-7C)  | 534118 | 1 | \$1,887.00 |
| 2700-5003 | WH-7CDW & WHS-CDW COM. DBL. WALL MDLS | 534125 | 1 | \$2,405.00 |
| 2700-5005 | TD-41 MODELS (EXCEPT DW)              | 604002 | 1 | \$1,321.00 |
| 2700-5006 | TD-41DW DOUBLE-WALL MODELS            | 604033 | 1 | \$2,362.00 |
| 2700-5008 | TD-80 MODELS                          | 604026 | 1 | \$1,376.00 |
| 2703R003  | CH-41 MODELS                          | 641762 | 1 | \$795.00   |
| 2702R002  | CH-80 MODELS                          | 659934 | 1 | \$832.00   |
| 2702R007  | CH-80 DW DOUBLE-WALL MODELS           | 686954 | 1 | \$1,594.00 |
| 2775-82   | WHS MODELS (EXCEPT C & DW)            | 534378 | 1 | \$1,148.00 |
| 2775-83   | WHS-DW RESIDENTIAL MODELS             | 534385 | 1 | \$1,909.00 |
| 2775-84   | WHS-DW COMMERCIAL MODELS              | 534392 | 1 | \$2,487.00 |
| 2713R002  | HM-41 MODELS                          | 659958 | 1 | \$1,015.00 |
| 2712R002  | HM-80 MODELS                          | 659941 | 1 | \$1,059.00 |
| 2801R002  | HM-80 DW DOUBLE-WALL MODELS           | 686947 | 1 | \$1,820.00 |

**MISC PARTS**

|           |                                    |        |   |         |
|-----------|------------------------------------|--------|---|---------|
| 2700-924  | AQUASTAT DRY WELL                  | 166357 | 1 | \$61.80 |
| 2500-218  | HEAT EXCHANGER COIL GASKET, 8 BOLT | 160768 | 1 | \$8.10  |
| 2500-178  | WH TOP OUTLET O-RING               | 160690 | 1 | \$1.00  |
| 2700-635  | WH TOP OUTLET UNION TEE PACKAGE    | 164438 | 1 | \$82.60 |
| 2703R001  | DIP TUBE, CH-41                    | 673503 | 1 | \$12.10 |
| 2702R001  | DIP TUBE, CH-80                    | 677389 | 1 | \$15.20 |
| 9340R160  | DRAIN VALVE ASSEMBLY, ALL CH & HM  | 671271 | 1 | \$75.70 |
| 2700R1106 | T&P RELIEF VALVE, RESIDENTIAL      | 643896 | 1 | \$36.30 |
| 2704R512  | TOP COVER HALF, HM-41 & HM-80      | 677372 | 1 | \$39.20 |
| 2783R0001 | HEAT TRAP, ALL HM                  | 677365 | 1 | \$24.70 |
| 2783R0004 | T&P BLOWDOWN TUBE: HM-41           | 677341 | 1 | \$43.90 |
| 2782R0002 | T&P BLOWDOWN TUBE: HM-80           | 677358 | 1 | \$44.10 |

## PREMIER™ INDIRECT-FIRED WATER HEATERS

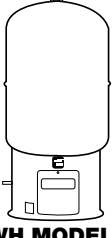
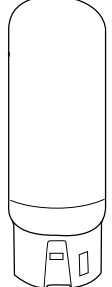
| Model Number  | Description | Coil                     | Control                  | Material   | Volume (Gal) | Shipping Dimensions (In) |    |    | Shipping Weight (Lbs) | UPC 642031 | Standard Leadtime (Days) | List Price (USD) |            |
|---|-------------|--------------------------|--------------------------|------------|--------------|--------------------------|----|----|-----------------------|------------|--------------------------|------------------|------------|
|   |             |                          |                          |            |              | L                        | W  | H  |                       |            |                          |                  |            |
| <br><b>WH MODELS</b>           | WH-7C       | 2704E76                  | 240MBH BOTTOM            | DIGITAL    | 180F Poly    | 41                       | 22 | 22 | 48                    | 144        | 557414                   | 10               | \$3,120.00 |
|   | WH-7ZC      | 2704Z91                  | 240MBH BOTTOM            | MECHANICAL | 180F Poly    | 41                       | 22 | 22 | 48                    | 144        | 582072                   | 10               | \$2,989.00 |
|   | WH-7CDW     | 2704E75                  | 240MBH BOTTOM DBL WALL   | DIGITAL    | 180F Poly    | 41                       | 22 | 22 | 48                    | 154        | 557407                   | 10               | \$3,770.00 |
| <br><b>WHS &amp; DC MODELS</b> | WHS-60Z     | 2775S5009                | 140MBH BOTTOM            | MECHANICAL | Stainless    | 60                       | 26 | 26 | 54                    | 160        | 557506                   | 10               | \$3,628.00 |
|   | WHS-60L     | 2775S5007                | 140MBH BOTTOM            | DIGITAL    | Stainless    | 60                       | 26 | 26 | 54                    | 160        | 557483                   | 10               | \$3,896.00 |
|   | WHS-60ZDW   | 2775S5010                | 140MBH BOTTOM DBL WALL   | MECHANICAL | Stainless    | 60                       | 26 | 26 | 54                    | 170        | 557513                   | 10               | \$4,211.00 |
|   | WHS-60LDW   | 2775S5008                | 140MBH BOTTOM DBL WALL   | DIGITAL    | Stainless    | 60                       | 26 | 26 | 54                    | 170        | 557490                   | 10               | \$4,434.00 |
|   | WHS-60ZC    | 2775S5027                | 240MBH BOTTOM            | MECHANICAL | Stainless    | 60                       | 26 | 26 | 54                    | 170        | 575753                   | 10               | \$3,984.00 |
|   | WHS-60ZCDW  | 2775S5011                | 240MBH BOTTOM DBL WALL   | MECHANICAL | Stainless    | 60                       | 26 | 26 | 54                    | 170        | 557520                   | 10               | \$4,893.00 |
|   | WHS-80Z     | 2775S5014                | 140MBH BOTTOM            | MECHANICAL | Stainless    | 80                       | 26 | 26 | 66                    | 170        | 557551                   | 10               | \$4,334.00 |
|   | WHS-80L     | 2775S5012                | 140MBH BOTTOM            | DIGITAL    | Stainless    | 80                       | 26 | 26 | 66                    | 170        | 557537                   | 10               | \$4,584.00 |
|   | WHS-80ZDW   | 2775S5015                | 140MBH BOTTOM DBL WALL   | MECHANICAL | Stainless    | 80                       | 26 | 26 | 66                    | 180        | 557568                   | 10               | \$4,674.00 |
|   | WHS-80LDW   | 2775S5013                | 140MBH BOTTOM DBL WALL   | DIGITAL    | Stainless    | 80                       | 26 | 26 | 66                    | 180        | 557544                   | 10               | \$4,922.00 |
|   | WHS-80ZC    | 2775S5026                | 240MBH BOTTOM            | MECHANICAL | Stainless    | 80                       | 26 | 26 | 66                    | 180        | 575777                   | 10               | \$4,561.00 |
|   | WHS-80ZCDW  | 2775S5016                | 240MBH BOTTOM DBL WALL   | MECHANICAL | Stainless    | 80                       | 26 | 26 | 66                    | 180        | 557575                   | 10               | \$5,360.00 |
|   | DC-80       | 2775S5029                | DUAL HEAT EXCHANGERS     | MECHANICAL | Stainless    | 80                       | 26 | 26 | 66                    | 190        | 584151                   | 10               | \$5,330.00 |
|   | DC-80DW     | 2775S5030                | DUAL DBL WALL EXCHANGERS | MECHANICAL | Stainless    | 80                       | 26 | 26 | 66                    | 200        | 584182                   | 10               | \$6,020.00 |
|   | WHS-120Z    | 2775S5020                | 140MBH BOTTOM            | MECHANICAL | Stainless    | 120                      | 30 | 30 | 71                    | 200        | 557605                   | 10               | \$5,800.00 |
| WHS-120L  | 2775S5019   | 140MBH BOTTOM            | DIGITAL                  | Stainless  | 120          | 30                       | 30 | 71 | 200                   | 557599     | 10                       | \$6,020.00       |            |
| WHS-120ZC   | 2775S5025   | 240MBH BOTTOM            | MECHANICAL               | Stainless  | 120          | 30                       | 30 | 71 | 200                   | 575791     | 10                       | \$6,090.00       |            |
| WHS-120ZCDW   | 2775S5021   | 240MBH BOTTOM DBL WALL   | MECHANICAL               | Stainless  | 120          | 30                       | 30 | 71 | 210                   | 557612     | 10                       | \$6,770.00       |            |
| DC-120  | 2775S5031   | DUAL HEAT EXCHANGERS     | MECHANICAL               | Stainless  | 120          | 30                       | 30 | 71 | 220                   | 584212     | 10                       | \$6,850.00       |            |
| DC-120DW  | 2775S5032   | DUAL DBL WALL EXCHANGERS | MECHANICAL               | Stainless  | 120          | 30                       | 30 | 71 | 230                   | 584243     | 10                       | \$7,730.00       |            |

## PREMIER HOT WATER STORAGE TANKS

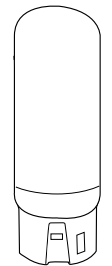
| Model Number   | Description | Volume (Gal)            | Shipping Dimensions (In) |    |    | Shipping Weight (Lbs) | UPC 642031 | Standard Leadtime (Days) | List Price (USD) |            |
|--|-------------|-------------------------|--------------------------|----|----|-----------------------|------------|--------------------------|------------------|------------|
|  |             |                         | L                        | W  | H  |                       |            |                          |                  |            |
| <br><b>S MODELS</b> | S-41        | 2704-71                 | 41                       | 22 | 22 | 54                    | 120        | 552419                   | 10               | \$1,282.00 |
|  | S-41L       | 2704-83 LESS AQUASTAT   | 41                       | 22 | 22 | 54                    | 120        | 566591                   | 10               | \$1,182.00 |
|  | S-80        | 2775-5001               | 80                       | 26 | 26 | 66                    | 156        | 552426                   | 10               | \$3,145.00 |
|  | S-80L       | 2775-5023 LESS AQUASTAT | 80                       | 26 | 26 | 66                    | 156        | 571144                   | 10               | \$3,041.00 |
|  | S-120       | 2775-5002               | 120                      | 30 | 30 | 71                    | 196        | 552433                   | 10               | \$4,497.00 |
|  | S-120L      | 2775-5024 LESS AQUASTAT | 120                      | 30 | 30 | 71                    | 196        | 571151                   | 10               | \$4,392.00 |



**Pallet Quantity:** All Models: 4  
**Warranty:** HM Models: 7-Years with Limited Lifetime upgrade option in carton  
 CH & WH Models: 6-Years with Limited Lifetime upgrade option in carton  
 WHS, DC & S Models: 10-Year Limited (Residential), 5-Year Limited (Commercial)  
**Hardware:** All models include T&P relief and drain valves

COMMERCIAL / RESIDENTIAL PRODUCTS

## APPLICATIONS & ORDERING

- For use in non-potable closed hydronic and chilled water systems.
- Fixed diaphragm construction.
- Available in Horizontal and Vertical configurations.
- Constructed to ASME Section VIII, Division 1.
- Maximum Operating Temperature: 240° F.

## How to Order: Specify Model & Options

AX-80-125SGR

- Step 1: Select Base Model Number  
 Step 2: Choose Pressure Rating  
 Step 3: Specify Sight Glass Option (or leave blank)  
 Step 4: Specify Restraint Option (or leave blank)

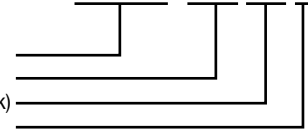

AX-80 (Horizontal) 125 PSI Rating with Sight Glass & Restraints

## AX MODELS: HORIZONTAL DIAPHRAGM TYPE, ASME

J

### TECHNICAL DATA

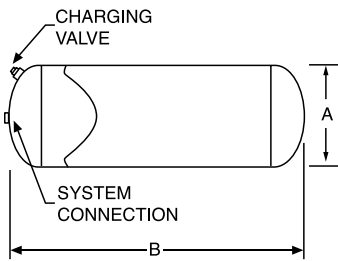

AX-15 THROUGH AX-240

| Base Model Number | Volume (Gal) | Max Acceptance Volume (Gal) | A Diameter (In) | B Length (In) | Shipping Weight (Lbs) |         |         |         |         |
|-------------------|--------------|-----------------------------|-----------------|---------------|-----------------------|---------|---------|---------|---------|
|                   |              |                             |                 |               | 125 PSI               | 150 PSI | 175 PSI | 250 PSI | 300 PSI |
| AX-15             | 8.0          | 2.4                         | 12              | 19            | 37                    | 39      | 48      | 55      | 59      |
| AX-20             | 10.9         | 2.4                         | 12              | 26            | 46                    | 48      | 60      | 69      | 74      |
| AX-40             | 21.7         | 11.3                        | 16              | 29            | 74                    | 76      | 96      | 111     | 118     |
| AX-60             | 33.6         | 11.3                        | 16              | 43            | 96                    | 120     | 125     | 144     | 154     |
| AX-80             | 44.4         | 22.6                        | 24              | 29            | 153                   | 160     | 200     | 230     | 245     |
| AX-100            | 55.7         | 22.6                        | 24              | 33            | 174                   | 180     | 227     | 261     | 279     |
| AX-120            | 68.0         | 34.0                        | 24              | 41            | 204                   | 245     | 266     | 306     | 327     |
| AX-144            | 77.0         | 34.0                        | 24              | 46            | 218                   | 250     | 285     | 327     | 350     |
| AX-180            | 90.0         | 34.0                        | 24              | 54            | 232                   | 265     | 301     | 348     | 372     |
| AX-200            | 110.0        | 34.0                        | 24              | 64            | 269                   | 320     | 350     | 404     | 430     |
| AX-240            | 132.0        | 46.0                        | 30              | 51            | 401                   | 403     | 522     | 602     | 642     |
| AX-260            | 159.0        | 56.0                        | 30              | 62            | 455                   | 460     | 572     | 683     | 728     |
| AX-280            | 211.0        | 84.0                        | 30              | 80            | 580                   | 600     | 755     | 870     | 930     |

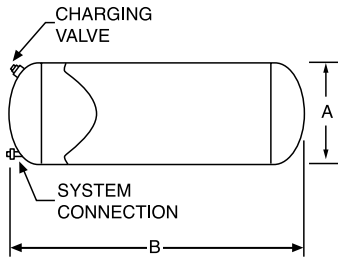

AX-260 & AX-280

### PRICING: ASME MODELS

| Base Model Number | Part No. / List Price (USD) |                   |                   |                   |          |
|-------------------|-----------------------------|-------------------|-------------------|-------------------|----------|
|                   | 125 PSI                     | 150 PSI           | 175 PSI           | 250 PSI           | 300 PSI  |
| AX-15             | 117-0015 / \$1,610          | 117-459 / \$1,771 | \$1,947           | 117-622 / \$2,142 | \$2,358  |
| AX-20             | 117-0020 / \$1,636          | 117-462 / \$1,799 | \$1,979           | \$2,177           | \$2,396  |
| AX-40             | 117-0040 / \$2,300          | 117-465 / \$2,528 | 117-556 / \$2,782 | \$3,061           | \$3,366  |
| AX-60             | 117-0060 / \$2,526          | 117-468 / \$2,780 | 117-554 / \$3,058 | \$3,364           | \$3,702  |
| AX-80             | 117-80 / \$3,206            | 117-525 / \$3,528 | \$3,880           | \$4,268           | \$4,696  |
| AX-100            | 117-100 / \$3,316           | 117-476 / \$3,646 | \$4,012           | \$4,414           | \$4,854  |
| AX-120            | 117-120 / \$3,500           | 117-481 / \$3,851 | 117-553 / \$4,130 | \$4,659           | \$5,100  |
| AX-144            | 117-144 / \$3,823           | 117-484 / \$4,205 | \$4,627           | \$5,090           | \$5,590  |
| AX-180            | 117-180 / \$4,038           | 117-487 / \$4,441 | \$4,884           | \$5,370           | \$5,920  |
| AX-200            | 117-200 / \$4,313           | 117-490 / \$4,743 | 117-449 / \$5,220 | \$5,740           | \$6,310  |
| AX-240            | 117-408 / \$4,939           | 117-493 / \$5,430 | \$5,970           | \$6,580           | \$7,230  |
| AX-260            | 117-420 / \$6,760           | 117-496 / \$7,430 | \$8,170           | \$8,990           | \$9,890  |
| AX-280            | 117-430 / \$8,200           | 117-499 / \$9,020 | 117-638 / \$9,240 | \$10,900          | \$12,025 |

**Additional Options:** Add to Base Model List Price  
**Sight Glass (SG):** \$336  
**Restraints (Saddles) (R):** AX-15 & 20: \$149, AX-40 & 60: \$229, AX-80 through 200: \$344, AX-240 through 280: \$459

**Standard Leadtime:** 125 & 150 PSI: 10 Days, 175 PSI: 30 Days, 250 & 300 PSI: 40 Days  
**Connection:** Malleable Iron: AX-15 through AX-60: 1/2", AX-80 through AX-240: 1", AX-260 & AX-280: 1-1/4"  
 AX-15 through AX-100: NPTF, Center  
 AX-120 through AX-240: NPTM, Center  
 AX-260 & AX-280: NPTM, Offset  
**Factory Precharge:** All models: 12 PSI  
**Warranty:** 1-Year Limited

COMMERCIAL PRODUCTS



## APPLICATIONS & ORDERING

- For use in non-potable closed hydronic and chilled water systems.
- Fixed diaphragm construction.
- Available in Horizontal and Vertical configurations.
- Constructed to ASME Section VIII, Division 1.
- Maximum Operating Temperature: 240° F.

## How to Order: Specify Model & Options

AX-120V-150

- Step 1: Select Base Model Number  
 Step 2: Choose Pressure Rating  
 Step 3: Specify Sight Glass Option (or leave blank)  
 Step 4: Specify Restraint Option (or leave blank)

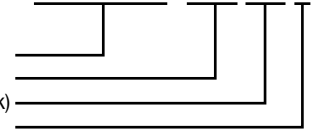

AX-120V (Vertical) 150 PSI Rating (No Sight Glass and Restraints)

## AX-V MODELS: VERTICAL DIAPHRAGM TYPE, ASME

J

### TECHNICAL DATA

| Base Model Number | Volume (Gal) | Max Acceptance Volume (Gal) | A Diameter (In) | B Height (In) | Shipping Weight (Lbs) |         |         |         |         |
|-------------------|--------------|-----------------------------|-----------------|---------------|-----------------------|---------|---------|---------|---------|
|                   |              |                             |                 |               | 125 PSI               | 150 PSI | 175 PSI | 250 PSI | 300 PSI |
| AX-15V            | 8.0          | 2.4                         | 12              | 20            | 39                    | 41      | 49      | 59      | 62      |
| AX-20V            | 10.9         | 2.4                         | 12              | 27            | 47                    | 49      | 61      | 71      | 75      |
| AX-40V            | 21.7         | 11.3                        | 16              | 30            | 76                    | 80      | 99      | 114     | 122     |
| AX-60V            | 33.6         | 11.3                        | 16              | 45            | 98                    | 103     | 127     | 147     | 157     |
| AX-80V            | 44.4         | 22.6                        | 24              | 29            | 155                   | 167     | 201     | 233     | 248     |
| AX-100V           | 55.7         | 22.6                        | 24              | 34            | 176                   | 187     | 229     | 264     | 282     |
| AX-120V           | 68.0         | 34.0                        | 24              | 47            | 214                   | 255     | 278     | 321     | 342     |
| AX-144V           | 77.0         | 34.0                        | 24              | 52            | 230                   | 267     | 299     | 345     | 368     |
| AX-180V           | 90.0         | 34.0                        | 24              | 60            | 271                   | 275     | 352     | 407     | 434     |
| AX-200V           | 110.0        | 34.0                        | 24              | 66            | 290                   | 358     | 377     | 435     | 464     |
| AX-240V           | 132.0        | 46.0                        | 30              | 58            | 401                   | 403     | 521     | 602     | 642     |
| AX-260V           | 159.0        | 56.0                        | 30              | 65            | 460                   | 467     | 598     | 690     | 736     |
| AX-280V           | 211.0        | 84.0                        | 30              | 82            | 590                   | 605     | 767     | 885     | 945     |

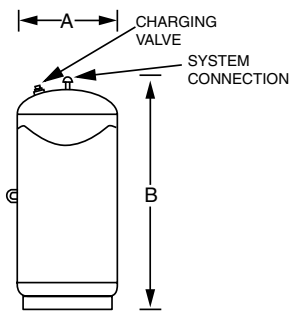

AX-15V THROUGH AX-100V

### PRICING: ASME MODELS

| Base Model Number | Part No. / List Price (USD) |                   |                    |                    |                   |
|-------------------|-----------------------------|-------------------|--------------------|--------------------|-------------------|
|                   | 125 PSI                     | 150 PSI           | 175 PSI            | 250 PSI            | 300 PSI           |
| AX-15V            | 117-401 / \$1,611           | 117-461 / \$1,772 | 117-454 / \$1,948  | 117-551 / \$2,143  | 117-586 / \$2,359 |
| AX-20V            | 117-402 / \$1,636           | 117-464 / \$1,799 | 117-452 / \$1,979  | 117-573 / \$2,177  | \$2,396           |
| AX-40V            | 117-403 / \$2,300           | 117-467 / \$2,528 | 117-453 / \$2,782  | 117-637 / \$3,061  | 117-625 / \$3,366 |
| AX-60V            | 117-0062 / \$2,526          | 117-470 / \$2,780 | 117-0559 / \$3,058 | 117-591 / \$3,364  | \$3,702           |
| AX-80V            | 117-81 / \$3,224            | 117-474 / \$3,546 | 117-588 / \$3,901  | 117-569 / \$4,291  | \$4,722           |
| AX-100V           | 117-101 / \$3,323           | 117-479 / \$3,654 | \$4,020            | 117-558 / \$4,422  | 117-550 / \$4,867 |
| AX-120V           | 117-121 / \$3,993           | 117-483 / \$4,394 | 117-620 / \$4,834  | 117-593 / \$5,310  | \$5,860           |
| AX-144V           | 117-145 / \$4,255           | 117-486 / \$4,681 | \$5,150            | 117-102 / \$5,680  | 117-589 / \$6,240 |
| AX-180V           | 117-181 / \$4,830           | 117-489 / \$5,310 | 117-565 / \$5,860  | \$6,430            | \$7,070           |
| AX-200V           | 117-201 / \$4,945           | 117-492 / \$5,440 | 117-585 / \$5,980  | 117-557 / \$6,590  | \$7,240           |
| AX-240V           | 117-281 / \$5,690           | 117-495 / \$6,250 | \$6,870            | \$7,560            | 117-598 / \$8,320 |
| AX-260V           | 117-421 / \$6,870           | 117-498 / \$7,560 | \$8,330            | \$9,160            | \$10,075          |
| AX-280V           | 117-431 / \$8,480           | 117-501 / \$9,320 | 117-580 / \$10,250 | 117-572 / \$11,275 | \$12,400          |

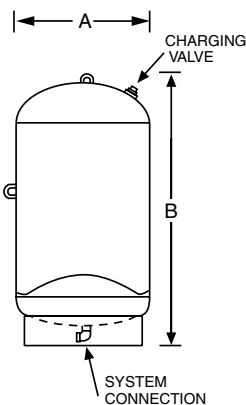

AX-120V THROUGH AX-240V

- Additional Options:** Add to Base Model List Price  
**Sight Glass (SG):** \$336  
**Seismic Restraints (R):** \$236

- Standard Leadtime:** 125 & 150 PSI: 10 Days, 175 PSI: 30 Days, 250 & 300 PSI: 40 Days  
**Connection (NPT):** Malleable Iron: AX-15V through AX-60V: 1/2", AX-80V through AX-240V: 1", AX-260V & AX-280V: 1-1/4"  
 AX-15V through AX-100V: NPTF, Center  
 AX-120V through AX-240V: NPTF, Bottom  
 AX-260V & AX-280V: NPTM, Offset

- Factory Precharge:** All models: 12 PSI  
**Warranty:** 1-Year Limited

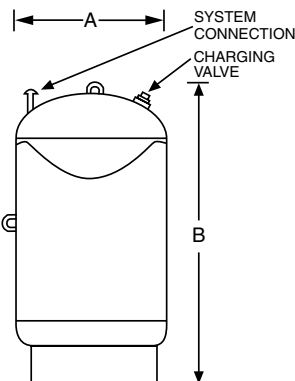

AX-260V & AX-280V

## APPLICATIONS & ORDERING

- For use in non-potable closed hydronic and chilled water systems.
- Replaceable bladder construction.
- Available in Full Acceptance versions.
- Constructed to ASME Section VIII, Division 1.
- Maximum Operating Temperature: 240° F.

## How to Order: Specify Model & Options

800-L-175SGR

- Step 1: Select Base Model Number  
 Step 2: Choose Pressure Rating  
 Step 3: Specify Sight Glass Option (or leave blank)  
 Step 4: Specify Restraint Option (or leave blank)

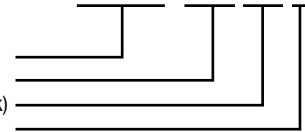

800-L 175 PSI Rating with Sight Glass & Restraints

## L MODELS: FULL ACCEPTANCE BLADDER, TOP CONNECTION, ASME

J

### TECHNICAL DATA

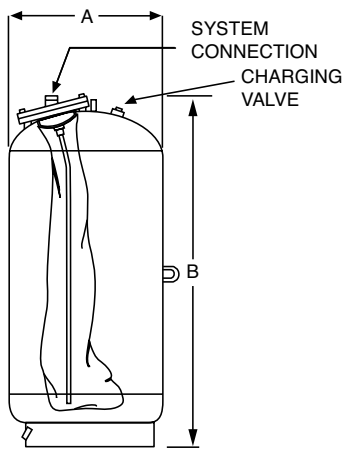

| Base Model Number | Volume (Gal) | Max Acceptance Volume (Gal) | A Diameter (In) | B Height (In) | Shipping Weight (Lbs) |         |         |         |         |
|-------------------|--------------|-----------------------------|-----------------|---------------|-----------------------|---------|---------|---------|---------|
|                   |              |                             |                 |               | 125 PSI               | 150 PSI | 175 PSI | 250 PSI | 300 PSI |
| 200-L             | 53           | 53                          | 24              | 38            | 190                   | 205     | 250     | 290     | 297     |
| 300-L             | 80           | 80                          | 24              | 52            | 230                   | 292     | 320     | 385     | 372     |
| 400-L             | 106          | 106                         | 24              | 66            | 275                   | 343     | 375     | 465     | 595     |
| 500-L             | 132          | 132                         | 24              | 79            | 311                   | 372     | 435     | 545     | 750     |
| 600-L             | 158          | 158                         | 30              | 64            | 439                   | 510     | 595     | 720     | 810     |
| 800-L             | 211          | 211                         | 30              | 82            | 543                   | 565     | 620     | 905     | 950     |
| 1000-L            | 264          | 264                         | 36              | 74            | 609                   | 750     | 750     | 1,015   | 1,065   |
| 1200-L            | 317          | 317                         | 36              | 86            | 700                   | 860     | 860     | 1,175   | 1,235   |
| 1400-L            | 370          | 370                         | 36              | 98            | 783                   | 970     | 970     | 1,335   | 1,400   |
| 1600-L            | 422          | 422                         | 48              | 69            | 1,106                 | 1,425   | 1,615   | 1,916   | 2,015   |
| 2000-L            | 528          | 528                         | 48              | 84            | 1,284                 | 1,675   | 2,386   | 2,410   | 2,651   |
| 2500-L            | 660          | 660                         | 48              | 101           | 1,544                 | 1,945   | 2,411   | 2,585   | 2,715   |
| 3000-L            | 792          | 792                         | 48              | 118           | 1,719                 | 2,225   | 2,500   | 2,950   | 3,100   |
| 3500-L            | 925          | 925                         | 54              | 111           | 2,187                 | 2,375   | 2,620   | 3,660   | 3,780   |
| 4000-L            | 1,057        | 1,057                       | 54              | 125           | 2,352                 | 2,640   | 3,000   | 4,080   | 4,285   |
| 5000-L            | 1,321        | 1,321                       | 60              | 128           | 2,450                 | 3,740   | 4,100   | 4,200   | 5,200   |
| 7500-L            | 1,980        | 1,980                       | 72              | 127           | 4,000                 | 4,300   | 4,500   | 5,550   | 6,750   |
| 10000-L           | 2,640        | 2,640                       | 72              | 159           | 4,900                 | 5,300   | 5,500   | 6,800   | 11,000  |
| 15000-L           | 3,963        | 3,963                       | 72              | 233           | 6,000                 | 7,600   | 7,900   | 9,800   | 12,500  |

### 200-L THROUGH 15000-L

### PRICING: ASME MODELS

| Base Model Number | Part No. / List Price (USD) |                     |                    |                    |                    |
|-------------------|-----------------------------|---------------------|--------------------|--------------------|--------------------|
|                   | 125 PSI                     | 150 PSI             | 175 PSI            | 250 PSI            | 300 PSI            |
| 200-L             | 191-2 / \$5,230             | 117-509 / \$6,070   | 191-19 / \$6,920   | 191-18 / \$7,960   | 191-42 / \$9,150   |
| 300-L             | 192-2 / \$5,590             | 117-510 / \$6,440   | 192-20 / \$7,410   | 192-19 / \$8,510   | 192-39 / \$9,800   |
| 400-L             | 193-2 / \$5,950             | 117-511 / \$6,840   | 193-20 / \$7,880   | 193-19 / \$9,060   | 193-41 / \$10,425  |
| 500-L             | 194-2 / \$6,250             | 117-512 / \$7,180   | 194-19 / \$8,260   | 194-18 / \$9,500   | 194-37 / \$10,925  |
| 600-L             | 174-2 / \$8,810             | 117-513 / \$10,150  | 174-22 / \$11,675  | 174-23 / \$13,425  | 194-39 / \$15,425  |
| 800-L             | 175-2 / \$9,570             | 117-514 / \$11,000  | 175-22 / \$12,675  | 175-23 / \$14,550  | 175-37 / \$16,750  |
| 1000-L            | 176-2 / \$11,000            | 117-515 / \$12,700  | 176-22 / \$14,600  | 176-23 / \$16,775  | 176-35 / \$19,275  |
| 1200-L            | 177-2 / \$11,750            | 117-516 / \$13,500  | 177-22 / \$15,550  | 177-16 / \$17,875  | 177-33 / \$20,550  |
| 1400-L            | 178-2 / \$12,575            | 117-517 / \$14,450  | 178-22 / \$16,625  | 178-23 / \$19,100  | 178-34 / \$21,975  |
| 1600-L            | 179-2 / \$18,075            | 117-518 / \$20,825  | 179-22 / \$23,925  | 179-23 / \$27,500  | 179-34 / \$31,675  |
| 2000-L            | 180-2 / \$19,625            | 117-519 / \$22,550  | 180-22 / \$25,900  | 180-23 / \$29,825  | 180-74 / \$34,300  |
| 2500-L            | 180-33 / \$22,625           | 117-520 / \$26,100  | 180-40 / \$29,950  | 180-43 / \$34,450  | 180-76 / \$39,575  |
| 3000-L            | 180-34 / \$28,775           | 117-521 / \$33,000  | 180-39 / \$38,000  | 180-44 / \$43,700  | 180-64 / \$50,250  |
| 3500-L            | 189-1 / \$34,875            | 117-522 / \$40,125  | 180-41 / \$46,125  | 180-45 / \$53,050  | 180-78 / \$61,100  |
| 4000-L            | 189-2 / \$40,575            | 117-523 / \$47,825  | 180-42 / \$53,600  | 180-46 / \$61,750  | 180-79 / \$71,000  |
| 5000-L            | 189-3 / \$53,550            | 117-940 / \$61,650  | 180-65 / \$70,800  | 189-7 / \$81,450   | 180-129 / \$93,700 |
| 7500-L            | 189-24 / \$94,550           | 117-473 / \$108,800 | 180-55 / \$124,900 | 189-42 / \$143,800 | 180-81 / \$165,400 |
| 10000-L           | 180-137 / \$108,400         | 117-941 / \$124,500 | 180-57 / \$143,300 | 180-58 / \$164,800 | 180-82 / \$189,400 |
| 15000-L           | 189-10 / \$144,000          | 117-475 / \$165,500 | 180-59 / \$190,400 | 180-60 / \$218,900 | 180-83 / \$251,700 |

**Additional Options:** Add to Base Model List Price  
**Sight Glass (SG):** \$336  
**Seismic Restraints (R):** \$236

**Standard Leadtime:** 200-L through 4000-L: 125 & 150 PSI: 10 Days, 175 PSI: 30 Days, 250 & 300 PSI: 40 Days  
 5000-L: 125 & 150 PSI: 20 Days, 175 PSI: 40 Days, 250 & 300 PSI: 60 Days,  
 7500-L through 15000-L: All pressures: 60 Days

**Connection (NPTF):** Malleable Iron: 200-L through 500-L: 1", 600-L through 2000-L: 1-1/2",  
 2500-L through 5000-L: 2", 7500-L through 15000-L: 3"

**Factory Precharge:** All models: 12 PSI  
**Warranty:** 1-Year Limited

## APPLICATIONS & ORDERING

- For use in non-potable closed hydronic and chilled water systems.
- Replaceable bladder construction.
- Available in Partial Acceptance versions.
- Constructed to ASME Section VIII, Division 1.
- Maximum Operating Temperature: 240° F.

## How to Order: Specify Model & Options

130-LBC-125 R

Step 1: Select Base Model Number  
 Step 2: Choose Pressure Rating  
 Step 3: Specify Sight Glass Option (or leave blank)  
 Step 4: Specify Restraint Option (or leave blank)

**130-LBC 125 PSI Rating with Restraints (No Sight Glass)**

## LBC MODELS: PARTIAL ACCEPTANCE BLADDER, BOTTOM CONNECTION, ASME J

### TECHNICAL DATA

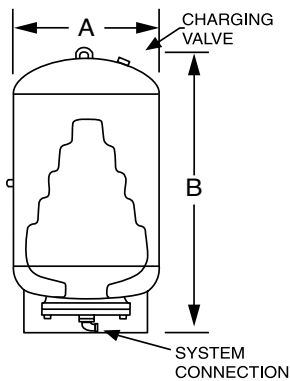

| Base Model Number | Volume (Gal) | Max Acceptance Volume (Gal) | A Diameter (In) | B Height (In) | Shipping Weight (Lbs) |         |         |         |         |
|-------------------|--------------|-----------------------------|-----------------|---------------|-----------------------|---------|---------|---------|---------|
|                   |              |                             |                 |               | 125 PSI               | 150 PSI | 175 PSI | 250 PSI | 300 PSI |
| 35-LBC            | 10           | 10                          | 10              | 37            | 67                    | 76      | 80      | 94      | 100     |
| 50-LBC            | 13           | 11                          | 12              | 37            | 76                    | 78      | 91      | 106     | 114     |
| 85-LBC            | 22           | 11                          | 16              | 35            | 92                    | 95      | 110     | 129     | 138     |
| 100-LBC           | 26           | 11                          | 16              | 39            | 99                    | 102     | 119     | 138     | 150     |
| 130-LBC           | 34           | 27                          | 20              | 35            | 135                   | 140     | 162     | 189     | 202     |
| 165-LBC           | 44           | 27                          | 20              | 40            | 149                   | 153     | 178     | 214     | 225     |
| 200-LBC           | 53           | 27                          | 24              | 41            | 195                   | 205     | 234     | 273     | 293     |
| 300-LBC           | 80           | 27                          | 24              | 56            | 233                   | 254     | 280     | 326     | 350     |
| 400-LBC           | 106          | 53                          | 24              | 69            | 274                   | 308     | 329     | 383     | 411     |
| 500-LBC           | 132          | 53                          | 24              | 83            | 310                   | 352     | 372     | 434     | 465     |
| 600-LBC           | 158          | 53                          | 30              | 67            | 438                   | 442     | 525     | 613     | 657     |

### PRICING: ASME MODELS

| Base Model Number | Part No. / List Price (USD) |                   |                   |                  |                  |
|-------------------|-----------------------------|-------------------|-------------------|------------------|------------------|
|                   | 125 PSI                     | 150 PSI           | 175 PSI           | 250 PSI          | 300 PSI          |
| 35-LBC            | 165-5 / \$3,732             | 165-10 / \$4,291  | \$4,937           | \$5,690          | \$6,520          |
| 50-LBC            | 166-5 / \$3,773             | 166-10 / \$4,337  | \$4,875           | 166-18 / \$5,740 | 166-1 / \$6,600  |
| 85-LBC            | 167-4 / \$3,825             | 167-10 / \$4,399  | \$5,060           | \$5,820          | 167-18 / \$6,700 |
| 100-LBC           | 168-4 / \$3,882             | 168-10 / \$4,465  | \$5,130           | \$5,910          | \$6,800          |
| 130-LBC           | 169-4 / \$3,935             | 117-502 / \$4,525 | \$5,200           | \$5,980          | \$6,880          |
| 165-LBC           | 171-15 / \$4,032            | 117-503 / \$4,638 | 117-601 / \$5,340 | \$6,130          | \$7,060          |
| 200-LBC           | 191-33 / \$4,098            | 117-504 / \$4,712 | \$5,420           | \$6,240          | \$7,170          |
| 300-LBC           | 192-31 / \$4,230            | 117-505 / \$4,866 | \$5,590           | \$6,440          | \$7,410          |
| 400-LBC           | 193-32 / \$4,981            | 117-506 / \$5,730 | 117-103 / \$6,600 | \$7,570          | \$8,710          |
| 500-LBC           | 194-32 / \$5,370            | 117-507 / \$6,170 | \$7,110           | \$8,170          | \$9,400          |
| 600-LBC           | 174-36 / \$6,700            | 117-508 / \$7,710 | \$8,870           | \$10,200         | \$11,750         |

**Additional Options:** Add to Base Model List Price  
**Sight Glass (SG):** \$336  
**Seismic Restraints (R):** \$236

**Standard Leadtime:** 125 & 150 PSI: 10 Days, 175 PSI: 30 Days, 250 & 300 PSI: 40 Days  
**Connection (NPTF):** Malleable Iron: All LBC Models: 1"  
**Factory Precharge:** All models: 12 PSI  
**Warranty:** 1-Year Limited

### 35-LBC THROUGH 600-LBC

## APPLICATIONS & ORDERING

- For use in non-potable closed hydronic and chilled water systems.
- Constructed to ASME Section VIII, Division 1.

## How to Order: Specify Model & Options

6-ASL-125

Step 1: Select Base Model Number  
Step 2: Choose Pressure Rating

6-Inch Air Separator Less Strainer, 125 PSI Rating

## TANGENTIAL AIR SEPARATORS, LESS STRAINER, ASME

J

### TECHNICAL DATA

| Base Model Number | Connection Size (In) | A Width (In) | B Height (In) | Shipping Weight (Lbs) |         |         |         |         |
|-------------------|----------------------|--------------|---------------|-----------------------|---------|---------|---------|---------|
|                   |                      |              |               | 125 PSI               | 150 PSI | 175 PSI | 250 PSI | 300 PSI |
| 1-ASL             | 1                    | 7            | 12            | 14                    | 15      | N/A     | N/A     | N/A     |
| 2-ASL             | 2                    | 18           | 23            | 41                    | 43      | 59      | 65      | 74      |
| 2 1/2-ASL         | 2-1/2                | 18           | 23            | 50                    | 54      | 70      | 80      | 90      |
| 3-ASL             | 3                    | 18           | 24            | 56                    | 60      | 80      | 90      | 100     |
| 4-ASL             | 4                    | 23           | 25            | 66                    | 79      | 92      | 105     | 118     |
| 5-ASL             | 5                    | 26           | 40            | 175                   | 195     | 266     | 280     | 315     |
| 6-ASL             | 6                    | 28           | 45            | 190                   | 210     | 330     | 350     | 400     |
| 8-ASL             | 8                    | 34           | 57            | 350                   | 400     | 490     | 560     | 630     |
| 10-ASL            | 10                   | 42           | 63            | 700                   | 750     | 950     | 1,120   | 1,260   |
| 12-ASL            | 12                   | 48           | 82            | 912                   | 990     | 1,200   | 1,460   | 1,640   |
| 14-ASL            | 14                   | 58           | 102           | 1,853                 | 2,150   | 2,800   | 2,965   | 3,335   |
| 16-ASL            | 16                   | 66           | 104           | 2,610                 | 3,600   | 4,060   | 4,175   | 4,700   |
| 18-ASL            | 18                   | 66           | 114           | 2,900                 | 4,000   | 4,600   | 5,100   | 5,400   |
| 20-ASL            | 20                   | 72           | 110           | 4,560                 | 5,800   | 6,500   | 7,300   | 8,200   |
| 22-ASL            | 22                   | 72           | 126           | 5,320                 | 6,000   | 7,000   | 8,500   | 9,575   |
| 24-ASL            | 24                   | 84           | 147           | 6,175                 | 7,000   | 8,500   | 9,880   | 11,000  |

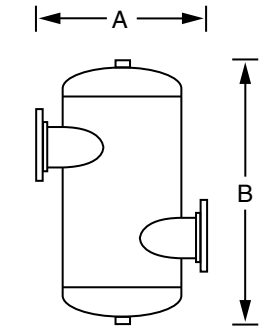

1-ASL through 4-ASL

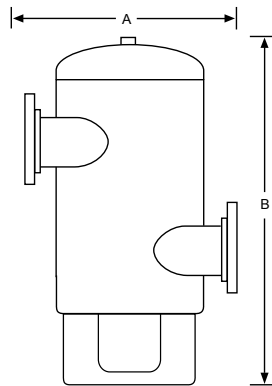

5-ASL through 24-ASL

### PRICING: ASME MODELS

| Base Model Number | Part No. / List Price (USD) |                   |                   |                   |                   |
|-------------------|-----------------------------|-------------------|-------------------|-------------------|-------------------|
|                   | 125 PSI                     | 150 PSI           | 175 PSI           | 250 PSI           | 300 PSI           |
| 1-ASL             | 489-1 / \$1,236             | 489-5 / \$1,363   | N/A               | N/A               | N/A               |
| 2-ASL             | 490-6 / \$1,402             | 490-26 / \$1,540  | \$1,960           | 490-28 / \$2,239  | \$2,518           |
| 2 1/2-ASL         | 491-6 / \$1,587             | 491-15 / \$1,745  | \$2,218           | 491-18 / \$2,539  | 491-16 / \$2,852  |
| 3-ASL             | 492F0006 / \$1,916          | 492-27 / \$2,106  | 492-31 / \$2,684  | 492-32 / \$3,064  | 492-28 / \$3,453  |
| 4-ASL             | 493-0006 / \$2,232          | 493-29 / \$2,455  | 493-33 / \$3,130  | 493-10 / \$3,575  | 493-31 / \$4,022  |
| 5-ASL             | 494-0006 / \$2,644          | 494-23 / \$2,910  | 494-21 / \$3,699  | 494-17 / \$4,233  | \$4,757           |
| 6-ASL             | 495-6 / \$3,237             | 495-28 / \$3,561  | 495-21 / \$4,500  | 495-17 / \$5,180  | \$5,830           |
| 8-ASL             | 496-6 / \$4,383             | 496-26 / \$4,821  | 496-18 / \$6,140  | 496-14 / \$7,000  | 496-29 / \$7,890  |
| 10-ASL            | 497-6 / \$7,580             | 497-18 / \$8,340  | 497-27 / \$10,625 | 497-28 / \$12,125 | 497-21 / \$13,650 |
| 12-ASL            | 498-6 / \$8,750             | 498-19 / \$9,620  | \$12,250          | 191-40 / \$14,000 | 191-38 / \$15,725 |
| 14-ASL            | 499-6 / \$14,900            | 499-46 / \$16,375 | \$20,850          | 499-66 / \$23,825 | \$26,825          |
| 16-ASL            | 499-24 / \$18,825           | 499-47 / \$20,700 | \$26,325          | \$30,100          | 502-4 / \$33,925  |
| 18-ASL            | 499-15 / \$28,425           | 499-48 / \$31,275 | \$39,775          | \$45,450          | \$51,150          |
| 20-ASL            | 499-27 / \$37,350           | 499-49 / \$41,100 | \$52,300          | \$59,800          | \$67,250          |
| 22-ASL            | 499-55 / \$43,350           | 499-31 / \$47,675 | \$60,700          | \$69,300          | \$77,950          |
| 24-ASL            | 499-19 / \$49,775           | 499-50 / \$54,700 | \$69,700          | \$79,650          | \$89,550          |

#### Additional Options:

#### Standard Leadtime:

#### Connection:

#### Warranty:

Grooved Pipe Connectors (G): Available on models 2-ASL through 14-ASL. Consult factory for pricing.  
 1-ASL through 12-ASL: 10 Days, 14-ASL through 18-ASL: 30 Days, 20-ASL through 24-ASL: Consult Amtrol Customer Service. Add 10 days to Standard Leadtime for Grooved Pipe Connectors (G).  
 125, 150, and 175 PSI: 150# flanges; 250 and 300 PSI: 300# flanges.  
 1-Year Limited

## APPLICATIONS & ORDERING

- For use in non-potable closed hydronic and chilled water systems.
- Choose from Tangential (vortex) or Inline (air scoop) styles.
- Constructed to ASME Section VIII, Division 1.

## How to Order: Specify Model & Options

6-AS-125

Step 1: Select Base Model Number  
Step 2: Choose Pressure Rating

6-Inch Air Separator With Strainer, 125 PSI Rating

## TANGENTIAL AIR SEPARATORS, WITH STRAINER, ASME

J

### TECHNICAL DATA

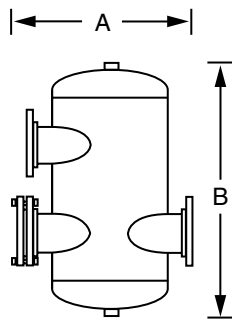

2-AS THROUGH 4-AS

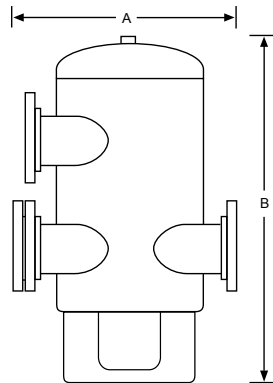

5-AS through 24-AS

| Base Model Number | Connection Size (In) | A Width (In) | B Height (In) | Shipping Weight (Lbs) |         |         |         |         |
|-------------------|----------------------|--------------|---------------|-----------------------|---------|---------|---------|---------|
|                   |                      |              |               | 125 PSI               | 150 PSI | 175 PSI | 250 PSI | 300 PSI |
| 2-AS              | 2                    | 18           | 23            | 45                    | 47      | 63      | 72      | 81      |
| 2 1/2-AS          | 2-1/2                | 18           | 23            | 54                    | 58      | 75      | 86      | 97      |
| 3-AS              | 3                    | 18           | 24            | 60                    | 64      | 84      | 96      | 108     |
| 4-AS              | 4                    | 23           | 25            | 70                    | 83      | 98      | 112     | 126     |
| 5-AS              | 5                    | 26           | 40            | 200                   | 220     | 280     | 320     | 360     |
| 6-AS              | 6                    | 28           | 45            | 249                   | 261     | 348     | 398     | 448     |
| 8-AS              | 8                    | 34           | 57            | 375                   | 445     | 525     | 600     | 675     |
| 10-AS             | 10                   | 42           | 63            | 750                   | 800     | 1,050   | 1,200   | 1,350   |
| 12-AS             | 12                   | 48           | 82            | 950                   | 1,060   | 1,330   | 1,520   | 1,710   |
| 14-AS             | 14                   | 58           | 102           | 2,200                 | 2,500   | 3,080   | 3,520   | 3,960   |
| 16-AS             | 16                   | 66           | 104           | 3,000                 | 3,900   | 4,200   | 4,800   | 5,400   |
| 18-AS             | 18                   | 66           | 114           | 3,500                 | 4,700   | 4,900   | 5,600   | 6,300   |
| 20-AS             | 20                   | 72           | 110           | 5,000                 | 6,100   | 7,000   | 8,000   | 9,000   |
| 22-AS             | 22                   | 72           | 126           | 5,500                 | 6,600   | 7,700   | 8,800   | 9,900   |
| 24-AS             | 24                   | 84           | 147           | 7,000                 | 8,400   | 9,800   | 11,200  | 12,600  |

### PRICING: ASME MODELS

| Base Model Number | Part No. / List Price (USD) |                   |                   |                   |                   |
|-------------------|-----------------------------|-------------------|-------------------|-------------------|-------------------|
|                   | 125 PSI                     | 150 PSI           | 175 PSI           | 250 PSI           | 300 PSI           |
| 2-AS              | 490-7 / \$1,570             | 490-25 / \$1,805  | 490-27 / \$2,195  | \$2,507           | \$2,829           |
| 2 1/2-AS          | 491-7 / \$1,736             | 491-14 / \$1,996  | 491-17 / \$2,428  | \$2,774           | \$3,120           |
| 3-AS              | 492F0007 / \$2,327          | 492-26 / \$2,674  | 492-30 / \$3,253  | 492-29 / \$3,720  | 492-33 / \$4,188  |
| 4-AS              | 493-0007 / \$2,518          | 493-28 / \$2,896  | 493-32 / \$3,521  | 493-30 / \$4,033  | \$4,534           |
| 5-AS              | 494-0007 / \$3,378          | 494-22 / \$3,886  | \$4,723           | \$5,410           | 494-16 / \$6,080  |
| 6-AS              | 495-7 / \$4,190             | 495-27 / \$4,818  | 495-20 / \$5,870  | 495-31 / \$6,710  | \$7,540           |
| 8-AS              | 496-7 / \$5,410             | 496-25 / \$6,220  | 496-20 / \$7,570  | 496-10 / \$8,650  | 496-36 / \$9,730  |
| 10-AS             | 497-7 / \$9,220             | 497-17 / \$10,600 | 497-22 / \$12,900 | 497-20 / \$14,725 | 497-23 / \$16,600 |
| 12-AS             | 498-7 / \$11,150            | 498-18 / \$13,750 | 498-21 / \$15,650 | 191-44 / \$17,875 | 498-23 / \$20,100 |
| 14-AS             | 499-7 / \$18,600            | 499-41 / \$21,400 | 499-69 / \$26,050 | 499-71 / \$29,775 | 499-74 / \$33,475 |
| 16-AS             | 499-10 / \$23,050           | 499-42 / \$26,475 | 499-68 / \$32,250 | 502-2 / \$36,850  | 502-1 / \$41,475  |
| 18-AS             | 499-33 / \$35,475           | 499-43 / \$40,800 | 503-03 / \$49,700 | 503-1 / \$56,800  | 499-73 / \$63,850 |
| 20-AS             | 499-29 / \$46,700           | 499-44 / \$53,700 | \$65,350          | 499-70 / \$74,700 | 499-72 / \$84,050 |
| 22-AS             | 499-35 / \$67,100           | 499-54 / \$77,250 | \$94,000          | \$107,400         | \$121,000         |
| 24-AS             | 499-40 / \$76,350           | 499-45 / \$87,800 | \$106,900         | \$122,200         | \$137,400         |

**Additional Options:** Grooved Pipe Connectors (G): Available on models 2-AS through 14-AS. Consult factory for pricing.  
**Standard Leadtime:** 2-AS through 12-AS: 10 Days, 14-AS through 18-AS: 30 Days, 20-AS through 24-AS: Consult Amtrol Customer Service. Add 10 days to Standard Leadtime for Grooved Pipe Connectors (G).  
**Connection:** 125, 150, and 175 PSI: 150# flanges; 250 and 300 PSI: 300# flanges.  
**Warranty:** 1-Year Limited

## APPLICATIONS & ORDERING

- For use in closed, non-potable water systems.
- Eliminates entrained air and separates debris associated with start-up and maintenance of any hydronic system.
- Constructed to ASME Section VIII, Division 1.

## How to Order: Specify Model & Options

3-ADS-125

Step 1: Select Base Model Number  
Step 2: Choose Pressure Rating

3-inch Air & Dirt Separator, 125 PSI Rating

## AIR & DIRT SEPARATORS, ASME

### TECHNICAL DATA

| Base Model Number | Connection Size (in) | A Width (in) | B Height (in) | Shipping Weight (Lbs) |         |
|-------------------|----------------------|--------------|---------------|-----------------------|---------|
|                   |                      |              |               | 125 PSI               | 150 PSI |
| 2-ADS             | 2                    | 15           | 23            | 60                    | 65      |
| 3-ADS             | 3                    | 20           | 29            | 92                    | 97      |
| 4-ADS             | 4                    | 21           | 29            | 102                   | 110     |
| 5-ADS             | 5                    | 28           | 42            | 144                   | 154     |
| 6-ADS             | 6                    | 28           | 42            | 149                   | 159     |
| 8-ADS             | 8                    | 34           | 49            | 258                   | 270     |
| 10-ADS            | 10                   | 38           | 64            | 384                   | 395     |
| 12-ADS            | 12                   | 43           | 75            | 533                   | 550     |

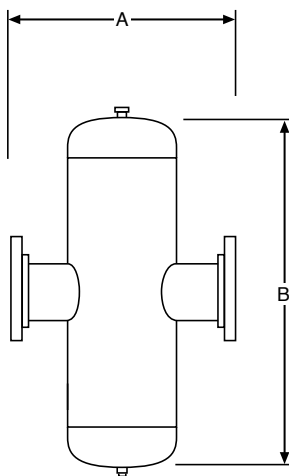

2-ADS THROUGH 12-ADS

### PRICING: ASME MODELS

| Base Model Number | Part No. / List Price (USD) |                   |
|-------------------|-----------------------------|-------------------|
|                   | 125 PSI                     | 150 PSI           |
| 2-ADS             | 523-01 / \$3,428            | 523-02 / \$3,785  |
| 3-ADS             | 523-03 / \$4,510            | 523-07 / \$4,975  |
| 4-ADS             | 523-04 / \$5,680            | 523-09 / \$6,270  |
| 5-ADS             | 523-05 / \$8,490            | 523-11 / \$9,360  |
| 6-ADS             | 523-06 / \$11,900           | 523-12 / \$13,100 |
| 8-ADS             | 523-08 / \$19,125           | 523-13 / \$21,050 |
| 10-ADS            | 523-10 / \$29,425           | 523-14 / \$32,375 |
| 12-ADS            | 523-20 / \$39,800           | 523-21 / \$43,800 |

**Additional Options:**  
**Standard Leadtime:**  
**Connection:**  
**Warranty:**

Grooved Pipe Connectors (G): Available on models 2-ADS through 12-ADS. Consult factory for pricing.  
2-ADS through 12-ADS: 30 Days. Add 10 days to Standard Leadtime for Grooved Pipe Connectors (G).  
125 and 150 PSI: 150# flanges.  
1-Year Limited.

## INLINE AIR PURGERS

- Eliminate air in closed hydronic or chilled water systems.

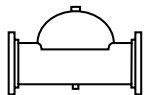

| Model Number | Connection Size (in) | Shipping Weight (Lbs) |         | Part No. / List Price (USD) |  |
|--------------|----------------------|-----------------------|---------|-----------------------------|--|
|              |                      | 125 PSI               | 150 PSI | 125 PSI                     | 150 PSI                                |
| 449*         | 4                    | 56                    | NA      | 449-1 / \$562               | NA                                     |
| 461*         | 5                    | NA                    | 60      | NA                          | 461-1 / \$2,080                        |
| 462*         | 6                    | NA                    | 65      | NA                          | 462-1 / \$2,244                        |
| 463*         | 8                    | NA                    | 113     | NA                          | 463-1 / \$3,004                        |
| 464*         | 10                   | NA                    | 174     | NA                          | 464-1 / \$4,760                        |
| 465*         | 12                   | NA                    | 330     | NA                          | 465-1 / \$5,690                        |
| 466*         | 14                   | NA                    | 500     | NA                          | 466-1 / \$9,070                        |
| 467          | 16                   | NA                    | 231     | NA                          | 467-1 / \$10,350 *150 PSI ANSI Flanges |
| 468          | 18                   | NA                    | 573     | NA                          | 468-1 / \$11,925                       |

**Standard Leadtime:**  
**Warranty:**

Model 449 through 465: 10 Days, Model 466 through 468: 20 Days.  
1-Year Limited

## Air Vents & Plain Steel Tanks

### HIGH CAPACITY AIR VENT

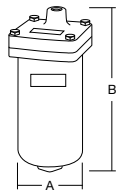

| Model Number | Description                      | A Diameter (In) | B Height (In) | Shipping Weight (Lbs) | List Price (USD) |
|--------------|----------------------------------|-----------------|---------------|-----------------------|------------------|
| 747          | 117-472 High Capacity Vent       | 4               | 10            | 8                     | \$1,023          |
| Repair Kit   | 117-524 Repair Kit & Gasket Assy |                 |               | 1                     | \$169            |

**For venting air from closed hydronic or chilled water systems.**

**Standard Leadtime:** Vent and Repair Kit: 10 Days **Warranty:** 1-Year Limited

### AC MODELS: PLAIN STEEL COMPRESSION TANKS, ASME



**AC12-15 THROUGH AC36-505**

#### PRICING: ASME MODELS

| Model Number | Volume (Gal) | A-Diameter (In) | B-Length (In) | Shipping Weight (Lbs) |          | Part No. / List Price (USD) |                    |
|--------------|--------------|-----------------|---------------|-----------------------|----------|-----------------------------|--------------------|
|              |              |                 |               | 125 PSIG              | 150 PSIG | 125 PSIG                    | 150 PSIG           |
| AC12-15      | 15           | 12              | 33            | NA                    | 44       | NA                          | 183-8014 / \$957   |
| AC12-24      | 24           | 12              | 51            | NA                    | 62       | NA                          | 183-8015 / \$1,007 |
| AC14-30      | 30           | 14              | 48            | NA                    | 72       | NA                          | 183-8016 / \$1,226 |
| AC14-40      | 40           | 14              | 63            | NA                    | 92       | NA                          | 183-8017 / \$1,425 |
| AC16-60      | 60           | 16              | 72            | NA                    | 120      | NA                          | 183-8018 / \$1,659 |
| AC20-80      | 80           | 20              | 63            | 136                   | NA       | 183-8019 / \$1,664          | NA                 |
| AC20-100     | 100          | 20              | 78            | 168                   | NA       | 183-8020 / \$2,485          | NA                 |
| AC24-120     | 120          | 24              | 65            | 218                   | NA       | 183-8021 / \$3,104          | NA                 |
| AC24-135     | 135          | 24              | 72            | 238                   | NA       | 183-8022 / \$3,200          | NA                 |
| AC30-175     | 175          | 30              | 62            | 338                   | NA       | 183-8023 / \$4,778          | NA                 |
| AC30-220     | 220          | 30              | 77            | 368                   | NA       | 183-8024 / \$5,610          | NA                 |
| AC30-240     | 240          | 30              | 84            | 394                   | NA       | 183-8025 / \$5,710          | NA                 |
| AC30-305     | 305          | 30              | 106           | 486                   | NA       | 183-8026 / \$5,990          | NA                 |
| AC36-400     | 400          | 36              | 93            | 645                   | NA       | 183-8028 / \$6,230          | NA                 |
| AC36-505     | 505          | 36              | 120           | 810                   | NA       | 183-8029 / \$6,830          | NA                 |

Maximum Operating Temperature: 450° F

**For use in closed hydronic and chilled water systems.**

**Standard Leadtime:** AC12-15 through AC30-305: 20 days. AC36-400 through AC36-505: 30 days.

**Working Pressure:** AC12-15 through AC16-60:150 PSI. AC20-80 through AC36-505: 125 PSI.

**Warranty:** 1-Year Limited

## APPLICATIONS & ORDERING

- For use in non-potable closed chilled water systems.
- Available with 3" to 12" connections.
- Constructed to ASME Section VIII, Division 1.

## How to Order: Specify Model & Options

CWBT500-6-125 R

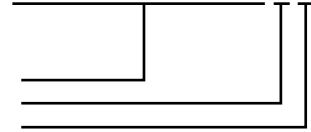

- Step 1: Select Base Model Number  
 Step 2: Specify Sensor Ports  
 Step 3: Specify Restraint Option (or leave blank)

**CWBT500-6 125 PSI Rating with Restraints**

## CWBT MODELS: CHILLED WATER BUFFER TANKS, ASME

### TECHNICAL DATA

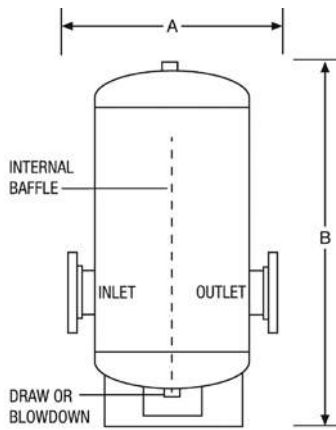

**CWBT120 THROUGH CWBT1040**

| Base Model Number | Volume (Gal) | A Width (In) | B Height (In) | Connection Size (In) | Shipping Weight (Lbs) |         |
|-------------------|--------------|--------------|---------------|----------------------|-----------------------|---------|
|                   |              |              |               |                      | 125 PSI               | 150 PSI |
| CWBT120-3         | 120          | 33           | 56            | 3                    | 294                   | 323     |
| CWBT120-4         | 120          | 33           | 56            | 4                    | 315                   | 347     |
| CWBT120-6         | 120          | 33           | 56            | 6                    | 333                   | 366     |
| CWBT200-3         | 200          | 39           | 63            | 3                    | 527                   | 580     |
| CWBT200-4         | 200          | 39           | 63            | 4                    | 547                   | 602     |
| CWBT200-6         | 200          | 39           | 63            | 6                    | 566                   | 623     |
| CWBT300-4         | 300          | 45           | 80            | 4                    | 753                   | 828     |
| CWBT300-6         | 300          | 45           | 80            | 6                    | 772                   | 849     |
| CWBT300-8         | 300          | 45           | 80            | 8                    | 801                   | 881     |
| CWBT500-6         | 500          | 51           | 99            | 6                    | 1,366                 | 1,503   |
| CWBT500-8         | 500          | 51           | 99            | 8                    | 1,395                 | 1,535   |
| CWBT500-10        | 500          | 51           | 99            | 10                   | 1,490                 | 1,639   |
| CWBT850-6         | 850          | 64           | 115           | 6                    | 2,707                 | 2,978   |
| CWBT850-8         | 850          | 64           | 115           | 8                    | 2,736                 | 3,010   |
| CWBT850-10        | 850          | 64           | 115           | 10                   | 2,771                 | 3,048   |
| CWBT1040-8        | 1040         | 70           | 108           | 8                    | 3,136                 | 3,450   |
| CWBT1040-10       | 1040         | 70           | 108           | 10                   | 3,171                 | 3,488   |
| CWBT1040-12       | 1040         | 70           | 108           | 12                   | 3,283                 | 3,611   |

### PRICING: ASME MODELS

| Base Model Number | Part No. / List Price (USD) |                   |
|-------------------|-----------------------------|-------------------|
|                   | 125 PSI                     | 150 PSI           |
| CWBT120-3         | 517-01 / \$4,757            | 517-28 / \$5,700  |
| CWBT120-4         | 517-02 / \$5,000            | 517-19 / \$6,010  |
| CWBT120-6         | 517-03 / \$5,450            | 517-49 / \$6,540  |
| CWBT200-3         | 517-04 / \$6,230            | 517-38 / \$7,480  |
| CWBT200-4         | 517-05 / \$6,560            | 517-31 / \$7,880  |
| CWBT200-6         | 517-06 / \$7,180            | 517-21 / \$8,620  |
| CWBT300-4         | 517-07 / \$7,840            | \$9,410           |
| CWBT300-6         | 517-08 / \$8,230            | \$9,880           |
| CWBT300-8         | 517-09 / \$9,020            | 517-27 / \$10,825 |
| CWBT500-6         | 517-10 / \$15,150           | 517-34 / \$18,200 |
| CWBT500-8         | 517-11 / \$15,900           | \$19,075          |
| CWBT500-10        | 517-12 / \$17,425           | \$20,925          |
| CWBT850-6         | 517-13 / \$22,575           | 517-25 / \$27,100 |
| CWBT850-8         | 517-14 / \$23,750           | \$28,525          |
| CWBT850-10        | 517-15 / \$26,000           | \$31,200          |
| CWBT1040-8        | 517-16 / \$30,000           | \$36,050          |
| CWBT1040-10       | 517-17 / \$31,475           | \$37,775          |
| CWBT1040-12       | 517-18 / \$34,500           | \$41,425          |

|                                     |                              |
|-------------------------------------|------------------------------|
| <b>Additional Options:</b>          | Add to Base Model List Price |
| <b>Seismic Restraints (R):</b>      | \$236                        |
| <b>Sensor Ports (SP):</b>           | \$336                        |
| <b>Grooved Pipe Connectors (G):</b> | Consult factory for pricing. |

**Standard Leadtime:** CWBT120-3 through CWBT300-8: 10 Days; CWBT500-6 through CWBT850-10: 30 Days; CWBT1040-8 through CWBT1040-12: Consult Amtrol Customer Service.  
 Add 10 days to Standard Leadtime for Grooved Pipe Connectors (G).

**Connection:** 125 and 150 PSI: 150# flanges.  
**Warranty:** 1-Year Limited



## APPLICATIONS & ORDERING

- For use in non-potable closed heating systems.
- Available with 2" to 4" connections.
- Constructed to ASME Section VIII, Division 1.
- Maximum Operating Temperature: 450° F.

## How to Order: Specify Model & Options

HWBT120-2-125SPR

- Step 1: Select Base Model Number  
 Step 2: Specify Sensor Ports  
 Step 3: Specify Restraint Option (or leave blank)



HWBT120-2 125 PSI Rating with Sensor Ports and Restraints

## HWBT MODELS: HOT WATER BUFFER TANKS, ASME

J

### TECHNICAL DATA

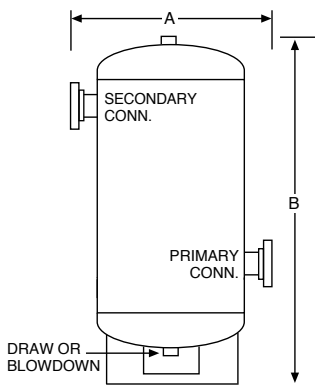

**HWBT120-2 THROUGH  
HWBT300-3**

| Base Model Number | Volume (Gal) | A Width (In) | B Height (In) | Primary Connection Size (In) | Secondary Connection Size (In) | Shipping Weight (Lbs) |         |
|-------------------|--------------|--------------|---------------|------------------------------|--------------------------------|-----------------------|---------|
|                   |              |              |               |                              |                                | 125 PSI               | 150 PSI |
| HWBT120-2         | 120          | 33           | 56            | 2                            | 2                              | 254                   | 279     |
| HWBT120-3         | 120          | 33           | 56            | 3                            | 3                              | 268                   | 295     |
| HWBT200-2         | 200          | 39           | 63            | 2                            | 2                              | 475                   | 523     |
| HWBT200-3         | 200          | 39           | 63            | 3                            | 3                              | 490                   | 539     |
| HWBT300-2         | 300          | 45           | 80            | 2                            | 2                              | 668                   | 735     |
| HWBT300-3         | 300          | 45           | 80            | 3                            | 3                              | 683                   | 751     |
| HWBT120-2/2       | 120          | 33           | 56            | 2                            | 2                              | 267                   | 294     |
| HWBT120-2/3       | 120          | 33           | 56            | 2                            | 3                              | 282                   | 310     |
| HWBT120-3/3       | 120          | 33           | 56            | 3                            | 3                              | 297                   | 327     |
| HWBT120-4/4       | 120          | 33           | 56            | 4                            | 4                              | 338                   | 372     |
| HWBT200-2/2       | 200          | 39           | 63            | 2                            | 2                              | 489                   | 538     |
| HWBT200-2/3       | 200          | 39           | 63            | 2                            | 3                              | 503                   | 553     |
| HWBT200-3/3       | 200          | 39           | 63            | 3                            | 3                              | 518                   | 570     |
| HWBT200-4/4       | 200          | 39           | 63            | 4                            | 4                              | 560                   | 617     |
| HWBT300-2/2       | 300          | 45           | 80            | 2                            | 2                              | 682                   | 750     |
| HWBT300-2/3       | 300          | 45           | 80            | 2                            | 3                              | 696                   | 766     |
| HWBT300-3/3       | 300          | 45           | 80            | 3                            | 3                              | 711                   | 782     |
| HWBT300-4/4       | 300          | 45           | 80            | 4                            | 4                              | 753                   | 828     |

### PRICING: ASME MODELS

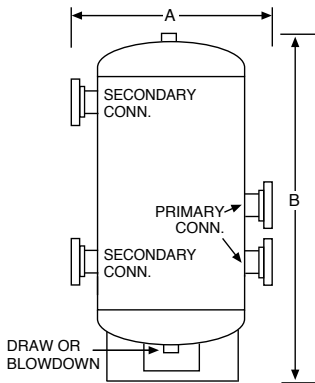

**HWBT120-2/2 THROUGH  
HWBT300-4/4**

| Base Model Number | Part No. / List Price (USD) |                    |
|-------------------|-----------------------------|--------------------|
|                   | 125 PSI                     | 150 PSI            |
| HWBT120-2         | 527-101 / \$4,010           | \$4,813            |
| HWBT120-3         | 527-102 / \$4,266           | \$5,120            |
| HWBT200-2         | 527-201 / \$5,380           | \$6,460            |
| HWBT200-3         | 527-202 / \$5,570           | 527-209 / \$6,690  |
| HWBT300-2         | 527-301 / \$7,160           | \$8,600            |
| HWBT300-3         | 527-302 / \$7,420           | \$8,910            |
| HWBT120-2/2       | 527-103 / \$5,310           | \$6,370            |
| HWBT120-2/3       | 527-104 / \$5,530           | \$6,640            |
| HWBT120-3/3       | 527-105 / \$5,760           | \$6,910            |
| HWBT120-4/4       | 527-106 / \$5,990           | \$7,170            |
| HWBT200-2/2       | 527-203 / \$6,620           | \$7,940            |
| HWBT200-2/3       | 527-204 / \$6,840           | \$8,210            |
| HWBT200-3/3       | 527-205 / \$7,070           | 527-208 / \$8,480  |
| HWBT200-4/4       | 527-206 / \$7,290           | \$8,750            |
| HWBT300-2/2       | 527-303 / \$8,460           | \$10,150           |
| HWBT300-2/3       | 527-304 / \$8,680           | \$10,425           |
| HWBT300-3/3       | 527-305 / \$8,910           | 527-310 / \$10,675 |
| HWBT300-4/4       | 527-306 / \$9,220           | \$11,050           |

- Additional Options:** Add to Base Model List Price  
**Seismic Restraints (R):** \$236  
**Sensor Ports (SP):** \$336  
**Grooved Pipe Connectors (G):** Consult factory for pricing.

- Standard Leadtime:** All Models 10 days.  
 Add 10 days to Standard Leadtime for Grooved Pipe Connectors (G).  
**Connection:** 125 and 150 PSI: 150# flanges.  
**Warranty:** 1-Year Limited

## APPLICATIONS & ORDERING

- For use in potable hot water systems.
- Antimicrobial Liner/ASHRAE 188 Anti-Legionella
- Fixed diaphragm construction.
- Constructed to ASME Section VIII, Division 1.
- Maximum Operating Temperature: 200° F.
- ST-5C through ST-20VC 150 and 175 PSI features deep drawn steel construction.

## How to Order: Specify Model & Options

ST-80VC-150SGR

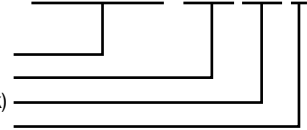

- Step 1: Select Base Model Number  
 Step 2: Choose Pressure Rating  
 Step 3: Specify Sight Glass Option (or leave blank)  
 Step 4: Specify Restraint Option (or leave blank)

ST-80VC 150 PSI Rating with Sight Glass & Restraints

## ST MODELS: DIAPHRAGM TYPE, ASME

J

### TECHNICAL DATA

| Base Model Number | Volume (Gal) | Max Acceptance Volume (Gal) | A Diameter (In) | B Height (In) | Shipping Weight (Lbs) |         |         |         |
|-------------------|--------------|-----------------------------|-----------------|---------------|-----------------------|---------|---------|---------|
|                   |              |                             |                 |               | 150 PSI               | 175 PSI | 250 PSI | 300 PSI |
| ST-5C-DD          | 2.0          | 0.9                         | 8               | 14            | 10                    | 12      | NA      | NA      |
| ST-5C             | 2.1          | 0.9                         | 10              | 10            | NA                    | NA      | 25      | 30      |
| ST-12C-DD         | 6.4          | 3.2                         | 12              | 18            | 17                    | 19      | NA      | NA      |
| ST-12C            | 6.4          | 3.2                         | 12              | 14            | NA                    | NA      | 42      | 50      |
| ST-20VC-DD        | 8.6          | 3.2                         | 12              | 22            | 36                    | 38      | NA      | NA      |
| ST-20VC           | 8.0          | 3.2                         | 12              | 19            | NA                    | NA      | 50      | 62      |
| ST-30VC           | 14.0         | 9.0                         | 16              | 19            | 59                    | 64      | 96      | 108     |
| ST-42VC           | 18.0         | 11.0                        | 16              | 24            | 71                    | 75      | 101     | 112     |
| ST-60VC           | 25.0         | 11.0                        | 16              | 32            | 85                    | 113     | 125     | 139     |
| ST-70VC           | 34.0         | 11.0                        | 16              | 45            | 99                    | 122     | 136     | 151     |
| ST-80VC           | 53.0         | 35.0                        | 24              | 37            | 224                   | 296     | 305     | 340     |
| ST-120VC          | 68.0         | 35.0                        | 24              | 44            | 266                   | 340     | 375     | 400     |
| ST-180VC          | 77.0         | 35.0                        | 24              | 49            | 285                   | 360     | 380     | 420     |
| ST-210VC          | 90.0         | 35.0                        | 24              | 57            | 319                   | 380     | 405     | 440     |

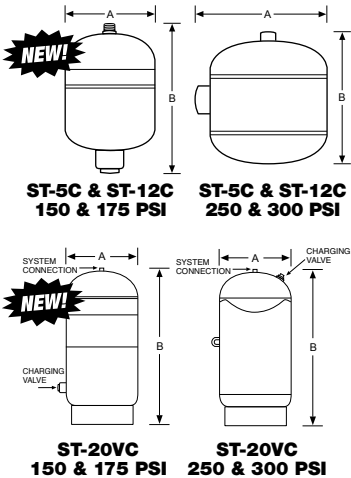

### PRICING: ASME MODELS

| Base Model Number | Part No. / List Price (USD) |                   |                   |                   |
|-------------------|-----------------------------|-------------------|-------------------|-------------------|
|                   | 150 PSI                     | 175 PSI           | 250 PSI           | 300 PSI           |
| ST-5C             | 140-004 / \$1,840           | 140-002 / \$2,022 | 140-751 / \$2,225 | 140-732 / \$2,448 |
| ST-12C            | 141-008 / \$2,403           | 141-007 / \$2,642 | 141-354 / \$2,907 | 141-355 / \$3,198 |
| ST-20VC           | 141-009 / \$2,497           | 141-010 / \$2,748 | 142-181 / \$3,023 | 142-186 / \$3,325 |
| ST-30VC           | 143-218 / \$2,819           | 146-830 / \$3,102 | 143-349 / \$3,411 | 143-368 / \$3,752 |
| ST-42VC           | 144-0148 / \$3,012          | 146-831 / \$3,314 | 144-245 / \$3,645 | \$4,009           |
| ST-60VC           | 146-751 / \$3,497           | 146-804 / \$3,848 | 146-828 / \$4,232 | 146-811 / \$4,655 |
| ST-70VC           | 146-790 / \$3,612           | 146-827 / \$3,974 | 146-829 / \$4,371 | 146-835 / \$4,809 |
| ST-80VC           | 147-139 / \$5,160           | 147-239 / \$5,680 | 147-216 / \$6,250 | 147-231 / \$6,890 |
| ST-120VC          | 147-199 / \$5,420           | 147-240 / \$5,970 | 147-241 / \$6,560 | 147-232 / \$7,210 |
| ST-180VC          | 148-109 / \$5,650           | 148-168 / \$6,220 | 148-170 / \$6,840 | \$7,530           |
| ST-210VC          | 148-110 / \$5,930           | 148-169 / \$6,530 | 148-171 / \$7,180 | \$7,900           |

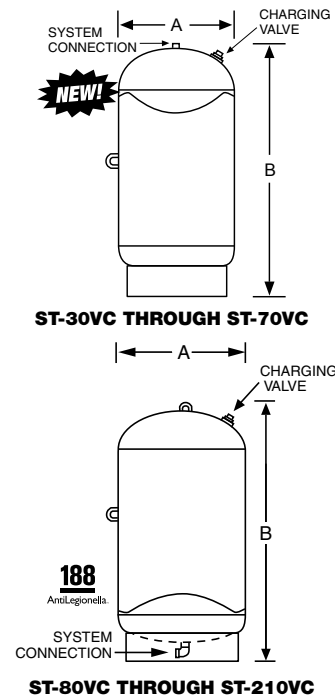

- Additional Options:** Add to Base Model List Price  
**Sight Glass (SG):** \$336  
**Seismic Restraints (R):** \$226

- Standard Leadtime:** 150 PSI: 10 Days, 175 PSI: 20 Days, 250 PSI: 30 Days, 300 PSI: 40 Days  
**Connection:** Stainless Steel: ST-5C 150 PSI and 175 PSI: 3/4" NPTM, ST-5C 250 PSI and 300 PSI: 3/4" NPTF, ST-12C through ST-70VC: 3/4" NPTF, ST-80VC through ST-210VC: 1 1/4" NPTF  
**Factory Precharge:** All models: 55 PSI  
**Warranty:** 1-Year Limited



## APPLICATIONS & ORDERING

- For use in potable hot water systems.
- Replaceable bladder construction.
- Available in ASME Code (C) and non-ASME construction.
- Maximum Operating Temperature: 240° F.

## How to Order: Specify Model & Options

ST-448C-125SGR

- Step 1: Select Base Model Number  
 Step 2: Choose Pressure Rating  
 Step 3: Specify Sight Glass Option (or leave blank)  
 Step 4: Specify Restraint Option (or leave blank)

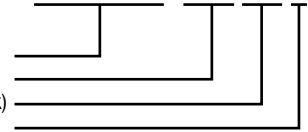

ST-448C 125 PSI Rating with Sight Glass & Restraints

## ST-C (ASME) and ST (NON-ASME) MODELS: FULL ACCEPTANCE BLADDER

J

### TECHNICAL DATA

| Base Model Number | Volume (Gal) | Max Acceptance Volume (Gal) | A Diameter (In) | B Height (In) | Shipping Weight (Lbs) |         |         |         |         |
|-------------------|--------------|-----------------------------|-----------------|---------------|-----------------------|---------|---------|---------|---------|
|                   |              |                             |                 |               | 125 PSI               | 150 PSI | 175 PSI | 250 PSI | 300 PSI |
| ST-447C           | 53           | 53                          | 24              | 45            | 236                   | 262     | 290     | 370     | 425     |
| ST-448C           | 80           | 80                          | 24              | 59            | 274                   | 340     | 430     | 492     | 540     |
| ST-449C           | 106          | 106                         | 24              | 73            | 320                   | 360     | 450     | 510     | 560     |
| ST-450C           | 132          | 132                         | 24              | 87            | 354                   | 400     | 460     | 570     | 632     |
| ST-451(C)         | 158          | 158                         | 30              | 73            | 494                   | 587     | 680     | 815     | 895     |
| ST-452(C)         | 211          | 211                         | 30              | 91            | 593                   | 625     | 699     | 1,005   | 1,107   |
| ST-453(C)         | 264          | 264                         | 36              | 86            | 667                   | 760     | 845     | 1,100   | 1,205   |
| ST-454(C)         | 317          | 317                         | 36              | 98            | 762                   | 850     | 960     | 1,265   | 1,400   |
| ST-455(C)         | 370          | 370                         | 36              | 110           | 842                   | 935     | 1,065   | 1,350   | 1,490   |
| ST-456(C)         | 422          | 422                         | 48              | 82            | 1,152                 | 1,423   | 1,650   | 1,660   | 1,830   |
| ST-457(C)         | 528          | 528                         | 48              | 97            | 1,335                 | 1,505   | 1,875   | 2,230   | 2,455   |

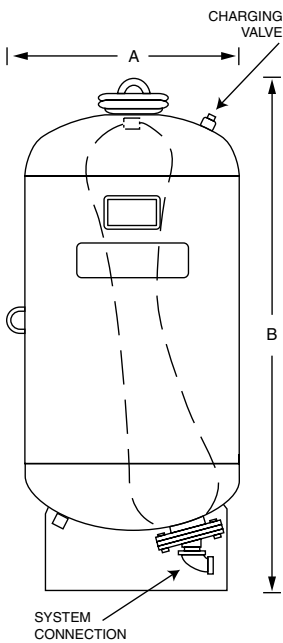

ST-447C THROUGH ST-457C

### PRICING: ASME MODELS

| Base Model Number | Part No. / List Price (USD) |                   |                   |                    |                    |
|-------------------|-----------------------------|-------------------|-------------------|--------------------|--------------------|
|                   | 125 PSI                     | 150 PSI           | 175 PSI           | 250 PSI            | 300 PSI            |
| ST-447C           | 183-48 / \$6,970            | 183-66 / \$7,680  | \$8,820           | 183-70 / \$10,150  | \$11,675           |
| ST-448C           | 183-49 / \$8,100            | 183-67 / \$8,910  | 183-88 / \$9,800  | 183-121 / \$10,800 | \$11,875           |
| ST-449C           | 183-50 / \$9,440            | 183-68 / \$10,400 | 183-93 / \$11,425 | 183-56 / \$12,600  | 183-127 / \$13,800 |
| ST-450C           | 183-51 / \$10,775           | 183-69 / \$11,850 | \$13,025          | 183-134 / \$14,300 | 183-135 / \$15,725 |
| ST-451C           | 184-38 / \$11,975           | 184-69 / \$13,175 | 184-73 / \$14,500 | 184-40 / \$15,925  | 184-79 / \$17,500  |
| ST-452C           | 185-38 / \$13,150           | 185-60 / \$14,475 | 185-39 / \$15,925 | 185-40 / \$17,475  | \$19,250           |
| ST-453C           | 186-38 / \$15,500           | 186-60 / \$17,025 | 186-39 / \$18,750 | \$20,600           | \$22,650           |
| ST-454C           | 181-38 / \$15,950           | 181-53 / \$17,525 | 181-39 / \$19,300 | \$21,225           | \$23,325           |
| ST-455C           | 182-38 / \$17,300           | 182-56 / \$19,000 | \$20,925          | \$23,025           | \$25,300           |
| ST-456C           | 187-38 / \$22,700           | 187-58 / \$25,025 | \$27,525          | 187-40 / \$30,300  | \$33,275           |
| ST-457C           | 188-38 / \$24,275           | 118-68 / \$26,725 | \$30,550          | 188-99 / \$32,350  | \$35,550           |

### PRICING: NON-ASME MODELS

| Base Model Number | Part No. / List Price (USD)<br>150 PSI |
|-------------------|--|
| ST-451            | 184-43 / \$10,525                      |
| ST-452            | 185-43 / \$10,725                      |
| ST-453            | 186-43 / \$12,450                      |
| ST-454            | 181-43 / \$13,250                      |
| ST-455            | 182-43 / \$14,050                      |
| ST-456            | 187-43 / \$18,350                      |
| ST-457            | 188-43 / \$19,575                      |

**Additional Options:** Add to Base Model List Price  
**Sight Glass (SG):** \$336  
**Seismic Restraints (R):** \$236

**Standard Leadtime:** 125 & 150 PSI: 10 Days, 175 PSI: 30 Days, 250 & 300 PSI: 40 Days  
**Connection (NPTF):** Bronze: ST-447 through ST-452: 2", ST-453 through ST-457: 3"  
**Factory Precharge:** All models: 55 PSI  
**Warranty:** 1-Year Limited



## APPLICATIONS & ORDERING

- For use in potable hot water systems
- Replaceable diaphragm construction.
- Available in ASME Code (C) and non-ASME construction.
- Maximum Operating Temperature: 240° F.

## How to Order: Specify Model & Options

ST-100CL-150SGR

- Step 1: Select Base Model Number  
 Step 2: Choose Pressure Rating  
 Step 3: Specify Sight Glass Option (or leave blank)  
 Step 4: Specify Restraint Option (or leave blank)

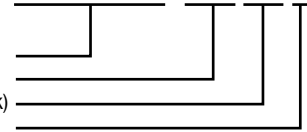

**ST-100CL 150 PSI Rating with Sight Glass & Restraints**

## ST-CL (ASME) and ST-L (NON-ASME) MODELS: PARTIAL ACCEPTANCE BLADDER

J

### TECHNICAL DATA

| Base Model Number | Volume (Gal) | Max Acceptance Volume (Gal) | A Diameter (In) | B Height (In) | Shipping Weight (Lbs) |
|-------------------|--------------|-----------------------------|-----------------|---------------|-----------------------|
| ST-35L(CL)        | 10           | 10                          | 10              | 37            | 76                    |
| ST-50L(CL)        | 13           | 11                          | 12              | 37            | 78                    |
| ST-85L(CL)        | 22           | 11                          | 16              | 35            | 95                    |
| ST-100L(CL)       | 26           | 11                          | 16              | 39            | 102                   |
| ST-130L(CL)       | 34           | 27                          | 20              | 35            | 134                   |
| ST-165L(CL)       | 44           | 27                          | 20              | 40            | 153                   |
| ST-200L(CL)       | 53           | 27                          | 24              | 41            | 205                   |
| ST-300L(CL)       | 80           | 27                          | 24              | 56            | 254                   |
| ST-400L(CL)       | 106          | 53                          | 24              | 69            | 308                   |
| ST-500L(CL)       | 132          | 53                          | 24              | 83            | 352                   |
| ST-600L(CL)       | 158          | 53                          | 30              | 67            | 442                   |

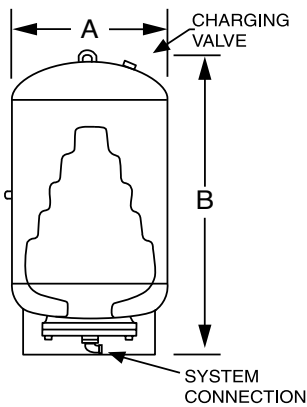

ST-35CL THROUGH ST-600CL

### PRICING: ASME MODELS

| Base Model Number | Part No. / List Price (USD) |
|-------------------|-----------------------------|
| 150 PSI           |                             |
| ST-35CL           | 165-6 / \$4,757             |
| ST-50CL           | 166-6 / \$4,821             |
| ST-85CL           | 167-5 / \$4,944             |
| ST-100CL          | 168-5 / \$5,000             |
| ST-130CL          | 169-5 / \$5,250             |
| ST-165CL          | 171-16 / \$5,440            |
| ST-200CL          | 191-34 / \$5,620            |
| ST-300CL          | 192-32 / \$5,820            |
| ST-400CL          | 193-33 / \$6,740            |
| ST-500CL          | 194-33 / \$7,000            |
| ST-600CL          | 174-38 / \$8,590            |

### PRICING: NON-ASME MODELS

| Base Model Number | Part No. / List Price (USD) |
|-------------------|-----------------------------|
| 150 PSI           |                             |
| ST-35L            | 165-7 / \$4,676             |
| ST-50L            | 166-7 / \$4,739             |
| ST-85L            | 167-6 / \$4,860             |
| ST-100L           | 168-6 / \$4,913             |
| ST-130L           | 169-6 / \$5,160             |
| ST-165L           | 171-17 / \$5,340            |
| ST-200L           | 191-35 / \$5,510            |
| ST-300L           | 192-33 / \$5,710            |
| ST-400L           | 193-34 / \$6,620            |
| ST-500L           | 194-34 / \$6,890            |
| ST-600L           | 174-39 / \$8,450            |

**Additional Options:** Add to Base Model List Price  
**Sight Glass (SG):** \$336  
**Seismic Restraints (R):** \$236

**Standard Leadtime:** All models 10 Days  
**Connection (NPTF):** Stainless Steel: All Models: 1"  
**Factory Precharge:** All models: 55 PSI  
**Warranty:** 1-Year Limited



## APPLICATIONS & ORDERING

- For use in water well and booster pump applications.
- Fixed diaphragm construction.
- Available in ASME Code (C) and non-ASME construction.
- Maximum Operating Temperature: 200° F.

## How to Order: Specify Model & Options

WX-403C-125SGR

- Step 1: Select Base Model Number  
 Step 2: Choose Pressure Rating  
 Step 3: Specify Sight Glass Option (or leave blank)  
 Step 4: Specify Restraint Option (or leave blank)

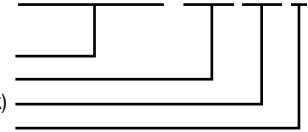

WX-403C (ASME) 125 PSI Rating with Sight Glass & Restraints

## WX-C (ASME) and WX (NON-ASME) MODELS: DIAPHRAGM TYPE J

### TECHNICAL DATA

| Base Model Number | Volume (Gal) | Max Acceptance Volume (Gal) | A Diameter (In) | B Height (In) | Shipping Weight (Lbs) |         |         |         |         |
|-------------------|--------------|-----------------------------|-----------------|---------------|-----------------------|---------|---------|---------|---------|
|                   |              |                             |                 |               | 125 PSI               | 150 PSI | 175 PSI | 250 PSI | 300 PSI |
| WX-401(C)         | 18           | 11                          | 16              | 31            | 77                    | 96      | 110     | 126     | 133     |
| WX-402(C)         | 25           | 11                          | 16              | 40            | 93                    | 113     | 125     | 145     | 160     |
| WX-403(C)         | 34           | 11                          | 16              | 49            | 115                   | 120     | 145     | 183     | 200     |
| WX-404(C)         | 68           | 34                          | 24              | 48            | 227                   | 232     | 313     | 411     | 432     |
| WX-405(C)         | 90           | 34                          | 24              | 59            | 252                   | 255     | 384     | 433     | 460     |
| WX-406(C)         | 110          | 34                          | 24              | 70            | 286                   | 335     | 402     | 475     | 500     |
| WX-407(C)         | 132          | 46                          | 30              | 57            | 436                   | 450     | 510     | 570     | 625     |

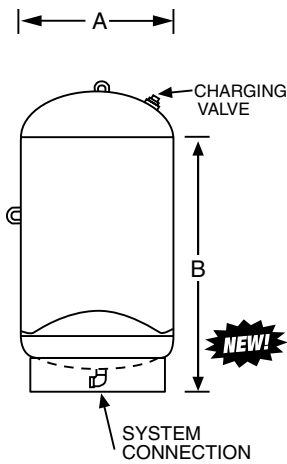

WX-401(C) THROUGH WX-407(C)

### PRICING: ASME MODELS

| Base Model Number | Part No. / List Price (USD) |                    |                   |                   |                    |
|-------------------|-----------------------------|--------------------|-------------------|-------------------|--------------------|
|                   | 125 PSI                     | 150 PSI            | 175 PSI           | 250 PSI           | 300 PSI            |
| WX-401C           | 144-80 / \$2,724            | 144-258 / \$2,997  | 144-160 / \$3,297 | 144-82 / \$3,628  | 144-83 / \$3,989   |
| WX-402C           | 145-80 / \$3,125            | 145-1000 / \$3,437 | 145-70 / \$3,781  | 145-95 / \$4,159  | 145-1003 / \$4,575 |
| WX-403C           | 146-80 / \$3,404            | 146-807 / \$3,745  | 146-760 / \$4,120 | 146-768 / \$4,533 | 172-01 / \$4,985   |
| WX-404C           | 147-80 / \$5,050            | 147-228 / \$5,550  | 147-129 / \$6,110 | 147-125 / \$6,730 | 173-01 / \$7,400   |
| WX-405C           | 149-80 / \$5,280            | 149-155 / \$5,820  | 149-41 / \$6,390  | 149-40 / \$7,040  | 173-03 / \$7,740   |
| WX-406C           | 149-138 / \$5,540           | 149-156 / \$6,100  | 149-144 / \$6,720 | 149-160 / \$7,380 | 149-169 / \$8,130  |
| WX-407C           | 149-139 / \$6,260           | 149-157 / \$6,900  | 149-159 / \$7,580 | 149-146 / \$8,340 | 149-170 / \$9,180  |

### PRICING: NON-ASME MODELS

| Base Model Number | Part No. / List Price (USD) |  |
|-------------------|-----------------------------|--|
|                   | 150 PSI                     |  |
| WX-401            | 144-74 / \$2,750            |  |
| WX-402            | 145-74 / \$2,955            |  |
| WX-403            | 146-74 / \$3,085            |  |
| WX-404            | 147-74 / \$3,889            |  |
| WX-405            | 149-74 / \$4,067            |  |
| WX-406            | 149-142 / \$4,579           |  |
| WX-407            | 149-143 / \$5,060           |  |

**Additional Options:** Add to Base Model List Price  
**Sight Glass (SG):** \$336  
**Seismic Restraints (R):** \$236

**Standard Leadtime:** 125 & 150 PSI: 10 days, 175 PSI: 20 days, 250 & 300 PSI: 30 days,  
**Connection (NPTF):** Malleable Iron: WX-401 through WX-403: 1", WX-404 through WX-407: 1-1/4"  
**Factory Precharge:** All models: 30 PSI  
**Warranty:** 1-Year Limited

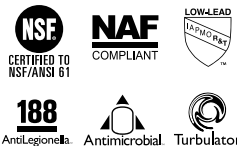

## APPLICATIONS & ORDERING

- For use in water well and booster pump applications.
- Replaceable bladder design.
- Available in ASME Code (C) and non-ASME construction.
- Maximum Operating Temperature: 240° F.

## How to Order: Specify Model & Options

WX-448C-175SGR

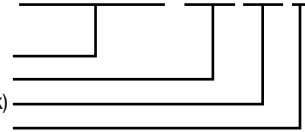

- Step 1: Select Base Model Number  
 Step 2: Choose Pressure Rating  
 Step 3: Specify Sight Glass Option (or leave blank)  
 Step 4: Restraint Option (or leave blank)

WX-448C (ASME) 175 PSI Rating with Sight Glass & Restraints

## WX-C (ASME) and WX (NON-ASME) MODELS: FULL ACCEPTANCE BLADDER

J

### TECHNICAL DATA

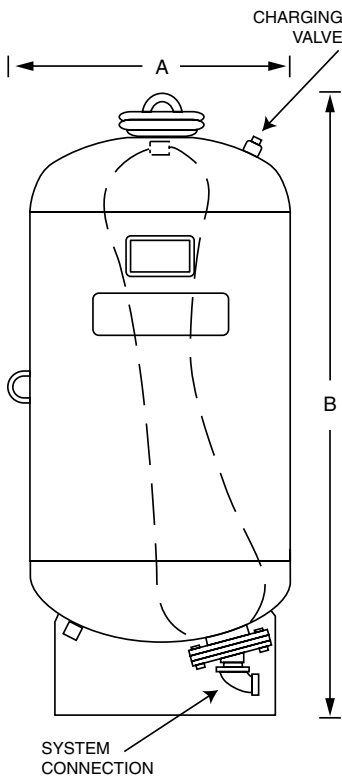

| Base Model Number | Volume (Gal) | Max Acceptance Volume (Gal) | A Diameter (In) | B Height (In) | Shipping Weight (Lbs) |         |         |         |         |         |
|-------------------|--------------|-----------------------------|-----------------|---------------|-----------------------|---------|---------|---------|---------|---------|
|                   |              |                             |                 |               | 100 PSI               | 125 PSI | 150 PSI | 175 PSI | 250 PSI | 300 PSI |
| WX-421            | 158          | 158                         | 30              | 75            | 388                   | N/A     | N/A     | N/A     | N/A     | N/A     |
| WX-422            | 211          | 211                         | 30              | 93            | 454                   | N/A     | N/A     | N/A     | N/A     | N/A     |
| WX-423            | 264          | 264                         | 36              | 82            | 506                   | N/A     | N/A     | N/A     | N/A     | N/A     |
| WX-424            | 317          | 317                         | 36              | 95            | 571                   | N/A     | N/A     | N/A     | N/A     | N/A     |
| WX-426            | 422          | 422                         | 48              | 82            | 971                   | N/A     | N/A     | N/A     | N/A     | N/A     |
| WX-427            | 528          | 528                         | 48              | 96            | 1,222                 | N/A     | N/A     | N/A     | N/A     | N/A     |
| WX-447(C)         | 53           | 53                          | 24              | 45            | N/A                   | 263     | 289     | 368     | 420     | 462     |
| WX-448(C)         | 80           | 80                          | 24              | 59            | N/A                   | 315     | 338     | 430     | 492     | 540     |
| WX-449(C)         | 106          | 106                         | 24              | 73            | N/A                   | 319     | 350     | 440     | 507     | 557     |
| WX-450(C)         | 132          | 132                         | 24              | 87            | N/A                   | 351     | 392     | 454     | 570     | 627     |
| WX-451(C)         | 158          | 158                         | 30              | 73            | N/A                   | 493     | 587     | 680     | 813     | 894     |
| WX-452(C)         | 211          | 211                         | 30              | 91            | N/A                   | 602     | 627     | 694     | 1,007   | 1,107   |
| WX-453(C)         | 264          | 264                         | 36              | 86            | N/A                   | 676     | 752     | 846     | 1,095   | 1,204   |
| WX-454(C)         | 317          | 317                         | 36              | 98            | N/A                   | 762     | 840     | 959     | 1,264   | 1,390   |
| WX-455(C)         | 370          | 370                         | 36              | 110           | N/A                   | 843     | 930     | 1,060   | 1,350   | 1,485   |
| WX-456(C)         | 422          | 422                         | 48              | 82            | N/A                   | 1,154   | 1,418   | 1,655   | 1,700   | 1,826   |
| WX-457(C)         | 528          | 528                         | 48              | 97            | N/A                   | 1,331   | 1,500   | 1,870   | 2,231   | 2,450   |
| WX-458C           | 660          | 660                         | 60              | 84            | N/A                   | 1,450   | 1,740   | 2,030   | 2,320   | 2,750   |
| WX-459C           | 792          | 792                         | 60              | 99            | N/A                   | 2,169   | 2,385   | 3,036   | 3,470   | 3,690   |
| WX-460C           | 925          | 925                         | 60              | 107           | N/A                   | 2,300   | 2,530   | 3,220   | 3,680   | 3,910   |
| WX-461C           | 1,056        | 1,056                       | 60              | 121           | N/A                   | 2,638   | 2,900   | 3,695   | 4,220   | 4,485   |
| WX-462C           | 1,320        | 1,320                       | 72              | 108           | N/A                   | 3,500   | 3,850   | 4,900   | 5,600   | 5,950   |
| WX-463C           | 1,980        | 1,980                       | 72              | 140           | N/A                   | 4,100   | 4,510   | 5,740   | 6,560   | 6,970   |

WX-447 through WX-457 Non-ASME available in 150 PSI only.

### PRICING: ASME MODELS

| Base Model Number | Part No. / List Price (USD) |                   |                    |                   |                    |
|-------------------|-----------------------------|-------------------|--------------------|-------------------|--------------------|
|                   | 125 PSI                     | 150 PSI           | 175 PSI            | 250 PSI           | 300 PSI            |
| WX-447C           | 183-18 / \$7,690            | 183-62 / \$8,450  | 183-38 / \$9,300   | 183-25 / \$10,250 | 183-122 / \$11,225 |
| WX-448C           | 183-19 / \$7,730            | 183-63 / \$8,510  | 183-46 / \$9,350   | 183-26 / \$10,300 | 183-116 / \$11,325 |
| WX-449C           | 183-17 / \$8,050            | 183-64 / \$8,860  | 183-23 / \$9,730   | 183-27 / \$10,700 | 183-99 / \$11,775  |
| WX-450C           | 183-20 / \$8,370            | 183-65 / \$9,210  | 183-100 / \$10,100 | 183-28 / \$11,125 | 183-52 / \$12,250  |
| WX-451C           | 184-35 / \$10,425           | 184-70 / \$11,500 | 184-41 / \$12,650  | 184-42 / \$13,925 | 184-74 / \$15,275  |
| WX-452C           | 185-35 / \$11,525           | 185-61 / \$12,675 | 185-41 / \$13,950  | 185-42 / \$15,350 | 185-56 / \$16,875  |
| WX-453C           | 186-35 / \$14,075           | 186-62 / \$15,450 | 186-41 / \$16,975  | 186-42 / \$18,725 | \$20,575           |
| WX-454C           | 181-35 / \$14,975           | 181-55 / \$16,425 | 181-41 / \$18,050  | 181-42 / \$19,875 | \$21,900           |
| WX-455C           | 182-35 / \$15,875           | 182-58 / \$17,425 | 182-41 / \$19,200  | 182-42 / \$21,075 | \$23,200           |
| WX-456C           | 187-35 / \$20,150           | 187-56 / \$22,175 | 187-41 / \$24,375  | 187-42 / \$26,825 | 187-64 / \$29,525  |
| WX-457C           | 188-35 / \$21,950           | 188-66 / \$24,150 | 188-41 / \$26,575  | 188-42 / \$29,200 | 188-68 / \$32,150  |
| WX-458C           | 188-70 / \$25,050           | 188-79 / \$27,600 | \$29,950           | \$33,350          | *                  |
| WX-459C           | 188-71 / \$29,325           | 188-97 / \$32,225 | \$35,450           | 188-94 / \$38,975 | *                  |
| WX-460C           | 188-72 / \$35,575           | \$39,150          | \$43,075           | \$47,400          | *                  |
| WX-461C           | 188-73 / \$39,475           | 188-91 / \$43,400 | \$47,725           | \$52,550          | *                  |
| WX-462C           | 188-74 / \$59,200           | \$65,100          | \$71,650           | *                 | *                  |
| WX-463C           | 188-96 / \$104,400          | *                 | *                  | *                 | *                  |

\* Consult Amtrol Customer Service for List Price and Lead Times.

#### Standard Leadtime:

WX-421 through WX-427, 100 PSI: 10 days  
 WX-447(C) through WX-457(C), 125 & 150 PSI: 10 Days, 175 PSI: 30 Days, 250 PSI: 40 Days,  
 300 PSI: 50 Days. WX-458C through WX-463C, All pressures: 50 Days.

#### Connection (NPTF):

Malleable Iron: WX-421 & WX-422: 2", WX-423 through WX-427: 3", WX-447(C) through WX-452(C): 2",  
 WX-453(C) through WX-457(C): 3", WX-458C through WX-463C: 4"

#### Factory Precharge:

All models: 25 PSI

#### Warranty:

1-Year Limited

### WX-421 THROUGH WX-463C



## WX-C (ASME) and WX (NON-ASME) MODELS: FULL ACCEPTANCE BLADDER (continued)

J

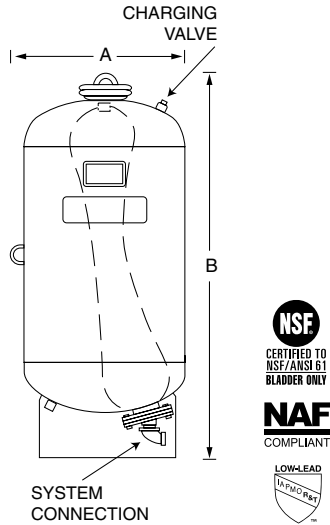

### PRICING: NON-ASME MODELS

| Base Model Number | Part No. / List Price (USD) |                   |
|-------------------|-----------------------------|-------------------|
|                   | 100 PSI                     | 150 PSI           |
| WX-421            | 184-13 / \$9,350            | N/A               |
| WX-422            | 185-13 / \$9,720            | N/A               |
| WX-423            | 186-13 / \$11,325           | N/A               |
| WX-424            | 181-13 / \$11,825           | N/A               |
| WX-426            | 187-13 / \$15,875           | N/A               |
| WX-427            | 188-13 / \$17,150           | N/A               |
| WX-447            | N/A                         | 183-35 / \$7,570  |
| WX-448            | N/A                         | 183-34 / \$7,760  |
| WX-449            | N/A                         | 183-33 / \$8,140  |
| WX-450            | N/A                         | 183-36 / \$8,400  |
| WX-451            | N/A                         | 184-34 / \$10,250 |
| WX-452            | N/A                         | 185-34 / \$11,325 |
| WX-453            | N/A                         | 186-34 / \$13,775 |
| WX-454            | N/A                         | 181-34 / \$14,675 |
| WX-455            | N/A                         | 182-34 / \$15,575 |
| WX-456            | N/A                         | 187-34 / \$19,800 |
| WX-457            | N/A                         | 188-34 / \$21,575 |

### WX-421 THROUGH WX-457

**Additional Options:** Add to Base Model List Price  
**Sight Glass (SG):** \$336  
**Seismic Restraints (R):** \$226

## WX-CL (ASME) and WX-L (NON-ASME) MODELS: PARTIAL ACCEPTANCE BLADDER, 125 PSI

J

### TECHNICAL DATA

| Base Model Number | Volume (Gal) | Max Acceptance Volume (Gal) | Dimensions      |               | Shipping Weight (Lbs) |
|-------------------|--------------|-----------------------------|-----------------|---------------|-----------------------|
|                   |              |                             | A Diameter (In) | B Height (In) |                       |
| WX-35L(CL)        | 10           | 10                          | 10              | 37            | 69                    |
| WX-50L(CL)        | 13           | 11                          | 12              | 37            | 76                    |
| WX-85L(CL)        | 22           | 11                          | 16              | 35            | 92                    |
| WX-100L(CL)       | 26           | 11                          | 16              | 39            | 98                    |
| WX-130L(CL)       | 34           | 27                          | 20              | 35            | 136                   |
| WX-165L(CL)       | 44           | 27                          | 20              | 40            | 146                   |
| WX-200L(CL)       | 53           | 27                          | 24              | 41            | 198                   |
| WX-300L(CL)       | 80           | 27                          | 24              | 56            | 236                   |
| WX-400L(CL)       | 106          | 53                          | 24              | 69            | 282                   |
| WX-500L(CL)       | 132          | 53                          | 24              | 83            | 316                   |
| WX-600L(CL)       | 158          | 53                          | 30              | 67            | 450                   |

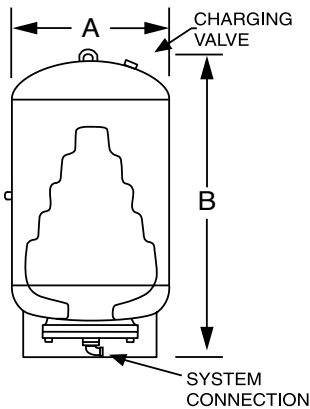

### WX-35CL THROUGH WX-600CL

### PRICING: ASME MODELS

| Base Model Number | Part No. / List Price (USD) |  |
|-------------------|-----------------------------|--|
|                   | 125 PSI                     |  |
| WX-35CL           | 165-8 / \$4,778             |  |
| WX-50CL           | 166-8 / \$4,839             |  |
| WX-85CL           | 167-7 / \$4,976             |  |
| WX-100CL          | 168-8 / \$5,020             |  |
| WX-130CL          | 169-8 / \$5,230             |  |
| WX-165CL          | 171-18 / \$5,290            |  |
| WX-200CL          | 191-36 / \$5,470            |  |
| WX-300CL          | 192-34 / \$5,720            |  |
| WX-400CL          | 193-35 / \$6,690            |  |
| WX-500CL          | 194-35 / \$6,920            |  |
| WX-600CL          | 174-40 / \$8,770            |  |

### PRICING: NON-ASME MODELS

| Base Model Number | Part No. / List Price (USD) |  |
|-------------------|-----------------------------|--|
|                   | 125 PSI                     |  |
| WX-35L            | 165-9 / \$4,696             |  |
| WX-50L            | 166-9 / \$4,758             |  |
| WX-85L            | 167-8 / \$4,892             |  |
| WX-100L           | 168-9 / \$4,933             |  |
| WX-130L           | 169-9 / \$5,140             |  |
| WX-165L           | 171-19 / \$5,200            |  |
| WX-200L           | 191-37 / \$5,390            |  |
| WX-300L           | 192-35 / \$5,640            |  |
| WX-400L           | 193-36 / \$6,580            |  |
| WX-500L           | 194-36 / \$6,790            |  |
| WX-600L           | 174-41 / \$8,620            |  |

**Additional Options:** Add to Base Model List Price  
**Sight Glass (SG):** \$336  
**Seismic Restraints (R):** \$236

**Standard Leadtime:** All models 10 Days  
**Connection (NPTF):** Malleable Iron: WX-35L(CL) through WX-100L(CL): 1-1/4", WX-130L(CL) through WX-300L(CL): 1-1/2", WX-400L(CL) through WX-600L(CL): 2"  
**Factory Precharge:** All models: 25 PSI  
**Warranty:** 1-Year Limited

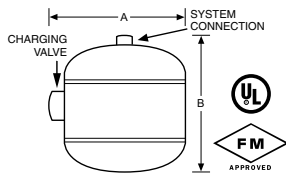
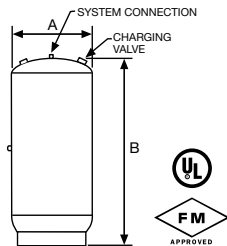
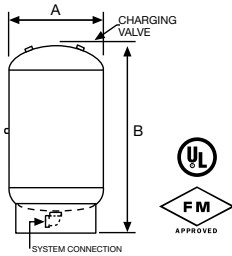

## FPT MODELS: FIRE-X-TROL® SPRINKLER SYSTEM EXPANSION TANKS, 175 PSI

**F**

**FPT-1(C) THROUGH FPT-12(C)**

**FPT-20V(C) THROUGH FPT-70V(C)**

**FPT-80V(C) THROUGH FPT-210V(C)**

Operating Temperature Range:  
-20° F to 200° F

### TECHNICAL DATA

| Model Number | Volume (Gal) | Max Acceptance Volume (Gal) | A Diameter (In) | B Height (In) | Sys. Conn. (In) St. Steel NPTF | Shipping Weight (Lbs) |
|--------------|--------------|-----------------------------|-----------------|---------------|--------------------------------|-----------------------|
| FPT-1(C)     | 1.5          | 0.7                         | 8               | 9             | 3/4                            | 16                    |
| FPT-5(C)     | 2.1          | 0.9                         | 10              | 10            | 3/4                            | 21                    |
| FPT-12(C)    | 6.4          | 3.2                         | 12              | 16            | 3/4                            | 36                    |
| FPT-20V(C)   | 8.0          | 3.2                         | 12              | 20            | 3/4                            | 52                    |
| FPT-30V(C)   | 14.0         | 9.0                         | 16              | 19            | 3/4                            | 97                    |
| FPT-42V(C)   | 17.5         | 11.0                        | 16              | 24            | 3/4                            | 116                   |
| FPT-60V(C)   | 25.0         | 11.0                        | 16              | 33            | 3/4                            | 154                   |
| FPT-70V(C)   | 34.0         | 11.0                        | 16              | 42            | 3/4                            | 197                   |
| FPT-80V(C)   | 53.0         | 35.0                        | 24              | 36            | 1 1/4                          | 251                   |
| FPT-120V(C)  | 66.0         | 35.0                        | 24              | 44            | 1 1/4                          | 281                   |
| FPT-180V(C)  | 77.0         | 35.0                        | 24              | 49            | 1 1/4                          | 353                   |
| FPT-210V(C)  | 90.0         | 35.0                        | 24              | 56            | 1 1/4                          | 382                   |

### PRICING: ASME MODELS

| Model Number | Part No. / List Price (USD) | 175 PSI |
|--------------|-----------------------------|---------|
| FPT-1C       | 140-757 / \$1,496           |         |
| FPT-5C       | 140-746 / \$2,029           |         |
| FPT-12C      | 141-370 / \$2,622           |         |
| FPT-20VC     | 142-183 / \$3,508           |         |
| FPT-30VC     | 143-373 / \$4,026           |         |
| FPT-42VC     | 144-259 / \$5,170           |         |
| FPT-60VC     | 146-809 / \$7,190           |         |
| FPT-70VC     | 146-810 / \$9,790           |         |
| FPT-80VC     | 147-229 / \$10,550          |         |
| FPT-120VC    | 147-230 / \$11,150          |         |
| FPT-180VC    | 148-161 / \$11,750          |         |
| FPT-210VC    | 148-162 / \$14,075          |         |

### PRICING: NON-ASME MODELS

| Model Number | Part No. / List Price (USD) | 175 PSI |
|--------------|-----------------------------|---------|
| FPT-1        | 140-756 / \$1,496           |         |
| FPT-5        | 140-748 / \$2,029           |         |
| FPT-12       | 141-374 / \$2,622           |         |
| FPT-20V      | 142-184 / \$3,508           |         |
| FPT-30V      | 143-378 / \$4,026           |         |
| FPT-42V      | 144-263 / \$5,170           |         |
| FPT-60V      | 146-813 / \$7,190           |         |
| FPT-70V      | 146-814 / \$9,790           |         |
| FPT-80V      | 147-235 / \$10,550          |         |
| FPT-120V     | 147-236 / \$11,150          |         |
| FPT-180V     | 148-164 / \$11,750          |         |
| FPT-210V     | 148-165 / \$14,075          |         |

Seismic Restraints (R); Sight Glass (SG) Available on Models FPT-20V(C) through FPT-210V(C)

## SPT MODELS: SURGE-TROL® SPRINKLER SYSTEM SURGE SUPPRESSORS, 275 PSI

**F**

### TECHNICAL DATA

| Model Number | Volume (Gal) | A Diameter (In) | B Height (In) | Sys. Conn. (In) | Shipping Weight (Lbs) |
|--------------|--------------|-----------------|---------------|-----------------|-----------------------|
| SPT-1        | 10           | 16              | 31            | 2               | 200                   |
| SPT-3        | 25           | 16              | 49            | 3               | 273                   |
| SPT-7        | 53           | 24              | 49            | 4               | 390                   |
| SPT-11       | 80           | 24              | 63            | 4               | 505                   |
| SPT-14       | 106          | 24              | 77            | 4               | 618                   |
| SPT-18       | 132          | 24              | 91            | 4               | 731                   |
| SPT-21       | 158          | 30              | 75            | 4               | 950                   |
| SPT-28       | 211          | 30              | 93            | 4               | 1,125                 |
| SPT-35       | 264          | 36              | 85            | 6               | 1,520                 |
| SPT-42       | 317          | 36              | 97            | 6               | 1,720                 |
| SPT-50       | 370          | 36              | 110           | 6               | 1,900                 |
| SPT-56       | 422          | 48              | 86            | 8               | 2,300                 |
| SPT-70       | 528          | 48              | 100           | 8               | 2,700                 |

### PRICING: ASME MODELS

| Model Number | Part No. / List Price (USD) | 275 PSI |
|--------------|-----------------------------|---------|
| SPT-1        | 217-012 / \$15,650          |         |
| SPT-3        | 217-013 / \$21,850          |         |
| SPT-7        | 217-001 / \$23,700          |         |
| SPT-11       | 217-002 / \$23,900          |         |
| SPT-14       | 217-003 / \$24,475          |         |
| SPT-18       | 217-004 / \$24,775          |         |
| SPT-21       | 217-005 / \$33,525          |         |
| SPT-28       | 217-006 / \$37,075          |         |

| Model Number | Part No. / List Price (USD) | 275 PSI |
|--------------|-----------------------------|---------|
| SPT-35       | 217-007 / \$47,850          |         |
| SPT-42       | 217-008 / \$50,700          |         |
| SPT-50       | 217-009 / \$53,500          |         |
| SPT-56       | 217-010 / \$61,950          |         |
| SPT-70       | 217-011 / \$65,000          |         |

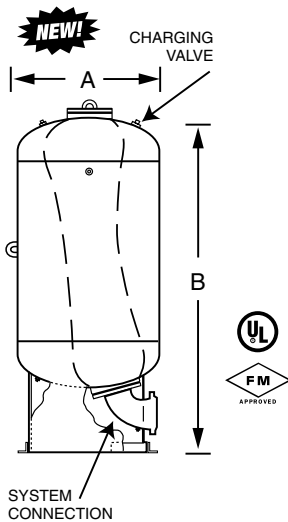
**SPT-1 THROUGH SPT-70**

Maximum Operating Temperature: 240° F

Seismic Restraints (R) Standard; Sight Glass (SG) Optional



## D MODELS: DIATROL® SHOCK SUPPRESSORS, 250 PSI, ASME

J

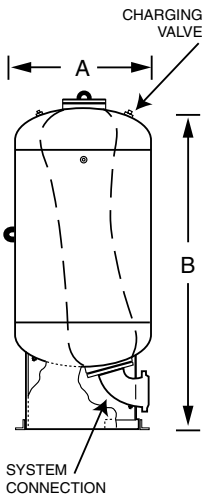

### D-7 THROUGH D-70

For Water Hammer Reduction in Potable Cold or Hot Water Systems.



Maximum Operating Temperature: 200° F

### TECHNICAL DATA

| Model Number | Volume (Gal) | A Diameter (In) | B Height (In) | Sys. Conn. (In) | Shipping Weight (Lbs) |
|--------------|--------------|-----------------|---------------|-----------------|-----------------------|
| D-7          | 53           | 24              | 49            | 4               | 390                   |
| D-11         | 80           | 24              | 63            | 4               | 505                   |
| D-14         | 106          | 24              | 77            | 4               | 618                   |
| D-18         | 132          | 24              | 91            | 4               | 731                   |
| D-21         | 158          | 30              | 75            | 4               | 950                   |
| D-28         | 211          | 30              | 93            | 4               | 1,125                 |
| D-35         | 264          | 36              | 85            | 6               | 1,520                 |
| D-42         | 317          | 36              | 97            | 6               | 1,720                 |
| D-50         | 370          | 36              | 110           | 6               | 1,900                 |
| D-56         | 422          | 48              | 86            | 8               | 2,300                 |
| D-70         | 528          | 48              | 100           | 8               | 2,700                 |

### PRICING: ASME MODELS

| Model Number   | Part No. / List Price (USD) |
|----------------|-----------------------------|
| <b>250 PSI</b> |                             |
| D-7            | 183-39 / \$16,275           |
| D-11           | 183-37 / \$16,475           |
| D-14           | 183-44 / \$16,950           |
| D-18           | 183-42 / \$17,375           |
| D-21           | 184-52 / \$26,400           |
| D-28           | 184-57 / \$29,375           |
| D-35           | 186-47 / \$41,075           |
| D-42           | 186-57 / \$44,000           |
| D-50           | 186-56 / \$46,925           |
| D-56           | 187-53 / \$55,750           |
| D-70           | 188-50 / \$58,750           |

Seismic Restraints (R) Standard & Sight Glass (SG) Optional

**Additional Options:** Add to Base Model List Price  
**Sight Glass (SG):** \$336

**Standard Leadtime:** FPT Models: 10 Days; SPT Models: 30 Days; D Models: 30 Days  
**Connection:** 250 PSI: 150# Flange; 275 PSI: 300# Flange  
**Warranty:** 1-Year Limited

### EXTROL® REPLACEMENT BLADDERS

| Model Number | Application | Shipping Weight (Lbs) | Standard Lead Time | List Price (USD) |
|--------------|-------------|-----------------------|--------------------|------------------|
| 191-3        | 200-L       | 15                    | 10 days            | \$2,380          |
| 192-3        | 300-L       | 20                    | 10 days            | \$2,513          |
| 193-3        | 400-L       | 25                    | 10 days            | \$2,638          |
| 194-3        | 500-L       | 30                    | 10 days            | \$2,725          |
| 174-16       | 600-L       | 33                    | 10 days            | \$2,819          |
| 175-15       | 800-L       | 35                    | 10 days            | \$2,912          |
| 176-15       | 1000-L      | 37                    | 10 days            | \$3,579          |
| 177-15       | 1200-L      | 43                    | 10 days            | \$3,711          |
| 178-15       | 1400-L      | 52                    | 10 days            | \$4,138          |
| 179-15       | 1600-L      | 55                    | 10 days            | \$4,337          |
| 180-15       | 2000-L      | 63                    | 10 days            | \$4,421          |
| 180-35       | 2500-L      | 71                    | 10 days            | \$4,732          |
| 180-36       | 3000-L      | 82                    | 10 days            | \$5,540          |
| 180-37       | 3500-L      | 102                   | 10 days            | \$7,550          |
| 180-38       | 4000-L      | 109                   | 10 days            | \$9,300          |
| 180-48       | 5000-L      | 128                   | 10 days            | \$10,975         |
| 180-90       | 7500-L      | 155                   | 30 days            | \$12,250         |
| 180-91       | 10000-L     | 225                   | 30 days            | \$16,725         |
| 180-92       | 15000-L     | 310                   | 30 days            | \$27,850         |
| 10-0001      | 35-100LBC   | 13                    | 10 days            | \$1,024          |
| 10-0002      | 130-300LBC  | 19                    | 10 days            | \$1,386          |
| 10-0003      | 400-600LBC  | 33                    | 10 days            | \$1,961          |

### THERM-X-TROL® & WELL-X-TROL® REPLACEMENT BLADDERS

| Model Number | Application     | Shipping Weight (Lbs) | Standard Lead Time | List Price (USD) |
|--------------|-----------------|-----------------------|--------------------|------------------|
| 183-10       | WX & ST-447     | 16                    | 10 days            | \$2,730          |
| 183-11       | WX & ST 448     | 21                    | 10 days            | \$2,815          |
| 183-12       | WX & ST-449     | 26                    | 10 days            | \$2,875          |
| 183-13       | WX & ST-450     | 31                    | 10 days            | \$2,886          |
| 184-27       | WX & ST-451/421 | 26                    | 10 days            | \$2,996          |
| 185-22       | WX & ST-452/422 | 32                    | 10 days            | \$3,096          |
| 186-23       | WX & ST-453/423 | 37                    | 10 days            | \$3,927          |
| 181-21       | WX & ST-454/424 | 42                    | 10 days            | \$3,972          |
| 182-21       | WX & ST-455     | 48                    | 10 days            | \$4,466          |
| 187-21       | WX & ST-456/426 | 52                    | 10 days            | \$4,582          |
| 188-21       | WX & ST-457/427 | 62                    | 10 days            | \$4,745          |
| 188-80       | WX458           | 71                    | 30 days            | \$6,020          |
| 188-81       | WX459           | 82                    | 30 days            | \$6,330          |
| 188-82       | WX460           | 102                   | 30 days            | \$8,520          |
| 188-83       | WX461           | 109                   | 30 days            | \$9,140          |
| 188-84       | WX462           | 128                   | 30 days            | \$10,475         |
| 188-85       | WX463           | 150                   | 30 days            | \$14,600         |
| 10-0004      | ST35-100(C)L    | 13                    | 10 days            | \$3,179          |
| 10-0005      | ST130-300(C)L   | 19                    | 10 days            | \$4,199          |
| 10-0006      | ST400-600(C)L   | 33                    | 10 days            | \$4,998          |
| 10-0007      | WX35-100(C)L    | 13                    | 10 days            | \$3,179          |
| 10-0008      | WX130-300(C)L   | 19                    | 10 days            | \$4,199          |
| 10-0009      | WX400-600(C)L   | 33                    | 10 days            | \$4,998          |



### DIATROL® & SURGE-TROL® REPLACEMENT BLADDERS

| Model Number | Application | Shipping Weight (Lbs) | Standard Leadtime | List Price (USD) |
|--------------|-------------|-----------------------|-------------------|------------------|
| 217-0039     | SPT-1       | 10                    | 10 days           | \$2,289          |
| 217-0040     | SPT-3       | 12                    | 10 days           | \$2,363          |
| 183-77       | D & SPT-7   | 15                    | 10 days           | \$2,523          |
| 183-72       | D & SPT-11  | 20                    | 10 days           | \$2,663          |
| 183-73       | D & SPT-14  | 25                    | 10 days           | \$2,797          |
| 183-74       | D & SPT-18  | 30                    | 10 days           | \$2,886          |
| 183-75       | D & SPT-21  | 33                    | 30 days           | \$2,996          |
| 183-76       | D & SPT-28  | 35                    | 30 days           | \$3,096          |
| 181-56       | D & SPT-35  | 37                    | 30 days           | \$3,927          |
| 181-57       | D & SPT-42  | 43                    | 30 days           | \$3,972          |
| 181-58       | D & SPT-50  | 52                    | 30 days           | \$4,466          |
| 187-59       | D & SPT-56  | 55                    | 30 days           | \$4,582          |
| 187-60       | D & SPT-70  | 63                    | 30 days           | \$4,947          |



**Standard Leadtime:** Extrol, Therm-X-Trol & Well-X-Trol Bladders: 10 Days; Diatrol & Surge-Trol Bladders: 40 Days  
**Warranty:** 1-Year Limited



# Index

|                |     |               |    |              |    |                |    |
|----------------|-----|---------------|----|--------------|----|----------------|----|
| 1-ASL.....     | 20  | 165-LBC.....  | 19 | 420-6.....   | 13 | 747.....       | 23 |
| 2 1/2-AS.....  | 21  | 174-16.....   | 34 | 421-1.....   | 13 | 800-L.....     | 18 |
| 2 1/2-ASL..... | 20  | 175-15.....   | 34 | 443-1.....   | 13 | 940R2.....     | 14 |
| 2-ADS.....     | 22  | 176-15.....   | 34 | 444-1.....   | 13 | 940R101.....   | 14 |
| 2-AS.....      | 21  | 177-15.....   | 34 | 445-1.....   | 13 | 1000-L.....    | 18 |
| 2-ASL.....     | 20  | 178-15.....   | 34 | 446-1.....   | 13 | 1200-L.....    | 18 |
| 3-ADS.....     | 22  | 179-15.....   | 34 | 447-1.....   | 13 | 1400-L.....    | 18 |
| 3-AS.....      | 21  | 180-15.....   | 34 | 448-1.....   | 13 | 1600-L.....    | 18 |
| 3-ASL.....     | 20  | 180-35.....   | 34 | 449.....     | 22 | 2000-L.....    | 18 |
| 4-ADS.....     | 22  | 180-36.....   | 34 | 461.....     | 22 | 2201N002.....  | 9  |
| 4-AS.....      | 21  | 180-37.....   | 34 | 462.....     | 22 | 2201N003.....  | 9  |
| 4-ASL.....     | 20  | 180-38.....   | 34 | 463.....     | 22 | 2201N006.....  | 9  |
| 5-ADS.....     | 22  | 180-48.....   | 34 | 464.....     | 22 | 2201N010.....  | 9  |
| 5-AS.....      | 21  | 180-90.....   | 34 | 465.....     | 22 | 2201N020.....  | 9  |
| 5-ASL.....     | 20  | 180-91.....   | 34 | 466.....     | 22 | 2201N021.....  | 9  |
| 6-ADS.....     | 22  | 180-92.....   | 34 | 467.....     | 22 | 2201N022.....  | 9  |
| 6-AS.....      | 21  | 181-21.....   | 34 | 468.....     | 22 | 2201R28.....   | 9  |
| 6-ASL.....     | 20  | 181-56.....   | 34 | 500-L.....   | 18 | 2201R37.....   | 9  |
| 8-ADS.....     | 22  | 181-57.....   | 34 | 500-LBC..... | 19 | 2201R39.....   | 9  |
| 8-AS.....      | 21  | 181-58.....   | 34 | 513P01.....  | 10 | 2500-178.....  | 14 |
| 8-ASL.....     | 20  | 182-21.....   | 34 | 537-1.....   | 10 | 2500-218.....  | 14 |
| 10-0001.....   | 34  | 183-10.....   | 34 | 541-1.....   | 10 | 2500-L.....    | 18 |
| 10-0002.....   | 34  | 183-11.....   | 34 | 600-L.....   | 18 | 2700-635.....  | 14 |
| 10-0003.....   | 34  | 183-12.....   | 34 | 600-LBC..... | 19 | 2700-924.....  | 14 |
| 10-0004.....   | 34  | 183-13.....   | 34 | 601-1.....   | 11 | 2700-5000..... | 14 |
| 10-0005.....   | 34  | 183-72.....   | 34 | 601-2.....   | 11 | 2700-5001..... | 14 |
| 10-0006.....   | 34  | 183-73.....   | 34 | 601-3.....   | 11 | 2700-5002..... | 14 |
| 10-0007.....   | 34  | 183-74.....   | 34 | 601-4.....   | 11 | 2700-5003..... | 14 |
| 10-0008.....   | 34  | 183-75.....   | 34 | 601-5.....   | 11 | 2700-5005..... | 14 |
| 10-0009.....   | 34  | 183-76.....   | 34 | 601-6.....   | 11 | 2700-5006..... | 14 |
| 10-ADS.....    | 22  | 183-77.....   | 34 | 602-1.....   | 11 | 2700-5008..... | 14 |
| 10-AS.....     | 21  | 184-27.....   | 34 | 602-2.....   | 11 | 2700-5008..... | 14 |
| 10-ASL.....    | 20  | 185-22.....   | 34 | 602-3.....   | 11 | 2700R1106..... | 14 |
| 12-ADS.....    | 22  | 186-23.....   | 34 | 602-4.....   | 11 | 2702R001.....  | 14 |
| 12-AS.....     | 21  | 187-21.....   | 34 | 602-5.....   | 11 | 2702R002.....  | 14 |
| 12-ASL.....    | 20  | 187-59.....   | 34 | 602-6.....   | 11 | 2703R001.....  | 14 |
| 14-AS.....     | 21  | 187-60.....   | 34 | 602-7.....   | 11 | 2703R003.....  | 14 |
| 14-ASL.....    | 20  | 188-21.....   | 34 | 602-8.....   | 11 | 2704-093.....  | 14 |
| 16-AS.....     | 21  | 188-80.....   | 34 | 603-1.....   | 11 | 2704-259.....  | 14 |
| 16-ASL.....    | 20  | 188-81.....   | 34 | 603-2.....   | 11 | 2704-392.....  | 14 |
| 18-AS.....     | 21  | 188-82.....   | 34 | 603-3.....   | 11 | 2704-487.....  | 14 |
| 18-ASL.....    | 20  | 188-83.....   | 34 | 603-4.....   | 11 | 2704-529.....  | 14 |
| 20-AS.....     | 21  | 188-84.....   | 34 | 603-5.....   | 11 | 2704R512.....  | 14 |
| 20-ASL.....    | 20  | 188-85.....   | 34 | 603-6.....   | 11 | 2712R002.....  | 14 |
| 22-AS.....     | 21  | 191-3.....    | 34 | 603-7.....   | 11 | 2713R002.....  | 14 |
| 22-ASL.....    | 20  | 192-3.....    | 34 | 603-8.....   | 11 | 2770-133.....  | 14 |
| 24-AS.....     | 21  | 193-3.....    | 34 | 604-1.....   | 11 | 2775-82.....   | 14 |
| 24-ASL.....    | 20  | 194-3.....    | 34 | 604-2.....   | 11 | 2775-83.....   | 14 |
| 35-LBC.....    | 19  | 200-L.....    | 18 | 604-3.....   | 11 | 2775-84.....   | 14 |
| 50-LBC.....    | 19  | 200-LBC.....  | 19 | 604-4.....   | 11 | 2775-454.....  | 14 |
| 85-LBC.....    | 19  | 217-0039..... | 34 | 606-2.....   | 11 | 2775-455.....  | 14 |
| 100-LBC.....   | 19  | 217-0040..... | 34 | 606-3.....   | 11 | 2775-768.....  | 14 |
| 113-3.....     | 9   | 245-59.....   | 9  | 606-4.....   | 11 | 2782R0002..... | 14 |
| 130-LBC.....   | 19  | 245-60.....   | 9  | 608-4.....   | 11 | 2783R0001..... | 14 |
| 140-127.....   | 8   | 245-61.....   | 9  | 608-6.....   | 11 | 2783R0004..... | 14 |
| 140-470.....   | 13  | 300-L.....    | 18 | 608-7.....   | 11 | 3000-L.....    | 18 |
| 146-832.....   | 8,9 | 300-LBC.....  | 19 | 608-8.....   | 11 | 3500-L.....    | 18 |
| 146-2350.....  | 8   | 400-L.....    | 18 | 700-C.....   | 13 | 4000-L.....    | 18 |
|                |     | 400-LBC.....  | 19 | 700-QC.....  | 13 | 5000-L.....    | 18 |
|                |     | 420-1.....    | 13 | 701-C.....   | 13 | 7500-L.....    | 18 |
|                |     |               |    |              |    | 9340R160.....  | 14 |

|                 |    |                  |    |                  |    |                 |    |
|-----------------|----|------------------|----|------------------|----|-----------------|----|
| 10000-L.....    | 18 | CH-80ZDW-B.....  | 14 | EX-3000-100..... | 12 | PL-86.....      | 7  |
| 15000-L.....    | 18 | CH-80ZDW-G.....  | 14 | EX-3000-125..... | 12 | PL-119.....     | 7  |
| AC12-15.....    | 23 | CH-80ZDW-R.....  | 14 | FPT-1(C).....    | 32 | Repair Kit..... | 23 |
| AC12-24.....    | 23 | CH-80Z-G.....    | 14 | FPT-5(C).....    | 32 | RO-2.....       | 7  |
| AC14-30.....    | 23 | CH-80Z-R.....    | 14 | FPT-12(C).....   | 32 | RO-3.....       | 7  |
| AC14-40.....    | 23 | CH-81.....       | 6  | FPT-20V(C).....  | 32 | RO-4.....       | 7  |
| AC16-60.....    | 23 | CH-86.....       | 6  | FPT-30V(C).....  | 32 | RO-10.....      | 7  |
| AC20-80.....    | 23 | CH-119.....      | 6  | FPT-42V(C).....  | 32 | RO-14.....      | 7  |
| AC20-100.....   | 23 | CWBT120-3.....   | 24 | FPT-60V(C).....  | 32 | RO-20.....      | 7  |
| AC24-120.....   | 23 | CWBT120-4.....   | 24 | FPT-70V(C).....  | 32 | RO-20PA.....    | 7  |
| AC24-135.....   | 23 | CWBT120-6.....   | 24 | FPT-80V(C).....  | 32 | RO-34.....      | 7  |
| AC30-175.....   | 23 | CWBT200-3.....   | 24 | FPT-120V(C)..... | 32 | RO-34PA.....    | 7  |
| AC30-220.....   | 23 | CWBT200-4.....   | 24 | FPT-180V(C)..... | 32 | RO-44.....      | 7  |
| AC30-240.....   | 23 | CWBT200-6.....   | 24 | FPT-210V(C)..... | 32 | RO-44PA.....    | 7  |
| AC30-305.....   | 23 | CWBT300-4.....   | 24 | FT-15.....       | 12 | RO-86.....      | 7  |
| AC36-400.....   | 23 | CWBT300-6.....   | 24 | FT-30.....       | 12 | RO-86PA.....    | 7  |
| AC36-505.....   | 23 | CWBT300-8.....   | 24 | FT-109.....      | 12 | RO-119PA.....   | 7  |
| AX-15.....      | 16 | CWBT500-6.....   | 24 | FT-109-15.....   | 12 | RP-10HP.....    | 9  |
| AX-15V.....     | 17 | CWBT500-8.....   | 24 | FT-109-100.....  | 12 | RP-15HP.....    | 9  |
| AX-20.....      | 16 | CWBT500-10.....  | 24 | FT-109-125.....  | 12 | RP-25HP.....    | 9  |
| AX-20V.....     | 17 | CWBT850-6.....   | 24 | FT-110.....      | 12 | RX-15.....      | 13 |
| AX-40.....      | 16 | CWBT850-8.....   | 24 | FT-110-100.....  | 12 | RX-30.....      | 13 |
| AX-40V.....     | 17 | CWBT850-10.....  | 24 | FT-110-125.....  | 12 | RX-60.....      | 13 |
| AX-60.....      | 16 | CWBT1040-8.....  | 24 | FT-111.....      | 12 | S-41.....       | 15 |
| AX-60V.....     | 17 | CWBT1040-10..... | 24 | FT-111-125.....  | 12 | S-41L.....      | 15 |
| AX-80.....      | 16 | CWBT1040-12..... | 24 | FT-112.....      | 12 | S-80.....       | 15 |
| AX-80V.....     | 17 | D-7.....         | 33 | HM-41L.....      | 14 | S-80L.....      | 15 |
| AX-100.....     | 16 | D-11.....        | 33 | HM-41LDW.....    | 14 | S-120.....      | 15 |
| AX-100V.....    | 17 | D-14.....        | 33 | HM-41Z.....      | 14 | S-120L.....     | 15 |
| AX-120.....     | 16 | D-18.....        | 33 | HM-41ZDW.....    | 14 | SE-15.....      | 13 |
| AX-120V.....    | 17 | D-21.....        | 33 | HM-80L.....      | 14 | SE-30.....      | 13 |
| AX-144.....     | 16 | D-28.....        | 33 | HM-80LDW.....    | 14 | SE-60.....      | 13 |
| AX-144V.....    | 17 | D-35.....        | 33 | HM-80Z.....      | 14 | SPT-1.....      | 32 |
| AX-180.....     | 16 | D-42.....        | 33 | HM-80ZDW.....    | 14 | SPT-3.....      | 32 |
| AX-180V.....    | 17 | D-50.....        | 33 | HWBT120-2.....   | 25 | SPT-7.....      | 32 |
| AX-200.....     | 16 | D-56.....        | 33 | HWBT120-2/2..... | 25 | SPT-11.....     | 32 |
| AX-200V.....    | 17 | D-70.....        | 33 | HWBT120-2/3..... | 25 | SPT-14.....     | 32 |
| AX-240.....     | 16 | DC-80.....       | 15 | HWBT120-3.....   | 25 | SPT-18.....     | 32 |
| AX-240V.....    | 17 | DC-80DW.....     | 15 | HWBT120-3/3..... | 25 | SPT-21.....     | 32 |
| AX-260.....     | 16 | DC-120.....      | 15 | HWBT120-4/4..... | 25 | SPT-28.....     | 32 |
| AX-260V.....    | 17 | DC-120DW.....    | 15 | HWBT200-2.....   | 25 | SPT-35.....     | 32 |
| AX-280.....     | 16 | DURABASE-15..... | 8  | HWBT200-2/2..... | 25 | SPT-42.....     | 32 |
| AX-280V.....    | 17 | DURABASE-22..... | 8  | HWBT200-2/3..... | 25 | SPT-50.....     | 32 |
| CH-14.....      | 6  | ERTG-12A.....    | 8  | HWBT200-3.....   | 25 | SPT-56.....     | 32 |
| CH-20.....      | 6  | ERTG-21A.....    | 8  | HWBT200-3/3..... | 25 | SPT-70.....     | 32 |
| CH-26.....      | 6  | ERTG-30A.....    | 8  | HWBT200-4/4..... | 25 | ST-1.....       | 10 |
| CH-32.....      | 6  | ERTG-42SA.....   | 8  | HWBT300-2.....   | 25 | ST-5.....       | 10 |
| CH-34.....      | 6  | ERTG-42TA.....   | 8  | HWBT300-2/2..... | 25 | ST-5C.....      | 26 |
| CH-41Z-B.....   | 14 | ERTG-82A.....    | 8  | HWBT300-2/3..... | 25 | ST-5C-DD.....   | 26 |
| CH-41ZCT-B..... | 14 | ERTG-120A.....   | 8  | HWBT300-3.....   | 25 | ST-5-FF.....    | 10 |
| CH-41ZCT-G..... | 14 | ERTG-220A.....   | 8  | HWBT300-3/3..... | 25 | ST-8.....       | 10 |
| CH-41ZCT-R..... | 14 | ERTG-315A.....   | 8  | HWBT300-4/4..... | 25 | ST-12.....      | 10 |
| CH-41ZDW-B..... | 14 | EX-15.....       | 12 | PL-14.....       | 7  | ST-12C.....     | 26 |
| CH-41ZDW-G..... | 14 | EX-15-FF.....    | 12 | PL-20.....       | 7  | ST-12C-DD.....  | 26 |
| CH-41ZDW-R..... | 14 | EX-30.....       | 12 | PL-26.....       | 7  | ST-12-FF.....   | 10 |
| CH-41Z-G.....   | 14 | EX-30-FF.....    | 12 | PL-32.....       | 7  | ST-20VC.....    | 26 |
| CH-41Z-R.....   | 14 | EX-60.....       | 12 | PL-34.....       | 7  | ST-20VC-DD..... | 26 |
| CH-44.....      | 6  | EX-90.....       | 12 | PL-44.....       | 7  | ST-25V.....     | 10 |
| CH-62.....      | 6  | EX-1500-100..... | 12 | PL-62.....       | 7  | ST-30V.....     | 10 |
| CH-80Z-B.....   | 14 | EX-1500-125..... | 12 | PL-81.....       | 7  | ST-30VC.....    | 26 |



|                  |    |                  |    |                   |   |                  |    |
|------------------|----|------------------|----|-------------------|---|------------------|----|
| ST-35L(CL).....  | 28 | WH-41L-B.....    | 14 | WX-202D-G.....    | 5 | WX-255D-G.....   | 5  |
| ST-42V.....      | 10 | WH-41LDW-B.....  | 14 | WX-202D-T.....    | 5 | WX-255D-T.....   | 5  |
| ST-42VC.....     | 26 | WH-41LDW-G.....  | 14 | WX-202-G.....     | 4 | WX-255-G.....    | 4  |
| ST-50L(CL).....  | 28 | WH-41L-G.....    | 14 | WX-202H.....      | 5 | WX-255PA.....    | 4  |
| ST-60V.....      | 10 | WH-41L-R.....    | 14 | WX-202PA.....     | 4 | WX-255PA-G.....  | 4  |
| ST-60VC.....     | 26 | WH-41Z-B.....    | 14 | WX-202PA-G.....   | 4 | WX-255PA-T.....  | 4  |
| ST-70VC.....     | 26 | WH-41ZDW-B.....  | 14 | WX-202PA-T.....   | 4 | WX-255-T.....    | 4  |
| ST-80V.....      | 10 | WH-41ZDW-G.....  | 14 | WX-202PS.....     | 5 | WX-300L(CL)..... | 31 |
| ST-80VC.....     | 26 | WH-41Z-G.....    | 14 | WX-202-T.....     | 4 | WX-302.....      | 4  |
| ST-85L(CL).....  | 28 | WH-41Z-R.....    | 14 | WX-202UG.....     | 6 | WX-302D.....     | 5  |
| ST-100L(CL)..... | 28 | WHS-60L.....     | 15 | WX-202XL.....     | 4 | WX-302D-G.....   | 5  |
| ST-120VC.....    | 26 | WHS-60LDW.....   | 15 | WX-202XLD.....    | 5 | WX-302D-T.....   | 5  |
| ST-130L(CL)..... | 28 | WHS-60Z.....     | 15 | WX-202XLD-G.....  | 5 | WX-302-G.....    | 4  |
| ST-165L(CL)..... | 28 | WHS-60ZC.....    | 15 | WX-202XLD-T.....  | 5 | WX-302PA.....    | 4  |
| ST-180V.....     | 10 | WHS-60ZCDW.....  | 15 | WX-202XL-G.....   | 4 | WX-302PA-G.....  | 4  |
| ST-180VC.....    | 26 | WHS-60ZDW.....   | 15 | WX-202XLPA.....   | 4 | WX-302PA-T.....  | 4  |
| ST-200L(CL)..... | 28 | WHS-80L.....     | 15 | WX-202XLPA-G..... | 4 | WX-302-T.....    | 4  |
| ST-200V.....     | 10 | WHS-80LDW.....   | 15 | WX-202XLPA-T..... | 4 | WX-350.....      | 4  |
| ST-210V.....     | 10 | WHS-80Z.....     | 15 | WX-202XL-T.....   | 4 | WX-350D.....     | 5  |
| ST-210VC.....    | 26 | WHS-80ZC.....    | 15 | WX-203.....       | 4 | WX-350D-G.....   | 5  |
| ST-300L(CL)..... | 28 | WHS-80ZCDW.....  | 15 | WX-203D.....      | 5 | WX-350D-T.....   | 5  |
| ST-400L(CL)..... | 28 | WHS-80ZDW.....   | 15 | WX-203D-G.....    | 5 | WX-350-G.....    | 4  |
| ST-447C.....     | 27 | WHS-120L.....    | 15 | WX-203D-T.....    | 5 | WX-350PA.....    | 4  |
| ST-448C.....     | 27 | WHS-120Z.....    | 15 | WX-203-G.....     | 4 | WX-350PA-G.....  | 4  |
| ST-449C.....     | 27 | WHS-120ZC.....   | 15 | WX-203PA.....     | 4 | WX-350PA-T.....  | 4  |
| ST-450C.....     | 27 | WHS-120ZCDW..... | 15 | WX-203PA-G.....   | 4 | WX-350-T.....    | 4  |
| ST-451(C).....   | 27 | WX1-250D.....    | 6  | WX-203PA-T.....   | 4 | WX-400L(CL)..... | 31 |
| ST-452(C).....   | 27 | WX1-251D.....    | 6  | WX-203-T.....     | 4 | WX-401(C).....   | 29 |
| ST-453(C).....   | 27 | WX1-302D.....    | 6  | WX-205.....       | 4 | WX-402(C).....   | 29 |
| ST-454(C).....   | 27 | WX-35L(CL).....  | 31 | WX-205D.....      | 5 | WX-403(C).....   | 29 |
| ST-455(C).....   | 27 | WX-50L(CL).....  | 31 | WX-205D-G.....    | 5 | WX-404(C).....   | 29 |
| ST-456(C).....   | 27 | WX-85L(CL).....  | 31 | WX-205D-T.....    | 5 | WX-405(C).....   | 29 |
| ST-457(C).....   | 27 | WX-100L(CL)..... | 31 | WX-205-G.....     | 4 | WX-406(C).....   | 29 |
| ST-500L(CL)..... | 28 | WX-101.....      | 5  | WX-205PA.....     | 4 | WX-407(C).....   | 29 |
| ST-600L(CL)..... | 28 | WX-101-G.....    | 5  | WX-205PA-G.....   | 4 | WX-421.....      | 30 |
| SX-30V.....      | 12 | WX-102.....      | 5  | WX-205PA-T.....   | 4 | WX-422.....      | 30 |
| SX-40V.....      | 12 | WX-102-G.....    | 5  | WX-205-T.....     | 4 | WX-423.....      | 30 |
| SX-60V.....      | 12 | WX-102PS.....    | 5  | WX-250.....       | 4 | WX-424.....      | 30 |
| SX-90V.....      | 12 | WX-102VFD.....   | 5  | WX-250D.....      | 5 | WX-426.....      | 30 |
| SX-110V.....     | 12 | WX-103.....      | 5  | WX-250D-G.....    | 5 | WX-427.....      | 30 |
| SX-130V.....     | 12 | WX-103-G.....    | 5  | WX-250D-T.....    | 5 | WX-447(C).....   | 30 |
| SX-160V.....     | 12 | WX-104.....      | 5  | WX-250-G.....     | 4 | WX-448(C).....   | 30 |
| T-5.....         | 10 | WX-104-G.....    | 5  | WX-250PA.....     | 4 | WX-449(C).....   | 30 |
| T-5-FF.....      | 10 | WX-105PS.....    | 5  | WX-250PA-G.....   | 4 | WX-450(C).....   | 30 |
| T-12.....        | 10 | WX-110PS.....    | 5  | WX-250PA-T.....   | 4 | WX-451(C).....   | 30 |
| T-12-FF.....     | 10 | WX-130L(CL)..... | 31 | WX-250-T.....     | 4 | WX-452(C).....   | 30 |
| UNVDKT.....      | 8  | WX-165L(CL)..... | 31 | WX-250UG.....     | 6 | WX-453(C).....   | 30 |
| WF-14.....       | 6  | WX-200.....      | 5  | WX-251.....       | 4 | WX-454(C).....   | 30 |
| WF-20.....       | 6  | WX-200-G.....    | 5  | WX-251D.....      | 5 | WX-455(C).....   | 30 |
| WF-26.....       | 6  | WX-200L(CL)..... | 31 | WX-251D-G.....    | 5 | WX-456(C).....   | 30 |
| WF-32.....       | 6  | WX-200PS.....    | 5  | WX-251D-T.....    | 5 | WX-457(C).....   | 30 |
| WF-34.....       | 6  | WX-200UG.....    | 6  | WX-251-G.....     | 4 | WX-458C.....     | 30 |
| WF-44.....       | 6  | WX-201.....      | 4  | WX-251PA.....     | 4 | WX-459C.....     | 30 |
| WF-62.....       | 6  | WX-201D.....     | 5  | WX-251PA-G.....   | 4 | WX-460C.....     | 30 |
| WF-81.....       | 6  | WX-201D-G.....   | 5  | WX-251PA-T.....   | 4 | WX-461C.....     | 30 |
| WF-86.....       | 6  | WX-201D-T.....   | 5  | WX-251-T.....     | 4 | WX-462C.....     | 30 |
| WF-119.....      | 6  | WX-201-G.....    | 4  | WX-251UG.....     | 6 | WX-463C.....     | 30 |
| WH-7C.....       | 15 | WX-201-T.....    | 4  | WX-252.....       | 4 | WX-500L(CL)..... | 31 |
| WH-7CDW.....     | 15 | WX-202.....      | 4  | WX-255.....       | 4 | WX-600L(CL)..... | 31 |
| WH-7ZC.....      | 15 | WX-202D.....     | 5  | WX-255D.....      | 5 |                  |    |

## AX Models: Horizontal Diaphragm Type, ASME

| Base Model | Part No. | Seismic Restraints | Part No. | Sight Glass | Part No. | Sight Glass & Restraints | Part No. |
|------------|----------|--------------------|----------|-------------|----------|--------------------------|----------|
| AX15-125   | 117-0015 | AX15-125R          | 117-0019 | AX15-125SG  | 117-0026 | AX15-125SGR              | 117-235  |
| AX20-125   | 117-0020 | AX20-125R          | 117-0028 | AX20-125SG  | 117-0029 | AX20-125SGR              | 117-0030 |
| AX40-125   | 117-0040 | AX40-125R          | 117-0048 | AX40-125SG  | 117-0049 | AX40-125SGR              | 117-434  |
| AX60-125   | 117-0060 | AX60-125R          | 117-0070 | AX60-125SG  | 117-0071 | AX60-125SGR              | 117-0072 |
| AX80-125   | 117-80   | AX80-125R          | 117-86   | AX80-125SG  | 117-87   | AX80-125SGR              | 117-88   |
| AX100-125  | 117-100  | AX100-125R         | 117-106  | AX100-125SG | 117-107  | AX100-125SGR             | 117-108  |
| AX120-125  | 117-120  | AX120-125R         | 117-127  | AX120-125SG | 117-128  | AX120-125SGR             | 117-143  |
| AX144-125  | 117-144  | AX144-125R         | 117-153  | AX144-125SG | 117-154  | AX144-125SGR             | 117-155  |
| AX180-125  | 117-180  | AX180-125R         | 117-188  | AX180-125SG | 117-189  | AX180-125SGR             | 117-190  |
| AX200-125  | 117-200  | AX200-125R         | 117-206  | AX200-125SG | 117-207  | AX200-125SGR             | 117-232  |
| AX240-125  | 117-408  | AX240-125R         | 117-409  | AX240-125SG | 117-411  | AX240-125SGR             | N/A      |
| AX260-125  | 117-420  | AX260-125R         | 117-422  | AX260-125SG | 117-423  | AX260-125SGR             | 117-617  |
| AX280-125  | 117-430  | AX280-125R         | 117-432  | AX280-125SG | 117-433  | AX280-125SGR             | N/A      |

## AX-V Models: Vertical Diaphragm Type, ASME

| Base Model | Part No. | Seismic Restraints | Part No. | Sight Glass  | Part No. | Sight Glass & Restraints | Part No. |
|------------|----------|--------------------|----------|--------------|----------|--------------------------|----------|
| AX15V-125  | 117-401  | AX15V-125R         | 117-439  | AX15V-125SG  | 117-407  | AX15V-125SGR             | 117-536  |
| AX20V-125  | 117-402  | AX20V-125R         | 117-236  | AX20V-125SG  | 117-406  | AX20V-125SGR             | N/A      |
| AX40V-125  | 117-403  | AX40V-125R         | 117-416  | AX40V-125SG  | 117-405  | AX40V-125SGR             | 117-417  |
| AX60V-125  | 117-0062 | AX60V-125R         | 117-346  | AX60V-125SG  | 117-0074 | AX60V-125SGR             | 117-578  |
| AX80V-125  | 117-81   | AX80V-125R         | 117-275  | AX80V-125SG  | 117-90   | AX80V-125SGR             | 117-277  |
| AX100V-125 | 117-101  | AX100V-125R        | 117-840  | AX100V-125SG | 117-110  | AX100V-125SGR            | 117-942  |
| AX120V-125 | 117-121  | AX120V-125R        | 117-345  | AX120V-125SG | 117-131  | AX120V-125SGR            | 117-220  |
| AX144V-125 | 117-145  | AX144V-125R        | 117-438  | AX144V-125SG | 117-151  | AX144V-125SGR            | N/A      |
| AX180V-125 | 117-181  | AX180V-125R        | 117-404  | AX180V-125SG | 117-192  | AX180V-125SGR            | 117-606  |
| AX200V-125 | 117-201  | AX200V-125R        | 117-347  | AX200V-125SG | 117-210  | AX200V-125SGR            | 117-564  |
| AX240V-125 | 117-281  | AX240V-125R        | 117-885  | AX240V-125SG | 117-412  | AX240V-125SGR            | 117-414  |
| AX260V-125 | 117-421  | AX260V-125R        | 117-440  | AX260V-125SG | 117-442  | AX260V-125SGR            | 117-576  |
| AX280V-125 | 117-431  | AX280V-125R        | 117-441  | AX280V-125SG | 117-437  | AX280V-125SGR            | 117-577  |

## L Models: Full Acceptance Bladder, Top Connection, ASME

| Base Model | Part No. | Seismic Restraints | Part No. | Sight Glass | Part No. | Sight Glass & Restraints | Part No. |
|------------|----------|--------------------|----------|-------------|----------|--------------------------|----------|
| 200L-125   | 191-2    | 200L-125R          | 191-6    | 200L-125SG  | 191-15   | 200L-125SGR              | 191-7    |
| 300L-125   | 192-2    | 300L-125R          | 192-29   | 300L-125SG  | 192-15   | 300L-125SGR              | 192-30   |
| 400L-125   | 193-2    | 400L-125R          | 193-30   | 400L-125SG  | 193-15   | 400L-125SGR              | 193-43   |
| 500L-125   | 194-2    | 500L-125R          | 194-6    | 500L-125SG  | 194-15   | 500L-125SGR              | 194-5    |
| 600L-125   | 174-2    | 600L-125R          | 174-32   | 600L-125SG  | 174-8    | 600L-125SGR              | 174-37   |
| 800L-125   | 175-2    | 800L-125R          | 175-35   | 800L-125SG  | 175-8    | 800L-125SGR              | 175-36   |
| 1000L-125  | 176-2    | 1000L-125R         | 176-30   | 1000L-125SG | 176-7    | 1000L-125SGR             | 176-33   |
| 1200L-125  | 177-2    | 1200L-125R         | 177-31   | 1200L-125SG | 177-7    | 1200L-125SGR             | 177-24   |
| 1400L-125  | 178-2    | 1400L-125R         | 178-31   | 1400L-125SG | 178-8    | 1400L-125SGR             | 178-33   |
| 1600L-125  | 179-2    | 1600L-125R         | 179-30   | 1600L-125SG | 179-7    | 1600L-125SGR             | 179-33   |
| 2000L-125  | 180-2    | 2000L-125R         | 180-31   | 2000L-125SG | 180-7    | 2000L-125SGR             | 180-16   |
| 2500L-125  | 180-33   | 2500L-125R         | 180-47   | 2500L-125SG | N/A      | 2500L-125SGR             | 180-126  |
| 3000L-125  | 180-34   | 3000L-125R         | 180-54   | 3000L-125SG | 180-86   | 3000L-125SGR             | 180-132  |
| 3500L-125  | 189-1    | 3500L-125R         | 189-22   | 3500L-125SG | N/A      | 3500L-125SGR             | N/A      |
| 4000L-125  | 189-2    | 4000L-125R         | 189-28   | 4000L-125SG | 189-36   | 4000L-125SGR             | N/A      |
| 5000L-125  | 189-3    | 5000L-125R         | N/A      | 5000L-125SG | N/A      | 5000L-125SGR             | 189-41   |

FREQUENTLY USED PART NUMBERS

## LBC Models: Partial Acceptance Bladder, Bottom Connection, ASME

| Base Model | Part No. | Seismic Restraints | Part No. | Sight Glass  | Part No. | Sight Glass & Restraints | Part No. |
|------------|----------|--------------------|----------|--------------|----------|--------------------------|----------|
| 35LBC-125  | 165-5    | 35LBC-125R         | 165-13   | 35LBC-125SG  | 165-11   | 35LBC-125SGR             | 165-15   |
| 50LBC-125  | 166-5    | 50LBC-125R         | 166-12   | 50LBC-125SG  | 166-11   | 50LBC-125SGR             | 166-14   |
| 85LBC-125  | 167-4    | 85LBC-125R         | 167-11   | 85LBC-125SG  | N/A      | 85LBC-125SGR             | 167-12   |
| 100LBC-125 | 168-4    | 100LBC-125R        | 168-7    | 100LBC-125SG | 168-11   | 100LBC-125SGR            | N/A      |
| 130LBC-125 | 169-4    | 130LBC-125R        | 169-7    | 130LBC-125SG | 169-10   | 130LBC-125SGR            | 169-11   |
| 165LBC-125 | 171-15   | 165LBC-125R        | 171-21   | 165LBC-125SG | N/A      | 165LBC-125SGR            | N/A      |
| 200LBC-125 | 191-33   | 200LBC-125R        | 191-41   | 200LBC-125SG | 191-39   | 200LBC-125SGR            | 191-45   |
| 300LBC-125 | 192-31   | 300LBC-125R        | 192-37   | 300LBC-125SG | 192-38   | 300LBC-125SGR            | N/A      |
| 400LBC-125 | 193-32   | 400LBC-125R        | 193-37   | 400LBC-125SG | 193-40   | 400LBC-125SGR            | N/A      |
| 500LBC-125 | 194-32   | 500LBC-125R        | N/A      | 500LBC-125SG | N/A      | 500LBC-125SGR            | 194-42   |
| 600LBC-125 | 174-36   | 600LBC-125R        | 174-42   | 600LBC-125SG | N/A      | 600LBC-125SGR            | N/A      |

## ST Models: Diaphragm Type, ASME

| Base Model  | Part No. | Seismic Restraints | Part No. | Sight Glass   | Part No. | Sight Glass & Restraints | Part No. |
|-------------|----------|--------------------|----------|---------------|----------|--------------------------|----------|
| ST20VC-150  | 141-009  | ST20VC-150R        | 141-010  | ST20VC-150SG  | 142-134  | ST20VC-150SGR            | N/A      |
| ST30VC-150  | 143-218  | ST30VC-150R        | 143-364  | ST30VC-150SG  | 143-269  | ST30VC-150SGR            | N/A      |
| ST42VC-150  | 144-0148 | ST42VC-150R        | 144-229  | ST42VC-150SG  | 144-179  | ST42VC-150SGR            | N/A      |
| ST60VC-150  | 146-751  | ST60VC-150R        | 146-796  | ST60VC-150SG  | 146-759  | ST60VC-150SGR            | N/A      |
| ST70VC-150  | 146-790  | ST70VC-150R        | 146-822  | ST70VC-150SG  | 146-808  | ST70VC-150SGR            | N/A      |
| ST80VC-150  | 147-139  | ST80VC-150R        | 147-202  | ST80VC-150SG  | 147-141  | ST80VC-150SGR            | 147-194  |
| ST120VC-150 | 147-199  | ST120VC-150R       | 147-218  | ST120VC-150SG | N/A      | ST120VC-150SGR           | N/A      |
| ST180VC-150 | 148-109  | ST180VC-150R       | 148-156  | ST180VC-150SG | 148-120  | ST180VC-150SGR           | N/A      |
| ST210VC-150 | 148-110  | ST210VC-150R       | 148-166  | ST210VC-150SG | 148-116  | ST210VC-150SGR           | N/A      |

## WELL-X-TROL® Quick Sizing

| Pump Discharge Rate (Approx. GPM) | OPERATING PRESSURE |            |            |            |            |            |
|-----------------------------------|--------------------|------------|------------|------------|------------|------------|
|                                   | 30/50 PSIG         |            | 40/60 PSIG |            | 50/70 PSIG |            |
|                                   | ESP I              | ESP II     | ESP I      | ESP II     | ESP I      | ESP II     |
| 5                                 | WX-202             | WX-205     | WX-202     | WX-205     | WX-202     | WX-250     |
| 7                                 | WX-202XL           | WX-250     | WX-203     | WX-251     | WX-203     | WX-251     |
| 10                                | WX-205             | WX-251     | WX-205     | WX-255     | WX-250     | WX-302     |
| 12                                | WX-250             | WX-255     | WX-250     | WX-255     | WX-251     | WX-350     |
| 15                                | WX-250             | WX-302     | WX-251     | WX-350     | WX-251     | WX-350     |
| 20                                | WX-251             | WX-350     | WX-255     | WX-255 (2) | WX-302     | WX-302 (2) |
| 25                                | WX-255             | WX-255 (2) | WX-302     | WX-302 (2) | WX-350     | WX-350 (2) |
| 30                                | WX-302             | WX-302 (2) | WX-350     | WX-350 (2) | WX-350     | WX-302 (3) |
| 35                                | WX-350             | WX-350 (2) | WX-350     | WX-350 (2) | WX-255 (2) | WX-350 (3) |
| 40                                | WX-350             | WX-350 (2) | WX-255 (2) | WX-302 (3) | WX-302 (2) | WX-350 (3) |

ESP I - Effective Sizing Protection I: The tank selection is based on approximately one minute running time. This is recommended for pumps up to 3/4 hp.  
 ESP II - Effective Sizing Protection II: The tank selection is based on approximately two minutes running time. This is recommended for pumps 3/4 hp or larger.

## THERM-X-TROL® Quick Sizing

| Maximum Temperature Setting 140°F |                               |       |        | Maximum Temperature Setting 160°F |                               |        |        | Maximum Temperature Setting 180°F |                               |        |        |
|-----------------------------------|-------------------------------|-------|--------|-----------------------------------|-------------------------------|--------|--------|-----------------------------------|-------------------------------|--------|--------|
| Water Heater Size (gals.)         | Static Supply Pressure (psig) |       |        | Water Heater Size (gals.)         | Static Supply Pressure (psig) |        |        | Water Heater Size (gals.)         | Static Supply Pressure (psig) |        |        |
|                                   | 40                            | 60    | 80     |                                   | 40                            | 60     | 80     |                                   | 40                            | 60     | 80     |
| 40                                | ST-5                          | ST-5  | ST-5   | 40                                | ST-5                          | ST-5   | ST-8   | 40                                | ST-8                          | ST-8   | ST-8   |
| 50                                | ST-5                          | ST-5  | ST-5   | 50                                | ST-5                          | ST-8   | ST-8   | 50                                | ST-8                          | ST-8   | ST-12  |
| 60                                | ST-8                          | ST-8  | ST-8   | 60                                | ST-8                          | ST-8   | ST-12  | 60                                | ST-8                          | ST-12  | ST-25V |
| 80                                | ST-8                          | ST-8  | ST-12  | 80                                | ST-8                          | ST-12  | ST-25V | 80                                | ST-12                         | ST-25V | ST-25V |
| 120                               | ST-12                         | ST-12 | ST-25V | 120                               | ST-12                         | ST-25V | ST-25V | 120                               | ST-25V                        | ST-25V | ST-25V |

Sizing based on: 40°F incoming water temperature; 150 psi T&P safety relief valve; Precharge equal to static supply pressure.  
 For larger applications: Visit [amtrol.com](http://amtrol.com), download the AMTROL App or contact Technical Support at 401.535.1216.

## EXTROL® Quick Sizing

| Boiler                          | Type of Radiation                  |                            |                     |                     |
|---------------------------------|------------------------------------|----------------------------|---------------------|---------------------|
|                                 | Finned Baseboard or Radiant Panels | Convectors or Unit Heaters | Radiators Cast Iron | Baseboard Cast Iron |
| Net Output in 1000'S of BTU/Hr. |                                    |                            |                     |                     |
| MBH                             | Use Model                          | Use Model                  | Use Model           | Use Model           |
| 25                              | EX-15                              | EX-15                      | EX-15               | EX-15               |
| 50                              | EX-15                              | EX-15                      | EX-30               | EX-30               |
| 75                              | EX-30                              | EX-30                      | EX-30               | EX-60               |
| 100                             | EX-30                              | EX-30                      | EX-60               | EX-60               |
| 125                             | EX-30                              | EX-60                      | EX-60               | EX-90               |
| 150                             | EX-30                              | EX-60                      | EX-90               | EX-90               |
| 175                             | EX-60                              | EX-60                      | SX Series           | SX Series           |
| 200                             | EX-60                              | EX-60                      | SX Series           | SX Series           |
| 250                             | EX-60                              | EX-90                      | SX Series           | SX Series           |
| 300                             | EX-90                              | SX Series                  | SX Series           | SX Series           |

Sizing based on: 12 psig Fill; 30 psig Relief Valve; 200°F Average Temperature.  
 For sizing with fluids other than water: Visit [amtrol.com](http://amtrol.com), download the AMTROL App or contact Technical Support at 401-535-1216.

QUICK SIZING





---

---

---

---

---

---

---

---

---

---

---

---

---

---

---

---

---

---

---

---

---

---

---

---

---

---

---



| <b>PRODUCT</b>                           | <b>MODELS</b>  | <b>DURATION (from date of purchase)</b>   |
|--|--|---|
| <b>WATER SYSTEMS</b>                     |  |   |
| Well-X-Trol® Residential Well Tanks      | WX   | Seven (7) Year Limited Warranty*  |
| Well-X1® Constant Pressure System        | WX1  | Seven (7) Year Limited Warranty (Tank)*<br>Two (2) Year Limited Warranty (Control)  |
| CH, WF & PL Well Tanks                   | All  | Five (5) Year Limited Warranty  |
| Guardian CP® Digital Control             | DC2  | Two (2) Year Limited Warranty   |
| Reverse Osmosis (RO) Tanks               | RO   | Five (5) Year Limited Warranty  |
| Retention Tanks                          | ERTG   | Three (3) Year Limited Warranty   |
| AMTROL Pressuriser®                      | RP   | Two (2) Year Limited Warranty   |
| <b>PLUMBING &amp; HEATING</b>            |  |   |
| Extrol® Expansion Tanks                  | EX, RX & SE<br>SX  | Five (5) Year Limited Warranty<br>One (1) Year Limited Warranty   |
| Fill-Trol® Tanks                         | FT   | Five (5) Year Limited Warranty  |
| Thermal Expansion Tanks                  | ST-5 through ST-25V<br>ST-30V through ST-210V<br>T   | Five (5) Year Limited Warranty<br>One (1) Year Limited Warranty<br>One (1) Year Limited Warranty  |
| Mini-Trol®<br>Diatrol®                   | All<br>All   | Five (5) Year Limited Warranty<br>Five (5) Year Limited Warranty (Residential)  |
| <b>HOT WATER MAKERS®</b>                 |  |   |
| BoilerMate® Hot Water Makers             | CH & WH-41   | Six (6) Year Limited Warranty on Heat Exchanger and Tank Assembly Only. Limited Lifetime Upgrade Option Available. See Literature for Upgrade Information.      |
| HYDROMAX® Hot Water Makers               | HM   | Seven (7) Year Limited Warranty on Heat Exchanger and Tank Assembly Only. Limited Lifetime Upgrade Option Available. See Literature for Upgrade Information.    |
| Ener-G-Net™ Control                      |  | Two (2) Year Limited Warranty   |
| Premier™ Hot Water Makers                | WH-7, WHS, DC & S  | Five (5) Year Limited Warranty in Commercial Applications. Ten (10) Year Limited Warranty in Residential Applications on Heat Exchanger and Tank Assembly Only. |
| <b>ALL OTHER</b>                         |  |   |
| All Other Products, Components and Parts | If not specified above including Hot Water Maker components and parts other than the Heat Exchanger and Tank Assembly. | One (1) Year Limited Warranty   |

**For detailed warranty information, please visit [www.amtrol.com](http://www.amtrol.com)**

All dimensions and weights listed are approximate.

\*Units manufactured April 1, 2010 or later.

# Look **INSIDE THE TANK.**

Outward appearances matter, but cut open our products and you'll see some important differences. It's what's on the inside that matters the most.



1400 Division Road, West Warwick, RI USA 02893  
T: 800.426.8765 F: 800.293.1519  
[www.amtrol.com](http://www.amtrol.com)