

BETHLEHEM STRUCTURAL SHAPES

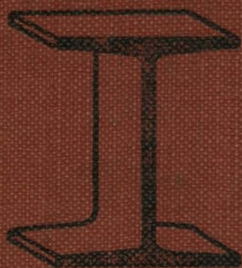

1911

AISC E&R Library



5342

ARCH

A685

.B47

1911

5342

B1

CATALOGUE
OF
BETHLEHEM
STRUCTURAL SHAPES

MANUFACTURED BY
BETHLEHEM STEEL COMPANY
SOUTH BETHLEHEM, PA.

PREPARED UNDER DIRECTION OF
GEORGE H. BLAKELEY,
MEM. AM. SOC. C. E.
MEM. AM. SOC. M. E.

GENERAL OFFICES,
At the Works, South Bethlehem, Pa.

BRANCH SALES OFFICES:

- BOSTON, 141 Milk Street.
- NEW YORK, 111 Broadway.
- PHILADELPHIA, Morris Building.
- PITTSBURGH, First National Bank Building.
- CLEVELAND, 1266 Ontario Street.
- CHICAGO, Peoples Gas Building.
- SAN FRANCISCO, Crocker Building.
- LONDON, 25 Victoria Street, S. W.

NOTICE.

This edition of the catalogue supersedes previous issues. It differs from the 1909 edition in some unimportant changes only, and in the addition of further information relating to the use and application of the Bethlehem Sections.

Information has been added regarding Compound Columns, built of Bethlehem H Sections with cover plates, as such may be of service where columns of larger sectional area than at present rolled are needed for very heavy loads.

While the catalogue shows the 8-inch and 9-inch I Beams, Sections B8 and B9, our patrons are advised that these small beams are not rolled at present, nor until further notice. Otherwise all the sections shown in the catalogue are produced.

BETHLEHEM STEEL COMPANY.

January, 1911.

PREFACE.

BEFORE placing the Grey Mills at Bethlehem in operation, the sections proposed to be rolled were designed and published in advance for the information of engineers and architects regarding the radical improvement in structural shapes, which the enterprise of the Bethlehem Steel Company purposed to offer in this country.

For more than a year the mills have now been in most successful operation, and the proposed sections, which were an unprecedented innovation, have since been used in hundreds of structures by the leading engineers and architects of this country. The experience thus acquired with actual demand has suggested some slight modifications of the sections, increasing their adaptability for the varied uses to which they have been applied.

Wide flanges so greatly increase the lateral strength of beams, adapting them to many purposes for which the previous Standard beams of the country could not be used, that it was found to be an improvement to further increase the width of the flanges of the Bethlehem I beam sections. Due to the greater effective depth of section thus secured, the thickness of the webs has been slightly increased in proportion, in most instances without adding to the weight of the sections.

A uniform bevel of 9 per cent. has now been adopted for the flanges of all beam and girder sections as a metallurgical improvement, and also for reasons of mechanical convenience of production.

Considerable reduction has been made in the number of column sections rolled, though still affording the same range of sizes, from minimum to maximum, as previously. Experience with the actual demands of construction has demonstrated that the range of sizes given in the present catalog is amply sufficient for every purpose; and, as they are produced with fewer roll changes, they consequently can be furnished more promptly.

SOUTH BETHLEHEM, PA.

May 1, 1909.

BETHLEHEM STRUCTURAL SHAPES.

Bethlehem structural shapes have proven to be a radical improvement and advance in the field of structural steel, reducing the cost and extending the use of steel in construction. They have achieved a remarkable success, and are highly regarded and strongly endorsed by leading engineers and architects.

Bethlehem structural shapes are wide flange I beam sections rolled by the Grey Universal Beam Mill. Similar beams, 10 to 30 inches deep, with flanges 10 to 12 inches wide, have been rolled by the Grey Mill in Germany since 1902 and are used extensively in Europe, England, Canada, and elsewhere. The larger and improved Grey Mills at Bethlehem, placed in successful operation early in 1908, rendered such sections available with their numerous advantages for the first time in this country.

In regard to shape and strength, Bethlehem Sections afford great advantages unobtainable with old style Standard beams. They can be used for every purpose instead of ordinary beams, or even instead of riveted sections, with economy in weight or saving in cost of fabrication, and in most cases with a saving both in weight and in cost of fabrication.

Instead of the horizontal grooved rolls of the old style mill, the Grey Mill has both horizontal and vertical rolls, forming the web and flanges of a beam by coincident rolling operations. Wider flanges are thus obtained than can be made by former methods of rolling. The method of rolling is shown by Fig. 1, on the next page. The horizontal rolls, *H*, and the vertical rolls, *V*, are brought proportionately closer together at each successive passage of the beam through the rolls. Fig. 2 represents a supplementary mill through which the beam passes, the purpose of which is to edge the flanges only, no other work being done in this secondary mill.

For large beams the ingot is cast approximately of an I beam shape, as shown by Fig. 3, in which the outer line represents the cross-section of the ingot in relation to the finished beam, both being drawn to scale. By successive reductions the ingot is rolled into a beam of proportionate dimensions.

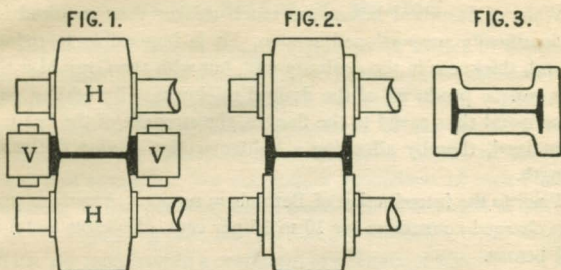

Shapes produced by the Grey Mill have thus a uniform work of reduction in the rolling on all parts of the section, which is not the case in beams rolled by the ordinary mill. The web is the only part of the shape actually rolled in the ordinary beam mill, the flanges being produced by crowding and dragging the metal through the flange grooves. Especially larger sizes of beams rolled by the old method show great variations in strength of the metal in the web and flanges, indicating a condition of internal stress due to the very unequal deformation in the rolling. Shapes of all sizes rolled by the Grey Mill, due to their scientific method of production, have practically a uniform quality of metal throughout the section and consequently an absence of internal stress. Such sections are safer and more reliable than beams rolled in the old way, especially when subject to impact or vibration.

In the following table this uniformity of quality is illustrated by results taken at random from numerous tests of Bethlehem sections:

Location of Test Piece.	Ultimate Strength, Lbs. per Sq. In.	Elastic Limit, Lbs. per Sq. In.	Elongation in 8 Inches.	Reduction of Area.
30" I Beam:				
Web,	66,550	39,960	25.6 %	50.6 %
Flange,	63,190	37,200	26.2 "	51.5 "
Root,	64,480	38,880	26.3 "	49.8 "
14" H Column:				
Web,	63,670	39,590	32.5 %	55.2 %
Flange,	61,740	38,180	31.2 "	59.9 "
Root,	63,520	37,900	28.2 "	54.6 "

Webs of Standard beams are much thicker than required for a scientifically proportioned section. It is impossible to reduce the web thickness in the ordinary mill, but with the Grey Mill the webs can be produced of the desired thickness. By adding part of the metal thus saved to the flanges, the strength of the beam is maintained, thereby affording a lighter section having the same strength.

Prior to the introduction of Bethlehem sections, American steel mills charged consumers for 10 to 15 per cent. of useless metal in steel beams.

Heretofore the largest beam rolled in this country has been 24 inches deep, weighing 100 lbs. per foot, and having a section modulus of 198. Whenever greater strength was required, a riveted girder was necessary. Bethlehem beams range to a maximum size of 30 inches deep, weighing 200 lbs. per foot, and having a section modulus of 610, or more than three times the strength of the largest beam previously rolled. The opportunity for using rolled beams instead of built-up riveted girders is, therefore, greatly increased.

Bethlehem rolled beam and girder sections can be advantageously used as girders for buildings, crane runways, short span bridges, track stringers, and for many other purposes where the more expensive type of riveted girder has heretofore been necessary. These rolled beams and rolled girders afford a saving in weight of metal and also a large economy in cost of fabrication, as they do not require the punching, assembling, and riveting necessary for building a riveted girder. The rolled beams can be obtained promptly as contrasted with the delay always experienced in procuring riveted girders.

Wide flanges give increased lateral stiffness, which commends the use of such beams in many cases, where the narrow flanges and lack of sufficient lateral rigidity prevent the use of ordinary Standard beams. Wide flanges also afford ample bearing surface and rigidity for girders for bridge floors, in which respects Standard beams are notably deficient.

Bethlehem structural shapes are designed to meet the requirements of American structural practice. Three separate types of shapes are furnished, viz.: Bethlehem I Beams, Girder Beams, and H Column sections.

BETHLEHEM I BEAMS.

Bethlehem I Beams from 8 inches to 24 inches in depth, inclusive, have the same strength, or section modulus and coefficient of strength, as Standard beams of the same depth. Bethlehem beams, due to the scientific proportion of the sections, weigh generally 10 per cent. less than Standard beams of the same depth and strength. For example, a Bethlehem 15-inch I Beam, weighing 54 lbs. per foot, has a coefficient of strength of 867,000. The corresponding Standard section is a 15-inch I beam weighing 60 lbs. per foot, having a coefficient of strength of 866,100. Therefore, for equal strength, the Bethlehem beam weighs 6 lbs. per foot less than the Standard beam, or a saving of 10 per cent. in weight.

Similar comparisons with other sizes of the Standard beams previously rolled by the mills of this country will show that the Bethlehem I beams afford an equal carrying capacity, but with practically 10 per cent. less weight of metal.

The table of "Comparison of Bethlehem I Beams with Standard I Beams," on page 41, shows the relation between the two types of beams for all sizes.

BETHLEHEM GIRDER BEAMS.

Bethlehem Girder Beams from 8 inches to 24 inches in depth, inclusive, have a strength, or section modulus and coefficient of strength, equal to that of two minimum weight Standard I beams of the same depth. The girder beam, however, weighs generally $12\frac{1}{2}$ per cent. less than the combined weight of the two Standard beams, not considering the saving in weight of separators needed for assembling the Standard beams into a girder. For example, a Bethlehem 15-inch girder beam, weighing 73 lbs. per foot, has a coefficient of strength of 1,256,000. Two Standard 15-inch I beams, each weighing 42 lbs. per foot, have a total coefficient of strength of 1,256,600. Thus, for equal depth and coefficient of strength, the girder beam weighs 11 lbs. per foot less than the two Standard beams. This is a saving of 13 per cent. in weight, not including separators, which would add at least $2\frac{1}{2}$ lbs. per foot more to the weight of the assembled girder. In this case a total saving of 16 per cent. in weight is afforded by the Bethlehem

girder beam, besides the saving in the cost of assembling the Standard beams into a girder.

The table of "Comparison of Bethlehem Girder Beams with Girders of Standard Beams," on page 40, shows the relation between the two types of beams.

The tables on pages 40 and 41 furnish a key for the comparison of Bethlehem I beams and girder beams with Standard beams. A framing plan for Standard beam shapes may be easily revised for the use of Bethlehem beam sections. In general, no rearrangement of the plan will be necessary and no recalculation will be required, except to select the proper Bethlehem sections which are equivalent in strength to the Standard beams and girders.

BETHLEHEM ROLLED H COLUMNS.

All column shapes having the same section number are made by the same rolls. Thus, the 14-inch H columns, comprising all the weights and variations in size of sections shown on page 44, are from the same rolls, furnishing a series of rolled columns of similar shape. Columns can thus be selected of the proper areas to suit variations of load, affording a wide range of sizes from the same rolling and insuring prompt delivery.

To provide for splices and connections is the only fabrication required for these rolled columns. In the case of columns with thick metal the holes require drilling, which can be done economically with a multiple drill. The saving in cost of fabricating the rolled column as compared with a built-up riveted column is a great advantage in favor of the solid rolled shape. Sections can be spliced to make a practically continuous column, and connections are easily made in the most approved manner of the best structural practice. All surfaces of the column are accessible for painting.

All Bethlehem sections are of open hearth steel exclusively, conforming to Manufacturers' Standard specifications, and also to American Railway Engineering and Maintenance of Way Association specifications. Material complying with any other standard specifications may be furnished by special arrangement. Large ingots, up to 10 tons in weight, are used, so that the work of reduction in rolling the shapes is sufficient to develop proper ductility of metal.

EXPLANATORY NOTES.

The flanges of Bethlehem I beams and girder beams have a uniform slope of 9 per cent. The flanges of the H column sections have a uniform slope of 2 per cent.

Bethlehem I beams and girder beams are increased, as shown in Fig. 1, by spreading the main rolls, which adds an equal amount to the thickness of the web and to the width of the flanges, all other dimensions remaining unchanged.

H column sections are increased, as shown in Fig. 2, by spreading both sets of rolls; the thickness of the web and the width of the flanges are increased equally, the thickness of the flanges being increased a proportionate amount.

Weights tabulated for Bethlehem I beams provide sufficient variations for ordinary purposes. Only the minimum weights are tabulated for the girder beams. Intermediate or heavier weights, corresponding to the usual variations of Standard beams, may be furnished by special arrangement. The H column sections are rolled only to the weights given in the tables.

The sections are numbered throughout the tables for convenience in identification and ordering.

Shapes will be cut to ordered length within an allowable variation either way, as follows: Bethlehem I beams from 8" to 24", inclusive, within $\frac{3}{8}$ inch; all other sections, within $\frac{1}{2}$ inch. For cutting with less variation, or to exact length, an extra price is charged.

Sections are furnished only at catalog weight. Shapes may have an allowable variation of $2\frac{1}{2}\%$ from nominal section.

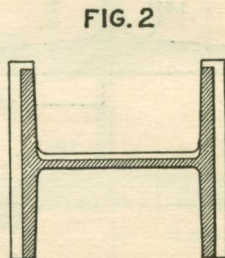
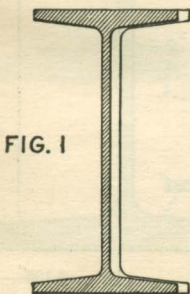

BETHLEHEM GIRDER BEAMS.

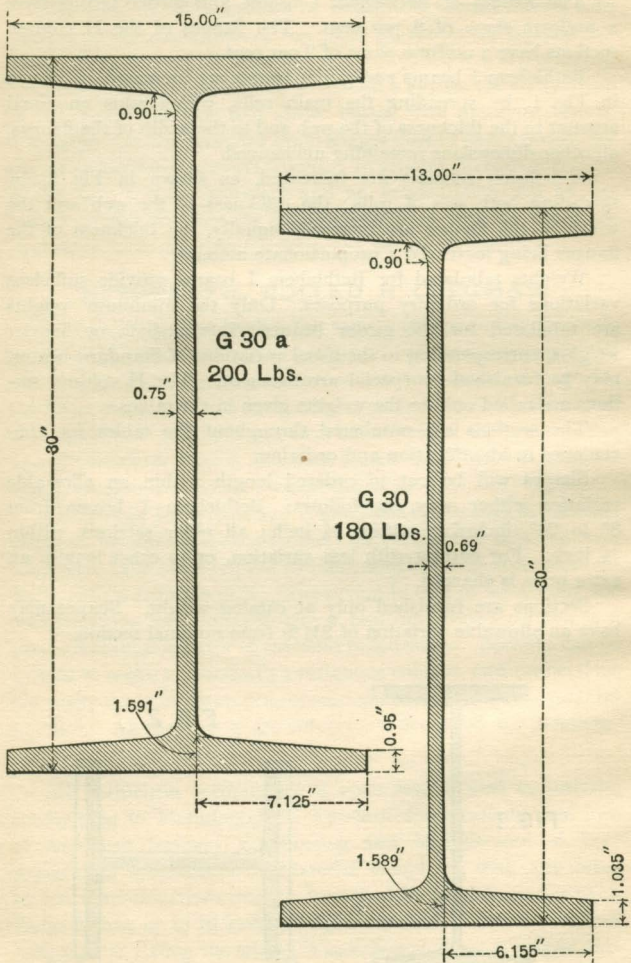

BETHLEHEM GIRDER BEAMS.

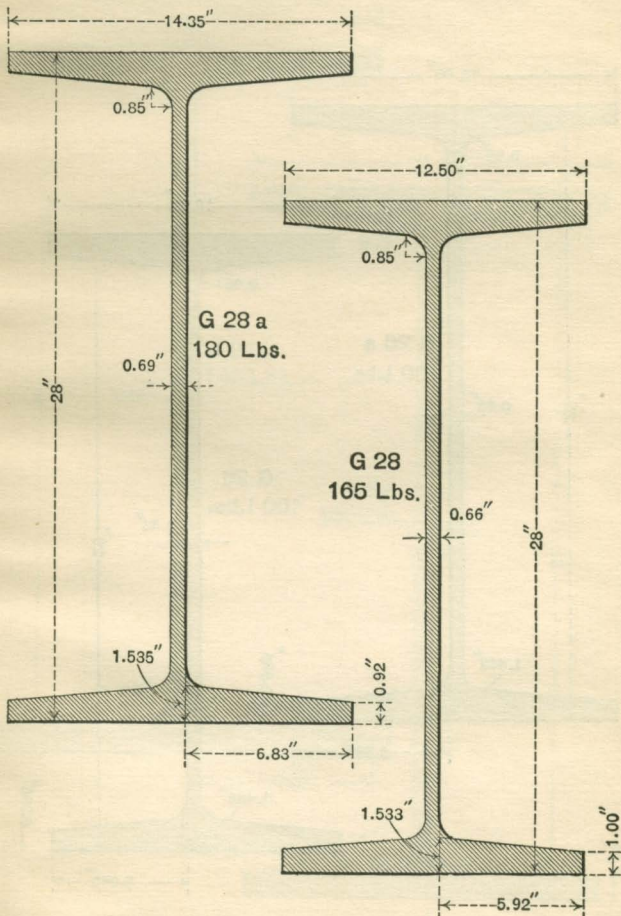

BETHLEHEM GIRDER BEAMS.

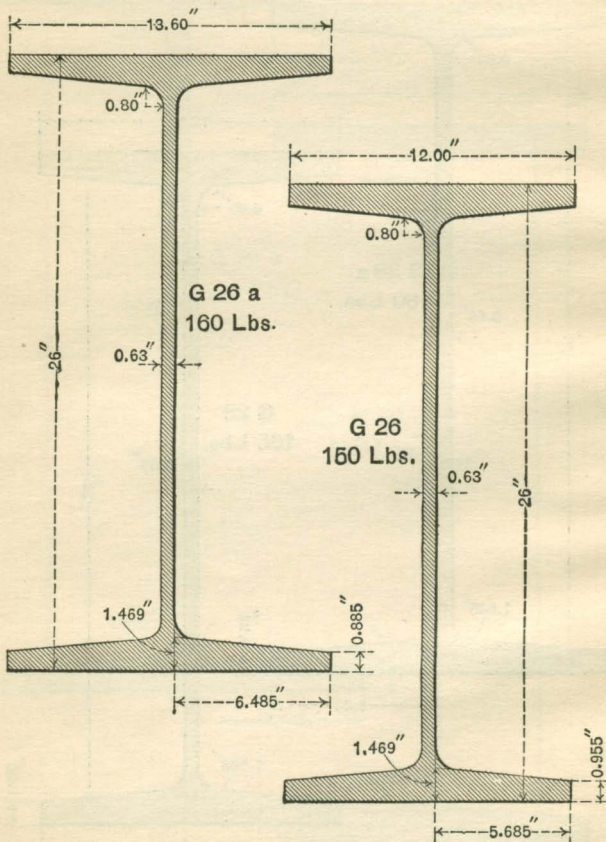

BETHLEHEM GIRDER BEAMS.

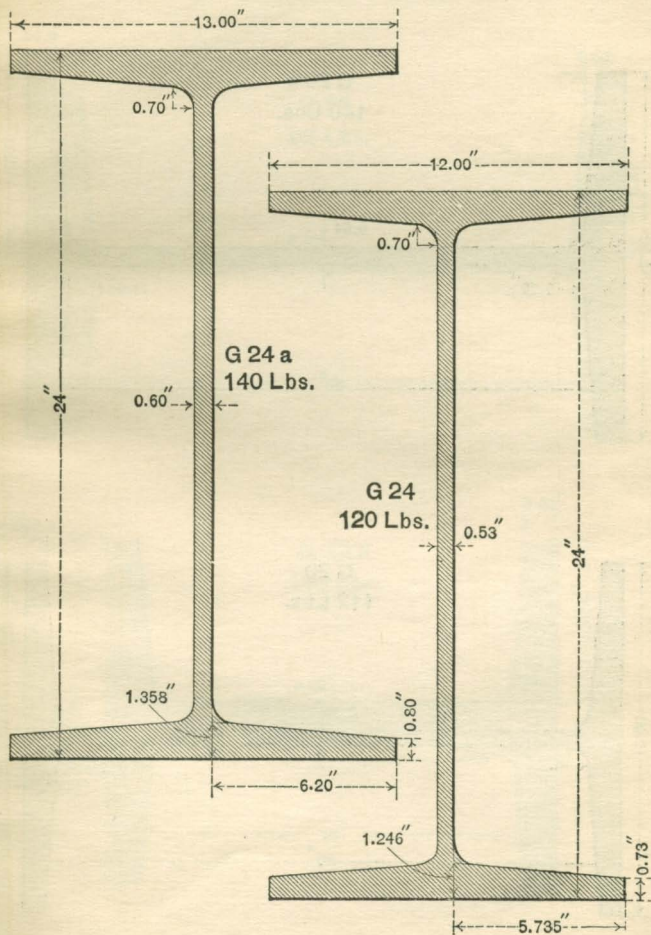

BETHLEHEM GIRDER BEAMS.

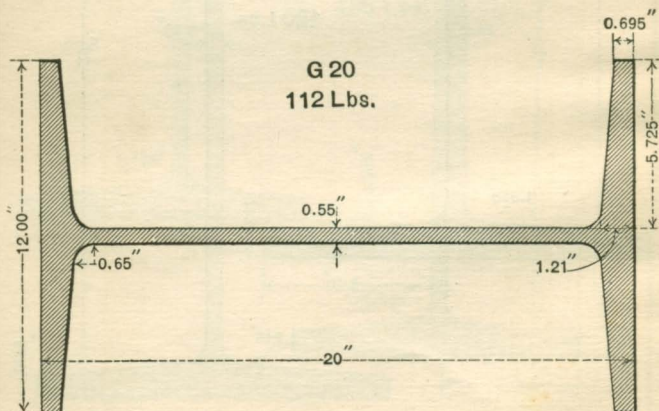
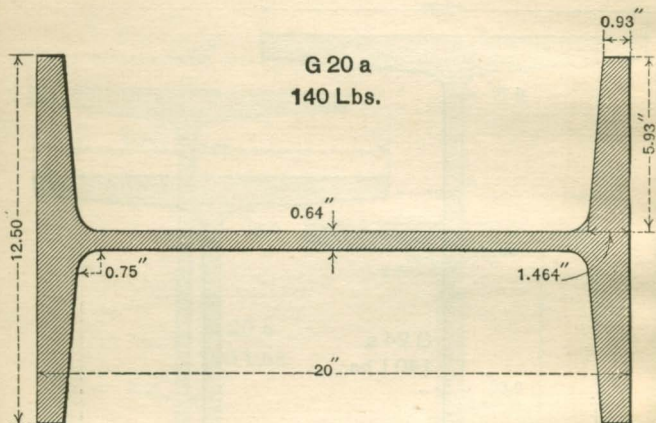

BETHLEHEM GIRDER BEAMS.

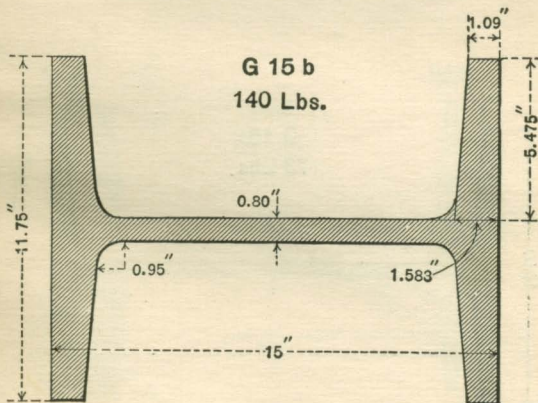
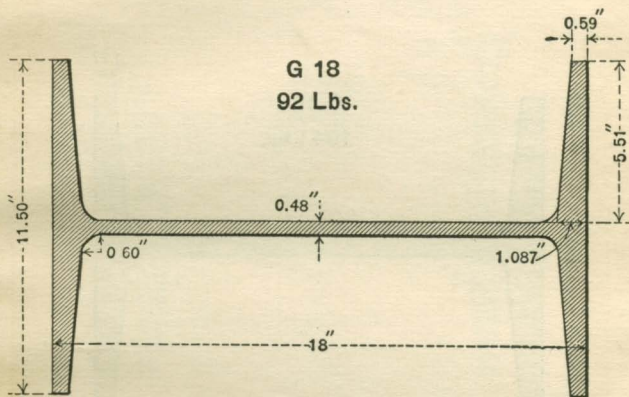

BETHLEHEM GIRDER BEAMS.

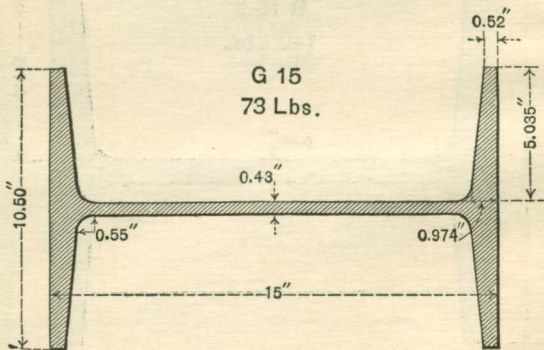
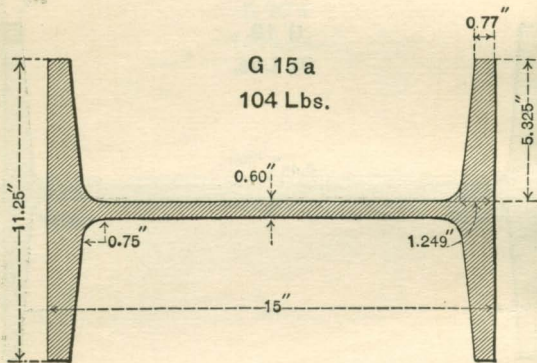

BETHLEHEM GIRDER BEAMS.

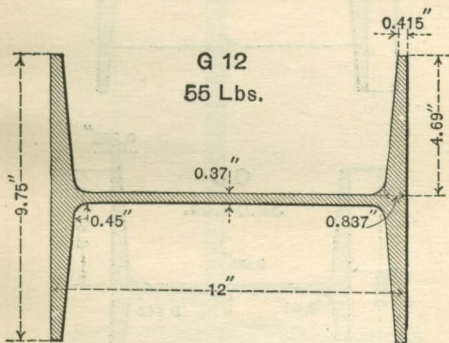
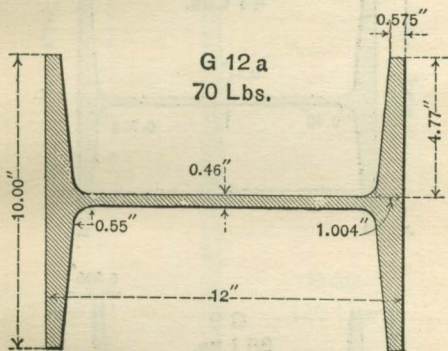

BETHLEHEM GIRDER BEAMS.

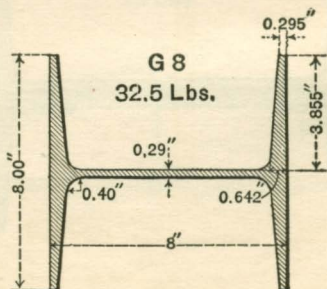
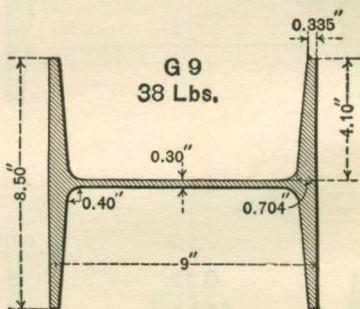
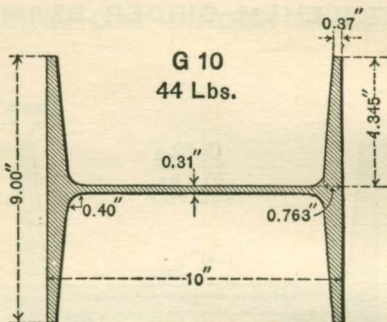

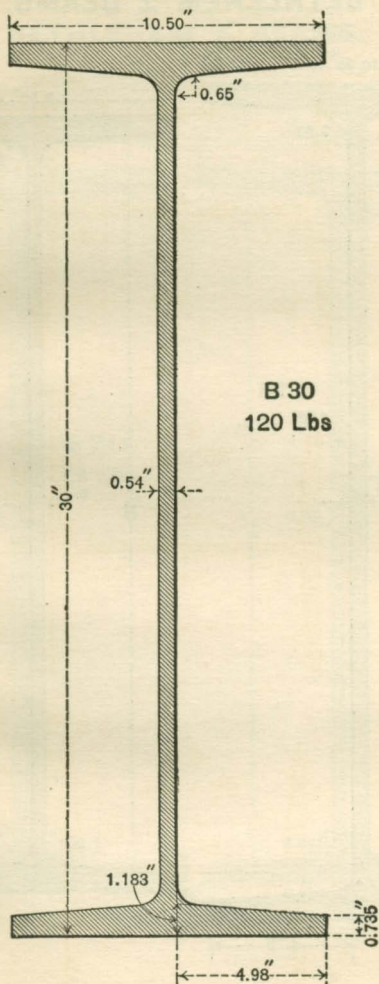
BETHLEHEM I BEAMS.

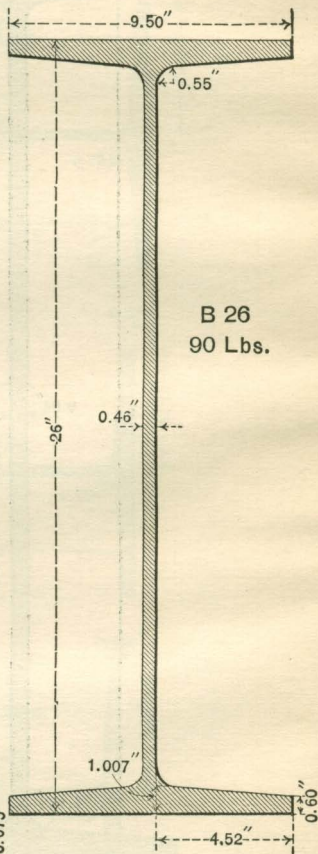
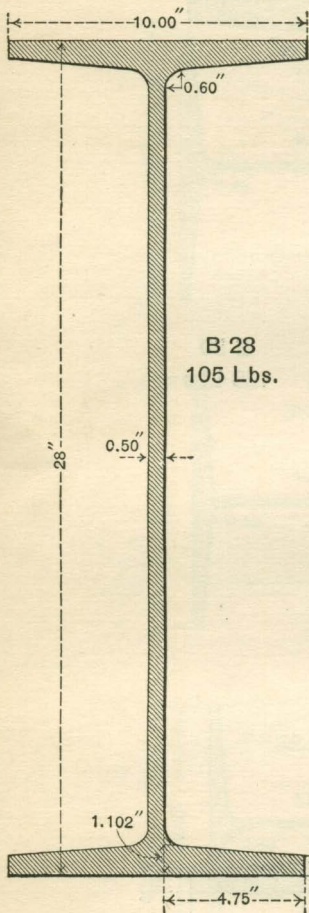
BETHLEHEM I BEAMS.

BETHLEHEM I BEAMS.

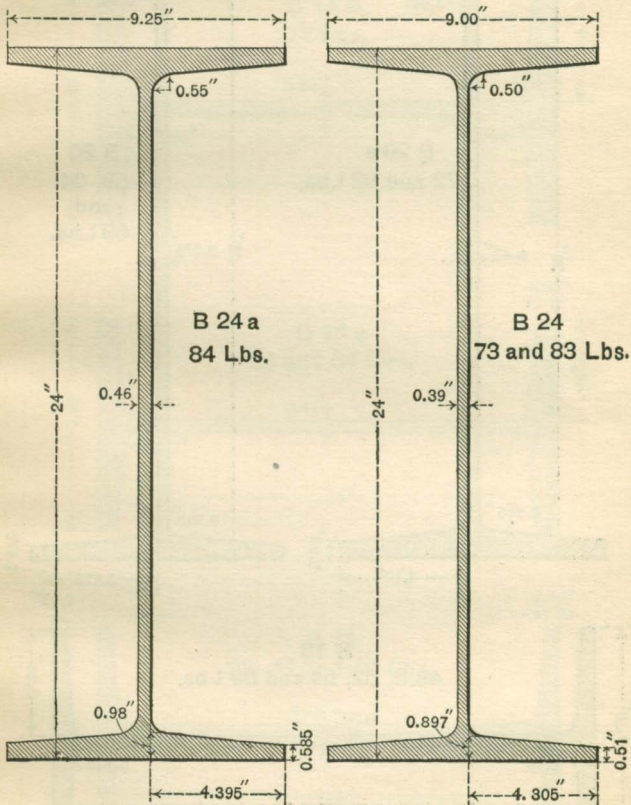

BETHLEHEM I BEAMS.

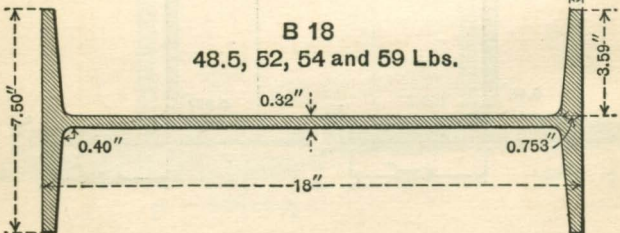
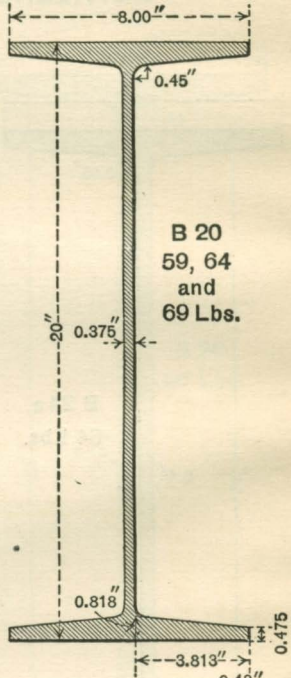
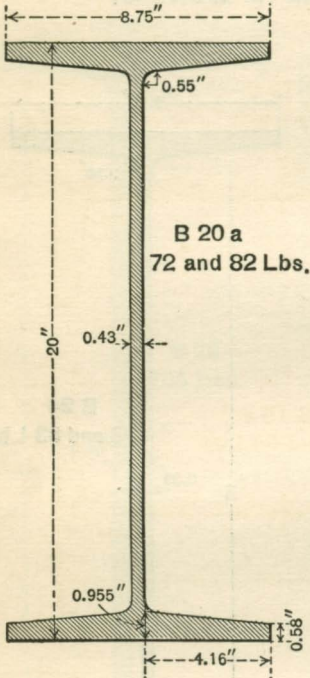

BETHLEHEM I BEAMS.

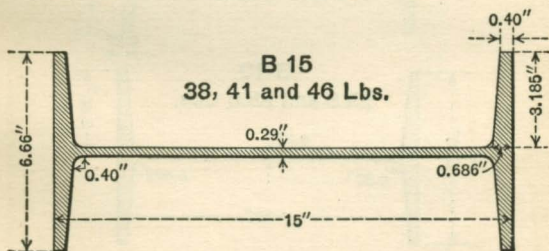
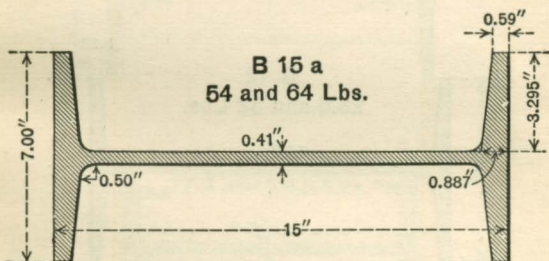
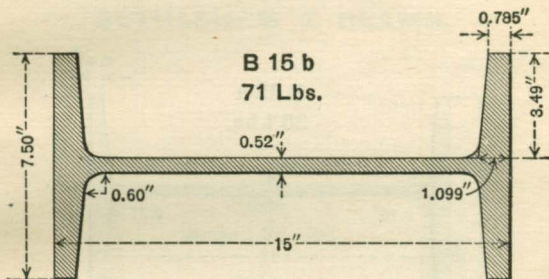

BETHLEHEM I BEAMS.

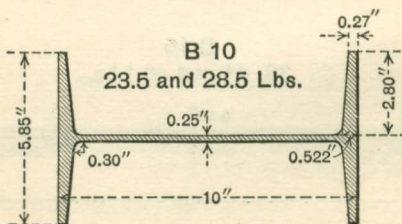
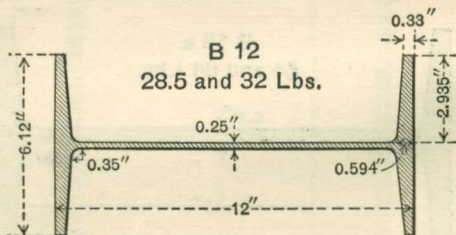
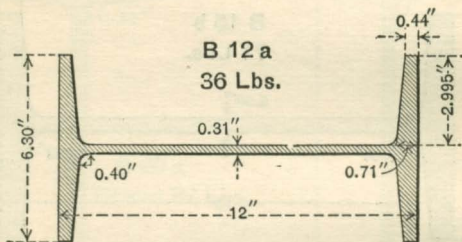

BETHLEHEM I BEAMS.

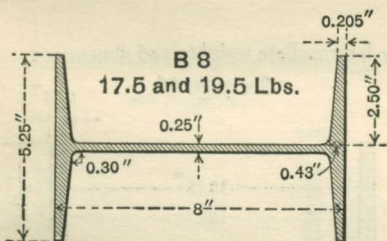
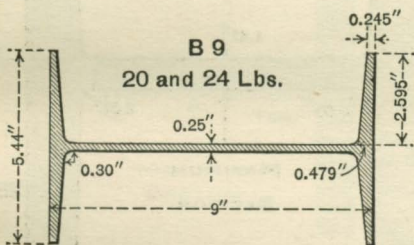

BETHLEHEM ROLLED H COLUMNS.

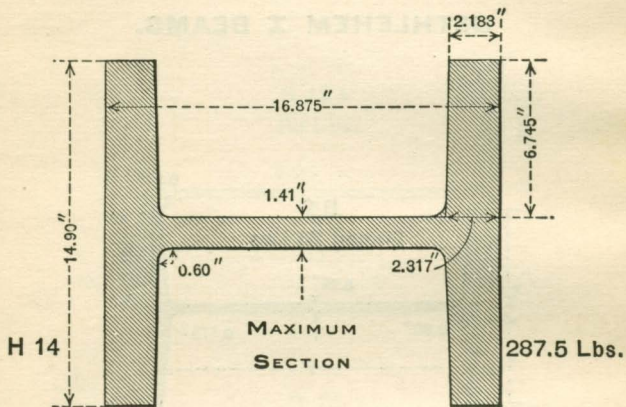

For intermediate weights and dimensions,
See page 44.

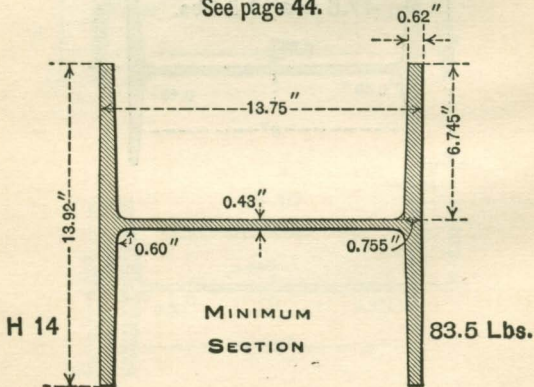

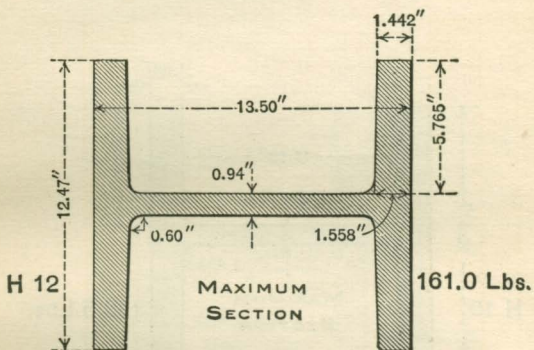
BETHLEHEM ROLLED H COLUMNS.

For intermediate weights and dimensions,
See page 46.

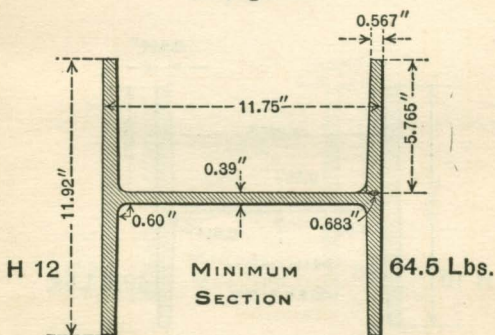

BETHLEHEM ROLLED H COLUMNS.

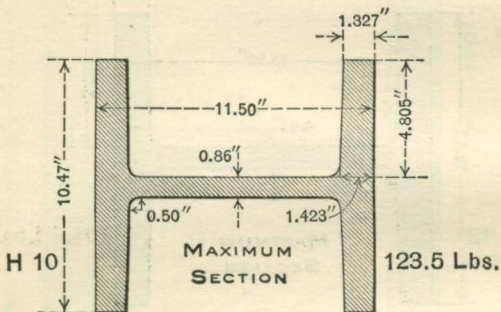

For intermediate weights and dimensions,
See page 48.

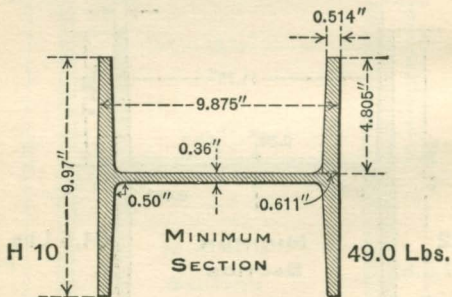

BETHLEHEM ROLLED H COLUMNS.

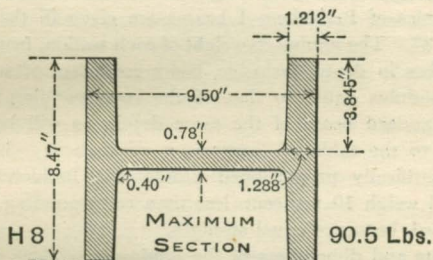

For intermediate weights and dimensions,
See page 50.

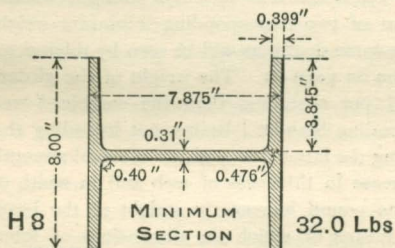

DIMENSIONS AND PROPERTIES OF BETHLEHEM I BEAMS AND GIRDER BEAMS.

Weights and dimensions of all the sizes of Bethlehem I beams usually rolled are given in the table on page 33. Sufficient variations of weights are provided in general for all ordinary purposes of construction. Intermediate or heavier weights may be furnished by special arrangement, but only in variations corresponding to the regular weights of Standard beams.

Properties of Bethlehem I beams are given in the table on pages 36-37. The minimum weight of each section, from 8 inches to 24 inches in depth, inclusive, has a coefficient of strength or section modulus equal to that of the corresponding minimum weight Standard beam of the same depth, as will be seen by reference to the table of comparison on page 41. Because of their scientifically proportioned profile, the Bethlehem beams in general weigh 10 per cent. less than corresponding old style, or Standard, beams of equal strength.

Weights and dimensions of the minimum sections of Bethlehem girder beams are given in the table on page 32. Heavier weights may be furnished by special arrangement, but only in increments corresponding to the regular weights of Standard beams.

Properties of Bethlehem girder beams are given in the table on pages 34-35. From 8 inches to 24 inches in depth, inclusive, these girder beams have a coefficient of strength or section modulus equal to that of two corresponding minimum weight Standard beams of the same depth, as will be seen by reference to the table of comparison on page 40. The weight of the girder beam is in general $12\frac{1}{2}$ per cent. less than the combined weight of the two corresponding Standard beams, not including the separators for assembling the latter into a girder of equal strength.

The increase in thickness of web and in width of flanges is given for one pound increase in weight of the beam or girder section, by means of which the dimensions of intermediate or heavier weights can be determined.

Coefficients of strength are given for maximum fiber stresses of 16,000 lbs. and for 12,500 lbs. per square inch. If the loads are quiescent or nearly so, as in buildings, the coefficients for

16,000 lbs. are generally used; but when moving loads are to be supported, coefficients for smaller fiber stresses should be used.

These coefficients of strength afford a simple means of finding the safe uniformly distributed load for any beam. Divide the coefficient, given for the beam, by the length of the span in feet. The quotient is the safe uniformly distributed load in pounds, including the weight of the beam.

To select a beam to support a given load on a given span, find the coefficient of strength required and refer to the tables for a beam having a coefficient of that value. The coefficient required is found by multiplying the uniformly distributed load in pounds by the span in feet.

If the load is concentrated at the center of the span, the safe load is one-half the safe uniformly distributed load for the same span. To select a beam for supporting a load concentrated at the center of the span, multiply the given load by 2 and consider the result as a uniform load.

If the load is not uniformly distributed or not concentrated at the center of span, the bending moment must be employed. The moment of resistance of the beam, in foot-lbs., must be equal to the bending moment of the loading in foot-lbs. Moments of resistance, in foot-lbs., for Bethlehem beams and girder beams are given on pages 38-39.

In selecting the proper beam required to support a given loading, the section modulus may also be used. The section modulus required is found by dividing the bending moment of the loading, in inch-lbs., by the allowable fiber stress in lbs. per square inch.

The maximum fiber stress, in lbs. per square inch, in a beam supporting a given loading is found by dividing the bending moment produced by the loading, in inch-lbs., by the section modulus of the beam.

In the case of very short spans, or of heavy concentrated loads, the crippling strength of the web may limit the safe allowable load on a beam, or determine the selection of a beam for supporting a given loading. The tables give the maximum safe shear on the webs, calculated by the customary formula for that purpose, as explained on pages 66-67.

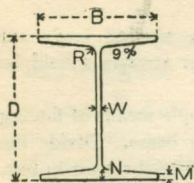

WEIGHTS AND DIMENSIONS OF
BETHLEHEM
GIRDER BEAMS.

DIMENSIONS, IN INCHES.

Section Number.	Weight per Foot, Pounds.	DIMENSIONS, IN INCHES.					
		Depth. D	Flange Width. B	Web Thick-ness. W	Flange Thickness.		Radius of Fillet. R
					At Edge. M	At Root. N	
G30 a	200.0	30	15.00	.750	0.950	1.591	.90
G30	180.0	30	13.00	.690	1.035	1.589	.90
G28 a	180.0	28	14.35	.690	0.920	1.535	.85
G28	165.0	28	12.50	.660	1.000	1.533	.85
G26 a	160.0	26	13.60	.630	0.885	1.469	.80
G26	150.0	26	12.00	.630	0.955	1.469	.80
G24 a	140.0	24	13.00	.600	0.800	1.358	.70
G24	120.0	24	12.00	.530	0.730	1.246	.70
G20 a	140.0	20	12.50	.640	0.930	1.464	.75
G20	112.0	20	12.00	.550	0.695	1.210	.65
G18	92.0	18	11.50	.480	0.590	1.087	.60
G15 b	140.0	15	11.75	.800	1.090	1.583	.95
G15 a	104.0	15	11.25	.600	0.770	1.249	.75
G15	73.0	15	10.50	.430	0.520	0.974	.55
G12 a	70.0	12	10.00	.460	0.575	1.004	.55
G12	55.0	12	9.75	.370	0.415	0.837	.45
G10	44.0	10	9.00	.310	0.370	0.763	.40
G9	38.0	9	8.50	.300	0.335	0.704	.40
G8	32.5	8	8.00	.290	0.295	0.642	.40

WEIGHTS AND DIMENSIONS OF
BETHLEHEM I BEAMS.

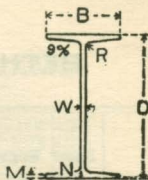

Section Number.	Weight per Foot, Pounds.	DIMENSIONS, IN INCHES.					
		Depth. D	Flange Width. B	Web Thickness. W	Flange Thickness.		Radius of Fillet. R
					At Edge. M	At Root. N	
B30	120.0	30	10.500	.540	.735	1.183	.65
B28	105.0	28	10.000	.500	.675	1.102	.60
B26	90.0	26	9.500	.460	.600	1.007	.55
B24 a	84.0	24	9.250	.460	.585	.980	.55
B24	83.0	24	9.130	.520	.510	.897	.50
	73.0	24	9.000	.390	.510	.897	.50
B20 a	82.0	20	8.890	.570	.580	.955	.55
	72.0	20	8.750	.430	.580	.955	.55
B20	69.0	20	8.145	.520	.475	.818	.45
	64.0	20	8.075	.450	.475	.818	.45
	59.0	20	8.000	.375	.475	.818	.45
B18	59.0	18	7.675	.495	.430	.753	.40
	54.0	18	7.590	.410	.430	.753	.40
	52.0	18	7.555	.375	.430	.753	.40
	48.5	18	7.500	.320	.430	.753	.40
B15 b	71.0	15	7.500	.520	.785	1.099	.60
B15 a	64.0	15	7.195	.605	.590	.887	.50
	54.0	15	7.000	.410	.590	.887	.50
B15	46.0	15	6.810	.440	.400	.686	.40
	41.0	15	6.710	.340	.400	.686	.40
	38.0	15	6.660	.290	.400	.686	.40
B12 a	36.0	12	6.300	.310	.440	.710	.40
	32.0	12	6.205	.335	.330	.594	.35
B12	28.5	12	6.120	.250	.330	.594	.35
	28.5	10	5.990	.390	.270	.522	.30
B10	23.5	10	5.850	.250	.270	.522	.30
	24.0	9	5.555	.365	.245	.479	.30
B9	20.0	9	5.440	.250	.245	.479	.30
	19.5	8	5.325	.325	.205	.430	.30
B8	17.5	8	5.250	.250	.205	.430	.30

PROPERTIES OF
BETHLEHEM GIRDER BEAMS.

Section Number.	Depth of Beam, Inches.	Weight per Foot, Pounds.	Area of Section, Square Inches.	Thick-ness of Web, Inches.	Width of Flange, Inches.	Increase of Web and Flange for each Pound Increase of Weight, Inches.	NEUTRAL AXIS PERPENDICULAR TO WEB AT CENTER.		
							Moment of Inertia, I	Radius of Gyration, r	Section Modulus, S
G30 a	30	200.0	58.71	.750	15.00	.010	9150.6	12.48	610.0
G30	30	180.0	53.00	.690	13.00	.010	8194.5	12.43	546.3
G28 a	28	180.0	52.86	.690	14.35	.011	7264.7	11.72	518.9
G28	28	165.0	48.47	.660	12.50	.011	6562.7	11.64	468.8
G26 a	26	160.0	46.91	.630	13.60	.011	5620.8	10.95	432.4
G26	26	150.0	43.94	.630	12.00	.011	5153.9	10.83	396.5
G24 a	24	140.0	41.16	.600	13.00	.012	4201.4	10.10	350.1
G24	24	120.0	35.38	.530	12.00	.012	3607.3	10.10	300.6
G20 a	20	140.0	41.19	.640	12.50	.015	2934.7	8.44	293.5
G20	20	112.0	32.81	.550	12.00	.015	2342.1	8.45	234.2
G18	18	92.0	27.12	.480	11.50	.016	1591.4	7.66	176.8
G15 b	15	140.0	41.27	.800	11.75	.020	1592.7	6.21	212.4
G15 a	15	104.0	30.50	.600	11.25	.020	1220.1	6.32	162.7
G15	15	73.0	21.49	.430	10.50	.020	883.4	6.41	117.8
G12 a	12	70.0	20.58	.460	10.00	.025	538.8	5.12	89.8
G12	12	55.0	16.18	.370	9.75	.025	432.0	5.17	72.0
G10	10	44.0	12.95	.310	9.00	.030	244.2	4.34	48.8
G9	9	38.0	11.22	.300	8.50	.033	170.9	3.90	38.0
G8	8	32.5	9.54	.290	8.00	.037	114.4	3.46	28.6

W=Safe load in pounds, uniformly distributed, including weight of beam.
L=Span, in feet. M=Moment of forces, in foot pounds.

PROPERTIES OF
BETHLEHEM GIRDER BEAMS.

COEFFICIENT OF STRENGTH				Maximum Safe Shear on Web, in Pounds.	NEUTRAL AXIS COIN- CIDENT WITH CEN- TER LINE OF WEB.		Section Number.
For Fiber Stress of 16,000 Lbs. per Sq. In. for Buildings. C	Add for each Lb. Increase in Weight of Beam.	For Fiber Stress of 12,500 Lbs. per Sq. In. for Moving Loads. C'	Add for each Lb. Increase in Weight of Beam.		Moment of Inertia. I'	Radius of Gyration. r'	
6,507,100	15690	5,083,700	12270	189,300	630.2	3.28	G30 a
5,827,200	15690	4,552,500	12270	165,200	433.3	2.86	G30
5,535,000	14640	4,324,200	11450	161,500	533.3	3.18	G28 a
5,000,100	14640	3,906,400	11450	150,300	371.9	2.77	G28
4,611,900	13600	3,603,100	10630	135,900	435.7	3.05	G26 a
4,228,800	13600	3,303,800	10630	135,900	314.6	2.68	G26
3,734,600	12550	2,917,600	9820	121,700	346.9	2.90	G24 a
3,206,500	12550	2,505,100	9820	98,500	249.4	2.66	G24
3,130,300	10460	2,445,600	8180	124,200	348.9	2.91	G20 a
2,498,300	10460	1,951,800	8180	98,500	239.3	2.70	G20
1,886,100	9410	1,473,500	7360	76,100	182.6	2.59	G18
2,265,200	7840	1,769,700	6140	134,200	331.0	2.83	G15 b
1,735,300	7840	1,355,700	6140	94,300	213.0	2.64	G15 a
1,256,600	7840	981,600	6140	59,200	123.2	2.39	G15
957,800	6280	748,300	4910	57,200	114.7	2.36	G12 a
768,000	6280	600,000	4910	42,300	81.1	2.24	G12
521,000	5230	407,000	4090	29,800	57.3	2.10	G10
405,000	4710	316,400	3680	26,700	44.1	1.98	G9
305,100	4180	238,300	3270	23,600	32.9	1.86	G8

C and C' = Coefficients given in the tables.

$$W = \frac{C \text{ or } C'}{L}; \quad M = \frac{C \text{ or } C'}{8}; \quad C \text{ or } C' = WL - 8M = \frac{3}{8} fS.$$

PROPERTIES OF
BETHLEHEM I BEAMS.

Section Number.	Depth of Beam, Inches.	Weight per Foot, Pounds.	Area of Section, Square Inches.	Thick-ness of Web, Inches.	Width of Flange, Inches.	Increase of Web and Flange for each Lb. Increase of Weight, Inches.	NEUTRAL AXIS PERPENDICULAR TO WEB AT CENTER.		
							Moment of Inertia.	Radius of Gyration.	Section Modulus.
							I	r	S
B30	30	120.0	35.30	.540	10.500	.010	5239.6	12.18	349.3
B28	28	105.0	30.88	.500	10.000	.011	4014.1	11.40	286.7
B26	26	90.0	26.49	.460	9.500	.011	2977.2	10.60	229.0
B24 a	24	84.0	24.80	.460	9.250	.012	2381.9	9.80	198.5
B24	24	83.0	24.59	.520	9.130	.012	2240.9	9.55	186.7
	24	73.0	21.47	.390	9.000	.012	2091.0	9.87	174.3
B20 a	20	82.0	24.17	.570	8.890	.015	1559.8	8.03	156.0
	20	72.0	21.37	.430	8.750	.015	1466.5	8.28	146.7
B20	20	69.0	20.26	.520	8.145	.015	1268.9	7.91	126.9
	20	64.0	18.86	.450	8.075	.015	1222.1	8.05	122.2
	20	59.0	17.36	.375	8.000	.015	1172.2	8.22	117.2
B18	18	59.0	17.40	.495	7.675	.016	883.3	7.12	98.1
	18	54.0	15.87	.410	7.590	.016	842.0	7.28	93.6
	18	52.0	15.24	.375	7.555	.016	825.0	7.36	91.7
	18	48.5	14.25	.320	7.500	.016	798.3	7.48	88.7
B15 b	15	71.0	20.95	.520	7.500	.020	796.2	6.16	106.2
B15 a	15	64.0	18.81	.605	7.195	.020	664.9	5.95	88.6
	15	54.0	15.88	.410	7.000	.020	610.0	6.20	81.3
B15	15	46.0	13.52	.440	6.810	.020	484.8	5.99	64.6
	15	41.0	12.02	.340	6.710	.020	456.7	6.16	60.9
	15	38.0	11.27	.290	6.660	.020	442.6	6.27	59.0
B12 a	12	36.0	10.61	.310	6.300	.025	269.2	5.04	44.9
B12	12	32.0	9.44	.335	6.205	.025	228.5	4.92	38.1
	12	28.5	8.42	.250	6.120	.025	216.2	5.07	36.0
B10	10	28.5	8.34	.390	5.990	.029	134.6	4.02	26.9
	10	23.5	6.94	.250	5.850	.029	122.9	4.21	24.6
B9	9	24.0	7.04	.365	5.555	.033	92.1	3.62	20.5
	9	20.0	6.01	.250	5.440	.033	85.1	3.76	18.9
B8	8	19.5	5.78	.325	5.325	.037	60.6	3.24	15.1
	8	17.5	5.18	.250	5.250	.037	57.4	3.33	14.3

W=Safe load in pounds, uniformly distributed, including weight of beam.

L=Span, in feet. M=Moment of forces, in foot pounds.

PROPERTIES OF
BETHLEHEM I BEAMS.

COEFFICIENTS OF STRENGTH.				Maximum Safe Shear on Web, in Pounds.	NEUTRAL AXIS COINCIDENT WITH CENTER LINE OF WEB.		Section Number.
For Fiber Stress of 16,000 Lbs. per Square Inch for Buildings. C	Add for each Lb. Increase in Weight of Beam.	For Fiber Stress of 12,500 Lbs. per Square Inch for Moving Loads. C'	Add for each Lb. Increase in Weight of Beam.		Moment of Inertia. I'	Radius of Gyration. r'	
3,726,000	15690	2,910,900	12270	103,800	165.0	2.16	B30
3,058,400	14640	2,389,300	11450	89,000	131.5	2.06	B28
2,442,800	13600	1,908,500	10630	75,300	101.2	1.95	B26
2,117,300	12550	1,654,100	9820	75,100	91.1	1.92	B24 a
1,991,900	12550	1,556,200	9820	93,100	78.0	1.78	B24
1,858,700	12550	1,452,100	9820	54,000	74.4	1.86	
1,663,800	10460	1,299,800	8180	102,400	79.9	1.82	B20 a
1,564,300	10460	1,222,100	8180	64,900	75.9	1.88	
1,353,500	10460	1,057,400	8180	88,200	51.2	1.59	
1,303,600	10460	1,018,500	8180	69,400	49.8	1.62	B20
1,250,300	10460	976,800	8180	50,000	48.3	1.66	
1,046,900	9410	817,900	7360	78,000	39.1	1.50	
997,900	9410	779,600	7360	57,500	37.7	1.54	B18
977,700	9410	763,900	7360	49,200	37.1	1.56	
946,100	9410	739,100	7360	36,700	36.2	1.59	
1,132,400	7840	884,700	6140	77,900	61.3	1.71	B15 b
945,600	7840	738,700	6140	93,900	41.9	1.49	B15 a
867,600	7840	677,800	6140	54,800	38.3	1.55	
689,500	7840	538,600	6140	60,000	25.2	1.36	
649,400	7840	507,400	6140	39,900	24.0	1.41	B15
629,500	7840	491,800	6140	30,100	23.4	1.44	
478,600	6280	373,900	4910	32,200	21.3	1.42	B12 a
406,200	6280	317,300	4910	35,800	16.0	1.30	B12
384,400	6280	300,300	4910	22,200	15.3	1.35	
287,100	5230	224,300	4090	39,800	12.1	1.21	B10
262,200	5230	204,800	4090	21,000	11.2	1.27	
218,300	4710	170,600	3680	33,900	8.8	1.12	B9
201,800	4710	157,600	3680	20,100	8.2	1.17	
161,600	4180	126,200	3270	26,900	6.7	1.08	B8
153,000	4180	119,600	3270	18,900	6.4	1.11	

J and C'—Coefficients given in the table.

$$W = \frac{CorC'}{L}; \quad M = \frac{CorC'}{8}; \quad CorC' = WL - 8M - \frac{3}{8} fS.$$

**MOMENTS OF RESISTANCE OF
BETHLEHEM GIRDER BEAMS,
IN FOOT POUNDS.**

NEUTRAL AXIS PERPENDICULAR TO WEB AT CENTER.

Section Number.	Depth of Beam, Inches.	Weight per Foot, Pounds.	MOMENTS OF RESISTANCE, IN FOOT POUNDS.		
			For Fiber Stress of 16,000 Lbs. per Square Inch. R	For Fiber Stress of 12,500 Lbs. per Square Inch. R'	For Fiber Stress of 10,000 Lbs. per Square Inch. R''
G30 a	30	200	813,390	635,460	508,370
G30	30	180	728,400	569,070	455,250
G28 r	28	180	691,880	540,530	432,420
G28	28	165	625,020	488,290	390,640
G26 a	26	160	576,490	450,380	360,310
G26	26	150	528,600	412,970	330,380
G24 a	24	140	466,820	364,710	291,760
G24	24	120	400,820	313,140	250,510
G20 a	20	140	391,280	305,700	244,560
G20	20	112	312,290	243,970	195,180
G18	18	92	235,760	184,190	147,350
G15 b	15	140	283,150	221,210	176,970
G15 a	15	104	216,910	169,460	135,570
G15	15	73	157,080	122,700	98,170
G12 a	12	70	119,730	93,540	74,830
G12	12	55	96,000	75,000	60,000
G10	10	44	65,130	50,880	40,700
G9	9	38	50,630	39,550	31,640
G8	8	32.5	38,140	29,790	23,830

W = Total uniformly distributed load, in pounds, including weight of beam.
P = Load, in pounds, at center of span.
L = Span in feet. M = Bending Moment of forces, in foot pounds.

**MOMENTS OF RESISTANCE OF
BETHLEHEM I BEAMS,
IN FOOT POUNDS.**

NEUTRAL AXIS PERPENDICULAR TO WEB AT CENTER

Section Number.	Depth of Beam, Inches.	Weight per Foot, Pounds.	MOMENTS OF RESISTANCE, IN FOOT POUNDS.		
			For Fiber Stress of 16,000 Lbs. per Square Inch. R	For Fiber Stress of 12,500 Lbs. per Square Inch. R'	For Fiber Stress of 10,000 Lbs. per Square Inch. R''
B30	30	120.0	465,740	363,860	291,090
B28	28	105.0	382,300	298,670	238,930
B26	26	90.0	305,350	238,560	190,850
B24 a	24	84.0	264,660	206,760	165,410
B24	24	83.0	248,980	194,520	155,620
	24	73.0	232,340	181,510	145,210
B20 a	20	82.0	207,980	162,480	129,980
	20	72.0	195,540	152,760	122,210
B20	20	69.0	169,190	132,170	105,740
	20	64.0	162,950	127,310	101,850
	20	59.0	156,290	122,100	97,680
	18	59.0	130,860	102,230	81,790
B18	18	54.0	124,740	97,450	77,960
	18	52.0	122,220	95,480	76,390
	18	48.5	118,260	92,390	73,910
B15 b	15	71.0	141,540	110,580	88,470
B15 a	15	64.0	118,200	92,340	73,870
	15	54.0	108,450	84,730	67,780
B15	15	46.0	86,180	67,330	53,860
	15	41.0	81,180	63,420	50,740
	15	38.0	78,680	61,470	49,180
B12 a	12	36.0	59,830	46,740	37,390
B12	12	32.0	50,770	39,670	31,730
	12	28.5	48,050	37,540	30,030
B10	10	28.5	35,880	28,030	22,430
	10	23.5	32,770	25,600	20,480
B9	9	24.0	27,290	21,320	17,060
	9	20.0	25,220	19,700	15,760
B8	8	19.5	20,200	15,780	12,620
	8	17.5	19,130	14,950	11,960

R, R' and R'' = Moments of Resistance given in the tables.

$$M = R, R' \text{ or } R'' : \quad R, R' \text{ or } R'' = \frac{1}{8} W L : \quad R, R' \text{ or } R'' = \frac{1}{4} P L + \frac{1}{8} W L.$$

**COMPARISON OF
BETHLEHEM GIRDER BEAMS
WITH GIRDERS OF STANDARD BEAMS.**

BETHLEHEM GIRDER BEAMS.				EQUIVALENT GIRDERS OF STANDARD BEAMS.				Economy of Bethlehem Beams, Pounds per Foot.
Section Number.	Depth of Beam, Inches.	Weight per Foot, Pounds.	Section Modulus.	Number of Beams.	Depth of Beams, Inches.	Weight of each Beam, Lbs. per Foot.	Section Modulus of two Beams.	
G30 a	30	200.0	610.0					
G30	30	180.0	546.3					
G28 a	28	180.0	518.9					
G28	28	165.0	468.8					
G26 a	26	160.0	432.4					
G26	26	150.0	396.5	2	24	100	396.8	50
G24 a	24	140.0	350.1	2	24	80	348.0	20
G24	24	120.0	300.6	2	20	85	301.8	50
G20 a	20	140.0	293.5	2	20	80	293.4	20
G20	20	112.0	234.2	2	20	65	234.0	18
G18	18	92.0	176.8	2	18	55	176.8	18
G15 b	15	140.0	212.4	2	15	80	212.2	20
G15 a	15	104.0	162.7	2	15	60	162.4	16
G15	15	73.0	117.8	2	15	42	117.8	11
G12 a	12	70.0	89.8	2	12	40	89.6	10
G12	12	55.0	72.0	2	12	31.5	72.0	8
G10	10	44.0	48.8	2	10	25	48.8	6
G9	9	38.0	38.0	2	9	21	37.8	4
G8	8	32.5	28.6	2	8	18	28.4	3.5

The difference in weights does not include separators for assembling the standard beams into girders. The weights of such separators vary from about 1.5 lbs. per foot for 8" beams to about 5.5 lbs. per foot for 24" beams. The actual economy in weight of the Bethlehem Girder Beams is increased to the same extent.

**COMPARISON OF
BETHLEHEM I BEAMS
WITH STANDARD I BEAMS.**

BETHLEHEM I BEAMS.				EQUIVALENT STANDARD BEAMS.			Economy of Bethlehem Beams, Pounds per Foot.
Section Number.	Depth of Beam, Inches.	Weight per Foot, Pounds.	Section Modulus.	Depth of Beam, Inches.	Weight per Foot, Pounds.	Section Modulus.	
B30	30	120.0	349.3				
B28	28	105.0	286.7				
B26	26	90.0	229.0				
B24 a	24	84.0	198.5	24	100	198.4	16.0
B24	24	83.0	186.7	24	90	186.6	7.0
	24	73.0	174.3	24	80	174.0	7.0
B20 a	20	82.0	156.0	20	90	155.8	8.0
	20	72.0	146.7	20	80	146.7	8.0
B20	20	69.0	126.9	20	75	126.9	6.0
	20	64.0	122.2	20	70	122.0	6.0
	20	59.0	117.2	20	65	117.0	6.0
B18	18	59.0	98.1	18	65	97.9	6.0
	18	54.0	93.6	18	60	93.5	6.0
	18	52.0	91.7				
	18	48.5	88.7	18	55	88.4	6.5
B15 b	15	71.0	106.2	15	80	106.1	9.0
B15 a	15	64.0	88.6	15	70	88.5	6.0
	15	54.0	81.3	15	60	81.2	6.0
B15	15	46.0	64.6	15	50	64.5	4.0
	15	41.0	60.9	15	45	60.8	4.0
	15	38.0	59.0	15	42	58.9	4.0
B12 a	12	36.0	44.9	12	40	44.8	4.0
	12	32.0	38.1	12	35	38.0	3.0
B12	12	28.5	36.0	12	31.5	36.0	3.0
B10	10	28.5	26.9	10	30	26.8	1.5
	10	23.5	24.6	10	25	24.4	1.5
B9	9	24.0	20.5	9	25	20.4	1.0
	9	20.0	18.9	9	21	18.9	1.0
B8	8	19.5	15.1	8	20.5	15.1	1.0
	8	17.5	14.3	8	18	14.2	0.5

SPACING OF
BETHLEHEM I BEAMS
AND
GIRDER BEAMS,

CENTER TO CENTER, TO PRODUCE EQUAL
RADII OF GYRATION ABOUT BOTH AXES
XX AND YY.

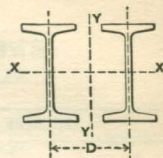

I BEAMS.				GIRDER BEAMS.			
Section Number.	Depth of Beam, Inches.	Weight per Foot of each Beam, Lbs.	Spacing on Centers, in Inches. D	Section Number.	Depth of Beam, Inches.	Weight per Foot of each Beam, Lbs.	Spacing on Centers, in Inches. D
B30	30	120.0	23.98	G30 a	30	200.0	24.09
B28	28	105.0	22.43	G30	30	180.0	24.20
B26	26	90.0	20.84	G28 a	28	180.0	22.57
B24 a	24	84.0	19.22	G28	28	165.0	22.60
	24	83.0	18.76	G26 a	26	160.0	21.03
B24	24	73.0	19.38	G26	26	150.0	20.99
	20	82.0	15.65	G24 a	24	140.0	19.35
B20 a	20	72.0	16.13	G24	24	120.0	19.48
	20	69.0	15.51	G20 a	20	140.0	15.85
B20	20	64.0	15.77	G20	20	112.0	16.01
	20	59.0	16.09	G18	18	92.0	14.41
	18	59.0	13.93	G15 b	15	140.0	*11.06
B18	18	54.0	14.24	G15 a	15	104.0	11.49
	18	52.0	14.38	G15	15	73.0	11.89
	18	48.5	14.62	G12 a	12	70.0	*9.08
B15 b	15	71.0	11.85	G12	12	55.0	*9.31
	15	64.0	11.51	G10	10	44.0	*7.60
B15 a	15	54.0	12.00	G9	9	38.0	*6.72
	15	46.0	11.66	G8	8	32.5	*5.85
B15	15	41.0	12.00				
	15	38.0	12.20				
B12 a	12	36.0	9.67				
	12	32.0	9.49				
B12	12	28.5	9.77				
	10	28.5	7.67				
B10	10	23.5	8.03				
	9	24.0	6.88				
B9	9	20.0	7.16				
	8	19.5	6.11				
B8	8	17.5	6.28				

* Denotes that the value of D given is less than the distance center to center of beams when placed close together with flanges in contact.

DIMENSIONS AND PROPERTIES OF BETHLEHEM ROLLED H COLUMNS.

The tables on pages 44-53, inclusive, give the dimensions, weights, areas, and structural properties of the H column sections for all the variations in size which are rolled.

The dimension, T , given in the tables, is the nominal average thickness of the flange, and is stated in even fractions of an inch for convenience.

The clear distance between the flange fillets is denoted by the dimension, L , given in the tables, and is the depth of the flat surface of the web available for connections.

All columns having the same section number are from the same rolls. Thus, all the sizes of 14-inch H columns tabulated on page 44 are produced by the same rolls, the variation in dimensions of the series of sections being formed by the proportionate separation of the horizontal and vertical rolls.

In selecting columns, it is advisable wherever possible to secure the desired range of size, from minimum to maximum, by confining the selection to columns having the same section number, as all the columns can then be secured from the same rolling.

The moment of inertia, section modulus, and radius of gyration are given around both axes for all columns. The section modulus around the axis XX may be used to determine the transverse strength, in case it is desired to use the column sections as beams. The coefficient of strength for such purpose may be obtained in the following manner:

$$C = \frac{2}{3} fS,$$

where f = allowed fiber stress in lbs. per square inch, and S = the section modulus.

The section modulus is also of use where columns are subject to bending due to eccentric loading. The use of the radius of gyration is explained on page 70, in connection with the tables of strength of columns.

Typical connections and splices for H columns are shown on page 97, from which the simplicity of detail and the small amount of fabrication required for these columns are apparent.

**DIMENSIONS AND PROPERTIES OF
BETHLEHEM ROLLED STEEL
14" H COLUMNS.**

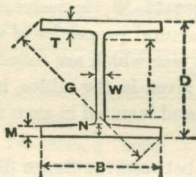

Section Number.	Weight of Section, Lbs. per Foot.	DIMENSIONS, IN INCHES.							
		D	Nominal. T	B	W	M	N	G	L
	83.5	$13\frac{3}{4}$	$\frac{1}{8}$	13.92	.43	.620	.755	$19\frac{5}{8}$	
	91.0	$13\frac{7}{8}$	$\frac{3}{4}$	13.96	.47	.683	.817	$19\frac{3}{4}$	
	99.0	14	$\frac{1}{8}$	14.00	.51	.745	.880	$19\frac{1}{2}$	
	106.5	$14\frac{1}{8}$	$\frac{7}{8}$	14.04	.55	.808	.942	$19\frac{1}{2}$	
	114.5	$14\frac{1}{4}$	$\frac{1}{8}$	14.08	.59	.870	1.005	$20\frac{1}{8}$	
	122.5	$14\frac{3}{8}$	1	14.12	.63	.933	1.067	$20\frac{3}{8}$	
	130.5	$14\frac{1}{2}$	$1\frac{1}{8}$	14.16	.67	.995	1.130	$20\frac{1}{4}$	
	138.0	$14\frac{3}{4}$	$\frac{1}{8}$	14.19	.70	1.058	1.192	$20\frac{3}{8}$	
	146.0	$14\frac{1}{2}$	$1\frac{3}{8}$	14.23	.74	1.120	1.255	$20\frac{1}{2}$	
	154.0	$14\frac{7}{8}$	$1\frac{1}{4}$	14.27	.78	1.183	1.317	$20\frac{5}{8}$	
	162.0	15	$1\frac{5}{8}$	14.31	.82	1.245	1.380	$20\frac{3}{4}$	
H14	170.5	$15\frac{1}{8}$	$1\frac{3}{8}$	14.35	.86	1.308	1.442	$20\frac{7}{8}$	
	178.5	$15\frac{1}{4}$	$1\frac{7}{8}$	14.39	.90	1.370	1.505	21	
	186.5	$15\frac{3}{8}$	$1\frac{1}{2}$	14.43	.94	1.433	1.567	$21\frac{1}{8}$	
	195.0	$15\frac{1}{2}$	$1\frac{9}{8}$	14.47	.98	1.495	1.630	$21\frac{1}{4}$	
	203.5	$15\frac{3}{4}$	$1\frac{5}{8}$	14.51	1.02	1.558	1.692	$21\frac{3}{8}$	
	211.0	$15\frac{1}{2}$	$1\frac{1}{8}$	14.54	1.05	1.620	1.755	$21\frac{7}{8}$	
	219.5	$15\frac{7}{8}$	$1\frac{3}{4}$	14.58	1.09	1.683	1.817	$21\frac{9}{8}$	
	227.5	16	$1\frac{3}{8}$	14.62	1.13	1.745	1.880	$21\frac{1}{8}$	
	236.0	$16\frac{1}{8}$	$1\frac{7}{8}$	14.66	1.17	1.808	1.942	$21\frac{1}{2}$	
	244.5	$16\frac{1}{4}$	$1\frac{5}{8}$	14.70	1.21	1.870	2.005	$21\frac{1}{2}$	
	253.0	$16\frac{3}{8}$	2	14.74	1.25	1.933	2.067	$22\frac{1}{8}$	
	261.5	$16\frac{1}{2}$	$2\frac{1}{8}$	14.78	1.29	1.995	2.130	$22\frac{3}{8}$	
	270.0	$16\frac{3}{4}$	$2\frac{1}{8}$	14.82	1.33	2.058	2.192	$22\frac{5}{8}$	
	278.5	$16\frac{7}{8}$	$2\frac{3}{8}$	14.86	1.37	2.120	2.255	$22\frac{7}{8}$	
	287.5	$16\frac{7}{8}$	$2\frac{1}{4}$	14.90	1.41	2.183	2.317	$22\frac{9}{8}$	

L is constant = 11.06"

**DIMENSIONS AND PROPERTIES OF
BETHLEHEM ROLLED STEEL
14" H COLUMNS.**

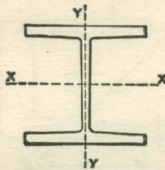

Weight of Section, Lbs. per Foot.	Area of Section, Square Inches.	AXIS XX.			AXIS YY.			Section Number.
		Moment of Inertia.	Section Modulus.	Radius of Gyration, Inches.	Moment of Inertia.	Section Modulus.	Radius of Gyration, Inches.	
		I	S	r	I'	S'	r'	
83.5	24.46	884.9	128.7	6.01	294.5	42.3	3.47	H14
91.0	26.76	976.8	140.8	6.04	325.4	46.6	3.49	
99.0	29.06	1070.6	153.0	6.07	356.9	51.0	3.50	
106.5	31.38	1166.6	165.2	6.10	387.8	55.2	3.52	
114.5	33.70	1264.5	177.5	6.13	420.3	59.7	3.53	
122.5	36.04	1364.6	189.9	6.16	453.4	64.2	3.55	
130.5	38.38	1466.7	202.3	6.18	486.9	68.8	3.56	
138.0	40.59	1568.4	214.5	6.21	519.7	73.3	3.58	
146.0	42.95	1674.7	227.1	6.24	554.4	77.9	3.59	
154.0	45.33	1783.3	239.8	6.27	589.5	82.6	3.61	
162.0	47.71	1894.0	252.5	6.30	626.1	87.5	3.62	
170.5	50.11	2007.0	265.4	6.33	662.3	92.3	3.64	
178.5	52.51	2122.3	278.3	6.36	699.0	97.2	3.65	
186.5	54.92	2239.8	291.4	6.39	736.3	102.1	3.66	
195.0	57.35	2359.7	304.5	6.41	774.2	107.0	3.68	
203.5	59.78	2481.9	317.7	6.44	812.6	112.0	3.69	
211.0	62.07	2603.3	330.6	6.48	849.8	116.9	3.70	
219.5	64.52	2730.2	344.0	6.51	889.3	122.0	3.71	
227.5	66.98	2859.6	357.5	6.53	929.4	127.1	3.72	
236.0	69.45	2991.5	371.0	6.56	970.0	132.3	3.74	
244.5	71.94	3125.8	384.7	6.59	1011.3	137.6	3.75	
253.0	74.43	3262.7	398.5	6.62	1053.2	142.9	3.76	
261.5	76.93	3402.1	412.4	6.65	1095.6	148.3	3.77	
270.0	79.44	3544.1	426.4	6.68	1138.7	153.7	3.79	
278.5	81.97	3688.8	440.5	6.71	1182.4	159.1	3.80	
287.5	84.50	3836.1	454.7	6.74	1226.7	164.7	3.81	

DIMENSIONS AND PROPERTIES OF
BETHLEHEM ROLLED STEEL
12'' H COLUMNS.

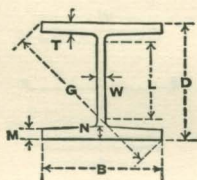

Section Number.	Weight of Section, Lbs. per Foot.	DIMENSIONS, IN INCHES.						
		D	Nominal. T	B	W	M	N	G
H12	64.5	11 $\frac{3}{4}$	$\frac{5}{8}$	11.92	.39	.567	.683	16 $\frac{3}{4}$
	71.5	11 $\frac{7}{8}$	$\frac{1}{8}$	11.96	.43	.630	.745	16 $\frac{7}{8}$
	78.0	12	$\frac{3}{4}$	12.00	.47	.692	.808	17
	84.5	12 $\frac{1}{8}$	$\frac{1}{8}$	12.04	.51	.755	.870	17 $\frac{1}{8}$
	91.5	12 $\frac{1}{4}$	$\frac{7}{8}$	12.08	.55	.817	.933	17 $\frac{1}{4}$
	98.5	12 $\frac{3}{8}$	$\frac{1}{8}$	12.12	.59	.880	.995	17 $\frac{3}{8}$
	105.0	12 $\frac{1}{2}$	1	12.16	.63	.942	1.058	17 $\frac{7}{8}$
	112.0	12 $\frac{5}{8}$	$\frac{1}{8}$	12.20	.67	1.005	1.120	17 $\frac{9}{8}$
	118.5	12 $\frac{3}{4}$	$\frac{1}{8}$	12.23	.70	1.067	1.183	17 $\frac{11}{8}$
	125.5	12 $\frac{7}{8}$	$\frac{3}{8}$	12.27	.74	1.130	1.245	17 $\frac{5}{8}$
	132.5	13	$\frac{1}{4}$	12.31	.78	1.192	1.308	17 $\frac{5}{8}$
	139.5	13 $\frac{1}{8}$	$\frac{5}{8}$	12.35	.82	1.255	1.370	18
	146.5	13 $\frac{1}{4}$	$\frac{3}{8}$	12.39	.86	1.317	1.433	18 $\frac{1}{8}$
	153.5	13 $\frac{3}{8}$	$\frac{7}{8}$	12.43	.90	1.380	1.495	18 $\frac{1}{4}$
161.0	13 $\frac{1}{2}$	$\frac{1}{2}$	12.47	.94	1.442	1.558	18 $\frac{3}{8}$	

L is constant = 9.21''

**DIMENSIONS AND PROPERTIES OF
BETHLEHEM ROLLED STEEL
12" H COLUMNS.**

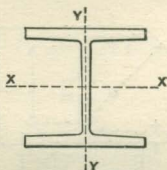

Weight of Section, Lbs. per Foot.	Area of Section, Square Inches.	AXIS XX.			AXIS YY.			Section Number.
		Moment of Inertia, I	Section Modulus, S	Radius of Gyration, Inches, r	Moment of Inertia, I'	Section Modulus, S'	Radius of Gyration, Inches, r'	
64.5	19.00	499.0	84.9	5.13	168.6	28.3	2.98	H12
71.5	20.96	556.6	93.7	5.15	188.2	31.5	3.00	
78.0	22.94	615.6	102.6	5.18	208.1	34.7	3.01	
84.5	24.92	676.1	111.5	5.21	228.5	37.9	3.03	
91.5	26.92	738.1	120.5	5.24	249.2	41.3	3.04	
98.5	28.92	801.7	129.6	5.27	270.1	44.6	3.06	
105.0	30.94	866.8	138.6	5.30	291.7	48.0	3.07	
112.0	32.96	933.4	147.9	5.33	313.6	51.4	3.08	
118.5	34.87	1000.0	156.9	5.36	335.0	54.8	3.10	
125.5	36.91	1069.8	166.2	5.38	357.7	58.3	3.11	
132.5	38.97	1141.3	175.6	5.41	380.7	61.9	3.13	
139.5	41.03	1214.5	185.0	5.44	404.1	65.4	3.14	
146.5	43.10	1289.4	194.6	5.47	428.0	69.1	3.15	
153.5	45.19	1366.0	204.3	5.50	452.2	72.8	3.16	
161.0	47.28	1444.3	214.0	5.53	477.0	76.5	3.18	

DIMENSIONS AND PROPERTIES OF
BETHLEHEM ROLLED STEEL
10" H COLUMNS.

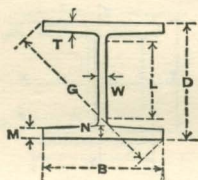

Section Number.	Weight of Section, Lbs. per Foot.	DIMENSIONS, IN INCHES.							
		D	Nominal. T	B	W	M	N	G	L
H10	49.0	9 $\frac{7}{8}$	1 $\frac{9}{16}$	9.97	.36	.514	.611	14 $\frac{1}{16}$	L is constant = 7.67'
	54.0	10	$\frac{5}{8}$	10.00	.39	.577	.673	14 $\frac{3}{16}$	
	59.5	10 $\frac{1}{8}$	1 $\frac{1}{16}$	10.04	.43	.639	.736	14 $\frac{5}{16}$	
	65.5	10 $\frac{1}{4}$	$\frac{3}{4}$	10.08	.47	.702	.798	14 $\frac{3}{8}$	
	71.0	10 $\frac{3}{8}$	1 $\frac{3}{16}$	10.12	.51	.764	.861	14 $\frac{1}{2}$	
	77.0	10 $\frac{1}{2}$	$\frac{7}{8}$	10.16	.55	.827	.923	14 $\frac{5}{8}$	
	82.5	10 $\frac{5}{8}$	1 $\frac{5}{16}$	10.20	.59	.889	.986	14 $\frac{3}{4}$	
	88.5	10 $\frac{3}{4}$	1	10.24	.63	.952	1.048	14 $\frac{7}{8}$	
	94.0	10 $\frac{7}{8}$	1 $\frac{1}{16}$	10.28	.67	1.014	1.111	15	
	99.5	11	1 $\frac{1}{8}$	10.31	.70	1.077	1.173	15 $\frac{1}{8}$	
	105.5	11 $\frac{1}{8}$	1 $\frac{3}{16}$	10.35	.74	1.139	1.236	15 $\frac{3}{16}$	
	111.5	11 $\frac{1}{4}$	1 $\frac{1}{4}$	10.39	.78	1.202	1.298	15 $\frac{5}{16}$	
	117.5	11 $\frac{3}{8}$	1 $\frac{5}{16}$	10.43	.82	1.264	1.361	15 $\frac{7}{16}$	
	123.5	11 $\frac{1}{2}$	1 $\frac{3}{8}$	10.47	.86	1.327	1.423	15 $\frac{9}{16}$	

DIMENSIONS AND PROPERTIES OF
BETHLEHEM ROLLED STEEL
10'' H COLUMNS.

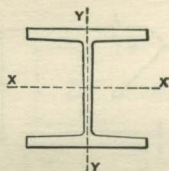

Weight of Section, Lbs. per Foot.	Area of Section, Square Inches.	AXIS XX.			AXIS YY.			Section Number.
		Moment of Inertia.	Section Modulus.	Radius of Gyration, Inches.	Moment of Inertia.	Section Modulus.	Radius of Gyration, Inches.	
		I	S	r	I'	S'	r'	
49.0	14.37	263.5	53.4	4.28	89.1	17.9	2.49	H10
54.0	15.91	296.8	59.4	4.32	100.4	20.1	2.51	
59.5	17.57	331.9	65.6	4.35	112.2	22.3	2.53	
65.5	19.23	368.0	71.8	4.37	124.2	24.6	2.54	
71.0	20.91	405.2	78.1	4.40	136.5	27.0	2.56	
77.0	22.59	443.6	84.5	4.43	149.1	29.4	2.57	
82.5	24.29	483.0	90.9	4.46	162.0	31.8	2.58	
88.5	25.99	523.5	97.4	4.49	175.1	34.2	2.60	
94.0	27.71	565.2	103.9	4.52	188.6	36.7	2.61	
99.5	29.32	607.0	110.4	4.55	201.7	39.1	2.62	
105.5	31.06	651.0	117.0	4.58	215.6	41.7	2.64	
111.5	32.80	696.2	123.8	4.61	229.9	44.3	2.65	
117.5	34.55	742.7	130.6	4.64	244.4	46.9	2.66	
123.5	36.32	790.4	137.5	4.67	259.3	49.5	2.67	

DIMENSIONS AND PROPERTIES OF
BETHLEHEM ROLLED STEEL
8" H COLUMNS.

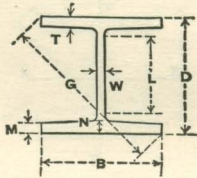

Section Number.	Weight of Section, Lbs. per Foot.	DIMENSIONS, IN INCHES.							
		D	T	B	W	M	N	G	L
H 8	32.0	$7\frac{7}{8}$	$\frac{7}{16}$	8.00	.31	.399	.476	$11\frac{1}{4}$	L is constant = 6.14"
	34.5	8	$\frac{1}{2}$	8.00	.31	.462	.538	$11\frac{3}{8}$	
	39.0	$8\frac{1}{8}$	$\frac{9}{16}$	8.04	.35	.524	.601	$11\frac{7}{16}$	
	43.5	$8\frac{1}{4}$	$\frac{5}{8}$	8.08	.39	.587	.663	$11\frac{9}{16}$	
	48.0	$8\frac{3}{8}$	$1\frac{1}{8}$	8.12	.43	.649	.726	$11\frac{11}{16}$	
	53.0	$8\frac{1}{2}$	$\frac{3}{4}$	8.16	.47	.712	.788	$11\frac{13}{16}$	
	57.5	$8\frac{5}{8}$	$1\frac{3}{8}$	8.20	.51	.774	.851	12	
	62.0	$8\frac{3}{4}$	$\frac{7}{8}$	8.24	.55	.837	.913	$12\frac{1}{16}$	
	67.0	$8\frac{7}{8}$	$1\frac{5}{16}$	8.28	.59	.899	.976	$12\frac{1}{8}$	
	71.5	9	1	8.32	.63	.962	1.038	$12\frac{1}{4}$	
	76.5	$9\frac{1}{8}$	$1\frac{1}{16}$	8.36	.67	1.024	1.101	$12\frac{3}{8}$	
	81.0	$9\frac{1}{4}$	$1\frac{1}{8}$	8.39	.70	1.087	1.163	$12\frac{1}{2}$	
	85.5	$9\frac{3}{8}$	$1\frac{3}{16}$	8.43	.74	1.149	1.226	$12\frac{5}{8}$	
90.5	$9\frac{1}{2}$	$1\frac{1}{4}$	8.47	.78	1.212	1.288	$12\frac{3}{4}$		

DIMENSIONS AND PROPERTIES OF
BETHLEHEM ROLLED STEEL
8" H COLUMNS.

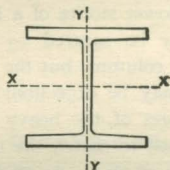

Weight of Section, Lbs. per Foot.	Area of Section, Square Inches.	AXIS XX.			AXIS YY.			Section Number.
		Moment of Inertia.	Section Modulus.	Radius of Gyration, Inches.	Moment of Inertia.	Section Modulus.	Radius of Gyration, Inches.	
		I	S	r	I'	S'	r'	
32.0	9.17	105.7	26.9	3.40	35.8	8.9	1.98	H 8
34.5	10.17	121.5	30.4	3.46	41.1	10.3	2.01	
39.0	11.50	139.5	34.3	3.48	47.2	11.7	2.03	
43.5	12.83	158.3	38.4	3.51	53.4	13.2	2.04	
48.0	14.18	177.7	42.4	3.54	59.8	14.7	2.05	
53.0	15.53	197.8	46.5	3.57	66.3	16.3	2.07	
57.5	16.90	218.6	50.7	3.60	73.1	17.8	2.08	
62.0	18.27	240.2	54.9	3.63	80.0	19.4	2.09	
67.0	19.66	262.5	59.2	3.65	87.1	21.0	2.11	
71.5	21.05	285.6	63.5	3.68	94.4	22.7	2.12	
76.5	22.46	309.5	67.8	3.71	101.9	24.4	2.13	
81.0	23.78	333.5	72.1	3.75	109.2	26.0	2.14	
85.5	25.20	359.0	76.6	3.77	117.2	27.8	2.16	
90.5	26.64	385.3	81.1	3.80	125.1	29.6	2.17	

BETHLEHEM 14" SPECIAL SECTION ROLLED STEEL H COLUMN.

When columns are required of greater sectional area than the regular sections of H columns, it is necessary to build a compound section to obtain the desired area. This may be the case in the columns for the lower stories of a high building.

Additional area may be secured by riveting plates to the flanges of the regular H columns, but the drilling of the holes for attaching such plates may be objectionable, on account of the thick metal in the flanges of the heavy H columns. The 14" special section is designed to match the regular 14" H columns, and permits the addition of plates, or other shapes, for increasing the area to the desired extent, avoiding the drilling of thick metal in the flanges.

Dimensions and properties of this special section are given on the opposite page. The section is produced by the same rolls and has the same inner contour as the series of 14" H columns on page 44. If the largest regular 14" H column does not provide the required area, the special section can be used and increased in area to the desired amount, in the manner indicated by Figs. 1-3 on the opposite page. This may be necessary for the heavy columns required in the lower stories of a high building. The regular series of 14" H columns can then be used in the upper stories, where they provide sufficient area. The regular 14" H columns can be spliced to the special section in the usual way.

Properties of Compound Columns, similar to Fig. 1, are given on pages 54-55, and safe loads in the tables on pages 86-87.

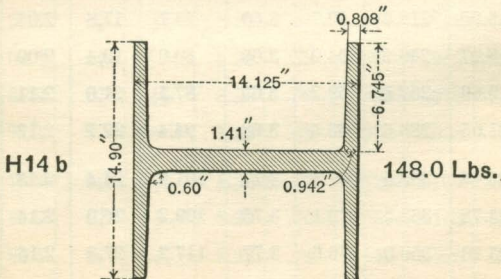

**DIMENSIONS AND PROPERTIES OF
BETHLEHEM 14" SPECIAL SECTION
ROLLED STEEL H COLUMN.**

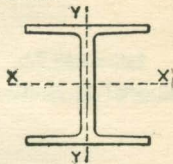
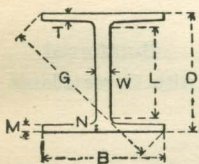

DIMENSIONS.

Section Number.	Weight of Section, Lbs. per Foot.	DIMENSIONS, IN INCHES.							
		D	Nominal. T	B	W	M	N	G	L
H14b	148.0	14 1/8	7/8	14.90	1.41	.808	.942	20 7/8	11.06

PROPERTIES.

Section Number.	Weight of Section, Lbs. per Foot.	Area of Section, Square Inches.	AXIS XX.			AXIS YY.		
			Moment of Inertia.	Section Modulus.	Radius of Gyration, Inches.	Moment of Inertia.	Section Modulus.	Radius of Gyration, Inches.
			I	S	r	I'	S'	r'
H14b	148.0	43.52	1368.5	193.8	5.61	468.6	62.9	3.28

SUGGESTIONS FOR USING THE SPECIAL SECTION OF H COLUMN IN BUILDING UP COLUMNS OF LARGE SECTIONAL AREA.

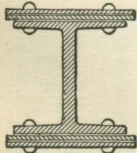

Fig. 1



Fig. 2

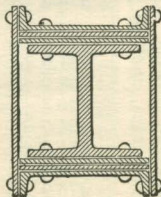
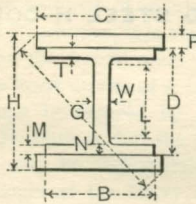

Fig. 3

**DIMENSIONS AND PROPERTIES OF
COMPOUND COLUMNS.**

14" x 148 Lb.
Special H Section.



Reinforced
with Cover Plates.

Section.	Weight of Section, Lbs. per Foot.	DIMENSIONS, IN INCHES.				
		Cover Plates.		Depth of Column. H	Diagonal Diameter. G	Dimensions of 14" Special H Section.
		Width. C	Thickness. P			
Columns composed of a 14" x 148 Lb. Special Column Section, (Section H 14b), reinforced with cover plates of width and thickness given in table. The total thickness, P, may be made of two or more plates, each of punchable thickness.	284.0	16	1 $\frac{1}{4}$	16 $\frac{5}{8}$	23 $\frac{1}{8}$	D 14 $\frac{1}{8}$
	290.8	16	1 $\frac{5}{16}$	16 $\frac{3}{4}$	23 $\frac{3}{8}$	
	297.6	16	1 $\frac{3}{8}$	16 $\frac{7}{8}$	23 $\frac{1}{4}$	
	304.4	16	1 $\frac{7}{8}$	17	23 $\frac{3}{8}$	
	311.2	16	1 $\frac{1}{2}$	17 $\frac{1}{8}$	23 $\frac{7}{8}$	
	318.0	16	1 $\frac{9}{16}$	17 $\frac{1}{4}$	23 $\frac{1}{2}$	
	324.8	16	1 $\frac{3}{8}$	17 $\frac{3}{8}$	23 $\frac{5}{8}$	
	331.6	16	1 $\frac{1}{8}$	17 $\frac{1}{2}$	23 $\frac{1}{8}$	
	338.4	16	1 $\frac{3}{4}$	17 $\frac{5}{8}$	23 $\frac{1}{8}$	B 14.90
	345.2	16	1 $\frac{3}{16}$	17 $\frac{3}{4}$	23 $\frac{7}{8}$	
	350.3	17	1 $\frac{3}{4}$	17 $\frac{5}{8}$	24 $\frac{1}{8}$	W 14.1
	357.5	17	1 $\frac{1}{8}$	17 $\frac{3}{4}$	24 $\frac{9}{16}$	
	364.7	17	1 $\frac{1}{8}$	17 $\frac{7}{8}$	24 $\frac{11}{16}$	M 0.808
	372.0	17	1 $\frac{1}{2}$	18	24 $\frac{3}{4}$	
	379.2	17	2	18 $\frac{1}{8}$	24 $\frac{1}{2}$	N 0.942
	386.4	17	2 $\frac{1}{16}$	18 $\frac{1}{4}$	24 $\frac{5}{8}$	
	393.6	17	2 $\frac{1}{8}$	18 $\frac{3}{8}$	25 $\frac{1}{8}$	L 11.06
	400.9	17	2 $\frac{3}{16}$	18 $\frac{1}{2}$	25 $\frac{1}{8}$	
	408.1	17	2 $\frac{1}{4}$	18 $\frac{5}{8}$	25 $\frac{3}{8}$	
	415.3	17	2 $\frac{5}{16}$	18 $\frac{3}{4}$	25 $\frac{5}{8}$	
	423.4	18	2 $\frac{1}{4}$	18 $\frac{5}{8}$	25 $\frac{7}{8}$	
	431.0	18	2 $\frac{5}{16}$	18 $\frac{3}{4}$	26	
	438.7	18	2 $\frac{3}{8}$	18 $\frac{7}{8}$	26 $\frac{1}{8}$	
	446.3	18	2 $\frac{7}{8}$	19	26 $\frac{3}{8}$	
	454.0	18	2 $\frac{1}{2}$	19 $\frac{1}{8}$	26 $\frac{1}{2}$	
	461.6	18	2 $\frac{9}{16}$	19 $\frac{1}{4}$	26 $\frac{3}{8}$	
	469.3	18	2 $\frac{5}{8}$	19 $\frac{3}{8}$	26 $\frac{7}{8}$	
	476.9	18	2 $\frac{1}{8}$	19 $\frac{1}{2}$	26 $\frac{9}{16}$	
484.6	18	2 $\frac{1}{4}$	19 $\frac{5}{8}$	26 $\frac{3}{4}$		

DIMENSIONS AND PROPERTIES OF
COMPOUND COLUMNS.

14" x 148 Lb.
Special H Section.

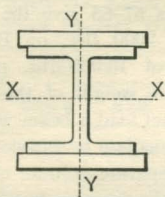

Reinforced
with Cover Plates.

Weight of Section, Lbs. per Foot.	Area of Section, Square Inches.	AXIS XX.			AXIS YY.			Cover Plates.	
		Moment of Inertia.	Section Modulus.	Radius of Gyration, Inches.	Moment of Inertia.	Section Modulus.	Radius of Gyration, Inches.	Width, Inches.	Thick-ness, Inches.
								I	S
284.0	83.52	3737.7	449.6	6.69	1321.9	165.2	3.98	16	1 1/4
290.8	85.52	3876.9	462.9	6.73	1364.6	170.6	3.99	16	1 5/16
297.6	87.52	4018.2	476.2	6.78	1407.3	175.9	4.01	16	1 3/8
304.4	89.52	4161.7	489.6	6.82	1449.9	181.2	4.02	16	1 7/16
311.2	91.52	4307.2	503.0	6.86	1492.6	186.6	4.04	16	1 1/2
318.0	93.52	4454.9	516.5	6.90	1535.3	191.9	4.05	16	1 9/16
324.8	95.52	4604.8	530.0	6.94	1577.9	197.2	4.06	16	1 5/8
331.6	97.52	4756.8	543.6	6.98	1620.6	202.6	4.0	16	1 11/16
338.4	99.52	4911.0	557.3	7.02	1663.3	207.9	4.09	16	1 3/4
345.2	101.52	5067.5	571.0	7.07	1705.9	213.2	4.10	16	1 13/16
350.3	103.02	5132.5	582.4	7.06	1901.6	223.7	4.30	17	1 3/4
357.5	105.15	5298.7	597.0	7.10	1952.8	229.7	4.31	17	1 11/16
364.7	107.27	5467.2	611.7	7.14	2003.9	235.8	4.32	17	1 1/8
372.0	109.40	5638.1	626.5	7.18	2055.1	241.8	4.33	17	1 5/16
379.2	111.52	5811.5	641.3	7.22	2106.3	247.8	4.35	17	2
386.4	113.65	5987.2	656.1	7.26	2157.5	253.8	4.36	17	2 1/16
393.6	115.77	6165.4	671.1	7.30	2208.7	259.8	4.37	17	2 1/8
400.9	117.90	6345.9	686.0	7.34	2259.8	265.9	4.38	17	2 3/16
408.1	120.02	6529.0	701.1	7.38	2311.0	271.9	4.39	17	2 1/4
415.3	122.15	6714.5	716.2	7.41	2362.2	277.9	4.40	17	2 5/16
423.4	124.52	6832.6	733.7	7.41	2655.6	295.1	4.62	18	2 1/4
431.0	126.77	7029.0	749.8	7.45	2716.4	301.8	4.63	18	2 5/16
438.7	129.02	7228.1	765.9	7.48	2777.1	308.6	4.64	18	2 3/8
446.3	131.27	7429.8	782.1	7.52	2837.9	315.3	4.65	18	2 7/16
454.0	133.52	7634.2	798.3	7.56	2898.6	322.1	4.66	18	2 1/2
461.6	135.77	7841.3	814.7	7.60	2959.4	328.8	4.67	18	2 9/16
469.3	138.02	8051.1	831.1	7.64	3020.1	335.6	4.68	18	2 5/8
476.9	140.27	8263.6	847.6	7.68	3080.9	342.3	4.69	18	2 11/16
484.6	142.52	8478.9	864.1	7.71	3141.6	349.1	4.70	18	2 3/4

SAFE UNIFORMLY DISTRIBUTED LOADS FOR BETHLEHEM I BEAMS AND GIRDER BEAMS.

The tables on pages 57-65 give the safe uniformly distributed loads, in tons of 2000 lbs., on Bethlehem beams for a maximum fiber stress of 16,000 lbs. per square inch. The tabular loads include the weight of the beam, which must be deducted to obtain the net load a beam will support.

Safe loads for intermediate or heavier weights of beams can be obtained from the separate column of corrections, given for each size, which states the increase in safe load for each pound increase in weight per foot of beam.

If the load is concentrated at the center of the span, the safe load is one-half the safe uniformly distributed load for the same span.

The safe loads on short spans may be limited by the shearing strength of the web, instead of by the maximum fiber stress allowed in the flanges. This limit is indicated in the tables by heavy cross lines. The loads given above these lines are greater than the safe crippling strength of the web, and must not be used unless the webs are stiffened. In such cases it will generally be advisable to select a heavier beam with a thicker web. Maximum safe shears for all beam and girder sections are given on page 67.

It is assumed in the tables that the compression flanges of the beams are properly secured against yielding sideways. They should be held in position at distances not exceeding 20 times the width of the flange, otherwise the allowable safe loads must be reduced as per the following table:

BEAMS UNSUPPORTED SIDEWAYS.

Unsupported Length of Beam.	Greatest Safe Load.	Unsupported Length of Beam.	Greatest Safe Load.
20 flange widths.	Full tabular load.	50 flange widths.	$\frac{7}{10}$ tabular load.
30 flange widths.	$\frac{9}{10}$ tabular load.	60 flange widths.	$\frac{6}{10}$ tabular load.
40 flange widths.	$\frac{8}{10}$ tabular load.	70 flange widths.	$\frac{5}{10}$ tabular load.

Bethlehem beams, on account of their much wider flanges, will safely support greater loads than Standard beams on long spans, where the beams are without lateral support.

SAFE LOADS UNIFORMLY DISTRIBUTED FOR
BETHLEHEM GIRDER BEAMS,
 IN TONS OF 2000 LBS.

BEAMS BEING SECURED AGAINST YIELDING SIDWAYS.

Span, in Feet.	30" G		Add for each Lb. Inc. in Wgt.	28" G		Add for each Lb. Inc. in Wgt.	26" G		Add for each Lb. Inc. in Wgt.
	G30 a	G30		G28 a	G28		G26 a	G26	
	200 Lbs.	180 Lbs.		180 Lbs.	165 Lbs.		160 Lbs.	150 Lbs.	
18	180.75	161.87	.44	153.75	138.89	.41	128.11	117.47	.38
19	171.24	153.35	.41	145.66	131.58	.39	121.37	111.29	.36
20	162.68	145.68	.39	138.38	125.00	.37	115.30	105.72	.34
21	154.93	138.74	.37	131.79	119.05	.35	109.81	100.69	.32
22	147.89	132.44	.36	125.80	113.64	.33	104.82	96.11	.31
23	141.46	126.68	.34	120.33	108.70	.32	100.26	91.93	.30
24	135.56	121.40	.33	115.31	104.17	.31	96.08	88.10	.28
25	130.14	116.55	.31	110.70	100.00	.29	92.24	84.58	.27
26	125.14	112.06	.30	106.44	96.16	.28	88.69	81.32	.26
27	120.50	107.91	.29	102.50	92.60	.27	85.41	78.31	.25
28	116.20	104.06	.28	98.84	89.29	.26	82.36	75.52	.24
29	112.19	100.47	.27	95.43	86.21	.25	79.52	72.91	.23
30	108.45	97.12	.26	92.25	83.34	.24	76.87	70.48	.23
31	104.95	93.99	.25	89.27	80.65	.24	74.39	68.21	.22
32	101.67	91.05	.25	86.48	78.13	.23	72.06	66.08	.21
33	98.59	88.29	.24	83.86	75.76	.22	69.88	64.07	.21
34	95.69	85.70	.23	81.40	73.53	.22	67.82	62.19	.20
35	92.96	83.25	.22	79.07	71.43	.21	65.88	60.41	.19
36	90.38	80.93	.22	76.88	69.45	.20	64.05	58.73	.19
37	87.93	78.75	.21	74.80	67.57	.20	62.32	57.15	.18
38	85.62	76.67	.21	72.83	65.79	.19	60.68	55.64	.18
39	83.42	74.71	.20	70.96	64.10	.19	59.13	54.22	.17
40	81.34	72.84	.20	69.19	62.50	.18	57.65	52.86	.17
41	79.35	71.06	.19	67.50	60.98	.18	56.24	51.57	.17
42	77.47	69.37	.19	65.89	59.53	.17	54.90	50.34	.16
43	75.66	67.76	.18	64.36	58.14	.17	53.63	49.17	.16
44	73.94	66.22	.18	62.90	56.82	.17	52.41	48.06	.15
45	72.30	64.75	.17	61.50	55.56	.16	51.24	46.99	.15
46	70.73	63.34	.17	60.16	54.35	.16	50.13	45.97	.15
47	69.22	61.99	.17	58.88	53.19	.16	49.06	44.99	.14
48	67.78	60.70	.16	57.66	52.09	.15	48.04	44.05	.14

Safe loads given include weight of beam.

Maximum fiber stress, 16,000 lbs. per square inch.

SAFE LOADS UNIFORMLY DISTRIBUTED FOR
BETHLEHEM GIRDER BEAMS,
 IN TONS OF 2000 LBS.

BEAMS BEING SECURED AGAINST YIELDING SIDEWAYS.

Span, in Feet.	24" G		Add for each Lb. Increase in Weight.	20" G		Add for each Lb. Increase in Weight.	18" G	Add for each Lb. Increase in Weight.
	G24 a	G24		G20 a	G20		G18	
	140 Lbs.	120 Lbs.		140 Lbs.	112 Lbs.		92 Lbs.	
12	155.61	133.60	.52	130.43	104.09	.44	78.59	.39
13	143.64	123.33	.48	120.40	96.09	.40	72.54	.36
14	133.38	114.52	.45	111.80	89.23	.37	67.36	.34
15	124.48	106.88	.42	104.34	83.28	.35	62.87	.31
16	116.71	100.20	.39	97.82	78.07	.33	58.94	.29
17	109.84	94.31	.37	92.07	73.48	.31	55.47	.28
18	103.74	89.07	.35	86.95	69.40	.29	52.39	.26
19	98.28	84.38	.33	82.38	65.74	.28	49.63	.25
20	93.37	80.16	.31	78.26	62.46	.26	47.15	.24
21	88.92	76.35	.30	74.53	59.48	.25	44.91	.22
22	84.88	72.88	.29	71.14	56.78	.24	42.87	.21
23	81.19	69.71	.27	68.05	54.31	.23	41.00	.20
24	77.80	66.80	.26	65.22	52.05	.22	39.29	.20
25	74.69	64.15	.25	62.61	49.97	.21	37.72	.19
26	71.82	61.66	.24	60.20	48.04	.20	36.27	.18
27	69.16	59.38	.23	57.97	46.26	.19	34.93	.17
28	66.69	57.26	.22	55.90	44.61	.19	33.68	.17
29	64.39	55.29	.22	53.97	43.07	.18	32.52	.16
30	62.24	53.44	.21	52.17	41.64	.17	31.43	.16
31	60.24	51.72	.20	50.49	40.30	.17	30.42	.15
32	58.35	50.10	.20	48.91	39.04	.16	29.47	.15
33	56.58	48.58	.19	47.43	37.85	.16	28.58	.14
34	54.92	47.15	.18	46.04	36.74	.15	27.74	.14
35	53.35	45.81	.18	44.72	35.69	.15	26.94	.13
36	51.87	44.54	.17	43.48	34.70	.15	26.20	.13
37	50.47	43.33	.17	42.30	33.76	.14	25.49	.13
38	49.14	42.19	.17	41.19	32.87	.14	24.82	.12
39	47.88	41.11	.16	40.13	32.03	.13	24.18	.12
40	46.68	40.08	.16	39.13	31.23	.13	23.58	.12

Safe loads given include weight of beam. Maximum fiber stress, 16,000 lbs. per square inch.

Loads given above the heavy lines are greater than safe loads for web crippling.

Safe loads given below the dotted line produce deflections exceeding $\frac{1}{360}$ of the span.

SAFE LOADS UNIFORMLY DISTRIBUTED FOR
BETHLEHEM GIRDER BEAMS,
 IN TONS OF 2000 LBS.

BEAMS BEING SECURED AGAINST YIELDING SIDEWAYS.

Span, in Feet.	15" G			Add for each Lb. Inc. in Wgt.	12" G		Add for each Lb. Inc. in Wgt.
	G15 b	G15 a	G15		G12 a	G12	
	140 Lbs.	104 Lbs.	73 Lbs.		70 Lbs.	55 Lbs.	
10	113.26	86.76	62.83	.39	47.89	38.40	.31
11	102.96	78.88	57.12	.36	43.54	34.91	.29
12	94.38	72.30	52.36	.33	39.91	32.00	.26
13	87.12	66.74	48.33	.30	36.84	29.54	.24
14	80.90	61.97	44.88	.28	34.21	27.43	.22
15	75.51	57.84	41.89	.26	31.93	25.60	.21
16	70.79	54.23	39.27	.25	29.93	24.00	.20
17	66.62	51.04	36.96	.23	28.17	22.59	.19
18	62.92	48.20	34.91	.22	26.61	21.33	.18
19	59.61	45.67	33.07	.21	25.21	20.21	.17
20	56.63	43.38	31.42	.20	23.95	19.20	.16
21	53.93	41.32	29.92	.19	22.81	18.28	.15
22	51.48	39.44	28.56	.18	21.77	17.45	.14
23	49.24	37.72	27.32	.17	20.82	16.69	.14
24	47.19	36.15	26.18	.16	19.95	16.00	.13
25	45.30	34.71	25.13	.16	19.16	15.36	.13
26	43.56	33.37	24.17	.15	18.42	14.77	.12
27	41.95	32.13	23.27	.15	17.74	14.22	.12
28	40.45	30.99	22.44	.14	17.10	13.71	.11
29	39.05	29.92	21.67	.14	16.51	13.24	.11
30	37.75	28.92	20.94	.13	15.96	12.80	.10
31	36.54	27.99	20.27	.13	15.45	12.39	.10
32	35.39	27.11	19.63	.12	14.97	12.00	.10
33	34.32	26.29	19.04	.12	14.51	11.64	.10
34	33.31	25.52	18.48	.12	14.09	11.29	.09
35	32.36	24.79	17.95	.11	13.68	10.97	.09

Safe loads given include weight of beam. Maximum fiber stress, 16,000 lbs. per square inch.

Load given above the heavy line is greater than a safe load for web crippling.

Safe loads given below the dotted lines produce deflections exceeding $\frac{1}{32}$ of the span.

**SAFE LOADS UNIFORMLY DISTRIBUTED FOR
BETHLEHEM GIRDER BEAMS,
IN TONS OF 2000 LBS.**

BEAMS BEING SECURED AGAINST YIELDING SIDWAYS.

Span, in Feet.	10" G	Add for each Lb. Increase in Weight.	Span, in Feet.	9" G	Add for each Lb. Increase in Weight.	8" G	Add for each Lb. Increase in Weight.
	G10			G9		G8	
	44 Lbs.			38 Lbs.		32.5 Lbs.	
10	26.65	.26	5	40.50	.47	30.51	.42
11	23.68	.24	6	33.75	.39	25.42	.35
12	21.71	.22	7	28.93	.34	21.79	.30
13	20.04	.20	8	25.31	.29	19.07	.26
14	18.61	.19	9	22.50	.26	16.95	.23
15	17.37	.17	10	20.25	.23	15.25	.21
16	16.28	.16	11	18.41	.21	13.87	.19
17	15.32	.15	12	16.88	.20	12.71	.17
18	14.47	.15	13	15.58	.18	11.73	.16
19	13.71	.14	14	14.47	.17	10.90	.15
20	13.03	.13	15	13.50	.16	10.17	.14
21	12.40	.12	16	12.66	.15	9.53	.13
22	11.84	.12	17	11.91	.14	8.97	.12
23	11.33	.11	18	11.25	.13	8.47	.12
24	10.85	.11	19	10.66	.12	8.03	.11
25	10.42	.10	20	10.13	.12	7.63	.10
26	10.02	.10	21	9.64	.11	7.26	.10
27	9.65	.10	22	9.21	.11	6.93	.09
28	9.30	.09	23	8.80	.10	6.63	.09
29	8.98	.09	24	8.44	.10	6.36	.08
30	8.68	.09	25	8.10	.09	6.10	.08
31	8.40	.08	26	7.79	.09		
32	8.14	.08	27	7.50	.09		
33	7.89	.08	28	7.23	.08		
34	7.66	.08	29	6.98	.08		
35	7.44	.07	30	6.75	.07		

Safe loads given include weight of beam. Maximum fiber stress, 16,000 lbs. per square inch.

Loads given above the heavy lines are greater than safe loads for web crippling.

Safe loads given below the dotted lines produce deflections exceeding $\frac{1}{360}$ of the span.

SAFE LOADS UNIFORMLY DISTRIBUTED FOR
BETHLEHEM I BEAMS,
 IN TONS OF 2000 LBS.

BEAMS BEING SECURED AGAINST YIELDING SIDWAYS.

Span, in Feet.	30" I		28" I		26" I	
	B30	Add for each Lb. Increase in Weight.	B28	Add for each Lb. Increase in Weight.	B26	Add for each Lb. Increase in Weight.
	120 Lbs.		105 Lbs.		90 Lbs.	
18	103.50	.44	84.95	.41	67.86	.38
19	98.05	.41	80.48	.39	64.29	.36
20	93.15	.39	76.46	.37	61.07	.34
21	88.71	.37	72.82	.35	58.16	.32
22	84.68	.36	69.51	.33	55.52	.31
23	81.00	.34	66.49	.32	53.11	.30
24	77.62	.33	63.72	.31	50.89	.28
25	74.52	.31	61.17	.29	48.86	.27
26	71.65	.30	58.81	.28	46.98	.26
27	69.00	.29	56.64	.27	45.24	.25
28	66.54	.28	54.61	.26	43.62	.24
29	64.24	.27	52.73	.25	42.12	.23
30	62.10	.26	50.97	.24	40.71	.23
31	60.10	.25	49.33	.24	39.40	.22
32	58.22	.25	47.79	.23	38.17	.21
33	56.45	.24	46.34	.22	37.01	.21
34	54.79	.23	44.98	.22	35.92	.20
35	53.23	.22	43.69	.21	34.90	.19
36	51.75	.22	42.48	.20	33.93	.19
37	50.35	.21	41.33	.20	33.01	.18
38	49.03	.21	40.24	.19	32.14	.18
39	47.77	.20	39.21	.19	31.32	.17
40	46.57	.20	38.23	.19	30.54	.17
41	45.44	.19	37.30	.18	29.79	.17
42	44.36	.19	36.41	.18	29.08	.16
43	43.33	.18	35.56	.17	28.41	.16
44	42.34	.18	34.75	.17	27.76	.15
45	41.40	.17	33.98	.16	27.14	.15
46	40.50	.17	33.24	.16	26.55	.15
47	39.64	.17	32.54	.16	25.99	.14
48	38.81	.16	31.86	.15	25.45	.14

Safe loads given include weight of beam. Maximum fiber stress, 16,000 lbs. per square inch.

SAFE LOADS UNIFORMLY DISTRIBUTED FOR

BETHLEHEM I BEAMS,

IN TONS OF 2000 LBS.

BEAMS BEING SECURED AGAINST YIELDING SIDEWAYS.

Span, in Feet.	24" I		Add for each Lb. Increase in Weight.	20" I					Add for each Lb. Increase in Weight.
	B24 a	B24		B20 a		B20			
	84 Lbs.	73 Lbs.		82 Lbs.	72 Lbs.	69 Lbs.	64 Lbs.	59 Lbs.	
12	88.22	77.45	.52	69.33	65.18	56.40	54.32	52.10	.44
13	81.43	71.49	.48	63.99	60.17	52.06	50.14	48.09	.40
14	75.62	66.38	.45	59.42	55.87	48.34	46.56	44.65	.37
15	70.58	61.96	.42	55.46	52.14	45.12	43.45	41.68	.35
16	66.16	58.08	.39	51.99	48.88	42.30	40.74	39.07	.33
17	62.27	54.67	.37	48.94	46.01	39.81	38.34	36.77	.31
18	58.81	51.63	.35	46.22	43.45	37.60	36.21	34.73	.29
19	55.72	48.91	.33	43.78	41.17	35.62	34.31	32.90	.28
20	52.93	46.47	.31	41.60	39.11	33.84	32.59	31.26	.26
21	50.41	44.26	.30	39.61	37.25	32.23	31.04	29.77	.25
22	48.12	42.24	.29	37.81	35.55	30.76	29.63	28.42	.24
23	46.03	40.41	.27	36.17	34.01	29.42	28.34	27.18	.23
24	44.11	38.72	.26	34.66	32.59	28.20	27.16	26.05	.22
25	42.35	37.17	.25	33.28	31.29	27.07	26.07	25.01	.21
26	40.72	35.74	.24	32.00	30.08	26.03	25.07	24.04	.20
27	39.21	34.42	.23	30.81	28.97	25.07	24.14	23.15	.19
28	37.81	33.19	.22	29.71	27.93	24.17	23.28	22.33	.19
29	36.50	32.05	.22	28.69	26.97	23.34	22.48	21.56	.18
30	35.29	30.98	.21	27.73	26.07	22.56	21.73	20.84	.17
31	34.15	29.98	.20	26.84	25.23	21.83	21.03	20.17	.17
32	33.08	29.04	.20	26.00	24.44	21.15	20.37	19.54	.16
33	32.08	28.16	.19	25.21	23.70	20.51	19.75	18.94	.16
34	31.14	27.33	.19	24.47	23.00	19.90	19.17	18.39	.15
35	30.25	26.55	.18	23.77	22.35	19.34	18.62	17.86	.15
36	29.41	25.82	.17	23.11	21.73	18.80	18.11	17.37	.15
37	28.61	25.12	.17	22.48	21.14	18.29	17.62	16.90	.14
38	27.86	24.46	.17	21.89	20.58	17.81	17.15	16.45	.14
39	27.14	23.83	.16	21.33	20.06	17.35	16.71	16.03	.13
40	26.47	23.23	.16	20.80	19.55	16.92	16.30	15.63	.13

Safe loads given include weight of beam. Maximum fiber stress, 16,000 lbs. per square inch.

Loads given above the heavy lines are greater than safe loads for web crippling.

SAFE LOADS UNIFORMLY DISTRIBUTED FOR
BETHLEHEM I BEAMS,
 IN TONS OF 2000 LBS.

BEAMS BEING SECURED AGAINST YIELDING SIDEWAYS.

Span, in Feet.	18" I			Add for each Lb. Increase in Weight.	15" I					Add for each Lb. Increase in Weight.
	B18				B15 b	B15 a	B15			
	59 Lbs.	54 Lbs.	48.5 Lbs.		71 Lbs.	54 Lbs.	46 Lbs.	41 Lbs.	38 Lbs.	
12	43.62	41.58	39.42	.39	47.18	36.15	28.73	27.06	26.23	.33
13	40.26	38.38	36.39	.36	43.55	33.37	26.52	24.98	24.21	.30
14	37.39	35.64	33.79	.34	40.44	30.99	24.62	23.19	22.48	.28
15	34.90	33.26	31.54	.31	37.75	28.92	22.98	21.65	20.98	.25
16	32.71	31.18	29.56	.29	35.39	27.11	21.55	20.30	19.67	.26
17	30.79	29.35	27.83	.28	33.30	25.52	20.28	19.10	18.51	.23
18	29.08	27.72	26.28	.26	31.45	24.10	19.15	18.04	17.49	.22
19	27.55	26.26	24.90	.25	29.80	22.83	18.14	17.09	16.56	.21
20	26.17	24.95	23.65	.24	28.31	21.69	17.24	16.24	15.74	.20
21	24.93	23.76	22.53	.22	26.96	20.66	16.42	15.46	14.99	.19
22	23.79	22.68	21.50	.21	25.74	19.72	15.67	14.76	14.31	.18
23	22.76	21.70	20.57	.21	24.62	18.86	14.99	14.12	13.68	.17
24	21.81	20.79	19.71	.20	23.59	18.07	14.36	13.53	13.11	.16
25	20.94	19.96	18.92	.19	22.65	17.35	13.79	12.99	12.59	.16
26	20.13	19.19	18.19	.18	21.78	16.68	13.26	12.49	12.11	.15
27	19.39	18.48	17.52	.17	20.97	16.07	12.77	12.03	11.66	.15
28	18.69	17.82	16.89	.17	20.22	15.49	12.31	11.60	11.24	.14
29	18.05	17.21	16.31	.16	19.52	14.96	11.89	11.20	10.85	.14
30	17.45	16.63	15.77	.16	18.87	14.46	11.49	10.82	10.49	.13
31	16.88	16.10	15.26	.15	18.26	13.99	11.12	10.47	10.15	.13
32	16.36	15.59	14.78	.15	17.69	13.56	10.77	10.15	9.84	.12
33	15.86	15.12	14.33	.14	17.16	13.15	10.45	9.84	9.54	.12
34	15.40	14.68	13.91	.14	16.65	12.76	10.14	9.55	9.26	.12
35	14.96	14.26	13.52	.13	16.18	12.39	9.85	9.28	8.99	.11
36	14.54	13.86	13.14	.13	15.73	12.05	9.58	9.02	8.74	.11
37	14.15	13.49	12.78	.13	15.30	11.72	9.32	8.78	8.51	.11
38	13.77	13.13	12.45	.12	14.90	11.42	9.07	8.55	8.28	.10
39	13.42	12.79	12.13	.12	14.52	11.12	8.84	8.33	8.07	.10
40	13.09	12.47	11.83	.12	14.15	10.84	8.62	8.12	7.87	.10

Safe loads given include weight of beam. Maximum fiber stress, 16,000 lbs. per square inch.

Load given above the heavy line exceeds safe load for web crippling.

Safe loads given below the dotted lines produce deflections exceeding $\frac{1}{80}$ of the span.

SAFE LOADS UNIFORMLY DISTRIBUTED FOR
BETHLEHEM I BEAMS,
 IN TONS OF 2000 LBS.

BEAMS BEING SECURED AGAINST YIELDING SIDEWAYS.

Span, in Feet.	12" I			Add for each Lb. Increase in Weight.	10" I		Add for each Lb. Increase in Weight.
	B12 a	B12			B10		
	36 Lbs.	32 Lbs.	28.5 Lbs.		28.5 Lbs.	23.5 Lbs.	
9	26.59	22.57	21.36	.35	15.95	14.57	.29
10	23.93	20.31	19.22	.31	14.35	13.11	.26
11	21.76	18.46	17.47	.29	13.05	11.92	.24
12	19.94	16.92	16.02	.26	11.96	10.92	.22
13	18.41	15.62	14.79	.24	11.04	10.08	.20
14	17.09	14.51	13.73	.22	10.25	9.36	.19
15	15.95	13.54	12.81	.21	9.57	8.74	.17
16	14.96	12.69	12.01	.20	8.97	8.19	.16
17	14.08	11.95	11.31	.19	8.44	7.71	.15
18	13.30	11.28	10.68	.17	7.97	7.28	.15
19	12.60	10.69	10.12	.17	7.55	6.90	.14
20	11.97	10.15	9.61	.16	7.18	6.55	.13
21	11.40	9.67	9.15	.15	6.84	6.24	.12
22	10.88	9.23	8.74	.14	6.52	5.96	.12
23	10.41	8.83	8.36	.14	6.24	5.70	.11
24	9.97	8.46	8.01	.13	5.98	5.46	.11
25	9.57	8.12	7.69	.13	5.74	5.24	.10
26	9.20	7.81	7.39	.12	5.52	5.04	.10
27	8.86	7.52	7.12	.12	5.32	4.86	.10
28	8.55	7.25	6.86	.11	5.13	4.68	.09
29	8.25	7.00	6.63	.11	4.95	4.52	.09
30	7.98	6.77	6.41	.11	4.78	4.37	.09
31	7.72	6.55	6.20	.10			
32	7.48	6.35	6.01	.10			
33	7.25	6.15	5.82	.10			
34	7.04	5.97	5.65	.09			
35	6.84	5.80	5.49	.09			

Safe loads given include weight of beam. Maximum fiber stress, 16,000 lbs. per square inch.

Safe loads given below the dotted lines produce deflections exceeding $\frac{1}{800}$ of the span.

SAFE LOADS UNIFORMLY DISTRIBUTED FOR
BETHLEHEM I BEAMS,
 IN TONS OF 2000 LBS.

BEAMS BEING SECURED AGAINST YIELDING SIDEWAYS.

Span, in Feet.	9" I		Add for each Lb. Increase in Weight.	8" I		Add for each Lb. Increase in Weight.
	B9			B8		
	24 Lbs.	20 Lbs.		19.5 Lbs.	17.5 Lbs.	
5	21.83	20.18	.47	16.16	15.30	.42
6	18.19	16.81	.39	13.46	12.75	.35
7	15.60	14.41	.34	11.54	10.93	.30
8	13.65	12.61	.29	10.10	9.57	.26
9	12.13	11.21	.26	8.98	8.50	.23
10	10.92	10.09	.24	8.08	7.65	.21
11	9.92	9.17	.21	7.34	6.96	.19
12	9.10	8.41	.20	6.73	6.38	.17
13	8.40	7.76	.18	6.21	5.89	.16
14	7.80	7.21	.17	5.77	5.47	.15
15	7.28	6.73	.16	5.39	5.10	.14
16	6.82	6.31	.15	5.05	4.78	.13
17	6.42	5.93	.14	4.75	4.50	.12
18	6.07	5.61	.13	4.49	4.25	.12
19	5.75	5.31	.13	4.25	4.03	.11
20	5.46	5.04	.12	4.04	3.83	.11
21	5.20	4.80	.11	3.85	3.64	.10
22	4.96	4.59	.11	3.67	3.48	.10
23	4.75	4.39	.10	3.51	3.33	.09
24	4.55	4.20	.10	3.37	3.19	.09
25	4.37	4.04	.10	3.23	3.06	.08
26	4.20	3.88	.09			
27	4.04	3.74	.09			
28	3.90	3.60	.09			
29	3.76	3.48	.08			
30	3.64	3.36	.08			

Safe loads given include weight of beam. Maximum fiber stress, 16,000 lbs. per square inch.

Safe loads given below the dotted lines produce deflections exceeding $\frac{1}{300}$ of the span.

MAXIMUM SAFE SHEAR ON THE WEBS OF BEAMS AND GIRDERS.

On relatively short spans the safe strength of the web of the beam against crippling, caused by the shearing stress, may determine the maximum safe load which the beam should support.

The shearing stresses in the web of a beam may be resolved into two component stresses of equal intensity, at right angles to each other, and at angles of 45 degrees with the neutral axis. Both of these stresses are of the same intensity and equal to that of the vertical shear. These component stresses are equivalent to compressive and tensile forces acting upon the web of the beam. The compressive forces tend to buckle the web, but it is not entirely free to buckle because the tensile forces acting at right angles have the effect of stiffening it.

The formula in general use for determining the maximum safe shear on the webs of beams and girders is as follows,

$$\text{Maximum safe shear, in pounds} = \frac{12,000 \, dt}{1 + \frac{h^2}{3000t^2}}$$

where d = depth of beam, t = thickness of web, and h = clear distance between flanges, all dimensions in inches.

The safe shears on the webs of Bethlehem beams and girders, derived from this formula, are given in the table on the opposite page, and also the corresponding minimum spans for the greatest safe uniformly distributed loads.

The safe uniformly distributed load for any span less than the minimum span given must not exceed twice the safe shear. The safe load concentrated at the center of a span must not be greater than twice the safe shear given, and the corresponding minimum span will be one-half the minimum span given in the table. Loading of any kind must not produce a shear exceeding the safe shear given unless the webs are stiffened.

In general, the shearing strength of the webs will be found ample for all ordinary cases of loading.

MAXIMUM SAFE SHEAR FOR
BETHLEHEM I BEAMS AND GIRDER
BEAMS,

BASED UPON THE CRIPPLING STRENGTH OF THE WEBS.
 ALSO THE CORRESPONDING MINIMUM SPANS
 FOR GREATEST SAFE UNIFORMLY DISTRIBUTED LOADS.

I BEAMS.					GIRDER BEAMS.				
Section Number.	Depth of Beam, Inches.	Weight per Foot, Pounds.	Maximum Safe Shear, Pounds.	Minimum Span, Feet.	Section Number.	Depth of Beam, Inches.	Weight per Foot, Pounds.	Maximum Safe Shear, Pounds.	Minimum Span, Feet.
B30	30	120.0	103,800	17.9	G30 a	30	200.0	189,300	17.2
B28	28	105.0	89,000	17.2	G30	30	180.0	165,200	17.6
B26	26	90.0	75,300	16.2	G28 a	28	180.0	161,500	17.3
B24 a	24	84.0	75,100	14.1	G28	28	165.0	150,300	16.6
B24	24	83.0	93,100	10.7	G26 a	26	160.0	135,900	17.0
	24	73.0	54,000	17.2	G26	26	150.0	135,900	15.6
B20 a	20	82.0	102,400	8.1	G24 a	24	140.0	121,700	15.3
	20	72.0	64,900	12.1	G24	24	120.0	98,500	16.3
B20	20	69.0	88,200	7.7	G20 a	20	140.0	124,200	12.6
	20	64.0	69,400	9.4	G20	20	112.0	98,500	12.7
	20	59.0	50,000	12.5	G18	18	92.0	76,100	12.4
B18	18	59.0	78,000	6.7	G15 b	15	140.0	134,200	8.4
	18	54.0	57,500	8.7	G15 a	15	104.0	94,300	9.2
	18	52.0	49,200	9.9	G15	15	73.0	59,200	10.6
B15 b	18	48.5	36,700	12.9	G12 a	12	70.0	57,200	8.4
	15	71.0	77,900	7.3	G12	12	55.0	42,300	9.1
B15 a	15	64.0	93,900	5.0	G10	10	44.0	29,800	8.7
	15	54.0	54,800	7.9	G9	9	38.0	26,700	7.6
B15	15	46.0	60,000	5.7	G8	8	32.5	23,600	6.5
	15	41.0	39,900	8.1					
B12 a	15	38.0	30,100	10.5					
	12	36.0	32,200	7.4					
B12	12	32.0	35,800	5.7					
	12	28.5	22,200	8.7					
B10	10	28.5	39,800	3.6					
	10	23.5	21,000	6.2					
B9	9	24.0	33,900	3.2					
	9	20.0	20,100	5.0					
B8	8	19.5	26,900	3.0					
	8	17.5	18,900	4.1					

$$\text{Maximum Safe Shear} = \frac{12,000 dt}{1 + \frac{h^2}{3000 t^2}}$$

Where,
 d = depth of beam,
 t = thickness of web,
 h = clear distance between flanges.
 All dimensions in inches.

BETHLEHEM

I BEAMS AND GIRDER BEAMS FOR RAILROAD BRIDGES.

The table on the opposite page shows the application of Bethlehem rolled beam and girder sections for use as track stringers in railroad bridges and for short span railroad bridges. The table is calculated according to Theodore Cooper's Specifications for Railroad Bridges for a loading of E 40, equivalent to a capacity for 142-ton locomotives. All figures are given for one rail or one-half track.

The size and weight of the Bethlehem rolled sections which are required for the purpose are given for the various spans. As a comparison, the size and weight of the corresponding present standard I beams that could be employed for the same purpose are also given, so far as standard beams could be used. The economical weight of the Bethlehem beams is apparent from this comparison. Riveted girders would be required on spans greater than 17 feet in length, unless the more economical rolled Bethlehem beams are used.

Bethlehem rolled beams, for all spans under 25 feet in length, will weigh less than the most economical riveted girder it is possible to design, even when the depth of the latter is unlimited. For spans over 25 feet in length, the rolled beams will weigh less than riveted girders of equal depth.

In every case the Bethlehem rolled section is economical, weight or cost considered, as compared with a standard I beam or with a riveted girder.

The Bethlehem beams also can be used to advantage for the cross girders or floor beams of bridges. Where available depth is limited, the rolled girder sections having twice the section modulus of standard beams of equal depth will be found desirable for stringers or cross girders, and prove economical in weight and cost as compared with built-up riveted girders which otherwise would be required. These rolled girder sections will also be found specially adapted for solid bridge floors of shallow depth.

**BETHLEHEM I BEAMS AND
GIRDER BEAMS
USED FOR
RAILROAD TRACK STRINGERS
AND SHORT SPAN RAILROAD BRIDGES.
DESIGNED ACCORDING TO COOPER'S SPECIFICATIONS
FOR LOADING E40.**

Span, in Feet.	Bending Moment, in Foot-Lbs. for ½ Track.	Section Modulus Required.	BETHLEHEM ROLLED SECTIONS REQUIRED.			MOST ECONOMICAL STANDARD I BEAM THAT COULD BE USED.	
			Section Number	Depth, Inches.	Weight per Foot, Lbs.	Weight per Foot, Lbs.	Size.
10	65,800	79	B15 a	15	54.0	60	15" I
11	76,700	92	B18	18	52.0	60	18" I
12	89,000	107	B20	20	59.0	65	20" I
13	102,000	122	B20	20	64.0	70	20" I
14	116,800	140	B20 a	20	72.0	80	20" I
15	133,000	160	B24	24	73.0	80	24" I
16	149,000	179	B24	24	83.0	85	24" I
17	166,000	199	B24 a	24	84.0	100	24" I
18	182,000	218	B26	26	90.0		
19	200,600	241	B28	28	105.0		
20	223,000	268	B28	28	105.0		
21	243,000	292	B30	30	120.0		
22	266,000	320	B30	30	120.0		
23	287,000	344	B30	30	120.0		
24	310,000	372	G26	26	150.0		
25	331,000	397	G26	26	150.0		
26	354,000	425	G26 a	26	160.0		
27	377,000	452	G28	28	165.0		
28	401,000	481	G30	30	180.0		
29	427,000	512	G30	30	180.0		
30	453,000	544	G30	30	180.0		
31	478,000	575	G30 a	30	200.0		
32	504,000	605	G30 a	30	200.0		

Bethlehem rolled sections, for spans under 25 feet, weigh less than the most economical riveted girder possible to design with unlimited depth.
Bethlehem rolled sections, for spans over 25 feet, weigh less than riveted girders of nearly equal depth.

EXPLANATION OF TABLES OF SAFE LOADS FOR BETHLEHEM ROLLED STEEL H COLUMNS.

The superiority of steel columns over columns of any other material is so well understood and recognized as to need no comment. Cast iron columns are sometimes used solely on the score of cheapness because of the relatively greater cost of riveted steel columns—the only kind of steel columns heretofore obtainable; but in buildings of anything more than the most moderate height, or wherever stiffness of frame and absolute security is essential, steel columns are exclusively employed.

Bethlehem rolled steel H sections reduce the cost of steel columns to such an extent that they can be used for all purposes with economy. These rolled steel columns provide all the desired qualities of safety and reliability at a cost less than that of any other form of steel column, and at a cost as low or even less than cast iron.

For very short lengths the compressive strength of structural steel of standard quality is the same as its tensile strength. As the length increases the compressive strength diminishes. A short column has a practically uniform compressive strength for all lengths less than about fifteen times its least diameter; but for greater lengths the strength decreases, the decrease being a function of the length of the column and the radius of gyration of the section in the direction of its least resistance to bending. Conforming to these conditions, the safe allowable stress, in lbs. per square inch, on square ended columns of medium steel used for buildings is given by the following formula:

13,000 lbs. for lengths under 55 radii of gyration.

16,000— $55 \frac{l}{r}$ for lengths over 55 radii of gyration.

in which l = unsupported length of column and r = least radius of gyration, both in inches.

The safe strength of steel columns given by this formula agrees in a satisfactory manner with the available experimental data on the subject. In addition it is of correct theoretical form. It represents a straight line which becomes tangent to the curve of Euler's formula for very long columns and fixes a maximum limit of stress for columns of relatively short length. The safe stress allowed on steel columns by this rule corresponds to the safe stress usually allowed for beams and girders in buildings. Columns pro-

portioned in accordance with this formula have the same proper degree of safety as the beams and girders which they support, thus maintaining a symmetrical proportion of all parts of the structure.

A comparison of this formula with the column formulas specified by the building laws of the principal cities in the United States is shown by the diagram herewith, from which it will be seen that it represents about an average of general practice.

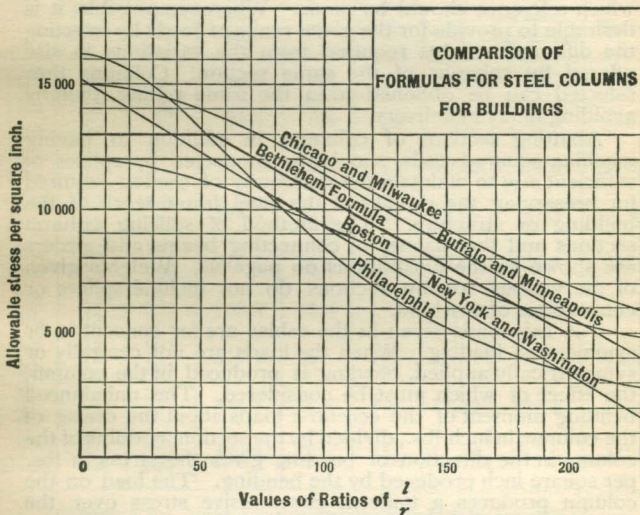

A riveted column, having the metal in its shaft injured and weakened by the punching of numerous rivet holes, is liable to fail under a less load than a rolled column in which the shaft is devoid of rivets. The formula does not take into consideration this advantage in favor of the rolled steel column sections. It represents only the best current practice in general steel column design, and is not limited to columns of special or superior shape.

Safe loads computed by this formula are given in the tables on pages 78-85 for all the sizes of Bethlehem rolled H columns and on pages 74-77 for Bethlehem I beams and girder beams when used as columns. The

column required for any given load and length is readily selected from these tables.

The unsupported length of a column should not exceed 150 radii of gyration, which is the limit of length for which safe loads are given in the tables. In the best practice the unsupported length of a column is frequently required not to exceed 125 times the least radius of gyration; this latter limit is indicated in the tables by zigzag lines.

An example is given on page 73 showing the method of selecting rolled H column sections for buildings, and to which reference should be made. Wherever possible, it is desirable to provide for the given range of loads by selecting the different weights required from the variations in size offered by columns of the same section. Columns thus selected can be obtained from the same rolling, thereby avoiding delay in delivery.

Abutting sections of columns, in addition to having machine squared ends, should be connected by splices of sufficient size to maintain the continuity of section required for preserving the rigidity of the steel frame work of the building or structure. The method of splicing column sections and the manner of connecting beams and girders are shown by the illustrations on page 97. Weights given of the various column sections do not include splices or connections of any kind.

The safe loads given in the tables are for concentric or symmetrical loading. When the loads are not centrally or symmetrically applied, bending is produced in the column, the effect of which must be considered. The unbalanced bending moment of the eccentric loads about the center of the column, in inch-lbs., divided by the section modulus of the column in the direction of bending gives the stress in lbs. per square inch produced by the bending. The load on the column produces a uniform compressive stress over the whole cross section to which the bending stress must be added. The sum is the maximum stress on the extreme fibers of the column section.

The maximum fiber stress due to direct load and bending must not be more than 25 per cent. in excess of the permissible stress on the column, for the given length, obtained from the formula for concentric loading, otherwise the section of the column must be increased until this limit is not exceeded.

The section modulus about each principal axis for all the sections of rolled H columns is given in the tables of their properties on pages 44-55, by means of which the effect of eccentric loading is easily calculated and considered in the above manner.

EXAMPLE**SHOWING THE METHOD OF SELECTING BETHLEHEM ROLLED H COLUMNS FOR BUILDINGS.**

For illustration, the interior columns of an actual 16-story building are taken as an example. The story heights and the loads on the columns are given in the following table:

Story.	Height of Story, Feet.	Load on Column, Tons.	H Column Section Required.					
			Safe Load, Tons.	Dimensions, in Inches.			Weight of Section, Lbs. per Foot.	Section Number.
				D	T	B		
16th	12	27	55.0	7 $\frac{7}{8}$	7 $\frac{7}{8}$	8.00	31.5	H8
15th	13	53	81.5	8 $\frac{3}{8}$	1 $\frac{1}{8}$	8.12	48.0	H8
14th	14	79						
13th	13	104	132.2	10 $\frac{3}{8}$	1 $\frac{3}{8}$	10.12	71.0	H10
12th	13	128						
11th	13	151	174.8	12 $\frac{1}{4}$	$\frac{7}{8}$	12.08	91.5	H12
10th	13	174						
9th	13	197	219.1	14 $\frac{1}{4}$	1 $\frac{5}{8}$	14.08	114.5	H14
8th	13	219						
7th	13	241	263.8	14 $\frac{5}{8}$	1 $\frac{7}{8}$	14.19	138.0	H14
6th	13	261						
5th	13	281	310.1	15	1 $\frac{5}{8}$	14.31	162.0	H14
4th	13	301						
3d	13	321	341.3	15 $\frac{1}{4}$	1 $\frac{7}{8}$	14.39	178.5	H14
2d	15	341						
1st	17	363	403.5	15 $\frac{3}{4}$	1 $\frac{11}{8}$	14.54	211.0	H14
Basement.	12	395						

Columns for buildings are usually selected in lengths of two stories. By inspection of the tables of safe loads for H columns, it is found that no columns smaller than 14" H sections have sufficient capacity for the lower stories. From the table on page 78 the 14" H columns required are then selected for the lower stories; and from the tables on pages 80, 82, and 84 the 12", 10", and 8" columns are selected for the upper stories.

All the sizes of columns, as selected and given in the above table, from the basement to the 9th story inclusive, are obtainable from the same rolls at a single rolling.

Where there is no limitation as to the size of the column, the largest dimension column having the required capacity will be the most economical.

SAFE LOADS, IN TONS OF 2000 LBS., FOR
BETHLEHEM GIRDER BEAMS
USED AS COLUMNS.

SQUARE ENDS.

Allowable stress per square inch :

13,000 lbs. for lengths under 55 radii.

16,000— $55 \frac{1}{r}$ for lengths over 55 radii.

Section Number.	Depth of Beam, Inches.	Weight per Foot, Lbs.	Area of Section, Sq. In.	Least Radius of Gyration, Inches.	UNSUPPORTED LENGTH OF COLUMNS, IN FEET.					
					8 Ft.	9 Ft.	10 Ft.	11 Ft.	12 Ft.	13 Ft.
G30 a	30	200.0	58.71	3.28	381.6	381.6	381.6	381.6	381.6	381.6
G30	30	180.0	53.00	2.86	344.5	344.5	344.5	344.5	344.5	344.5
G28 a	28	180.0	52.86	3.18	343.6	343.6	343.6	343.6	343.6	343.6
G28	28	165.0	48.47	2.77	315.1	315.1	315.1	315.1	315.1	312.7
G26 a	26	160.0	46.91	3.05	304.9	304.9	304.9	304.9	304.9	304.9
G26	26	150.0	43.94	2.38	285.6	285.6	285.6	285.6	285.6	281.2
G24 a	24	140.0	41.16	2.90	267.5	267.5	267.5	267.5	267.5	267.5
G24	24	120.0	35.38	2.66	230.0	230.0	230.0	230.0	230.0	225.8
G20 a	20	140.0	41.19	2.91	267.8	267.8	267.8	267.8	267.8	267.8
G20	20	112.0	32.81	2.70	213.3	213.3	213.3	213.3	213.3	210.4
G18	18	92.0	27.12	2.59	176.3	176.3	176.3	176.3	175.5	172.0
G15 b	15	140.0	41.27	2.83	268.2	268.2	268.2	268.2	268.2	267.6
G15 a	15	104.0	30.50	2.64	198.3	198.3	198.3	198.3	198.3	194.4
G15	15	73.0	21.49	2.39	139.7	139.7	139.7	139.3	136.3	133.4
G12 a	12	70.0	20.58	2.36	133.8	133.8	133.8	133.0	130.1	127.3
G12	12	55.0	16.18	2.24	105.2	105.2	105.2	103.2	100.9	98.5
G10	10	44.0	12.95	2.10	84.1	84.1	83.2	81.2	79.2	77.1
G9	9	38.0	11.22	1.98	72.9	72.9	71.1	69.2	67.3	65.4
G8	8	32.5	9.54	1.86	62.0	61.1	59.4	57.7	56.0	54.3

Beams not secured against yielding sideways and free to fail in direction of least radius of gyration.

SAFE LOADS, IN TONS OF 2000 LBS., FOR
BETHLEHEM GIRDER BEAMS
 USED AS COLUMNS.

SQUARE ENDS.

Allowable stress per square inch :

13,000 lbs. for lengths under 55 radii.

16,000— $55 \frac{1}{r}$ for lengths over 55 radii.

UNSUPPORTED LENGTH OF COLUMNS IN FEET.

UNSUPPORTED LENGTH OF COLUMNS IN FEET.										Section Number.
14 Ft.	15 Ft.	16 Ft.	18 Ft.	20 Ft.	22 Ft.	24 Ft.	28 Ft.	32 Ft.	36 Ft.	
381.6	381.6	375.2	363.4	351.5	339.7	327.9	304.3	280.7	257.0	G30 a
338.4	332.3	326.2	313.9	301.7	289.5	277.2	252.8	228.3	203.9	G30
343.6	340.6	335.1	324.1	313.1	302.2	291.2	269.3	247.3	225.4	G28 a
306.9	301.1	295.4	283.8	272.3	260.7	249.2	226.1	203.0	179.9	G28
304.2	299.2	294.1	283.9	273.8	263.6	253.5	233.2	212.9	192.6	G26 a
275.8	270.4	265.0	254.1	243.3	232.5	221.7	200.0	178.4	156.8	G26
263.7	259.0	254.3	245.0	235.6	226.2	216.9	198.1	179.4	160.7	G24 a
221.4	217.0	212.6	203.8	194.9	186.1	177.3	159.7	142.1	124.4	G24
264.1	259.5	254.8	245.5	236.1	226.8	217.4	198.8	180.1	161.4	G20 a
206.4	202.3	198.3	190.3	182.3	174.3	166.2	150.2	134.2	G20
168.6	165.1	161.7	154.8	147.9	140.9	134.0	120.2	106.4	G18
262.8	258.0	253.2	243.5	233.9	224.3	214.7	195.4	176.2	G15 b
190.6	186.8	183.0	175.4	167.8	160.1	152.5	137.3	122.0	G15 a
130.4	127.4	124.5	118.5	112.6	106.7	100.7	88.9	G15
124.4	121.5	118.6	112.9	107.1	101.4	95.6	84.1	G12 a
96.1	93.7	91.3	86.6	81.8	77.0	72.3	62.7	G12
75.1	73.1	71.0	67.0	62.9	58.8	54.7	G10
63.6	61.7	59.8	56.1	52.4	48.6	44.9	G9
52.7	51.0	49.3	45.9	42.5	39.1	35.7	G8

Loads given to the right of the zigzag line are for lengths greater than 125 radii of gyration.

SAFE LOADS, IN TONS OF 2000 LBS., FOR
BETHLEHEM I BEAMS
 USED AS COLUMNS.
 SQUARE ENDS.

Section Number.	Depth of Beam, Inches.	Weight per Foot, Pounds.	Area of Section, Sq. In.	Least Radius of Gyration, Inches.	UNSUPPORTED LENGTH OF COLUMNS.					
					5 Ft.	6 Ft.	7 Ft.	8 Ft.	9 Ft.	10 Ft.
B30	30	120.0	35.30	2.16	229.5	229.5	229.5	229.5	229.5	228.5
B28	28	105.0	30.88	2.06	200.7	200.7	200.7	200.7	200.7	197.6
B26	26	90.0	26.49	1.95	172.2	172.2	172.2	172.2	171.6	167.1
B24 a	24	84.0	24.80	1.92	161.2	161.2	161.2	161.2	160.0	155.8
B24	24	83.0	24.59	1.78	159.9	159.9	159.9	159.9	155.7	151.2
	24	73.0	21.47	1.86	139.6	139.6	139.6	139.6	137.5	133.7
B20 a	20	82.0	24.17	1.82	157.1	157.1	157.1	157.1	153.9	149.5
	20	72.0	21.37	1.88	138.9	138.9	138.9	138.9	137.2	133.5
B20	20	69.0	20.26	1.59	131.7	131.7	131.7	128.4	124.2	120.0
	20	64.0	18.86	1.62	122.6	122.6	122.6	120.1	116.3	112.5
	20	59.0	17.36	1.66	112.8	112.8	112.8	111.3	107.8	104.4
B18	18	59.0	17.40	1.50	113.1	112.4	112.4	108.6	104.8	100.9
	18	54.0	15.87	1.54	103.2	103.2	103.2	99.8	96.4	93.0
	18	52.0	15.24	1.56	99.1	99.1	99.1	96.2	92.9	89.7
	18	48.5	14.25	1.59	92.7	92.7	92.7	90.4	87.4	84.5
B15 b	15	71.0	20.95	1.71	136.2	136.2	136.2	135.3	131.2	127.2
B15 a	15	64.0	18.81	1.49	122.3	122.3	121.3	117.1	113.0	108.8
	15	54.0	15.88	1.55	103.2	103.2	103.2	100.0	96.6	93.3
B15	15	46.0	13.52	1.36	87.9	87.9	85.2	81.9	78.6	75.3
	15	41.0	12.02	1.41	78.1	78.1	76.5	73.6	70.8	68.0
	15	38.0	11.27	1.44	73.2	73.2	72.1	69.5	66.9	64.3
B12 a	12	36.0	10.61	1.42	69.0	69.0	67.6	65.2	62.7	60.2
	12	32.0	9.44	1.30	61.4	61.2	58.8	56.4	54.0	51.6
B12	12	28.5	8.42	1.35	54.8	54.8	53.0	50.9	48.9	46.8
	10	28.5	8.34	1.21	54.2	53.0	50.8	48.5	46.2	44.0
B10	10	23.5	6.94	1.27	45.1	44.7	42.9	41.1	39.3	37.5
	9	24.0	7.04	1.12	45.8	43.9	41.8	39.7	37.7	35.6
B9	9	20.0	6.01	1.17	39.1	37.9	36.2	34.5	32.8	31.1
	8	19.5	5.78	1.08	37.4	35.6	33.9	32.1	30.3	28.6
B8	8	17.5	5.18	1.11	33.6	32.2	30.6	29.1	27.6	26.0

Beams not secured against yielding sideways and free to fail in direction of least radius of gyration.

SAFE LOADS, IN TONS OF 2000 LBS., FOR
BETHLEHEM I BEAMS
 USED AS COLUMNS.
 SQUARE ENDS.

UNSUPPORTED LENGTH OF COLUMNS.

11 Ft.	12 Ft.	13 Ft.	14 Ft.	15 Ft.	16 Ft.	18 Ft.	20 Ft.	22 Ft.	24 Ft.	Section Number.
223.1	217.7	212.3	206.9	201.5	196.1	185.3	174.6	163.8	153.0	B30
192.6	187.7	182.7	177.8	172.9	167.9	158.0	148.1	138.2	128.3	B28
162.6	158.1	153.6	149.1	144.7	140.2	131.2	122.3	113.3	104.3	B26
151.5	147.2	143.0	138.7	134.4	130.2	121.7	113.1	104.6	96.1	B24 a
146.6	142.0	137.5	132.9	128.4	123.8	114.7	105.6	96.4	B24
129.9	126.1	122.3	118.5	114.6	110.8	103.2	95.6	88.0	B24
145.2	140.8	136.4	132.0	127.6	123.2	114.5	105.7	97.0	B20 a
129.7	126.0	122.2	118.5	114.7	111.0	103.4	95.9	88.4	B20 a
115.8	111.6	107.4	103.2	99.0	94.8	86.4	78.0	B20
108.6	104.8	100.9	97.1	93.3	89.4	81.7	74.0	B20
100.9	97.5	94.0	90.6	87.1	83.7	76.8	69.9	B20
97.1	93.3	89.5	85.6	81.8	78.0	70.3	62.7	B18
89.6	86.2	82.8	79.4	76.0	72.6	65.8	59.0	B18
86.5	83.3	80.0	76.8	73.6	70.4	63.9	57.5	B18
81.5	78.5	75.6	72.6	69.7	66.7	60.8	54.9	B18
123.1	119.1	115.0	111.0	107.0	102.9	94.8	86.7	B15 b
104.6	100.5	96.3	92.1	88.0	83.8	75.5	67.2	B15 a
89.9	86.5	83.1	79.7	76.3	73.0	66.2	59.4	B15 a
72.1	68.8	65.5	62.2	58.9	55.7	49.1	B15
65.2	62.4	59.6	56.8	54.0	51.1	45.5	B15
61.7	59.2	56.6	54.0	51.4	48.8	43.7	B15
57.8	55.3	52.8	50.4	47.9	45.4	40.5	B12 a
49.2	46.8	44.4	42.0	39.6	37.2	B12 a
44.7	42.7	40.6	38.6	36.5	34.4	B12
41.7	39.4	37.1	34.9	32.6	30.3	B12
35.7	33.9	32.1	30.3	28.5	26.6	B10
33.5	31.4	29.4	27.3	25.2	B10
29.4	27.7	26.0	24.3	22.7	B9
26.8	25.0	23.3	21.5	B9
24.5	22.9	21.4	19.9	B8

Allowable stress per square inch:
 13,000 lbs. for lengths under 55 radii.
 16,000—55 $\frac{1}{r}$ for lengths over 55 radii.

Loads given to the right of the zigzag line are for lengths greater than 125 radii of gyration.

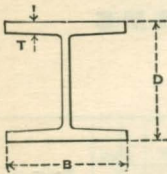

SAFE LOADS, IN TONS OF 2000 LBS., FOR
BETHLEHEM ROLLED STEEL
14" H COLUMNS.

SQUARE ENDS.

Allowable stress per square inch :

13,000 lbs. for lengths under 55 radii.

16,000— $55 \frac{1}{r}$ for lengths over 55 radii.

Section Number.	Weight of Section, Lbs. per Foot.	DIMENSIONS, INCHES.			Area of Section, Square Inches.	Least Radius of Gyration, Inches.	UNSUPPORTED LENGTH OF COLUMNS.				
		D	T	B			10 Ft.	12 Ft.	14 Ft.	16 Ft.	18 Ft.
	83.5	13 $\frac{3}{4}$	1 $\frac{1}{8}$	13.92	24.46	3.47	159.0	159.0	159.0	158.5	153.8
	91.0	13 $\frac{7}{8}$	1 $\frac{3}{4}$	13.96	26.76	3.49	173.9	173.9	173.9	173.9	168.5
	99.0	14	1 $\frac{3}{8}$	14.00	29.06	3.50	188.9	188.9	188.9	188.6	183.2
	106.5	14 $\frac{1}{8}$	1 $\frac{7}{8}$	14.04	31.38	3.52	204.0	204.0	204.0	204.0	198.1
	114.5	14 $\frac{1}{4}$	1 $\frac{5}{8}$	14.08	33.70	3.53	219.1	219.1	219.1	219.1	212.9
	122.5	14 $\frac{3}{8}$	1	14.12	36.04	3.55	234.3	234.3	234.3	234.3	228.0
	130.5	14 $\frac{1}{2}$	1 $\frac{1}{8}$	14.16	38.38	3.56	249.5	249.5	249.5	249.5	243.0
	138.0	14 $\frac{5}{8}$	1 $\frac{1}{8}$	14.19	40.59	3.58	263.8	263.8	263.8	263.8	257.4
	146.0	14 $\frac{3}{4}$	1 $\frac{3}{8}$	14.23	42.95	3.59	279.2	279.2	279.2	279.2	272.5
	154.0	14 $\frac{7}{8}$	1 $\frac{1}{4}$	14.27	45.33	3.61	294.7	294.7	294.7	294.7	288.1
	162.0	15	1 $\frac{5}{8}$	14.31	47.71	3.62	310.1	310.1	310.1	310.1	303.4
H14	170.5	15 $\frac{1}{8}$	1 $\frac{3}{8}$	14.35	50.11	3.64	325.7	325.7	325.7	325.7	319.0
	178.5	15 $\frac{1}{4}$	1 $\frac{7}{8}$	14.39	52.51	3.65	341.3	341.3	341.3	341.3	334.6
	186.5	15 $\frac{3}{8}$	1 $\frac{1}{2}$	14.43	54.92	3.66	357.0	357.0	357.0	357.0	350.3
	195.0	15 $\frac{1}{2}$	1 $\frac{9}{8}$	14.47	57.35	3.68	372.8	372.8	372.8	372.8	366.1
	203.5	15 $\frac{5}{8}$	1 $\frac{5}{8}$	14.51	59.78	3.69	388.6	388.6	388.6	388.6	381.9
	211.0	15 $\frac{3}{4}$	1 $\frac{1}{8}$	14.54	62.07	3.70	403.5	403.5	403.5	403.5	396.9
	219.5	15 $\frac{7}{8}$	1 $\frac{1}{4}$	14.58	64.52	3.71	419.4	419.4	419.4	419.4	412.9
	227.5	16	1 $\frac{3}{8}$	14.62	66.98	3.72	435.4	435.4	435.4	435.4	429.0
	236.0	16 $\frac{1}{8}$	1 $\frac{7}{8}$	14.66	69.45	3.74	451.4	451.4	451.4	451.4	445.2
	244.5	16 $\frac{1}{4}$	1 $\frac{5}{8}$	14.70	71.94	3.75	467.6	467.6	467.6	467.6	461.5
	253.0	16 $\frac{3}{8}$	2	14.74	74.43	3.76	483.8	483.8	483.8	483.8	477.9
	261.5	16 $\frac{1}{2}$	2 $\frac{1}{8}$	14.78	76.93	3.77	500.0	500.0	500.0	500.0	494.4
	270.0	16 $\frac{3}{4}$	2 $\frac{1}{8}$	14.82	79.44	3.79	516.4	516.4	516.4	516.4	510.9
	278.5	16 $\frac{7}{8}$	2 $\frac{3}{8}$	14.86	81.97	3.80	532.8	532.8	532.8	532.8	527.6
	287.5	16 $\frac{7}{8}$	2 $\frac{1}{4}$	14.90	84.50	3.81	549.3	549.3	549.3	549.3	544.3

For detail dimensions, see page 44.

**SAFE LOADS, IN TONS OF 2000 LBS., FOR
BETHLEHEM ROLLED STEEL
14" H COLUMNS.
SQUARE ENDS.**

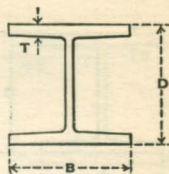

Allowable stress per square inch :
13,000 lbs. for lengths under 55 radii.
16,000— $55 \frac{1}{r}$ for lengths over 55 radii.

UNSUPPORTED LENGTH OF COLUMNS.

20 Ft.	22 Ft.	24 Ft.	26 Ft.	28 Ft.	30 Ft.	32 Ft.	36 Ft.	40 Ft.	44 Ft.	Weight of Section, Lbs. per Foot.
149.2	144.5	139.9	135.2	130.5	125.9	121.2	111.9	102.6		83.5
163.4	158.4	153.3	148.2	143.2	138.1	133.1	122.9	112.8		91.0
177.7	172.2	166.7	161.2	155.8	150.3	144.8	133.8	122.9	111.9	99.0
192.2	186.3	180.4	174.6	168.7	162.8	156.9	145.1	133.4	121.6	106.5
206.6	200.3	194.0	187.7	181.4	175.1	168.8	156.2	143.6	131.0	114.5
221.3	214.6	207.9	201.2	194.5	187.8	181.1	167.7	154.3	140.9	122.5
235.9	228.8	221.7	214.5	207.4	200.3	193.2	179.0	164.7	150.5	130.5
249.9	242.4	234.9	227.4	220.0	212.5	205.0	190.0	175.1	160.1	138.0
264.6	256.7	248.9	241.0	233.1	225.2	217.3	201.5	185.7	170.0	146.0
279.8	271.5	263.2	254.9	246.6	238.3	230.0	213.5	196.9	180.3	154.0
294.7	286.0	277.3	268.6	259.9	251.2	242.5	225.1	207.7	190.3	162.0
309.9	300.8	291.7	282.6	273.5	264.4	255.3	237.1	218.9	200.7	170.5
325.1	315.6	306.1	296.6	287.1	277.6	268.1	249.1	230.1	211.1	178.5
340.4	330.5	320.6	310.7	300.8	290.9	281.0	261.2	241.4	221.6	186.5
355.8	345.5	335.2	324.9	314.6	304.3	294.0	273.4	252.8	232.2	195.0
371.2	360.5	349.8	339.1	328.4	317.7	307.0	285.6	264.2	242.8	203.5
385.8	374.8	363.7	352.6	341.6	330.5	319.4	297.3	275.1	253.0	211.0
401.4	390.0	378.5	367.1	355.6	344.1	332.6	309.7	286.8	263.8	219.5
417.2	405.3	393.4	381.6	369.7	357.8	345.9	322.2	298.5	274.8	227.5
433.0	420.7	408.4	396.2	383.9	371.6	359.4	334.8	310.3	285.8	236.0
448.9	436.2	423.6	410.9	398.2	385.6	372.9	347.6	322.2	296.9	244.5
464.8	451.8	438.7	425.7	412.6	399.6	386.5	360.4	334.3	308.1	253.0
480.9	467.4	454.0	440.5	427.1	413.6	400.2	373.3	346.4	319.5	261.5
497.0	483.2	469.3	455.5	441.6	427.8	413.9	386.3	358.6	330.9	270.0
513.3	499.1	484.8	470.6	456.3	442.1	427.8	399.4	370.9	342.4	278.5
529.6	515.0	500.4	485.7	471.1	456.4	441.8	412.5	383.3	354.0	287.5

Loads to the right of the heavy line are for lengths greater than 125 radii.

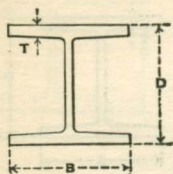

**SAFE LOADS, IN TONS OF 2000 LBS., FOR
BETHLEHEM ROLLED STEEL
12" H COLUMNS.
SQUARE ENDS.**

Allowable stress per square inch :
13,000 lbs. for lengths under 55 radii.
16,000— $55 \frac{1}{r}$ for lengths over 55 radii.

Section Number.	Weight of Section, Lbs. per Foot.	DIMENSIONS, INCHES.			Area of Section, Square Inches.	Least Radius of Gyration, Inches.	UNSUPPORTED LENGTH OF COLUMNS.				
		D	T	B			10 Ft.	12 Ft.	14 Ft.	16 Ft.	18 Ft.
H12	64.5	$11\frac{3}{4}$	$\frac{5}{8}$	11.92	19.00	2.98	123.5	123.5	122.5	118.3	114.1
	71.5	$11\frac{7}{8}$	$1\frac{1}{8}$	11.96	20.96	3.00	136.2	136.2	135.4	130.8	126.2
	78.0	12	$\frac{3}{4}$	12.00	22.94	3.01	149.1	149.1	148.3	143.3	138.3
	84.5	$12\frac{1}{8}$	$1\frac{3}{8}$	12.04	24.92	3.03	162.0	162.0	161.4	155.9	150.5
	91.5	$12\frac{1}{4}$	$\frac{7}{8}$	12.08	26.92	3.04	175.0	175.0	174.5	168.6	162.8
	98.5	$12\frac{3}{8}$	$1\frac{5}{8}$	12.12	28.92	3.06	188.0	188.0	187.7	181.5	175.2
	105.0	$12\frac{1}{2}$	1	12.16	30.94	3.07	201.1	201.1	201.0	194.3	187.7
	112.0	$12\frac{5}{8}$	$1\frac{1}{8}$	12.20	32.96	3.08	214.2	214.2	214.2	207.2	200.1
	118.5	$12\frac{3}{4}$	$1\frac{1}{8}$	12.23	34.87	3.10	226.7	226.7	226.7	219.6	212.1
	125.5	$12\frac{7}{8}$	$1\frac{3}{8}$	12.27	36.91	3.11	239.9	239.9	239.9	232.6	224.8
	132.5	13	$1\frac{1}{4}$	12.31	38.97	3.13	253.3	253.3	253.3	246.0	237.8
	139.5	$13\frac{1}{8}$	$1\frac{5}{8}$	12.35	41.03	3.14	266.7	266.7	266.7	259.3	250.6
	146.5	$13\frac{1}{4}$	$1\frac{3}{8}$	12.39	43.10	3.15	280.2	280.2	280.2	272.6	263.5
	153.5	$13\frac{3}{8}$	$1\frac{7}{8}$	12.43	45.19	3.16	293.7	293.7	293.7	286.0	276.6
161.0	$13\frac{1}{2}$	$1\frac{1}{2}$	12.47	47.28	3.18	307.3	307.3	307.3	299.7	289.9	

For detail dimensions, see page 46.

**SAFE LOADS, IN TONS OF 2000 LBS., FOR
BETHLEHEM ROLLED STEEL
12" H COLUMNS.
SQUARE ENDS.**

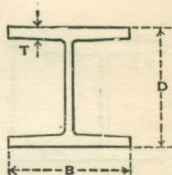

Allowable stress per square inch :
13,000 lbs. for lengths under 55 radii.
16,000— $55 \frac{1}{r}$ for lengths over 55 radii.

UNSUPPORTED LENGTH OF COLUMNS.

20 Ft.	22 Ft.	24 Ft.	26 Ft.	28 Ft.	30 Ft.	32 Ft.	34 Ft.	36 Ft.	38 Ft.	Weight of Section, Lbs. per Foot.
109.9	105.7	101.5	97.3	93.1	88.9	84.7	80.5	76.3		64.5
121.6	117.0	112.4	107.8	103.1	98.5	93.9	89.3	84.7		71.5
133.2	128.2	123.2	118.1	113.1	108.1	103.0	98.0	93.0		78.0
145.1	139.7	134.2	128.8	123.4	117.9	112.5	107.1	101.7		84.5
156.9	151.1	145.2	139.4	133.5	127.7	121.9	116.0	110.2	104.3	91.5
169.0	162.8	156.5	150.3	144.0	137.8	131.6	125.3	119.1	112.8	98.5
181.0	174.4	167.7	161.1	154.4	147.8	141.1	134.4	127.8	121.1	105.0
193.1	186.0	178.9	171.9	164.8	157.7	150.7	143.6	136.6	129.5	112.0
204.7	197.3	189.9	182.5	175.0	167.6	160.2	152.8	145.3	137.9	118.5
217.0	209.1	201.3	193.5	185.6	177.8	170.0	162.1	154.3	146.5	125.5
229.6	221.4	213.2	204.9	196.7	188.5	180.3	172.1	163.9	155.6	132.5
242.0	233.4	224.8	216.1	207.5	198.9	190.3	181.6	173.0	164.4	139.5
254.5	245.5	236.4	227.4	218.4	209.3	200.3	191.3	182.3	173.2	146.5
267.1	257.7	248.3	238.8	229.4	219.9	210.5	201.1	191.6	182.2	153.5
280.1	270.3	260.5	250.7	240.9	231.0	221.2	211.4	201.6	191.8	161.0

Loads to the right of the heavy line are for lengths greater than 125 radii.

SAFE LOADS, IN TONS OF 2000 LBS., FOR

BETHLEHEM ROLLED STEEL 10" H COLUMNS.

SQUARE ENDS.

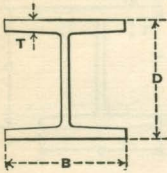

Allowable stress per square inch :
 13,000 lbs. for lengths under 55 radii.
 16,000—55 $\frac{1}{r}$ for lengths over 55 radii.

Section Number.	Weight of Section, Lbs. per Foot.	DIMENSIONS, INCHES.			Area of Section, Square Inches.	Least Radius of Gyration, Inches.	UNSUPPORTED LENGTH OF COLUMNS.				
		D	T	B			10 Ft.	11 Ft.	12 Ft.	13 Ft.	14 Ft.
H10	49.0	9 $\frac{7}{8}$	$\frac{9}{16}$	9.97	14.37	2.49	93.5	93.5	92.1	90.2	88.3
	54.0	10	$\frac{5}{8}$	10.00	15.91	2.51	103.4	103.4	102.2	100.1	98.0
	59.5	10 $\frac{1}{8}$	$\frac{1}{16}$	10.04	17.57	2.53	114.2	114.2	113.1	110.8	108.5
	65.5	10 $\frac{1}{4}$	$\frac{3}{4}$	10.08	19.23	2.54	125.0	125.0	123.9	121.4	118.9
	71.0	10 $\frac{3}{8}$	$\frac{1}{16}$	10.12	20.91	2.56	135.9	135.9	134.9	132.2	129.5
	77.0	10 $\frac{1}{2}$	$\frac{7}{8}$	10.16	22.59	2.57	146.8	146.8	145.9	143.0	140.1
	82.5	10 $\frac{5}{8}$	$\frac{1}{16}$	10.20	24.29	2.58	157.9	157.9	157.0	153.9	150.8
	88.5	10 $\frac{3}{4}$	1	10.24	25.99	2.60	168.9	168.9	168.3	165.0	161.7
	94.0	10 $\frac{7}{8}$	1 $\frac{1}{16}$	10.28	27.71	2.61	180.1	180.1	179.6	176.1	172.6
	99.5	11	1 $\frac{1}{8}$	10.31	29.32	2.62	190.6	190.6	190.2	186.6	182.9
	105.5	11 $\frac{1}{8}$	1 $\frac{3}{16}$	10.35	31.06	2.64	201.9	201.9	201.9	198.0	194.1
	111.5	11 $\frac{1}{4}$	1 $\frac{1}{4}$	10.39	32.80	2.65	213.2	213.2	213.2	209.3	205.2
	117.5	11 $\frac{3}{8}$	1 $\frac{5}{16}$	10.43	34.55	2.66	224.6	224.6	224.6	220.7	216.4
	123.5	11 $\frac{1}{2}$	1 $\frac{3}{8}$	10.47	36.32	2.67	236.1	236.1	236.1	232.2	227.7

For detail dimensions, see page 48.

**SAFE LOADS, IN TONS OF 2000 LBS., FOR
BETHLEHEM ROLLED STEEL
10" H COLUMNS.
SQUARE ENDS.**

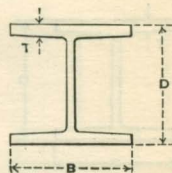

Allowable stress per square inch :
13,000 lbs. for lengths under 55 radii.
13,000— $55 \frac{1}{r}$ for lengths over 55 radii.

UNSUPPORTED LENGTH OF COLUMNS.

Weight of
Section, Lbs.
per Foot.

15 Ft.	16 Ft.	18 Ft.	20 Ft.	22 Ft.	24 Ft.	26 Ft.	28 Ft.	30 Ft.	32 Ft.	
86.3	84.5	80.7	76.9	73.1	69.3	65.4	61.6	57.8	54.0	49.0
95.9	93.8	89.6	85.4	81.3	77.1	72.9	68.7	64.5	60.3	54.0
106.2	103.9	99.3	94.7	90.1	85.6	81.0	76.4	71.8	67.2	59.5
116.4	113.9	108.9	103.9	98.9	93.9	88.9	83.9	78.9	73.9	65.5
126.9	124.2	118.8	113.4	108.0	102.6	97.2	91.8	86.4	80.1	71.0
137.2	134.3	128.5	122.7	116.9	111.1	105.3	99.5	93.7	87.9	77.0
147.7	144.6	138.4	132.2	126.0	119.8	113.5	107.3	101.1	94.9	82.5
158.4	155.1	148.5	142.0	135.4	128.8	122.2	115.6	109.0	102.4	88.5
169.1	165.6	158.6	151.6	144.6	137.6	130.6	123.6	116.6	109.6	94.0
179.2	175.5	168.1	160.7	153.3	145.9	138.5	131.2	123.8	116.4	99.5
190.3	186.4	178.6	170.8	163.1	155.3	147.5	139.8	132.0	124.2	105.5
201.2	197.0	188.9	180.7	172.5	164.4	156.2	148.0	139.9	131.7	111.5
212.1	207.8	199.2	190.7	182.1	173.5	165.0	156.4	147.8	139.2	117.5
223.2	218.7	209.8	200.8	191.8	182.8	173.8	164.9	155.9	146.9	123.5

Loads to the right of the heavy line are for lengths greater than 125 radii.

SAFE LOADS, IN TONS OF 2000 LBS., FOR
BETHLEHEM ROLLED STEEL
8" H COLUMNS.
SQUARE ENDS.

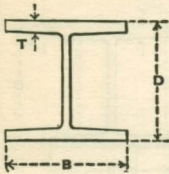

Allowable stress per square inch :
 13,000 lbs. for lengths under 55 radii.
 16,000— $55 \frac{1}{r}$ for lengths over 55 radii.

Section Number.	Weight of Section, Lbs. per Foot.	DIMENSIONS, INCHES.			Area of Section, Square Inches.	Least Radius of Gyration, Inches.	UNSUPPORTED LENGTH OF COLUMNS.				
		D	T	B			8 Ft.	9 Ft.	10 Ft.	11 Ft.	12 Ft.
H 8	32.0	$7\frac{7}{8}$	$\frac{7}{16}$	8.00	9.17	1.98	59.7	59.7	58.1	56.5	55.0
	34.5	8	$\frac{1}{2}$	8.00	10.17	2.01	66.1	66.1	64.7	63.0	61.3
	39.0	$8\frac{1}{8}$	$\frac{9}{16}$	8.04	11.50	2.03	74.8	74.8	73.3	71.4	69.6
	43.5	$8\frac{1}{4}$	$\frac{5}{8}$	8.08	12.83	2.04	83.4	83.4	81.9	79.8	77.7
	48.0	$8\frac{3}{8}$	$\frac{11}{16}$	8.12	14.18	2.05	92.2	92.2	90.6	88.3	86.1
	53.0	$8\frac{1}{2}$	$\frac{3}{4}$	8.16	15.53	2.07	101.0	101.0	99.5	97.0	94.5
	57.5	$8\frac{5}{8}$	$\frac{13}{16}$	8.20	16.90	2.08	109.9	109.9	108.4	105.7	103.0
	62.0	$8\frac{3}{4}$	$\frac{7}{8}$	8.24	18.27	2.09	118.8	118.8	117.3	114.4	111.5
	67.0	$8\frac{7}{8}$	$\frac{15}{16}$	8.28	19.66	2.11	127.8	127.8	126.5	123.5	120.4
	71.5	9	1	8.32	21.05	2.12	136.8	136.8	135.6	132.4	129.1
	76.5	$9\frac{1}{8}$	$1\frac{1}{16}$	8.36	22.46	2.13	146.0	146.0	144.9	141.4	137.9
	81.0	$9\frac{1}{4}$	$1\frac{1}{8}$	8.39	23.78	2.14	154.6	154.6	153.6	149.9	146.2
	85.5	$9\frac{3}{8}$	$1\frac{3}{16}$	8.43	25.20	2.16	163.8	163.8	163.1	159.3	155.4
	90.5	$9\frac{1}{2}$	$1\frac{1}{4}$	8.47	26.64	2.17	173.2	173.2	172.6	168.6	164.5

For detail dimensions, see page 50.

**SAFE LOADS, IN TONS OF 2000 LBS., FOR
BETHLEHEM ROLLED STEEL
8" H COLUMNS.
SQUARE ENDS.**

Allowable stress per square inch :
13,000 lbs. for lengths under 55 radii.
16,000— $55 \frac{1}{r}$ for lengths over 55 radii.

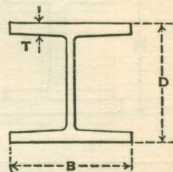

UNSUPPORTED LENGTH OF COLUMNS.

UNSUPPORTED LENGTH OF COLUMNS.										Weight of Section, Lbs. per Foot.
13 Ft.	14 Ft.	15 Ft.	16 Ft.	17 Ft.	18 Ft.	20 Ft.	22 Ft.	24 Ft.	26 Ft.	
53.5	52.0	50.4	48.9	47.4	45.9	42.8	39.7	36.7		32.0
59.7	58.0	56.3	54.6	53.0	51.3	48.0	44.6	41.3	38.0	34.5
67.7	65.8	64.0	62.1	60.2	58.4	54.6	50.9	47.1	43.4	39.0
75.7	73.6	71.5	69.4	67.4	65.3	61.1	57.0	52.8	48.7	43.5
83.8	81.5	79.2	76.9	74.6	72.4	67.8	63.2	58.7	54.1	48.0
92.1	89.6	87.1	84.6	82.2	79.7	74.7	69.8	64.8	59.9	53.0
100.3	97.7	95.0	92.3	89.6	86.9	81.6	76.2	70.9	65.5	57.5
108.7	105.8	102.9	100.0	97.1	94.2	88.5	82.7	76.9	71.2	62.0
117.3	114.2	111.2	108.1	105.0	101.9	95.8	89.6	83.5	77.3	67.0
125.8	122.5	119.2	116.0	112.7	109.4	102.9	96.3	89.8	83.2	71.5
134.4	131.0	127.5	124.0	120.5	117.0	110.1	103.1	96.2	89.2	76.5
142.6	138.9	135.2	131.6	127.9	124.2	116.9	109.6	102.2	94.9	81.0
151.6	147.7	143.9	140.0	136.1	132.3	124.6	116.9	109.2	101.5	85.5
160.5	156.4	152.4	148.3	144.3	140.2	132.1	124.0	115.9	107.8	90.5

Loads to the right of the heavy line are for lengths greater than 125 radii.

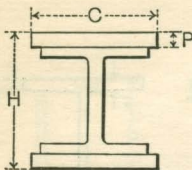

SAFE LOADS, IN TONS OF 2000 LBS., FOR
COMPOUND COLUMNS.
SQUARE ENDS.

14" x 148 Lb. Special H Column Section
 Reinforced with Cover Plates.

Allowable stress per square inch :
 13,000 lbs. for lengths under 55 radii.
 16,000 — 55 $\frac{1}{r}$ for lengths over 55 radii.

Section.	Weight of Section, Lbs. per Foot.	DIMENSIONS, INCHES.			Area of Section, Square Inches.	Least Radius of Gyration, Inches.	UNSUPPORTED LENGTH OF COLUMNS.				
		C	P	H			12 Ft.	14 Ft.	16 Ft.	18 Ft.	20 Ft.
Columns composed of a 14" x 148 Lb. Special Column Section, (Section H14b), reinforced with cover plates of width and thickness given in table.	284.0	16	1 $\frac{1}{4}$	16 $\frac{5}{8}$	83.52	3.98	542.9	542.9	542.9	542.9	529.7
	290.8	16	1 $\frac{5}{16}$	16 $\frac{7}{8}$	85.52	3.99	555.9	555.9	555.9	555.9	542.7
	297.6	16	1 $\frac{3}{8}$	16 $\frac{1}{2}$	87.52	4.01	568.9	568.9	568.9	568.9	556.1
	304.4	16	1 $\frac{7}{8}$	17	89.52	4.02	581.9	581.9	581.9	581.9	569.2
	311.2	16	1 $\frac{1}{2}$	17 $\frac{1}{2}$	91.52	4.04	594.9	594.9	594.9	594.9	582.6
	318.0	16	1 $\frac{9}{16}$	17 $\frac{1}{4}$	93.52	4.05	607.9	607.9	607.9	607.9	595.8
	324.8	16	1 $\frac{5}{8}$	17 $\frac{3}{8}$	95.52	4.06	620.9	620.9	620.9	620.9	608.9
	331.6	16	1 $\frac{11}{16}$	17 $\frac{1}{2}$	97.52	4.08	633.9	633.9	633.9	633.9	622.4
	338.4	16	1 $\frac{3}{4}$	17 $\frac{3}{4}$	99.52	4.09	646.9	646.9	646.9	646.9	635.6
	345.2	16	1 $\frac{3}{8}$	17 $\frac{1}{4}$	101.52	4.10	659.9	659.9	659.9	659.9	648.7
	350.3	17	1 $\frac{3}{4}$	17 $\frac{3}{4}$	103.02	4.30	669.6	669.6	669.6	669.6	666.0
	357.5	17	1 $\frac{11}{16}$	17 $\frac{1}{2}$	105.15	4.31	683.5	683.5	683.5	683.5	680.2
	364.7	17	1 $\frac{5}{8}$	17 $\frac{1}{2}$	107.27	4.32	697.3	697.3	697.3	697.3	694.3
	372.0	17	1 $\frac{5}{16}$	18	109.40	4.33	711.1	711.1	711.1	711.1	708.4
	379.2	17	2	18 $\frac{1}{2}$	111.52	4.35	724.9	724.9	724.9	724.9	723.0
386.4	17	2 $\frac{1}{16}$	18 $\frac{1}{2}$	113.65	4.36	738.7	738.7	738.7	738.7	737.2	
393.6	17	2 $\frac{1}{8}$	18 $\frac{3}{8}$	115.77	4.37	752.5	752.5	752.5	752.5	751.3	
400.9	17	2 $\frac{3}{16}$	18 $\frac{1}{2}$	117.90	4.38	766.4	766.4	766.4	766.4	765.5	
408.1	17	2 $\frac{1}{4}$	18 $\frac{3}{8}$	120.02	4.39	780.1	780.1	780.1	780.1	779.7	
415.3	17	2 $\frac{5}{16}$	18 $\frac{1}{2}$	122.15	4.40	794.0	794.0	794.0	794.0	794.0	
423.4	18	2 $\frac{1}{4}$	18 $\frac{5}{8}$	124.52	4.62	809.4	809.4	809.4	809.4	809.4	
431.0	18	2 $\frac{5}{16}$	18 $\frac{3}{4}$	126.77	4.63	824.0	824.0	824.0	824.0	824.0	
438.7	18	2 $\frac{3}{8}$	18 $\frac{7}{8}$	129.02	4.64	838.6	838.6	838.6	838.6	838.6	
446.3	18	2 $\frac{7}{16}$	19	131.27	4.65	853.3	853.3	853.3	853.3	853.3	
454.0	18	2 $\frac{1}{2}$	19 $\frac{1}{2}$	133.52	4.66	867.9	867.9	867.9	867.9	867.9	
461.6	18	2 $\frac{9}{16}$	19 $\frac{1}{2}$	135.77	4.67	882.5	882.5	882.5	882.5	882.5	
469.3	18	2 $\frac{5}{8}$	19 $\frac{3}{4}$	138.02	4.68	897.1	897.1	897.1	897.1	897.1	
476.9	18	2 $\frac{11}{16}$	19 $\frac{3}{4}$	140.27	4.69	911.8	911.8	911.8	911.8	911.8	
484.6	18	2 $\frac{3}{4}$	19 $\frac{3}{4}$	142.52	4.70	926.4	926.4	926.4	926.4	926.4	

For detail dimensions, see page 54.

**SAFE LOADS, IN TONS OF 2000 LBS., FOR
COMPOUND COLUMNS.
SQUARE ENDS.**

14' x 148 Lb. Special H Column Section
Reinforced with Cover Plates.

Allowable stress per square inch :
13,000 lbs. for lengths under 55 radii.
16,000 — $55 \frac{1}{r}$ for lengths over 55 radii.

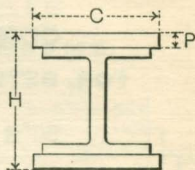

UNSUPPORTED LENGTH OF COLUMNS.

Cover Plates.

22 Ft.	24 Ft.	26 Ft.	28 Ft.	30 Ft.	32 Ft.	36 Ft.	40 Ft.	44 Ft.	48 Ft.	Width, Inches. C	Thick- ness, Inches. P
515.8	502.0	488.1	474.3	460.4	446.6	418.9	391.2	363.5	335.8	16	1 1/4
528.6	514.4	500.3	486.1	472.0	457.8	429.5	401.2	372.9	344.7	16	1 5/8
541.7	527.3	512.9	498.5	484.1	469.7	440.9	412.1	383.3	354.4	16	1 3/8
554.5	539.8	525.1	510.4	495.7	481.0	451.6	422.2	392.8	363.4	16	1 7/8
567.7	552.7	537.8	522.8	507.9	492.9	463.0	433.1	403.2	373.3	16	1 1/2
580.5	565.3	550.0	534.8	519.6	504.3	473.8	443.4	412.9	382.4	16	1 9/8
593.4	577.8	562.3	546.8	531.2	515.7	484.7	453.6	422.5	391.5	16	1 5/8
606.6	590.9	575.1	559.3	543.5	527.8	496.2	464.7	433.1	401.6	16	1 1/8
619.5	603.4	587.4	571.3	555.3	539.2	507.1	475.0	442.9	410.7	16	1 3/8
632.4	616.1	599.7	583.4	567.0	550.7	518.0	485.3	452.6	419.9	16	1 1/8
650.2	634.4	618.6	602.8	587.0	571.2	539.5	507.9	476.3	444.7	17	1 3/4
664.1	648.0	631.9	615.8	599.7	583.6	551.4	519.2	487.0	454.8	17	1 7/8
677.9	661.5	645.1	628.7	612.3	595.9	563.2	530.4	497.6	464.8	17	1 5/8
691.8	675.1	658.4	641.7	625.1	608.4	575.0	541.7	508.3	475.0	17	1 5/8
706.0	689.1	672.2	655.3	638.4	621.4	587.6	553.8	519.9	486.1	17	2
720.0	702.8	685.5	668.3	651.1	633.9	599.5	565.1	530.7	496.3	17	2 1/8
733.8	716.3	698.9	681.4	663.9	646.4	611.4	576.5	541.5	506.5	17	2 1/8
747.8	730.0	712.2	694.5	676.7	658.9	623.4	587.9	552.4	516.8	17	2 3/8
761.7	743.6	725.6	707.5	689.5	671.5	635.4	599.3	563.2	527.1	17	2 1/4
775.7	757.3	739.0	720.7	702.4	684.0	647.4	610.8	574.1	537.5	17	2 1/8
800.5	782.7	764.9	747.1	729.3	711.5	676.0	640.4	604.8	569.2	18	2 1/4
815.4	797.3	779.2	761.2	743.1	725.0	688.9	652.7	616.6	580.5	18	2 5/8
830.3	811.9	793.6	775.2	756.9	738.5	701.8	665.1	628.4	591.7	18	2 3/8
845.2	826.6	807.9	789.3	770.7	752.0	714.8	677.5	640.3	603.0	18	2 7/8
860.1	841.2	822.3	803.4	784.5	765.6	727.8	689.9	652.1	614.3	18	2 1/2
875.1	855.9	836.7	817.5	798.3	779.2	740.8	702.4	664.0	625.6	18	2 9/8
890.1	870.6	851.1	831.7	812.2	792.7	753.8	714.9	675.9	637.0	18	2 5/8
905.0	885.3	865.5	845.8	826.1	806.3	766.8	727.4	687.9	648.4	18	2 1/8
920.0	900.0	880.0	860.0	840.0	819.9	779.9	739.9	699.9	659.8	18	2 3/4

^ Loads to the right of the heavy line are for lengths greater than 125 radii.

CONNECTION ANGLES FOR BETHLEHEM GIRDER BEAMS.

30" G

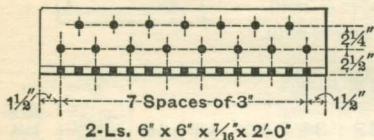

18" G

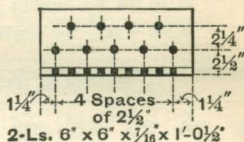

26" and 28" Gs

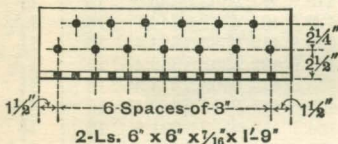

15" G

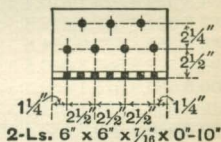

24" G

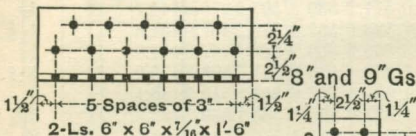

8" and 9" Gs

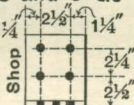

10" and 12" Gs



20" G

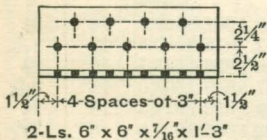

2-Ls. 6" x 6" x 1/16" x 0'-5"



2-Ls. 6" x 6" x 1/16" x 0'-7 1/2"

Spacing same in both legs of angles unless shown otherwise.
All holes 1/8" diameter for 3/4" diameter rivets or bolts.

CONNECTION ANGLES FOR BETHLEHEM I BEAMS.

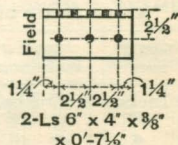
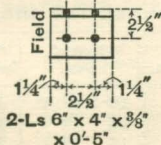
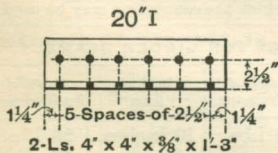
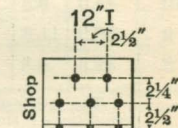
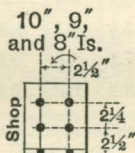
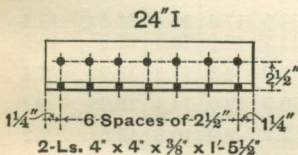
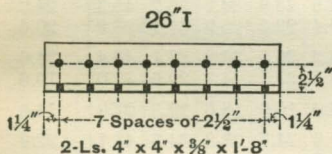
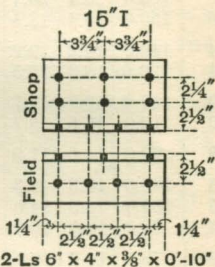
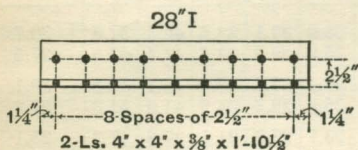
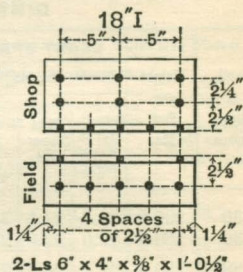
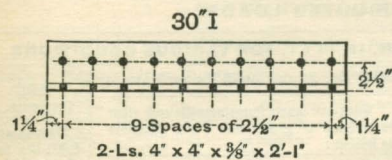

Spacing same in both legs of angles unless shown otherwise.
All holes $\frac{13}{16}$ " diameter for $\frac{3}{4}$ " diameter rivets or bolts.

MINIMUM SPANS, IN FEET, ON WHICH THE CONNECTION ANGLES FOR
BETHLEHEM GIRDER BEAMS
 CAN BE USED FOR GREATEST SAFE UNIFORMLY
 DISTRIBUTED LOADS.

Depth of Beam, Inches.	Weight per Foot, Lbs.	LEAST SPAN, IN FEET, FOR VARIOUS CONDITIONS.								Field Connection. Rivet Shear, 8,000 Lbs. per Square Inch.
		Rivets: Shearing 10,000 Lbs., Bearing 20,000 Lbs. per Square In.								
		Connection to Web of Beam.	Field Connection.	When two beams frame opposite each other to a beam or girder with a web thickness as follows:						
$\frac{9}{16}$ "	$\frac{1}{2}$ "			$\frac{7}{16}$ "	$\frac{3}{8}$ "	$\frac{5}{16}$ "	$\frac{1}{4}$ "			
30	200.0	24.5	24.5	25.7	28.9	33.1	38.6	46.3	57.8	30.7
30	180.0	22.0	22.0	23.0	25.9	29.6	34.5	41.4	51.8	27.5
28	180.0	24.1	24.1	25.2	28.4	32.4	37.8	45.4	56.8	30.1
28	165.0	21.8	21.8	22.8	25.6	29.3	34.2	41.0	51.3	27.2
26	160.0	20.1	20.1	21.0	23.7	27.0	31.5	37.8	47.3	25.1
26	150.0	18.4	18.4	19.3	21.7	24.8	28.9	34.7	43.4	23.0
24	140.0	19.2	19.2	20.1	22.6	25.9	30.2	36.2	45.3	24.0
24	120.0	18.3	16.5	17.3	19.4	22.2	25.9	31.1	38.9	20.6
20	140.0	19.7	19.7	20.6	23.2	26.5	30.9	37.1	46.4	24.6
20	112.0	16.8	15.7	16.4	18.5	21.1	24.7	29.6	37.0	19.6
18	92.0	14.6	11.9	12.4	14.0	16.0	18.6	22.3	27.9	14.8
15	140.0	18.3	18.3	19.2	21.6	24.7	28.8	34.5	43.1	22.9
15	104.0	14.0	14.0	14.7	16.5	18.9	22.0	26.4	33.1	17.5
15	73.0	13.9	10.2	10.6	12.0	13.7	16.0	19.1	23.9	12.7
12	70.0	11.6	10.8	11.4	12.8	14.6	17.0	20.4	25.5	13.5
12	55.0	11.5	8.7	9.1	10.2	11.7	13.7	16.4	20.5	10.9
10	44.0	9.3	5.9	6.2	6.9	7.9	9.3	11.1	13.9	7.4
9	38.0	11.3	7.6	8.0	9.0	10.3	12.0	14.4	18.0	9.5
8	32.5	8.8	5.8	6.0	6.8	7.7	9.0	10.8	13.6	7.2

The greatest value given of the least span for any of the governing conditions is the minimum span for which the connection may be used.

WEIGHTS OF CONNECTION ANGLES FOR GIRDER BEAMS.

Depth of Beam.	Weight of One Connection.	Depth of Beam.	Weight of One Connection.	Depth of Beam.	Weight of One Connection.
30 Inches.	77 Lbs.	20 Inches.	48 Lbs.	10 Inches.	25 Lbs.
28 "	67 "	18 "	41 "	9 "	17 "
26 "	67 "	15 "	32 "	8 "	17 "
24 "	57 "	12 "	25 "		

Weights given do not include rivets for field connections.

**MINIMUM SPANS, IN FEET, ON WHICH THE CONNECTION ANGLES FOR
BETHLEHEM I BEAMS
CAN BE USED FOR GREATEST SAFE UNIFORMLY
DISTRIBUTED LOADS.**

Depth of Beam, Inches.	Weight per Foot, Lbs.	LEAST SPAN, IN FEET, FOR VARIOUS CONDITIONS.								Field Connection. Rivet Shear, 8,000 Lbs. per Square Inch.
		Rivets : Shearing 10,000 Lbs., Bearing 20,000 Lbs. per Square In.								
		Con- nection to Web of Beam.	Field Con- nec- tion.	When two beams frame opposite each other to a beam or girder with a web thickness as follows :						
$\frac{9}{16}$ "	$\frac{1}{2}$ "			$\frac{7}{16}$ "	$\frac{3}{8}$ "	$\frac{5}{16}$ "	$\frac{1}{4}$ "			
30	120.0	23.0	21.1	22.1	24.8	28.4	33.1	39.7	49.7	26.3
28	105.0	22.7	19.2	20.1	22.7	25.9	30.2	36.2	45.3	24.0
26	90.0	22.1	17.3	18.1	20.4	23.3	27.1	32.6	40.7	21.6
24	84.0	21.9	17.1	17.9	20.2	23.1	26.9	32.2	40.3	21.4
24	73.0	22.7	15.0	15.7	17.7	20.2	23.6	28.3	35.4	18.8
20	72.0	20.2	14.7	15.4	17.4	19.9	23.2	27.8	34.8	18.4
20	59.0	18.5	11.8	12.3	13.9	15.9	18.5	22.2	27.8	14.7
18	48.5	16.4	10.7	11.2	12.6	14.4	16.8	20.2	25.2	13.4
15	71.0	12.1	16.0	16.8	18.9	21.6	25.1	30.2	37.7	20.0
15	54.0	11.8	12.3	12.8	14.5	16.5	19.3	23.1	28.9	15.3
15	38.0	12.1	8.9	9.3	10.5	12.0	14.0	16.8	21.0	11.1
12	36.0	10.3	9.0	9.5	10.6	12.2	14.2	17.0	21.3	11.3
12	28.5	10.3	7.2	7.6	8.5	9.8	11.4	13.7	17.1	9.1
10	23.5	8.7	7.4	7.8	8.7	10.0	11.6	14.0	17.5	9.3
9	20.0	6.7	5.7	6.0	6.7	7.7	9.0	10.8	13.5	7.1
8	17.5	5.1	4.3	4.5	5.1	5.8	6.8	8.2	10.2	5.4

The greatest value given of the least span for any of the governing conditions is the minimum span for which the connection may be used.

WEIGHTS OF CONNECTION ANGLES FOR BETHLEHEM I BEAMS.

Depth of Beam.	Weight of One Connection.	Depth of Beam.	Weight of One Connection.	Depth of Beam.	Weight of One Connection.
30 Inches.	46 Lbs.	20 Inches.	28 Lbs.	10 Inches.	12 Lbs.
28 "	41 "	18 "	28 "	9 "	12 "
26 "	37 "	15 "	24 "	8 "	12 "
24 "	32 "	12 "	18 "		

Weights given do not include rivets for field connections.

CAST IRON SEPARATORS FOR
BETHLEHEM GIRDER BEAMS.

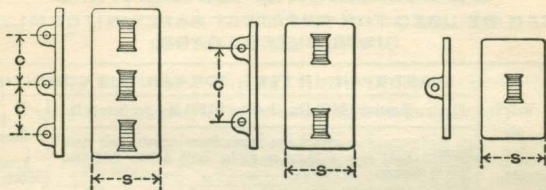

Separators for 18 to 30 inch beams are $\frac{5}{8}$ inch metal.
Separators for 8 to 15 inch beams are $\frac{1}{2}$ inch metal.

SEPARATORS WITH THREE BOLTS.

DESIGNATION OF BEAM.			DISTANCES.			BOLTS.		WEIGHTS, IN POUNDS.			
Section Number.	Depth, Inches.	Weight per Foot, Pounds.	Out to Out of Flanges of Beams, Inches.	Center to Center of Beams, Inches.	Width of Separator, Inches. S	Center to Center, Inches. C	Length, Inches.	Separators.		Bolts and Nuts.	
								Separator for Additional Spread of Beams, S	Increase for 1" Additional Spread of Beams.	Bolts and Nuts for Width S	Increase for 1" Additional Spread of Beams.
G30 a	30	200.0	30 $\frac{3}{4}$	15 $\frac{3}{4}$	15	10	17 $\frac{1}{2}$	73.0	4.50	7.7	.375
G30	30	180.0	26 $\frac{3}{4}$	13 $\frac{3}{4}$	13	10	15 $\frac{1}{2}$	64.5	4.50	7.0	.375
G28 a	28	180.0	29 $\frac{3}{8}$	15	14 $\frac{1}{4}$	7 $\frac{1}{2}$	16 $\frac{3}{4}$	65.0	4.15	7.4	.375
G28	28	165.0	25 $\frac{3}{4}$	13 $\frac{1}{4}$	12 $\frac{5}{8}$	7 $\frac{1}{2}$	15	59.1	4.15	6.8	.375
G26 a	26	160.0	27 $\frac{7}{8}$	14 $\frac{1}{4}$	13 $\frac{5}{8}$	7 $\frac{1}{2}$	16	59.0	3.85	7.1	.375
G26	26	150.0	24 $\frac{3}{4}$	12 $\frac{3}{4}$	12 $\frac{1}{2}$	7 $\frac{1}{2}$	14 $\frac{1}{2}$	53.0	3.85	6.6	.375

SEPARATORS WITH TWO BOLTS.

G24 a	24	140.0	26 $\frac{3}{4}$	13 $\frac{3}{4}$	13 $\frac{1}{8}$	12 $\frac{1}{2}$	15 $\frac{1}{4}$	50.0	3.50	4.6	.25
G24	24	120.0	24 $\frac{3}{4}$	12 $\frac{3}{4}$	12 $\frac{1}{4}$	12 $\frac{1}{2}$	14 $\frac{1}{4}$	47.0	3.50	4.3	.25
G20 a	20	140.0	25 $\frac{1}{2}$	13	12 $\frac{3}{8}$	10	14 $\frac{3}{4}$	39.0	2.80	4.5	.25
G20	20	112.0	24 $\frac{1}{2}$	12 $\frac{1}{2}$	12	10	14	38.0	2.80	4.3	.25
G18	18	92.0	23 $\frac{1}{2}$	12	11 $\frac{1}{2}$	10	13 $\frac{1}{2}$	34.0	2.60	4.2	.25
G15 b	15	140.0	24	12 $\frac{1}{4}$	11 $\frac{3}{8}$	7 $\frac{1}{2}$	14	22.0	1.50	4.3	.25
G15 a	15	104.0	23	11 $\frac{3}{4}$	11 $\frac{1}{8}$	7 $\frac{1}{2}$	13 $\frac{1}{2}$	22.0	1.60	4.2	.25
G15	15	73.0	21 $\frac{1}{2}$	11	10 $\frac{1}{2}$	7 $\frac{1}{2}$	12 $\frac{1}{2}$	21.0	1.60	4.0	.25
G12 a	12	70.0	20 $\frac{1}{2}$	10 $\frac{1}{2}$	10	5	12	17.5	1.30	3.8	.25
G12	12	55.0	20 $\frac{1}{8}$	10 $\frac{3}{8}$	10	5	11 $\frac{3}{4}$	17.5	1.30	3.8	.25

SEPARATORS WITH ONE BOLT.

G10	10	44.0	18 $\frac{1}{2}$	9 $\frac{1}{2}$	9 $\frac{1}{8}$		10 $\frac{3}{4}$	11.0	1.10	1.8	.125
G9	9	38.0	17 $\frac{1}{2}$	9	8 $\frac{3}{4}$		10 $\frac{1}{4}$	10.0	1.00	1.7	.125
G8	8	32.5	16 $\frac{1}{2}$	8 $\frac{1}{2}$	8 $\frac{1}{4}$		9 $\frac{3}{4}$	8.0	.85	1.7	.125

All bolts $\frac{3}{4}$ inch diameter.

CAST IRON SEPARATORS FOR
BETHLEHEM I BEAMS.

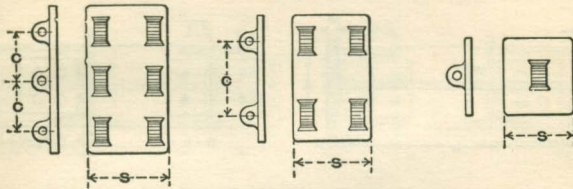

Separators for 18 to 30 inch beams are $\frac{5}{8}$ inch metal.
Separators for 8 to 15 inch beams are $\frac{1}{2}$ inch metal.

SEPARATORS WITH THREE BOLTS.

DESIGNATION OF BEAM.			DISTANCES.			BOLTS.		WEIGHTS, IN POUNDS.			
Section Number.	Depth, Inches.	Weight per Foot, Pounds.	Out to Out of Flanges of Beams, Inches.	Center to Center of Beams, Inches.	Width of Separator, Inches. S	Center to Center, Inches. C	Length, Inches.	Separators.		Bolts and Nuts.	
								Separator for Width S	Increase for 1" Additional Spread of Beams.	Bolts and Nuts for Width S	Increase for 1" Additional Spread of Beams.
B30	30	120.0	21 $\frac{3}{4}$	11 $\frac{1}{4}$	10 $\frac{3}{4}$	10	12 $\frac{3}{4}$	50.1	4.50	6.0	.375
B28	28	105.0	20 $\frac{5}{8}$	10 $\frac{5}{8}$	10 $\frac{1}{8}$	7 $\frac{1}{2}$	12	43.9	4.15	5.7	.375
B26	26	90.0	19 $\frac{5}{8}$	10 $\frac{1}{8}$	9 $\frac{5}{8}$	7 $\frac{1}{2}$	11 $\frac{1}{2}$	39.3	3.85	5.5	.375

SEPARATORS WITH TWO BOLTS.

B24 a	24	84.0	19	9 $\frac{3}{4}$	9 $\frac{1}{4}$	12 $\frac{1}{2}$	11 $\frac{1}{4}$	35.1	3.65	3.6	.25
B24	24	73.0	18 $\frac{5}{8}$	9 $\frac{5}{8}$	9 $\frac{1}{4}$	12 $\frac{1}{2}$	11	35.1	3.65	3.6	.25
B20 a	20	72.0	18 $\frac{1}{8}$	9 $\frac{3}{8}$	9	10	10 $\frac{3}{4}$	28.2	3.00	3.5	.25
B20	20	59.0	16 $\frac{5}{8}$	8 $\frac{3}{8}$	8 $\frac{1}{4}$	10	10	26.1	3.00	3.4	.25
B18	18	48.5	15 $\frac{1}{2}$	8	7 $\frac{5}{8}$	10	9 $\frac{1}{4}$	22.1	2.70	3.2	.25
B15 b	15	71.0	15 $\frac{1}{2}$	8	7 $\frac{1}{2}$	7 $\frac{1}{2}$	9 $\frac{1}{2}$	13.1	1.65	3.2	.25
B15 a	15	54.0	14 $\frac{1}{2}$	7 $\frac{1}{2}$	7	7 $\frac{1}{2}$	9	12.3	1.65	3.1	.25
B15	15	38.0	14	7 $\frac{1}{4}$	7	7 $\frac{1}{2}$	8 $\frac{1}{2}$	13.3	1.80	3.0	.25
B12 a	12	36.0	13 $\frac{1}{8}$	6 $\frac{3}{4}$	6 $\frac{3}{8}$	5	8	9.1	1.30	2.8	.25
B12	12	28.5	12 $\frac{5}{8}$	6 $\frac{1}{2}$	6 $\frac{1}{4}$	5	7 $\frac{3}{4}$	9.0	1.30	2.8	.25

SEPARATORS WITH ONE BOLT.

B10	10	23.5	12 $\frac{1}{8}$	6 $\frac{1}{4}$	6		7 $\frac{1}{2}$	7.5	1.10	1.4	.125
B9	9	20.0	11 $\frac{1}{4}$	5 $\frac{3}{4}$	5 $\frac{1}{2}$		7	6.4	1.00	1.3	.125
B8	8	17.5	10 $\frac{7}{8}$	5 $\frac{5}{8}$	5 $\frac{3}{8}$		6 $\frac{3}{4}$	5.5	.85	1.3	.125

All bolts $\frac{3}{4}$ inch diameter.

DETAIL DIMENSIONS FOR
BETHLEHEM I BEAMS.

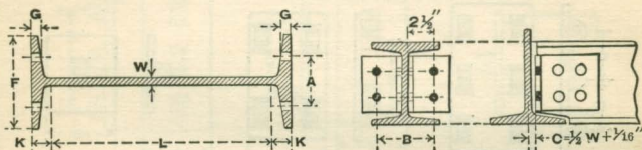

Section Number.	Depth of Beam, Inches.	Weight per Foot, Lbs.	DIMENSIONS, IN INCHES.								Maximum Rivet or Bolt, Inch.
			F	W	L	K	G	A	B	C	
B30	30	120.0	10 1/2	3 5/8	26 7/16	1 2 5/8	2 9/8	6 1/2	5 9/16	5 1/8	1
B28	28	105.0	10	1/2	24 1 1/16	1 2 1/8	2 7/8	6	5 1/2	5 1/8	1
B26	26	90.0	9 1/2	1 5/8	23	1 1/2	2 5/8	5 1/2	5 7/16	5 1/8	1
B24 a	24	84.0	9 1/4	1 5/8	21	1 1/2	3/4	5 1/4	5 7/16	5 1/8	7/8
B24	24	83.0	9 1/8	3 3/4	21 5/16	1 1 1/8	1 1/8	5 1/4	5 1/2	5 1/8	7/8
	24	73.0	9	2 5/8	21 5/16	1 1 1/8	1 1/8	5 1/4	5 3/8	1/4	7/8
B20 a	20	82.0	8 5/8	3 7/8	17 1/8	1 7/16	3/4	5	5 9/16	3/8	7/8
	20	72.0	8 3/4	7/8	17 1/8	1 7/16	3/4	5	5 7/16	1/4	7/8
B20	20	69.0	8 9/16	3 3/8	17 1/2	1 1/4	5/8	4 1/2	5 1/2	5 1/8	7/8
	20	64.0	8 5/16	2 9/16	17 1/2	1 1/4	5/8	4 1/2	5 1/16	5 1/8	7/8
	20	59.0	8	3/8	17 1/2	1 1/4	5/8	4 1/2	5 3/8	1/4	7/8
B18	18	59.0	7 4 3/4	1/2	15 3/4	1 1/8	9/16	4 1/4	5 1/2	5 1/8	7/8
	18	54.0	7 1 9/16	1 3/8	15 3/4	1 1/8	9/16	4 1/4	5 7/16	1/4	7/8
	18	52.0	7 9/16	3/8	15 3/4	1 1/8	9/16	4 1/4	5 3/8	1/4	7/8
	18	48.5	7 1/2	2 1/4	15 3/4	1 1/8	9/16	4 1/4	5 5/16	1/4	7/8

DETAIL DIMENSIONS FOR
BETHLEHEM I BEAMS.

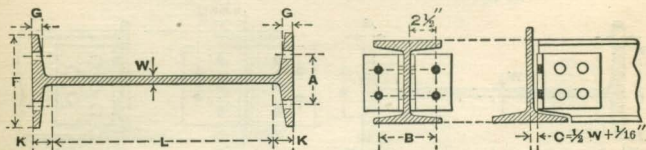

Section Number.	Depth of Beam, Inches.	Weight per Foot, Lbs.	DIMENSIONS, IN INCHES									Maximum Rivet or Bolt, Inch.
			F	W	L	K	G	A	B	C		
B15 b	15	71.0	7 1/2	3 3/4	11 3/4	1 5/8	1 5/8	4 1/4	5 1/2	5/16	7/8	
B15 a	15	64.0	7 1 3/8	3 9/4	12 5/16	1 1 1/2	3/4	4	5 5/8	3/8	7/8	
	15	54.0	7	1 3/2	12 5/16	1 1 1/2	2 3/4	4	5 7/8	1/4	7/8	
B15	15	46.0	6 1 3/8	7/8	12 7/8	1 1/8	1 1/2	3 3/4	5 7/8	5/16	7/8	
	15	41.0	6 3 3/8	1 1/2	12 7/8	1 1/8	1 7/8	3 3/4	5 5/8	1/4	7/8	
	15	38.0	6 3 1/2	1 9/4	12 7/8	1 1/8	1 3/2	3 3/4	5 5/8	3/8	7/8	
B12 a	12	36.0	6 1 9/4	5/8	9 7/8	1 1/8	9/16	3 1/2	5 5/8	3/8	3/4	
B12	12	32.0	6 3/8	2 1/4	10 3/16	2 9/2	7/8	3 1/2	5 5/8	1/4	3/4	
	12	28.5	6 1/8	1/4	10 3/16	2 9/2	7/8	3 1/2	5 1/4	3/16	3/4	
B10	10	28.5	5 6 3/4	2 5/4	8 3/8	1 3/8	3/8	3 1/4	5 3/8	1/4	3/4	
	10	23.5	5 2 7/2	1/4	8 3/8	1 3/8	3/8	3 1/4	5 1/4	3/16	3/4	
B9	9	24.0	5 9/8	2 3/4	7 1/2	3/4	3/8	3	5 3/8	1/4	3/4	
	9	20.0	5 1 7/8	1/4	7 1/2	3/4	3/8	3	5 1/4	3/16	3/4	
B8	8	19.5	5 2 1/4	2 1/4	6 5/8	1 1/8	5/16	2 3/4	5 5/8	1/4	3/4	
	8	17.5	5 1/4	1/4	6 5/8	1 1/8	5/16	2 3/4	5 1/4	3/16	3/4	

DETAIL DIMENSIONS FOR
BETHLEHEM GIRDER BEAMS.

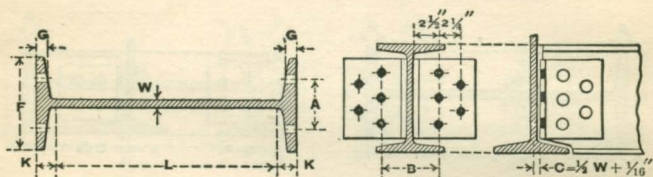

Section Number.	Depth of Beam, Inches.	Weight per Foot, Lbs.	DIMENSIONS, IN INCHES.								Maximum Rivet or Bolt, Inch.
			F	W	L	K	G	A	B	C	
G30 a	30	200.0	15	$\frac{3}{4}$	$25\frac{3}{16}$	$2\frac{13}{16}$	$1\frac{1}{8}$	11	$5\frac{3}{4}$	$\frac{7}{8}$	1
G30	30	180.0	13	$\frac{11}{8}$	$25\frac{3}{16}$	$2\frac{13}{16}$	$1\frac{7}{8}$	9	$5\frac{11}{8}$	$\frac{7}{8}$	1
G28 a	28	180.0	$14\frac{11}{16}$	$\frac{11}{8}$	$23\frac{3}{8}$	$2\frac{5}{16}$	$1\frac{3}{2}$	$10\frac{1}{4}$	$5\frac{11}{8}$	$\frac{7}{8}$	1
G28	28	165.0	$12\frac{1}{2}$	$\frac{23}{16}$	$23\frac{3}{8}$	$2\frac{5}{16}$	$1\frac{3}{8}$	$8\frac{1}{2}$	$5\frac{11}{8}$	$\frac{3}{8}$	1
G26 a	26	160.0	$13\frac{9}{16}$	$\frac{5}{8}$	$21\frac{5}{8}$	$2\frac{3}{16}$	$1\frac{1}{8}$	$9\frac{1}{2}$	$5\frac{5}{8}$	$\frac{3}{8}$	1
G26	26	150.0	12	$\frac{5}{8}$	$21\frac{5}{8}$	$2\frac{3}{16}$	$1\frac{1}{8}$	8	$5\frac{5}{8}$	$\frac{3}{8}$	1
G24 a	24	140.0	13	$\frac{13}{16}$	20	2	$\frac{3}{16}$	9	$5\frac{5}{8}$	$\frac{3}{8}$	1
G24	24	120.0	12	$\frac{17}{16}$	$20\frac{1}{4}$	$1\frac{7}{8}$	$\frac{23}{16}$	8	$5\frac{1}{2}$	$\frac{5}{8}$	1
G20 a	20	140.0	$12\frac{1}{2}$	$\frac{41}{16}$	$15\frac{11}{16}$	$2\frac{5}{16}$	$1\frac{1}{8}$	$8\frac{1}{2}$	$5\frac{5}{8}$	$\frac{3}{8}$	1
G20	20	112.0	12	$\frac{35}{16}$	$16\frac{3}{8}$	$1\frac{13}{16}$	$\frac{7}{8}$	8	$5\frac{9}{16}$	$\frac{5}{8}$	1
G18	18	92.0	$11\frac{1}{2}$	$\frac{31}{16}$	$14\frac{3}{4}$	$1\frac{5}{8}$	$\frac{23}{16}$	$7\frac{1}{2}$	$5\frac{1}{2}$	$\frac{5}{8}$	1
G15 b	15	140.0	$11\frac{3}{4}$	$\frac{51}{16}$	$10\frac{1}{8}$	$2\frac{7}{8}$	$1\frac{3}{2}$	$7\frac{3}{4}$	$5\frac{13}{8}$	$\frac{7}{8}$	1
G15 a	15	104.0	$11\frac{1}{4}$	$\frac{19}{16}$	$11\frac{1}{8}$	$1\frac{5}{8}$	$\frac{15}{8}$	$7\frac{1}{4}$	$5\frac{5}{8}$	$\frac{3}{8}$	1
G15	15	73.0	$10\frac{1}{2}$	$\frac{7}{8}$	$12\frac{1}{16}$	$1\frac{11}{16}$	$\frac{11}{8}$	$6\frac{1}{2}$	$5\frac{7}{8}$	$\frac{1}{4}$	1
G12 a	12	70.0	10	$\frac{15}{16}$	9	$1\frac{1}{2}$	$\frac{3}{4}$	6	$5\frac{7}{8}$	$\frac{5}{8}$	1
G12	12	55.0	$9\frac{3}{4}$	$\frac{3}{8}$	$9\frac{1}{2}$	$1\frac{1}{4}$	$\frac{13}{16}$	6	$5\frac{3}{8}$	$\frac{1}{4}$	1
G10	10	44.0	9	$\frac{5}{16}$	$7\frac{3}{4}$	$1\frac{1}{8}$	$\frac{17}{16}$	$5\frac{1}{2}$	$5\frac{5}{16}$	$\frac{3}{16}$	$\frac{7}{8}$
G9	9	38.0	$8\frac{1}{2}$	$\frac{13}{16}$	$6\frac{7}{8}$	$1\frac{1}{16}$	$\frac{15}{16}$	$5\frac{1}{4}$	$5\frac{5}{16}$	$\frac{3}{16}$	$\frac{7}{8}$
G8	8	32.5	8	$\frac{19}{64}$	6	1	$\frac{7}{16}$	5	$5\frac{5}{16}$	$\frac{3}{16}$	$\frac{7}{8}$

TYPES OF H COLUMN DETAILS.

Fig. 1

Fig. 2

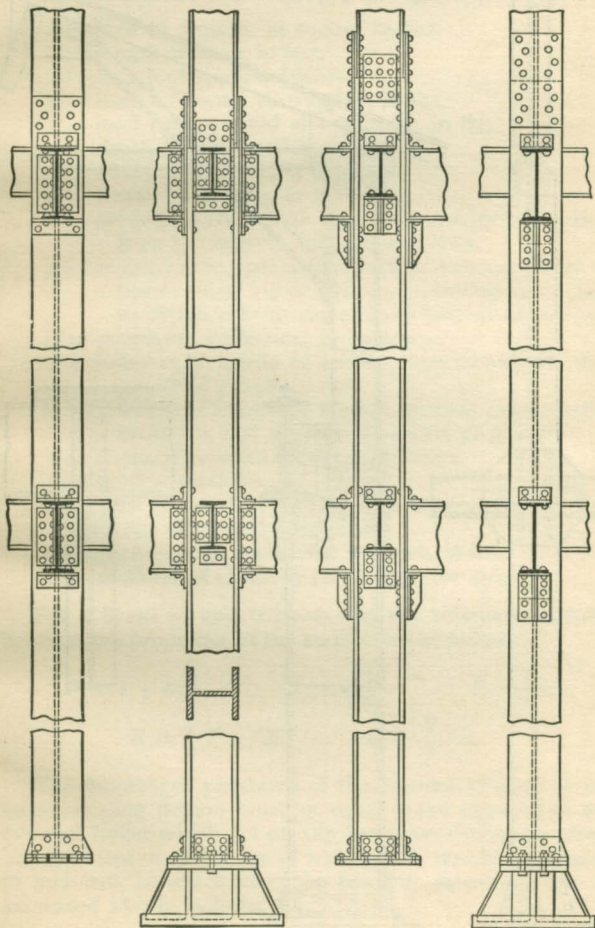

**SHOP BUILDING CONSTRUCTION
WITH BETHLEHEM WIDE FLANGE BEAMS USED FOR
COLUMNS AND CRANE GIRDERS.**

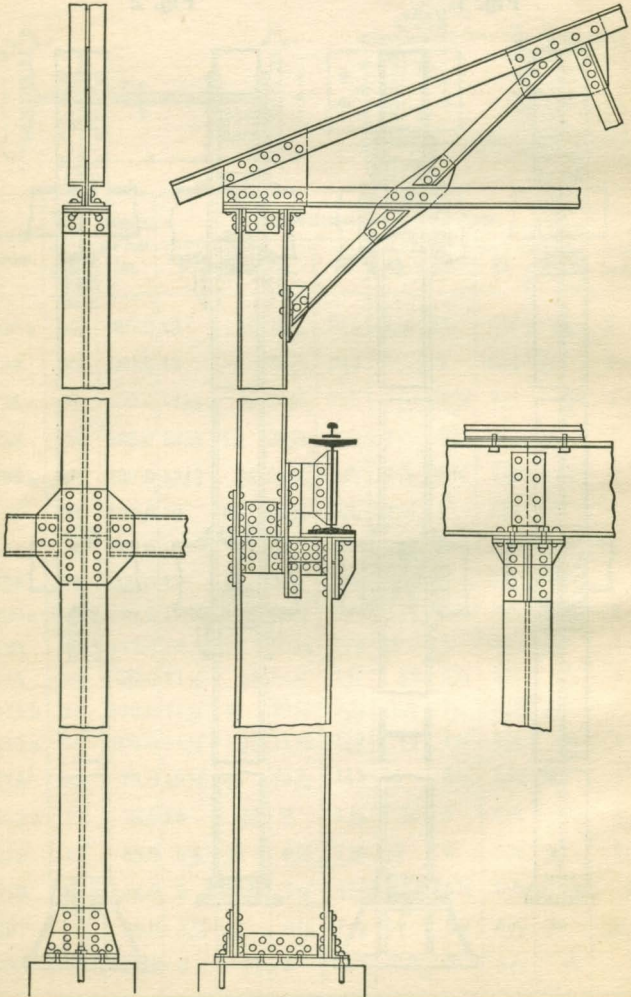

NOTES ON THE STRENGTH AND DEFLECTION OF BEAMS.

The general notation employed throughout is as follows :

a = area of section, in square inches.

L = length of span, in feet.

l = length of span, in inches.

W = load uniformly distributed, in lbs.

P = load concentrated at any point, in lbs.

d = depth of cross-section, in inches.

M = bending moment, in foot-lbs.

m = bending moment, in inch-lbs.

n = greatest distance of center of gravity of section from top or from bottom, in inches.

f = stress, in lbs., per square inch in extreme fibers of beam, either top or bottom, according as n refers to distance from top or from bottom of section.

D = maximum deflection, in inches.

I = moment of inertia of section, neutral axis through center of gravity.

I'' = moment of inertia of section, neutral axis parallel to above, but not through center of gravity.

z = distance between these neutral axes.

S = section modulus.

R = least moment of resistance of section, in inch-lbs.

r = radius of gyration, in inches.

C = coefficient of transverse strength, in lbs.

E = modulus of elasticity (29,000,000 for steel).

For a beam of any cross-section the relations existing between the properties of the section are as follows :

$$I'' = I + az^2. \quad r = \sqrt{\frac{I}{a}}. \quad S = \frac{I}{n}.$$

$$R = \frac{I}{n} f = fS. \quad C = \frac{2}{3} fS.$$

The moment of resistance of the internal stresses of the beam resisting flexure must be equal to the moment of the external forces which act on the beam producing bending. The moment of resistance of a section is usually expressed in inch-lbs., in which case the bending moment must be expressed also in inch-lbs.

The relations existing between bending moment, moment of resistance, section modulus and stress per square inch are expressed thus :

$$m = R. \qquad S = \frac{m}{f}.$$

$$m = fS. \qquad f = \frac{m}{S}.$$

When the bending moment is in foot-lbs., the following relations are useful :

$$C = 8M. \qquad M = \frac{C}{8}.$$

If W is a uniformly distributed load in lbs., and the span, L , is taken in feet, then :

$$C = WL. \qquad W = \frac{C}{L}.$$

The last two formulas are convenient. To find the safe uniformly distributed load in lbs. for any section, it is only necessary to divide its coefficient of strength by the span in feet. If the uniformly distributed load in lbs. is given, multiply it by the span in feet and the result is the coefficient of strength required by the section.

On the next page formulas are given for finding bending moments, safe loads and deflections for beams loaded and supported in usual ways. Bending moments will be in foot-lbs. or inch-lbs. according as the lengths are taken in feet or inches. To obtain deflection in inches the lengths must be taken in inches.

For illustration, take a center load of 30,000 lbs. on a span of 20 feet :

$$M = \frac{30,000 \times 20}{4} = 150,000 \text{ foot-lbs.}$$

$$C = 8M = 8 \times 150,000 = 1,200,000.$$

The nearest beam is a 20" Bethlehem I beam, weighing 59 lbs. per foot, which has a coefficient of 1,250,300.

If the bending moment had been taken in inch-lbs., then

$$m = \frac{30,000 \times 240}{4} = 1,800,000 \text{ inch-lbs.}$$

$$S = \frac{m}{f} = 1,800,000 \div 16,000 = 112.5$$

The beam selected by the first method has a section modulus of 117.2, which is the nearest to that required. Both methods of calculation give identical results.

BENDING MOMENTS AND DEFLECTIONS OF BEAMS FOR USUAL METHODS OF LOADING.

P or W = total load
 l = length of beam

I = moment of inertia
 E = modulus of elasticity

- (1.) Beam fixed at one end and loaded at the other.

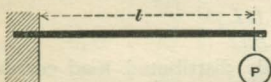

Safe load = $\frac{1}{8}$ that given in tables.
Maximum bending moment at point of support = Pl .
Maximum shear at point of support = P .

$$\text{Deflection} = \frac{Pl^3}{3EI}$$

- (2.) Beam fixed at one end and uniformly loaded.

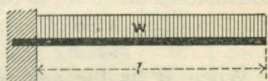

Safe load = $\frac{1}{4}$ that given in tables.
Maximum bending moment at point of support = $\frac{Wl}{2}$.
Maximum shear at point of support = W .

$$\text{Deflection} = \frac{Wl^3}{8EI}$$

- (3.) Beam supported at both ends, single load in the middle.

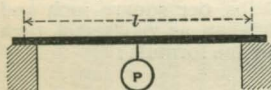

Safe load = $\frac{1}{2}$ that given in tables.
Maximum bending moment at middle of beam = $\frac{Pl}{4}$.

Maximum shear at points of support = $\frac{1}{2}P$.

$$\text{Deflection} = \frac{Pl^3}{48EI}$$

- (4.) Beam supported at both ends and uniformly loaded.

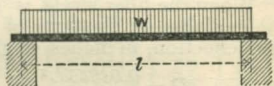

Safe load = that given in tables
Maximum bending moment at middle of beam = $\frac{Wl}{8}$.

Maximum shear at points of support = $\frac{1}{2}W$.

$$\text{Deflection} = \frac{5Wl^3}{384EI}$$

- (5.) Beam supported at both ends, single unsymmetrical load.

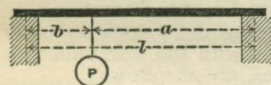

Safe load = that given in tables $\times \frac{l^2}{8ab}$.

Maximum bending moment under load = $\frac{Pab}{l}$.

Maximum shears: at support, a end = $\frac{Pb}{l}$; at other support = $\frac{Pa}{l}$.

$$\text{Max. Deflec.} = \frac{Pab(2l-a)}{9EI} \sqrt{\frac{1}{3}a(2l-a)}$$

- (6.) Beam supported at both ends, two symmetrical loads.

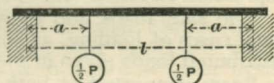

Safe load = that given in tables $\times \frac{l}{4a}$.

Maximum bending moment between loads = $\frac{1}{2}Pa$.

Maximum shear between load and nearer support = $\frac{1}{2}P$.

$$\text{Max. Deflection} = \frac{Pa}{48EI} (3l^2 - 4a^2)$$

DEFLECTION OF STEEL BEAMS AND GIRDERS UNDER TRANSVERSE LOADS.

Using the notation given on page 99, the deflection, in inches, of a steel beam or other section under a uniformly distributed load of W , in lbs., is found from the formula,

$$D = \frac{5}{384} \frac{WL^3}{EI} = \frac{5}{384} \frac{W(12L)^3}{EI}.$$

When W is the safe uniformly distributed load corresponding to a coefficient of strength C , the following relations exist between W and C and the properties of the shape :

$$W = \frac{C}{L}, \quad \text{and} \quad C = \frac{2}{3} f S = \frac{2}{3} f \frac{I}{n}.$$

Substituting these values in the above formula, then,

$$D = \frac{15fL^2}{nE}$$

When the fiber stress is 16,000 lbs. per square inch and the modulus of elasticity of steel taken as 29,000,000, then the deflection, in inches, is given by the formula :

$$D = \frac{0.01655L^2}{2n}.$$

In the case of a beam, girder or other section symmetrical about its neutral axis, $2n$ equals the depth of the beam. The deflection, in inches, of such a section under its safe uniformly distributed load which produces a fiber stress of 16,000 lbs. per square inch is given by the simple formula,

$$D = \frac{0.01655L^2}{d}, \quad \text{or very nearly} = \frac{1}{60} \frac{L^2}{d}.$$

The table on the opposite page gives the value of the expression $0.01655L^2$ for spans from 1 foot to 60 feet.

The safe loads and corresponding deflections for other usual cases of loading, as compared with the safe uniformly distributed loads given in the tables, are as follows :

Beam supported at both ends and loaded with a single load concentrated at center of span. Safe load = $\frac{1}{2}$ tabular load. Deflection = $\frac{8}{15}$.

Cantilever beam, fixed at one end and unsupported at the other, uniformly loaded. Safe load = $\frac{1}{4}$ tabular load. Deflection = $2\frac{4}{15}$.

Cantilever beam, fixed at one end and unsupported at the other, single load concentrated at free end. Safe load = $\frac{1}{8}$ tabular load. Deflection = $3\frac{2}{15}$.

DEFLECTION COEFFICIENTS

FOR UNIFORMLY DISTRIBUTED LOADS.

FIBER STRESS, 16,000 LBS. PER SQUARE INCH.

Length of Span, Feet.	Deflection Coefficient.	Length of Span, Feet.	Deflection Coefficient.	Length of Span, Feet.	Deflection Coefficient.	Length of Span, Feet.	Deflection Coefficient.
1	.0166	16	4.2372	31	15.9062	46	35.0234
2	.0662	17	4.7834	32	16.9490	47	36.5628
3	.1490	18	5.3628	33	18.0248	48	38.1352
4	.2648	19	5.9752	34	19.1338	49	39.7407
5	.4138	20	6.6207	35	20.2759	50	41.3793
6	.5959	21	7.2993	36	21.4510	51	43.0510
7	.8110	22	8.0110	37	22.6593	52	44.7559
8	1.0593	23	8.7559	38	23.9007	53	46.4938
9	1.3407	24	9.5338	39	25.1752	54	48.2648
10	1.6552	25	10.3448	40	26.4828	55	50.0690
11	2.0028	26	11.1890	41	27.8234	56	51.9062
12	2.3834	27	12.0662	42	29.1972	57	53.7766
13	2.7972	28	12.9766	43	30.6041	58	55.6800
14	3.2441	29	13.9200	44	32.0441	59	57.6166
15	3.7241	30	14.8966	45	33.5172	60	59.5862

These coefficients furnish a convenient means of finding the deflection of steel sections under their uniformly distributed safe loads for a maximum fiber stress of 16,000 lbs. per square inch.

To find the deflection of a steel beam, girder or other section which is symmetrical about its neutral axis, under the above condition of loading, divide the deflection coefficient found in the above table for the given span by the depth of the beam in inches. The quotient will be the deflection in inches.

To find the deflection of an angle or other section which is not symmetrical about its neutral axis under the above condition of loading, divide the deflection coefficient in the table for the given span by twice the greatest distance, in inches, of the neutral axis from the outside fiber in the direction of bending.

Under uniformly distributed loading corresponding to other intensities of stress the deflection can be found by simple proportion. Thus, for a uniformly distributed load producing a fiber stress of 12,000 lbs. per square inch the deflection will be $\frac{12000}{16000}$ or $\frac{3}{4}$ of that found by the use of the above coefficients.

SPACING OF TIE RODS.

Tie rods are used in fire proof floors to resist the thrust of the floor arches and to hold the steel beams in position laterally. Rods of $\frac{3}{4}$ inch diameter are generally employed for this purpose. They should be placed as near as possible in the line of thrust of the arch, usually 3 inches above the bottom of the beams.

The proper spacing of tie rods is determined by two considerations. The stress on the net area of the rod produced by the thrust of the arch must not exceed 15,000 lbs. per square inch. Also the lateral stress produced in the beams or channels by the thrust of the arches must not be excessive.

The spacing required to satisfy the first of these requirements is found in the following manner:

Let t = thrust of arch, in lbs. per lineal foot.

r = rise of arch, in inches.

l = distance between beams, or span of arch, in feet.

w = load per square foot, in lbs.

a = net area of tie rod, in square inches.

d = distance between tie rods, in feet.

$$\text{Then, } t = \frac{3wl^2}{2r}, (1); \text{ and } d = \frac{10,000ar}{wl^2}, (2)$$

The net areas, in square inches, of the usual sizes of tie rods are as follows:

Diameter of rod	= $\frac{5}{8}$ "	$\frac{3}{4}$ "	$\frac{7}{8}$ "	1"
Net area,	$a = 0.20$	0.30	0.42	0.55

For $\frac{3}{4}$ inch rods, the size generally used, and for a total load of 150 lbs. per square foot the spacing given by formula (2) becomes $d = 20r \div l^2$.

The effective rise of flat tile arches may be assumed as 2 inches less than the depth of the arch.

The maximum spacing, in feet, of $\frac{3}{4}$ inch tie rods for a total load of 150 lbs. per square foot, producing a stress of 15,000 lbs. per square inch in net area of rods is given in the following table:

MAXIMUM SPACING, IN FEET, OF $\frac{3}{4}$ " TIE RODS FOR A TOTAL LOAD OF 150 LBS. PER SQUARE FOOT.

Span of Arch, Feet.	EFFECTIVE RISE OF ARCH.							
	3"	4"	5"	6"	7"	8"	9"	10"
4	3.7	5.0	6.2	7.5	8.7	10.0	11.2	12.5
5	2.4	3.2	4.0	4.8	5.6	6.4	7.2	8.0
6		2.2	2.8	3.3	3.9	4.4	5.0	5.5
7			2.0	2.4	2.9	3.3	3.7	4.1
8					2.2	2.5	2.8	3.1

It may be necessary to decrease the distance between tie rods given in the preceding table or found from formula (2), in order to satisfy the second requirement that the lateral stress in the beams or channels produced by the thrust of the arches may not be excessive.

Let I' = moment of inertia of beam or channel, side-ways.

b = width of flange of beam or channel, in inches.

x = distance, in inches, of neutral axis from back of channel.

f = fiber stress produced by thrust of arch, in lbs., per square inch.

The beams or channels may be considered as continuous, in which case the stress produced by flexure and the corresponding spacing of rods are given by the following formulas :

$$\text{For Beams, } f = \frac{td^2b}{2I'}, \quad (3); \quad \text{and} \quad d = \sqrt{\frac{2fI'}{tb}}, \quad (4)$$

$$\text{For Channels, } f = \frac{td^2(b-x)}{I'}, \quad (5); \quad \text{and} \quad d = \sqrt{\frac{fI'}{t(b-x)}}, \quad (6)$$

Where the thrusts of adjacent arches are opposed to each other, as in the interior beams of a floor, the thrust t in these formulas may be taken only for the live loads. The sum of the stresses produced by lateral thrust and vertical loading should not exceed 20,000 lbs. per square inch. As the vertical loading in building construction is usually allowed to produce a fiber stress of 16,000 lbs. per square inch, the lateral stress must therefore be limited to 4000 lbs. per square inch. In such case the fiber stress, f , in formula (4) is to be taken as 4000.

For exterior arches along walls, or around openings, the thrust t must be taken for the full live and dead load.

Channels will be found to require a greater number of tie rods than interior beams, and it may be advisable in some instances to use a beam for a skewback instead of a channel.

If formulas (4) and (6) give a greater distance between rods than is obtained by the use of formula (2), the value given by the latter is to be used, as the stress on the tie rod itself must not exceed its safe limit.

Beams must be held laterally at intervals not greater than twenty times the width of their flanges, otherwise their safe loads as given the tables must be reduced in the proportion given in the table at the bottom of page 56.

BEARING PLATES.

Steel bearing plates are used under the ends of steel beams resting on walls to distribute the pressure on the latter. The plate must be of a sufficient size so that the allowable safe pressure on the wall will not be exceeded.

For good brickwork laid in cement mortar, capable of sustaining a safe pressure of 200 lbs. per square inch, the table below gives standard sizes of bearing plates which will suffice in general on ordinary spans for I beams up to 24 inches in depth.

STANDARD BEARING PLATES FOR I BEAMS.

Depth of Beam, Inches.	Bearing on Wall, Inches.	SIZE OF BEARING PLATES.			Safe End Reaction at 200 Lbs. per Sq. In., Tons.	Weight of Bearing Plate, Lbs.
		Length, Inches.	Width, Inches.	Thickness, Inches.		
24	16	16	16	$\frac{7}{8}$	25.6	64
20	16	16	15	$\frac{7}{8}$	24.0	60
18	16	16	14	$\frac{7}{8}$	22.4	56
15	12	12	14	$\frac{7}{8}$	16.8	42
12	12	12	12	$\frac{3}{4}$	14.4	31
10	10	10	10	$\frac{5}{8}$	10.0	18
9	8	8	9	$\frac{1}{2}$	7.2	11
8	8	8	8	$\frac{1}{2}$	6.4	9
7	8	8	8	$\frac{1}{2}$	6.4	9
6	6	6	6	$\frac{1}{2}$	3.6	5
and less						

Larger I beams, girder beams and girders will require plates of increased size. In such special cases the size of the bearing plate must be determined by the area required to distribute the pressure and its thickness then obtained by the following formula :

$$t = \frac{1}{2}(w-b) \sqrt{\frac{3p}{f}},$$

in which,

t = thickness of plate, in inches.

w = width of plate perpendicular to beam, in inches.

b = width of flange of beam, in inches.

p = allowable pressure on wall, in lbs. per square inch.

f = allowable fiber stress in plate, in lbs. per square inch.

For an allowable stress of 16,000 lbs. per square inch the thickness of the plate required can be obtained for various pressures by multiplying $\frac{1}{2}(w-b)$, or the cantilever projection of the plate, by the following coefficients :

Pressure, lbs. sq. in.,	100	150	200	350	500
Coefficient,.....	0.137	0.168	0.194	0.256	0.306

BEARING VALUES OF PLATES, IN TONS OF 2000 LBS.

Size of Plate, Inches.	ALLOWABLE PRESSURE PER SQUARE INCH.					Size of Plate, Inches.	ALLOWABLE PRESSURE PER SQUARE INCH.				
	100 Lbs.	150 Lbs.	200 Lbs.	350 Lbs.	500 Lbs.		100 Lbs.	150 Lbs.	200 Lbs.	350 Lbs.	500 Lbs.
6x 6	1.8	2.7	3.6	6.3	9.0	14x14	9.8	14.7	19.6	34.3	49.0
6x 8	2.4	3.6	4.8	8.4	12.0	14x16	11.2	16.8	22.4	39.2	56.0
6x10	3.0	4.5	6.0	10.5	15.0	14x18	12.6	18.9	25.2	44.1	63.0
8x 8	3.2	4.8	6.4	11.2	16.0	16x16	12.8	19.2	25.6	44.8	64.0
8x10	4.0	6.0	8.0	14.0	20.0	16x18	14.4	21.6	28.8	50.4	72.0
8x12	4.8	7.2	9.6	16.8	24.0	16x20	16.0	24.0	32.0	56.0	80.0
10x10	5.0	7.5	10.0	17.5	25.0	18x18	16.2	24.3	32.4	56.7	81.0
10x12	6.0	9.0	12.0	21.0	30.0	18x20	18.0	27.0	36.0	63.0	90.0
10x14	7.0	10.5	14.0	24.5	35.0	18x22	19.8	29.7	39.6	69.3	99.0
12x12	7.2	10.8	14.4	25.2	36.0	20x20	20.0	30.0	40.0	70.0	100.0
12x14	8.4	12.6	16.8	29.4	42.0	20x22	22.0	33.0	44.0	77.0	110.0
12x16	9.6	14.4	19.2	33.6	48.0	20x24	24.0	36.0	48.0	84.0	120.0

The pressure on masonry of different kinds should not exceed the following values, in lbs. per square inch :

Kind of Masonry.	Pressure, Lbs. per Sq. In.
Brickwork in lime mortar,	100
Brickwork in cement and lime mortar,	150
Brickwork in Portland cement mortar,	200
Portland cement concrete,	350
Sandstone of good quality,	400
Bluestone and limestone,	500
Granite,	600

Frequently a template of bluestone, or other hard quality of stone, is used instead of a steel bearing plate. Where the load to be supported is considerable, as at the ends of girders, both steel bearing plates and stone templates should be used ; in which case the size of the bearing plate is determined by the allowable pressure on the stone template according to the safe pressure given above for the kind of stone used. The size of the stone template must also be sufficient to limit the pressure on the brickwork to the safe allowable value as given above for the quality of masonry used. The stone should not project beyond the steel bearing plate in any direction more than $\frac{3}{4}$ of the thickness of the stone.

GRILLAGE BEAMS IN FOUNDATIONS.

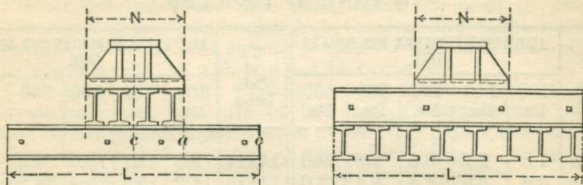

Grillages of steel beams imbedded in concrete are used in column footings to distribute the load over the desired area on yielding soil, thereby avoiding large masses of masonry and deep excavations. The beams should not be less than 3 inches apart in the clear between flanges so that the space between beams can be thoroughly filled with concrete. Separators should be used to keep the beams properly spaced.

The load supported by each beam in a layer equals the total load on the foundation divided by the number of beams in the layer. Loading is uniformly distributed over the length on which it is applied and the beam is uniformly supported from below over its entire length. Maximum bending occurs at c , the center of length of the beam.

W = load supported by each beam, in lbs.

L = length of beam, in feet.

N = length, in feet, on which load is applied.

C = coefficient of strength for the beam.

Maximum bending moment, in foot-lbs. = $\frac{1}{8} W(L-N)$.

This formula for bending moment is the same as that for a simple beam of the length $(L-N)$ supporting a uniformly distributed load of W . By using the length $(L-N)$ as the span the size or safe load of grillage beams may be obtained directly from the tables of safe loads for I beams and girder beams. If $(L-N)$ is less than the spans given in these tables the size or safe load must be obtained by means of the coefficient of strength or section modulus. When W is in pounds and L and N are in feet, the safe load on a given grillage beam is found by the formula,

$$W = \frac{C}{L-N}; \quad (1)$$

and the coefficient of strength required by a beam for a given loading from the formula,

$$C = W(L-N). \quad (2)$$

The greatest safe load may be limited by the safe shearing or crippling strength of the web which should be investigated. The shear due to the load W is a maximum at the point a under the outer edge of the superimposed load, and is found as follows:

V_s = maximum shear due to the load W .

V = greatest safe allowable shear on web of beam.

$$V_s = \frac{W(L-N)}{2L}.$$

The shear V_s must not exceed V , the safe shearing strength of the web. If the beams are thoroughly imbedded in concrete and the webs prevented from buckling,

$$V = 12,000dt = \text{safe allowable shear, in lbs.}$$

But if the webs are not supported against buckling,

$$V = \frac{12,000dt}{1 + \frac{h^2}{3000t^2}} = \begin{cases} \text{safe crippling strength} \\ \text{of web, in lbs.} \end{cases}$$

where d = depth of beam, t = thickness of web and h = clear distance between flanges, all in inches. The last formula is that for the safe crippling strength of webs and values for it are given for Bethlehem beam and girder sections in the table on page 67.

When shearing strength of the web is considered, the maximum load on a given grillage beam is

$$W = 2V \frac{L}{L-N}; \quad (3)$$

and the safe shearing strength required by the web of a beam for a given loading is

$$V = \frac{W}{2} \frac{L-N}{L}. \quad (4)$$

To find the safe load on a given beam use formulas (1) and (3) and take the lesser of the two values. When formula (3) gives the smaller value the safe load is limited by the shearing strength of the web.

To select a grillage beam for a given loading find the coefficient of strength required by formula (2) and the safe shearing strength of web required by formula (4). The proper beam must then be selected to satisfy both requirements.

It will be found that Bethlehem girder beams are desirable and economical for use as grillage beams.

SHEARING AND BEARING VALUE OF RIVETS.

Diameter of Rivet, Inches.	Area in Square Inches.	Single Shear at 7500 Lbs.	Bearing Values, in Pounds, for Different Thickness of Plate in Inches at 15,000 Lbs. per Square Inch.				
			1/4"	5/16"	3/8"	7/16"	1/2"
3/8	.1104	830	1410	1760	2110
1/2	.1963	1470	1880	2340	2810	3280	3750
5/8	.3068	2300	2340	2930	3520	4100	4690
3/4	.4418	3310	2810	3520	4220	4920	5630
7/8	.6013	4510	3280	4100	4920	5740	6560
1	.7854	5890	3750	4690	5620	6560	7500

Diameter of Rivet, Inches.	Area in Square Inches.	Single Shear at 9000 Lbs.	Bearing Values, in Pounds, for Different Thickness of Plate in Inches at 18,000 Lbs. per Square Inch.				
			1/4"	5/16"	3/8"	7/16"	1/2"
3/8	.110	990	1680	2110	2530
1/2	.196	1770	2250	2820	3370	3940	4500
5/8	.307	2760	2790	3480	4180	4870	5580
3/4	.442	3970	3370	4210	5050	5910	6750
7/8	.601	5410	3940	4920	5910	6880	7870
1	.785	7060	4500	5620	6750	7870	9000

Diameter of Rivet, Inches.	Area in Square Inches.	Single Shear at 10,000 Lbs.	Bearing Values, in Pounds, for Different Thickness of Plate in Inches at 20,000 Lbs. per Square Inch.				
			1/4"	5/16"	3/8"	7/16"	1/2"
3/8	.1104	1100	1880	2340	2810
1/2	.1963	1960	2500	3130	3750	4380	5,000
5/8	.3068	3070	3130	3910	4690	5470	6,250
3/4	.4418	4420	3750	4690	5630	6560	7,500
7/8	.6013	6010	4380	5470	6570	7660	8,750
1	.7854	7850	5000	6250	7500	8750	10,000

Diameter of Rivet, Inches.	Area in Square Inches.	Single Shear at 11,000 Lbs.	Bearing Values, in Pounds, for Different Thickness of Plate in Inches at 22,000 Lbs. per Square Inch.				
			1/4"	5/16"	3/8"	7/16"	1/2"
3/8	.1104	1210	2060	2580	3090
1/2	.1963	2160	2750	3440	4130	4820	5,500
5/8	.3068	3370	3440	4300	5160	6020	6,880
3/4	.4418	4860	4130	5160	6190	7220	8,250
7/8	.6013	6310	4810	6020	7220	8430	9,630
1	.7854	8640	5500	6880	8250	9630	11,000

Bearing values given above or to the right of the upper zigzag lines are greater than double shear. Bearing values given between the upper and lower zigzag lines are less than double shear and greater than single shear.

SHEARING AND BEARING VALUE OF RIVETS.

Bearing Values, in Pounds, for Different Thickness of Plate in Inches
at 15,000 Lbs. per Square Inch.

$\frac{9}{16}$ "	$\frac{5}{8}$ "	$\frac{11}{16}$ "	$\frac{3}{4}$ "	$\frac{13}{16}$ "	$\frac{7}{8}$ "	$\frac{15}{16}$ "	1"	Diameter of Rivet, Inches.
.....	$\frac{3}{8}$
.....	$\frac{1}{2}$
5280	5860	$\frac{5}{8}$
6330	7030	7,720	8,440	$\frac{3}{4}$
7380	8200	9,030	9,850	10,670	11,480	12,300	$\frac{7}{8}$
8440	9380	10,310	11,250	12,190	13,130	14,060	15 000	1

Bearing Values, in Pounds, for Different Thickness of Plate in Inches
at 18,000 Lbs. per Square Inch.

$\frac{9}{16}$ "	$\frac{5}{8}$ "	$\frac{11}{16}$ "	$\frac{3}{4}$ "	$\frac{13}{16}$ "	$\frac{7}{8}$ "	$\frac{15}{16}$ "	1"	Diameter of Rivet, Inches.
.....	$\frac{3}{8}$
.....	$\frac{1}{2}$
6,330	7,030	$\frac{5}{8}$
7,590	8 440	9,280	10,130	$\frac{3}{4}$
8,860	9,840	10,830	11,810	12,800	13,780	14,770	$\frac{7}{8}$
10,120	11,250	12,370	13,500	14,630	15,750	16,880	18,000	1

Bearing Values, in Pounds, for Different Thickness of Plate in Inches
at 20,000 Lbs. per Square Inch.

$\frac{9}{16}$ "	$\frac{5}{8}$ "	$\frac{11}{16}$ "	$\frac{3}{4}$ "	$\frac{13}{16}$ "	$\frac{7}{8}$ "	$\frac{15}{16}$ "	1"	Diameter of Rivet, Inches.
.....	$\frac{3}{8}$
.....	$\frac{1}{2}$
7,030	7,810	$\frac{5}{8}$
8,440	9,380	10,310	11,250	$\frac{3}{4}$
9,840	10,940	12,030	13,130	14,220	15,310	16,410	$\frac{7}{8}$
11,250	12,500	13,750	15,000	16,250	17,500	18,750	20,000	1

Bearing Values, in Pounds, for Different Thickness of Plate in Inches
at 22,000 Lbs. per Square Inch.

$\frac{9}{16}$ "	$\frac{5}{8}$ "	$\frac{11}{16}$ "	$\frac{3}{4}$ "	$\frac{13}{16}$ "	$\frac{7}{8}$ "	$\frac{15}{16}$ "	1"	Diameter of Rivet, Inches.
.....	$\frac{3}{8}$
.....	$\frac{1}{2}$
7,740	8,600	$\frac{5}{8}$
9,280	10,320	11,340	12,380	$\frac{3}{4}$
10,840	12,040	13,240	14,440	15,640	16,840	18,050	$\frac{7}{8}$
12,380	13,750	15,130	16,500	17,880	19,250	20,630	22,000	1

Bearing values given below or to the left of the lower zigzag lines are less than single shear.

WEIGHT OF 100 STEEL RIVETS OR ROUND HEAD BOLTS WITHOUT NUTS.

POUNDS.

Length, Inches.	$\frac{3}{8}$ In. Diam.	$\frac{1}{2}$ In. Diam.	$\frac{5}{8}$ In. Diam.	$\frac{3}{4}$ In. Diam.	$\frac{7}{8}$ In. Diam.	1 In. Diam.	$1\frac{1}{8}$ In. Diam.	$1\frac{1}{4}$ In. Diam.
1 $\frac{1}{4}$	5.5	12.8	22.0	29.3	43.9	66.6	93.3	127.0
1 $\frac{1}{2}$	6.3	14.2	24.1	32.4	48.2	72.1	100.0	136.0
1 $\frac{3}{4}$	7.0	15.5	26.3	35.5	52.5	77.7	107.0	145.0
2	7.9	16.9	28.5	38.7	56.7	83.3	114.0	153.0
2 $\frac{1}{4}$	8.7	18.3	30.7	41.8	61.0	88.8	121.0	162.0
2 $\frac{1}{2}$	9.4	19.7	32.8	44.9	65.2	94.4	128.0	171.0
2 $\frac{3}{4}$	10.2	21.1	35.0	48.0	69.5	100.0	136.0	179.0
3	11.0	22.5	37.2	51.1	73.7	105.0	143.0	188.0
3 $\frac{1}{4}$	11.7	23.9	39.3	54.3	78.0	111.0	150.0	197.0
3 $\frac{1}{2}$	12.6	25.3	41.5	57.4	82.3	116.0	157.0	205.0
3 $\frac{3}{4}$	13.4	26.7	43.7	60.5	86.5	122.0	164.0	214.0
4	14.1	28.1	45.9	63.6	90.8	128.0	170.0	223.0
4 $\frac{1}{4}$	14.9	29.4	48.0	66.7	95.0	134.0	177.0	231.0
4 $\frac{1}{2}$	15.7	30.8	50.2	69.9	99.3	139.0	185.0	240.0
4 $\frac{3}{4}$	16.5	32.2	52.4	73.0	104.0	145.0	192.0	249.0
5	17.2	33.6	54.5	76.1	108.0	150.0	199.0	258.0
5 $\frac{1}{4}$	18.1	35.0	56.7	79.2	112.0	156.0	206.0	266.0
5 $\frac{1}{2}$	18.8	36.4	58.9	82.3	116.0	161.0	213.0	275.0
5 $\frac{3}{4}$	19.6	37.8	61.1	85.5	120.0	166.0	220.0	284.0
6	20.4	39.2	63.2	88.6	124.0	172.0	227.0	292.0
6 $\frac{1}{2}$	21.9	42.0	67.6	95.1	133.0	184.0	241.0	310.0
7	23.5	44.7	71.9	101.0	142.0	195.0	255.0	327.0
7 $\frac{1}{2}$	25.1	47.5	76.1	108.0	150.0	206.0	269.0	345.0
8	26.6	50.3	80.6	114.0	159.0	217.0	284.0	362.0
8 $\frac{1}{2}$	28.2	53.1	85.0	120.0	167.0	227.0	298.0	379.0
9	29.8	55.9	89.3	126.0	176.0	239.0	312.0	397.0
9 $\frac{1}{2}$	31.3	58.7	93.7	133.0	185.0	250.0	325.0	414.0
10	32.8	61.4	98.0	139.0	193.0	261.0	340.0	431.0
10 $\frac{1}{2}$	34.5	64.2	103.0	145.0	202.0	272.0	354.0	449.0
11	36.0	67.0	107.0	151.0	210.0	284.0	368.0	466.0
11 $\frac{1}{2}$	37.6	69.8	111.0	158.0	218.0	295.0	382.0	484.0
12	39.2	72.5	115.0	164.0	227.0	306.0	396.0	501.0
100 Heads.	1.8	5.8	11.1	13.6	22.6	39.0	58.0	83.5

**WEIGHT, IN POUNDS, OF 100 BOLTS
WITH SQUARE HEADS AND NUTS.**

Length under Head, Inches.	Diameter of Bolts.								
	¼ In.	⅜ In.	½ In.	⅝ In.	¾ In.	⅞ In.	1 In.	1 ¼ In.	1 ½ In.
1 ½	4.0	7.0	10.5	15.2	22.5	39.5	63.0
1 ¾	4.4	7.5	11.3	16.3	23.8	41.6	66.0
2	4.8	8.0	12.0	17.4	25.2	43.8	69.0	109.0	163
2 ¼	5.2	8.5	12.8	18.5	26.5	45.8	72.0	113.3	169
2 ½	5.5	9.0	13.5	19.6	27.8	48.0	75.0	117.5	174
2 ¾	5.8	9.5	14.3	20.7	29.1	50.1	78.0	121.8	180
3	6.3	10.0	15.0	21.8	30.5	52.3	81.0	126.0	185
3 ½	7.0	11.0	16.5	24.0	33.1	56.5	87.0	134.3	196
4	7.8	12.0	18.0	26.2	35.8	60.8	93.1	142.5	207
4 ½	8.5	13.0	19.5	28.4	38.4	65.0	99.1	151.0	218
5	9.3	14.0	21.0	30.6	41.1	69.3	105.2	159.6	229
5 ½	10.0	15.0	22.5	32.8	43.7	73.5	111.3	168.0	240
6	10.8	16.0	24.0	35.0	46.4	77.8	117.3	176.6	251
6 ½	25.5	37.2	49.0	82.0	123.4	185.0	262
7	27.0	39.4	51.7	86.3	129.4	193.7	273
7 ½	28.5	41.6	54.3	90.5	135.0	202.0	284
8	30.0	43.8	59.6	94.8	141.5	210.7	295
9	48.2	64.9	103.3	153.6	227.8	317
10	52.6	70.2	111.8	165.7	244.8	339
11	57.0	75.5	120.3	177.8	261.9	360
12	61.4	80.8	128.8	189.9	278.9	382
14	91.4	145.8	214.1	313.0	426
16	102.0	162.8	238.3	347.1	470
18	112.6	179.5	262.6	381.2	514
20	123.2	206.5	286.8	415.3	558
Per Inch Additional	1.4	2.1	3.1	4.2	5.5	8.5	12.3	16.7	21.8

WEIGHTS OF NUTS AND BOLT HEADS IN POUNDS.

Diameter of Bolt in Inches.	¼ In.	⅜ In.	½ In.	⅝ In.	¾ In.	⅞ In.	1 In.
Weight of Hexagon Nut and Head.....	.021	.036	.064	.13	.26	.40	.68
Weight of Square Nut and Head.....	.024	.042	.070	.15	.29	.47	.77
Diameter of Bolt in Inches.	1 In.	1 ¼ In.	1 ½ In.	1 ¾ In.	2 In.	2 ½ In.	3 In.
Weight of Hexagon Nut and Head.....	1.01	2.10	4.26	6.89	9.24	17.3	27.2
Weight of Square Nut and Head.....	1.19	2.39	5.01	8.41	12.93	21.4	33.5

REDUCTION OF AREA, IN SQUARE INCHES, FOR ONE RIVET HOLE.

To be deducted from gross area of plates or shapes to obtain net area.

Thickness of Metal, Inches.	DIAMETER OF HOLE.										
	1/2"	9/16"	5/8"	11/16"	3/4"	13/16"	7/8"	15/16"	1"	1 1/16"	1 1/8"
1/16	.03	.04	.04	.04	.05	.05	.05	.06	.06	.07	.07
1/8	.06	.07	.08	.09	.09	.10	.11	.12	.13	.13	.14
3/16	.09	.11	.12	.13	.14	.15	.16	.18	.19	.20	.21
1/4	.13	.14	.16	.17	.19	.20	.22	.23	.25	.27	.28
5/16	.16	.18	.20	.21	.23	.25	.27	.29	.31	.33	.35
3/8	.19	.21	.23	.26	.28	.30	.33	.35	.38	.40	.42
7/16	.22	.25	.27	.30	.33	.36	.38	.41	.44	.46	.49
1/2	.25	.28	.31	.34	.38	.41	.44	.47	.50	.53	.56
9/16	.28	.32	.35	.39	.42	.46	.49	.53	.56	.60	.63
5/8	.31	.35	.39	.43	.47	.51	.55	.59	.63	.66	.70
11/16	.34	.39	.43	.47	.52	.56	.60	.64	.69	.73	.77
3/4	.38	.42	.47	.52	.56	.61	.66	.70	.75	.80	.84
13/16	.41	.46	.51	.56	.61	.66	.71	.76	.81	.86	.91
7/8	.44	.49	.55	.60	.66	.71	.77	.82	.88	.93	.98
15/16	.47	.53	.59	.64	.70	.76	.82	.88	.94	1.00	1.05
1	.50	.56	.63	.69	.75	.81	.88	.94	1.00	1.06	1.13
1 1/16	.53	.60	.66	.73	.80	.86	.93	1.00	1.06	1.13	1.20
1 1/8	.56	.63	.70	.77	.84	.91	.98	1.05	1.13	1.20	1.27
1 3/16	.59	.67	.74	.82	.89	.96	1.04	1.11	1.19	1.26	1.34
1 1/4	.63	.70	.78	.86	.94	1.02	1.09	1.17	1.25	1.33	1.41
1 5/16	.66	.74	.82	.90	.98	1.07	1.15	1.23	1.31	1.39	1.48
1 3/8	.69	.77	.86	.95	1.03	1.12	1.20	1.29	1.38	1.46	1.55
1 7/16	.72	.81	.90	.99	1.08	1.17	1.26	1.35	1.44	1.53	1.62
1 1/2	.75	.84	.94	1.03	1.13	1.22	1.31	1.41	1.50	1.59	1.69
1 9/16	.78	.88	.98	1.07	1.17	1.27	1.37	1.46	1.56	1.66	1.76
1 5/8	.81	.91	1.02	1.12	1.22	1.32	1.42	1.52	1.63	1.73	1.83
1 11/16	.84	.95	1.05	1.16	1.27	1.37	1.47	1.58	1.69	1.79	1.90
1 3/4	.88	.98	1.09	1.20	1.31	1.42	1.53	1.64	1.75	1.86	1.97
1 13/16	.91	1.02	1.13	1.25	1.36	1.47	1.59	1.70	1.81	1.93	2.04
1 7/8	.94	1.05	1.17	1.29	1.41	1.52	1.64	1.76	1.88	1.99	2.11
1 15/16	.97	1.09	1.21	1.33	1.45	1.57	1.70	1.82	1.94	2.06	2.18
2	1.00	1.13	1.25	1.38	1.50	1.63	1.75	1.88	2.00	2.13	2.25

When holes are punched the diameter of the hole should be taken 1/8 inch greater than the diameter of the rivet or bolt.

For drilled holes the diameter may be taken only 1/16 inch greater than the diameter of the rivet or bolt.

DECIMALS OF AN INCH

FOR EACH $\frac{1}{64}$ TH.

$\frac{3}{2}$ ds.	$\frac{1}{64}$ ths.	Decimal.	Fraction.	$\frac{3}{2}$ ds.	$\frac{1}{64}$ ths.	Decimal.	Fraction.
	1	.015625			33	.515625	
1	2	.03125		17	34	.53125	
	3	.046875			35	.546875	
2	4	.0625	1-16	18	36	.5625	9-16
	5	.078125			37	.578125	
3	6	.09375		19	38	.59375	
	7	.109375			39	.609375	
4	8	.125	1-8	20	40	.625	5-8
	9	.140625			41	.640625	
5	10	.15625		21	42	.65625	
	11	.171875			43	.671875	
6	12	.1875	3-16	22	44	.6875	11-16
	13	.203125			45	.703125	
7	14	.21875		23	46	.71875	
	15	.234375			47	.734375	
8	16	.25	1-4	24	48	.75	3-4
	17	.265625			49	.765625	
9	18	.28125		25	50	.78125	
	19	.296875			51	.796875	
10	20	.3125	5-16	26	52	.8125	13-16
	21	.328125			53	.828125	
11	22	.34375		27	54	.84375	
	23	.359375			55	.859375	
12	24	.375	3-8	28	56	.875	7-8
	25	.390625			57	.890625	
13	26	.40625		29	58	.90625	
	27	.421875			59	.921875	
14	28	.4375	7-16	30	60	.9375	15-16
	29	.453125			61	.953125	
15	30	.46875		31	62	.96875	
	31	.484375			63	.984375	
16	32	.5	1-2	32	64	1.	1

DECIMALS OF A FOOT
FOR EACH $\frac{1}{64}$ th OF AN INCH.

Inch.	0"	1"	2"	3"	4"	5"	6"	7"	8"	9"	10"	11"
0	0	.0833	.1667	.2500	.3333	.4167	.5000	.5833	.6667	.7500	.8333	.9167
$\frac{1}{64}$.0013	.0846	.1680	.2513	.3346	.4180	.5013	.5846	.6680	.7513	.8346	.9180
$\frac{2}{64}$.0026	.0859	.1693	.2526	.3359	.4193	.5026	.5859	.6693	.7526	.8359	.9193
$\frac{3}{64}$.0039	.0872	.1706	.2539	.3372	.4206	.5039	.5872	.6706	.7539	.8372	.9206
$\frac{4}{64}$.0052	.0885	.1719	.2552	.3385	.4219	.5052	.5885	.6719	.7552	.8385	.9219
$\frac{5}{64}$.0065	.0898	.1732	.2565	.3398	.4232	.5065	.5898	.6732	.7565	.8398	.9232
$\frac{6}{64}$.0078	.0911	.1745	.2578	.3411	.4245	.5078	.5911	.6745	.7578	.8411	.9245
$\frac{7}{64}$.0091	.0924	.1758	.2591	.3424	.4258	.5091	.5924	.6758	.7591	.8424	.9258
$\frac{1}{8}$.0104	.0937	.1771	.2604	.3437	.4271	.5104	.5937	.6771	.7604	.8437	.9271
$\frac{9}{64}$.0117	.0951	.1784	.2617	.3451	.4284	.5117	.5951	.6784	.7617	.8451	.9284
$\frac{10}{64}$.0130	.0964	.1797	.2630	.3464	.4297	.5130	.5964	.6797	.7630	.8464	.9297
$\frac{11}{64}$.0143	.0977	.1810	.2643	.3477	.4310	.5143	.5977	.6810	.7643	.8477	.9310
$\frac{1}{6}$.0156	.0990	.1823	.2656	.3490	.4323	.5156	.5990	.6823	.7656	.8490	.9323
$\frac{13}{64}$.0169	.1003	.1836	.2669	.3503	.4336	.5169	.6003	.6836	.7669	.8503	.9336
$\frac{14}{64}$.0182	.1016	.1849	.2682	.3516	.4349	.5182	.6016	.6849	.7682	.8516	.9349
$\frac{15}{64}$.0195	.1029	.1862	.2695	.3529	.4362	.5195	.6029	.6862	.7695	.8529	.9362
$\frac{1}{4}$.0208	.1042	.1875	.2708	.3542	.4375	.5208	.6042	.6875	.7708	.8542	.9375
$\frac{17}{64}$.0221	.1055	.1888	.2721	.3555	.4388	.5221	.6055	.6888	.7721	.8555	.9388
$\frac{18}{64}$.0234	.1068	.1901	.2734	.3568	.4401	.5234	.6068	.6901	.7734	.8568	.9401
$\frac{19}{64}$.0247	.1081	.1914	.2747	.3581	.4414	.5247	.6081	.6914	.7747	.8581	.9414
$\frac{20}{64}$.0260	.1094	.1927	.2760	.3594	.4427	.5260	.6094	.6927	.7760	.8594	.9427
$\frac{21}{64}$.0273	.1107	.1940	.2773	.3607	.4440	.5273	.6107	.6940	.7773	.8607	.9440
$\frac{22}{64}$.0286	.1120	.1953	.2786	.3620	.4453	.5286	.6120	.6953	.7786	.8620	.9453
$\frac{23}{64}$.0299	.1133	.1966	.2799	.3633	.4466	.5299	.6133	.6966	.7799	.8633	.9466
$\frac{3}{8}$.0312	.1146	.1979	.2812	.3646	.4479	.5312	.6146	.6979	.7812	.8646	.9479
$\frac{25}{64}$.0326	.1159	.1992	.2826	.3659	.4492	.5326	.6159	.6992	.7826	.8659	.9492
$\frac{26}{64}$.0339	.1172	.2005	.2839	.3672	.4505	.5339	.6172	.7005	.7839	.8672	.9505
$\frac{27}{64}$.0352	.1185	.2018	.2852	.3685	.4518	.5352	.6185	.7018	.7852	.8685	.9518
$\frac{28}{64}$.0365	.1198	.2031	.2865	.3698	.4531	.5365	.6198	.7031	.7865	.8698	.9531
$\frac{29}{64}$.0378	.1211	.2044	.2878	.3711	.4544	.5378	.6211	.7044	.7878	.8711	.9544
$\frac{30}{64}$.0391	.1224	.2057	.2891	.3724	.4557	.5391	.6224	.7057	.7891	.8724	.9557
$\frac{31}{64}$.0404	.1237	.2070	.2904	.3737	.4570	.5404	.6237	.7070	.7904	.8737	.9570
$\frac{1}{2}$.0417	.1250	.2083	.2917	.3750	.4583	.5417	.6250	.7083	.7917	.8750	.9583

INDEX.

	PAGE
Allowable variation in weights of sections	9
Angles, connection, for I beams and girder beams	88-89
Area, reduction of, for rivet holes	114
Areas, method of increasing sectional	9
Beams, bearing plates for	106-107
bending moment, shear and deflection of	101
deflection of	102-103
grillage, calculation of	108-109
notes on strength and deflection of	99-101
unsupported sideways, reduced loads for	56
Beams, Bethlehem I:	
comparison of, with Standard I beams	41
dimensions of	33
distance c. to c., for equal radii of gyration	42
moments of resistance for, in ft. lbs.	39
properties of	36-37
safe loads, uniformly distributed for	61-65
" " for, used as columns	76-77
safe shear on webs of	66-67
shapes of	19-25
standard gauges for rivet holes in	94-95
weights of	33
Beams, Bethlehem Rolled Girder:	
comparison of, with Standard I beams	40
dimensions of	32
distance c. to c., for equal radii of gyration	42
moments of resistance for, in ft. lbs.	38
properties of	34-35
safe loads, uniformly distributed for	57-60
" " for, used as columns	74-75
safe shear on webs of	66-67
shapes of	10-18
standard gauges for rivet holes in	96
weights of	32
Bearing plates, notes on	106-107
Bending moments, for usual methods of loading	101

	PAGE
Bolts, weights of	113
Bridges, Bethlehem beams and girders for railroad	68-69
Columns, Bethlehem Rolled Steel H :	
areas of	44-51
connections and details for	97-98
dimensions of	44-51
example showing method of selecting	73
properties of	44-51
safe loads for	78-85
shapes of	26-29
special section, uses and properties of	52-53
weights of	44-51
Compound Columns, weights and properties of	54-55
safe loads for	86-87
Connection angles for I beams and girder beams	88-89
minimum spans for	90-91
Cutting to length, allowable variation in	9
Decimals of a foot, for each $\frac{1}{8}$ th inch	116-117
“ an inch, for each $\frac{1}{8}$ th	115
Deflection of beams, notes on	102-103
Dimensions of Bethlehem girder beams	32
“ Bethlehem H column sections	44-51
“ Bethlehem I beams	33
Explanation of Bethlehem structural shapes	4-9
Formulas for bending moments and deflections	101
Grillage beams, notes on calculation of	108-109
Rivet holes, reduction of area for	114
Rivet spacing for Bethlehem beams and girders	94-96
Rivets, shearing and bearing values for	110-111
weights of	112
Separators for I beams and girder beams	92-93
Shear, safe, on webs of beams	66-67
Tie rods, size and spacing of	104-105
Weights of beams, Bethlehem I and girder	32-33
“ bearing plates	106-107
“ bolts	113
“ connection angles for beams	88-89
“ H column sections	44-51
“ rivets	112
“ separators for beams	92-93

BETHLEHEM STEEL COMPANY,

Works at South Bethlehem, Pa.,

The Largest Individual Steel Plant in America,

MANUFACTURES

Open Hearth Steel Structural Shapes, Wide Flange Beams, Rolled Girders, Rolled Column Sections, Standard I Beams, Channels, Angles, Rounds, Squares, and Flats.

Open Hearth Steel Rails from 60 to 100 pounds per yard.

Forgings of All Sizes, rough or finished, for Marine and Stationary Engines, Locomotives, Machine Tools, etc., of fluid compressed open hearth carbon or nickel steel, hydraulic forged solid or hollow around a mandrel, and annealed or oil tempered.

Drop Forgings of all sizes.

Hydraulic Presses, Heavy Machinery, and Machine Tools designed and built.

Armor Plate and Armor Plate Vaults

Land and Naval Ordnance, Finished Guns of All Calibers, Gun Forgings, Gun Carriages, Projectiles.

Pumping Engines and Machinery.
Gas Engines.

Steel Castings of all sizes, of carbon or nickel steel.

Iron Castings of all sizes.

Brass and Bronze Castings.

High Speed and Special Tool Steels.

Muck Bar Iron.

Stay Bolt Iron.

Steel Billets.

Pig Iron.

BETHLEHEM
STRUCTURAL
SHAPES



1911