

SPECIFICATION

January 2014

25

Important indications ceramics

1. Additions

New series and models

Series	Remark	Availability
D-Code	Washbasin Med # 231165, 231155 Furniture Washbasin Med # 035285 Bidet wall mounted # 225715 Toilet wall mounted # 253509	available available available available
DuraStyle	Washbasin Med # 232465, 232455 Furniture washbasin # 232510 Furniture washbasin # 232610 Bidet wall mounted # 228715 Toilet wall mounted # 255109 Toilet wall mounted # 255209 Toilet close-coupled # 216209 Cistern # 093530	available end of March 2014 end of March 2014 end of March 2014 end of March 2014 end of March 2014 end of April 2014 end of April 2014
Happy D.2	Previous model of the series Onto - washbasin # 263152 Furniture washbasin # 231812 Metal console # 0030791000 Toilet wall mounted # 222209	available end of June 2014 end of June 2014 end of June 2014
Starck 2	Vanity basin # 232748	available
Vero	Vanity basin # 031550	available

2. Discontinued items

Series and models

Series	Remark
D-Code	Toilet wall mounted # 220909 Bidet wall mounted # 223615
Duraplus	all items except # 010609, 018509, # 019509, 254709, 253210
Onto	Washbasin # 263052 Furniture washbasin # 262943 Vanity basin # 262943
Starck 1	Washbowl # 038847
Starck 2	One-piece toilet # 016301 Washbasin # 041165, 041160, 041155 Handrinsebasin # 076150 Above counter basin # 041155 Vanity basin # 047847

3. WonderGliss

Sanitary ceramics with the special WonderGliss surface finish will remain clean and attractive-looking for a long time to come. Thanks to the coating which is fired into the ceramics, water immediately contracts into drops and drips off, taking any other residuals substances (like e.g. lime) along. The result: less polluting deposits, less cleaning work - more fun in the bathroom! For more information please refer to www.duravit.com.



WonderGliss
Simply add a '1' to the model-no.

4. Dimensioning/Weights

The indicated dimensions in mm always refer to width x depth. Mentioned weights are net.

5. Tolerances

All drawings are showing the necessary dimensions in mm with standard tolerances. They are without obligation as proper dimensions can be taken from finished products only.

6. Special indications

Ceramic

When ordering please make sure that you use the correct model numbers:

0 4 5 4 6 0 0 8 0 0

0 4 5 4 6 0 0 8 3 0

When ordering washbasins with three tap holes punched please indicate this by inserting „30“ in the 9th and 10th digit.

0 4 5 4 6 0 0 8 0 0 1

When ordering items with WonderGliss-coating please add a „1“ as 11th digit.

Model Colour Variant

SensoWash®

When ordering please make sure that you use the correct model numbers:

6 1 0 0 0 1 0 0 2 0 0 0 3 0 0

Further information please see in chapter SensoWash®.

Model Colour Voltage Configuration Plug

7. CAD drawings

CAD data of Duravit sanitary ware can be downloaded from our internet website www.duravit.com or pro.duravit.com (DXF, DWG, IGS, STP format).

8. Guarantee

Duravit AG grants a guarantee period of 5 years for all ceramic sanitary ware and acrylic ware. Duravit AG grants a guarantee period of 2 years for all whirlsystems, electronic toilet seats and accessories, providing that the installation is carried out by a certified plumber or electrician.

9. Cutout templates

Necessary cutout templates are enclosed to the products. DXF-data are available on pro.duravit.com.

10. Symbols

- 6,0 l water saving 6-liter flush
- 4,8 l water saving 4,8-liter flush
- 4,5 l water saving 4,5-liter flush
- ⊗ without tap hole
- 1 pre-punched tap hole
- 1 tap hole punched
- ● 2 pre-punched tap holes left and right for 2 taps
- ● ● 1 tap hole punched, 2 tap holes pre-punched
- ● ○ 1 tap hole punched, 2 additional tap holes are possible (please indicate when ordering)
- ● 2 tap holes punched left and right for 2 taps
- ● ● 3 tap holes punched
- ● 2 tap holes punched with large distance between tap fittings
- ● 2 tap holes pre-punched with large distance between tap fittings
- ● 1 tap hole punched (left)
- ● 1 pre-punched tap hole for soap dispenser (right)
- ● 1 tap hole pre-punched (left), 1 pre-punched tap hole for soap dispenser (right)
- ● 1 tap hole punched (left)
- ● 1 tap hole punched for soap dispenser (right)
- ● 1 tap hole punched (right)
- ● 1 tap hole punched for soap dispenser (left)

Content

General information			
Important Indications Ceramics	2		
Numerical Index	4		
International Standards	14		
Overview product categories	21		
SensoWash® Product Information	175		
Important Indications Kitchen sinks	216		
Important Indications bathtubs and well being	241		
Accessories for bathtubs			
Product Information	242		
Whirlsystem Product Information	243		
Antislip Product Information	253		
OpenSpace Product Information	454		
Pool Product Information	461		
Sauna Product Information	481		
St.Trop Product Information	504		
Important Indications Bathroom Furniture	519		
Ordering information ceramics	from 650		
Ordering information and ordering guides bathtub and well being	from 654		
Ordering information and ordering guides bathroom furniture	from 656		
General Terms of Sale	675		
Colour Chart	End of Pricelist		
Ceramics			
1930 Series	35		
2nd floor	38		
Architec	48		
Bacino	59		
Bagnella	60		
Caro	61		
Darling New	64		
D-Code	70		
Duraplus	83		
DuraStyle	85		
Esplanade	101		
Bathroom_Foster	103		
Happy D.2	106		
PuraVida	115		
Scola	119		
Starck 1	120		
Starck 2	130		
Starck 3	137		
Urinals, various	155		
US-toilets, various	159		
Vanity basins, various	160		
Vero	161		
SensoWash®			
SensoWash for Darling New	181		
SensoWash for D-Code	187		
SensoWash for DuraStyle	191		
SensoWash for Happy D.2	196		
SensoWash for Starck 2	198		
SensoWash for Starck 3	204		
Kitchen sinks			
Kitchen sinks built-in version			
Kiora	217		
Starck K	219		
Kitchen sinks flush mounted			
Kiora	221		
Starck K	223		
Undercounter kitchen sinks			
Vero	226		
Accessories			
D-Code	228		
Karree	230		
Starck 1	232		
Fittings			
Fittings ceramic	233		
Fittings SensoWash®	238		
Bath- and whirltubs			
2x3	254		
2nd floor	257		
Blue Moon	270		
Darling New	283		
Daro	299		
D-Code	302		
DuraStyle	310		
Esplanade	323		
Happy D.2	333		
Nahho	345		
Paiova	353		
PuraVida	377		
Starck	386		
Sundeck	404		
Vero	429		
Shower trays			
D-Code	438		
DuraPlan	444		
Starck Slimline	448		
Shower screens			
OpenSpace	454		
Pools			
Blue Moon	465		
Sundeck	474		
Sauna			
Inipi	486		
Inipi B	498		
Steam showers			
St.Trop	504		
Accessories Bathtubs / Well Being			
Tub covers	510		
Fittings	512		
Bathroom furniture			
2nd floor	521		
Darling New	536		
Delos	543		
DuraStyle	562		
Esplanade	573		
Fogo	576		
Happy D.2	590		
Ketho	600		
PuraVida	613		
Starck	620		
X-Large	626		
Light and mirrors	643		

Numerical Index

Model-No.	Page	Model-No.	Page	Model-No.	Page	Model-No.	Page
00		005037	160, 233	006429	83, 84	009781	232
001402	38, 39, 42	005038	48, 49, 233	006431	146, 151, 152	009782	232
001416	69, 96, 235	005040	124, 233	006439	146, 151, 152	009791	232
001417	69, 96, 235	005041	128, 129, 237	006451	111, 112, 113	009801	232
001418	37, 81, 235	005042	153, 157, 237	006459	111, 112, 113	009904	228, 230
001422	46, 47, 235	005043	48, 233	006461	112, 113	009912	229, 230
001428	47, 235	005044	48, 234	006469	112, 113	009914	229
001429	47, 235	005051	59, 103, 233	006481	36, 37	009915	229
001431	37, 63, 235	005052	39, 40, 233	006500	35, 36, 236	009916	229
001435	158, 237	005060	157	006550	63	009917	228
001436	158, 237	005061	157	006551	63	009918	228
001480	235	005062	57, 58, 157	006560	62	009919	228
001481	236	005064	66, 90, 236	006561	62	009920	228
001482	236	005071	238	006569	62	009921	228
003032	73	005072	181, 191, 238	006570	84	009922	228
003033	72, 161, 163	005073	38, 40, 234	006588	127, 128	009923	228
003034	169	005074	85	006591	129, 136	009924	228
003035	73, 169	005111	97, 153, 236	006630	83, 84	009925	228
003036	73, 169	005112	63, 97, 236	006661	36, 37	009926	228
003037	161	005200	219, 220, 224	006679	159	009927	228
003038	161	005201	219, 220, 225	006691	133	009928	229
003039	161, 163	005202	219, 220, 225	006699	133	009950	230
003045	38, 39, 234	005203	219, 220, 225	006700	120, 234	009951	230
003047	161	005204	219, 223	006701	35, 36, 237	009952	230
003048	121, 122	005205	219, 220, 224	006704	120	009953	230
003049	122	005206	219, 220, 225	006712	140, 234	009954	230
003050	120	005207	219, 220, 225	006713	157, 158, 237	009955	231
003059	119	005208	219, 220, 225	006731	74, 75, 79	009956	231
003063	161, 166	005214	217, 218, 222	006739	74, 75, 79	009957	231
003064	138	005503	38, 39, 234	006741	75, 80, 81	009958	230
003065	161	005504	130, 139, 234	006769	170, 171	009959	230
003066	161	005505	43, 234	006771	149	009960	230
003067	161, 163	006021	104, 105	006779	149	009961	230
003071	169	006031	76	006851	114	009962	230
003072	169	006039	76	006869	63	009963	231
003073	169	006041	76	006870	159		
003074	161, 163	006051	92, 93, 97	006899	46, 47	01	
003075	161	006059	92, 93, 97	006919	117, 118	010101	63
003076	109	006071	76	006939	171	010609	84
003077	109	006091	76	006961	54	010C	592, 633
003078	109	006131	156	006969	54	011009	46
003079	109, 110	006151	172	006979	102	011201	114
005000	83, 139, 237	006209	75, 80, 81	006981	66, 67, 135	011301	81, 189
005001	140	006221	36, 37	006989	66, 67, 135	011701	81, 190
005004	99, 158	006241	145, 146	007414	62	011C	592, 633
005006	157, 237	006261	145, 146	007504	36, 47, 235	012409	147
005008	56, 57	006279	104, 105	007508	77, 78, 188	012601	147
005019	102, 127, 236	006281	54	007559	56, 57	012609	147
005020	36, 46, 236	006291	54	009701	232	012809	148
005024	43, 44, 233	006332	66, 69, 152	009711	232	012C	592, 633
005025	49, 233	006339	66, 69, 152	009721	232	013410	104
005026	88, 89, 234	006371	90, 91, 96	009722	232	013415	104
005027	45, 46, 237	006379	90, 91, 96	009731	232	013610	46
005028	45, 51, 233	006381	143, 144, 148	009741	232	013710	46
005030	155, 156, 237	006389	143, 144, 148	009751	232	013C	592, 633
005031	59, 103, 233	006420	83, 84	009761	232	015701	159
005036	38, 39, 234	006427	83, 84	009771	232	015C	593, 633

Numerical Index

Model-No.	Page	Model-No.	Page	Model-No.	Page	Model-No.	Page
016C	593, 633	031348	140	040658	121	049963	64
017509	104	031455	167	040753	121	049983	64
017609	105	031550	167	040833	126		
017709	105	031555	167	040853	123	05	
017C	593, 633	031653	45	040C	552	050C	553
018209	36	031758	44, 45	041947	103	053C	553
018509	84	031840	50	041955	103		
018C	593, 633	031845	50	041960	103	06	
019009	54	031850	50	041970	103	068460	119
019509	84	031927	53	043460	61	068560	119
019809	62	031932	53	043470	61		
		031937	53	043490	61	07	
02		031942	51	043860	35	070225	165
020C	551	032040	50	043870	35	070350	164
021009	127	032042	50	043880	35	070445	164, 165
022509	62	032045	49	043C	553	070536	71
022701	36	032050	49	044358	48	070545	71
022709	36	032542	59	044546	126	070650	70
023309	128	032910	169	044648	124	070745	71
023809	133	032912	169	044753	123	070845	86
023C	551	032985	169	044845	48	070950	106
024309	54	033043	168	044958	48	071050	106
025C	594, 635	033048	168	045058	48	071150	106
026610	35	033213	141, 142	045140	60	071350	86
026710	35	033342	59	045148	60	071450	130
026C	594, 635	033452	59	045250	166	071C	615
027410	127	033550	103	045260	166	072050	116
027415	126	033643	103	045360	166, 167	072150	117
027C	594, 635	033754	71	045410	161, 162, 163	072C	616
028C	594, 635	033849	72	045412	161, 162, 163	073147	64
029010	61	033856	71	045450	161, 162	073C	615
029015	61	033955	71	045460	161, 162, 164	074C	616
		033C	552	045470	161, 162	075045	139
03		034210	73	045480	161, 162	075140	139
030050	137	034265	73	045550	165	075150	139
030055	137	034285	73	045560	165	075244	139
030060	137	034760	44	045748	109	075C	615
030065	137	034812	72	045C	595, 635	076138	130
030155	138	034943	86	046157	61	076465	49
030160	138	034960	86	046240	51	076565	49
030249	140	035285	73	046340	52	076635	49
030256	140	036970	116	046651	160	076C	616
030348	138, 140	037070	116	046840	52	078550	35
030410	137	037110	116	046847	50	079040	43, 44
030470	137	037243	87	046C	595, 635	079050	43
030480	137	037260	87	047334	51	079150	61
030543	141	037337	88	047658	35	079342	35
030549	141	037456	87	047C	595, 635	079444	83
030750	137	037462	87	048360	108	079C	583
030755	137	037555	87	048C	595, 635		
030760	137	038647	124	049112	38, 39, 40	08	
030960	138	038747	125	049160	42, 43	081737	55
030970	138			049170	42	081835	57, 58
030C	552	04		049180	41	081836	56
031055	140	040557	120	049747	64	081837	55
031260	138	040575	120	049910	64	081937	56
031270	138	040590	120	049953	64	082036	57

Numerical Index

Model-No.	Page	Model-No.	Page	Model-No.	Page	Model-No.	Page
08		086383	130	10		212101	113
082037	55	086397	103	100107	233	212151	197
082135	153	086398	103	100254	55, 56	212301	69, 184
082235	153	086399	103	100255	56, 57	212351	183
082335	156	086515	137, 141	100342	57, 98, 100	212401	151, 211
082336	156	086516	137, 141	100343	58	212451	210
082444	153	086517	137, 138, 139	100344	57, 58, 100	212501	152, 213
082544	153	086518	139	100384	100	212551	212
082625	153	087220	36	100524	193, 206, 207	212601	69, 186
082725	154	087221	36			212651	185
082830	82	087230	37	11		212701	152, 215
082930	82	087250	62	1128	642	212751	214
083037	157, 158	087270	118	1131	642	212809	133
083432	128, 136	087280	102	1135	641	212909	134, 201
083532	129, 136	087400	84	1136	641	212959	200
083630	63	087600	47	1137	641	213001	37
084436	157	087610	47	1150	641	213209	118
084737	155	089245	37	1152	641	213301	135, 203
084837	155	089255	37	1154	641	213351	202
085035	156	089265	37			213409	113
085135	155	089275	37	12		213809	67
085713	43	089C	583	1238	571	213909	67
085714	38, 39, 41			1239	571	214109	150, 207
085716	42	09		1248	571	214159	206
085717	71	090900	171	1249	571	214209	80, 188
085718	70, 72	090910	171	1255	612	214409	68
085790	35	090C	583	1257	612	214509	135
085791	35	091200	105	1265	612	214609	102
085810	115	091210	105	1266	611	214709	102
085812	115	091C	584	1267	612	215009	93
085813	116	092000	147, 148, 207	1270	541	215509	94
085824	64	092010	147, 148, 207	1272	541	215609	95
085825	64	092011	150, 207	1274	542	215659	193
085826	64	092040	152, 212, 213	1276	542	215701	96
085827	106	092410	63	1288	560	215751	194
085828	106	092700	77, 78, 188	1289	560	215909	112
085829	85	092710	77, 78, 188	1290	561	216001	97
085830	85	092720	81, 190	1291	561	216051	195
085831	86	092731	80, 188			216209	96
085832	106	092800	149	21			
085833	130	092810	149	210301	171	22	
085834	130	092910	114	210409	149	220009	143
085835	130	093100	67, 68	210609	47	220109	144
086318	42	093110	67, 68	210709	47	220209	144
086319	38, 39, 41	093111	67	210809	76	220309	145
086320	61	093120	69, 185, 186	210909	76	220609	145
086321	61	093130	68, 69, 186	211001	77	221009	74
086322	61	093200	152, 214, 215	211101	77	221109	75
086325	61	093300	134, 135, 201	211109	78	221509	146
086326	61	093400	113	211401	78	221709	170
086327	70, 72	093410	113	211509	77	221909	117
086350	120	093500	94, 95, 193	211609	171	222009	46
086351	120	093510	94, 95, 193	211709	170	222109	111
086352	120	093520	97, 195	211809	79	222209	112
086353	120	093530	96	211909	118	222309	75, 187
086355	120			212001	151, 209	222509	143
086356	120			212051	208	222609	146, 205

Numerical Index

Model-No.	Page	Model-No.	Page	Model-No.	Page	Model-No.	Page
222659	204	231660	106	255109	92	6080	564
222709	144	231665	106	255209	90	6081	564
222809	76	231680	106	255309	102	6082	564
223010	143	231765	107	255409	102	6083	564
223015	142	231810	109, 110			6084	630
223115	142	231812	109, 110	26		6086	630
223410	143	231865	109, 110	262155	64	6088	630
223710	73	231880	109, 110	262160	64		
223715	73	231955	85	262165	64	61	
223810	74	231960	85	262260	101	610000	182, 184, 215
223915	169	231965	85	262285	101	610001	181, 183, 214
224010	170	232010	88	263152	85	610100	187, 188, 190
224110	74	232012	88			610200	191, 192, 195
224610	117	232065	88	27		610300	196, 197
224710	117	232080	88	270060	115	6180	564
224715	117	232144	131	270070	115	6181	564
224915	65	232246	125	270160	115	6182	564
225010	65	232355	130	270170	115	6183	564
225110	65	232360	130	2704	640		
225415	45	232365	130			62	
225510	132	232455	85	28		6208	631
225615	65	232460	85	280032	172	6209	631
225715	73	232465	85	280132	172	6220	547
225815	111	232510	89	280430	97	6221	547
225910	111	232580	89	280431	98, 99	6222	547
226110	101	232610	88	280530	97	6223	548
226210	101	232680	88	280630	98	6224	548
226510	101	232748	131	280631	99	6225	548
226610	101			280730	98	6226	548
226710	111	25		280830	100	6227	548
227115	131	2525	541			6228	548
227210	131	2528	611	52		6230	545
228015	142	2530	611	522048	160	6231	545
228115	142	253115	53			6232	545
228215	89	253210	83	60		6233	545
228310	90	253309	132, 199	6042	632	6234	546
228410	90	253359	198	6043	632	6235	546
228515	89	253409	132	6044	632	6236	546
228615	90	253509	74	6045	632	6237	546
228715	89	253609	91	6046	632	6268	592
		2537	610	6047	632	6280	564
23		253709	92	6048	629	6281	564
230370	122	253759	191	6049	629	6282	564
230557	122	253809	93	6050	629	6283	564
230710	122	253909	91	6051	629		
230910	121	254009	91	6052	632	63	
231055	70	254109	92	6053	632	6300	595
231060	70	254209	93	6054	632	6301	595
231065	70	254259	192	6056	631	6302	595
231155	70	254409	66, 182	6057	631	6310	593
231160	70	254459	181	6058	631	6311	593
231165	70	254509	66	6059	631	6312	593
231260	70	254609	54	6060	629	6320	547
231360	70	254709	83	6061	629	6321	547
231440	108	254909	66	6062	629	6322	547
231460	107	255009	112	6063	629	6323	548
231560	107	255059	196	6068	630	6324	548

Numerical Index

Model-No.	Page	Model-No.	Page	Model-No.	Page	Model-No.	Page
63		6446	524	6644	603	6765	615
6325	548	6447	524	6645	603	6767	615
6326	548	6448	524	6646	603	6769	616
6327	548	6454	538	6647	602	6784	567
6328	548	6455	524	6648	602	6785	567
6330	545	6456	525	6649	602	6787	549
6331	545	6457	525	6650	602	6788	549
6332	545	6458	525	6654	607	6789	549
6333	545	6460	538	6655	607	6790	549
6334	546	6461	538	6656	607	6791	550
6335	546	6462	538	6657	607	6792	550
6336	546	6470	539	6658	608	6794	605
6337	546	6471	539	6662	602	6795	605
6342	632	6472	539	6663	602	6796	605
6343	632	6480	565	6664	602	6797	606
6344	632	6481	565	6665	602	6799	555
6345	632	6482	565	6666	603		
6346	632	6483	566	6667	602	68	
6347	632	6484	566	6668	602	6802	585
6352	633	6485	566	6669	602	6803	585
6353	633	6486	566	6670	602	6805	586
6354	633	6487	567	6684	604	6806	586
6364	592	6488	567	6685	604	6807	585
6365	592	6489	567	6686	604	6830	596
6366	592	6490	567	6687	604	6831	596
6380	565	6495	565	6688	604	6832	596
6381	565			6689	604	6833	596
6382	565	65		6690	604	6840	594
6383	566	6500	634	6691	604	6841	594
6384	566	6501	634	6692	604	6842	594
6385	566	6502	634	6694	605	6843	594
6386	566	6510	634	6695	605	6846	556
6387	566	6511	634	6696	605	6847	556
6388	566	6512	634	6697	606	6854	607
6389	566	6521	635			6855	607
6390	566	6522	635	67		6856	607
6393	565	6523	635	6713	636	6857	608
6394	565	6524	635	6714	636	6883	568
6395	565	6525	629	6715	636	6884	568
6396	565	6531	634	6716	636	6885	568
6397	565	6532	634	6717	636	6891	550
		6533	634	6718	636	6892	550
		6534	634	6719	636	6894	605
64				6721	637	6895	605
6405	523			6722	637	6896	605
6406	523	66		6723	637	6897	606
6407	523	6624	604	6724	637	6899	555
6408	523	6629	603	6731	637		
6424	525	6630	604	6732	637	69	
6425	526	6635	604	6733	637	695100	234
6426	526	6636	604	6734	637	695200	236
6427	527	6637	604	6746	556	695300	236
6439	530	6638	604	6747	556	695800	55, 63, 237
6440	523	6639	604	6754	607	6991	551
6441	523	6640	605	6755	607	6992	551
6442	523, 530	6641	605	6756	607		
6443	523, 530	6642	605	6757	607		
6445	523	6643	603				

Numerical Index

Model-No.	Page	Model-No.	Page	Model-No.	Page	Model-No.	Page
70		700215	367, 368	700315	337, 338	703018	308
700009	386	700216	361, 362	700316	339	703019	309
700010	387	700217	367, 368	700317	340	703020	309
700011	388	700218	356	700318	341	703021	309
700012	389	700219	359	700319	342	703032	398
700023	254, 255	700220	363, 364	700320	343	703033	398
700024	254, 255	700221	369, 370	700331	393, 394	703034	398
700027	299, 300	700222	363, 364	700332	393, 394	703035	398
700028	301	700223	369, 370	700333	393, 394	703036	398
700048	390	700231	317	700334	393, 394	703037	398
700050	391	700233	316	700335	393, 394	703038	398
700052	392	700238	284, 285	700336	393, 394	703039	398
700065	406, 407	700239	286, 287	700337	393, 394	703040	398
700066	413, 414, 417	700240	284, 285	700338	395	703041	398
700074	258, 259	700241	286, 287	700339	396, 397	703042	398
700075	258, 259	700242	284, 285	700340	396, 397		
700076	262, 263	700243	286, 287	700341	396, 397	71	
700079	260, 261	700244	288	701022	272, 278	710169	466, 467
700080	260, 261	700245	289	701023	272, 278	710358	475
700081	264, 265	700246	290	701024	272, 279	710359	476
700095	302	700247	291	701025	308		
700096	302	700248	292	701026	308	72	
700097	303	700249	293	701027	308	720079	445
700098	302	700264	357	701028	308	720080	446
700099	303	700265	360	701031	308	720081	446
700100	302	700266	365, 366	701032	308	720082	445
700101	304	700267	371, 372	701033	308	720083	446
700125	408, 409	700268	365, 366	701035	308	720084	446
700126	410, 411	700269	371, 372	701036	308	720085	445
700127	418, 419, 420	700270	353	701037	308	720086	446
700128	413, 414, 417	700271	354	701059	275, 278, 470	720087	446
700131	429	700280	347	701060	275, 278, 470	720088	446
700132	430	700281	324	701061	275, 279, 470	720089	445
700133	431	700282	325	701065	398	720090	446
700134	432	700283	326	701066	398	720091	446
700135	433	700284	327	701067	398	720092	446
700136	434	700285	348	701068	398	720093	440
700137	305	700286	349	701069	398	720094	440
700138	306	700288	328	701070	398	720095	440
700141	299, 300	700289	329	701071	398	720096	440
700143	271, 272, 273	700290	330	701072	398	720097	441
700160	262, 263	700291	331	701073	398	720098	441
700161	262, 263	700292	310, 311	701074	398	720099	441
700162	264, 265	700293	312, 313	701075	398	720100	441
700163	264, 265	700294	310, 311	701091	466, 470	720101	438
700169	274, 275	700295	312, 313	701092	466, 470	720102	438
700181	377	700296	310, 311	701093	466, 470	720103	438
700182	379, 380	700297	312, 313	701120	354, 373	720104	439
700183	379, 380	700298	314	701121	353, 373	720105	439
700184	381	700299	315	701126	348, 351	720106	439
700185	382	700308	333, 334	701127	349, 352	720107	439
700196	412	700309	335, 336	703012	308	720108	442
700197	421	700310	333, 334	703013	308	720113	440
700198	378	700311	335, 336	703014	308	720114	448
700212	355	700312	333, 334	703015	308	720115	448
700213	358	700313	335, 336	703016	308	720116	448
700214	361, 362	700314	337, 338	703017	308	720119	449

Numerical Index

Model-No.	Page	Model-No.	Page	Model-No.	Page	Model-No.	Page
72		730011	508	7594	597, 639	790144	446, 447
720120	449	7330	609	7595	597, 639	790145	446, 447
720121	449	7331	609	7596	640	790146	446, 447
720122	449	7332	609			790147	445, 447
720123	449	7333	609	76		790148	446, 447
720124	449	7340	558	7641	559	790149	446, 447
720125	449	7341	558	7642	559	790150	446, 447
720126	449	7342	558	7643	559	790151	445, 446, 447
720127	450	7343	558	7644	559	790153	406, 422
720128	450	7344	558	7692	639	790154	410, 422
720129	450	7346	558	7693	597	790155	406, 408, 422
720130	450			7694	597, 639	790156	408, 422
720131	450	75		7695	597, 639	790157	347, 351
720132	450	7501	491	7696	640	790158	440, 441, 443
720133	450	7502	491			790213	406, 408, 422
720134	450	7503	493	77		790215	258, 260, 266
720135	451	7504	493	770001	455, 456	790216	258, 260, 266
720136	451	7505	495	770002	455, 456	790225	302, 307
720137	452	7506	495	770003	455, 456	790226	304, 305, 307
720138	452	7507	497	770004	457, 458	790227	303, 307
720139	453	7508	497	770005	457, 458	790236	271, 272, 276
720140	453	7509	489	770006	347, 351, 459	790247	274, 275, 276
7229	609	7510	489	770007	347, 351, 460	790253	311, 313
7240	557	751010	220, 224			790254	314, 315
7241	557	751090	220, 225	79		790261	445, 446, 447
7242	557	7511	503	790001	353, 354, 373	790262	445, 446, 447
7243	557	751110	220, 224	790002	406, 408, 477	790263	448, 449, 515
7244	557	751190	220, 225	790003	271, 272, 277	790269	448, 449, 515
7246	557	7512	503	790004	274, 275, 468	790285	300, 377, 512
7255	539	751290	219, 223	790005	324, 325, 332	790286	300, 377, 512
7256	539	7513	501	790006	347, 348, 351	790287	254, 256
7257	539	7514	501	790007	284, 286, 294	790288	254, 256
7258	539	751445	227	790008	288, 289, 294	790289	285, 287, 512
7265	539	751455	226	790009	333, 335, 344	790290	285, 287, 512
7266	570	751475	226	790010	393, 395, 398	790291	513
7267	570	751555	227	790100	254, 259, 512	790292	513
7268	570	751690	218, 222	790101	448, 449, 514	790293	289, 290, 512
7269	570	751790	218, 222	790102	448, 449, 514	790294	289, 290, 512
7270	570	751810	217, 221	790103	254, 258, 512	790295	382, 387, 513
7271	570	751910	217, 221	790104	254, 258, 512	790296	382, 387, 513
7275	539	752010	217, 221	790105	316, 317, 512	790297	324, 325, 332
7276	539	752110	217, 221	790114	514	790298	324, 325, 332
7277	539	752210	218, 222	790115	514	790299	327, 331, 513
7278	539	7530	609	790123	271, 272, 468	790301	515
7285	539	7531	610	790125	302, 303, 443	790302	515
7290	638	7532	610	790126	302, 303, 443	790340	445, 446, 515
7291	597	7533	610	790127	302, 303, 443	790414	386
7292	638	7535	540	790128	305, 307	790415	388
7293	597	7536	540	790129	438, 439, 443	790418	254
7294	597, 638	7537	540	790131	258, 260, 266	790419	254
7295	597, 638	7538	540	790137	445, 447	790420	300
7296	638	7541	559	790138	446, 447	790421	301
7297	639	7542	559	790139	446, 447	790450	390, 391, 392
		7543	559	790140	445, 447	790453	406
		7544	559	790141	446, 447	790455	259
73		7592	639	790142	446, 447	790456	259
730009	506	7593	597	790143	445, 447	790457	263
730010	507						

Numerical Index

Model-No.	Page	Model-No.	Page	Model-No.	Page	Model-No.	Page
790468	300	790878	467, 469	791431	285	791495	450
790469	302	790880	466, 468	791432	287	791496	450
790470	302	790881	272, 275, 277	791433	285	791497	450
790471	303	790882	272, 275, 277	791434	287	791498	451
790472	302	790883	271, 272, 277	791435	285	791499	451
790473	303	790884	274, 275, 468	791436	287	7915	493
790474	302	790885	274, 275, 468	791437	288	791500	452
790475	304	790886	274, 275, 468	791438	289	791501	452
790476	305	790887	467, 469	791439	394	791502	453
790477	306	790888	467, 469	791440	394	791503	453
790478	438	790889	467, 469	791441	394	7916	491, 493, 497
790479	438	790890	467, 469	791442	394	7917	489
790480	438	7910	560	791443	394	791803	467, 469
790481	439	7911	571	791444	394	791804	467, 469
790482	439	7912	598, 640	791445	394	791805	273, 278, 468
790483	439	791200	327, 331, 513	791446	395	791806	273, 278, 468
790484	439	791201	316, 318	791447	397	791808	467, 468
790485	442	791202	316, 318	791448	397	791809	475, 476, 477
790489	429	791203	317, 318	791449	397	791811	421, 423
790490	430	791204	317, 318	791451	440	791812	421, 423
790491	431	791205	255, 300, 513	791452	440	791813	421, 423
790492	432	791206	285, 287, 513	791453	440	791824	510
790493	433	791207	324, 325, 513	791454	440	791825	511
790494	434	791210	387, 389, 513	791455	441	791828	510
790495	408	791217	438, 439, 443	791456	441	791829	511
790496	410	791219	339, 340, 344	791457	441	791846	509
7905	540	791220	339, 340, 344	791458	441	791847	284, 286, 294
790592	506, 507, 509	791221	334, 336, 344	791459	440	791848	290, 291, 294
790598	467, 470, 477	791222	334, 336, 344	791460	311, 313	791849	292, 294
7906	540	791226	288, 289, 513	791462	311, 313	791850	255, 259, 514
790650	316, 317, 434	791227	288, 289, 514	791464	311, 313	791851	254, 259, 514
790831	406, 408, 422	791228	339, 340, 513	791466	314	791852	255, 259, 514
790832	406, 408, 477	791229	339, 340, 514	791467	315	791853	255, 259, 514
790840	254, 259, 514	791230	317, 324, 513	791468	334, 336	791859	467, 468, 477
790842	413, 418, 423	791231	324, 325, 514	791470	334, 336	791860	467, 469, 477
790843	415, 419, 423	791232	314, 315	791472	334, 336	791861	510
790844	417, 420, 423	791233	271, 272, 276	791474	338	791862	511
790846	271, 272, 278	791234	271, 273, 276	791475	338	791863	510
790848	410, 413, 422	791235	327, 331, 513	791476	343	791864	511
790850	515	791236	274, 275, 276	791477	448	791865	510
790851	271, 272, 277	791237	406, 408, 422	791478	448	791866	511
790852	271, 272, 277	791238	415, 417, 422	791479	448	791867	475, 477
790855	271, 272, 278	791239	407, 409, 422	791480	449	791868	476, 477
790856	271, 272, 278	791240	347, 351	791481	449	791869	475, 476, 477
790857	271, 272, 278	791241	347, 351	791482	449	791870	475, 476, 477
790858	271, 272, 278	791404	263	791483	449	791920	377, 378
790859	413, 423	791405	263	791484	449	791922	380
790860	415, 423	791406	412	791485	449	791923	380
790861	417, 423	791418	355	791486	449	791924	381
790866	274, 275, 277	791419	358	791487	449	7920	503
790867	274, 275, 468	791420	362	791488	449		
790868	274, 275, 278	791421	368	791489	449	82	
790869	274, 275, 278	791422	362	791490	450	8270	570
790870	274, 275, 278	791423	368	791491	450	8271	570
790871	274, 275, 278	791425	317	791492	450	8272	570
790875	412, 421, 477	791427	316	791493	450	8273	570
790876	421, 423	791430	316	791494	450	828C	569

Numerical Index

Model-No.	Page	Model-No.	Page	Model-No.	Page	Model-No.	Page
82		8682	480	8904	269, 297, 437	8995	297
829C	569	8683	480	8905	269, 402	8996	297
83		8690	480	8906	269, 297, 437	8997	297
8370	578	8691	480	8907	269, 402	8998	297
8371	578	8692	480	8908	402	8999	297
8372	578	8693	480	8909	402	90	
8373	578	87		8910	402	9050	575
8374	578	8710	376	8911	402	9051	575
8375	578	8711	376	8912	402	9055	575
8377	579	8712	376	8915	402	9090	575
8378	579	8713	376	8916	402	9091	575
8380	579	8714	376	8917	402	91	
8381	579	8715	376	8918	402	9108	625
8382	579, 580	872700	128	8919	402	9156	534
8383	579	872710	128	8922	403	9157	534
8384	579	872900	133	8923	403	9158	535
8385	579, 580	872910	133	8924	403	92	
8388	579, 580	8750	282	8925	403	9200	617
85		8751	282	8926	403	9201	617
850000	58, 154	8752	282	8936	403	9202	617
8520	580	8755	298, 321, 403	8937	298, 322, 403	9203	618
8521	580	8760	282, 473	8938	269, 298, 437	9205	618
8522	580	8761	282, 473	8939	269, 298, 437	9206	619
8523	580	8762	282, 473	8941	269, 298, 437	9250	598
8524	581	8763	473	8942	269, 403	9251	598
8525	581	8764	473	8946	321	9252	599
8526	582	8765	473	8947	321	9253	599
8527	581	8772	269	8948	321	9272	534
8528	581	8773	269	8949	322	9275	530
8529	581	8775	298, 321, 403	8951	322	9276	530
8530	582	8776	269, 298, 437	8952	321	94	
8531	581	8777	269, 298, 437	8953	321	9408	533
8532	581	8778	269, 298, 437	8954	321	9420	617
8533	581	8780	297, 321, 402	8955	322	9421	617
8534	582	8781	269, 297, 437	8965	298	9422	617
856C	527	8782	269, 297, 437	8966	298	9424	617
857C	528	8783	269, 297, 437	8967	298	9425	617
858C	528	8785	297, 321, 402	8968	298	9427	624
859C	528	8786	269, 297, 437	8969	298	9428	624
86		8787	269, 297, 437	8970	385	9429	624
8650	427	8788	269, 297, 437	8971	385	95	
8652	428	88		8972	385	9520	622
8654	427	8837	426	8973	385	9523	622
8655	427	8840	426	8974	385	9526	622
8657	428	8842	427	8975	385	9528	622
8659	428	8844	426	8976	385	9529	623
8660	427	8845	426	8977	385	9542	585
8666	427	8847	427	8978	385	9543	588
8669	428	8849	426	8979	385	9546	589
8670	428	8855	426	8980	385	9547	589
8674	428	89		8981	385	9550	589
8675	428	8900	269	8990	297	9553	578
8680	480	8901	269	899025	47, 62, 235		
8681	480	8902	269, 298, 437	8991	297		
		8903	269, 403	8992	297		
				8993	297		
				8994	297		

Numerical Index

Model-No.	Page	Model-No.	Page	Model-No.	Page	Model-No.	Page
9554	578	98					
9555	578	9870	645				
9556	578	9871	572				
9557	578	9872	572				
9572	578	9873	572				
9573	578	9874	572				
9574	578	9881	572				
		9882	572				
		9883	572				
96		9884	572				
9614	586, 645	9891	572				
9615	586, 645	9892	572				
9616	586, 645	9893	572				
9620	586, 646	9894	572				
9638	531, 644						
9639	532, 645	99					
9640	624	9902	529, 554, 637				
9642	531, 644	9903	529, 554, 638				
9645	530	9904	529, 554, 584				
9646	530	9905	556				
9647	530	9907	529, 584				
9648	530	9910	560, 598				
9650	532	9911	608				
9651	533	9913	535, 648				
9652	533	9914	535, 649				
9653	533	9915	623				
9672	587	9917	596, 637				
9673	587	9920	619				
9674	587	9921	619				
9675	587	9922	575				
9676	588	9926	529, 554, 637				
9677	588	9933	570, 616				
9678	588	9938	570				
9679	588	9970	527				
9680	586, 645	9983	529, 585				
9681	586, 645	9984	529, 585				
9682	586, 645	9985	523, 582, 638				
		9986	523, 582, 638				
97		9990	554				
9700	647						
9701	647						
9702	647						
9703	647						
9705	648						
9706	648						
9707	648						
9708	648						
9716	623						
9717	623						
9718	623						
9720	624						
9721	624						
9770	646						
9771	646						
9772	646						
9773	646						

International Standards

Series	Description	Model #	USA + Canada
1930	Bidet wall mounted	026610	●
	Washbasin	043860	●
	Washbasin	043870	●
	Handrinse basin	078550	●
	Handrinse basin	079342	●
	Cistern US	087230	HET
	Two-Piece toilet US version	213001	HET
2nd floor	Bidet wall mounted	223515	●
	Vanity basin	031653	●
	Above counter basin	031758	●
	Washbasin	049112	●
	Washbasin	049160	●
	Washbasin	049170	●
	Washbasin	049180	●
	Handrinse basin	079040	●
	Handrinse basin	079050	●
	Toilet wall mounted	220509	HET
	Toilet wall mounted	222009	HET
Architec	Washbasin H70	044358	●
	Washbasin	044845	●
	Washbasin	044958	●
	Washbasin	045058	●
	Vanity basin	046840	●
	Handrinse basin	076635	●
	Urinal	081836	HET
	Urinal	082036	HET
	Bacino	Above counter basin	032542
Above counter basin		033342	●
Above counter basin		033452	●
Caro	Two-Piece toilet	010101	HET
	Toilet wall mounted	015609	HET
	Bidet wall mounted	029015	●
	Cistern	092410	HET
	Urinal	083630	HET
Darling New	Cistern	093110	HET
	Cistern	093120	HET
	One-Piece toilet	212301	HET
	One-Piece toilet	212351	●
	Two-Piece toilet	212601	HET
	Two-Piece toilet	212651	●
	Toilet close-coupled	213809	HET
	Toilet wall mounted	254409	HET
	Toilet wall mounted	254459	●
	Toilet wall mounted	254459	HET
	Toilet wall mounted	254409	HET
	One-Piece toilet	212351	●
	One-Piece toilet	212301	●
	Two-Piece toilet	212651	HET
	Two-Piece toilet	212601	HET
Toilet wall mounted	254509	HET	
Toilet floor standing	213909	HET	
D-Code	One-Piece toilet	011301	HET
	Two-Piece toilet	011701	HET
	Handrinse basin	070545	●
	Cistern	092720	HET
	Toilet wall mounted	222309	●
DuraStyle	Washbasin	231055	●
	One-Piece toilet	215751	HET
	One-Piece toilet	215701	HET
	Two-Piece toilet	216051	HET
	Two-Piece toilet	216001	HET
	Toilet close-coupled	215609	HET
	Toilet close-coupled	215659	HET
	Toilet wall mounted	253809	HET
	Toilet wall mounted	254209	HET
	Toilet wall mounted	254259	HET
	Toilet wall mounted	253709	HET

● = listed

International Standards

Series	Description	Model #	USA + Canada
Bathroom Foster	Bidet wall mounted	013415	●
	Toilet wall mounted	017509	HET
	Washbowl	033550	●
	Washbasin	041955	●
Happy D.2	Toilet close-coupled	213409	HET
	Toilet wall mounted	255009	HET
	Toilet wall mounted	255059	HET
	One-piece toilet	212101	HET
	One-piece toilet	212151	HET
	Toilet wall mounted	222109	HET
Metro	One-Piece Toilet	015701	HET
	Bidet floor standing	026210	●
PuraVida	Cistern	087270	HET
	Toilet close-coupled	211909	HET
	Toilet wall mounted	221909	HET
Scola	Washbasin	068460	●
	Washbasin	068560	●
Starck 1	Toilet wall mounted	021009	HET
	Bidet wall mounted	027415	●
	Washbasin	040575	●
	Washbasin	040590	●
	Washbasin	230370	●
	Washbasin	230557	●
	Washbasin	230710	●
	Furniture Washbasin	040658	●
	Above counter basin	040833	●
	Above counter basin	040853	●
	Above counter basin	044546	●
	Above counter basin	044648	●
	Above counter basin	044753	●
	Urinal	083432	HET
	Urinal	083532	HET
Starck 2	Toilet wall mounted	253359	HET
	Toilet wall mounted	253309	HET
	Toilet close-coupled	212959	HET
	Toilet close-coupled	212909	HET
	One piece toilet	213351	HET
	One piece toilet	213301	HET
	Toilet wall mounted	253409	HET
	Toilet floor standing	212809	HET
	Toilet wall mounted	222659	HET
Starck 3	Toilet wall mounted	222609	HET
	One-Piece toilet	212051	●
	One-Piece toilet	212001	●
	Two-Piece toilet	212551	HET
	Two-Piece toilet	212501	HET
	Toilet close-coupled	214159	●
	Toilet close-coupled	214109	●
	Toilet wall mounted	222509	HET
	Toilet floor standing	215859	HET
	Toilet wall mounted Compact	222709	HET
	Toilet close-coupled	012809	HET
	Washbasin	030050	●
	Washbasin	030055	●
	Washbasin	030060	●
	Washbasin	030065	●
	Vanity basin	030256	●
	Vanity basin	030348	●
	Furniture Washbasin	030410	●
	Furniture Washbasin	030470	●
	Furniture Washbasin	030480	●
	Vanity basin	030549	●
	Washbasin Vital	030970	●
	Semi-recessed washbasin	031055	●
	Handrinse basin	075045	●
	Handrinse basin	075150	●
Corner handrinse basin	075244	●	
Urinal	082135	HET	

● = listed

International Standards

Series	Description	Model #	USA + Canada
	Urinal	082444	HET
	Urinal	082544	HET
	Cistern	092000	●
	Cistern	092010	HET
	Cistern (2-piece)	092040	HET
	One-Piece toilet	212001	HET
	One-Piece toilet	212051	HET
	Two-Piece toilet	212551	HET
	Toilet floor standing	215809	HET
	Toilet wall mounted	222659	HET
	Two-Piece toilet	212501	HET
	Toilet wall mounted	220009	HET
	Toilet wall mounted	220209	HET
	Toilet wall mounted Vital	220309	HET
	Toilet wall mounted	222509	●
	Toilet wall mounted	222609	HET
	Bidet floor standing	223010	●
	Bidet wall mounted	223015	●
	Bidet floor standing	223410	●
Urinals	McDry	084436	●
	Utronic	083035	●
Vero	Semi-recessed washbasin	031455	●
	Vanity basin	031555	●
	Furniture Washbasin	032910	●
	Furniture Washbasin	032912	●
	Furniture Washbasin	032985	●
	Vanity basin	033048	●
	Above counter basin	045250	●
	Above counter basin	045260	●
	Washbasin	045360	●
	Washbasin	045410	●
	Washbasin	045450	●
	Washbasin	045460	●
	Washbasin	045480	●
	Washbowl	045550	●
	Above counter basin	045560	●
	Handrinse basin	070225	●
	Handrinse basin	070350	●
	Handrinse basin	070445	●
	Cistern	090910	HET
	One-Piece toilet	210301	HET
	Toilet close-coupled	211609	HET
	Toilet floor standing	211709	HET
	Toilet wall mounted	221709	HET
	Bidet wall mounted	223915	●
	Bidet floor standing	224010	●
	Urinal	280032	HET
	Urinal	280132	HET

Ceramics

Ceramics

Ceramics

Ceramics

Barrier-free applications



Washbasin Med
Architec # **044358**
575 x 520 mm



Washbasin Med
D-Code # **231165**
650 x 500 mm



Washbasin Med
D-Code # **231160**
600 x 460 mm



Washbasin Med
D-Code # **231155**
550 x 430 mm



Washbasin
D-Code # **231260**
600 x 550 mm



Washbasin Med
D-Code # **231360**
600 x 550 mm



Furniture washbasin Med
D-Code # **035285**
850 x 480 mm



Washbasin Med
DuraStyle # **232465**
650 x 440 mm



Washbasin Med
DuraStyle # **232460**
600 x 440 mm



Washbasin Med
DuraStyle # **232455**
550 x 440 mm



Washbasin Med
Starck 3 # **030760**
600 x 450 mm



Washbasin Med
Starck 3 # **030755**
550 x 420 mm



Washbasin Med
Starck 3 # **030750**
500 x 360 mm



Washbasin
Starck 3 # **030970**
700 x 545 mm



Washbasin
Starck 3 # **030960**
600 x 545 mm



Washbasin Med
Starck 3 # **031270**
700 x 545 mm



Washbasin Med
Starck 3 # **031260**
600 x 545 mm



Toilet wall mounted
Architec # **019009**
350 x 700 mm



Toilet wall mounted
Architec # **024309**
350 x 700 mm



Toilet wall mounted
D-Code # **222809**
360 x 700 mm



Toilet wall mounted
Starck 3 # **220309**
360 x 700 mm

Furniture washbasins



Furniture washbasin
2nd floor # **049112**
1200 x 505 mm



Furniture washbasin
2nd floor # **049112**
1200 x 505 mm



Furniture washbasin
2nd floor # **049180**
800 x 500 mm



Furniture washbasin
2nd floor # **049160**
600 x 430 mm



Furniture handrinse basin
2nd floor # **079040**
400 x 300 mm



Furniture washbasin
Darling New # **049910**
1030 x 545 mm



Furniture washbasin
Darling New # **049983**
830 x 545 mm



Furniture washbasin
Darling New # **049963**
630 x 520 mm



Furniture washbasin
Darling New # **049953**
530 x 430 mm



Furniture washbasin
D-Code # **034210**
1050 x 480 mm



Furniture washbasin
D-Code # **034285**
850 x 480 mm



Furniture washbasin Med
D-Code # **035285**
850 x 480 mm



Furniture washbasin
D-Code # **034265**
650 x 480 mm



Double furniture washbasin
D-Code # **034812**
1200 x 480 mm



Furniture washbasin
DuraStyle # **232012**
1200 x 480 mm



Furniture washbasin
DuraStyle # **232010**
1000 x 480 mm



Furniture washbasin
DuraStyle # **232080**
800 x 480 mm



Furniture washbasin
DuraStyle # **232065**
650 x 480 mm



Furniture washbasin asymmetric
DuraStyle # **232610**
1000 x 480 mm



Furniture washbasin asymmetric
DuraStyle # **232510**
1000 x 480 mm



Furniture washbasin asymmetric
DuraStyle # **232680**
800 x 480 mm



Furniture washbasin asymmetric
DuraStyle # **232580**
800 x 480 mm



Furniture washbasin
Esplanade # **262285**
850 x 535 mm



Furniture washbasin
Esplanade # **262260**
600 x 535 mm

Furniture washbasins



Furniture washbasin
Happy D.2 # **231812**
1200 x 505 mm



Furniture washbasin
Happy D.2 # **231812**
1200 x 505 mm



Furniture washbasin
Happy D.2 # **231810**
1000 x 505 mm



Furniture washbasin
Happy D.2 # **231880**
800 x 505 mm



Furniture washbasin
Happy D.2 # **231865**
650 x 505 mm



Furniture handrinse basin
Happy D.2 # **071050**
500 x 360 mm



Furniture washbasin
PuraVida # **037110**
1000 x 525 mm



Furniture handrinse basin
PuraVida # **072150**
500 x 420 mm



Furniture washbasin
Starck 1 # **040658**
Ø 580 mm



Furniture washbasin
Starck 1 # **038647**
Ø 470 mm



Furniture washbasin
Starck 1 # **038747**
470 x 470 mm



Furniture washbasin
Starck 3 # **030410**
1050 x 485 mm



Furniture washbasin
Starck 3 # **030480**
850 x 485 mm



Furniture washbasin
Starck 3 # **030470**
700 x 490 mm



Furniture washbasin
Starck 3 # **030348**
480 x 465 mm



Double furniture washbasin
Starck 3 # **033213**
1300 x 485 mm



Furniture washbasin
Vero # **032912**
1250 x 490 mm



Furniture washbasin
Vero # **032910**
1050 x 490 mm



Furniture washbasin
Vero # **032985**
850 x 490 mm



Furniture handrinse basin
Vero # **070350**
500 x 250 mm



Furniture handrinse basin
Vero # **070445**
450 x 350 mm

Guest bathrooms



Handrinse basin
1930 Series # **078550**
500 x 365 mm



Handrinse basin corner model
1930 Series # **079342**
595 x 450 mm



Handrinse basin
2nd floor # **079050**
500 x 400 mm



Handrinse basin
2nd floor # **079040**
400 x 300 mm



Furniture handrinse basin
2nd floor # **079040**
400 x 300 mm



Washbowl
Bacino # **033342**
420 x 420 mm



Washbowl
Bacino # **032542**
Ø 420 mm



Washbowl
Bagnella # **045140**
Ø 400 mm



Handrinse basin
Caro # **079150**
500 x 365 mm



Handrinse basin
Darling New # **073147**
470 x 345 mm



Handrinse basin
D-Code # **070650**
500 x 220 mm



Handrinse basin
D-Code # **070545**
450 x 340 mm



Handrinse basin
D-Code # **070536**
360 x 270 mm



Handrinse basin
DuraStyle # **071350**
500 x 220 mm



Handrinse basin
DuraStyle # **070845**
450 x 335 mm



Handrinse basin
Happy D.2 # **070950**
500 x 360 mm



Handrinse basin
Happy D.2 # **071150**
500 x 220 mm



Handrinse basin
PuraVida # **072050**
500 x 420 mm



Furniture handrinse basin
PuraVida # **072150**
500 x 420 mm



Washbowl
Starck 1 # **040833**
Ø 330 mm



Handrinse basin
Starck 2 # **071450**
500 x 390 mm



Handrinse basin
Starck 2 # **076138**
380 x 260 mm



Handrinse basin
Vero # **070350**
500 x 250 mm



Furniture handrinse basin
Vero # **070350**
500 x 250 mm

Guest bathrooms



Handrinse basin
Vero # **070445**
450 x 350 mm



Furniture handrinse basin
Vero # **070445**
450 x 350 mm



Handrinse basin
Vero # **070225**
250 x 450 mm

Japan toilets



One-piece toilet
Starck 3 # **212451**
370 x 735 mm



One-piece toilet
Starck 3 # **212401**
370 x 735 mm



Two-piece toilet
Starck 3 # **212751**
370 x 720 mm



Two-piece toilet
Starck 3 # **212701**
370 x 720 mm

Urinals



Urinal
Architec # **081837**
380 x 350 mm



Urinal
Architec # **081737**
380 x 350 mm



Urinal
Architec # **082037**
380 x 385 mm



Urinal
Architec # **081937**
380 x 385 mm



Urinal
Architec # **081836**
380 x 350 mm



Urinal
Architec # **082036**
380 x 385 mm



Urinal Dry
Architec # **081835**
380 x 350 mm



Urinal Ben
Urinals, various # **084737**
370 x 350 mm



Urinal Ben
Urinals, various # **084837**
370 x 350 mm



Urinal Bill
Urinals, various # **085135**
345 x 350 mm



Urinal
Caro # **083630**
300 x 250 mm



Urinal
D-Code # **082830**
305 x 295 mm



Urinal
D-Code # **082930**
305 x 295 mm



Urinal
DuraStyle # **280430**
300 x 340 mm



Urinal
DuraStyle # **280530**
300 x 340 mm



Urinal
DuraStyle # **280630**
300 x 340 mm



Urinal
DuraStyle # **280730**
300 x 340 mm



Urinal
DuraStyle # **280431**
300 x 340 mm



Urinal
DuraStyle # **280631**
300 x 340 mm



Urinal Dry
DuraStyle # **280830**
300 x 340 mm



Urinal Fizz
Urinals, various # **082336**
305 x 285 mm



Urinal Fizz
Urinals, various # **082335**
305 x 285 mm



Urinal Jim
Urinals, various # **085035**
345 x 350 mm



Urinal McDry
Urinals, various # **084436**
365 x 335 mm

Urinals



Urinal
Starck 1 # **083432**
320 x 285 mm



Urinal
Starck 1 # **083532**
320 x 285 mm



Urinal
Starck 3 # **082135**
330 x 350 mm



Urinal
Starck 3 # **082235**
330 x 350 mm



Urinal
Starck 3 # **082444**
450 x 350 mm



Urinal
Starck 3 # **082544**
450 x 350 mm



Urinal
Starck 3 # **082625**
245 x 300 mm



Urinal
Starck 3 # **082725**
245 x 300 mm



Urinal Utronic
Urinals, various # **083037**
345 x 315 mm



Urinal
Vero # **280032**
295 x 320 mm



Urinal
Vero # **280132**
295 x 320 mm



Ceramic urinal partition
Starck 3 # **850000**
705 x 400 mm

US toilets



One-piece toilet
Darling New # **212301**
405 x 715 mm



One-piece toilet
Darling New # **212351**
405 x 715 mm



One-piece toilet
D-Code # **011301**
395 x 735 mm



One-piece toilet
DuraStyle # **215701**
370 x 720 mm



One-piece toilet
DuraStyle # **215751**
370 x 720 mm



One-piece toilet
Happy D.2 # **212101**
385 x 710 mm



One-piece toilet
Happy D.2 # **212151**
385 x 710 mm



One-piece toilet
US toilets, various # **015701**
385 x 740 mm



One-piece toilet
Starck 2 # **213301**
375 x 715 mm



One-piece toilet
Starck 2 # **213351**
375 x 715 mm



One-piece toilet
Starck 3 # **212001**
370 x 715 mm



One-piece toilet
Starck 3 # **212051**
370 x 715 mm



One-piece toilet
Vero # **210301**
370 x 715 mm



Two-piece toilet
1930 series # **213001**
360 x 665 mm



Two-piece toilet
Caro # **010101**
360 x 750 mm



Two-piece toilet
Darling New # **212601**
370 x 700 mm



Two-piece toilet
Darling New # **212651**
370 x 700 mm



Two-piece toilet
D-Code # **011701**
350 x 685 mm



Two-piece toilet
DuraStyle # **216001**
385 x 700 mm



Two-piece toilet
DuraStyle # **216051**
385 x 700 mm



Two-piece toilet
Happy D.2 # **011201**
365 x 700 mm



Two-piece toilet
Starck 3 # **212501**
370 x 705 mm



Two-piece toilet
Starck 3 # **212551**
370 x 705 mm

Vanity basins - countertop version



Vanity basin
1930 series # **047658**
580 x 470 mm



Vanity basin
2nd floor # **034760**
600 x 430 mm



Vanity basin
2nd floor # **031758**
580 x 415 mm



Vanity basin
Architec # **031850**
Ø 500 mm



Vanity basin
Architec # **046847**
Ø 470 mm



Vanity basin
Architec # **031845**
Ø 450 mm



Vanity basin
Architec # **031840**
Ø 400 mm



Vanity basin Bali
Architec # **047334**
Ø 335 mm



Vanity basin
Caro # **046157**
560 x 445 mm



Vanity basin
D-Code # **033754**
545 x 435 mm



Vanity basin
DuraStyle # **037462**
615 x 495 mm



Vanity basin
DuraStyle # **037260**
600 x 430 mm



Vanity basin
DuraStyle # **037456**
560 x 455 mm



Vanity basin
DuraStyle # **037243**
430 x 430 mm



Vanity basin
DuraStyle # **262943**
Ø 430 mm



Vanity basin
Happy D.2 # **048360**
600 x 460 mm



Vanity basin Manua
Vanity basins, various # **522048**
Ø 480 mm



Vanity basin
Starck 1 # **040753**
Ø 535 mm



Vanity basin
Starck 2 # **232748**
Ø 480 mm



Vanity basin
Starck 3 # **030256**
560 x 460 mm



Vanity basin
Starck 3 # **030348**
480 x 465 mm



Vanity basin
Vero # **031555**
550 x 465 mm



Vanity basin
Vero # **031550**
500 x 465 mm

Vanity basins - Semi-recessed washbasins



Semi-recessed washbasin
D-Code # **033955**
550 x 440 mm



Semi-recessed washbasin
DuraStyle # **037555**
550 x 455 mm



Semi-recessed washbasin
Starck 3 # **031055**
550 x 460 mm



Semi-recessed washbasin
Vero # **031455**
550 x 470 mm

Vanity basins - undercounter version



Vanity basin
2nd floor # **031653**
525 x 350 mm



Vanity basin
Architec # **031942**
Ø 420 mm



Vanity basin
Architec # **046240**
Ø 400 mm



Vanity basin
Architec # **046340**
Ø 400 mm



Vanity basin
Architec # **046840**
Ø 400 mm



Vanity basin
Architec # **031937**
Ø 375 mm



Vanity basin
Architec # **031932**
Ø 325 mm



Vanity basin
Architec # **031927**
Ø 275 mm



Vanity basin
D-Code # **033856**
560 x 400 mm



Vanity basin
D-Code # **033849**
495 x 290 mm



Vanity basin
DuraStyle # **037337**
370 x 370 mm



Vanity basin
Bathroom_Foster # **033643**
430 x 280 mm



Vanity basin
Happy D.2 # **045748**
480 x 345 mm



Vanity basin Santosa
Vanity basins, various # **046651**
510 x 375 mm



Vanity basin
Starck 3 # **030249**
490 x 365 mm



Vanity basin
Starck 3 # **030549**
490 x 365 mm



Vanity basin
Starck 3 # **030543**
430 x 430 mm



Vanity basin
Vero # **033048**
485 x 315 mm



Vanity basin
Vero # **033043**
430 x 315 mm

Washbowls



Washbowl
2nd floor # **031758**
580 x 415 mm



Above counter basin
Architec # **032050**
500 x 500 mm



Above counter basin
Architec # **032045**
450 x 450 mm



Above counter basin
Architec # **032042**
420 x 420 mm



Above counter basin
Architec # **032040**
400 x 400 mm



Washbowl
Bacino # **033452**
550 x 420 mm



Washbowl
Bacino # **033342**
420 x 420 mm



Washbowl
Bacino # **032542**
Ø 420 mm



Washbowl
Bagnella # **045148**
Ø 480 mm



Washbowl
Bagnella # **045140**
Ø 400 mm



Above counter basin
Darling New # **049747**
Ø 470 mm



Washbowl
DuraStyle # **034960**
600 x 380 mm



Washbowl
DuraStyle # **034943**
430 x 430 mm



Washbowl
Bathroom_Foster # **033550**
495 x 350 mm



Washbowl
Happy D.2 # **231765**
650 x 400 mm



Washbowl
Happy D.2 # **231460**
600 x 400 mm



Washbowl
Happy D.2 # **231560**
600 x 475 mm



Washbowl
Happy D.2 # **231440**
400 x 400 mm



Washbowl
PuraVida # **037070**
700 x 420 mm



Washbowl +
PuraVida # **036970**
700 x 450 mm



Washbowl
Starck 1 # **044753**
Ø 530 mm



Washbowl
Starck 1 # **040853**
Ø 530 mm



Above counter basin
Starck 1 # **044648**
Ø 480 mm



Washbowl
Starck 1 # **038647**
Ø 470 mm

Washbowls



Washbowl
Starck 1 # **038747**
470 x 470 mm



Washbowl
Starck 1 # **044546**
Ø 460 mm



Washbowl
Starck 1 # **232246**
460 x 460 mm



Washbowl
Starck 1 # **040833**
Ø 330 mm



Washbowl
Starck 2 # **232144**
440 x 400 mm



Washbowl
Vero # **045560**
600 x 380 mm



Washbowl
Vero # **045550**
500 x 380 mm









Above counter basin
Vero # **045260**
595 x 465 mm









Above counter basin
Vero # **045250**
500 x 470 mm

1930 Series Design by Duravit

Description		mm	kg	Qty.	Model-No.	Euro
						White - 00
	Washbasin					
	with overflow, with tap platform					
	800 mm ● ● ●	800 x 550	29,5	8	043880 00 00	
	800 mm ● ● ●	800 x 550	29,5	8	043880 00 30	
	700 mm ● ● ●	700 x 500	23,0	10	043870 00 00	
	700 mm ● ● ●	700 x 500	23,0	10	043870 00 30	
	600 mm ●	600 x 410	13,5	15	043860 00 00	
600 mm ● ● ●	600 x 410	13,5	15	043860 00 30		
	Pedestal					
	for washbasins # 043880 and 043870	296 x 280	13,5	15	085790 00 00	
	for washbasin # 043860	270 x 255	11,7	15	085791 00 00	
	Handrinse basin					
	with overflow, with tap platform					
	500 mm ●	500 x 365	11,0	24	078550 00 00	
	Handrinse basin corner model					
	with overflow, with tap platform					
	595 mm ●	595 x 450	9,5	21	079342 00 00	
	Vanity basin					
	countertop basin, with overflow, with tap platform					
	580 mm ● ● ●	580 x 470	14,7	15	047658 00 00	
	580 mm ● ● ●	580 x 470	14,7	15	047658 00 30	
	Bidet wall mounted ●					
	with overflow with tap platform	360 x 580	21,9	16	026610 00 00	
	Fixing					
	for wall mounted bidet and wall mounted toilet					
	caps white	∅ 12 x 180	0,2		006500 00 00	
	caps chrome	∅ 12 x 180	0,2		006500 10 00	
<div style="border: 1px solid black; padding: 2px;"> Infobox: If pre-wall carrier not used, the fixing # 006500 is recommended </div>						
	Bidet floor standing ● ● ●					
	with overflow with tap platform	355 x 600	23,8	9	026710 00 00	
	Fixing					
	for floor standing bidet, floor standing toilet and siphon cover					
	caps white and chrome	∅ 6 x 70	0,4		006701 10 00	

1930 Series Design by Duravit

Description		mm	kg	Qty.	Model-No.	Euro
						White - 00
	Toilet wall mounted washdown model					
	♻️ 6,0 l	355 x 580	21,5	12	018209 00 00	
	Fixing for wall mounted bidet and wall mounted toilet					
	caps white	∅ 12 x 180	0,2		006500 00 00	
	caps chrome	∅ 12 x 180	0,2		006500 10 00	
	Noise reduction gasket for wall mounted toilet		0,3		005020 00 00	
	Toilet seat and cover without automatic closure, hinges chrome					
	octagonal seat hole			3,9	006481 00 00	
	oval seat hole			3,9	006661 00 00	
	Toilet seat and cover without automatic closure, walnut coloured, hinges chrome					
	oval seat hole			3,9	006221 00 00	
Infobox: If pre-wall carrier not used, the fixing # 006500 is recommended						
	Toilet close-coupled washdown model, (without cistern),					
	♻️ 6,0 l					
	vertical outlet	355 x 665	25,5	9	022701 00 00	
	horizontal outlet	355 x 665	25,0	9	022709 00 00	
	Fixing for floor standing bidet, floor standing toilet and siphon cover					
	caps white and chrome	∅ 6 x 70	0,4		006701 10 00	
	Cistern with Dual Flush mechanism, chrome,					
	♻️ 6,0 l					
	for side supply	430 x 175	15,7	27	087220 00 05	
	for bottom left supply	430 x 175	15,9	27	087221 00 05	
	Conversion set for back supply					
	chrome		0,5		007504 10 00	
	Toilet seat and cover without automatic closure, hinges chrome					
	octagonal seat hole			3,9	006481 00 00	
	oval seat hole			3,9	006661 00 00	
	Toilet seat and cover without automatic closure, walnut coloured, hinges chrome					
	oval seat hole			3,9	006221 00 00	



1930 Series Design by Duravit

	Description	mm	kg	Qty.	Model-No.	Euro
						White - 00
	Two-piece toilet (without cistern), elongated with syphonic jet action, US-version, 305 mm/12" rough-in, IAPMO listed, vertical outlet ♠ 1,28 gpf (4,8 l)	360 x 665	26,0	9	213001 00 00	
	Mounting set for One-piece and Two-piece toilets 1/2", US-version			0,48	001431 00 00	
	Mounting set for One-piece and Two-piece toilets 1/2"			0,48	001418 00 96	
	Cistern with Single Flush mechanism, chrome, bottom left supply ♠ 1,28 gpf (4,8 l)	420 x 175	15,5	27	087230 00 05	
	Toilet seat and cover without automatic closure, hinges chrome octagonal seat hole			3,9	006481 00 00	
	oval seat hole			3,9	006661 00 00	
	Toilet seat and cover without automatic closure, walnut coloured, hinges chrome oval seat hole			3,9	006221 00 00	
	Shelf 750 mm	750 x 130	5,0	55	089275 00 00	
	650 mm	650 x 130	4,5	60	089265 00 00	
	550 mm	550 x 130	3,5	60	089255 00 00	
	450 mm	450 x 130	3,0	85	089245 00 00	



WonderGliss
Simply add a '1' to
the model-no.

2nd floor Design by sieger design

Description	mm	kg	Qty.	Model-No.	Euro
					White - 00
 Washbasin with overflow, with tap platform, overflow clip chrome included, 1200 mm					
●	1200 x 505	36,5	8	049112 00 00	
● ● ●	1200 x 505	36,5	8	049112 00 30	
⊗	1200 x 505	36,5	8	049112 00 60	
 Design Siphon * chrome		1,5		005036 10 00	
 Design angle valve with rosette, chrome	1/2"	0,5		003045 10 00	
Pedestal for # 049112, 049180	200 x 215	16,2	30	086319 00 00	
Siphon cover for # 049112, 049180	205 x 320	8,4	32	085714 00 00	
Fixing for siphon cover		0,1		005503 00 00	
Flexible hose with angle connection (1 pair) for # 049112, 049180, 049170 and 049160 for 3 hole faucet	1/2" x 340	0,1		001402 10 00	

Infobox: * When using this siphon please observe outlet height from upper surface of finished floor to centre of outlet in accordance with the technical specification sheet / Attention: Flexible hose with angle connection in combination with washbasins with 3 hole faucet and siphon cover / For fixing the ceramics from the size 1200 mm 2 sets of washbasin fixations are required



Furniture washbasin with overflow, with tap platform, overflow clip chrome included, 1200 mm					
●	1200 x 505	36,5	8	049112 00 00	
● ● ●	1200 x 505	36,5	8	049112 00 30	
⊗	1200 x 505	36,5	8	049112 00 60	
Space saving siphon White	1 1/4"	0,4		005073 00 00	

Infobox: For fixing the ceramics from the size 1200 mm 2 sets of washbasin fixations are required / For vanity units the space saving siphon is recommended / Overview of furniture recommendation see page 656

2nd floor Design by sieger design



Description	mm	kg	Qty.	Model-No.	Euro
					White - 00
 Washbasin ground with overflow, with tap platform, overflow clip chrome included, 1200 mm					
●	1200 x 505	36,5	8	049112 00 27	
● ● ●	1200 x 505	36,5	8	049112 00 25	
⊗	1200 x 505	36,5	8	049112 00 28	
Design Siphon * chrome		1,5		005036 10 00	
Design angle valve with rosette, chrome	1/2"	0,5		003045 10 00	
Infobox: * When using this siphon please observe outlet height from upper surface of finished floor to centre of outlet in accordance with the technical specification sheet / For fixing the ceramics from the size 1200 mm 2 sets of washbasin fixations are required / Overview of furniture recommendation see page 656					





Washbasin with overflow, with tap platform, overflow clip chrome included 1200 mm ● ●	1200 x 505	36,5	8	049112 00 24	
Design Siphon * chrome		1,5		005036 10 00	
Design angle valve with rosette, chrome	1/2"	0,5		003045 10 00	
Push-open waste *** chrome		0,35		005052 10 00	
Pedestal for # 049112, 049180	200 x 215	16,2	30	086319 00 00	
Siphon cover for # 049112, 049180	205 x 320	8,4	32	085714 00 00	
Fixing for siphon cover		0,1		005503 00 00	
Flexible hose with angle connection (1 pair) for # 049112, 049180, 049170 and 049160 for 3 hole faucet	1/2" x 340	0,1		001402 10 00	

Infobox: * When using this siphon please observe outlet height from upper surface of finished floor to centre of outlet in accordance with the technical specification sheet / *** Required in conjunction with wall mounted tap fitting, vanity unit and/or consoles / Attention: Flexible hose with angle connection in combination with washbasins with 3 hole faucet and siphon cover / For fixing the ceramics from the size 1200 mm 2 sets of washbasin fixations are required / In conjunction with pop-up basin waste or push-open valve the flow capacity of max. 7,5l /min./tap should not be exceeded

2nd floor Design by sieger design

Description	mm	kg	Qty.	Model-No.	Euro	
					White - 00	
 <p>Furniture washbasin with overflow, with tap platform, overflow clip chrome included 1200 mm ● ●</p>	1200 x 505	36,5	8	049112 00 24		
Push-open waste *** chrome		0,35		005052 10 00		
Space saving siphon White	1 1/4"	0,4		005073 00 00		
<p>Infobox: *** Required in conjunction with wall mounted tap fitting, vanity unit and/or consoles / For fixing the ceramics from the size 1200 mm 2 sets of washbasin fixations are required / For vanity units the space saving siphon is recommended / In conjunction with pop-up basin waste or push-open valve the flow capacity of max. 7,5l /min./tap should not be exceeded / Overview of furniture recommendation see page 656</p>						
 <p>Washbasin ground with overflow, with tap platform, overflow clip chrome included 1200 mm ● ●</p>	1200 x 505	36,5	8	049112 00 26		
	Design Siphon * chrome		1,5		005036 10 00	
	Design angle valve with rosette, chrome	1/2"	0,5		003045 10 00	
	Push-open waste *** chrome		0,35		005052 10 00	
<p>Infobox: * When using this siphon please observe outlet height from upper surface of finished floor to centre of outlet in accordance with the technical specification sheet / *** Required in conjunction with wall mounted tap fitting, vanity unit and/or consoles / For fixing the ceramics from the size 1200 mm 2 sets of washbasin fixations are required / In conjunction with pop-up basin waste or push-open valve the flow capacity of max. 7,5l /min./tap should not be exceeded / Overview of furniture recommendation see page 656</p>						

2nd floor Design by sieger design

Description	mm	kg	Qty.	Model-No.	Euro
					White - 00
 Washbasin with overflow, with tap platform, overflow clip chrome included, 800 mm					
●	800 x 500	25,3	10	049180 00 00	
● ● ●	800 x 500	25,3	10	049180 00 30	
⊗	800 x 500	25,3	10	049180 00 60	
 Design Siphon * chrome					
		1,5		005036 10 00	
 Design angle valve with rosette, chrome	1/2"	0,5		003045 10 00	
Pedestal for # 049112, 049180	200 x 215	16,2	30	086319 00 00	
Siphon cover for # 049112, 049180	205 x 320	8,4	32	085714 00 00	
Fixing for siphon cover		0,1		005503 00 00	
Flexible hose with angle connection (1 pair) for # 049112, 049180, 049170 and 049160 for 3 hole faucet	1/2" x 340	0,1		001402 10 00	

Infobox: * When using this siphon please observe outlet height from upper surface of finished floor to centre of outlet in accordance with the technical specification sheet / Attention: Flexible hose with angle connection in combination with washbasins with 3 hole faucet and siphon cover



Furniture washbasin with overflow, with tap platform, overflow clip chrome included, 800 mm					
●	800 x 500	25,3	10	049180 00 00	
● ● ●	800 x 500	25,3	10	049180 00 30	
⊗	800 x 500	25,3	10	049180 00 60	
Space saving siphon White	1 1/4"	0,4		005073 00 00	







Infobox: Overview of furniture recommendation see page 656 / For vanity units the space saving siphon is recommended



Washbasin ground with overflow, with tap platform, overflow clip chrome included, 800 mm					
●	800 x 500	25,3	10	049180 00 27	
● ● ●	800 x 500	25,3	10	049180 00 25	
⊗	800 x 500	25,3	10	049180 00 28	
Design Siphon * chrome		1,5		005036 10 00	
Design angle valve with rosette, chrome	1/2"	0,5		003045 10 00	

Infobox: * When using this siphon please observe outlet height from upper surface of finished floor to centre of outlet in accordance with the technical specification sheet / Overview of furniture recommendation see page 656

2nd floor Design by sieger design

Description	mm	kg	Qty.	Model-No.	Euro
					White - 00
 Washbasin with overflow, with tap platform, overflow clip chrome included, 700 mm					
●	700 x 460	16,7	18	049170 00 00	
● ● ●	700 x 460	16,7	18	049170 00 30	
⊗	700 x 460	16,7	18	049170 00 60	
600 mm					
●	600 x 430	16,7	21	049160 00 00	
● ● ●	600 x 430	16,7	21	049160 00 30	
⊗	600 x 430	16,7	21	049160 00 60	
 Design Siphon * chrome			1,5	005036 10 00	
 Design angle valve with rosette, chrome	1/2"	0,5		003045 10 00	
Pedestal for # 049170, 049160	170 x 215	16,7	30	086318 00 00	
Siphon cover for # 049170, 049160	180 x 315	8,3	32	085716 00 00	
Fixing for siphon cover		0,1		005503 00 00	
Flexible hose with angle connection (1 pair) for # 049112, 049180, 049170 and 049160 for 3 hole faucet	1/2" x 340	0,1		001402 10 00	
Infobox: * When using this siphon please observe outlet height from upper surface of finished floor to centre of outlet in accordance with the technical specification sheet / Attention: Flexible hose with angle connection in combination with washbasins with 3 hole faucet and siphon cover					
 Washbasin ground with overflow, with tap platform, overflow clip chrome included, 700 mm					
●	700 x 460	16,7	18	049170 00 27	
● ● ●	700 x 460	16,7	18	049170 00 25	
⊗	700 x 460	16,7	18	049170 00 28	
600 mm					
●	600 x 430	16,7	21	049160 00 27	
● ● ●	600 x 430	16,7	21	049160 00 25	
⊗	600 x 430	16,7	21	049160 00 28	
 Design Siphon * chrome			1,5	005036 10 00	
 Design angle valve with rosette, chrome	1/2"	0,5		003045 10 00	
Infobox: * When using this siphon please observe outlet height from upper surface of finished floor to centre of outlet in accordance with the technical specification sheet / Overview of furniture recommendation see page 656					

2nd floor Design by sieger design

Description	mm	kg	Qty.	Model-No.	Euro
 Furniture washbasin with overflow, with tap platform, overflow clip chrome included, 600 mm					White - 00
	●	600 x 430	16,7	21	049160 00 00
	● ● ●	600 x 430	16,7	21	049160 00 30
	⊗	600 x 430	16,7	21	049160 00 60

Space saving siphon

White	1 1/4"	0,4		005073 00 00
-------	--------	-----	--	---------------------

Infobox: Overview of furniture recommendation see page 656 / For vanity units the space saving siphon is recommended

Handrinse basin

without overflow,
 with tap platform,
 without tap hole

500 mm ●	500 x 400	12,6	21	079050 00 00
500 mm ⊗	500 x 400	12,6	21	079050 00 70

Design Siphon *

chrome		1,5		005036 10 00
--------	--	-----	--	---------------------

Design angle valve

with rosette, chrome	1/2"	0,5		003045 10 00
----------------------	------	-----	--	---------------------

Slotted waste

chrome	50	0,3		005024 10 00
--------	----	-----	--	---------------------

Siphon cover

for # 079050	180 x 285	6,3	32	085713 00 00
--------------	-----------	-----	----	---------------------

Fixing

for siphon cover		0,09		005505 00 00
------------------	--	------	--	---------------------

Infobox: * When using this siphon please observe outlet height from upper surface of finished floor to centre of outlet in accordance with the technical specification sheet

Handrinse basin

without overflow,
 with tap platform,
 without tap hole

400 mm ●	400 x 300	7,0	33	079040 00 00
400 mm ⊗	400 x 300	7,0	33	079040 00 70

Slotted waste

chrome	50	0,3		005024 10 00
--------	----	-----	--	---------------------

Design Siphon *



chrome		1,5		005036 10 00
--------	--	-----	--	---------------------

Design angle valve



with rosette, chrome	1/2"	0,5		003045 10 00
----------------------	------	-----	--	---------------------

Infobox: * When using this siphon please observe outlet height from upper surface of finished floor to centre of outlet in accordance with the technical specification sheet







2nd floor Design by sieger design

	Description	mm	kg	Qty.	Model-No.	Euro
						White - 00
	Furniture handrinse basin					
	without overflow, with tap platform					
	400 mm ●	400 x 300	7,0	33	079040 00 00	
	400 mm ☒	400 x 300	7,0	33	079040 00 70	
	Slotted waste					
chrome	50	0,3		005024 10 00		
	Space saving siphon					
	White	1 1/4"	0,4		005073 00 00	
Infobox: Overview of furniture recommendation see page 656 / For vanity units the space saving siphon is recommended						
	Washbowl					
	ground, without overflow, without tap platform					
	580 mm ☒	580 x 415	13,1	24	031758 00 00	
	Design Siphon *					
	chrome		1,5		005036 10 00	
	Slotted waste					
chrome	50	0,3		005024 10 00		
	Design angle valve					
	with rosette, chrome	1/2"	0,5		003045 10 00	
Infobox: * When using this siphon please observe outlet height from upper surface of finished floor to centre of outlet in accordance with the technical specification sheet / Overview of furniture recommendation see page 656						
	Vanity basin					
	countertop basin, with overflow, with tap platform, back plane glazed, overflow clip chrome included					
	600 mm ●	600 x 430	10,5	24	034760 00 00	
	600 mm ● ● ●	600 x 430	10,5	24	034760 00 30	
	Design Siphon *					
chrome		1,5		005036 10 00		
	Design angle valve					
	with rosette, chrome	1/2"	0,5		003045 10 00	
Infobox: * When using this siphon please observe outlet height from upper surface of finished floor to centre of outlet in accordance with the technical specification sheet / Overview of furniture recommendation see page 656						





2nd floor Design by sieger design

Description	mm	kg	Qty.	Model-No.	Euro
					White - 00
 Vanity basin countertop basin, without overflow, without tap platform 580 mm ☒	580 x 415	13,1	24	031758 00 29	
Design Siphon * chrome		1,5		005036 10 00	
Design angle valve with rosette, chrome	1/2"	0,5		003045 10 00	
Slotted waste chrome	50	0,3		005024 10 00	
Infobox: * When using this siphon please observe outlet height from upper surface of finished floor to centre of outlet in accordance with the technical specification sheet / Overview of furniture recommendation see page 656					
 Vanity basin undercounter basin, with overflow, without tap platform, fixings included 525 mm ☒	525 x 350	8,3	24	031653 00 00	
Design Siphon * chrome		1,5		005036 10 00	
Design angle valve with rosette, chrome	1/2"	0,5		003045 10 00	
Fixing Set for stone countertops (with the exception of # 046651)		0,2		005028 00 00	
Infobox: Measurements of undercounter models represent interior measurements / * When using this siphon please observe outlet height from upper surface of finished floor to centre of outlet in accordance with the technical specification sheet					
 Bidet wall mounted ● with overflow, with tap platform, Durafix included overflow clip chrome included	370 x 540	20,8	20	225415 00 00	
Fixing for wall mounted bidet and wall mounted toilet caps white	Ø 12 x 180	0,2		006500 00 00	
Siphon for bidet with extended outlet pipe chrome	1 1/4"	0,6		005027 00 00	
Infobox: Durafix for invisible fixation is included in delivery / If pre-wall carrier not used, the fixing # 006500 is recommended					





2nd floor Design by sieger design

	Description	mm	kg	Qty.	Model-No.	Euro
						White - 00
	Bidet floor standing with overflow, with tap platform, fixings included, overflow clip chrome included					
	●	370 x 665	26,0	9	013710 00 00	
	● ● ●	370 x 665	26,0	9	013710 00 30	
	Siphon for bidet with extended outlet pipe chrome	1 1/4"	0,6		005027 00 00	
	Bidet floor standing with overflow, with tap platform, fixings included, overflow clip chrome included					
	●	370 x 570	25,0	12	013610 00 00	
	● ● ●	370 x 570	25,0	12	013610 00 30	
	Siphon for bidet with extended outlet pipe chrome	1 1/4"	0,6		005027 00 00	
	Toilet wall mounted washdown model, Durafix included 4,5 l	370 x 540	26,8	16	222009 00 00	
	Fixing for wall mounted bidet and wall mounted toilet caps white	Ø 12 x 180	0,2		006500 00 00	
	Noise reduction gasket for wall mounted toilet		0,3		005020 00 00	
	Toilet seat and cover removable, hinges stainless steel with SoftClose automatic closure		2,7		006899 00 00	
Infobox: Durafix for invisible fixation is included in delivery / If pre-wall carrier not used, the fixing # 006500 is recommended						
	Toilet floor standing for independent water supply, washdown model, fixings included, horizontal outlet 6,0 l	370 x 570	28,0	12	011009 00 00	
	Vario connector set for horizontal and vertical outlet, length adjustable incl. excenter	Ø 110	1,5		001422 00 00	
	Toilet seat and cover removable, hinges stainless steel with SoftClose automatic closure		2,7		006899 00 00	
Infobox: When using the vario-connector-set, supply vertical from 85 - 115 mm, length adjustable						





2nd floor Design by sieger design





	Description	mm	kg	Qty.	Model-No.	Euro
						White - 00
	Toilet close-coupled washdown model, (without cistern), fixings included, horizontal outlet					
	♻️ 6,0 l	370 x 665	31,0	9	210709 00 00	
	Connecting bend with rosette vertical outlet	Ø 110	0,1		001428 00 00	
	Connecting pipe with rosette horizontal outlet	Ø 110	0,1		001429 00 00	
	Cistern with Dual Flush mechanism, chrome, ♻️ 6,0 l					
	for side supply	380 x 180	14,8	27	087600 00 05	
	for bottom left supply	380 x 180	15,0	27	087610 00 05	
	Conversion set for back supply chrome		0,5		007504 10 00	
	Toilet seat and cover removable, hinges stainless steel					
	with SoftClose automatic closure		2,7		006899 00 00	
	Toilet close-coupled washdown model, (without cistern), Outlet for Vario connector set, for horizontal and vertical outlet, length adjustable from 70 - 210 mm, and vario connecting bend, vertical outlet from 200 - 240 mm, fixings included					
	♻️ 6,0 l	370 x 665	32,5	9	210609 00 00	
	Vario connector set for horizontal and vertical outlet, length adjustable incl. excenter	Ø 110	1,5		001422 00 00	
	Vario connecting bend for vertical outlet	Ø 100	0,7		899025 00 06	
	Cistern with Dual Flush mechanism, chrome, ♻️ 6,0 l					
	for side supply	380 x 180	14,8	27	087600 00 05	
	for bottom left supply	380 x 180	15,0	27	087610 00 05	
	Conversion set for back supply chrome		0,5		007504 10 00	
	Toilet seat and cover removable, hinges stainless steel					
	with SoftClose automatic closure		2,7		006899 00 00	

Architec Design by Prof. Frank Huster



Description	mm	kg	Qty.	Model-No.	Euro
					White - 00
	Washbasin without overflow, with tap platform, 575 mm with pre-punched hole for soap dispenser on right side, with pre-punched tap hole for tap on left side ● ●	575 x 520	15,2	24	044958 00 00
	tap hole on right side ●	575 x 520	15,2	24	044958 00 08
	tap hole on left side ●	575 x 520	15,2	24	044958 00 09
	tap hole on left side, soap dispenser right ● ●	575 x 520	15,2	24	044958 00 23
	Slotted waste chrome	50	0,3		005024 10 00
	Washbasin with overflow, with tap platform, with pre-punched tap hole for tap on left side, with pre-punched hole for soap dispenser on right side 575 mm ● ●	575 x 520	15,2	24	045058 00 00
	Slotted waste chrome	80	0,4		005038 10 00
	Washbasin Med without overflow, with tap platform, for mounting with in-wall-siphon kit, with pre-punched hole for soap dispenser on right side, with pre-punched tap hole for tap on left side 575 mm ● ●	575 x 520	14,0	30	044358 00 00
	In-wall-siphon kit ** for washbasin Architec including connection equipment		0,6		005044 10 00
	Drain cover chrome		0,08		005043 10 00
Infobox: ** Mandatory for installation / Barrier-free according to DIN 18040-1 and DIN 18040-2					
	Washbasin corner model without overflow, with tap platform, with tap hole, with pre-punched hole for soap dispenser on right side 635 mm ● ●	635 x 540	12,0	24	044845 00 00
	Slotted waste chrome	50	0,3		005024 10 00
Infobox: Pop-up waste cannot be used / Measurements represent width x projection					

Architec Design by Prof. Frank Huster



Description	mm	kg	Qty.	Model-No.	Euro
					White -- 00
	Handrinse basin diagonal model, without overflow, with tap platform, with integrated ceramic shelf				
	bowl on left side ●	645 x 410	10,1	18	076465 00 00
	bowl on right side ●	645 x 410	10,1	18	076565 00 00
	Outlet bend with double sleeve				
	chrome	Ø 32	0,2		005025 10 00
	Slotted waste				
	chrome	50	0,3		005024 10 00
	Handrinse basin without overflow, with tap platform, 360 mm with pre-punched hole for soap dispenser on right side, with pre-punched tap hole for tap on left side ● ●				
	tap hole on left side ●	360 x 380	7,6	54	076635 00 00
	tap hole on right side ●	360 x 380	7,6	54	076635 00 09
	tap hole on right side ●	360 x 380	7,6	54	076635 00 08
	Slotted waste				
	chrome	50	0,3		005024 10 00
	Above counter basin ground, without overflow, with tap platform, fixings included, 500 mm				
	without tap hole ☒	500 x 500	12,4	12	032050 00 00
	tap hole on right side ●	500 x 500	12,4	12	032050 00 08
	tap hole on left side ●	500 x 500	12,4	12	032050 00 09
	Slotted waste				
	chrome	80	0,4		005038 10 00
Info box: Soap dispenser hole Ø 30 mm right or left available on request / Max. Ø 70 mm for lotion tank approved / Overview of furniture recommendation see page 656					
	Above counter basin ground, without overflow, with tap platform, fixings included, 450 mm				
	without tap hole ☒	450 x 450	11,4	21	032045 00 00
	tap hole on right side ●	450 x 450	11,4	21	032045 00 08
	tap hole on left side ●	450 x 450	11,4	21	032045 00 09
	Slotted waste				
	chrome	80	0,4		005038 10 00
Info box: Soap dispenser hole Ø 30 mm right or left available on request / Max. Ø 70 mm for lotion tank approved / Overview of furniture recommendation see page 656					

Description		mm	kg	Qty.	Model-No.	Euro
						White - 00
	Above counter basin ground, with overflow, with tap platform, fixings included, 420 mm					
	without tap hole ☒	420 x 420	12,0	21	032042 00 00	
	tap hole on right side ●	420 x 420	12,0	21	032042 00 08	
	tap hole on left side ●	420 x 420	12,0	21	032042 00 09	
	400 mm					
	without tap hole ☒	400 x 400	11,8	21	032040 00 00	
	tap hole on right side ●	400 x 400	11,8	21	032040 00 08	
	tap hole on left side ●	400 x 400	11,8	21	032040 00 09	
	Push-open waste ***					
	chrome		0,35		005052 10 00	
<div style="border: 1px solid black; padding: 5px;"> Infobox: *** Required in conjunction with wall mounted tap fitting, vanity unit and/or consoles / Soap dispenser hole Ø 30 mm right or left available on request / Max. Ø 70 mm for lotiontank approved / Overview of furniture recommendation see page 656 </div>						
	Vanity basin countertop basin, without overflow, without tap platform, outside fully glazed					
	500 mm ☒	Ø 500	6,5	21	031850 00 00	
	450 mm ☒	Ø 450	5,4	21	031845 00 00	
	Slotted waste					
	chrome	80	0,4		005038 10 00	
	Vanity basin countertop basin, with overflow, without tap platform, outside fully glazed					
	470 mm ☒	Ø 470	7,3	21	046847 00 00	
	Push-open waste ***					
	chrome		0,35		005052 10 00	
<div style="border: 1px solid black; padding: 5px;"> Infobox: *** Required in conjunction with wall mounted tap fitting, vanity unit and/or consoles </div>						
	Vanity basin countertop basin, with overflow, without tap platform, outside fully glazed					
	400 mm ☒	Ø 400	5,2	21	031840 00 00	
	Push-open waste ***					
	chrome		0,35		005052 10 00	
<div style="border: 1px solid black; padding: 5px;"> Infobox: *** Required in conjunction with wall mounted tap fitting, vanity unit and/or consoles </div>						



Architec Design by Prof. Frank Huster





	Description	mm	kg	Qty.	Model-No.	Euro
						White - 00
	Vanity basin Bali countertop basin, with overflow, without tap platform, outside fully glazed					
	335 mm ☒	Ø 335	3,6	42	047334 00 31	
	Push-open waste *** chrome		0,35		005052 10 00	
Infobox: *** Required in conjunction with wall mounted tap fitting, vanity unit and/or consoles						
	Vanity basin undercounter basin, without overflow, without tap platform, outside fully glazed, fixings for installation in wooden consoles included					
	420 mm ☒	Ø 420	5,6	21	031942 00 00	
	Slotted waste chrome	80	0,4		005038 10 00	
	Fixing Set for stone countertops (with the exception of # 046651)		0,2		005028 00 00	
Infobox: Measurements of undercounter models represent interior measurements						
	Vanity basin undercounter basin, without overflow, with tap platform, with tap hole, with pre-punched hole for soap dispenser on right side, fixings for installation in wooden consoles included					
	400 mm ● ●	Ø 400	6,7	21	046240 00 00	
	Slotted waste chrome	50	0,3		005024 10 00	
	Fixing Set for stone countertops (with the exception of # 046651)		0,2		005028 00 00	
Infobox: Measurements of undercounter models represent interior measurements						







Architec Design by Prof. Frank Huster



Description		mm	kg	Qty.	Model-No.	Euro
						White - 00
	Vanity basin undercounter basin, without overflow, without tap platform, fixings for installation in wooden consoles included					
400 mm ☒		Ø 400	6,5	21	046340 00 00	
Slotted waste						
chrome		50	0,3		005024 10 00	
Fixing Set						
for stone countertops (with the exception of # 046651)			0,2		005028 00 00	
Infobox: Measurements of undercounter models represent interior measurements						
	Vanity basin undercounter basin, with overflow, without tap platform, outside fully glazed, fixings for installation in wooden consoles included					
400 mm ☒		Ø 400	6,5	21	046840 00 00	
Fixing Set						
for stone countertops (with the exception of # 046651)			0,2		005028 00 00	
Push-open waste ***						
chrome			0,35		005052 10 00	
Infobox: Measurements of undercounter models represent interior measurements / *** Required in conjunction with wall mounted tap fitting, vanity unit and/or consoles						
	Vanity basin special ground for Duravit furniture, undercounter basin, with overflow, without tap platform, outside fully glazed					
400 mm ☒		Ø 400	6,5	21	046840 00 22	
Push-open waste ***						
chrome			0,35		005052 10 00	
Infobox: Measurements of undercounter models represent interior measurements / *** Required in conjunction with wall mounted tap fitting, vanity unit and/or consoles / Undercounter basin only in combination with variable consoles, as well as vanity units for undercounter basins, see the furniture part. Delivery only in combination of console or vanity unit with attached washbasin / Not available in WonderGliss						

Architec Design by Prof. Frank Huster



Description	mm	kg	Qty.	Model-No.	Euro
					White - 00
	Vanity basin undercounter basin, without overflow, without tap platform, outside fully glazed, fixings for installation in wooden consoles included				
375 mm ☒	Ø 375	5,45	21	031937 00 00	
	Slotted waste chrome	80	0,4	005038 10 00	
	Fixing Set for stone countertops (with the exception of # 046651)		0,2	005028 00 00	
Infobox: Measurements of undercounter models represent interior measurements					
	Vanity basin undercounter basin, with overflow, without tap platform, outside fully glazed, fixings for installation in wooden consoles included				
325 mm ☒	Ø 325	4,9	42	031932 00 00	
275 mm ☒	Ø 275	4,7	42	031927 00 00	
	Push-open waste *** chrome		0,35	005052 10 00	
	Fixing Set for stone countertops (with the exception of # 046651)		0,2	005028 00 00	
Infobox: Measurements of undercounter models represent interior measurements / *** Required in conjunction with wall mounted tap fitting, vanity unit and/or consoles					
	Bidet wall mounted ● with overflow, with tap platform Durafix included	365 x 580	20,5	20	253115 00 00
	Fixing for wall mounted bidet and wall mounted toilet caps white	Ø 12 x 180	0,2	006500 00 00	
Infobox: Durafix for concealed fixation is included in delivery / If pre-wall carrier not used, the fixing # 006500 is recommended					

Description	mm	kg	Qty.	Model-No.	Euro
					White - 00
 Toilet wall mounted projection 700 mm, suitable for barrier-free applications, ♻️ 6,0 l					
washdown model	350 x 700	24,8	14	019009 00 00	
washout model	350 x 700	27,2	14	024309 00 00	
Fixing for wall mounted bidet and wall mounted toilet					
caps white	Ø 12 x 180	0,2		006500 00 00	
caps chrome	Ø 12 x 180	0,2		006500 10 00	
Noise reduction gasket for wall mounted toilet					
		0,3		005020 00 00	
 Toilet seat and cover with lateral reinforcement and extended hinge shaft, hinges stainless steel					
without automatic closure			1,9	006291 00 00	
 Toilet seat and cover with lateral reinforcement and extended hinge shaft, hinges stainless steel					
without automatic closure			3,2	006281 00 00	
Infobox: Barrier-free according to DIN 18040-1 and DIN 18040-2 / If pre-wall carrier not used, the fixing # 006500 is recommended					
 Toilet wall mounted washdown model, Durafix included ♻️ 4,5 l					
	365 x 575	23,0	20	254609 00 64	
Noise reduction gasket for wall mounted toilet					
		0,3		005020 00 00	
Fixing for wall mounted bidet and wall mounted toilet					
caps white	Ø 12 x 180	0,2		006500 00 00	
 Toilet seat and cover removable, wrap over, hinges stainless steel					
without automatic closure			2,1	006961 00 00	
with SoftClose automatic closure			2,1	006969 00 00	
Infobox: Durafix for concealed fixation is included in delivery / If pre-wall carrier not used, the fixing # 006500 is recommended					



	Description	mm	kg	Qty.	Model-No.	Euro
						White - 00
	Urinal					
	concealed inlet, for 1/2" connection, rimless, horizontal outlet, includes jet nozzle, inlet-set, ceramic covered siphon Ø 103 mm and fixings					
	model without fly	380 x 350	20,8	9	081837 00 00	
	model with fly 	380 x 350	20,8	9	081837 00 07	
	Siphon insert					
Spare part for siphon without sensor control		0,9		100254 00 00		
<div style="border: 1px solid black; padding: 5px;"> Infobox: In combination with adjustable in-wall flushometers / When using GEBERIT pre-wall carriers model range Duofix # 111.685 / Kombifix # 457.685 / GIS # 461.685 (available up to and including 2008), mandatory in combination with inlet traverse # 242.040.00.1 for 1/2" inlet connection / When using GEBERIT pre-wall carriers model range Duofix # 111.616 / Kombifix # 457.611 / GIS # 461.621 (available from Jan. 2009), mandatory in combination with inlet adapter # 242.042.00.1 for 1/2" inlet connection </div>						
	Urinal					
	visible inlet, rimless, horizontal outlet, includes jet nozzle, inlet-set, ceramic covered siphon Ø 103 mm and fixings					
	model without fly	380 x 350	20,8	9	081737 00 00	
	model with fly 	380 x 350	20,8	9	081737 00 07	
	Siphon insert					
Spare part for siphon without sensor control		0,9		100254 00 00		
<div style="border: 1px solid black; padding: 5px;"> Infobox: In combination with adjustable flushometers without ventilation </div>						
	Urinal					
	concealed inlet, syphonic action, horizontal outlet, includes ceramic covered siphon Ø 103 mm and fixings					
	model without fly	380 x 385	23,0	9	082037 00 00	
	model with fly 	380 x 385	23,0	9	082037 00 07	
	Siphon insert					
Spare part for siphon without sensor control		0,9		100254 00 00		
Water inlet mechanism						
for urinals with back supply	1/2"	0,1		695800 00 00		

Description		mm	kg	Qty.	Model-No.	Euro
	Urinal					White - 00
	visible inlet, syphonic action, horizontal outlet, includes ceramic covered siphon Ø 103 mm and fixings					
	model without fly	380 x 385	23,0	9	081937 00 00	
	model with fly	380 x 385	23,0	9	081937 00 07	
	Siphon insert					
Spare part for siphon without sensor control		0,9		100254 00 00		
	Urinal					
	Electronic urinal for battery supply, concealed inlet, for 1/2" connection, rimless, horizontal outlet, includes jet nozzle, inlet-set, ceramic covered siphon Ø 103 mm, fixings and complete control unit					
	model without fly	380 x 350	21,1	9	081836 00 00	
	model with fly	380 x 350	21,1	9	081836 00 07	
	Siphon insert					
Spare part for siphon with sensor control		0,9		100255 00 00		
Conversion set						
for conversion of back supply to bottom left connection		0,4		007559 00 00		
Infobox: When using GEBERIT pre-wall carriers model range Duofix # 111.685 / Kombifix # 457.685 / GIS # 461.685 (available up to and including 2008), mandatory in combination with inlet traverse # 242.040.00.1 for 1/2" inlet connection / When using GEBERIT pre-wall carriers model range Duofix # 111.616 / Kombifix # 457.611 / GIS # 461.621 (available from Jan. 2009), mandatory in combination with inlet adapter # 242.042.00.1 for 1/2" inlet connection / Installation measures for conversion set # 0075590000 see www.duravit.com						
	Urinal					
	Electronic urinal for power supply, concealed inlet, for 1/2" connection, rimless, horizontal outlet, includes jet nozzle, inlet-set, ceramic covered siphon Ø 103 mm, fixings and complete control unit					
	model without fly	380 x 350	21,1	9	081836 00 93	
	model with fly	380 x 350	21,1	9	081836 00 97	
	Pre-assembly set					
power supply unit 110 - 230V including electrical outlet				005008 00 00		
Siphon insert						
Spare part for siphon with sensor control		0,9		100255 00 00		
Conversion set						
for conversion of back supply to bottom left connection		0,4		007559 00 00		
Infobox: The power supply isn't included in delivery / When using GEBERIT pre-wall carriers model range Duofix # 111.685 / Kombifix # 457.685 / GIS # 461.685 (available up to and including 2008), mandatory in combination with inlet traverse # 242.040.00.1 for 1/2" inlet connection / When using GEBERIT pre-wall carriers model range Duofix # 111.616 / Kombifix # 457.611 / GIS # 461.621 (available from Jan. 2009), mandatory in combination with inlet adapter # 242.042.00.1 for 1/2" inlet connection / Installation measures for conversion set # 0075590000 see www.duravit.com						



Architec Design by Prof. Frank Huster

Description	mm	kg	Qty.	Model-No.	Euro
					White - 00
					
Urinal Electronic urinal for battery supply, concealed inlet, horizontal outlet, including inlet-set, ceramic covered siphon Ø 103 mm, fixings and complete control unit					
model without fly	380 x 385	23,3	9	082036 00 00	
model with fly	380 x 385	23,3	9	082036 00 07	
Siphon insert Spare part for siphon with sensor control		0,9		100255 00 00	
Conversion set for conversion of back supply to bottom left connection		0,4		007559 00 00	
Infobox: Installation measures for conversion set # 0075590000 see www.duravit.com					
					
Urinal Electronic urinal for power supply, concealed inlet, horizontal outlet, including inlet-set, ceramic covered siphon Ø 103 mm, fixings and complete control unit					
model without fly	380 x 385	23,3	9	082036 00 93	
model with fly	380 x 385	23,3	9	082036 00 97	
Pre-assembly set power supply unit 110 - 230V including electrical outlet				005008 00 00	
Siphon insert Spare part for siphon with sensor control		0,9		100255 00 00	
Conversion set for conversion of back supply to bottom left connection		0,4		007559 00 00	
Infobox: The power supply isn't included in delivery / Installation measures for conversion set # 0075590000 see www.duravit.com					
					
Urinal Architec Dry waterless, horizontal outlet, Air trap and fixing included					
model without fly	380 x 350	22,5	9	081835 00 00	
Air trap Spare part		0,02		100342 00 00	
Inspection key Spare part		0,02		100344 00 00	
Blue cleaner Cleaner with spray top 6 bottles 500 ml each		3,6		005062 00 00	
Infobox: Not available in WonderGliss					



Architec Design by Prof. Frank Huster

Description	mm	kg	Qty.	Model-No.	Euro
					White - 00
 Urinal Architec Dry waterless, horizontal outlet, Air trap, cover and fixing included model without fly	380 x 350	22,5	9	081835 00 99	
	Air trap with cover for Urinal				
	Spare part				100343 00 00
	Inspection key				
Spare part				0,02	100344 00 00
Blue cleaner					
Cleaner with spray top					
6 bottles 500 ml each				3,6	005062 00 00
Infobox: Not available in WonderGliss					
 Ceramic urinal partition fixings included	705 x 400	16,8	33	850000 00 00	









Bacino Design by Duravit

	Description	mm	kg	Qty.	Model-No.	Euro
						White - 00
	Washbowl with overflow, without tap platform, overflow clip chrome included, fixings included					
	550 mm ☒	550 x 420	12,0	21	033452 00 00	
	Pop-up basin waste chrome					
	with horizontal lever**		0,5		005031 10 00	
	with vertical lever***		0,5		005051 10 00	
Infobox: *** In combination with wall mounted tap and Duravit bathroom furniture / Overview of furniture recommendation see page 656 / ** Required in conjunction with wall mounted tap fitting and consoles with a maximum thickness of 30 mm						
	Washbowl with overflow, without tap platform, overflow clip chrome included, fixings included					
	420 mm ☒	420 x 420	8,0	21	033342 00 00	
	Pop-up basin waste chrome					
	with horizontal lever**		0,5		005031 10 00	
	with vertical lever***		0,5		005051 10 00	
Infobox: *** In combination with wall mounted tap and Duravit bathroom furniture / Overview of furniture recommendation see page 656 / ** Required in conjunction with wall mounted tap fitting and consoles with a maximum thickness of 30 mm						
	Washbowl with overflow, without tap platform, overflow clip chrome included, fixings included					
	420 mm ☒	Ø 420	7,0	21	032542 00 00	
	Pop-up basin waste chrome					
	with horizontal lever**		0,5		005031 10 00	
	with vertical lever***		0,5		005051 10 00	
Infobox: *** In combination with wall mounted tap and Duravit bathroom furniture / Overview of furniture recommendation see page 656 / ** Required in conjunction with wall mounted tap fitting and consoles with a maximum thickness of 30 mm						





Bagnella Design by sieger design

Description		mm	kg	Qty.	Model-No.	Euro
						White - 00
	Washbowl without overflow, without tap platform, chrome ring included, fixings included					
480 mm ☒		Ø 480	9,5	21	045148 00 00	
Slotted waste						
chrome		50	0,3		005024 10 00	
Infobox: Overview of furniture recommendation see page 656						
	Washbowl without overflow, without tap platform, chrome ring included, fixings included					
400 mm ☒		Ø 400	8,0	21	045140 00 00	
Slotted waste						
chrome		50	0,3		005024 10 00	
Infobox: Overview of furniture recommendation see page 656						







Caro Design by Phoenix Design

Description		mm	kg	Qty.	Model-No.	Euro
						White - 00
  	Washbasin with overflow, with tap platform					
	900 mm ○ ● ○	900 x 595	30,3	8	043490 00 00	
	700 mm ○ ● ○	700 x 505	20,0	14	043470 00 00	
	600 mm ○ ● ○	600 x 470	14,5	24	043460 00 00	
	Pedestal					
	for # 043490	160 x 295	16,5	24	086320 00 00	
	for # 043470 and 043460	165 x 220	13,5	24	086321 00 00	
	Siphon cover					
	for # 043490	180 x 330	10,1	48	086325 00 00	
	for # 043470 and 043460	165 x 285	5,5	48	086326 00 00	
Fixing for siphon cover			0,1	005503 00 00		
 	Handrinse basin with overflow, with tap platform					
	500 mm ●	500 x 365	9,3	24	079150 00 00	
	Siphon cover for # 079150	165 x 215	4,5	42	086322 00 00	
	Fixing for siphon cover			0,1	005503 00 00	
		Vanity basin countertop basin, with overflow, with tap platform				
560 mm ○ ● ○		560 x 445	11,0	15	046157 00 00	
	Bidet wall mounted ● with overflow with tap platform					
		360 x 620	18,5	14	029015 00 00	
	Fixing for wall mounted bidet and wall mounted toilet					
	caps white	Ø 12 x 180	0,2		006500 00 00	
	caps chrome	Ø 12 x 180	0,2		006500 10 00	
Infobox: If pre-wall carrier not used, the fixing # 006500 is recommended						
	Bidet floor standing ● with overflow, with tap platform					
	fixings included	360 x 640	27,2	9	029010 00 00	







Caro Design by Phoenix Design

	Description	mm	kg	Qty.	Model-No.	Euro
						White - 00
	Toilet wall mounted washdown model					
	♻️ 6,0 l	360 x 620	25,7	14	019809 00 00	
	Fixing for wall mounted bidet and wall mounted toilet					
	caps white	Ø 12 x 180	0,2		006500 00 00	
	caps chrome	Ø 12 x 180	0,2		006500 10 00	
	Noise reduction gasket for wall mounted toilet					
			0,3		005020 00 00	
	Toilet seat and cover without automatic closure					
	hinges white			3,2	006560 00 00	
	hinges stainless steel			3,2	006561 00 00	
	with SoftClose automatic closure					
	hinges stainless steel			2,7	006569 00 00	
Infobox: If pre-wall carrier not used, the fixing # 006500 is recommended						
	Toilet close-coupled washdown model, (without cistern), Outlet for Vario connector set, for horizontal and vertical outlet, length adjustable from 70 - 225 mm, and vario connecting bend, vertical outlet from 215 - 255 mm, fixings included					
	♻️ 6,0 l	360 x 695	36,0	9	022509 00 00	
	Vario connector set for horizontal and vertical outlet, length adjustable incl. excenter	Ø 110	1,5		001422 00 00	
	Vario connecting bend for vertical outlet	Ø 100	0,7		899025 00 06	
	Cistern with Dual Flush mechanism, chrome, concealed left supply					
	♻️ 6,0 l	395 x 140	12,5	24	087250 00 85	
	Push button White				007414 00 00	
	Toilet seat and cover without automatic closure					
	hinges white			3,2	006560 00 00	
	hinges stainless steel			3,2	006561 00 00	
	with SoftClose automatic closure					
	hinges stainless steel			2,7	006569 00 00	





Caro Design by Phoenix Design

Description		mm	kg	Qty.	Model-No.	Euro
						White - 00
	Two-piece toilet (without cistern), US-version, elongated with syphonic jet action, 305 mm/12" rough-in, IAPMO listed, vertical outlet ♠ 1,28 gpf (4,8 l)	360 x 750	35,4	12	010101 00 62	
	Mounting set for One-piece and Two-piece toilets 1/2", US-version			0,48	001431 00 00	
	 Cistern with Single Flush piston valve, top flush, chrome, bottom left supply ♠ 1,28 gpf (4,8 l)	385 x 175	12,5	40	092410 00 05	
 Toilet seat and cover elongated, hinges stainless steel with automatic closure				3,2	006869 00 00	
   	Urinal concealed inlet and outlet, syphonic action, fixings included model for cover	300 x 250	12,0	20	083630 00 00	
	Siphon horizontal outlet (concealed)	∅ 50		0,2	005112 00 00	
	Water inlet mechanism for urinals with back supply	1/2"		0,1	695800 00 00	
	Urinal Cover hinges white hinges stainless steel			1,3 1,3	006550 00 00 006551 00 00	







Darling New Design by sieger design

	Description	mm	kg	Qty.	Model-No.	Euro		
						White	- 00	
  	Washbasin with overflow, with tap platform							
	650 mm ●	650 x 550	19,0	12	262165 00 00			
	650 mm ● ● ●	650 x 550	19,0	12	262165 00 30			
	600 mm ●	600 x 520	18,0	18	262160 00 00			
	600 mm ● ● ●	600 x 520	18,0	18	262160 00 30			
	550 mm ●	550 x 480	15,3	24	262155 00 00			
	550 mm ● ● ●	550 x 480	15,3	24	262155 00 30			
	Pedestal for # 262165, 262160, 262155			17,0	30	085824 00 00		
	Siphon cover for # 262165, 262160, 262155			6,4	40	085825 00 00		
	Fixing for siphon cover			0,1		005503 00 00		
 	Handrinse basin with overflow, with tap platform							
	470 mm ●	470 x 345	9,7	32	073147 00 00			
	Siphon cover for # 073147			5,2	45	085826 00 00		
	Fixing for siphon cover			0,1		005503 00 00		
	Above counter basin ground, with overflow, with tap platform, fixings included							
	470 mm ●	Ø 470	9,4	16	049747 00 00			
Infobox: Overview of furniture recommendation see page 656								
	Furniture washbasin with overflow, with tap platform							
	1030 mm ●	1030 x 545	24,0	10	049910 00 00			
	1030 mm ● ● ●	1030 x 545	24,0	10	049910 00 30			
	830 mm ●	830 x 545	20,4	10	049983 00 00			
	830 mm ● ● ●	830 x 545	20,4	10	049983 00 30			
	630 mm ●	630 x 520	15,7	18	049963 00 00			
	630 mm ● ● ●	630 x 520	15,7	18	049963 00 30			
	530 mm ●	530 x 430	11,0	24	049953 00 00			
	Space saving siphon White	1 1/4"		0,4		005073 00 00		
	Infobox: For vanity units the space saving siphon is recommended / Overview of furniture recommendation see page 656							







Darling New Design by sieger design

Description	mm	kg	Qty.	Model-No.	Euro
 <p>Bidet wall mounted ● with overflow, with tap platform Durafix included</p>	370 x 540	20,5	16	224915 00 00	White - 00
	Fixing				
	for wall mounted bidet and wall mounted toilet				
	caps white	Ø 12 x 180	0,2		006500 00 00
Infobox: Durafix for invisible fixation is included in delivery / If pre-wall carrier not used, the fixing # 006500 is recommended					
 <p>Bidet wall mounted Compact ● with overflow, with tap platform Durafix included</p>	360 x 485	18,3	20	225615 00 00	
	Fixing				
	for wall mounted bidet and wall mounted toilet				
	caps white	Ø 12 x 180	0,2		006500 00 00
Infobox: Durafix for invisible fixation is included in delivery / If pre-wall carrier not used, the fixing # 006500 is recommended					
 <p>Bidet floor standing ● with overflow, with tap platform fixings included</p>	370 x 630	26,5	9	225110 00 00	
	Siphon for bidet				
	with extended outlet pipe				
	chrome	1 1/4"	0,6		005027 00 00
 <p>Bidet floor standing ● back to wall, with overflow, with tap platform fixings included</p>	370 x 570	25,4	12	225010 00 00	
	Siphon for bidet				
	with extended outlet pipe				
	chrome	1 1/4"	0,6		005027 00 00



Darling New Design by sieger design

	Description	mm	kg	Qty.	Model-No.	Euro
						White - 00
	Toilet wall mounted washdown model, Durafix included					
	4,5 l	370 x 540	23,3	16	254509 00 00	
	Fixing for wall mounted bidet and wall mounted toilet					
	caps white	Ø 12 x 180	0,2		006500 00 00	
	Noise reduction gasket for wall mounted toilet		0,3		005064 00 00	
	Toilet seat and cover hinges stainless steel without automatic closure			2,4	006981 00 00	
	with SoftClose automatic closure, removable			2,7	006989 00 00	
Infobox: Durafix for invisible fixation is included in delivery / If pre-wall carrier not used, the fixing # 006500 is recommended						
	Toilet wall mounted washdown model, suitable for SensoWash Starck, Durafix included					
	4,5 l	370 x 620	27,4	12	254409 00 00	
	Fixing for wall mounted bidet and wall mounted toilet					
	caps white	Ø 12 x 180	0,2		006500 00 00	
	Noise reduction gasket for wall mounted toilet		0,3		005064 00 00	
	Toilet seat and cover elongated, hinges stainless steel without automatic closure			2,0	006332 00 00	
	with automatic closure, removable			2,0	006339 00 00	
Infobox: Durafix for invisible fixation is included in delivery / If pre-wall carrier not used, the fixing # 006500 is recommended / When using the Geberit Design Panel 115.322.11.1 please order elbow 147.236.00.1 / Further details see www.sensowash.com						
	Toilet wall mounted Compact washdown model, Durafix included					
	4,5 l	360 x 485	19,9	16	254909 00 00	
	Fixing for wall mounted bidet and wall mounted toilet					
	caps white	Ø 12 x 180	0,2		006500 00 00	
	Noise reduction gasket for wall mounted toilet		0,3		005020 00 00	
	Toilet seat and cover hinges stainless steel without automatic closure			2,4	006981 00 00	
	with SoftClose automatic closure, removable			2,7	006989 00 00	
Infobox: Durafix for invisible fixation is included in delivery / If pre-wall carrier not used, the fixing # 006500 is recommended						



Darling New Design by sieger design

Description		mm	kg	Qty.	Model-No.	Euro
						White - 00
	Toilet floor standing back to wall, washdown model, fixings included, horizontal outlet					
	♻️ 4,5 l	370 x 570	27,6	12	213909 00 00	
	Toilet seat and cover hinges stainless steel					
	without automatic closure		2,4		006981 00 00	
	with SoftClose automatic closure, removable		2,7		006989 00 00	
	Toilet close-coupled washdown model, (without cistern), Outlet for Vario connector set, for horizontal and vertical outlet, length adjustable from 70 - 145 mm, and vario connecting bend, vertical outlet from 140 - 180 mm, fixings included					
	♻️ 4,5 l	370 x 630	30,0	9	213809 00 00	
	Vario connector set for horizontal and vertical outlet, length adjustable incl. excenter	Ø 110	1,5		001422 00 00	
	Vario connecting bend for vertical outlet	Ø 100	0,7		899025 00 06	
	Cistern with Dual Flush mechanism, chrome, for side supply					
	♻️ 6,0 l	405 x 160	13,9	27	093100 00 05	
	♻️ 4,5 l	405 x 160	13,9	27	093100 00 85	
	for bottom left supply					
	♻️ 6,0 l	405 x 160	13,9	27	093110 00 05	
	♻️ 4,5 l	405 x 160	13,9	27	093110 00 85	
	Cistern Singapore version, with Dual Flush mechanism, chrome, for bottom left supply					
	♻️ 4,0 l	405 x 160	13,9	40	093111 00 05	
	Conversion set for back supply chrome		0,5		007504 10 00	
	Toilet seat and cover hinges stainless steel					
	without automatic closure		2,4		006981 00 00	
	with SoftClose automatic closure, removable		2,7		006989 00 00	

Darling New Design by sieger design

Description	mm	kg	Qty.	Model-No.	Euro
					White - 00
 Toilet close-coupled Hong Kong - version, washdown model, (without cistern), Outlet for Vario connector set, for horizontal and vertical outlet, length adjustable from 70 - 145 mm, and vario connecting bend, vertical outlet from 140 - 180 mm, fixings included ♠ 4,5 l	370 x 650	28,0	9	214409 00 00	
Vario connector set for horizontal and vertical outlet, length adjustable incl. excenter	∅ 110	1,5		001422 00 00	
Vario connecting bend for vertical outlet	∅ 100	0,7		899025 00 06	
Cistern with Dual Flush mechanism, chrome, for side supply ♠ 6,0 l	405 x 160	13,9	27	093100 00 05	
♠ 4,5 l	405 x 160	13,9	27	093100 00 85	
for bottom left supply ♠ 6,0 l	405 x 160	13,9	27	093110 00 05	
♠ 4,5 l	405 x 160	13,9	27	093110 00 85	
Conversion set for back supply chrome		0,5		007504 10 00	
Cistern Hong Kong - version, without mechanism for back, bottom left or right supply	405 x 170	14,6	40	093130 00 00	
 Toilet seat and cover hinges stainless steel without automatic closure		2,4		006981 00 00	
with SoftClose automatic closure, removable		2,7		006989 00 00	







Darling New Design by sieger design

Description		mm	kg	Qty.	Model-No.	Euro	
						White - 00	
	One-piece toilet US-version, back to wall, suitable for SensoWash Starck, elongated with syphonic jet action, 305 mm/12" rough-in, with Single Flush piston valve, top flush, IAPMO listed, vertical outlet ♠ 1,28 gpf (4,8 l)				212301 00 05		
	Mounting set for One-piece and Two-piece toilets 1/2"		0,48		001416 00 00		
	1/2", US-version		0,48		001417 00 00		
	Toilet seat and cover elongated, hinges stainless steel without automatic closure removable, with automatic closure		2,0		006332 00 00 006339 00 00		
<div style="border: 1px solid black; padding: 5px;"> Infobox: When using the Geberit Design Panel 115.322.11.1 please order elbow 147.236.00.1 / Further details see www.sensowash.com </div>							
	Two-piece toilet (without cistern), US-version, suitable for SensoWash Starck, elongated with syphonic jet action, 305 mm/12" rough-in, IAPMO listed, vertical outlet ♠ 1,28 gpf (4,8 l)	370 x 700	35,5	12	212601 00 00		
	Mounting set for One-piece and Two-piece toilets 1/2"		0,48		001416 00 00		
	1/2", US-version		0,48		001417 00 00		
	Cistern with Single Flush piston valve, top flush, bottom left supply ♠ 1,28 gpf (4,8 l)	405 x 170	13,5	40	093120 00 05		
Cistern Hong Kong - version, without mechanism for back, bottom left or right supply	405 x 170	14,6	40	093130 00 00			
	Toilet seat and cover elongated, hinges stainless steel without automatic closure removable, with automatic closure		2,0		006332 00 00 006339 00 00		
	<div style="border: 1px solid black; padding: 5px;"> Infobox: When using the Geberit Design Panel 115.322.11.1 please order elbow 147.236.00.1 / Further details see www.sensowash.com </div>						









WonderGliss
Simply add a '1' to
the model-no.







D-Code Design by sieger design

Description		mm	kg	Qty.	Model-No.	Euro	
						White - 00	
  	Washbasin with overflow, with tap platform						
	650 mm ○ ● ○	650 x 500	21,6	18	231065 00 002		
	650 mm ● ● ●	650 x 500	21,6	18	231065 00 302		
	600 mm ○ ● ○	600 x 460	17,8	21	231060 00 002		
	600 mm ● ● ●	600 x 460	17,8	21	231060 00 302		
	550 mm ○ ● ○	550 x 430	16,1	24	231055 00 002		
	550 mm ● ● ●	550 x 430	16,1	24	231055 00 302		
	Pedestal for # 231065, 231060, 231055, 034812			10,4	35	086327 00 002	
	Siphon cover for # 231065, 231060, 231055, 034812 fixings included			5,5	40	085718 00 002	
		Washbasin Med without overflow, with tap platform					
650 mm ●		650 x 500	21,6	21	231165 00 002		
650 mm ☒		650 x 500	21,6	21	231165 00 702		
600 mm ●		600 x 460	17,8	24	231160 00 002		
600 mm ☒		600 x 460	17,8	24	231160 00 702		
550 mm ●		550 x 430	16,1	24	231155 00 002		
550 mm ☒		550 x 430	16,1	24	231155 00 702		
	Washbasin with overflow, with tap platform						
	600 mm ●	600 x 550	18,6	12	231260 00 002		
Infobox: Barrier-free according to DIN 18040-1 and DIN 18040-2							
	Washbasin Med without overflow, with tap platform						
	600 mm ●	600 x 550	18,6	12	231360 00 002		
	600 mm ☒	600 x 550	18,6	12	231360 00 702		
Infobox: Barrier-free according to DIN 18040-1 and DIN 18040-2							
	Handrinse basin with overflow, with tap platform, 500 mm						
	without tap hole ☒	500 x 220	7,0	40	070650 00 002		
	tap hole on right side ●	500 x 220	7,0	40	070650 00 082		
	tap hole on left side ●	500 x 220	7,0	40	070650 00 092		
Infobox: Mandatory in combination with a bottle trap							







D-Code Design by sieger design

	Description	mm	kg	Qty.	Model-No.	Euro
						White -- 00
	Handrinse basin with overflow, with tap platform 450 mm ●	450 x 340	10,2	36	070545 00 002	
	Siphon cover fixings included for # 070545		4,6	60	085717 00 002	
	Handrinse basin Med without overflow, with tap platform 450 mm ●	450 x 340	10,2	36	070745 00 002	
	450 mm ☒	450 x 340	10,2	36	070745 00 702	
	Handrinse basin with overflow, with tap platform, 360 mm without tap hole ☒	360 x 270	5,5	42	070536 00 002	
Infobox: Mandatory in combination with a bottle trap						
	Vanity basin countertop basin, with overflow, with tap platform 545 mm ○ ● ○	545 x 435	11,4	32	033754 00 00	
	545 mm ● ● ●	545 x 435	11,4	32	033754 00 30	
	Semi-recessed washbasin with overflow, with tap platform, fixings for installation in wooden consoles included 550 mm ●	550 x 440	14,5	28	033955 00 00	
	550 mm ● ● ●	550 x 440	14,5	28	033955 00 30	
	Vanity basin undercounter basin, with overflow, without tap platform, fixings for installation in wooden consoles included 560 mm ☒	560 x 400	8,9	28	033856 00 00	
	Fixing Set for stone countertops (with the exception of # 046651)		0,2		005028 00 00	
Infobox: Measurements of undercounter models represent interior measurements						







D-Code Design by sieger design

	Description	mm	kg	Qty.	Model-No.	Euro
						White - 00
	Vanity basin undercounter basin, with overflow, without tap platform, fixings for installation in wooden consoles included					
	495 mm ☒	495 x 290	10,0	32	033849 00 00	
	Fixing Set for stone countertops (with the exception of # 046651)		0,2		005028 00 00	
Infobox: Measurements of undercounter models represent interior measurements						
	Double washbasin with overflow, with tap platform					
	1200 mm ●	1200 x 490	36,1	12	034812 00 002	
	1200 mm ● ● ●	1200 x 490	36,1	12	034812 00 302	
	Pedestal for # 231065, 231060, 231055, 034812		10,4	35	086327 00 002	
	Siphon cover for # 231065, 231060, 231055, 034812 fixings included		5,5	40	085718 00 002	
Infobox: For fixing the ceramics from the size 1200 mm 2 sets of washbasin fixations are required						
	Double furniture washbasin with overflow, with tap platform					
	1200 mm ●	1200 x 480	36,1	12	034812 00 002	
	1200 mm ● ● ●	1200 x 480	36,1	12	034812 00 302	
	Space saving siphon White	1 1/4"	0,4		005073 00 00	
	Towel rail square tube 14 mm, chrome for washbasin # 034812				003033 10 00	
Infobox: For fixing the ceramics from the size 1200 mm 2 sets of washbasin fixations are required / For vanity units the space saving siphon is recommended / Overview of furniture recommendation see page 656						





D-Code Design by sieger design

	Description	mm	kg	Qty.	Model-No.	Euro
						White - 00
	Furniture washbasin with overflow, with tap platform					
	1050 mm ●	1050 x 480	30,5	8	034210 00 002	
	1050 mm ●●●	1050 x 480	30,5	8	034210 00 302	
	850 mm ●	850 x 480	25,0	8	034285 00 002	
	850 mm ●●●	850 x 480	25,0	8	034285 00 302	
	650 mm ●	650 x 480	20,1	18	034265 00 002	
	650 mm ●●●	650 x 480	20,1	18	034265 00 302	
	Space saving siphon White	1 1/4"	0,4		005073 00 00	
	Towel rail square tube 14 mm, chrome					
	for washbasin # 034210		0,58		003035 10 00	
	for washbasin # 034285 / 035285		0,46		003036 10 00	
	for washbasin # 034265		0,39		003032 10 00	
Infobox: Overview of furniture recommendation see page 656 / For vanity units the space saving siphon is recommended						
	Furniture basin Med without overflow, with tap platform					
	850 mm ●	850 x 480	25,0	8	035285 00 002	
	850 mm ☒	850 x 480	25,0	8	035285 00 702	
	Towel rail square tube 14 mm, chrome					
	for washbasin # 034285 / 035285		0,46		003036 10 00	
	Bidet wall mounted ● with overflow with tap platform	355 x 545	17,4	20	225715 00 002	
	Fixing for wall mounted bidet and wall mounted toilet					
	caps white	Ø 12 x 180	0,2		006500 00 00	
	caps chrome	Ø 12 x 180	0,2		006500 10 00	
Infobox: If pre-wall carrier not used, the fixing # 006500 is recommended						
	Bidet wall mounted Compact ● with overflow with tap platform	350 x 480	15,8	20	223715 00 002	
	Fixing for wall mounted bidet and wall mounted toilet					
	caps white	Ø 12 x 180	0,2		006500 00 00	
	caps chrome	Ø 12 x 180	0,2		006500 10 00	
Infobox: If pre-wall carrier not used, the fixing # 006500 is recommended						
	Bidet floor standing ● with overflow, with tap platform fixings included	355 x 525	18,0	20	223710 00 002	









D-Code Design by sieger design

	Description	mm	kg	Qty.	Model-No.	Euro
						White - 00
	Bidet floor standing ● with overflow, with tap platform fixings included	350 x 540	16,7	20	223810 00 002	
	Bidet floor standing ● back to wall, with overflow, with tap platform fixings included	360 x 560	20,5	20	224110 00 002	
	Toilet wall mounted washdown model 4,5 l	355 x 545	20,0	20	253509 00 002	
	Fixing for wall mounted bidet and wall mounted toilet					
	caps white	Ø 12 x 180	0,2		006500 00 00	
	caps chrome	Ø 12 x 180	0,2		006500 10 00	
	Noise reduction gasket for wall mounted toilet		0,3		005020 00 00	
	Toilet seat and cover hinges stainless steel					
	without automatic closure			2,42	006731 00 00	
	hinges plastic					
	with SoftClose automatic closure			2,64	006739 00 00	
Infobox: If pre-wall carrier not used, the fixing # 006500 is recommended						
	Toilet wall mounted washout model 6,0 l	355 x 540	18,2	20	221009 00 002	
	Fixing for wall mounted bidet and wall mounted toilet					
	caps white	Ø 12 x 180	0,2		006500 00 00	
	caps chrome	Ø 12 x 180	0,2		006500 10 00	
	Toilet seat and cover hinges stainless steel					
	without automatic closure			2,42	006731 00 00	
	hinges plastic					
	with SoftClose automatic closure			2,64	006739 00 00	
Infobox: If pre-wall carrier not used, the fixing # 006500 is recommended						







D-Code Design by sieger design

Description		mm	kg	Qty.	Model-No.	Euro
						White - 00
	Toilet wall mounted Compact washdown model					
	6,0 l	350 x 480	13,8	20	221109 00 002	
	Fixing for wall mounted bidet and wall mounted toilet					
	caps white	Ø 12 x 180	0,2		006500 00 00	
	caps chrome	Ø 12 x 180	0,2		006500 10 00	
	Toilet seat and cover hinges stainless steel					
	without automatic closure			2,42	006731 00 00	
	hinges plastic					
	with SoftClose automatic closure			2,64	006739 00 00	
Infobox: If pre-wall carrier not used, the fixing # 006500 is recommended						
	Toilet wall mounted suitable for SensoWash D-Code, washdown model					
	6,0 l	360 x 590	19,7	16	222309 00 002	
	Fixing for wall mounted bidet and wall mounted toilet					
	caps white	Ø 12 x 180	0,2		006500 00 00	
	caps chrome	Ø 12 x 180	0,2		006500 10 00	
	Toilet seat and cover elongated, hinges stainless steel					
	without automatic closure			2,5	006741 00 00	
	with automatic closure, removable			2,5	006209 00 96	
Infobox: If pre-wall carrier not used, the fixing # 006500 is recommended / When using the Geberit Design Panel 115.322.11.1 please order elbow 147.236.00.1 / Further details see www.sensowash.com						





D-Code Design by sieger design

Description		mm	kg	Qty.	Model-No.	Euro
						White - 00
	Toilet wall mounted washdown model, suitable for barrier-free applications, projection 700 mm ♻️ 6,0 l	360 x 700	28,3	9	222809 00 002	
	Fixing for wall mounted bidet and wall mounted toilet					
	caps white	Ø 12 x 180	0,2		006500 00 00	
	caps chrome	Ø 12 x 180	0,2		006500 10 00	
	Toilet seat and cover elongated, with lateral reinforcement and extended hinge shaft, hinges stainless steel without automatic closure			2,4	006041 00 00	
	Toilet seat and cover elongated, hinges stainless steel without automatic closure			2,3	006031 00 00	
	with SoftClose automatic closure, removable			2,3	006039 00 00	
	Toilet seat and cover elongated, hinges stainless steel without automatic closure			1,2	006071 00 00	
	Toilet seat and cover without automatic closure, elongated, with lateral reinforcement and extended hinge shaft hinges stainless steel			1,4	006091 00 00	
Infobox: Barrier-free according to DIN 18040-1 and DIN 18040-2 / If pre-wall carrier not used, the fixing # 006500 is recommended						
	Toilet floor standing for independent water supply, washdown model, fixings included, horizontal outlet ♻️ 6,0 l	350 x 480	15,4	16	210809 00 002	
	Toilet seat and cover hinges stainless steel without automatic closure			2,42	006731 00 00	
	hinges plastic with SoftClose automatic closure			2,64	006739 00 00	
	Toilet floor standing for independent water supply, washout model, fixings included, horizontal outlet ♻️ 6,0 l	350 x 480	15,9	16	210909 00 002	
	Toilet seat and cover hinges stainless steel without automatic closure			2,42	006731 00 00	
	hinges plastic with SoftClose automatic closure			2,64	006739 00 00	



D-Code Design by sieger design

Description		mm	kg	Qty.	Model-No.	Euro
						White - 00
	Toilet floor standing for independent water supply, washdown model, fixings included, vertical outlet ♠ 6,0 l	350 x 530	21,7	20	211001 00 002	
	Toilet seat and cover hinges stainless steel without automatic closure		2,42		006731 00 00	
	hinges plastic with SoftClose automatic closure		2,64		006739 00 00	
	Toilet floor standing back to wall, for independent water supply, washdown model, fixings included, horizontal outlet ♠ 6,0 l	355 x 560	22,0	20	211509 00 002	
	Toilet seat and cover hinges stainless steel without automatic closure		2,42		006731 00 00	
	hinges plastic with SoftClose automatic closure		2,64		006739 00 00	
	Toilet close-coupled washdown model, (without cistern), vertical outlet, fixings included ♠ 6,0 l	355 x 650	22,0	12	211101 00 002	
	Cistern with Dual Flush mechanism, chrome, ♠ 6,0 l					
	for side supply	385 x 170	12,5	48	092700 00 04	
	bottom left supply	385 x 170	12,5	48	092710 00 04	
	Conversion set for back supply, chrome		0,2		007508 10 00	
	Toilet seat and cover hinges stainless steel without automatic closure		2,42		006731 00 00	
	hinges plastic with SoftClose automatic closure		2,64		006739 00 00	





D-Code Design by sieger design

Description		mm	kg	Qty.	Model-No.	Euro
						White - 00
	Toilet close-coupled washdown model, (without cistern), horizontal outlet, fixings included 6,0 l	355 x 650	18,6	12	211109 00 002	
	Cistern with Dual Flush mechanism, chrome, 6,0 l					
	for side supply	385 x 170	12,5	48	092700 00 04	
	bottom left supply	385 x 170	12,5	48	092710 00 04	
	Conversion set for back supply, chrome		0,2		007508 10 00	
	Toilet seat and cover hinges stainless steel without automatic closure			2,42	006731 00 00	
	hinges plastic with SoftClose automatic closure			2,64	006739 00 00	
	Toilet close-coupled AUS-Version, washdown model, (without cistern), fixings included, vertical outlet 4,5 l	355 x 650	22,7	12	211401 00 642	
	Cistern with Dual Flush mechanism, chrome, 6,0 l					
	for side supply	385 x 170	12,5	48	092700 00 04	
	bottom left supply	385 x 170	12,5	48	092710 00 04	
	Toilet seat and cover hinges stainless steel without automatic closure			2,42	006731 00 00	
	hinges plastic with SoftClose automatic closure			2,64	006739 00 00	



D-Code Design by sieger design

Description		mm	kg	Qty.	Model-No.	Euro
						White - 00
	Toilet close-coupled washdown model, (without cistern), Outlet for Vario connector set, for horizontal and vertical outlet, length adjustable from 70 - 185 mm, and vario connecting bend, vertical outlet from 175 - 215 mm, fixings included					
	♻️ 6,0 l	355 x 650	24,5	12	211809 00 002	
	Vario connector set for horizontal and vertical outlet, length adjustable incl. excenter	Ø 110	1,5		001422 00 00	
	Vario connecting bend for vertical outlet	Ø 100	0,7		899025 00 06	
	Cistern with Dual Flush mechanism, chrome, ♻️ 6,0 l					
	for side supply	385 x 170	12,5	48	092700 00 04	
	bottom left supply	385 x 170	12,5	48	092710 00 04	
	Conversion set for back supply, chrome		0,2		007508 10 00	
	Toilet seat and cover hinges stainless steel without automatic closure			2,42	006731 00 00	
	hinges plastic with SoftClose automatic closure			2,64	006739 00 00	



D-Code Design by sieger design

	Description	mm	kg	Qty.	Model-No.	Euro
						White - 00
	Toilet close-coupled  washdown model, suitable for SensoWash D-Code, (without cistern), Outlet for Vario connector set, for horizontal and vertical outlet, length adjustable from 70 - 180 mm, and vario connecting bend, vertical outlet from 170 - 210 mm, fixings included ♻️ 6,0 l	360 x 695			214209 00 002	
	Vario connector set for horizontal and vertical outlet, length adjustable incl. excenter	∅ 110	1,5		001422 00 00	
	Vario connecting bend for vertical outlet	∅ 100	0,7		899025 00 06	
	Cistern with Dual Flush mechanism, chrome, ♻️ 6,0 l for side supply bottom left supply	385 x 170 385 x 170	12,5 12,5	48 48	092700 00 04 092710 00 04	
	Conversion set for back supply, chrome		0,2		007508 10 00	
	Cistern Singapore version, with Dual Flush mechanism, chrome, for bottom left supply ♻️ 4,0 l	385 x 170		40	092731 00 05	
	Toilet seat and cover elongated, hinges stainless steel without automatic closure with automatic closure, removable			2,5 2,5	006741 00 00 006209 00 96	
Infobox: When using the Geberit Design Panel 115.322.11.1 please order elbow 147.236.00.1 / Further details see www.sensowash.com						





D-Code Design by sieger design

Description		mm	kg	Qty.	Model-No.	Euro	
						White - 00	
	One-piece toilet US-version, suitable for SensoWash D-Code, elongated with syphonic jet action, 305 mm/12" rough-in, with Single Flush mechanism, with side lever, IAPMO listed, vertical outlet ♠ 1,28 gpf (4,8 l)	395 x 735	39,5	8	011301 00 01		
	Mounting set for One-piece and Two-piece toilets 1/2"		0,48		001418 00 96		
	1/2", US-version		0,48		001431 00 00		
	Toilet seat and cover elongated, hinges stainless steel without automatic closure with automatic closure, removable		2,5		006741 00 00 006209 00 96		
<div style="border: 1px solid black; padding: 5px;"> Infobox: When using the Geberit Design Panel 115.322.11.1 please order elbow 147.236.00.1 / Further details see www.sensowash.com </div>							
	Two-piece toilet (without cistern), US-version, suitable for SensoWash D-Code, elongated with syphonic jet action, 305 mm/12" rough-in, IAPMO listed, vertical outlet ♠ 1,28 gpf (4,8 l)	350 x 685	26,2	12	011701 00 62		
	Mounting set for One-piece and Two-piece toilets 1/2"		0,48		001418 00 96		
	1/2", US-version		0,48		001431 00 00		
	Cistern with Single Flush mechanism, with side lever, 3"/80 mm flapper valve, bottom left supply ♠ 1,28 gpf (4,8 l)	390 x 170	12,0	40	092720 00 02		
	Toilet seat and cover elongated, hinges stainless steel without automatic closure with automatic closure, removable		2,5		006741 00 00 006209 00 96		
	<div style="border: 1px solid black; padding: 5px;"> Infobox: When using the Geberit Design Panel 115.322.11.1 please order elbow 147.236.00.1 / Further details see www.sensowash.com </div>						





D-Code Design by sieger design

	Description	mm	kg	Qty.	Model-No.	Euro
	Urinal visible inlet, rimless, includes jet nozzle, inlet-set, waste, bottle trap Ø 32 mm and fixings model without fly model with fly	305 x 295	14,6	20	082830 00 00	White - 00
	Urinal concealed inlet, rimless, for 1/2" connection, includes jet nozzle, inlet-set, waste, bottle trap Ø 32 mm and fixings model without fly model with fly	305 x 295	14,6	20	082930 00 00	Infobox: In combination with adjustable in-wall flushometers / When using GEBERIT pre-wall carriers model range Duofix # 111.685 / Kombifix # 457.685 / GIS # 461.685 (available up to and including 2008), mandatory in combination with inlet traverse # 242.040.00.1 for 1/2" inlet connection / When using GEBERIT pre-wall carriers model range Duofix # 111.616 / Kombifix # 457.611 / GIS # 461.621 (available from Jan. 2009), mandatory in combination with inlet adapter # 242.042.00.1 for 1/2" inlet connection





Duraplus Design by Duravit

Description	mm	kg	Qty.	Model-No.	Euro		
					White - 00	Pergamon - 47	
 <p>Handrinse basin corner model Triberg with overflow, with tap platform</p>	440 mm ●	440 x 380	6,1	60	079444 .. 00		
	440 mm ●	440 x 380	6,1	60	079444 .. 11		
	Fixing hooks						
	for urinal # 084533 and 084229, for washbasin # 045360						
	for handrinse basin # 079444 and # 075244		0,3			005000 00 00	
 <p>Bidet wall mounted Colomba ● with overflow with tap platform</p>		360 x 575	20,0	24	253210 .. 00		
	Fixing						
	for wall mounted bidet and wall mounted toilet						
	caps white	Ø 12 x 180	0,2			006500 00 00	
	caps chrome	Ø 12 x 180	0,2			006500 10 00	
Infobox: If pre-wall carrier not used, the fixing # 006500 is recommended							
 <p>Toilet wall mounted Colomba washdown model</p>	● 6,0 l	360 x 575	21,2	24	254709 .. 00		
	Fixing						
	for wall mounted bidet and wall mounted toilet						
	caps white	Ø 12 x 180	0,2			006500 00 00	
	caps chrome	Ø 12 x 180	0,2			006500 10 00	
Noise reduction gasket							
for wall mounted toilet		0,3			005020 00 00		
 <p>Toilet seat and cover without automatic closure</p>	hinges stainless steel		2,9		006420 .. 00		
	hinges white		2,9		006427 .. 00		
	hinges plastic		2,4		006630 .. 00		
	with automatic closure						
	hinges stainless steel		2,9		006429 00 00		
	Infobox: If pre-wall carrier not used, the fixing # 006500 is recommended						

Duraplus Design by Duravit

	Description	mm	kg	Qty.	Model-No.	Euro		
						White	- 00	Pergamon - 47
	Toilet wall mounted Bambi washdown model, model for children							
	♻️ 6,0 l	320 x 525	14,0	27	018509 00 00			
	Fixing for wall mounted bidet and wall mounted toilet							
	caps white	Ø 12 x 180	0,2		006500 00 00			
	caps chrome	Ø 12 x 180	0,2		006500 10 00			
	Noise reduction gasket for wall mounted toilet			0,3	005020 00 00			
	Toilet seat and cover hinges stainless steel without automatic closure			1,6	006570 00 00			
	Infobox: If pre-wall carrier not used, the fixing # 006500 is recommended							
	Toilet wall mounted Practica-Cascade (without cistern), cascade model							
	♻️ 6,0 l	365 x 650	17,5	16	019509 .. 00			
	Fixing for wall mounted bidet and wall mounted toilet							
	caps white	Ø 12 x 180	0,2		006500 00 00			
	caps chrome	Ø 12 x 180	0,2		006500 10 00			
	Noise reduction gasket for wall mounted toilet			0,3	005020 00 00			
	Cistern Lago with Dual Flush mechanism, chrome, for side supply							
	♻️ 6,0 l	420 x 185	10,0	27	087400 .. 05			
	Toilet seat and cover without automatic closure							
	hinges stainless steel			2,9	006420 .. 00			
	hinges white			2,9	006427 .. 00			
	hinges plastic			2,4	006630 .. 00			
	with automatic closure							
	hinges stainless steel			2,9	006429 00 00			
Infobox: If pre-wall carrier not used, the fixing # 006500 is recommended								
	Toilet floor standing Bambi for independent water supply, washout model, model for children, horizontal outlet							
	♻️ 6,0 l	300 x 390	11,0	32	010609 00 00			
	Fixing for floor standing bidet, floor standing toilet and siphon cover							
	caps white and chrome	Ø 6 x 70	0,4		006701 10 00			
	Toilet seat and cover hinges stainless steel without automatic closure			1,6	006570 00 00			





DuraStyle Design by Matteo Thun

	Description	mm	kg	Qty.	Model-No.	Euro	
						White - 00	
  	Washbasin with overflow, with tap platform						
	650 mm ●	650 x 440	18,4	15	231965 00 00		
	650 mm ● ● ●	650 x 440	18,4	15	231965 00 30		
	600 mm ●	600 x 440	17,0	15	231960 00 00		
	600 mm ● ● ●	600 x 440	17,0	15	231960 00 30		
	550 mm ●	550 x 440	15,8	24	231955 00 00		
	550 mm ● ● ●	550 x 440	15,8	24	231955 00 30		
	Pedestal for # 231955, 231960, 231965, 232012, 232010, 232080, 232065, 232610, 232680, 232510, 232580			12,1	30	085829 00 00	
	Siphon cover for # 231955, 231960, 231965, 232012, 232010, 232080, 232065, 232610, 232680, 232510, 232580			7,1	40	085830 00 00	
	Fixing for siphon cover			0,1		005503 00 00	
	Washbasin with overflow, with tap platform						
	450 mm ● ● ●	450 x 335	16,1	21	263152 00 30		
	Design Siphon * chrome			1,5	005036 10 00		
	Design angle valve with rosette, chrome	1/2"		0,5	003045 10 00		
	Fixing Set for stone countertops			0,2	005074 10 00		
	Infobox: * When using this siphon please observe outlet height from upper surface of finished floor to centre of outlet in accordance with the technical specification sheet / Measurements of basins represent interior measurements / For installation in stone countertops, please follow the preinstallation sheet available on http://pro.duravit.com / Cutout template available on http://pro.duravit.com / Overview of furniture recommendation see page 656						
	Washbasin Med without overflow, with tap platform						
	650 mm ●	650 x 440	18,1	15	232465 00 00		
	650 mm ☒	650 x 440	18,1	15	232465 00 70		
	600 mm ●	600 x 440	16,5	15	232460 00 00		
	600 mm ☒	600 x 440	16,5	15	232460 00 70		
	550 mm ●	550 x 440	16,1	24	232455 00 00		
	550 mm ☒	550 x 440	16,1	24	232455 00 70		
	Slotted waste chrome	80		0,4	005038 10 00		







WonderGliss
Simply add a '1' to
the model-no.

DuraStyle Design by Matteo Thun

	Description	mm	kg	Qty.	Model-No.	Euro
	Handrinse basin without overflow, with tap platform, 500 mm					White - 00
	without tap hole ☒	500 x 220	7,5	50	071350 00 00	
	tap hole on right side ●	500 x 220	7,5	50	071350 00 08	
	tap hole on left side ●	500 x 220	7,5	50	071350 00 09	
	Slotted waste chrome	50	0,3		005024 10 00	
 	Handrinse basin without overflow, with tap platform 450 mm ●	450 x 335	9,5	28	070845 00 00	
	Siphon cover for # 070845		5,4	48	085831 00 00	
	Fixing for siphon cover		0,1		005503 00 00	
	Slotted waste chrome	50	0,3		005024 10 00	
	Washbowl without overflow, without tap platform, fixings included 600 mm ☒	600 x 380	12,0	24	034960 00 00	
	Design Siphon * chrome		1,5		005036 10 00	
	Design angle valve with rosette, chrome	1/2"	0,5		003045 10 00	
	Slotted waste chrome	50	0,3		005024 10 00	
	Infobox: * When using this siphon please observe outlet height from upper surface of finished floor to centre of outlet in accordance with the technical specification sheet / Overview of furniture recommendation see page 656					
	Washbowl without overflow, without tap platform, fixings included 430 mm ☒	430 x 430	10,3	26	034943 00 00	
	Design Siphon * chrome		1,5		005036 10 00	
	Design angle valve with rosette, chrome	1/2"	0,5		003045 10 00	
	Slotted waste chrome	50	0,3		005024 10 00	
	Infobox: * When using this siphon please observe outlet height from upper surface of finished floor to centre of outlet in accordance with the technical specification sheet / Overview of furniture recommendation see page 656					





DuraStyle Design by Matteo Thun

	Description	mm	kg	Qty.	Model-No.	Euro
						White - 00
	Vanity basin countertop basin, with overflow, with tap platform 615 mm ●	615 x 495	12,5	14	037462 00 00	
Infobox: Overview of furniture recommendation see page 656						
	Vanity basin countertop basin, with overflow, with tap platform 560 mm ●	560 x 455	10,5	21	037456 00 00	
Infobox: Overview of furniture recommendation see page 656						
	Vanity basin countertop basin, without overflow, without tap platform 600 mm ☒	600 x 430	9,5	14	037260 00 00	
	Slotted waste chrome	50	0,3		005024 10 00	
Infobox: Overview of furniture recommendation see page 656						
	Vanity basin countertop basin, without overflow, without tap platform 430 mm ☒	430 x 430	7,5	21	037243 00 00	
	Slotted waste chrome	50	0,3		005024 10 00	
Infobox: Overview of furniture recommendation see page 656						
	Semi-recessed washbasin with overflow, with tap platform, fixings for installation in wooden consoles included 550 mm ●	550 x 455	14,5	21	037555 00 00	
Infobox: Overview of furniture recommendation see page 656						







WonderGliss
Simply add a '1' to
the model-no.

DuraStyle Design by Matteo Thun

Description	mm	kg	Qty.	Model-No.	Euro
					White - 00
	Vanity basin undercounter basin, fixings for installation in wooden consoles included, with overflow, without tap platform				
370 mm ☒	370 x 370	6,2	21	037337 00 00	
	Fixing Set for stone countertops (with the exception of # 046651)				
		0,2		005028 00 00	
Infobox: Measurements of undercounter models represent interior measurements / Overview of furniture recommendation see page 656					
	Vanity basin special ground for Duravit furniture, fixings for installation in wooden consoles included, undercounter basin, with overflow, without tap platform				
370 mm ☒	370 x 370	6,2	21	037337 00 22	
Infobox: Measurements of undercounter models represent interior measurements / Undercounter basin only in combination with variable consoles, as well as vanity units for undercounter basins, see the furniture part. Delivery only in combination of console or vanity unit with attached washbasin / Not available in WonderGliss					
	Furniture washbasin with overflow, with tap platform				
1200 mm ●	1200 x 480	33,2	8	232012 00 00	
1200 mm ● ● ●	1200 x 480	33,2	8	232012 00 30	
1000 mm ●	1000 x 480	28,2	8	232010 00 00	
1000 mm ● ● ●	1000 x 480	28,2	8	232010 00 30	
800 mm ●	800 x 480	22,5	8	232080 00 00	
800 mm ● ● ●	800 x 480	22,5	8	232080 00 30	
650 mm ●	650 x 480	18,3	18	232065 00 00	
650 mm ● ● ●	650 x 480	18,3	18	232065 00 30	
	Siphon for washbasin with outlet pipe 300 mm				
chrome	1 1/4"	0,6		005026 00 00	
Infobox: For fixing the ceramics from the size 1200 mm 2 sets of washbasin fixations are required / Overview of furniture recommendation see page 656					
	Furniture washbasin asymmetric with overflow, with tap platform, bowl on right side				
1000 mm ●	1000 x 480	27,0	8	232610 00 00	
1000 mm ● ● ●	1000 x 480	27,0	8	232610 00 30	
800 mm ●	800 x 480	23,0	8	232680 00 00	
800 mm ● ● ●	800 x 480	23,0	8	232680 00 30	
	Siphon for washbasin with outlet pipe 300 mm				
chrome	1 1/4"	0,6		005026 00 00	
Infobox: Overview of furniture recommendation see page 656					

DuraStyle Design by Matteo Thun

Description	mm	kg	Qty.	Model-No.	Euro
					White - 00
	Furniture washbasin asymmetric				
with overflow, with tap platform, bowl on left side					
1000 mm ●	1000 x 480	27,0	8	232510 00 00	
1000 mm ● ● ●	1000 x 480	27,0	8	232510 00 30	
800 mm ●	800 x 480	23,0	8	232580 00 00	
800 mm ● ● ●	800 x 480	23,0	8	232580 00 30	
Siphon for washbasin					
with outlet pipe 300 mm					
chrome	1 1/4"	0,6		005026 00 00	
Infobox: Overview of furniture recommendation see page 656					
	Bidet wall mounted ●				
with overflow, with tap platform					
Durafix included	370 x 540		16	228715 00 00	
Fixing					
for wall mounted bidet and wall mounted toilet					
caps white	Ø 12 x 180	0,2		006500 00 00	
Siphon for bidet					
with extended outlet pipe					
chrome	1 1/4"	0,6		005027 00 00	
Infobox: If pre-wall carrier not used, the fixing # 006500 is recommended					
	Bidet wall mounted ●				
with overflow with tap platform					
	370 x 540	21,0	16	228215 00 00	
Fixing					
for wall mounted bidet and wall mounted toilet					
caps white	Ø 12 x 180	0,2		006500 00 00	
caps chrome	Ø 12 x 180	0,2		006500 10 00	
Siphon for bidet					
with extended outlet pipe					
chrome	1 1/4"	0,6		005027 00 00	
Infobox: If pre-wall carrier not used, the fixing # 006500 is recommended					
	Bidet wall mounted Compact ●				
with overflow with tap platform					
	370 x 480	21,5	16	228515 00 00	
Fixing					
for wall mounted bidet and wall mounted toilet					
caps white	Ø 12 x 180	0,2		006500 00 00	
caps chrome	Ø 12 x 180	0,2		006500 10 00	
Siphon for bidet					
with extended outlet pipe					
chrome	1 1/4"	0,6		005027 00 00	
Infobox: If pre-wall carrier not used, the fixing # 006500 is recommended					



WonderGliss
Simply add a '1' to
the model-no.

DuraStyle Design by Matteo Thun

	Description	mm	kg	Qty.	Model-No.	Euro	
	Bidet wall mounted ● with overflow, with tap platform Durafix included	370 x 620	21,8	12	228615 00 00	White - 00	
	Fixing for wall mounted bidet and wall mounted toilet caps white	Ø 12 x 180	0,2		006500 00 00		
	Siphon for bidet with extended outlet pipe chrome	1 1/4"	0,6		005027 00 00		
	Infobox: If pre-wall carrier not used, the fixing # 006500 is recommended						
		Bidet floor standing ● with overflow, with tap platform fixings included	370 x 630	27,3	9	228310 00 00	
Siphon for bidet with extended outlet pipe chrome		1 1/4"	0,6		005027 00 00		
	Bidet floor standing ● back to wall, with overflow, with tap platform fixings included	370 x 570	24,8	12	228410 00 00		
	Siphon for bidet with extended outlet pipe chrome	1 1/4"	0,6		005027 00 00		
	Toilet wall mounted washdown model, Durafix included ♀ 4,5 l	370 x 540		16	255209 00 00		
	Fixing for wall mounted bidet and wall mounted toilet caps white	Ø 12 x 180	0,2		006500 00 00		
	Noise reduction gasket for wall mounted toilet			0,3	005064 00 00		
		Toilet seat and cover hinges stainless steel without automatic closure			2,3	006371 00 00	
		with SoftClose automatic closure, removable			2,3	006379 00 00	
		Infobox: Durafix for invisible fixation is included in delivery / If pre-wall carrier not used, the fixing # 006500 is recommended					







DuraStyle Design by Matteo Thun

Description		mm	kg	Qty.	Model-No.	Euro	
	Toilet wall mounted washdown model					White - 00	
	♻️ 4,5 l	370 x 540	25,0	16	253609 00 00		
	Fixing for wall mounted bidet and wall mounted toilet						
	caps white	Ø 12 x 180	0,2		006500 00 00		
	caps chrome	Ø 12 x 180	0,2		006500 10 00		
	Noise reduction gasket for wall mounted toilet			0,3	005064 00 00		
	Toilet seat and cover hinges stainless steel without automatic closure			2,3	006371 00 00		
	with SoftClose automatic closure, removable			2,3	006379 00 00		
	Infobox: If pre-wall carrier not used, the fixing # 006500 is recommended						
		Toilet wall mounted washout model					
♻️ 4,5 l		370 x 540	27,0	16	254009 00 00		
Fixing for wall mounted bidet and wall mounted toilet							
caps white		Ø 12 x 180	0,2		006500 00 00		
caps chrome		Ø 12 x 180	0,2		006500 10 00		
Noise reduction gasket for wall mounted toilet				0,3	005064 00 00		
Toilet seat and cover hinges stainless steel without automatic closure				2,3	006371 00 00		
with SoftClose automatic closure, removable				2,3	006379 00 00		
Infobox: If pre-wall carrier not used, the fixing # 006500 is recommended							
		Toilet wall mounted Compact washdown model					
	♻️ 4,5 l	370 x 480	22,5	16	253909 00 00		
	Fixing for wall mounted bidet and wall mounted toilet						
	caps white	Ø 12 x 180	0,2		006500 00 00		
	caps chrome	Ø 12 x 180	0,2		006500 10 00		
	Noise reduction gasket for wall mounted toilet			0,3	005064 00 00		
	Toilet seat and cover hinges stainless steel without automatic closure			2,3	006371 00 00		
	with SoftClose automatic closure, removable			2,3	006379 00 00		
	Infobox: If pre-wall carrier not used, the fixing # 006500 is recommended						



WonderGliss
Simply add a '1' to
the model-no.

DuraStyle Design by Matteo Thun

	Description	mm	kg	Qty.	Model-No.	Euro
						White - 00
	Toilet wall mounted Compact Fixation clearance 230 mm, washdown model					
	4,5 l	370 x 480	22,5	16	254109 00 00	
	Fixing for wall mounted bidet and wall mounted toilet					
	caps white	Ø 12 x 180	0,2		006500 00 00	
	caps chrome	Ø 12 x 180	0,2		006500 10 00	
	Noise reduction gasket for wall mounted toilet					
			0,3		005064 00 00	
	Toilet seat and cover hinges stainless steel					
	without automatic closure			2,3	006371 00 00	
	with SoftClose automatic closure, removable			2,3	006379 00 00	
	Infobox: If pre-wall carrier not used, the fixing # 006500 is recommended					
	Toilet wall mounted washdown model, Durafix included					
	4,5 l	370 x 620	31,0	12	253709 00 00	
	Fixing for wall mounted bidet and wall mounted toilet					
	caps white	Ø 12 x 180	0,2		006500 00 00	
	Noise reduction gasket for wall mounted toilet					
			0,3		005064 00 00	
	Toilet seat and cover removable, elongated, hinges stainless steel					
	without automatic closure			2,6	006051 00 00	
	with SoftClose automatic closure			2,6	006059 00 00	
	Infobox: Durafix for invisible fixation is included in delivery / If pre-wall carrier not used, the fixing # 006500 is recommended					
	Toilet wall mounted rimless, washdown model, Durafix included					
	4,5 l	370 x 540		16	255109 00 00	
	Fixing for wall mounted bidet and wall mounted toilet					
	caps white	Ø 12 x 180	0,2		006500 00 00	
	Noise reduction gasket for wall mounted toilet					
			0,3		005064 00 00	
	Toilet seat and cover hinges stainless steel					
	without automatic closure			2,3	006371 00 00	
	with SoftClose automatic closure, removable			2,3	006379 00 00	
	Infobox: Durafix for invisible fixation is included in delivery / If pre-wall carrier not used, the fixing # 006500 is recommended					



DuraStyle Design by Matteo Thun

Description		mm	kg	Qty.	Model-No.	Euro		
	Toilet wall mounted rimless, washdown model ♾️ 4,5 l	370 x 540	25,4	16	253809 00 00	White - 00		
	Fixing for wall mounted bidet and wall mounted toilet caps white	∅ 12 x 180	0,2		006500 00 00			
	caps chrome	∅ 12 x 180	0,2		006500 10 00			
	Noise reduction gasket for wall mounted toilet			0,3	005064 00 00			
		Toilet seat and cover hinges stainless steel without automatic closure			2,3	006371 00 00		
		with SoftClose automatic closure, removable			2,3	006379 00 00		
		Infobox: If pre-wall carrier not used, the fixing # 006500 is recommended						
		Toilet wall mounted rimless, washdown model, Durafix included ♾️ 4,5 l	370 x 620	28,3	12	254209 00 00		
		Fixing for wall mounted bidet and wall mounted toilet caps white	∅ 12 x 180	0,2		006500 00 00		
		Noise reduction gasket for wall mounted toilet			0,3	005064 00 00		
		Toilet seat and cover removable, elongated, hinges stainless steel without automatic closure			2,6	006051 00 00		
		with SoftClose automatic closure			2,6	006059 00 00		
		Infobox: Durafix for invisible fixation is included in delivery / If pre-wall carrier not used, the fixing # 006500 is recommended						
		Toilet floor standing back to wall, washdown model, fixings included, horizontal outlet ♾️ 4,5 l	370 x 570	28,0	12	215009 00 00		
			Toilet seat and cover hinges stainless steel without automatic closure			2,3	006371 00 00	
			with SoftClose automatic closure, removable			2,3	006379 00 00	





WonderGliss
Simply add a '1' to
the model-no.

DuraStyle Design by Matteo Thun

Description	mm	kg	Qty.	Model-No.	Euro
					White - 00
 Toilet close-coupled washdown model, (without cistern), Outlet for Vario connector set, for horizontal and vertical outlet, length adjustable from 70 - 170 mm, and vario connecting bend, vertical outlet from 160 - 200 mm, fixings included ♠ 4,5 l	370 x 630	30,5	9	215509 00 00	
Vario connector set for horizontal and vertical outlet, length adjustable incl. excenter	Ø 110	1,5		001422 00 00	
Vario connecting bend for vertical outlet	Ø 100	0,7		899025 00 06	
 Cistern with Dual Flush mechanism, chrome, for side supply ♠ 6,0 l	390 x 170	14,9	27	093500 00 05	
♠ 4,5 l	390 x 170	14,9	27	093500 00 85	
for bottom left supply ♠ 6,0 l	390 x 170	14,9	27	093510 00 05	
♠ 4,5 l	390 x 170	14,9	27	093510 00 85	
Conversion set for back supply chrome		0,5		007504 10 00	
 Toilet seat and cover hinges stainless steel without automatic closure		2,3		006371 00 00	
with SoftClose automatic closure, removable		2,3		006379 00 00	







DuraStyle Design by Matteo Thun

Description	mm	kg	Qty.	Model-No.	Euro	
					White	- 00
 Toilet close-coupled washdown model, (without cistern), Outlet for Vario connector set, for horizontal and vertical outlet, length adjustable from 70 - 190 mm, and vario connecting bend, vertical outlet from 180 - 220 mm, fixings included ♣ 4,5 l	370 x 700	41,3	9	215609 00 00		
	Vario connector set for horizontal and vertical outlet, length adjustable incl. excenter					
	Ø 110	1,5		001422 00 00		
Vario connecting bend for vertical outlet						
	Ø 100	0,7		899025 00 06		
 Cistern with Dual Flush mechanism, chrome, for side supply ♣ 6,0 l ♣ 4,5 l for bottom left supply ♣ 6,0 l ♣ 4,5 l	390 x 170	14,9	27	093500 00 05		
	390 x 170	14,9	27	093500 00 85		
	390 x 170	14,9	27	093510 00 05		
	390 x 170	14,9	27	093510 00 85		
	Conversion set for back supply chrome					
			0,5		007504 10 00	
 Toilet seat and cover removable, elongated, hinges stainless steel without automatic closure with SoftClose automatic closure			2,6	006051 00 00		
			2,6	006059 00 00		







WonderGliss
Simply add a '1' to
the model-no.

DuraStyle Design by Matteo Thun

Description		mm	kg	Qty.	Model-No.	Euro
						White - 00
	Toilet close-coupled Hong Kong / France -version, washdown model, (without cistern), fixings included, horizontal outlet					
	♻️ 4,5 l	370 x 630			216209 00 00	
	Cistern with Dual Flush mechanism, chrome, for side supply					
	♻️ 6,0 l	390 x 170	14,9	27	093500 00 05	
	♻️ 4,5 l	390 x 170	14,9	27	093500 00 85	
	for bottom left supply					
	♻️ 6,0 l	390 x 170	14,9	27	093510 00 05	
	♻️ 4,5 l	390 x 170	14,9	27	093510 00 85	
	Conversion set for back supply chrome			0,5	007504 10 00	
	Cistern Hong-Kong Version, without mechanism, for back, bottem left or right supply					
	♻️ 4,5 l				093530 00 00	
	Toilet seat and cover hinges stainless steel					
	without automatic closure			2,3	006371 00 00	
	with SoftClose automatic closure, removable			2,3	006379 00 00	
	One-piece toilet US-version, elongated with syphonic jet action, 305 mm/12" rough-in, with dual flush piston valve, top flush, IAPMO listed, vertical outlet					
	♻️ 1,32/0,92 gpf (5/3,5 l)	370 x 720	55,0	8	215701 00 05	
	Mounting set for One-piece and Two-piece toilets					
	1/2"			0,48	001416 00 00	
	1/2", US-version			0,48	001417 00 00	
	Toilet seat and cover removable, elongated, hinges stainless steel					
	without automatic closure			2,6	006051 00 00	
	with SoftClose automatic closure			2,6	006059 00 00	



DuraStyle Design by Matteo Thun

	Description	mm	kg	Qty.	Model-No.	Euro
						White -- 00
	Two-piece toilet US-version, elongated with syphonic jet action, 305 mm/12" rough-in, with dual flush piston valve, top flush, IAPMO listed, vertical outlet ♻️ 1,32/0,92 gpf (5/3,5 l)		41,7	12	216001 00 00	
	Cistern with dual flush piston valve, top flush, for bottom left supply ♻️ 1,32/0,92 gpf (5/3,5 l)		13,6	40	093520 00 05	
	Mounting set for One-piece and Two-piece toilets 1/2"		0,48		001418 00 96	
	Toilet seat and cover removable, elongated, hinges stainless steel without automatic closure with SoftClose automatic closure		2,6		006051 00 00 006059 00 00	
	Urinal concealed inlet, syphonic action, vertical or horizontal outlet, fixings included model without fly model with fly	300 x 340 300 x 340	15,4 15,4	16 16	280430 00 00 280430 00 07	
	Water inlet mechanism for urinals with back supply 1/2"		0,1		695800 00 00	
	Siphon vertical outlet horizontal outlet (concealed)	Ø 50 Ø 50	0,2 0,2		005111 00 00 005112 00 00	
	Urinal visible inlet, syphonic action, vertical or horizontal outlet, fixings included model without fly model with fly	300 x 340 300 x 340	15,4 15,4	16 16	280530 00 00 280530 00 07	
	Siphon vertical outlet horizontal outlet (concealed)	Ø 50 Ø 50	0,2 0,2		005111 00 00 005112 00 00	





WonderGliss
Simply add a '1' to
the model-no.



DuraStyle Design by Matteo Thun

Description	mm	kg	Qty.	Model-No.	Euro	
					White - 00	
 <p>Urinal concealed inlet, rimless, for 1/2" connection, horizontal outlet Ø 50 mm, includes jet nozzle, inlet-set, siphon-trap and fixings</p>	model without fly	300 x 340	13,9	16	280630 00 00	
	model with fly	300 x 340	13,9	16	280630 00 07	
	Air trap					
	Spare part		0,02			100342 00 00
	Inspection key					
Spare part		0,02			100344 00 00	
<p>Infobox: In combination with adjustable in-wall flushometers / When using GEBERIT pre-wall carriers model range Duofix # 111.616 / Kombifix # 457.611 / GIS # 461.621 (available from Jan. 2009), mandatory in combination with inlet adapter # 242.042.00.1 for 1/2" inlet connection / When using GEBERIT pre-wall carriers model range Duofix # 111.685 / Kombifix # 457.685 / GIS # 461.685 (available up to and including 2008), mandatory in combination with inlet traverse # 242.040.00.1 for 1/2" inlet connection</p>						
 <p>Urinal visible inlet, rimless, horizontal outlet Ø 50 mm, includes jet nozzle, inlet-set, siphon-trap and fixings</p>	model without fly	300 x 340	13,9	16	280730 00 00	
	model with fly	300 x 340	13,9	16	280730 00 07	
	Air trap					
	Spare part		0,02			100342 00 00
	Inspection key					
Spare part		0,02			100344 00 00	
<p>Infobox: For flushometers with a distance of 50 mm from wall to center flush pipe / In combination with adjustable flushometers without ventilation</p>						
 <p>Urinal Electronic urinal for battery supply, concealed inlet, syphonic action, horizontal outlet, complete control unit and fixings included</p>	model without fly	300 x 340	17,6	12	280431 00 00	
	model with fly	300 x 340	17,6	12	280431 00 07	
	Siphon					
	horizontal outlet (concealed)	Ø 50	0,2			005112 00 00



DuraStyle Design by Matteo Thun

Description	mm	kg	Qty.	Model-No.	Euro
					White - 00
					
Urinal Electronic urinal for power supply, concealed inlet, syphonic action, horizontal outlet, complete control unit and fixings included					
model without fly	300 x 340	17,6	12	280431 00 93	
model with fly	300 x 340	17,6	12	280431 00 97	
Pre-assembly set power supply unit 230V including electrical outlet		0,2		005004 00 00	
Siphon horizontal outlet (concealed)	Ø 50	0,2		005112 00 00	
Infobox: The power supply isn't included in delivery					
					
Urinal Electronic urinal for battery supply, rimless, concealed inlet, horizontal outlet Ø 50 mm, complete control unit, jet nozzle, inlet-set, siphon-trap and fixings included					
model without fly	300 x 340	16,1	12	280631 00 00	
model with fly	300 x 340	16,1	12	280631 00 07	
Air trap Spare part		0,02		100342 00 00	
Inspection key Spare part		0,02		100344 00 00	
					
Urinal Electronic urinal for power supply, rimless, concealed inlet, horizontal outlet Ø 50 mm, complete control unit, jet nozzle, inlet-set, siphon-trap and fixings included					
model without fly	300 x 340	16,1	12	280631 00 93	
model with fly	300 x 340	16,1	12	280631 00 97	
Pre-assembly set power supply unit 230V including electrical outlet		0,2		005004 00 00	
Air trap Spare part		0,02		100342 00 00	
Inspection key Spare part		0,02		100344 00 00	
Infobox: The power supply isn't included in delivery					





DuraStyle Design by Matteo Thun

Description	mm	kg	Qty.	Model-No.	Euro
					White - 00
 Urinal DuraStyle Dry waterless, horizontal outlet Ø 50 mm, Air trap and fixing included					
	model without fly	300 x 340	13,8	16	280830 00 00
model with fly 	300 x 340	13,8	16	280830 00 07	
Air trap incl. Key-Ring					
Spare part			0,07	100384 00 00	
Air trap					
Spare part			0,02	100342 00 00	
Inspection key					
Spare part			0,02	100344 00 00	
Blue cleaner					
Cleaner with spray top					
6 bottles 500 ml each			3,6	005062 00 00	
Infobox: Not available in WonderGliss					









Esplanade Design by Sergei Tchoban

Description	mm	kg	Qty.	Model-No.	Euro
					White - 00
	Furniture washbasin with overflow, with tap platform, overflow clip chrome included				
	850 mm ●	850 x 535	24,0	7	262285 00 00
	850 mm ● ● ●	850 x 535	24,0	7	262285 00 30
	600 mm ●	600 x 535	17,3	14	262260 00 00
	600 mm ● ● ●	600 x 535	17,3	14	262260 00 30
	Siphon for washbasin with outlet pipe 300 mm chrome	1 1/4"	0,6		005026 00 00
Infobox: Overview of furniture recommendation see page 656					
	Bidet wall mounted ● with overflow, with tap platform, overflow clip chrome included, Durafix included				
	Oak	450 x 560	26,2	6	226610 00 00
	Silk	450 x 560	26,2	6	226510 00 00
	Siphon for bidet with extended outlet pipe chrome	1 1/4"	0,6		005027 00 00
	Fixing for wall mounted bidet and wall mounted toilet caps white	Ø 12 x 180	0,2		006500 00 00
Infobox: Durafix for invisible fixation is included in delivery / If pre-wall carrier not used, the fixing # 006500 is recommended					
	Bidet floor standing ● with overflow, with tap platform, overflow clip chrome included, fixings included				
	Oak	450 x 650	32,4	6	226210 00 00
	Silk	450 x 650	32,4	6	226110 00 00
	Siphon for bidet with extended outlet pipe chrome	1 1/4"	0,6		005027 00 00

Esplanade Design by Sergei Tchoban

Description		mm	kg	Qty.	Model-No.	Euro
						White - 00
	Toilet wall mounted washdown model, Durafix included, 4,5 l					
	Oak	450 x 560	27,5	6	255409 00 00	
	Silk	450 x 560	27,5	6	255309 00 00	
	Noise reduction gasket for wall mounted bidet and wall mounted toilet		0,3		005019 00 00	
	Fixing for wall mounted bidet and wall mounted toilet					
	caps white	Ø 12 x 180	0,2		006500 00 00	
	Toilet seat and cover hinges stainless steel with SoftClose automatic closure			3,9	006979 00 00	
Infobox: Durafix for invisible fixation is included in delivery / If pre-wall carrier not used, the fixing # 006500 is recommended						
	Toilet close-coupled washdown model, (without cistern), Outlet for Vario connector set, for horizontal and vertical outlet, length adjustable from 70 - 170 mm, and vario connecting bend, vertical outlet from 170 - 220 mm, fixings included, 4,5 l					
	Oak	450 x 650	36,7	6	214709 00 00	
	Silk	450 x 650	36,7	6	214609 00 00	
	Vario connector set for horizontal and vertical outlet, length adjustable					
	incl. excenter	Ø 110	1,5		001422 00 00	
	Vario connecting bend for vertical outlet	Ø 100	0,7		899025 00 06	
	Cistern with Dual Flush mechanism, chrome, concealed left supply					
	6,0 l	440 x 180	14,5	16	087280 00 05	
	4,5 l	440 x 180	14,5	16	087280 00 85	
	Toilet seat and cover hinges stainless steel with SoftClose automatic closure			3,9	006979 00 00	





Bathroom_Foster Design by Norman Foster

Description	mm	kg	Qty.	Model-No.	Euro	
					White	- 00
 <p>Washbasin with overflow, with tap platform</p>	700 mm ○ ● ○	19,0	12	041970 00 00		
	600 mm ○ ● ○	15,0	15	041960 00 00		
	550 mm ○ ● ○	14,9	21	041955 00 00		
 <p>Pedestal for # 041970, 041960 and 041955</p>	155 x 255	10,8	24	086398 00 00		
 <p>Siphon cover for # 041970, 041960 and 041955</p>	160 x 325	5,7	32	086397 00 00		
 <p>Fixing for siphon cover</p>		0,1		005503 00 00		
 <p>Handrinse basin with overflow, with tap platform</p>	470 mm ●	9,9	21	041947 00 00		
 <p>Siphon cover for # 041947</p>	160 x 275	4,7	32	086399 00 00		
 <p>Fixing for siphon cover</p>		0,1		005503 00 00		
 <p>Washbowl with overflow, without tap platform, fixings included</p>	495 mm	8,9	24	033550 00 00		
<p>Pop-up basin waste chrome</p>						
	with horizontal lever**	0,5		005031 10 00		
	with vertical lever***	0,5		005051 10 00		
<p>Infobox: *** In combination with wall mounted tap and Duravit bathroom furniture / Overview of furniture recommendation see page 656 / ** Required in conjunction with wall mounted tap fitting and consoles with a maximum thickness of 30 mm</p>						
 <p>Vanity basin undercounter basin, with overflow, without tap platform, fixings included</p>	430 mm	6,8	24	033643 00 00		
<p>Fixing Set for stone countertops (with the exception of # 046651)</p>		0,2		005028 00 00		
<p>Design Siphon * chrome</p>		1,5		005036 10 00		
<p>Design angle valve with rosette, chrome</p>	1/2"	0,5		003045 10 00		
<p>Infobox: Measurements of undercounter models represent interior measurements / * When using this siphon please observe outlet height from upper surface of finished floor to centre of outlet in accordance with the technical specification sheet</p>						







WonderGliss
Simply add a '1' to
the model-no.





Bathroom_Foster Design by Norman Foster

Description	mm	kg	Qty.	Model-No.	Euro
					White - 00
	Bidet wall mounted ●				
	with overflow				
	with tap platform	360 x 570	15,0	16	013415 00 00
Fixing					
for wall mounted bidet and wall mounted toilet					
caps chrome	Ø 12 x 180	0,2		006500 10 00	
Infobox: If pre-wall carrier not used, the fixing # 006500 is recommended					
	Bidet floor standing ●				
	with overflow, with tap platform				
	fixings included	360 x 570	18,7	12	013410 00 00
	Toilet wall mounted				
	washdown model				
	♻️ 6,0 l	360 x 570	17,5	16	017509 00 00
Fixing					
for wall mounted bidet and wall mounted toilet					
caps chrome	Ø 12 x 180	0,2		006500 10 00	
Noise reduction gasket					
for wall mounted toilet					
		0,3		005020 00 00	
	Toilet seat and cover				
	hinges stainless steel				
	without automatic closure		2,8		006021 00 00
removable,					
hinge plate stainless steel					
with SoftClose automatic closure		2,5		006279 00 00	
Infobox: If pre-wall carrier not used, the fixing # 006500 is recommended					



Bathroom_Foster Design by Norman Foster

Description	mm	kg	Qty.	Model-No.	Euro
					White - 00
	Toilet close-coupled washdown model, (without cistern), Outlet for Vario connector set, for horizontal and vertical outlet, length adjustable from 70 - 200 mm, and vario connecting bend, vertical outlet from 190 - 230 mm, fixings included 6,0 l	360 x 660	24,2	9	017609 00 00
	Vario connector set for horizontal and vertical outlet, length adjustable incl. excenter	Ø 110	1,5		001422 00 00
	Vario connecting bend for vertical outlet	Ø 100	0,7		899025 00 06
	Cistern with Dual Flush mechanism, chrome, 6,0 l				
	for side supply	375 x 175	12,5	27	091200 00 05
	for bottom left supply	375 x 175	12,5	27	091210 00 05
	Conversion set for back supply chrome		0,5		007504 10 00
	Toilet seat and cover hinges stainless steel without automatic closure removable, hinge plate stainless steel with SoftClose automatic closure				
			2,8		006021 00 00
			2,5		006279 00 00
	Toilet floor standing for independent water supply, washdown model, fixings included, horizontal outlet 6,0 l	360 x 570	20,0	12	017709 00 00
	Toilet seat and cover hinges stainless steel without automatic closure removable, hinge plate stainless steel with SoftClose automatic closure				
			2,8		006021 00 00
			2,5		006279 00 00

Happy D.2 Design by sieger design

Description		mm	kg	Qty.	Model-No.	Euro
						White - 00
	Washbasin with overflow, with tap platform, overflow clip chrome included					
	800 mm ●	800 x 525	25,9	8	231680 00 00	
	800 mm ● ● ●	800 x 525	25,9	8	231680 00 30	
	650 mm ●	650 x 500	20,8	18	231665 00 00	
	650 mm ● ● ●	650 x 500	20,8	18	231665 00 30	
	600 mm ●	600 x 475	19,5	21	231660 00 00	
	600 mm ● ● ●	600 x 475	19,5	21	231660 00 30	
	Design Siphon * chrome		1,5		005036 10 00	
	Design angle valve with rosette, chrome	1/2"	0,5		003045 10 00	
	Pedestal for # 231680, 231665, 231660		13,9	32	085827 00 00	
	Siphon cover for # 231680, 231665, 231660		7,6	40	085828 00 00	
Fixing for siphon cover		0,1		005503 00 00		
Infobox: * When using this siphon please observe outlet height from upper surface of finished floor to centre of outlet in accordance with the technical specification sheet						
	Handrinse basin with overflow, with tap platform, overflow clip chrome included					
	500 mm ●	500 x 360	12,3	32	070950 00 00	
	Siphon cover for # 070950		5,8	40	085832 00 00	
	Handrinse basin without overflow, with tap platform, 500 mm					
	without tap hole ☒	500 x 220	7,2	50	071150 00 00	
	tap hole on right side ●	500 x 220	7,2	50	071150 00 08	
tap hole on left side ●	500 x 220	7,2	50	071150 00 09		
	Furniture handrinse basin with overflow, with tap platform, overflow clip chrome included					
	500 mm ●	500 x 360	10,1	32	071050 00 00	
Infobox: Overview of furniture recommendation see page 656						



Happy D.2 Design by sieger design

Description	mm	kg	Qty.	Model-No.	Euro
					White - 00
 Washbowl ground, with overflow, with tap platform, fixings included, overflow clip chrome included 650 mm ●	650 x 400	18,5	17	231765 00 00	
Design Siphon * chrome		1,5		005036 10 00	
Design angle valve with rosette, chrome	1/2"	0,5		003045 10 00	
Infobox: * When using this siphon please observe outlet height from upper surface of finished floor to centre of outlet in accordance with the technical specification sheet / Overview of furniture recommendation see page 656					
 Washbowl ground, with overflow, with tap platform, back plane unglazed, fixings included, overflow clip chrome included 600 mm ●	600 x 460	16,0	15	231560 00 00	
Design Siphon * chrome		1,5		005036 10 00	
Design angle valve with rosette, chrome	1/2"	0,5		003045 10 00	
Infobox: * When using this siphon please observe outlet height from upper surface of finished floor to centre of outlet in accordance with the technical specification sheet / Overview of furniture recommendation see page 656 / Mounting only in combination with console					
 Washbowl ground, with overflow, without tap platform, fixings included, overflow clip chrome included 600 mm ☒	600 x 400	13,6	18	231460 00 00	
Design Siphon * chrome		1,5		005036 10 00	
Design angle valve with rosette, chrome	1/2"	0,5		003045 10 00	
Pop-up basin waste chrome with horizontal lever**		0,5		005031 10 00	
Push-open waste *** chrome		0,35		005052 10 00	
Infobox: * When using this siphon please observe outlet height from upper surface of finished floor to centre of outlet in accordance with the technical specification sheet / *** Required in conjunction with wall mounted tap fitting, vanity unit and/or consoles / Overview of furniture recommendation see page 656 / ** Required in conjunction with wall mounted tap fitting and consoles with a maximum thickness of 30 mm					





WonderGliss
Simply add a '1' to
the model-no.





Happy D.2 Design by sieger design

Description		mm	kg	Qty.	Model-No.	Euro
						White - 00
	Washbowl					
	ground, with overflow, without tap platform, fixings included, overflow clip chrome included					
	400 mm ☒	400 x 400	12,0	21	231440 00 00	
	Design Siphon *					
	chrome		1,5		005036 10 00	
	Design angle valve					
	with rosette, chrome	1/2"	0,5		003045 10 00	
Pop-up basin waste						
chrome						
with horizontal lever**		0,5		005031 10 00		
Push-open waste ***						
chrome		0,35		005052 10 00		
<div style="border: 1px solid black; padding: 5px;"> Infobox: * When using this siphon please observe outlet height from upper surface of finished floor to centre of outlet in accordance with the technical specification sheet / *** Required in conjunction with wall mounted tap fitting, vanity unit and/or consoles / Overview of furniture recommendation see page 656 / ** Required in conjunction with wall mounted tap fitting and consoles with a maximum thickness of 30 mm </div>						
	Vanity basin					
	countertop basin, with overflow, overflow clip chrome included, with tap platform					
	600 mm ●	600 x 460	8,6		048360 00 00	
	600 mm ● ● ●	600 x 460	8,6		048360 00 30	
	Design Siphon *					
	chrome		1,5		005036 10 00	
	Design angle valve					
with rosette, chrome	1/2"	0,5		003045 10 00		
<div style="border: 1px solid black; padding: 5px;"> Infobox: * When using this siphon please observe outlet height from upper surface of finished floor to centre of outlet in accordance with the technical specification sheet / Overview of furniture recommendation see page 656 </div>						





Happy D.2 Design by sieger design

Description	mm	kg	Qty.	Model-No.	Euro
					White - 00
	Vanity basin undercounter basin, with overflow, without tap platform, fixings for installation in wooden consoles included 480 mm ☒	480 x 345	8,0	21	045748 00 00
	Fixing Set for stone countertops (with the exception of # 046651)		0,2		005028 00 00
	Design Siphon * chrome		1,5		005036 10 00
	Design angle valve with rosette, chrome	1/2"	0,5		003045 10 00
	Push-open waste *** chrome		0,35		005052 10 00
<p>Infobox: * When using this siphon please observe outlet height from upper surface of finished floor to centre of outlet in accordance with the technical specification sheet / *** Required in conjunction with wall mounted tap fitting, vanity unit and/or consoles / Measurements of undercounter models represent interior measurements</p>					
	Furniture washbasin with overflow, with tap platform, overflow clip chrome included 1200 mm ● 1200 mm ● ● ● 1000 mm ● 1000 mm ● ● ● 800 mm ● 800 mm ● ● ● 650 mm ● 650 mm ● ● ●	1200 x 505 1200 x 505 1000 x 505 1000 x 505 800 x 505 800 x 505 650 x 505 650 x 505			231812 00 00 231812 00 30 231810 00 00 231810 00 30 231880 00 00 231880 00 30 231865 00 00 231865 00 30
	Design Siphon * chrome		1,5		005036 10 00
	Design angle valve with rosette, chrome	1/2"	0,5		003045 10 00
	Space saving siphon White	1 1/4"	0,4		005073 00 00
	Metal console height adjustable +50 mm, chrome for washbasin # 231812 for washbasin # 231810 for washbasin # 231880 for washbasin # 231865				003079 10 00 003076 10 00 003077 10 00 003078 10 00
<p>Infobox: * When using this siphon please observe outlet height from upper surface of finished floor to centre of outlet in accordance with the technical specification sheet / For fixing the ceramics from the size 1200 mm 2 sets of washbasin fixations are required / For vanity units the space saving siphon is recommended / Overview of furniture recommendation see page 656</p>					







Happy D.2 Design by sieger design

Description	mm	kg	Qty.	Model-No.	Euro	
					White -- 00	
 Furniture washbasin ground with overflow, with tap platform, overflow clip chrome included	1200 mm ●	1200 x 505		231812 00 27		
	1200 mm ● ● ●	1200 x 505		231812 00 25		
	1000 mm ●	1000 x 505	27,0	8	231810 00 27	
	1000 mm ● ● ●	1000 x 505	27,0	8	231810 00 25	
	800 mm ●	800 x 505	25,9	8	231880 00 27	
	800 mm ● ● ●	800 x 505	25,9	8	231880 00 25	
	650 mm ●	650 x 505	21,0	18	231865 00 27	
	650 mm ● ● ●	650 x 505	21,0	18	231865 00 25	
Design Siphon * chrome		1,5		005036 10 00		
Design angle valve with rosette, chrome	1/2"	0,5		003045 10 00		
Infobox: * When using this siphon please observe outlet height from upper surface of finished floor to centre of outlet in accordance with the technical specification sheet / For fixing the ceramics from the size 1200 mm 2 sets of washbasin fixations are required / Overview of furniture recommendation see page 656						
 Furniture washbasin with overflow, with tap platform, overflow clip chrome included	1200 mm ● ●	1200 x 505		231812 00 24		
	Design Siphon * chrome		1,5		005036 10 00	
	Design angle valve with rosette, chrome	1/2"	0,5		003045 10 00	
	Space saving siphon White	1 1/4"	0,4		005073 00 00	
 Metal console height adjustable +50 mm, chrome for washbasin # 231812				003079 10 00		
	Infobox: * When using this siphon please observe outlet height from upper surface of finished floor to centre of outlet in accordance with the technical specification sheet / For fixing the ceramics from the size 1200 mm 2 sets of washbasin fixations are required / For vanity units the space saving siphon is recommended / Overview of furniture recommendation see page 656					
 Furniture washbasin ground with overflow, with tap platform, overflow clip chrome included	1200 mm ● ●	1200 x 505		231812 00 26		
	Design Siphon * chrome		1,5		005036 10 00	
	Design angle valve with rosette, chrome	1/2"	0,5		003045 10 00	
	Infobox: * When using this siphon please observe outlet height from upper surface of finished floor to centre of outlet in accordance with the technical specification sheet / For fixing the ceramics from the size 1200 mm 2 sets of washbasin fixations are required / Overview of furniture recommendation see page 656					





Happy D.2 Design by sieger design

	Description	mm	kg	Qty.	Model-No.	Euro
						White -- 00
	Bidet wall mounted ● with overflow, with tap platform, overflow clip chrome included Durafix included	355 x 540	18,6	20	225815 00 00	
	Fixing for wall mounted bidet and wall mounted toilet caps white	Ø 12 x 180	0,2		006500 00 00	
Infobox: Durafix for invisible fixation is included in delivery / If pre-wall carrier not used, the fixing # 006500 is recommended						
	Bidet floor standing ● with overflow, with tap platform, overflow clip chrome included fixings included	365 x 630	26,4	9	225910 00 00	
	Bidet floor standing ● back to wall, with overflow, with tap platform, overflow clip chrome included fixings included	365 x 570	25,3	12	226710 00 00	
	Toilet wall mounted washdown model, Durafix included ♻️ 4,5 l	365 x 540	26,8	16	222109 00 00	
	Fixing for wall mounted bidet and wall mounted toilet caps white	Ø 12 x 180	0,2		006500 00 00	
	Noise reduction gasket for wall mounted toilet		0,3		005064 00 00	
	Toilet seat and cover removable, hinges stainless steel without automatic closure with SoftClose automatic closure			2,7 2,7	006451 00 00 006459 00 00	
Infobox: Durafix for invisible fixation is included in delivery / If pre-wall carrier not used, the fixing # 006500 is recommended						

Happy D.2 Design by sieger design

Description		mm	kg	Qty.	Model-No.	Euro
						White - 00
	Toilet wall mounted rimless, washdown model, Durafix included ♻️ 4,5 l	365 x 540			222209 00 00	
	Fixing for wall mounted bidet and wall mounted toilet caps white	Ø 12 x 180	0,2		006500 00 00	
	Noise reduction gasket for wall mounted toilet		0,3		005064 00 00	
	Toilet seat and cover removable, hinges stainless steel without automatic closure with SoftClose automatic closure		2,7 2,7		006451 00 00 006459 00 00	
Infobox: Durafix for invisible fixation is included in delivery / If pre-wall carrier not used, the fixing # 006500 is recommended						
	Toilet wall mounted rimless, washdown model, Durafix included ♻️ 4,5 l	365 x 620	28,2		255009 00 00	
	Fixing for wall mounted bidet and wall mounted toilet caps white	Ø 12 x 180	0,2		006500 00 00	
	Noise reduction gasket for wall mounted toilet		0,3		005064 00 00	
	Toilet seat and cover removable, hinges stainless steel, elongated without automatic closure with SoftClose automatic closure		2,9 2,7		006461 00 00 006469 00 00	
Infobox: Durafix for invisible fixation is included in delivery / If pre-wall carrier not used, the fixing # 006500 is recommended						
	Toilet floor standing back to wall, for independent water supply, washdown model, fixings included, horizontal outlet ♻️ 4,5 l	365 x 570	29,0	12	215909 00 00	
	Toilet seat and cover removable, hinges stainless steel without automatic closure with SoftClose automatic closure		2,7 2,7		006451 00 00 006459 00 00	



Happy D.2 Design by sieger design

Description		mm	kg	Qty.	Model-No.	Euro
						White - 00
	Toilet close-coupled washdown model, (without cistern), Outlet for Vario connector set, for horizontal and vertical outlet, length adjustable from 70 - 170 mm, and vario connecting bend, vertical outlet from 160 - 200 mm, fixings included					
	♠ 4,5 l	365 x 630	37,8	9	213409 00 00	
	Vario connector set for horizontal and vertical outlet, length adjustable incl. excenter	∅ 110	1,5		001422 00 00	
	Vario connecting bend for vertical outlet	∅ 100	0,7		899025 00 06	
	Cistern with Dual Flush mechanism, chrome, for side supply					
	♠ 6,0 l		13,0	27	093400 00 05	
	♠ 4,5 l		13,0	27	093400 00 85	
	for bottom left supply					
	♠ 6,0 l		13,0	27	093410 00 05	
	♠ 4,5 l		13,0	27	093410 00 85	
	Conversion set for back supply chrome		0,5		007504 10 00	
	Toilet seat and cover removable, hinges stainless steel without automatic closure			2,7	006451 00 00	
	with SoftClose automatic closure			2,7	006459 00 00	
	One-piece toilet US-version, elongated with syphonic jet action, 305 mm/12" rough-in, with dual flush piston valve, top flush, IAPMO listed, vertical outlet					
	♠ 1,32/0,92 gpf (5/3,5 l)	385 x 710	57,0		212101 00 01	
	Mounting set for One-piece and Two-piece toilets					
	1/2"		0,48		001418 00 96	
	1/2", US-version		0,48		001431 00 00	
	Toilet seat and cover removable, hinges stainless steel, elongated					
	without automatic closure		2,9		006461 00 00	
	with SoftClose automatic closure		2,7		006469 00 00	





WonderGliss
Simply add a '1' to
the model-no.



Happy D.2 Design by sieger design

Description		mm	kg	Qty.	Model-No.	Euro
						White - 00
	Two-piece toilet (without cistern), US-version, elongated with syphonic jet action, 305 mm/12" rough-in, IAPMO listed, vertical outlet ♠ 1,28 gpf (4,8 l)	365 x 700	28,4	12	011201 00 62	
	Cistern with Single Flush piston valve, top flush, chrome, bottom left supply ♠ 1,28 gpf (4,8 l)		12,45	40	092910 00 05	
	Mounting set for One-piece and Two-piece toilets 1/2"		0,48		001418 00 96	
	1/2", US-version		0,48		001431 00 00	
	Toilet seat and cover elongated, hinges stainless steel without automatic closure		3,1		006851 00 00	

PuraVida Design by Phoenix Design





Description	mm	kg	Qty.	Model-No.	Euro
					White - 00
	Washbasin without overflow, with tap platform, ceramic covered slotted waste included				
700 mm ●	700 x 500	18,1	15	270070 00 00	
700 mm ● ● ●	700 x 500	18,1	15	270070 00 30	
600 mm ●	600 x 465	14,9	15	270060 00 00	
600 mm ● ● ●	600 x 465	14,9	15	270060 00 30	
	Design Siphon * chrome		1,5	005036 10 00	
	Design angle valve with rosette, chrome	1/2"	0,5	003045 10 00	
	Pedestal for # 270070, 270170, 270060, 270160		11,6 24	085810 00 00	
	Siphon cover for # 270070, 270170, 270060, 270160		6,0 24	085812 00 00	
	Fixing for siphon cover		0,1	005503 00 00	

Infobox: * When using this siphon please observe outlet height from upper surface of finished floor to centre of outlet in accordance with the technical specification sheet







	Washbasin + without overflow, with tap platform, with deep basin, ceramic covered slotted waste included				
700 mm ●	700 x 500	18,7	15	270170 00 00	
700 mm ● ● ●	700 x 500	18,7	15	270170 00 30	
600 mm ●	600 x 465	15,6	15	270160 00 00	
600 mm ● ● ●	600 x 465	15,6	15	270160 00 30	
	Design Siphon * chrome		1,5	005036 10 00	
	Design angle valve with rosette, chrome	1/2"	0,5	003045 10 00	
	Pedestal for # 270070, 270170, 270060, 270160		11,6 24	085810 00 00	
	Siphon cover for # 270070, 270170, 270060, 270160		6,0 24	085812 00 00	
	Fixing for siphon cover		0,1	005503 00 00	

Infobox: * When using this siphon please observe outlet height from upper surface of finished floor to centre of outlet in accordance with the technical specification sheet





PuraVida Design by Phoenix Design

Description		mm	kg	Qty.	Model-No.	Euro
						White - 00
	Handrinse basin without overflow, with tap platform, ceramic covered slotted waste included					
	500 mm ●	500 x 420	12,9	21	072050 00 00	
	Siphon cover for # 072050		4,8	24	085813 00 00	
	Fixing for siphon cover		0,1		005503 00 00	
	Washbowl ground, without overflow, without tap platform, fixings and ceramic covered slotted waste included					
	700 mm ☒	700 x 420	11,8	20	037070 00 00	
	Design Siphon * chrome		1,5		005036 10 00	
	Design angle valve with rosette, chrome	1/2"	0,5		003045 10 00	
Infobox: * When using this siphon please observe outlet height from upper surface of finished floor to centre of outlet in accordance with the technical specification sheet / Overview of furniture recommendation see page 656						
	Washbowl + ground, without overflow, without tap platform, with deep basin, fixings and ceramic covered slotted waste included					
	700 mm ☒	700 x 465	13,5	17	036970 00 00	
	Design Siphon * chrome		1,5		005036 10 00	
	Design angle valve with rosette, chrome	1/2"	0,5		003045 10 00	
Infobox: * When using this siphon please observe outlet height from upper surface of finished floor to centre of outlet in accordance with the technical specification sheet / Overview of furniture recommendation see page 656						
	Furniture washbasin without overflow, with tap platform, fixings and ceramic covered slotted waste included					
	1000 mm ●	1000 x 525	19,6	10	037110 00 00	
	1000 mm ● ● ●	1000 x 525	19,6	10	037110 00 30	
	Space saving siphon White	1 1/4"	0,4		005073 00 00	
Infobox: Overview of furniture recommendation see page 656 / For vanity units the space saving siphon is recommended / Installation only in combination with PuraVida vanity unit						

PuraVida Design by Phoenix Design

Description	mm	kg	Qty.	Model-No.	Euro
					White - 00
 Furniture handrinse basin without overflow, with tap platform, fixings and ceramic covered slotted waste included 500 mm ●	500 x 420	10,0	24	072150 00 00	
Space saving siphon White	1 1/4"	0,4		005073 00 00	
Infobox: For vanity units the space saving siphon is recommended / Overview of furniture recommendation see page 656 / Installation only in combination with PuraVida vanity unit					
 Bidet wall mounted ● with overflow, with tap platform, Durafix and ceramic covered pop-up waste, included	360 x 545	18,0	20	224715 00 00	
Fixing for wall mounted bidet and wall mounted toilet caps white	Ø 12 x 180	0,2		006500 00 00	
Infobox: Durafix for concealed fixation is included in delivery / If pre-wall carrier not used, the fixing # 006500 is recommended					
 Bidet floor standing ● with overflow, with tap platform, fixings and ceramic covered pop-up waste, included	360 x 630	25,0	12	224710 00 00	
 Bidet floor standing ● back to wall, with overflow, with tap platform, fixings and ceramic covered pop-up waste, included	360 x 575	24,0	16	224610 00 00	
 Toilet wall mounted washdown model, Durafix included ♀6,0 l	360 x 545	23,0	16	221909 00 00	
Noise reduction gasket for wall mounted toilet		0,3		005064 00 00	
Fixing for wall mounted bidet and wall mounted toilet caps white	Ø 12 x 180	0,2		006500 00 00	
 Toilet seat and cover hinges stainless steel with SoftClose automatic closure		2,9		006919 00 00	
Infobox: Durafix for concealed fixation is included in delivery / If pre-wall carrier not used, the fixing # 006500 is recommended					

PuraVida Design by Phoenix Design

Description		mm	kg	Qty.	Model-No.	Euro
						White - 00
	Toilet floor standing back to wall, for independent water supply, washdown model, fixings included, horizontal outlet ♻️ 6,0 l	360 x 575	27,0	12	213209 00 00	
	Toilet seat and cover hinges stainless steel with SoftClose automatic closure		2,9		006919 00 00	
	Toilet close-coupled washdown model, (without cistern), Outlet for Vario connector set, for horizontal and vertical outlet, length adjustable from 70 - 165 mm, and vario connecting bend, vertical outlet from 155 - 195 mm, fixings included ♻️ 6,0 l	360 x 630	31,0	9	211909 00 00	
	Vario connector set for horizontal and vertical outlet, length adjustable incl. excenter	Ø 110	1,5		001422 00 00	
	Vario connecting bend for vertical outlet	Ø 100	0,7		899025 00 06	
	Cistern with Dual Flush mechanism, chrome, concealed left supply ♻️ 6,0 l ♻️ 4,5 l	365 x 135 365 x 135	12,5 12,5	22 22	087270 00 05 087270 00 85	
	Toilet seat and cover hinges stainless steel with SoftClose automatic closure		2,9		006919 00 00	





Scola Design by Duravit

Description	mm	kg	Qty.	Model-No.	Euro
					White - 00
					
Washbasin					
with overflow, with tap platform					
bowl on left side ●	615 x 460	23,3	15	068460 00 11	
bowl on right side ●	615 x 460	23,3	15	068560 00 11	
with overflow, with tap platform, with pre-punched tap hole					
bowl on left side ●	615 x 460	23,3	15	068460 00 00	
bowl on right side ●	615 x 460	23,3	15	068560 00 00	
Pop-up basin waste					
chrome					
with horizontal lever**		0,5		005031 10 00	
Design Siphon *					
chrome		1,5		005036 10 00	
Design angle valve					
with rosette, chrome	1/2"	0,5		003045 10 00	
Metal console					
for washbasin # 068460 and 068560					
chrome		2,7		003059 10 00	





Infobox: * When using this siphon please observe outlet height from upper surface of finished floor to centre of outlet in accordance with the technical specification sheet / ** Required in conjunction with wall mounted tap fitting and consoles with a maximum thickness of 30 mm



Starck 1 Design by Philippe Starck

Description	mm	kg	Qty.	Model-No.	Euro	
					White	- 00
 Washbasin with overflow, with tap platform, overflow clip chrome included						
900 mm ●	900 x 550	21,7	8	040590 00 00		
900 mm ● ● ●	900 x 550	21,7	8	040590 00 30		
750 mm ●	750 x 545	18,9	8	040575 00 00		
750 mm ● ● ●	750 x 545	18,9	8	040575 00 30		
Siphon for washbasin with outlet pipe 300 mm chrome	1 1/4"	0,6		005026 00 00		
Pedestal for # 040590, 040575	225 x 375	15,1	12	086350 00 00		
 Pedestal for # 040590, 040575 model for towel rails	225 x 375	12,8	12	086351 00 00		
Fixing caps chrome	Ø 6 x 60	0,1		006700 10 00		
Siphon cover for # 040590, 040575	165 x 375	8,6	20	086355 00 00		
 Siphon cover for # 040590, 040575 model for towel rails	165 x 375	8,6	20	086356 00 00		
Fixing for siphon cover		0,1		005503 00 00		
Towel rail (1 pair) chrome		0,2		003050 10 00		
 Washbasin with overflow, with tap platform, overflow clip chrome included, fixings included						
570 mm ●	Ø 570	14,5	12	040557 00 00		
Siphon for washbasin with outlet pipe 300 mm chrome	1 1/4"	0,6		005026 00 00		
Siphon cover for # 040557	185 x 385	9,3	20	086352 00 00		
 Siphon cover for # 040557 model for towel rails	185 x 385	9,0	20	086353 00 00		
Fixing for siphon cover	Ø 10 x 100	0,2		006704 10 00		
Towel rail (1 pair) chrome		0,2		003050 10 00		
Infobox: Siphon covers # 086352 or 086353 are mandatory for the installation of the washbasin # 040557						



Starck 1 Design by Philippe Starck

Description		mm	kg	Qty.	Model-No.	Euro	
						White - 00	
	Vanity basin countertop basin, with overflow, with tap platform, outside fully glazed, overflow clip chrome included 535 mm ●	Ø 535	10,2	10	040753 00 00		
	<hr/>						
	Furniture washbasin with overflow, with tap platform, overflow clip chrome included, for vanity unit # S1 9520 580 mm ●	Ø 580	12,6	18	040658 00 00		
	Siphon for washbasin with outlet pipe 300 mm chrome	1 1/4"	0,6		005026 00 00		
	Infobox: Overview of furniture recommendation see page 656						
	Washbasin bowl on right side, without overflow, ceramic covered slotted waste included 1100 mm ●	1100 x 570	28,4	10	230910 00 00		
	1100 mm ☒	1100 x 570	28,4	10	230910 00 70		
	Design Siphon * chrome			1,5		005036 10 00	
	Design angle valve with rosette, chrome	1/2"	0,5			003045 10 00	
	Metal console height adjustable +50 mm, for # 230710 and 230910 chrome			4,5	36	003048 10 00	
	Infobox: * When using this siphon please observe outlet height from upper surface of finished floor to centre of outlet in accordance with the technical specification sheet / For # 230710, 230910 and 230557 installation with vanity unit or metal console is mandatory / Axor Starck X tap fittings are recommended						
	<hr/>						

Starck 1 Design by Philippe Starck

Description	mm	kg	Qty.	Model-No.	Euro
					White - 00
 <p>Washbasin bowl on left side, without overflow, ceramic covered slotted waste included</p> <p>1100 mm ● 1100 x 570 30,4 10 230710 00 00</p> <p>1100 mm ☒ 1100 x 570 30,4 10 230710 00 70</p> <p>Design Siphon * chrome 1,5 005036 10 00</p> <p>Design angle valve with rosette, chrome 1/2" 0,5 003045 10 00</p> <p>Metal console height adjustable +50 mm, for # 230710 and 230910 chrome 4,5 36 003048 10 00</p> <p>Infobox: * When using this siphon please observe outlet height from upper surface of finished floor to centre of outlet in accordance with the technical specification sheet / For # 230710, 230910 and 230557 installation with vanity unit or metal console is mandatory / Axor Starck X tap fittings are recommended</p>					
 <p>Washbasin without overflow, without tap platform, ceramic covered slotted waste included</p> <p>705 mm ● 705 x 520 27,5 12 230370 00 00</p> <p>705 mm ☒ 705 x 520 27,5 12 230370 00 70</p> <p>Design Siphon * chrome 1,5 005036 10 00</p> <p>Design angle valve with rosette, chrome 1/2" 0,5 003045 10 00</p> <p>Infobox: * When using this siphon please observe outlet height from upper surface of finished floor to centre of outlet in accordance with the technical specification sheet</p>					
 <p>Washbasin without overflow, without tap platform, fixings and ceramic covered slotted waste included</p> <p>570 mm ● 570 x 570 14,4 20 230557 00 00</p> <p>570 mm ☒ 570 x 570 14,4 20 230557 00 70</p> <p>Design Siphon * chrome 1,5 005036 10 00</p> <p>Design angle valve with rosette, chrome 1/2" 0,5 003045 10 00</p> <p>Metal console for # 230557, height adjustable +50 mm chrome 4,0 60 003049 10 00</p> <p>Infobox: * When using this siphon please observe outlet height from upper surface of finished floor to centre of outlet in accordance with the technical specification sheet</p>					



Starck 1 Design by Philippe Starck

Description	mm	kg	Qty.	Model-No.	Euro
					White - 00
	Washbowl ground, with overflow, without tap platform, overflow clip chrome included, fixings included 530 mm ☒	Ø 530	11,7	18	044753 00 00
	Pop-up basin waste chrome				
	with horizontal lever**		0,5		005031 10 00
	with vertical lever***		0,5		005051 10 00
	Design Siphon * chrome		1,5		005036 10 00
	Design angle valve with rosette, chrome	1/2"	0,5		003045 10 00
<p>Infobox: *** In combination with wall mounted tap and Duravit bathroom furniture / * When using this siphon please observe outlet height from upper surface of finished floor to centre of outlet in accordance with the technical specification sheet / Overview of furniture recommendation see page 656 / ** Required in conjunction with wall mounted tap fitting and consoles with a maximum thickness of 30 mm</p>					
	Washbowl with overflow, without tap platform, overflow clip chrome included, fixings included 530 mm ☒	Ø 530	9,8	16	040853 00 00
	Pop-up basin waste chrome				
	with horizontal lever**		0,5		005031 10 00
	with vertical lever***		0,5		005051 10 00
	Design Siphon * chrome		1,5		005036 10 00
	Design angle valve with rosette, chrome	1/2"	0,5		003045 10 00
<p>Infobox: *** In combination with wall mounted tap and Duravit bathroom furniture / * When using this siphon please observe outlet height from upper surface of finished floor to centre of outlet in accordance with the technical specification sheet / Overview of furniture recommendation see page 656 / ** Required in conjunction with wall mounted tap fitting and consoles with a maximum thickness of 30 mm</p>					





WonderGliss
Simply add a '1' to
the model-no.

Starck 1 Design by Philippe Starck

	Description	mm	kg	Qty.	Model-No.	Euro
						White - 00
	Above counter basin ground, with overflow, with tap platform, fixings included					
	480 mm ●	Ø 480	15,1	21	044648 00 00	
	Drain cover chrome			0,1	005040 10 00	
	Design Siphon * chrome			1,5	005036 10 00	
	Design angle valve with rosette, chrome	1/2"		0,5	003045 10 00	
Infobox: * When using this siphon please observe outlet height from upper surface of finished floor to centre of outlet in accordance with the technical specification sheet / With not visible ceramic overflow / Attention: Washbowl # 044648 only in combination with Drain cover # 005040 / Overview of furniture recommendation see page 656						
	Washbowl ground, without overflow, without tap platform, fixings and ceramic covered slotted waste included					
	470 mm ●	Ø 470	10,2	26	038647 00 27	
	470 mm ☒	Ø 470	10,2	26	038647 00 28	
	Design Siphon * chrome			1,5	005036 10 00	
	Design angle valve with rosette, chrome	1/2"		0,5	003045 10 00	
Infobox: * When using this siphon please observe outlet height from upper surface of finished floor to centre of outlet in accordance with the technical specification sheet / Overview of furniture recommendation see page 656						
	Furniture washbasin without overflow, without tap platform, fixings and ceramic covered slotted waste included					
	470 mm ●	Ø 470	10,2	26	038647 00 00	
	470 mm ☒	Ø 470	10,2	26	038647 00 70	
	Space saving siphon White	1 1/4"		0,4	005073 00 00	
	Infobox: Overview of furniture recommendation see page 656 / For vanity units the space saving siphon is recommended					

Starck 1 Design by Philippe Starck

Description	mm	kg	Qty.	Model-No.	Euro
					White - 00
 <p>Washbowl ground, without overflow, without tap platform, fixings and ceramic covered slotted waste included</p>	470 mm ●	470 x 470	11,5	24	038747 00 27
	470 mm ☒	470 x 470	11,5	24	038747 00 28
	Design Siphon *				
	chrome		1,5		005036 10 00
	Design angle valve				
with rosette, chrome	1/2"	0,5		003045 10 00	
Infobox: * When using this siphon please observe outlet height from upper surface of finished floor to centre of outlet in accordance with the technical specification sheet / Overview of furniture recommendation see page 656					
 <p>Furniture washbasin without overflow, without tap platform, fixings and ceramic covered slotted waste included</p>	470 mm ●	470 x 470	11,5	24	038747 00 00
	470 mm ☒	470 x 470	11,5	24	038747 00 70
	Space saving siphon				
	White	1 1/4"	0,4		005073 00 00
	Infobox: Overview of furniture recommendation see page 656 / For vanity units the space saving siphon is recommended				
 <p>Washbowl with tap dome, ground, without overflow</p>	460 mm ●	460 x 460	9,4	26	232246 00 00
	Slotted waste				
	chrome	50	0,3		005024 10 00
	Design Siphon *				
	chrome		1,5		005036 10 00
Design angle valve					
with rosette, chrome	1/2"	0,5		003045 10 00	
Infobox: * When using this siphon please observe outlet height from upper surface of finished floor to centre of outlet in accordance with the technical specification sheet / We recommend the following taps: Axor Starck Puro (Hansgrohe), Metris S (Hansgrohe), Metris 110 (Hansgrohe), Talis 150 (Hansgrohe), Focus 190 (Hansgrohe), Imo (Dornbracht) / Overview of furniture recommendation see page 656					

Starck 1 Design by Philippe Starck

	Description	mm	kg	Qty.	Model-No.	Euro
						White - 00
	Washbowl ground, without overflow, without tap platform, fixings included					
	460 mm ☒	Ø 460	11,2	21	044546 00 00	
	Slotted waste chrome	50	0,3		005024 10 00	
	Design Siphon * chrome		1,5		005036 10 00	
	Design angle valve with rosette, chrome	1/2"	0,5		003045 10 00	
Infobox: * When using this siphon please observe outlet height from upper surface of finished floor to centre of outlet in accordance with the technical specification sheet / Overview of furniture recommendation see page 656						
	Washbowl with overflow, without tap platform, overflow clip chrome included					
	330 mm ☒	Ø 330	4,9	30	040833 00 00	
	Pop-up basin waste chrome					
	with horizontal lever**		0,5		005031 10 00	
	with vertical lever***		0,5		005051 10 00	
	Design Siphon * chrome		1,5		005036 10 00	
	Design angle valve with rosette, chrome	1/2"	0,5		003045 10 00	
Infobox: *** In combination with wall mounted tap and Duravit bathroom furniture / * When using this siphon please observe outlet height from upper surface of finished floor to centre of outlet in accordance with the technical specification sheet / Installation of washbowl # 040833 should be carried out by experts only using a special glue. Diameter of cut-out is Ø 115 mm / ** Required in conjunction with wall mounted tap fitting and consoles with a maximum thickness of 30 mm / Overview of furniture recommendation see page 656						
	Bidet wall mounted ● with overflow, with tap platform, overflow clip chrome included					
	Durafix included	410 x 575	21,0	12	027415 00 00	
	Siphon for bidet with extended outlet pipe					
	chrome	1 1/4"	0,6		005027 00 00	
	Fixing for wall mounted bidet and wall mounted toilet					
caps white	Ø 12 x 180	0,2		006500 00 00		
Infobox: Please use Philippe Starck taps only for bidets / Durafix for concealed fixation is included in delivery / If pre-wall carrier not used, the fixing # 006500 is recommended						





Starck 1 Design by Philippe Starck

	Description	mm	kg	Qty.	Model-No.	Euro
						White - 00
	Bidet floor standing ● with overflow, with tap platform, overflow clip chrome included fixings included	410 x 640	28,4	9	027410 00 00	
	Siphon for bidet with extended outlet pipe chrome	1 1/4"	0,6		005027 00 00	
	Infobox: Please use Philippe Starck taps only for bidets					
	Toilet wall mounted washdown model, Durafix included ♀ 4,5 l	410 x 575	27,5	12	021009 00 64	
	Noise reduction gasket for wall mounted bidet and wall mounted toilet		0,3		005019 00 00	
	Fixing for wall mounted bidet and wall mounted toilet caps white	∅ 12 x 180	0,2		006500 00 00	
	Toilet seat and cover removable, with hinge shaft, hinge plate stainless steel with SoftClose automatic closure			3,4	006588 00 99	
Infobox: Durafix for concealed fixation is included in delivery / If pre-wall carrier not used, the fixing # 006500 is recommended						





WonderGliss
Simply add a '1' to
the model-no.









Starck 1 Design by Philippe Starck

Description	mm	kg	Qty.	Model-No.	Euro
					White - 00
 Toilet close-coupled washdown model, (without cistern), Outlet for Vario connector set, for horizontal and vertical outlet, length adjustable from 70 - 190 mm, and vario connecting bend, vertical outlet from 180 - 220 mm, fixings included ♻️ 4,5 l	415 x 640	36,9	9	023309 00 64	
Vario connector set for horizontal and vertical outlet, length adjustable incl. excenter	Ø 110	1,5		001422 00 00	
Vario connecting bend for vertical outlet	Ø 100	0,7		899025 00 06	
 Cistern with Stop & Go mechanism, concealed left supply, push button CLASSIC, chrome ♻️ 6,0 l ♻️ 4,5 l	390 x 125 390 x 125	14,0 14,0	24 24	872700 00 05 872700 00 85	
 Cistern with Stop & Go mechanism, concealed left supply, push button PURO, chrome ♻️ 6,0 l ♻️ 4,5 l	390 x 125 390 x 125	14,0 14,0	24 24	872710 00 05 872710 00 85	
 Toilet seat and cover removable, with hinge shaft, hinge plate stainless steel with SoftClose automatic closure			3,4	006588 00 99	
 Urinal concealed inlet and outlet, syphonic action, fixings included, model without cover model without fly model with fly	320 x 285 320 x 285	10,5 10,5	20 20	083432 00 00 083432 00 07	
Siphon horizontal outlet (concealed)	Ø 50	0,2		005112 00 00	
Water inlet mechanism for urinals with back supply	1/2"	0,1		695800 00 00	
Urinal screen Stainless steel		0,2		005041 10 00	





Starck 1 Design by Philippe Starck

Description	mm	kg	Qty.	Model-No.	Euro
					White - 00
 Urinal concealed inlet and outlet, syphonic action, fixings included, model for cover					
model without fly	320 x 285	10,6	20	083532 00 00	
model with fly 	320 x 285	10,6	20	083532 00 07	
Siphon horizontal outlet (concealed)	Ø 50	0,2		005112 00 00	
Water inlet mechanism for urinals with back supply	1/2"	0,1		695800 00 00	
Urinal screen Stainless steel		0,2		005041 10 00	
 Urinal Cover hinges stainless steel		0,9		006591 00 00	





Starck 2 Design by Philippe Starck

Description	mm	kg	Qty.	Model-No.	Euro	
					White	- 00
 Washbasin with overflow, with tap platform						
650 mm ●	650 x 500	18,2	12	232365 00 00		
650 mm ● ● ●	650 x 500	18,2	12	232365 00 30		
600 mm ●	600 x 500	16,8	18	232360 00 00		
600 mm ● ● ●	600 x 500	16,8	18	232360 00 30		
550 mm ●	550 x 500	15,7	24	232355 00 00		
550 mm ● ● ●	550 x 500	15,7	24	232355 00 30		
 Pedestal for # 232365, 232360, 232355		8,7	32	085833 00 00		
 Siphon cover for # 232365, 232360, 232355		5,8	40	085834 00 00		
Fixing for siphon cover		0,1		005503 00 00		
 Washbasin ground with overflow, with tap platform, fixings included						
600 mm ●	600 x 500	16,8	18	232360 00 27		
600 mm ● ● ●	600 x 500	16,8	18	232360 00 25		
Design Siphon * chrome		1,5		005036 10 00		
Design angle valve with rosette, chrome	1/2"	0,5		003045 10 00		
Infobox: * When using this siphon please observe outlet height from upper surface of finished floor to centre of outlet in accordance with the technical specification sheet / Overview of furniture recommendation see page 656						
 Handrinse basin with overflow, with tap platform						
500 mm ●	500 x 390	12,5	28	071450 00 00		
 Siphon cover for # 071450		5,0	40	085835 00 00		
Fixing for siphon cover		0,1		005503 00 00		
 Handrinse basin without overflow, with tap platform, 380 mm pre-punched tap hole on left and right side ● ●						
	380 x 260	5,3	45	076138 00 00		
Slotted waste chrome	50	0,3		005024 10 00		
 Siphon cover for # 076138	175 x 185	2,8	40	086383 00 00		
Fixing for siphon cover		0,1		005504 00 00		
Infobox: Handrinse basin # 076138 with siphon cover # 086383 only available in connection with bottle trap						





Starck 2 Design by Philippe Starck

	Description	mm	kg	Qty.	Model-No.	Euro
						White -- 00
	Washbowl ground, without overflow, without tap platform, fixings included 440 mm ☒	440 x 400	7,5	24	232144 00 00	
	Slotted waste chrome	50	0,3		005024 10 00	
	Design Siphon * chrome		1,5		005036 10 00	
	Design angle valve with rosette, chrome	1/2"	0,5		003045 10 00	
InfoBox: * When using this siphon please observe outlet height from upper surface of finished floor to centre of outlet in accordance with the technical specification sheet / Overview of furniture recommendation see page 656						
	Vanity basin countertop basin, with overflow, with tap platform 480 mm ●	Ø 480	8,6		232748 00 00	
InfoBox: Overview of furniture recommendation see page 656						
	Bidet wall mounted ● with overflow, with tap platform Durafix included	370 x 540	22,2	16	227115 00 00	
	Fixing for wall mounted bidet and wall mounted toilet caps white	Ø 12 x 180	0,2		006500 00 00	
	Siphon for bidet with extended outlet pipe chrome	1 1/4"	0,6		005027 00 00	
InfoBox: Durafix for invisible fixation is included in delivery / If pre-wall carrier not used, the fixing # 006500 is recommended						
	Bidet floor standing ● with overflow, with tap platform fixings included	370 x 630	29,4	9	227210 00 00	
	Siphon for bidet with extended outlet pipe chrome	1 1/4"	0,6		005027 00 00	

Starck 2 Design by Philippe Starck

	Description	mm	kg	Qty.	Model-No.	Euro
						White - 00
	Bidet floor standing ● back to wall, with overflow, with tap platform fixings included	370 x 570	28,0	12	225510 00 00	
	Siphon for bidet with extended outlet pipe chrome	1 1/4"	0,6		005027 00 00	
	<hr/>					
	Toilet wall mounted washdown model, Durafix included 4,5 l	370 x 540	26,0	16	253409 00 00	
	Fixing for wall mounted bidet and wall mounted toilet caps white	Ø 12 x 180	0,2		006500 00 00	
	Noise reduction gasket for wall mounted toilet		0,3		005064 00 00	
	Toilet seat and cover hinges stainless steel without automatic closure with SoftClose automatic closure, removable		2,4 2,7		006981 00 00 006989 00 00	
	Infobox: Durafix for invisible fixation is included in delivery / If pre-wall carrier not used, the fixing # 006500 is recommended					
	<hr/>					
	Toilet wall mounted washdown model, suitable for SensoWash Starck, Durafix included 4,5 l	375 x 620	29,0	12	253309 00 00	
	Fixing for wall mounted bidet and wall mounted toilet caps white	Ø 12 x 180	0,2		006500 00 00	
	Noise reduction gasket for wall mounted toilet		0,3		005064 00 00	
	Toilet seat and cover elongated, hinges stainless steel without automatic closure removable, with automatic closure		2,0 2,0		006332 00 00 006339 00 00	
	Infobox: Durafix for invisible fixation is included in delivery / If pre-wall carrier not used, the fixing # 006500 is recommended / When using the Geberit Design Panel 115.322.11.1 please order elbow 147.236.00.1 / Further details see www.sensowash.com					



Starck 2 Design by Philippe Starck

Description		mm	kg	Qty.	Model-No.	Euro
						White - 00
	Toilet floor standing back to wall, washdown model, fixings included, horizontal outlet					
	♻️ 4,5 l	370 x 570	32,0	12	212809 00 00	
	Toilet seat and cover hinges stainless steel					
	without automatic closure		2,4		006981 00 00	
	with SoftClose automatic closure, removable		2,7		006989 00 00	
	Toilet close-coupled washdown model, (without cistern), Outlet for Vario connector set, for horizontal and vertical outlet, length adjustable from 70 - 210 mm, and vario connecting bend, vertical outlet from 200 - 240 mm, fixings included					
	♻️ 6,0 l	355 x 640	24,5	9	023809 00 00	
	Vario connector set for horizontal and vertical outlet, length adjustable incl. excenter	Ø 110	1,5		001422 00 00	
	Vario connecting bend for vertical outlet	Ø 100	0,7		899025 00 06	
	Cistern with Dual Flush mechanism, chrome, ♻️ 6,0 l					
	for side supply	370 x 180	10,4	27	872900 00 05	
	for bottom left supply	370 x 180	10,4	27	872910 00 05	
	Toilet seat and cover hinges stainless steel					
	without automatic closure		3,0		006691 00 00	
	with SoftClose automatic closure, removable		3,2		006699 00 00	







WonderGliss
Simply add a '1' to
the model-no.





Starck 2 Design by Philippe Starck

Description	mm	kg	Qty.	Model-No.	Euro
					White - 00
 Toilet close-coupled washdown model, suitable for SensoWash Starck, (without cistern), Outlet for Vario connector set, for horizontal and vertical outlet, length adjustable from 70 - 200 mm, and vario connecting bend, vertical outlet from 200 - 240 mm, fixings included ♠ 4,5 l	370 x 725	39,0	9	212909 00 00	
Vario connector set for horizontal and vertical outlet, length adjustable incl. excenter	∅ 110	1,5		001422 00 00	
Vario connecting bend for vertical outlet	∅ 100	0,7		899025 00 06	
 Cistern Singapore version, with Dual Flush mechanism, chrome, concealed left supply ♠ 6,0 l	370 x 145	11,2	22	093300 00 05	
♠ 4,5 l	370 x 145	11,2	22	093300 00 85	
 Toilet seat and cover elongated, hinges stainless steel without automatic closure removable, with automatic closure					
		2,0		006332 00 00	
		2,0		006339 00 00	
Infobox: When using the Geberit Design Panel 115.322.11.1 please order elbow 147.236.00.1 / Further details see www.sensowash.com					





Starck 2 Design by Philippe Starck

Description		mm	kg	Qty.	Model-No.	Euro
						White - 00
	Toilet close-coupled washdown model, (without cistern), Outlet for Vario connector set, for horizontal and vertical outlet, length adjustable from 70 - 200 mm, and vario connecting bend, vertical outlet from 160 - 200 mm, fixings included					
	♻️ 4,5 l	370 x 630	36,0	9	214509 00 00	
	Vario connector set for horizontal and vertical outlet, length adjustable incl. excenter	Ø 110	1,5		001422 00 00	
	Vario connecting bend for vertical outlet	Ø 100	0,7		899025 00 06	
	Cistern Singapore version, with Dual Flush mechanism, chrome, concealed left supply					
	♻️ 6,0 l	370 x 145	11,2	22	093300 00 05	
	♻️ 4,5 l	370 x 145	11,2	22	093300 00 85	
	Toilet seat and cover hinges stainless steel without automatic closure		2,4		006981 00 00	
	with SoftClose automatic closure, removable		2,7		006989 00 00	
	<hr/>					
	One-piece toilet US-version, suitable for SensoWash Starck, elongated with syphonic jet action, 305 mm/12" rough-in, with Single Flush piston valve, top flush, IAPMO listed, vertical outlet					
	♻️ 1,28 gpf (4,8 l)	375 x 715	57,0	8	213301 00 05	
	Mounting set for One-piece and Two-piece toilets 1/2"		0,48		001418 00 96	
	1/2", US-version		0,48		001431 00 00	
	Toilet seat and cover elongated, hinges stainless steel without automatic closure		2,0		006332 00 00	
	removable, with automatic closure		2,0		006339 00 00	
	<hr/>					
Infobox: When using the Geberit Design Panel 115.322.11.1 please order elbow 147.236.00.1 / Further details see www.sensowash.com						

Starck 2 Design by Philippe Starck

Description	mm	kg	Qty.	Model-No.	Euro
					White - 00
					
Urinal concealed inlet and outlet, syphonic action, fixings included, model without cover					
model without fly	320 x 285	10,5	20	083432 00 00	
model with fly 	320 x 285	10,5	20	083432 00 07	
Siphon horizontal outlet (concealed)	Ø 50	0,2		005112 00 00	
Water inlet mechanism for urinals with back supply	1/2"	0,1		695800 00 00	
Urinal screen Stainless steel		0,2		005041 10 00	
					
Urinal concealed inlet and outlet, syphonic action, fixings included, model for cover					
model without fly	320 x 285	10,6	20	083532 00 00	
model with fly 	320 x 285	10,6	20	083532 00 07	
Siphon horizontal outlet (concealed)	Ø 50	0,2		005112 00 00	
Water inlet mechanism for urinals with back supply	1/2"	0,1		695800 00 00	
Urinal screen Stainless steel		0,2		005041 10 00	
					
Urinal Cover hinges stainless steel		0,9		006591 00 00	







Starck 3 Design by Philippe Starck

Description	mm	kg	Qty.	Model-No.	Euro	
					White	- 00
 Washbasin with overflow, with tap platform 1050 mm ○ ● ○ 850 mm ○ ● ○ 700 mm ○ ● ○	1050 x 485 850 x 485 700 x 490	25,8 22,4 21,2	8 8 12	030410 00 00 030480 00 00 030470 00 00		
Pedestal for # 030065, 030060, 030055 030410, 030480, 030470, 033213	150 x 210	14,0	36	086516 00 00		
Siphon cover for # 030065, 030060, 030055 030410, 030480, 030470, 033213	170 x 285	8,1	40	086515 00 00		
Fixing for siphon cover		0,1		005503 00 00		
 Furniture washbasin with overflow, with tap platform 1050 mm ○ ● ○ 850 mm ○ ● ○ 700 mm ○ ● ○	1050 x 485 850 x 485 700 x 490	25,8 22,4 21,2	8 8 12	030410 00 00 030480 00 00 030470 00 00		
Space saving siphon White	1 1/4"	0,4		005073 00 00		
Infobox: Suitable for universal vanity units and vanity units of X-Large and Ketho / Overview of furniture recommendation see page 656 / For vanity units the space saving siphon is recommended						
 Washbasin with overflow, with tap platform 650 mm ○ ● ○ 600 mm ○ ● ○ 550 mm ○ ● ○ 500 mm ○ ● ○	650 x 485 600 x 450 550 x 430 500 x 360	21,0 19,0 14,9 14,1	15 15 18 24	030065 00 00 030060 00 00 030055 00 00 030050 00 00		
Pedestal for # 030065, 030060, 030055 030410, 030480, 030470, 033213	150 x 210	14,0	36	086516 00 00		
Siphon cover for # 030065, 030060, 030055 030410, 030480, 030470, 033213 for # 030050, 075045 030160, 030155	170 x 285 165 x 240	8,1 5,8	40 30	086515 00 00 086517 00 00		
Fixing for siphon cover		0,1		005503 00 00		
 Washbasin Med without overflow, with tap platform, with pre-punched tap hole 600 mm ● 550 mm ● 500 mm ●	600 x 450 550 x 420 500 x 360	18,3 14,9 13,4	15 18 24	030760 00 00 030755 00 00 030750 00 00		
Slotted waste chrome	80	0,4		005038 10 00		









WonderGliss
Simply add a '1' to
the model-no.

Starck 3 Design by Philippe Starck

	Description	mm	kg	Qty.	Model-No.	Euro
						White - - 00
	Washbasin Compact with overflow, with tap platform					
	600 mm ○ ● ○	600 x 370	15,9	20	030160 00 00	
	550 mm ○ ● ○	550 x 370	13,0	20	030155 00 00	
	Siphon cover for # 030050, 075045					
	030160, 030155	165 x 240	5,8	30	086517 00 00	
	Fixing for siphon cover					
			0,1		005503 00 00	
	Washbasin with overflow, with tap platform					
	700 mm ○ ● ○	700 x 545	20,8	14	030970 00 00	
	600 mm ○ ● ○	600 x 545	18,0	12	030960 00 00	
	Infobox: Barrier-free according to DIN 18040-1 and DIN 18040-2					
	Washbasin without overflow, with tap platform, with pre-punched tap hole					
	700 mm ●	700 x 545	20,8	14	031270 00 00	
	600 mm ●	600 x 545	18,0	12	031260 00 00	
	Slotted waste chrome	80				
			0,4		005038 10 00	
	Infobox: Barrier-free according to DIN 18040-1 and DIN 18040-2					
	Washbasin with overflow, with tap platform, outside fully glazed					
	480 mm ● ● ●	480 x 465	12,5	21	030348 00 30	
	480 mm ○ ● ○	480 x 465	12,5	21	030348 00 00	
	Metal console height adjustable +50 mm for furniture basin # 030348, chrome					
			2,5		003064 10 00	
	Infobox: Only in combination with metal console					
	Furniture washbasin with overflow, with tap platform, outside fully glazed					
	480 mm ○ ● ○	480 x 465	12,5	21	030348 00 00	
	480 mm ● ● ●	480 x 465	12,5	21	030348 00 30	
	Space saving siphon White	1 1/4"				
			0,4		005073 00 00	
	Infobox: For vanity units the space saving siphon is recommended / Suitable for vanity units X-Large and Ketho / Overview of furniture recommendation see page 656					







Starck 3 Design by Philippe Starck

Description		mm	kg	Qty.	Model-No.	Euro
						White - 00
	Handrinse basin with overflow, with tap platform, pre-punched tap hole on left and right side					
	500 mm ●●	500 x 260	8,0	35	075150 00 00	
	Siphon cover for # 075150	160 x 165	3,1	36	086518 00 00	
	Fixing for siphon cover		0,1		005504 00 00	
	Push-open waste *** chrome		0,35		005052 10 00	
Infobox: In combination with Siphon cover not any Pop-up drain						
	Handrinse basin with overflow, with tap platform					
	450 mm ●	450 x 320	9,4	28	075045 00 00	
	450 mm ●	450 x 320	9,4	28	075045 00 10	
	Siphon cover for # 030050, 075045 030160, 030155	165 x 240	5,8	30	086517 00 00	
	Fixing for siphon cover		0,1		005503 00 00	
	Handrinse basin with overflow, with tap platform, tap hole on right side, fixings included					
	400 mm ●	400 x 260	7,9	35	075140 00 00	
	Push-open waste *** chrome		0,35		005052 10 00	
Infobox: Mandatory in combination with a bottle trap						
	Handrinse basin corner model with overflow, with tap platform					
	430 mm ●	430 x 380	6,2	40	075244 00 00	
	Fixing hooks for urinal # 084533 and 084229, for washbasin # 045360 for handrinse basin # 079444 and # 075244		0,3		005000 00 00	

Starck 3 Design by Philippe Starck

	Description	mm	kg	Qty.	Model-No.	Euro
						White -- 00
	Utility basin without overflow, without tap platform 480 mm ☒	480 x 425	17,4	12	031348 00 00	
	Grid fixings included		1,1		005001 10 00	
	Utility basin without overflow, without tap platform 480 mm ☒	480 x 425	17,4	12	031348 00 00	
	Fixing for mounting utility basin Starck 3 # 031348 without grid chrome	Ø 10 x 140	0,2		006712 10 00	
	Vanity basin countertop basin, with overflow, with tap platform 560 mm ○ ● ○	560 x 460	14,0	18	030256 00 00	
	Vanity basin countertop basin, ground, with overflow, with tap platform, outside fully glazed 480 mm ○ ● ○	480 x 465	12,5	21	030348 00 22	
Infobox: Vanity basin, countertop version # 030348 for wall application, only						
	Semi-recessed washbasin with overflow, with tap platform, fixings for installation in wooden consoles included 550 mm ○ ● ○	550 x 460	14,5	14	031055 00 00	
Infobox: Overview of furniture recommendation see page 656						
	Vanity basin undercounter basin, with overflow, with tap platform, fixings for installation in wooden consoles included 490 mm ○ ● ○	490 x 365	8,2	21	030249 00 00	
	Fixing Set for stone countertops (with the exception of # 046651)		0,2		005028 00 00	
Infobox: Measurements of undercounter models represent interior measurements						

Starck 3 Design by Philippe Starck

Description	mm	kg	Qty.	Model-No.	Euro
					White - 00
 Vanity basin undercounter basin, with overflow, without tap platform, fixings for installation in wooden consoles included 490 mm ☒	490 x 365	7,7	21	030549 00 00	
Fixing Set for stone countertops (with the exception of # 046651)		0,2		005028 00 00	
Infobox: Measurements of undercounter models represent interior measurements					
 Vanity basin special ground for Duravit furniture, undercounter basin, with overflow, without tap platform 490 mm ☒	490 x 365	7,7	21	030549 00 22	
Push-open waste *** chrome		0,35		005052 10 00	
Infobox: Measurements of undercounter models represent interior measurements / *** Required in conjunction with wall mounted tap fitting, vanity unit and/or consoles / Undercounter basin only in combination with variable consoles, as well as vanity units for undercounter basins, see the furniture part. Delivery only in combination of console or vanity unit with attached washbasin / Not available in WonderGliss					
 Vanity basin undercounter basin, with overflow, without tap platform, fixings for installation in wooden consoles included 430 mm ☒	430 x 430	7,4	21	030543 00 00	
Fixing Set for stone countertops (with the exception of # 046651)		0,2		005028 00 00	
Infobox: Measurements of undercounter models represent interior measurements					
 Double washbasin with overflow, with tap platform 1300 mm ●	1300 x 485	38,5	6	033213 00 00	
1300 mm ●●●	1300 x 485	38,5	6	033213 00 30	
 Pedestal for # 030065, 030060, 030055 030410, 030480, 030470, 033213 150 x 210		14,0	36	086516 00 00	
 Siphon cover for # 030065, 030060, 030055 030410, 030480, 030470, 033213 170 x 285		8,1	40	086515 00 00	
Fixing for siphon cover		0,1		005503 00 00	
Infobox: For fixing the ceramics from the size 1200 mm 2 sets of washbasin fixations are required / When combined with pedestal or siphon cover, 2 of each are mandatory					









WonderGliss
Simply add a '1' to
the model-no.







Starck 3 Design by Philippe Starck

	Description	mm	kg	Qty.	Model-No.	Euro
						White - 00
	Double furniture washbasin					
	with overflow, with tap platform					
	1300 mm ●	1300 x 485	38,5	6	033213 00 00	
	1300 mm ● ● ●	1300 x 485	38,5	6	033213 00 30	
	Space saving siphon					
	White	1 1/4"	0,4		005073 00 00	
<div style="border: 1px solid black; padding: 5px;"> Infobox: For fixing the ceramics from the size 1200 mm 2 sets of washbasin fixations are required / For vanity units the space saving siphon is recommended / Suitable for vanity units X-Large and Ketho / Overview of furniture recommendation see page 656 </div>						
	Bidet wall mounted ●					
	with overflow with tap platform	360 x 540	20,8	16	223015 00 00	
	Fixing for wall mounted bidet and wall mounted toilet					
	caps white	Ø 12 x 180	0,2		006500 00 00	
	caps chrome	Ø 12 x 180	0,2		006500 10 00	
<div style="border: 1px solid black; padding: 5px;"> Infobox: If pre-wall carrier not used, the fixing # 006500 is recommended </div>						
	Bidet wall mounted ●					
	with overflow, with tap platform Durafix included	360 x 540	21,0	16	228015 00 00	
	Fixing for wall mounted bidet and wall mounted toilet					
	caps white	Ø 12 x 180	0,2		006500 00 00	
<div style="border: 1px solid black; padding: 5px;"> Infobox: Durafix for invisible fixation is included in delivery / If pre-wall carrier not used, the fixing # 006500 is recommended </div>						
	Bidet wall mounted Compact ●					
	with overflow with tap platform	360 x 475	17,7	16	223115 00 00	
	Fixing for wall mounted bidet and wall mounted toilet					
	caps white	Ø 12 x 180	0,2		006500 00 00	
	caps chrome	Ø 12 x 180	0,2		006500 10 00	
<div style="border: 1px solid black; padding: 5px;"> Infobox: If pre-wall carrier not used, the fixing # 006500 is recommended </div>						
	Bidet wall mounted Compact ●					
	with overflow, with tap platform Durafix included	360 x 475	18,5	16	228115 00 00	
	Fixing for wall mounted bidet and wall mounted toilet					
	caps white	Ø 12 x 180	0,2		006500 00 00	
<div style="border: 1px solid black; padding: 5px;"> Infobox: Durafix for invisible fixation is included in delivery / If pre-wall carrier not used, the fixing # 006500 is recommended </div>						





Starck 3 Design by Philippe Starck

	Description	mm	kg	Qty.	Model-No.	Euro
						White - 00
	Bidet floor standing ● with overflow, with tap platform fixings included	360 x 560	24,2	9	223010 00 00	
	Bidet floor standing ● with overflow, with tap platform fixings included	360 x 655	26,5	9	223410 00 00	
	Toilet wall mounted washdown model 6,0 l	360 x 540	26,5	16	220009 00 00	
	Fixing for wall mounted bidet and wall mounted toilet caps white	Ø 12 x 180	0,2		006500 00 00	
	caps chrome	Ø 12 x 180	0,2		006500 10 00	
	Noise reduction gasket for wall mounted toilet		0,3		005020 00 00	
	Toilet seat and cover hinges stainless steel without automatic closure		2,3		006381 00 00	
	with SoftClose automatic closure, removable		2,7		006389 00 00	
Infobox: If pre-wall carrier not used, the fixing # 006500 is recommended						
	Toilet wall mounted washdown model, Durafix included 4,5 l	360 x 540	27,0	16	222509 00 00	
	Fixing for wall mounted bidet and wall mounted toilet caps white	Ø 12 x 180	0,2		006500 00 00	
	Noise reduction gasket for wall mounted toilet		0,3		005020 00 00	
	Toilet seat and cover hinges stainless steel without automatic closure		2,3		006381 00 00	
	with SoftClose automatic closure, removable		2,7		006389 00 00	
Infobox: Durafix for invisible fixation is included in delivery / If pre-wall carrier not used, the fixing # 006500 is recommended						

Starck 3 Design by Philippe Starck

	Description	mm	kg	Qty.	Model-No.	Euro
						White - 00
	Toilet wall mounted washout model					
	♻️ 6,0 l	360 x 540	23,1	16	220109 00 00	
	Fixing for wall mounted bidet and wall mounted toilet					
	caps white	Ø 12 x 180	0,2		006500 00 00	
	caps chrome	Ø 12 x 180	0,2		006500 10 00	
	Noise reduction gasket for wall mounted toilet		0,3		005020 00 00	
	Toilet seat and cover hinges stainless steel					
	without automatic closure			2,3	006381 00 00	
	with SoftClose automatic closure, removable			2,7	006389 00 00	
	Infobox: If pre-wall carrier not used, the fixing # 006500 is recommended					
	Toilet wall mounted Compact washdown model					
	♻️ 6,0 l	360 x 485	21,5	16	220209 00 00	
	Fixing for wall mounted bidet and wall mounted toilet					
	caps white	Ø 12 x 180	0,2		006500 00 00	
	caps chrome	Ø 12 x 180	0,2		006500 10 00	
	Noise reduction gasket for wall mounted toilet		0,3		005020 00 00	
	Toilet seat and cover hinges stainless steel					
	without automatic closure			2,3	006381 00 00	
	with SoftClose automatic closure, removable			2,7	006389 00 00	
	Infobox: If pre-wall carrier not used, the fixing # 006500 is recommended					
	Toilet wall mounted Compact washdown model, Durafix included					
	♻️ 4,5 l	360 x 485	21,5	16	222709 00 00	
	Fixing for wall mounted bidet and wall mounted toilet					
	caps white	Ø 12 x 180	0,2		006500 00 00	
	caps chrome	Ø 12 x 180	0,2		006500 10 00	
	Noise reduction gasket for wall mounted toilet		0,3		005020 00 00	
	Toilet seat and cover hinges stainless steel					
	without automatic closure			2,3	006381 00 00	
	with SoftClose automatic closure, removable			2,7	006389 00 00	
	Infobox: Durafix for invisible fixation is included in delivery / If pre-wall carrier not used, the fixing # 006500 is recommended					







Starck 3 Design by Philippe Starck

Description		mm	kg	Qty.	Model-No.	Euro	
	Toilet wall mounted washdown model, suitable for barrier-free applications, projection 700 mm ♻️ 6,0 l	360 x 700	33,0	9	220309 00 00	White - 00	
	Fixing for wall mounted bidet and wall mounted toilet						
	caps white	Ø 12 x 180	0,2		006500 00 00		
	caps chrome	Ø 12 x 180	0,2		006500 10 00		
	Noise reduction gasket for wall mounted toilet			0,3	005020 00 00		
		Toilet seat and cover with lateral reinforcement and extended hinge shaft, hinges stainless steel without automatic closure			3,3	006241 00 00	
			Toilet seat and cover with lateral reinforcement and extended hinge shaft, hinges stainless steel without automatic closure			1,7	006261 00 00
	Infobox: Barrier-free according to DIN 18040-1 and DIN 18040-2 / If pre-wall carrier not used, the fixing # 006500 is recommended						
		Toilet wall mounted Fixation clearance 230 mm, washdown model ♻️ 6,0 l	360 x 540	26,5	16	220609 00 00	
Fixing for wall mounted bidet and wall mounted toilet							
caps white		Ø 12 x 180	0,2		006500 00 00		
caps chrome		Ø 12 x 180	0,2		006500 10 00		
Noise reduction gasket for wall mounted toilet				0,3	005020 00 00		
		Toilet seat and cover hinges stainless steel without automatic closure			2,3	006381 00 00	
		with SoftClose automatic closure, removable			2,7	006389 00 00	
Infobox: If pre-wall carrier not used, the fixing # 006500 is recommended							











WonderGliss
Simply add a '1' to
the model-no.

Starck 3 Design by Philippe Starck

Description		mm	kg	Qty.	Model-No.	Euro
						White - 00
	Toilet wall mounted comfort washdown model, seat height + 50 mm					
	♻️ 6,0 l	360 x 545	27,0	12	221509 00 00	
Fixing for wall mounted bidet and wall mounted toilet						
	caps white	Ø 12 x 180	0,2		006500 00 00	
	caps chrome	Ø 12 x 180	0,2		006500 10 00	
Noise reduction gasket for wall mounted toilet						
			0,3		005064 00 00	
	Toilet seat and cover with lateral reinforcement and extended hinge shaft, hinges stainless steel without automatic closure					
			3,3		006241 00 00	
	Toilet seat and cover with lateral reinforcement and extended hinge shaft, hinges stainless steel without automatic closure					
			1,7		006261 00 00	
	Toilet seat and cover hinges stainless steel without automatic closure with SoftClose automatic closure, removable					
			2,3		006381 00 00	
			2,7		006389 00 00	
Infobox: If pre-wall carrier not used, the fixing # 006500 is recommended						
	Toilet wall mounted washdown model, suitable for SensoWash Starck, Durafix included					
	♻️ 6,0 l	370 x 620	29,0	12	222609 00 00	
Fixing for wall mounted bidet and wall mounted toilet						
	caps white	Ø 12 x 180	0,2		006500 00 00	
Noise reduction gasket for wall mounted toilet						
			0,3		005020 00 00	
	Toilet seat ring elongated, open front, hinges plastic without automatic closure with automatic closure					
			1,4		006431 00 00	
			1,4		006439 00 00	
	Toilet seat and cover elongated, hinges stainless steel without automatic closure with automatic closure, removable					
			2,0		006332 00 00	
			2,0		006339 00 00	
Infobox: Durafix for invisible fixation is included in delivery / If pre-wall carrier not used, the fixing # 006500 is recommended / When using the Geberit Design Panel 115.322.11.1 please order elbow 147.236.00.1 / Further details see www.sensowash.com						



Starck 3 Design by Philippe Starck

Description		mm	kg	Qty.	Model-No.	Euro
						White -- 00
	Toilet floor standing for independent water supply, washdown model, fixings included, horizontal outlet					
	♻️ 6,0 l	360 x 560	27,6	9	012409 00 00	
	Toilet seat and cover hinges stainless steel					
	without automatic closure		2,3		006381 00 00	
	with SoftClose automatic closure, removable		2,7		006389 00 00	
	Toilet close-coupled washdown model, (without cistern), fixings included, vertical outlet					
	♻️ 6,0 l	360 x 655	31,2	9	012601 00 00	
	Cistern with Dual Flush mechanism, chrome,					
	♻️ 6,0 l					
	for side supply	390 x 185	13,0	27	092000 00 05	
	for bottom left supply	390 x 185	13,0	27	092010 00 05	
	Toilet seat and cover hinges stainless steel					
	without automatic closure		2,3		006381 00 00	
	with SoftClose automatic closure, removable		2,7		006389 00 00	
	Toilet close-coupled washdown model, (without cistern), fixings included, horizontal outlet					
	♻️ 6,0 l	360 x 655	29,0	9	012609 00 00	
	♻️ 4,5 l	360 x 655	29,0	9	012609 00 64	
	Cistern with Dual Flush mechanism, chrome,					
	for side supply					
	♻️ 6,0 l	390 x 185	13,0	27	092000 00 05	
	♻️ 4,5 l	390 x 185	13,0	27	092000 00 85	
	for bottom left supply					
	♻️ 6,0 l	390 x 185	13,0	27	092010 00 05	
	♻️ 4,5 l	390 x 185	13,0	27	092010 00 85	
	Toilet seat and cover hinges stainless steel					
	without automatic closure		2,3		006381 00 00	
	with SoftClose automatic closure, removable		2,7		006389 00 00	





WonderGliss
Simply add a '1' to
the model-no.





Starck 3 Design by Philippe Starck

Description	mm	kg	Qty.	Model-No.	Euro	
					White	- 00
 Toilet close-coupled washdown model, (without cistern), Outlet for Vario connector set, for horizontal and vertical outlet, length adjustable from 70 - 210 mm, and vario connecting bend, vertical outlet from 200 - 240 mm, fixings included						
	6,0 l	360 x 655	31,3	9	012809 00 00	
	4,5 l	360 x 655	31,3	9	012809 00 64	
Vario connector set for horizontal and vertical outlet, length adjustable incl. excenter		Ø 110	1,5	001422 00 00		
	Vario connecting bend for vertical outlet					
		Ø 100	0,7	899025 00 06		
 Cistern with Dual Flush mechanism, chrome, for side supply						
	6,0 l	390 x 185	13,0	27	092000 00 05	
	4,5 l	390 x 185	13,0	27	092000 00 85	
	for bottom left supply					
	6,0 l	390 x 185	13,0	27	092010 00 05	
 Toilet seat and cover hinges stainless steel without automatic closure with SoftClose automatic closure, removable						
				2,3	006381 00 00	
				2,7	006389 00 00	

Starck 3 Design by Philippe Starck



	Description	mm	kg	Qty.	Model-No.	Euro
						White - 00
	Toilet close-coupled Big Toilet washdown model, (without cistern), Outlet for Vario connector set, for horizontal and vertical outlet, length adjustable from 70 - 220 mm, and vario connecting bend, vertical outlet from 210 - 250 mm, fixings included					
	♻️ 6,0 l	420 x 740	40,3		210409 00 00	
	Vario connector set for horizontal and vertical outlet, length adjustable incl. excenter	Ø 110	1,5		001422 00 00	
	Vario connecting bend for vertical outlet	Ø 100	0,7		899025 00 06	
	Cistern with Dual Flush mechanism, chrome, ♻️ 6,0 l					
	for side supply	475 x 210	19,0	36	092800 00 05	
	for bottom left supply	475 x 210	19,0	36	092810 00 05	
	Conversion set for back supply chrome			0,5	007504 10 00	
	Toilet seat and cover hinges stainless steel					
	without automatic closure			3,0	006771 00 00	
	with SoftClose automatic closure, removable			3,0	006779 00 00	

Starck 3 Design by Philippe Starck

Description	mm	kg	Qty.	Model-No.	Euro
					White - 00
 Toilet close-coupled washdown model, suitable for SensoWash Starck, (without cistern), Outlet for Vario connector set, for horizontal and vertical outlet, length adjustable from 70 - 200 mm, and vario connecting bend, vertical outlet from 190 - 230 mm, fixings included ♠ 4,5 l	370 x 705	34,3	9	214109 00 00	
Vario connector set for horizontal and vertical outlet, length adjustable incl. excenter	∅ 110	1,5		001422 00 00	
Vario connecting bend for vertical outlet	∅ 100	0,7		899025 00 06	
 Cistern with Dual Flush mechanism, chrome, for side supply ♠ 6,0 l	390 x 185	13,0	27	092000 00 05	
♠ 4,5 l	390 x 185	13,0	27	092000 00 85	
for bottom left supply ♠ 6,0 l	390 x 185	13,0	27	092010 00 05	
♠ 4,5 l	390 x 185	13,0	27	092010 00 85	
Conversion set for back supply chrome		0,5		007504 10 00	
 Cistern Singapore version, with Dual Flush mechanism, chrome, bottom left supply ♠ 4,0 l	390 x 185	13,0	40	092011 00 05	
 Toilet seat and cover elongated, hinges stainless steel without automatic closure		2,0		006332 00 00	
with automatic closure, removable		2,0		006339 00 00	

Infobox: When using the Geberit Design Panel 115.322.11.1 please order elbow 147.236.00.1 / Further details see www.sensowash.com

Starck 3 Design by Philippe Starck

Description		mm	kg	Qty.	Model-No.	Euro
						White - 00
	One-piece toilet US-version, suitable for SensoWash Starck, elongated with syphonic jet action, 305 mm/12" rough-in, with Single Flush mechanism, with side lever, 3"/80 mm flapper valve, vertical outlet ♠ 1,28 gpf (4,8 l)	370 x 715	52,1	6	212001 00 01	
	Mounting set for One-piece and Two-piece toilets 1/2"		0,48		001416 00 00	
	1/2", US-version		0,48		001417 00 00	
	Toilet seat ring elongated, open front, hinges plastic without automatic closure		1,4		006431 00 00	
with automatic closure		1,4		006439 00 00		
	Toilet seat and cover elongated, hinges stainless steel without automatic closure		2,0		006332 00 00	
	with automatic closure, removable		2,0		006339 00 00	
	Infobox: When using the Geberit Design Panel 115.322.11.1 please order elbow 147.236.00.1 / Further details see www.sensowash.com					
	One-piece toilet Japan-version, suitable for SensoWash Starck, elongated, 200 mm/8" rough-in, with Single Flush piston valve, top flush, JIS listed, vertical outlet ♠ 6,0 l	370 x 735	46,1	8	212401 00 01	
	Toilet seat ring elongated, open front, hinges plastic without automatic closure		1,4		006431 00 00	
	with automatic closure		1,4		006439 00 00	
	Toilet seat and cover elongated, hinges stainless steel without automatic closure		2,0		006332 00 00	
with automatic closure, removable		2,0		006339 00 00		
Infobox: When using the Geberit Design Panel 115.322.11.1 please order elbow 147.236.00.1 / Further details see www.sensowash.com						









WonderGliss
Simply add a '1' to
the model-no.



Starck 3 Design by Philippe Starck

		Description	mm	kg	Qty.	Model-No.	Euro
							White - 00
	Two-piece toilet	US-version, (without cistern), suitable for SensoWash Starck, elongated with syphonic jet action, 305 mm/12" rough-in, vertical outlet					
		♻️ 1,28 gpf (4,8 l)	370 x 705	38,9	12	212501 00 00	
	Mounting set	for One-piece and Two-piece toilets					
		1/2"		0,48		001416 00 00	
		1/2", US-version		0,48		001417 00 00	
	Cistern	with Single Flush mechanism, with side lever, 3"/80 mm flapper valve, bottom left supply					
		♻️ 1,28 gpf (4,8 l)		13,8	40	092040 00 04	
	Toilet seat ring	elongated, open front, hinges plastic					
		without automatic closure		1,4		006431 00 00	
		with automatic closure		1,4		006439 00 00	
	Toilet seat and cover	elongated, hinges stainless steel					
		without automatic closure		2,0		006332 00 00	
		with automatic closure, removable		2,0		006339 00 00	
Infobox: When using the Geberit Design Panel 115.322.11.1 please order elbow 147.236.00.1 / Further details see www.sensowash.com							
	Two-piece toilet	(without cistern), Japan-version, suitable for SensoWash Starck, elongated with syphonic jet action, 200 mm/8" rough-in, JIS listed, vertical outlet					
		♻️ 6,0 l	370 x 720	33,8	12	212701 00 00	
		Cistern	with Single Flush piston valve, top flush, bottom left supply				
			♻️ 6,0 l			30	093200 00 01
		Toilet seat ring	elongated, open front, hinges plastic				
		without automatic closure		1,4		006431 00 00	
		with automatic closure		1,4		006439 00 00	
	Toilet seat and cover	elongated, hinges stainless steel					
		without automatic closure		2,0		006332 00 00	
		with automatic closure, removable		2,0		006339 00 00	
Infobox: When using the Geberit Design Panel 115.322.11.1 please order elbow 147.236.00.1 / Further details see www.sensowash.com							



Starck 3 Design by Philippe Starck

Description	mm	kg	Qty.	Model-No.	Euro
					White - 00
	Urinal				
concealed inlet, syphonic action, vertical or horizontal outlet, fixings included					
model without fly	330 x 350	14,5	16	082135 00 00	
model with fly 	330 x 350	14,5	16	082135 00 07	
Water inlet mechanism					
for urinals with back supply	1/2"	0,1		695800 00 00	
Siphon					
vertical outlet	Ø 50	0,2		005111 00 00	
horizontal outlet (concealed)	Ø 50	0,2		005112 00 00	
Urinal screen					
Stainless steel		0,2		005042 10 00	
	Urinal				
visible inlet, syphonic action, vertical or horizontal outlet, fixings included					
model without fly	330 x 350	14,5	16	082235 00 00	
model with fly 	330 x 350	14,5	16	082235 00 07	
Siphon					
vertical outlet	Ø 50	0,2		005111 00 00	
horizontal outlet (concealed)	Ø 50	0,2		005112 00 00	
Urinal screen					
Stainless steel		0,2		005042 10 00	
	Urinal				
horizontal outlet (concealed), inlet spud 1" x 3/4", outlet flange 4 1/4"/108 mm, ceramic cover for waste included, fixings included					
concealed inlet	450 x 350	29,5	12	082444 00 00	
visible inlet	450 x 350	29,5	12	082544 00 00	
	Urinal				
visible inlet, rimless, includes jet nozzle, inlet set, ceramic covered slotted waste Ø 72 mm, bottle trap Ø 32 mm and fixings					
model without fly	245 x 300	18,3	16	082625 00 00	
model with fly 	245 x 300	18,3	16	082625 00 07	
Infobox: For flushometers with a distance of 50 mm from wall to center flush pipe / In combination with adjustable flushometers without ventilation					







Starck 3 Design by Philippe Starck

	Description	mm	kg	Qty.	Model-No.	Euro
	Urinal concealed inlet, rimless, for 1/2" connection, includes jet nozzle, inlet set, ceramic covered slotted waste Ø 72 mm, bottle trap Ø 32 mm and fixings	245 x 300	18,25	16	082725 00 00	White - 00
	model without fly	245 x 300	18,25	16	082725 00 00	
	model with fly 	245 x 300	18,25	16	082725 00 07	
<div style="border: 1px solid black; padding: 5px;"> <p>Infobox: In combination with adjustable in-wall flushometers / When using GEBERIT pre-wall carriers model range Duofix # 111.685 / Kombifix # 457.685 / GIS # 461.685 (available up to and including 2008), mandatory in combination with inlet traverse # 242.040.00.1 for 1/2" inlet connection / When using GEBERIT pre-wall carriers model range Duofix # 111.616 / Kombifix # 457.611 / GIS # 461.621 (available from Jan. 2009), mandatory in combination with inlet adapter # 242.042.00.1 for 1/2" inlet connection</p> </div>						
	Ceramic urinal partition fixings included	705 x 400	16,8	33	850000 00 00	





Urinals, various

Description	mm	kg	Qty.	Model-No.	Euro
					White - 00
					
Urinal Ben concealed inlet, syphonic action, vertical or horizontal outlet					
model without fly	370 x 350	16,5	15	084737 00 00	
model with fly	370 x 350	16,5	15	084737 00 07	
Siphon					
vertical outlet	Ø 50	0,2		005111 00 00	
horizontal outlet (concealed)	Ø 50	0,2		005112 00 00	
Fixing					
for urinal Ben, Jim, Bill caps chrome	Ø 10 x 140	0,2		005030 10 00	
Water inlet mechanism					
for urinals with back supply	1/2"	0,1		695800 00 00	
					
Urinal Ben visible inlet, syphonic action, vertical or horizontal outlet					
model without fly	370 x 350	16,5	15	084837 00 00	
model with fly	370 x 350	16,5	15	084837 00 07	
Siphon					
vertical outlet	Ø 50	0,2		005111 00 00	
horizontal outlet (concealed)	Ø 50	0,2		005112 00 00	
Fixing					
for urinal Ben, Jim, Bill caps chrome	Ø 10 x 140	0,2		005030 10 00	
					
Urinal Bill concealed inlet, syphonic action, vertical or horizontal outlet					
model without fly	345 x 350	12,0	20	085135 00 00	
model with fly	345 x 350	12,0	20	085135 00 07	
Siphon					
vertical outlet	Ø 50	0,2		005111 00 00	
horizontal outlet (concealed)	Ø 50	0,2		005112 00 00	
Fixing					
for urinal Ben, Jim, Bill caps chrome	Ø 10 x 140	0,2		005030 10 00	
Water inlet mechanism					
for urinals with back supply	1/2"	0,1		695800 00 00	



Urinals, various

Description	mm	kg	Qty.	Model-No.	Euro
					White - 00
					
Urinal Fizz concealed inlet, syphonic action, horizontal outlet, fixings included, model without cover					
model without fly	305 x 285	12,8	20	082336 00 00	
model with fly 	305 x 285	12,8	20	082336 00 07	
Siphon horizontal outlet (concealed)	Ø 50	0,2		005112 00 00	
Water inlet mechanism for urinals with back supply	1/2"	0,1		695800 00 00	
					
Urinal Fizz concealed inlet, syphonic action, horizontal outlet, fixings included, model for cover					
model without fly	305 x 285	12,8	20	082335 00 00	
model with fly 	305 x 285	12,8	20	082335 00 07	
Siphon horizontal outlet (concealed)	Ø 50	0,2		005112 00 00	
Water inlet mechanism for urinals with back supply	1/2"	0,1		695800 00 00	
					
Urinal Cover hinges stainless steel		0,8		006131 00 00	
					
Urinal Jim visible inlet, syphonic action, vertical or horizontal outlet					
model without fly	345 x 350	12,0	20	085035 00 00	
model with fly 	345 x 350	12,0	20	085035 00 07	
Siphon vertical outlet	Ø 50	0,2		005111 00 00	
horizontal outlet (concealed)	Ø 50	0,2		005112 00 00	
Fixing for urinal Ben, Jim, Bill					
caps chrome	Ø 10 x 140	0,2		005030 10 00	



Urinals, various

Description	mm	kg	Qty.	Model-No.	Euro
					White - 00
					
Urinal McDry waterless					
model without fly	365 x 335	20,4	12	084436 00 00	
model with fly 	365 x 335	20,4	12	084436 00 07	
Fixing for urinal Dellarco, Duraplus, Utronic, Dry, Katja, 1930					
caps chrome	Ø 8 x 110	0,1		006713 10 00	
Outlet connector for McDry urinal					
		0,12		005006 00 00	
Blue sealing liquid sealing liquid					
24 bottles 100 ml each		2,2		005060 00 00	
Blue sealing liquid sealing liquid, can 5L					
incl. measuring jug and draw-off tap		4,5		005061 00 00	
Blue cleaner Cleaner with spray top					
6 bottles 500 ml each		3,6		005062 00 00	
Info box: Not available in WonderGliss / 1 bottle (100 ml) sealing liquid included / The using of the outlet connector is required					
					
Urinal Utronic Electronic urinal for battery supply, concealed inlet, syphonic action, horizontal outlet, complete control unit included					
model without fly	345 x 315	19,5	12	083037 00 00	
model with fly 	345 x 315	19,5	12	083037 00 07	
Fixing for urinal Dellarco, Duraplus, Utronic, Dry, Katja, 1930					
caps chrome	Ø 8 x 110	0,1		006713 10 00	
Siphon horizontal outlet (concealed)	Ø 50	0,2		005112 00 00	
Urinal screen Stainless steel		0,2		005042 10 00	

Urinals, various

Description	mm	kg	Qty.	Model-No.	Euro
					White - 00
 Urinal Utronic Electronic urinal for power supply, concealed inlet, syphonic action, horizontal outlet, complete control unit included					
model without fly	345 x 315	19,5	12	083037 00 93	
model with fly	345 x 315	19,5	12	083037 00 97	
Pre-assembly set power supply unit 230V including electrical outlet			0,2	005004 00 00	
Fixing for urinal Dellarco, Duraplus, Utronic, Dry, Katja, 1930 caps chrome	Ø 8 x 110	0,1		006713 10 00	
Siphon horizontal outlet (concealed)	Ø 50	0,2		005112 00 00	
Urinal screen Stainless steel		0,2		005042 10 00	
Infobox: The power supply isn't included in delivery					
 Mounting set for urinal Ben, Jim, Bill, consisting of fixings and siphon vertical outlet				001435 10 00	
 Mounting set for urinal Ben, Jim, Bill, consisting of fixings and siphon horizontal outlet				001436 10 00	



US toilets, various

Description	mm	kg	Qty.	Model-No.	Euro
					White - 00
 One-piece toilet US-version, elongated with syphonic jet action, 305 mm/12" rough-in, with Single Flush mechanism, with side lever, 3"/80 mm flapper valve, IAPMO listed, vertical outlet ♻️ 1,28 gpf (4,8 l)	385 x 740	39,0	8	015701 00 03	
Mounting set for One-piece and Two-piece toilets 1/2", US-version		0,48		001431 00 00	
 Toilet seat and cover Metro elongated, hinges plastic without automatic closure with automatic closure		1,7 2,1		006870 00 00 006679 00 00	





WonderGliss
Simply add a '1' to
the model-no.

Vanity basins, various

Description	mm	kg	Qty.	Model-No.	Euro		
					White - 00	Pergamon - 47	
 <p>Vanity basin Manua countertop basin, with overflow, with tap platform 480 mm ●</p>	Ø 480	10,0	28	522048 .. 00			
 <p>Vanity basin Santosa undercounter basin, with overflow, without tap platform, fixings for installation in wooden consoles included 510 mm ☒</p>	510 x 375	8,0	28	046651 .. 00			
<p>Fixing Set for stone countertops</p>			0,02	005037 10 00			
 <p>Vanity basin Santosa special ground for Duravit furniture, undercounter basin, with overflow, without tap platform 510 mm ☒</p>	510 x 375	8,0	28	046651 00 22			
<p>Push-open waste *** chrome</p>			0,35	005052 10 00			
<p>Infobox: Measurements of undercounter models represent interior measurements / *** Required in conjunction with wall mounted tap fitting, vanity unit and/or consoles / Undercounter basin only in combination with variable consoles, as well as vanity units for undercounter basins, see the furniture part. Delivery only in combination of console or vanity unit with attached washbasin / Not available in WonderGliss</p>							

Vero Design by Duravit

Description	mm	kg	Qty.	Model-No.	Euro			
					White	- 00	Black	- 08
	Washbasin with overflow, with tap platform, 1200 mm							
●	1200 x 470	33,5	8	045412 .. 00				
● ● ●	1200 x 470	33,5	8	045412 .. 30				
⊗	1200 x 470	33,5	8	045412 .. 60				
	1000 mm							
●	1000 x 470	28,2	8	045410 .. 00				
● ● ●	1000 x 470	28,2	8	045410 .. 30				
⊗	1000 x 470	28,2	8	045410 .. 60				
	800 mm							
●	800 x 470	21,8	8	045480 .. 00				
● ● ●	800 x 470	21,8	8	045480 .. 30				
⊗	800 x 470	21,8	8	045480 .. 60				
	700 mm							
●	700 x 470	20,9	18	045470 .. 00				
● ● ●	700 x 470	20,9	18	045470 .. 30				
⊗	700 x 470	20,9	18	045470 .. 60				
	600 mm							
●	600 x 470	17,9	21	045460 .. 00				
● ● ●	600 x 470	17,9	21	045460 .. 30				
⊗	600 x 470	17,9	21	045460 .. 60				
	500 mm							
●	500 x 470	15,2	24	045450 .. 00				
● ● ●	500 x 470	15,2	24	045450 .. 30				
⊗	500 x 470	15,2	24	045450 .. 60				
	Design Siphon *							
	chrome		1,5	005036 10 00				
	Design angle valve							
	with rosette, chrome	1/2"	0,5	003045 10 00				
	Pop-up basin waste							
	chrome							
	with horizontal lever**		0,5	005031 10 00				
	Metal console height adjustable +50 mm, chrome							
	for washbasin # 045412		3,1	003074 10 00				
	for washbasin # 045410		3,0	003067 10 00				
	for washbasin # 045480		2,9	003066 10 00				
	for washbasin # 045470		2,8	003075 10 00				
	for washbasin # 045360 and 045460		2,8	003063 10 00				
	for washbasin # 045450		2,8	003065 10 00				
	Towel rail square tube 14 mm, chrome							
	for washbasin # 045412		0,8	003033 10 00				
	for washbasin # 045410		0,7	003039 10 00				
	for washbasin # 045480		0,65	003038 10 00				
	for washbasin # 045470		0,4	003047 10 00				
	for washbasin # 045460		0,37	003037 10 00				



Infobox: * When using this siphon please observe outlet height from upper surface of finished floor to centre of outlet in accordance with the technical specification sheet / For fixing the ceramics from the size 1000 mm 2 sets of washbasin fixations are required / ** Required in conjunction with wall mounted tap fitting and consoles with a maximum thickness of 30 mm

Vero Design by Duravit



Description	mm	kg	Qty.	Model-No.	Euro			
					White	- 00	Black	- 08
Washbasin ground with overflow, fixings included, with tap platform, 1200 mm								
●	1200 x 470	33,5	8	045412 .. 27				
● ● ●	1200 x 470	33,5	8	045412 .. 25				
⊗	1200 x 470	33,5	8	045412 .. 28				
1000 mm								
●	1000 x 470	28,2	8	045410 .. 27				
● ● ●	1000 x 470	28,2	8	045410 .. 25				
⊗	1000 x 470	28,2	8	045410 .. 28				
800 mm								
●	800 x 470	21,8	8	045480 .. 27				
● ● ●	800 x 470	21,8	8	045480 .. 25				
⊗	800 x 470	21,8	8	045480 .. 28				
700 mm								
●	700 x 470	20,9	18	045470 .. 27				
● ● ●	700 x 470	20,9	18	045470 .. 25				
⊗	700 x 470	20,9	18	045470 .. 28				
600 mm								
●	600 x 470	17,9	21	045460 .. 27				
● ● ●	600 x 470	17,9	21	045460 .. 25				
⊗	600 x 470	17,9	21	045460 .. 28				
500 mm								
●	500 x 470	12,5	24	045450 .. 27				
● ● ●	500 x 470	12,5	24	045450 .. 25				
⊗	500 x 470	12,5	24	045450 .. 28				
Design Siphon *								
chrome			1,5	005036 10 00				
Pop-up basin waste								
chrome								
with horizontal lever**			0,5	005031 10 00				
Design angle valve								
with rosette, chrome	1/2"		0,5	003045 10 00				

Infobox: * When using this siphon please observe outlet height from upper surface of finished floor to centre of outlet in accordance with the technical specification sheet / For fixing the ceramics from the size 1000 mm 2 sets of washbasin fixations are required / ** Required in conjunction with wall mounted tap fitting and consoles with a maximum thickness of 30 mm / Overview of furniture recommendation see page 656

Vero Design by Duravit





Description	mm	kg	Qty.	Model-No.	Euro			
					White	- 00	Black	- 08
 Washbasin with overflow, with tap platform 1200 mm ● ● 1200 x 470 33,5 8 045412 .. 24 1000 mm ● ● 1000 x 470 28,2 8 045410 .. 24								
Design Siphon * chrome		1,5		005036 10 00				
Design angle valve with rosette, chrome	1/2"	0,5		003045 10 00				
Push-open waste *** chrome		0,35		005052 10 00				
 Metal console height adjustable +50 mm, chrome for washbasin # 045412 3,1 003074 10 00 for washbasin # 045410 3,0 003067 10 00								
 Towel rail square tube 14 mm, chrome for washbasin # 045412 0,8 003033 10 00 for washbasin # 045410 0,7 003039 10 00								

Infobox: * When using this siphon please observe outlet height from upper surface of finished floor to centre of outlet in accordance with the technical specification sheet / *** Required in conjunction with wall mounted tap fitting, vanity unit and/or consoles / For fixing the ceramics from the size 1000 mm 2 sets of washbasin fixations are required / Recommended in connection with two single lever basin mixers / In conjunction with pop-up basin waste or push-open valve the flow capacity of max. 7,5l /min./tap should not be exceeded / When mounting 2 one-hole taps please consider space of # 045412 565 mm, # 045410 465 mm between





 Washbasin ground with overflow, with tap platform, fixings included 1200 mm ● ● 1200 x 470 33,5 8 045412 .. 26 1000 mm ● ● 1000 x 470 28,2 8 045410 .. 26								
Design Siphon * chrome		1,5		005036 10 00				
Design angle valve with rosette, chrome	1/2"	0,5		003045 10 00				
Push-open waste *** chrome		0,35		005052 10 00				

Infobox: * When using this siphon please observe outlet height from upper surface of finished floor to centre of outlet in accordance with the technical specification sheet / *** Required in conjunction with wall mounted tap fitting, vanity unit and/or consoles / For fixing the ceramics from the size 1000 mm 2 sets of washbasin fixations are required / Recommended in connection with two single lever basin mixers / In conjunction with pop-up basin waste or push-open valve the flow capacity of max. 7,5l /min./tap should not be exceeded / When mounting 2 one-hole taps please consider space of # 045412 565 mm, # 045410 465 mm between / Overview of furniture recommendation see page 656



Vero Design by Duravit

	Description	mm	kg	Qty.	Model-No.	Euro			
						White	- 00	Black	- 08
	Washbasin Med without overflow, with tap platform								
	600 mm ●	600 x 470	17,9	21	045460 00 41				
	600 mm ☒	600 x 470	17,9	21	045460 00 70				
	Slotted waste chrome	80	0,4		005038 10 00				
	Handrinse basin with overflow, with tap platform, 500 mm pre-punched tap hole on left and right side ● ●	500 x 250	9,9	40	070350 .. 00				
	tap hole on right side ●	500 x 250	9,9	40	070350 .. 08				
	tap hole on left side ●	500 x 250	9,9	40	070350 .. 09				
	Furniture handrinse basin with overflow, with tap platform, 500 mm pre-punched tap hole on left and right side ● ●	500 x 250	9,9	40	070350 .. 00				
	tap hole on right side ●	500 x 250	9,9	40	070350 .. 08				
	tap hole on left side ●	500 x 250	9,9	40	070350 .. 09				
	Space saving siphon White	1 1/4"	0,4		005073 00 00				
Infobox: Overview of furniture recommendation see page 656 / For vanity units the space saving siphon is recommended									
	Handrinse basin with overflow, with tap platform, without tap hole								
	450 mm ●	450 x 350	11,5	27	070445 .. 00				
	450 mm ☒	450 x 350	11,5	27	070445 .. 60				
	Furniture handrinse basin with overflow, with tap platform								
	450 mm ●	450 x 350	11,5	27	070445 .. 00				
	450 mm ☒	450 x 350	11,5	27	070445 .. 60				
	Space saving siphon White	1 1/4"	0,4		005073 00 00				
Infobox: Overview of furniture recommendation see page 656 / For vanity units the space saving siphon is recommended									
	Handrinse basin ground with overflow, with tap platform, fixings included								
	450 mm ●	450 x 350	11,5	27	070445 .. 27				
Infobox: Overview of furniture recommendation see page 656									



Vero Design by Duravit

	Description	mm	kg	Qty.	Model-No.	Euro			
						White	- 00	Black	- 08
	Handrinse basin Med without overflow, with tap platform 450 mm ●	450 x 350	11,5	27	070445 00 41				
	Slotted waste chrome	80	0,4		005038 10 00				
	<div style="border: 1px solid black; padding: 5px;"> Infobox: * When using this siphon please observe outlet height from upper surface of finished floor to centre of outlet in accordance with the technical specification sheet / Overview of furniture recommendation see page 656 </div>								
	Handrinse basin with overflow, with tap platform 250 mm ●	250 x 450	8,9	32	070225 00 00				
	<div style="border: 1px solid black; padding: 5px;"> Infobox: * When using this siphon please observe outlet height from upper surface of finished floor to centre of outlet in accordance with the technical specification sheet / Overview of furniture recommendation see page 656 </div>								
	Washbowl ground, without overflow, without tap platform, fixings included 600 mm ☒	600 x 380	14,2	28	045560 00 00				
	Design Siphon * chrome		1,5		005036 10 00				
	Design angle valve with rosette, chrome	1/2"	0,5		003045 10 00				
	Slotted waste chrome	50	0,3		005024 10 00				
	<div style="border: 1px solid black; padding: 5px;"> Infobox: * When using this siphon please observe outlet height from upper surface of finished floor to centre of outlet in accordance with the technical specification sheet / Overview of furniture recommendation see page 656 </div>								
	Washbowl ground, without overflow, without tap platform, fixings included 500 mm ☒	500 x 380	12,5	21	045550 . . 00				
	Design Siphon * chrome		1,5		005036 10 00				
	Design angle valve with rosette, chrome	1/2"	0,5		003045 10 00				
	Slotted waste chrome	50	0,3		005024 10 00				
	<div style="border: 1px solid black; padding: 5px;"> Infobox: * When using this siphon please observe outlet height from upper surface of finished floor to centre of outlet in accordance with the technical specification sheet / Overview of furniture recommendation see page 656 </div>								



Vero Design by Duravit

Description	mm	kg	Qty.	Model-No.	Euro					
					White	- 00	Black	- 08		
 <p>Above counter basin ground, with overflow, with tap platform, back plane glazed, fixings included</p>	595 mm ●	595 x 465	20,2	21	045260 .. 00					
	595 mm ● ● ●	595 x 465	20,2	21	045260 .. 30					
	595 mm ☒	595 x 465	20,2	21	045260 00 60					
	Design Siphon *									
	chrome			1,5		005036 10 00				
	Design angle valve									
	with rosette, chrome	1/2"		0,5		003045 10 00				
	Infobox: * When using this siphon please observe outlet height from upper surface of finished floor to centre of outlet in accordance with the technical specification sheet / Overview of furniture recommendation see page 656									
	 <p>Above counter basin ground, with overflow, with tap platform, back plane glazed, fixings included</p>	500 mm ●	500 x 470	16,2	24	045250 00 00				
500 mm ● ● ●		500 x 470	16,2	24	045250 00 30					
500 mm ☒		500 x 470	16,2	24	045250 00 60					
Design Siphon *										
chrome				1,5		005036 10 00				
Design angle valve										
with rosette, chrome		1/2"		0,5		003045 10 00				
Infobox: * When using this siphon please observe outlet height from upper surface of finished floor to centre of outlet in accordance with the technical specification sheet / Overview of furniture recommendation see page 656										
 <p>Washbasin with overflow, with back panel, for wall tap</p>		600 mm ● ● ●	600 x 470	20,9	9	045360 00 00				
	Fixing hooks									
	for urinal # 084533 and 084229, for washbasin # 045360									
	for handrinse basin # 079444 and # 075244									
	Design Siphon *									
	chrome			1,5		005036 10 00				
	Design angle valve									
	with rosette, chrome	1/2"		0,5		003045 10 00				
	Pop-up basin waste									
	chrome									
with horizontal lever**			0,5		005031 10 00					
Metal console										
height adjustable +50 mm, chrome										
for washbasin # 045360 and 045460										
Infobox: * When using this siphon please observe outlet height from upper surface of finished floor to centre of outlet in accordance with the technical specification sheet / taps: Hansgrohe Axor Citterio 39313xxx und Axor Citterio 39315xxx, Axor Montreux 16532xxx, installation set # 96142000, basic set # 10303180 / ** Required in conjunction with wall mounted tap fitting and consoles with a maximum thickness of 30 mm										



Vero Design by Duravit

Description	mm	kg	Qty.	Model-No.	Euro			
					White	- 00	Black	- 08
 Washbasin ground with overflow, with back panel, for wall tap, fixings included 600 mm ●●●	600 x 470	20,9	9	045360 00 25				
	Fixing hooks for urinal # 084533 and 084229, for washbasin # 045360 for handrinse basin # 079444 and # 075244							
Design Siphon * chrome			1,5	005036 10 00				
Design angle valve with rosette, chrome		1/2"	0,5	003045 10 00				
Pop-up basin waste chrome with horizontal lever**			0,5	005031 10 00				
Infobox: * When using this siphon please observe outlet height from upper surface of finished floor to centre of outlet in accordance with the technical specification sheet / taps: Hansgrohe Axor Citterio 39313xxx und Axor Citterio 39315xxx, Axor Montreux 16532xxx, installation set # 96142000, basic set # 10303180 / ** Required in conjunction with wall mounted tap fitting and consoles with a maximum thickness of 30 mm / Overview of furniture recommendation see page 656								
 Vanity basin countertop basin, with overflow, with tap platform 550 mm ● 550 mm ●●● 550 mm ☒ 500 mm ● 500 mm ●●● 500 mm ☒	550 x 465	12,7	21	031555 00 00				
	550 x 465	12,7	21	031555 00 30				
	550 x 465	12,7	21	031555 00 60				
	500 x 465		21	031550 00 00				
	500 x 465		21	031550 00 30				
	500 x 465		21	031550 00 60				
	Infobox: Overview of furniture recommendation see page 656							
 Semi-recessed washbasin with overflow, with tap platform, fixings for installation in wooden consoles included 550 mm ● 550 mm ●●● 550 mm ☒	550 x 470	17,6	21	031455 00 00				
	550 x 470	17,6	21	031455 00 30				
	550 x 470	17,6	21	031455 00 60				
	Infobox: Overview of furniture recommendation see page 656							





Vero Design by Duravit

Description	mm	kg	Qty.	Model-No.	Euro			
					White	- 00	Black	- 08
 Vanity basin undercounter basin, with overflow, without tap platform, fixings for installation in wooden consoles included 430 mm \otimes	430 x 315	7,7	24	033043 00 00				
	Fixing Set							
	for stone countertops (with the exception of # 046651)							
	0,2				005028 00 00			
Design Siphon *								
chrome								
1,5				005036 10 00				
Design angle valve								
with rosette, chrome								
1/2"								
0,5				003045 10 00				
Infobox: * When using this siphon please observe outlet height from upper surface of finished floor to centre of outlet in accordance with the technical specification sheet / Measurements of undercounter models represent interior measurements								
 Vanity basin undercounter basin, with overflow, without tap platform, fixings for installation in wooden consoles included 485 mm \otimes	485 x 315	9,1	21	033048 00 00				
	Fixing Set							
	for stone countertops (with the exception of # 046651)							
	0,2				005028 00 00			
Design Siphon *								
chrome								
1,5				005036 10 00				
Design angle valve								
with rosette, chrome								
1/2"								
0,5				003045 10 00				
Infobox: Measurements of undercounter models represent interior measurements / * When using this siphon please observe outlet height from upper surface of finished floor to centre of outlet in accordance with the technical specification sheet								
 Vanity basin special ground for Duravit furniture, undercounter basin, with overflow, without tap platform 485 mm \otimes	485 x 315	7,4	21	033048 00 22				
	Design Siphon *							
	chrome							
	1,5				005036 10 00			
Design angle valve								
with rosette, chrome								
1/2"								
0,5				003045 10 00				
Push-open waste ***								
chrome								
0,35				005052 10 00				
Infobox: Measurements of undercounter models represent interior measurements / * When using this siphon please observe outlet height from upper surface of finished floor to centre of outlet in accordance with the technical specification sheet / *** Required in conjunction with wall mounted tap fitting, vanity unit and/or consoles / Undercounter basin only in combination with variable consoles, as well as vanity units for undercounter basins, see the furniture part. Delivery only in combination of console or vanity unit with attached washbasin / Not available in WonderGliss								





Vero Design by Duravit

Description	mm	kg	Qty.	Model-No.	Euro			
					White	- 00	Black	- 08
	Furniture washbasin							
with overflow, with tap platform, 1250 mm								
●	1250 x 490	36,3	8	032912 00 00				
● ● ●	1250 x 490	36,3	8	032912 00 30				
⊗	1250 x 490	36,3	8	032912 00 60				
1050 mm								
●	1050 x 490	32,2	8	032910 00 00				
● ● ●	1050 x 490	32,2	8	032910 00 30				
⊗	1050 x 490	32,2	8	032910 00 60				
850 mm								
●	850 x 490	25,4	8	032985 00 00				
● ● ●	850 x 490	25,4	8	032985 00 30				
⊗	850 x 490	25,4	8	032985 00 60				
Design Siphon *								
chrome		1,5		005036 10 00				
Design angle valve								
with rosette, chrome	1/2"	0,5		003045 10 00				
Space saving siphon								
White	1 1/4"	0,4		005073 00 00				
Metal console								
height adjustable +50 mm, chrome								
for furniture washbasin # 032912		3,4		003073 10 00				
for furniture washbasin # 032910		3,3		003072 10 00				
for furniture washbasin # 032985		3,2		003071 10 00				
Towel rail								
square tube 14 mm, chrome								
for furniture washbasin # 032912		0,66		003034 10 00				
for furniture washbasin # 032910		0,58		003035 10 00				
for furniture washbasin # 032985		0,46		003036 10 00				
Infobox: * When using this siphon please observe outlet height from upper surface of finished floor to centre of outlet in accordance with the technical specification sheet / For fixing the ceramics from the size 1000 mm 2 sets of washbasin fixations are required / For vanity units the space saving siphon is recommended / Overview of furniture recommendation see page 656								
	Bidet wall mounted ●							
with overflow with tap platform	370 x 540	21,5	20	223915 .. 00				
Fixing								
for wall mounted bidet and wall mounted toilet								
caps white	Ø 12 x 180	0,2		006500 00 00				
caps chrome	Ø 12 x 180	0,2		006500 10 00				
Siphon for bidet								
with extended outlet pipe chrome	1 1/4"	0,6		005027 00 00				
Infobox: If pre-wall carrier not used, the fixing # 006500 is recommended								





Vero Design by Duravit

Description	mm	kg	Qty.	Model-No.	Euro					
					White	- 00	Black	- 08		
 <p>Bidet floor standing with overflow, with tap platform, fixings included</p> <p>● 370 x 570 27,0 16 224010 .. 00</p> <p>●●● 370 x 570 27,0 16 224010 .. 30</p> <p>Siphon for bidet with extended outlet pipe chrome 1 1/4" 0,6 005027 00 00</p>										
	<hr/>									
	 <p>Toilet wall mounted washdown model 4,5 l 370 x 545 25,2 16 221709 .. 64</p> <p>Noise reduction gasket for wall mounted toilet 0,3 005064 00 00</p> <p>Fixing for wall mounted bidet and wall mounted toilet</p> <p>caps white Ø 12 x 180 0,2 006500 00 00</p> <p>caps chrome Ø 12 x 180 0,2 006500 10 00</p>									
		<hr/>								
		 <p>Toilet seat and cover removable, hinges stainless steel with SoftClose automatic closure 3,1 006769 .. 00</p>								
<div style="border: 1px solid black; padding: 2px;"> Infobox: If pre-wall carrier not used, the fixing # 006500 is recommended </div>										
<hr/>										
 <p>Toilet floor standing for independent water supply, washdown model, fixings included, horizontal outlet 6,0 l 370 x 570 29,5 16 211709 00 00</p>										
	 <p>Toilet seat and cover removable, hinges stainless steel with SoftClose automatic closure 3,1 006769 00 00</p>									
		<hr/>								

Vero Design by Duravit

Description	mm	kg	Qty.	Model-No.	Euro				
					White	- 00	Black	- 08	
 <p>Toilet close-coupled washdown model, (without cistern), Outlet for Vario connector set, for horizontal and vertical outlet, length adjustable from 70 - 185 mm, and vario connecting bend, vertical outlet from 175 - 215 mm, fixings included ♾️ 6,0 l</p>	370 x 630	31,8	9	211609 .. 00					
	Vario connector set								
	for horizontal and vertical outlet, length adjustable incl. excenter								
	∅ 110	1,5			001422 00 00				
Vario connecting bend									
for vertical outlet									
∅ 100	0,7			899025 00 06					
 <p>Cistern with Dual Flush mechanism, chrome, ♾️ 6,0 l</p>	for side supply								
	380 x 160	13,6	27	090900 .. 05					
	for bottom left supply								
	380 x 160	13,8	27	090910 .. 05					
Conversion set									
for back supply chrome									
		0,5		007504 10 00					
 <p>Toilet seat and cover removable, hinges stainless steel with SoftClose automatic closure</p>									
			3,1	006769 .. 00					
 <p>One-piece toilet US-version, elongated with syphonic jet action, 305 mm/12" rough-in, with Single Flush piston valve, top flush, IAPMO listed, vertical outlet ♾️ 1,28 gpf (4,8 l)</p>	370 x 715	52,8	8	210301 00 05					
	Mounting set								
	for One-piece and Two-piece toilets 1/2", US-version								
			0,48		001431 00 00				
 <p>Toilet seat and cover removable, elongated, hinges stainless steel with SoftClose automatic closure</p>									
			2,8	006939 00 00					
Infobox: Not available in WonderGliss									

Vero Design by Duravit

Description	mm	kg	Qty.	Model-No.	Euro			
					White	- 00	Black	- 08
								
Urinal concealed inlet, syphonic action, horizontal outlet, fixings included, model without cover								
model without fly	295 x 320	14,8	20	280032 .. 00				
model with fly 	295 x 320	14,8	20	280032 00 07				
Siphon horizontal outlet (concealed)	Ø 50	0,2		005112 00 00				
Water inlet mechanism for urinals with back supply	1/2"	0,1		695800 00 00				
								
Urinal concealed inlet, syphonic action, horizontal outlet, fixings included, model for cover								
model without fly	295 x 320	14,8	20	280132 00 00				
model with fly 	295 x 320	14,8	20	280132 00 07				
Siphon horizontal outlet (concealed)	Ø 50	0,2		005112 00 00				
Water inlet mechanism for urinals with back supply	1/2"	0,1		695800 00 00				
								
Urinal Cover hinges stainless steel		1,2		006151 00 00				

SensoWash®

SensoWash®

SensoWash®

SensoWash®

SensoWash® Product Information

Starck

SensoWash® Starck C, DuraStyle and Happy D.2, shower toilet seat with concealed connections, designed by Philippe Starck

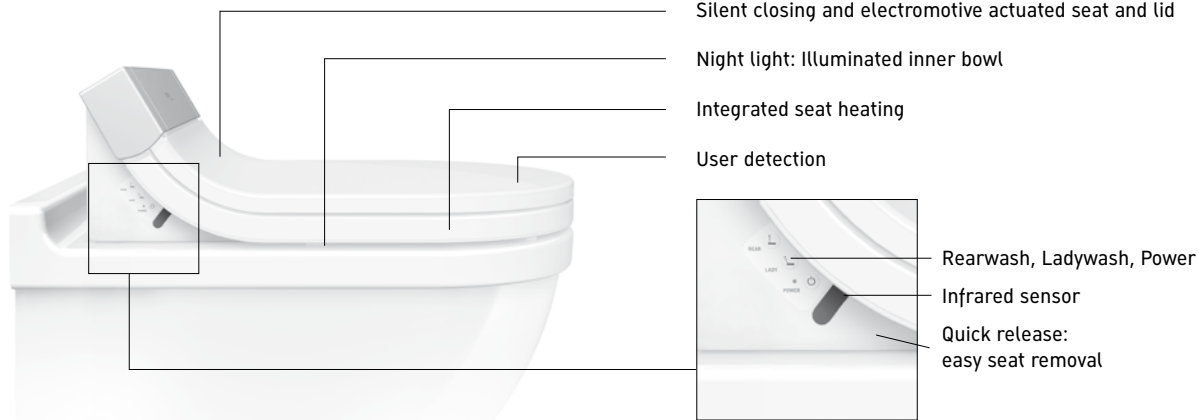

SensoWash® by Philippe Starck with concealed connections - the comfort model of Duravit. All the functions of SensoWash® Starck are operated by remote control. Starting with the motor-operated toilet lid and toilet seat that open and close on command. The heated toilet seat feels pleasant to the touch and its temperature can be individually controlled. A sensor makes sure that it doesn't get too hot. After using the toilet, simply select the desired function - Rearwash, Comfortwash or Ladywash - and enjoy the pleasant cleaning with warm water. This is followed by a gentle flow of warm, drying air.

Water temperature, water volume, nozzle position and drying temperature are all individually adjustable. For added convenience, personal preferences can be stored in two different user profiles. And even though the remote control is completely intuitive: for reassurance, the bracket contains quick reference to the operating instructions - a particularly useful feature when SensoWash® Starck is used in hotels.

SensoWash® C - Concealed technology

The development of a sophisticated technology for the toilet seat - water for cleaning, power for functionality - into the "interior" of the toilet ceramic. This makes installation simple and effortless. There are three stages, pre-installation, toilet installation and final assembly of the shower-toilet seat. **Further information: www.SensoWash.com**

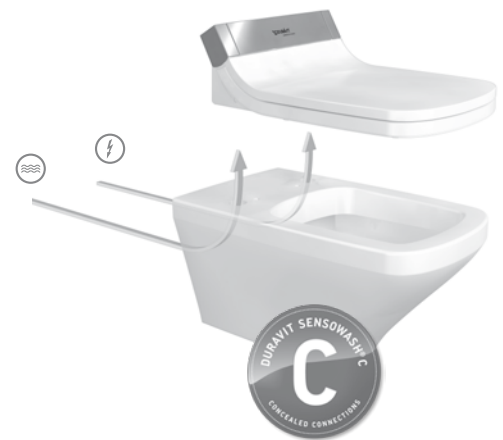

SensoWash® Starck shower toilet seat with visible connections, designed by Philippe Starck

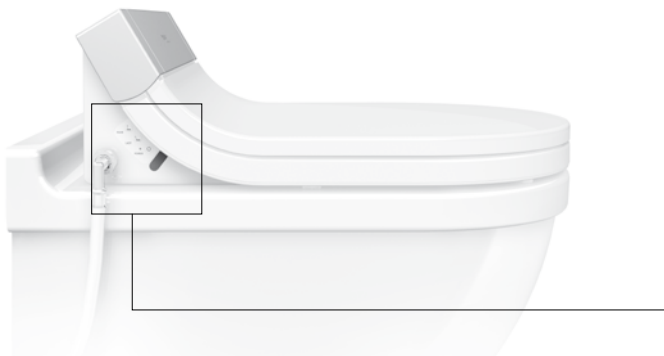

SensoWash® Starck shower toilet seat by Philippe Starck is also available with visible connections for water and power supply. Suitable for Starck 2, Starck 3 and Darling New series elongated toilet ceramics. **Further information: www.SensoWash.com**

SensoWash® Product Information

Remote control

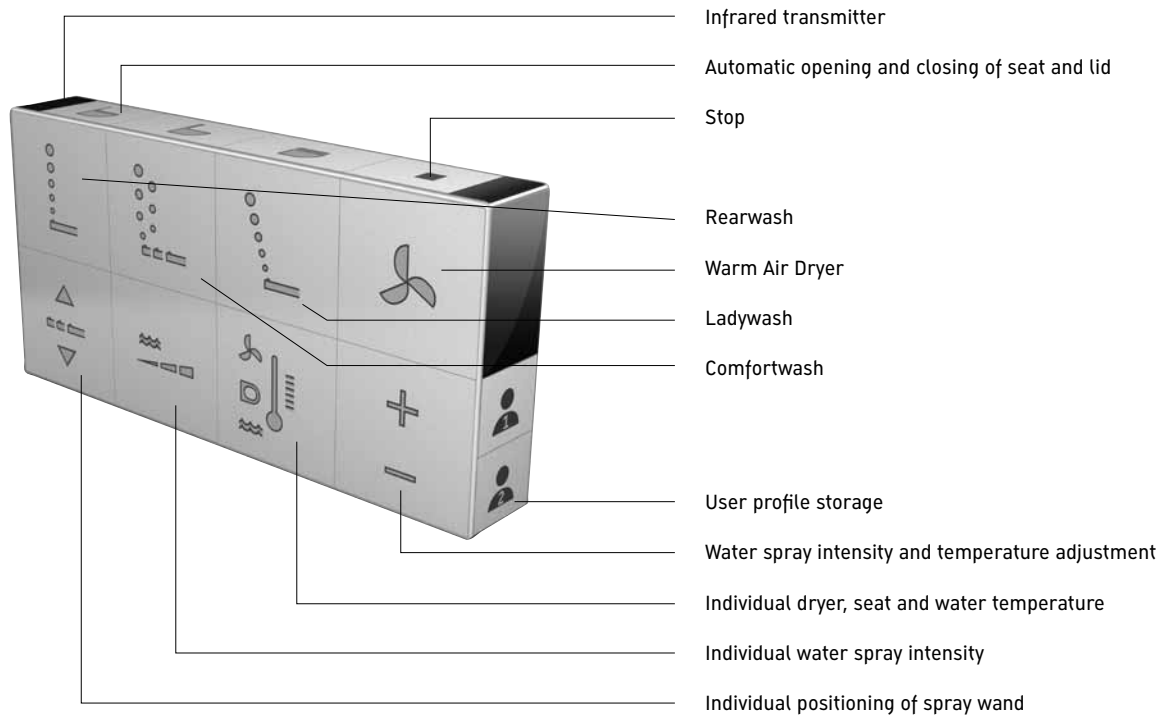

SensoWash® Product Information

Starck



Rearwash:

after using the toilet, the rear wash is both pleasant and safe. Water temperature, water volume and nozzle position can all be individually adjusted and, once saved, are easy to select. The spray wand has a ultrahygienic stainless steel surface and a replaceable nozzle. The spray wand and nozzles are cleaned automatically before and after each use.

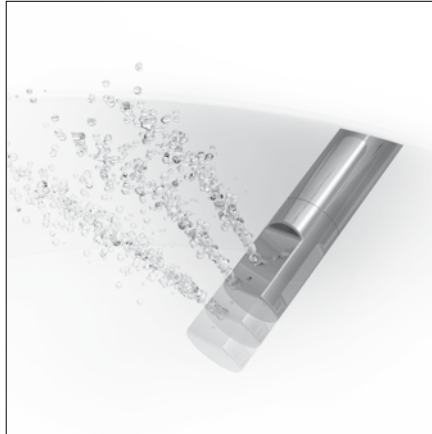

Comfortwash:

the Comfortwash function offers a wider wash as the spray wand moves forwards and backwards. Alternatively, the Comfortwash also offers a pulsating water jet.



Ladywash:

specially developed to meet the needs of female users, the Ladywash function uses a water jet at a comfortable anatomical angle for gentle cleaning. As with the Rear- and Comfortwash, individual settings can be selected and the spray wand and nozzles are cleaned automatically before and after use.



Warm Air Dryer:

use of the various wash functions is followed by a gentle flow of warm, drying air. The temperature of the dryer air can be adjusted by remote control. With this function, too, it is possible to save personal preferences and select them again at a later date.

SensoWash® Product Information

D-Code

Toilet seat and cover

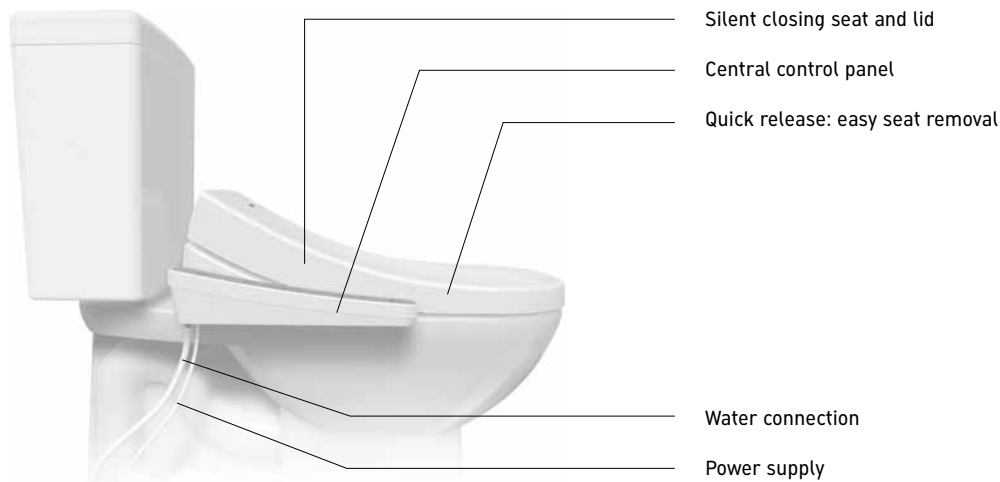

Control panel

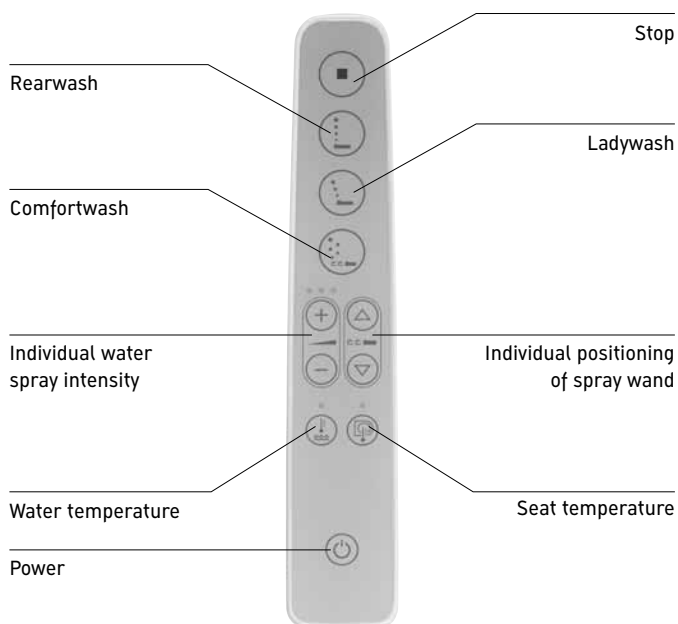

SensoWash® D-Code perfectly matches the ceramic series designed by Sieger Design at a reasonable price. Control unit mounted lateral to the seat and therefore also is suitable for using in public and semi-public areas.

Further information: www.SensoWash.com

SensoWash® Product Information

D-Code



Rearwash:

the Rearwash is pleasant and safe. Water temperature, water volume and nozzle position are individually adjustable. The stainless steel spray wand and the water nozzles are cleaned automatically before and after each use.



Comfortwash:

with the forward and backward movements of the spray wand, the Comfortwash function offers particularly attentive cleaning. Here, too, the spray wand and nozzles are cleaned automatically before and after each use.



Ladywash:

this was specially developed for the female body. With a special water jet, the Ladywash promises particularly gentle cleaning at a comfortable anatomical angle. Like the other functions, this is also individually adjustable and the spray wand and nozzles are cleaned automatically before and after use.

SensoWash® Product Information



sensoWASH®
DESIGN BY S+ARCK

sensoWASH®
D-CODE

Seat		
Silent closing seat and lid	●	●
Electromotive actuated seat and lid	●	-
Adjustable seat temperature	●	●
User detection	●	●
Hygiene		
Automatic cleaning of spray wand and nozzle before and after use	●	●
Antimicrobial properties of seat and nozzle materials	●	●
Spray nozzle detachable for cleaning	●	-
Complete unit removable for cleaning	●	●
Cleanse		
Rearwash	●	●
Ladywash	●	●
Oscillating Comfortwash	●	●
Pulsating massage jet	●	-
Adjustable spray wand position	●	●
Adjustable water spray intensity	●	●
Adjustable water temperature	●	●
Comfort		
Adjustable Warm Air Dryer temperature	●	-
Programmable user profiles	●	-
Night light function	●	-
Remote control	●	-
Specifications		
Shower water supplied from tank heater	-	●
Shower water heated by instant heater	●	-
Energy saving mode	●	●
Nominal voltage	100 – 120 V ~ 220 – 240 V ~	100 – 120 V ~ 220 – 240 V ~
Frequency	50/60 Hz	50/60 Hz
Maximum rating	1650 W	765 W
Water line pressure	0,07 – 0,75 MPa	0,1 – 0,68 MPa
Protection class: protection against water splashing from any direction (s.p. 650-652)	IP X4	IP X4
Temperature range		
Operating temperature	10 – 40 °C	10 – 39 °C
Water temperature	36 – 40 °C	32 – 39 °C
Seat temperature	33 – 37 °C	31 – 37 °C
Temperature of Warm Air Dryer	40 – 55 °C	-

An Electrical Leakage Protection to the bathroom socket is required prior to the installation of the product.



SensoWash® for Darling New Design by Philippe Starck

Description	mm	kg	Qty.	Model-No.	Euro
					White - 00
 SensoWash Starck C shower toilet seat with concealed connections Remote control included, Electromotive actuated seat and lid, Rear-, Lady- and Comfort-wash, Individual adjustment of water-, air- and seat temperature as well as spray wand position and water spray intensity, Self-cleaning spray wand, 2 individually programmable user profiles, Night light, Quick release: easy seat unit removal, On / off-button AC 220 - 240V 50Hz 370 x 515 6,4 610001 00 2000300 AC 100 - 120V 50 - 60Hz 370 x 515 6,4 610001 00 1001300					
 Toilet wall mounted washdown model, only in combination with SensoWash Starck C, connecting elements for SensoWash with concealed connections included, Durafix included ♀ 4,5 l 370 x 620 27,4 12 254459 00 00					
Fixing for wall mounted bidet and wall mounted toilet caps white Ø 12 x 180 0,2 006500 00 00					
Noise reduction gasket for wall mounted toilet 0,3 005064 00 00					
Mounting set for in-wall carrier 005072 00 00					
Infobox: Mounting set # 005072 suitable for most common pre-wall carriers with horizontal support - mandatory during bare brickwork! Further details see http://pro.duravit.com / Durafix for invisible fixation is included in delivery / If pre-wall carrier not used, the fixing # 006500 is recommended / Further details see www.sensowash.com					





WonderGliss
Simply add a '1' to
the model-no.



SensoWash® for Darling New Design by Philippe Starck

Description	mm	kg	Qty.	Model-No.	Euro
					White - 00
 SensoWash Starck shower toilet seat Remote control included, Electromotive actuated seat and lid, Rear-, Lady- and Comfort-wash, Individual adjustment of water-, air- and seat temperature as well as spray wand position and water spray intensity, Self-cleaning spray wand, 2 individually programmable user profiles, Night light, Quick release: easy seat unit removal, On / off-button, AC 220 - 240V 50Hz					
Europe	370 x 515	5,7		610000 00 2100200	
Korea	370 x 515	5,7		610000 00 2100000	
Malaysia, Singapore	370 x 515	5,7		610000 00 2060000	
Hong Kong, Malta, Cyprus, Arabia	370 x 515	5,7		610000 00 2070000	
Indonesia, Thailand, Philippines, Lebanon, Jordan, Syria	370 x 515	5,7		610000 00 2041000	
AC 100 - 120V 50 - 60Hz					
Japan	370 x 515	5,7		610000 00 1051000	
Taiwan	370 x 515	5,7		610000 00 1061000	
USA, Canada	370 x 515	5,7		610000 00 1040100	
 Toilet wall mounted washdown model, suitable for SensoWash Starck, Durafix included ♠ 4,5 l					
	370 x 620	27,4	12	254409 00 00	
Fixing					
for wall mounted bidet and wall mounted toilet caps white	∅ 12 x 180	0,2		006500 00 00	
Noise reduction gasket					
for wall mounted toilet		0,3		005064 00 00	
Infobox: Durafix for invisible fixation is included in delivery / If pre-wall carrier not used, the fixing # 006500 is recommended / When using the Geberit Design Panel 115.322.11.1 please order elbow 147.236.00.1 / Further details see www.sensowash.com					



SensoWash® for Darling New Design by Philippe Starck

Description	mm	kg	Qty.	Model-No.	Euro	
					White	- 00
 <p>SensoWash Starck C shower toilet seat with concealed connections Remote control included, Electromotive actuated seat and lid, Rear-, Lady- and Comfort-wash, Individual adjustment of water-, air- and seat temperature as well as spray wand position and water spray intensity, Self-cleaning spray wand, 2 individually programmable user profiles, Night light, Quick release: easy seat unit removal, On / off-button</p>						
	AC 220 - 240V 50Hz	370 x 515	6,4		610001 00 2000300	
	AC 100 - 120V 50 - 60Hz	370 x 515	6,4		610001 00 1001300	
 <p>One-piece toilet US-version, only in combination with SensoWash Starck C, elongated with syphonic jet action, 305 mm/12" rough-in, with Single Flush piston valve, top flush, IAPMO listed, connecting elements for SensoWash with concealed connections included, vertical outlet</p>						
	◆ 1,28 gpf (4,8 l)	400 x 715	48,3	8	212351 00 05	
<p>Mounting set for One-piece and Two-piece toilets</p>						
	1/2"		0,48		001416 00 00	
	1/2", US-version		0,48		001417 00 00	
<div style="border: 1px solid black; padding: 5px;"> Infobox: Further details see www.sensowash.com </div>						

SensoWash® for Darling New Design by Philippe Starck

Description	mm	kg	Qty.	Model-No.	Euro		
					White	- 00	
 <p>SensoWash Starck shower toilet seat Remote control included, Electromotive actuated seat and lid, Rear-, Lady- and Comfort-wash, Individual adjustment of water-, air- and seat temperature as well as spray wand position and water spray intensity, Self-cleaning spray wand, 2 individually programmable user profiles, Night light, Quick release: easy seat unit removal, On / off-button, AC 220 - 240V 50Hz</p>	Europe	370 x 515	5,7		610000 00 2100200		
	Korea	370 x 515	5,7		610000 00 2100000		
	Malaysia, Singapore	370 x 515	5,7		610000 00 2060000		
	Hong Kong, Malta, Cyprus, Arabia	370 x 515	5,7		610000 00 2070000		
	Indonesia, Thailand, Philippines, Lebanon, Jordan, Syria	370 x 515	5,7		610000 00 2041000		
	AC 100 - 120V 50 - 60Hz						
	Japan	370 x 515	5,7		610000 00 1051000		
	Taiwan	370 x 515	5,7		610000 00 1061000		
	USA, Canada	370 x 515	5,7		610000 00 1040100		
	 <p>One-piece toilet US-version, back to wall, suitable for SensoWash Starck, elongated with syphonic jet action, 305 mm/12" rough-in, with Single Flush piston valve, top flush, IAPMO listed, vertical outlet 💧 1,28 gpf (4,8 l)</p>					212301 00 05	
		Mounting set					
		for One-piece and Two-piece toilets					
		1/2"			0,48		001416 00 00
	1/2", US-version			0,48		001417 00 00	
<div style="border: 1px solid black; padding: 5px;"> Infobox: When using the Geberit Design Panel 115.322.11.1 please order elbow 147.236.00.1 / Further details see www.sensowash.com </div>							



SensoWash® for Darling New Design by Philippe Starck

Description	mm	kg	Qty.	Model-No.	Euro	
					White	- 00
 <p>SensoWash Starck C shower toilet seat with concealed connections Remote control included, Electromotive actuated seat and lid, Rear-, Lady- and Comfort-wash, Individual adjustment of water-, air- and seat temperature as well as spray wand position and water spray intensity, Self-cleaning spray wand, 2 individually programmable user profiles, Night light, Quick release: easy seat unit removal, On / off-button</p>						
AC 220 - 240V 50Hz	370 x 515	6,4		610001 00 2000300		
AC 100 - 120V 50 - 60Hz	370 x 515	6,4		610001 00 1001300		
 <p>Two-piece toilet (without cistern), US-version, only in combination with SensoWash Starck C, elongated with syphonic jet action, 305 mm/12" rough-in, IAPMO listed, connecting elements for SensoWash with concealed connections included, vertical outlet</p>						
♻️ 1,28 gpf (4,8 l)	370 x 700	35,5	12	212651 00 00		
 <p>Cistern with Single Flush piston valve, top flush, bottom left supply</p>						
♻️ 1,28 gpf (4,8 l)	405 x 170	13,5	40	093120 00 05		
<p>Mounting set for One-piece and Two-piece toilets</p>						
1/2"		0,48		001416 00 00		
1/2", US-version		0,48		001417 00 00		
Infobox: Further details see www.sensowash.com						





WonderGliss
 Simply add a '1' to
 the model-no.





SensoWash® for Darling New Design by Philippe Starck

Description	mm	kg	Qty.	Model-No.	Euro
					White - 00
 SensoWash Starck shower toilet seat Remote control included, Electromotive actuated seat and lid, Rear-, Lady- and Comfort- wash, Individual adjustment of water-, air- and seat tempe- rature as well as spray wand position and water spray intensity, Self-cleaning spray wand, 2 individually programmable user profiles, Night light, Quick release: easy seat unit removal, On / off-button, AC 220 - 240V 50Hz					
Europe	370 x 515	5,7		610000 00 2100200	
Korea	370 x 515	5,7		610000 00 2100000	
Malaysia, Singapore	370 x 515	5,7		610000 00 2060000	
Hong Kong, Malta, Cyprus, Arabia	370 x 515	5,7		610000 00 2070000	
Indonesia, Thailand, Philip- pines, Lebanon, Jordan, Syria	370 x 515	5,7		610000 00 2041000	
AC 100 - 120V 50 - 60Hz					
Japan	370 x 515	5,7		610000 00 1051000	
Taiwan	370 x 515	5,7		610000 00 1061000	
USA, Canada	370 x 515	5,7		610000 00 1040100	
 Two-piece toilet (without cistern), US-version, suitable for SensoWash Starck, elongated with syphonic jet action, 305 mm/12" rough-in, IAPMO listed, vertical outlet ♠ 1,28 gpf (4,8 l)	370 x 700	35,5	12	212601 00 00	
Mounting set for One-piece and Two-piece toilets					
1/2"		0,48		001416 00 00	
1/2", US-version		0,48		001417 00 00	
 Cistern with Single Flush piston valve, top flush, bottom left supply ♠ 1,28 gpf (4,8 l)	405 x 170	13,5	40	093120 00 05	
Cistern Hong Kong - version, without mechanism for back, bottom left or right supply	405 x 170	14,6	40	093130 00 00	
Infobox: When using the Geberit Design Panel 115.322.11.1 please order elbow 147.236.00.1 / Further details see www.sensowash.com					



SensoWash® for D-Code Design by Duravit

Description	mm	kg	Qty.	Model-No.	Euro
					White - 00
 SensoWash D-Code shower toilet seat With automatic closure, Rear-, Lady- and Comfort- wash, Individual adjustment of wa- ter- and seat temperature as well as spray wand position and water spray intensity, Self-cleaning spray wand, Quick release: easy seat unit removal, On / off-button, AC 220 - 240V 50Hz					
Europe	360 x 530	7,6		610100 00 2100200	
Korea	360 x 530	7,6		610100 00 2100000	
Malaysia, Singapore	360 x 530	7,6		610100 00 2060000	
Hong Kong, Malta, Cyprus, Arabia	360 x 530	7,6		610100 00 2070000	
Indonesia, Thailand, Philip- pines, Lebanon, Jordan, Syria	360 x 530	7,6		610100 00 2041000	
AC 100 - 120V 50 - 60Hz					
Taiwan	360 x 530	7,6		610100 00 1061000	
USA, Canada	360 x 530	7,6		610100 00 1040100	
 Toilet wall mounted suitable for SensoWash D-Code, washdown model ♻️ 6,0 l					
	360 x 590	19,7	16	222309 00 002	
Fixing for wall mounted bidet and wall mounted toilet					
caps white	Ø 12 x 180	0,2		006500 00 00	
caps chrome	Ø 12 x 180	0,2		006500 10 00	
Infobox: If pre-wall carrier not used, the fixing # 006500 is recommended / When using the Geberit Design Panel 115.322.11.1 please order elbow 147.236.00.1 / Further details see www.sensowash.com					



SensoWash® for D-Code Design by Duravit

Description	mm	kg	Qty.	Model-No.	Euro	
					White	- 00
 <p>SensoWash D-Code shower toilet seat With automatic closure, Rear-, Lady- and Comfort- wash, Individual adjustment of wa- ter- and seat temperature as well as spray wand position and water spray intensity, Self-cleaning spray wand, Quick release: easy seat unit removal, On / off-button, AC 220 - 240V 50Hz</p>						
Europe	360 x 530	7,6		610100 00 2100200		
Korea	360 x 530	7,6		610100 00 2100000		
Malaysia, Singapore	360 x 530	7,6		610100 00 2060000		
Hong Kong, Malta, Cyprus, Arabia	360 x 530	7,6		610100 00 2070000		
Indonesia, Thailand, Philip- pines, Lebanon, Jordan, Syria	360 x 530	7,6		610100 00 2041000		
AC 100 - 120V 50 - 60Hz						
Taiwan	360 x 530	7,6		610100 00 1061000		
USA, Canada	360 x 530	7,6		610100 00 1040100		
 <p>Toilet close-coupled washdown model, suitable for SensoWash D-Code, (without cistern), Outlet for Vario connector set, for horizontal and verti- cal outlet, length adjustable from 70 - 180 mm, and vario connecting bend, vertical outlet from 170 - 210 mm, fixings included</p>						
♾ 6,0 l	360 x 695			214209 00 002		
<p>Vario connector set for horizontal and vertical outlet, length adjustable</p>						
incl. excenter	∅ 110	1,5		001422 00 00		
<p>Vario connecting bend for vertical outlet</p>	∅ 100	0,7		899025 00 06		
 <p>Cistern with Dual Flush mechanism, chrome,</p>						
♾ 6,0 l						
for side supply	385 x 170	12,5	48	092700 00 04		
bottom left supply	385 x 170	12,5	48	092710 00 04		
<p>Conversion set for back supply, chrome</p>		0,2		007508 10 00		
 <p>Cistern Singapore version, with Dual Flush mechanism, chrome, for bottom left supply</p>						
♾ 4,0 l	385 x 170		40	092731 00 05		
<p>InfoBox: When using the Geberit Design Panel 115.322.11.1 please order elbow 147.236.00.1 / Further details see www.sensowash.com</p>						



SensoWash® for D-Code Design by Duravit

Description	mm	kg	Qty.	Model-No.	Euro	
					White	- 00
 <p>SensoWash D-Code shower toilet seat With automatic closure, Rear-, Lady- and Comfort- wash, Individual adjustment of wa- ter- and seat temperature as well as spray wand position and water spray intensity, Self-cleaning spray wand, Quick release: easy seat unit removal, On / off-button, AC 220 - 240V 50Hz</p>						
Europe	360 x 530	7,6		610100 00 2100200		
Korea	360 x 530	7,6		610100 00 2100000		
Malaysia, Singapore	360 x 530	7,6		610100 00 2060000		
Hong Kong, Malta, Cyprus, Arabia	360 x 530	7,6		610100 00 2070000		
Indonesia, Thailand, Philip- pines, Lebanon, Jordan, Syria	360 x 530	7,6		610100 00 2041000		
AC 100 - 120V 50 - 60Hz						
Taiwan	360 x 530	7,6		610100 00 1061000		
USA, Canada	360 x 530	7,6		610100 00 1040100		
 <p>One-piece toilet US-version, suitable for SensoWash D-Code, elongated with syphonic jet action, 305 mm/12" rough-in, with Single Flush mecha- nism, with side lever, IAPMO listed, vertical outlet ♠ 1,28 gpf (4,8 l)</p>	395 x 735	39,5	8	011301 00 01		
<p>Mounting set for One-piece and Two-piece toilets</p>						
1/2"		0,48		001418 00 96		
1/2", US-version		0,48		001431 00 00		
<div style="border: 1px solid black; padding: 5px;"> <p>Infobox: When using the Geberit Design Panel 115.322.11.1 please order elbow 147.236.00.1 / Further details see www.sensowash.com</p> </div>						

SensoWash® for D-Code Design by Duravit

Description	mm	kg	Qty.	Model-No.	Euro	
					White	- 00
 <p>SensoWash D-Code shower toilet seat With automatic closure, Rear-, Lady- and Comfort- wash, Individual adjustment of wa- ter- and seat temperature as well as spray wand position and water spray intensity, Self-cleaning spray wand, Quick release: easy seat unit removal, On / off-button, AC 220 - 240V 50Hz</p>						
Europe	360 x 530	7,6		610100 00 2100200		
Korea	360 x 530	7,6		610100 00 2100000		
Malaysia, Singapore	360 x 530	7,6		610100 00 2060000		
Hong Kong, Malta, Cyprus, Arabia	360 x 530	7,6		610100 00 2070000		
Indonesia, Thailand, Philip- pines, Lebanon, Jordan, Syria	360 x 530	7,6		610100 00 2041000		
AC 100 - 120V 50 - 60Hz						
Taiwan	360 x 530	7,6		610100 00 1061000		
USA, Canada	360 x 530	7,6		610100 00 1040100		
 <p>Two-piece toilet (without cistern), US-version, suitable for SensoWash D-Code, elongated with syphonic jet action, 305 mm/12" rough-in, IAPMO listed, vertical outlet</p>						
◆ 1,28 gpf (4,8 l)	350 x 685	26,2	12	011701 00 62		
 <p>Cistern with Single Flush mecha- nism, with side lever, 3"/80 mm flapper valve, bottom left supply</p>						
◆ 1,28 gpf (4,8 l)	390 x 170	12,0	40	092720 00 02		
<p>Mounting set for One-piece and Two-piece toilets</p>						
1/2"		0,48		001418 00 96		
1/2", US-version		0,48		001431 00 00		
<div style="border: 1px solid black; padding: 5px;"> <p>Infobox: When using the Geberit Design Panel 115.322.11.1 please order elbow 147.236.00.1 / Further details see www.sensowash.com</p> </div>						



SensoWash® for DuraStyle Design by Philippe Starck

Description	mm	kg	Qty.	Model-No.	Euro
					White - 00
 SensoWash DuraStyle by Starck shower toilet seat With concealed connections, Remote control included, Electromotive actuated seat and lid, Rear-, Lady- and Comfort- wash, Individual adjustment of water-, air- and seat tempe- rature as well as spray wand position and water spray intensity, Self-cleaning spray wand, 2 individually programmable user profiles, Night light, Quick release: easy seat unit removal, On / off-button					
AC 220 - 240V 50Hz	376 x 519	6,4		610200 00 2000300	
AC 100 - 120V 50 - 60Hz	376 x 519	6,4		610200 00 1001300	
 Toilet wall mounted washdown model, only in combination with SensoWash DuraStyle, connecting elements for SensoWash with concealed connections included, Durafix included ♠ 4,5 l					
	370 x 620	31,0	12	253759 00 00	
Fixing for wall mounted bidet and wall mounted toilet caps white					
	∅ 12 x 180	0,2		006500 00 00	
Noise reduction gasket for wall mounted toilet					
		0,3		005064 00 00	
Mounting set for in-wall carrier					
				005072 00 00	
Infobox: Mounting set # 005072 suitable for most common pre-wall carriers with horizontal support - mandatory during bare brickwork! Further details see http://pro.duravit.com / If pre-wall carrier not used, the fixing # 006500 is recommended / Durafix for invisible fixation is included in delivery / Further details see www.sensowash.com					





WonderGliss
Simply add a '1' to
the model-no.



SensoWash® for DuraStyle Design by Philippe Starck

Description	mm	kg	Qty.	Model-No.	Euro	
					White	- 00
 <p>SensoWash DuraStyle by Starck shower toilet seat With concealed connections, Remote control included, Electromotive actuated seat and lid, Rear-, Lady- and Comfort- wash, Individual adjustment of water-, air- and seat tempe- rature as well as spray wand position and water spray intensity, Self-cleaning spray wand, 2 individually programmable user profiles, Night light, Quick release: easy seat unit removal, On / off-button</p>						
AC 220 - 240V 50Hz	376 x 519	6,4		610200 00 2000300		
AC 100 - 120V 50 - 60Hz	376 x 519	6,4		610200 00 1001300		
 <p>Toilet wall mounted rimless, washdown model, only in combination with SensoWash DuraStyle, connecting elements for SensoWash with concealed connections included, Durafix included</p>						
▲ 4,5 l	370 x 620	28,3	12	254259 00 00		
<p>Fixing for wall mounted bidet and wall mounted toilet</p>						
caps white	Ø 12 x 180	0,2		006500 00 00		
<p>Noise reduction gasket for wall mounted toilet</p>						
		0,3		005064 00 00		
<p>Mounting set for in-wall carrier</p>						
				005072 00 00		
<p>Infobox: Mounting set # 005072 suitable for most common pre-wall carriers with horizontal support - mandatory during bare brickwork! Further details see http://pro.duravit.com / If pre-wall carrier not used, the fixing # 006500 is recommended / Durafix for invisible fixation is included in delivery / Further details see www.sensowash.com</p>						



SensoWash® for DuraStyle Design by Philippe Starck

Description	mm	kg	Qty.	Model-No.	Euro		
					White	- 00	
 SensoWash DuraStyle by Starck shower toilet seat With concealed connections, Remote control included, Electromotive actuated seat and lid, Rear-, Lady- and Comfort- wash, Individual adjustment of water-, air- and seat tempe- rature as well as spray wand position and water spray intensity, Self-cleaning spray wand, 2 individually programmable user profiles, Night light, Quick release: easy seat unit removal, On / off-button							
	AC 220 - 240V 50Hz	376 x 519	6,4		610200 00 2000300		
	AC 100 - 120V 50 - 60Hz	376 x 519	6,4		610200 00 1001300		
 Toilet close-coupled washdown model, only in combination with SensoWash DuraStyle, (without cistern), Outlet for Vario connector set, for horizontal and verti- cal outlet, length adjustable from 70 - 190 mm, and vario connecting bend, vertical outlet from 180 - 220 mm, connecting elements for SensoWash with concealed connections included, fixings included							
	4,5 l	370 x 700	41,3	9	215659 00 00		
Vario connector set for horizontal and vertical outlet, length adjustable							
	incl. excenter	Ø 110	1,5		001422 00 00		
Vario connecting bend for vertical outlet							
		Ø 100	0,7		899025 00 06		
 Cistern with Dual Flush mechanism, chrome, for side supply							
	6,0 l	390 x 170	14,9	27	093500 00 05		
	4,5 l	390 x 170	14,9	27	093500 00 85		
	for bottom left supply						
	6,0 l	390 x 170	14,9	27	093510 00 05		
	4,5 l	390 x 170	14,9	27	093510 00 85		
Connecting set only in conjunction with SensoWash C and cistern # 093510/092010							
					100524 00 00		
Conversion set for back supply							
	chrome		0,5		007504 10 00		
Infobox: Further details see www.sensowash.com							



SensoWash® for DuraStyle Design by Philippe Starck

Description	mm	kg	Qty.	Model-No.	Euro	
					White	- 00
 <p>SensoWash DuraStyle by Starck shower toilet seat With concealed connections, Remote control included, Electromotive actuated seat and lid, Rear-, Lady- and Comfort-wash, Individual adjustment of water-, air- and seat temperature as well as spray wand position and water spray intensity, Self-cleaning spray wand, 2 individually programmable user profiles, Night light, Quick release: easy seat unit removal, On / off-button</p>						
AC 220 - 240V 50Hz	376 x 519	6,4		610200 00 2000300		
AC 100 - 120V 50 - 60Hz	376 x 519	6,4		610200 00 1001300		
 <p>One-piece toilet US-version, only in combination with SensoWash DuraStyle, elongated with syphonic jet action, 305 mm/12" rough-in, with dual flush piston valve, top flush, IAPMO listed, connecting elements for SensoWash with concealed connections included, vertical outlet</p>						
♠ 1,32/0,92 gpf (5/3,5 l)	370 x 720	55,0	8	215751 00 05		
<p>Mounting set for One-piece and Two-piece toilets</p>						
1/2"		0,48		001416 00 00		
1/2", US-version		0,48		001417 00 00		
<div style="border: 1px solid black; padding: 5px;"> Infobox: Further details see www.sensowash.com </div>						

SensoWash® for DuraStyle Design by Philippe Starck

Description	mm	kg	Qty.	Model-No.	Euro	
					White	- 00
 <p>SensoWash DuraStyle by Starck shower toilet seat With concealed connections, Remote control included, Electromotive actuated seat and lid, Rear-, Lady- and Comfort-wash, Individual adjustment of water-, air- and seat temperature as well as spray wand position and water spray intensity, Self-cleaning spray wand, 2 individually programmable user profiles, Night light, Quick release: easy seat unit removal, On / off-button</p>						
AC 220 - 240V 50Hz	376 x 519	6,4		610200 00 2000300		
AC 100 - 120V 50 - 60Hz	376 x 519	6,4		610200 00 1001300		
 <p>Two-piece toilet US-version, elongated with syphonic jet action, 305 mm/12" rough-in, with dual flush piston valve, top flush, IAPMO listed, only in combination with SensoWash DuraStyle, connecting elements for SensoWash with concealed connections included, vertical outlet</p>						
♠ 1,32/0,92 gpf (5/3,5 l)	385 x 700	41,7	12	216051 00 00		
 <p>Cistern with dual flush piston valve, top flush, for bottom left supply</p>						
♠ 1,32/0,92 gpf (5/3,5 l)		13,6	40	093520 00 05		
<p>Mounting set for One-piece and Two-piece toilets</p>						
1/2"		0,48		001418 00 96		
Infobox: Further details see www.sensowash.com						

SensoWash® for Happy D.2 Design by Philippe Starck

Description	mm	kg	Qty.	Model-No.	Euro	
					White	- 00
 <p>SensoWash Happy D.2 by Starck shower toilet seat With concealed connections, Remote control included, Electromotive actuated seat and lid, Rear-, Lady- and Comfort- wash, Individual adjustment of water-, air- and seat tempe- rature as well as spray wand position and water spray intensity, Self-cleaning spray wand, 2 individually programmable user profiles, Night light, Quick release: easy seat unit removal, On / off-button</p>						
AC 220 - 240V 50Hz	370 x 515	6,4		610300 00 2000300		
AC 100 - 120V 50 - 60Hz	370 x 515	6,4		610300 00 1001300		
 <p>Toilet wall mounted rimless, washdown model, only in combination with SensoWash Happy D.2, connecting elements for SensoWash with concealed connections included, Durafix included</p>						
♻️ 4,5 l	365 x 620			255059 00 00		
<p>Fixing for wall mounted bidet and wall mounted toilet</p>						
caps white	Ø 12 x 180	0,2		006500 00 00		
<p>Noise reduction gasket for wall mounted toilet</p>						
		0,3		005064 00 00		
<p>Mounting set for in-wall carrier</p>						
				005072 00 00		
<p>Infobox: Mounting set # 005072 suitable for most common pre-wall carriers with horizontal support - mandatory during bare brickwork! Further details see http://pro.duravit.com / If pre-wall carrier not used, the fixing # 006500 is recommended / Durafix for invisible fixation is included in delivery / Further details see www.sensowash.com</p>						



SensoWash® for Happy D.2 Design by Philippe Starck

Description	mm	kg	Qty.	Model-No.	Euro	
					White	- 00
 <p>SensoWash Happy D.2 by Starck shower toilet seat With concealed connections, Remote control included, Electromotive actuated seat and lid, Rear-, Lady- and Comfort-wash, Individual adjustment of water-, air- and seat temperature as well as spray wand position and water spray intensity, Self-cleaning spray wand, 2 individually programmable user profiles, Night light, Quick release: easy seat unit removal, On / off-button</p>	AC 220 - 240V 50Hz	370 x 515	6,4	610300 00 2000300		
	AC 100 - 120V 50 - 60Hz	370 x 515	6,4	610300 00 1001300		
	One-piece toilet					
	US-version, only in combination with SensoWash Happy D.2, elongated with syphonic jet action, 305 mm/12" rough-in, with dual flush piston valve, top flush, IAPMO listed, connecting elements for SensoWash with concealed connections included, vertical outlet 1,32/0,92 gpf (5/3,5 l)					
Mounting set						
for One-piece and Two-piece toilets						
1/2"						
1/2", US-version						
Infobox: Further details see www.sensowash.com						





WonderGliss
Simply add a '1' to
the model-no.



SensoWash® for Starck 2 Design by Philippe Starck

Description	mm	kg	Qty.	Model-No.	Euro
					White - 00
 SensoWash Starck C shower toilet seat with concealed connections Remote control included, Electromotive actuated seat and lid, Rear-, Lady- and Comfort-wash, Individual adjustment of water-, air- and seat temperature as well as spray wand position and water spray intensity, Self-cleaning spray wand, 2 individually programmable user profiles, Night light, Quick release: easy seat unit removal, On / off-button					
AC 220 - 240V 50Hz	370 x 515	6,4		610001 00 2000300	
AC 100 - 120V 50 - 60Hz	370 x 515	6,4		610001 00 1001300	
 Toilet wall mounted washdown model, only in combination with SensoWash Starck C, connecting elements for SensoWash with concealed connections included, Durafix included ♀ 4,5 l					
	375 x 620	29,0	12	253359 00 00	
Noise reduction gasket for wall mounted toilet			0,3	005064 00 00	
Fixing for wall mounted bidet and wall mounted toilet caps white	∅ 12 x 180	0,2		006500 00 00	
Mounting set for in-wall carrier				005072 00 00	
Infobox: Mounting set # 005072 suitable for most common pre-wall carriers with horizontal support - mandatory during bare brickwork! Further details see http://pro.duravit.com / Durafix for invisible fixation is included in delivery / If pre-wall carrier not used, the fixing # 006500 is recommended / Further details see www.sensowash.com					



SensoWash® for Starck 2 Design by Philippe Starck

Description	mm	kg	Qty.	Model-No.	Euro
					White - 00
 SensoWash Starck shower toilet seat Remote control included, Electromotive actuated seat and lid, Rear-, Lady- and Comfort- wash, Individual adjustment of water-, air- and seat tempe- rature as well as spray wand position and water spray intensity, Self-cleaning spray wand, 2 individually programmable user profiles, Night light, Quick release: easy seat unit removal, On / off-button, AC 220 - 240V 50Hz					
Europe	370 x 515	5,7		610000 00 2100200	
Korea	370 x 515	5,7		610000 00 2100000	
Malaysia, Singapore	370 x 515	5,7		610000 00 2060000	
Hong Kong, Malta, Cyprus, Arabia	370 x 515	5,7		610000 00 2070000	
Indonesia, Thailand, Philip- pines, Lebanon, Jordan, Syria	370 x 515	5,7		610000 00 2041000	
AC 100 - 120V 50 - 60Hz					
Japan	370 x 515	5,7		610000 00 1051000	
Taiwan	370 x 515	5,7		610000 00 1061000	
USA, Canada	370 x 515	5,7		610000 00 1040100	
 Toilet wall mounted washdown model, suitable for SensoWash Starck, Durafix included ♠ 4,5 l					
	375 x 620	29,0	12	253309 00 00	
Fixing for wall mounted bidet and wall mounted toilet caps white					
	∅ 12 x 180	0,2		006500 00 00	
Noise reduction gasket for wall mounted toilet					
		0,3		005064 00 00	
Infobox: Durafix for invisible fixation is included in delivery / If pre-wall carrier not used, the fixing # 006500 is recommen- ded / When using the Geberit Design Panel 115.322.11.1 please order elbow 147.236.00.1 / Further details see www.sensowash.com					

SensoWash® for Starck 2 Design by Philippe Starck

Description	mm	kg	Qty.	Model-No.	Euro	
					White	- 00
 SensoWash Starck C shower toilet seat with concealed connections Remote control included, Electromotive actuated seat and lid, Rear-, Lady- and Comfort-wash, Individual adjustment of water-, air- and seat temperature as well as spray wand position and water spray intensity, Self-cleaning spray wand, 2 individually programmable user profiles, Night light, Quick release: easy seat unit removal, On / off-button						
	AC 220 - 240V 50Hz	370 x 515	6,4		610001 00 2000300	
	AC 100 - 120V 50 - 60Hz	370 x 515	6,4		610001 00 1001300	
 Toilet close-coupled washdown model, only in combination with SensoWash Starck C, (without cistern), Outlet for Vario connector set, for horizontal and vertical outlet, length adjustable from 70 - 200 mm, and vario connecting bend, vertical outlet from 200 - 240 mm, connecting elements for SensoWash with concealed connections included, fixings included						
	4,5 l	370 x 725	39,0	9	212959 00 00	
Vario connector set for horizontal and vertical outlet, length adjustable incl. excenter						
		Ø 110	1,5		001422 00 00	
Vario connecting bend for vertical outlet						
	Ø 100	0,7		899025 00 06		
 Cistern Singapore version, with Dual Flush mechanism, chrome, concealed left supply						
	6,0 l	370 x 145	11,2	22	093300 00 05	
	4,5 l	370 x 145	11,2	22	093300 00 85	
Infobox: Further details see www.sensowash.com						



SensoWash® for Starck 2 Design by Philippe Starck

Description	mm	kg	Qty.	Model-No.	Euro			
					White	- 00		
 <p>SensoWash Starck shower toilet seat Remote control included, Electromotive actuated seat and lid, Rear-, Lady- and Comfort-wash, Individual adjustment of water-, air- and seat temperature as well as spray wand position and water spray intensity, Self-cleaning spray wand, 2 individually programmable user profiles, Night light, Quick release: easy seat unit removal, On / off-button, AC 220 - 240V 50Hz</p>	Europe	370 x 515	5,7		610000 00 2100200			
	Korea	370 x 515	5,7		610000 00 2100000			
	Malaysia, Singapore	370 x 515	5,7		610000 00 2060000			
	Hong Kong, Malta, Cyprus, Arabia	370 x 515	5,7		610000 00 2070000			
	Indonesia, Thailand, Philippines, Lebanon, Jordan, Syria	370 x 515	5,7		610000 00 2041000			
	AC 100 - 120V 50 - 60Hz							
	Japan	370 x 515	5,7		610000 00 1051000			
	Taiwan	370 x 515	5,7		610000 00 1061000			
	USA, Canada	370 x 515	5,7		610000 00 1040100			
	 <p>Toilet close-coupled washdown model, suitable for SensoWash Starck, (without cistern), Outlet for Vario connector set, for horizontal and vertical outlet, length adjustable from 70 - 200 mm, and vario connecting bend, vertical outlet from 200 - 240 mm, fixings included</p>	4,5 l	370 x 725	39,0	9	212909 00 00		
		Vario connector set						
		for horizontal and vertical outlet, length adjustable						
		incl. excenter	Ø 110		1,5		001422 00 00	
	Vario connecting bend							
for vertical outlet								
Ø 100		0,7			899025 00 06			
 <p>Cistern Singapore version, with Dual Flush mechanism, chrome, concealed left supply</p>	6,0 l	370 x 145	11,2	22	093300 00 05			
	4,5 l	370 x 145	11,2	22	093300 00 85			
	Infobox: When using the Geberit Design Panel 115.322.11.1 please order elbow 147.236.00.1 / Further details see www.sensowash.com							





WonderGliss
Simply add a '1' to
the model-no.

SensoWash® for Starck 2 Design by Philippe Starck

Description	mm	kg	Qty.	Model-No.	Euro
					White - 00
 SensoWash Starck C shower toilet seat with concealed connections Remote control included, Electromotive actuated seat and lid, Rear-, Lady- and Comfort-wash, Individual adjustment of water-, air- and seat temperature as well as spray wand position and water spray intensity, Self-cleaning spray wand, 2 individually programmable user profiles, Night light, Quick release: easy seat unit removal, On / off-button					
AC 220 - 240V 50Hz	370 x 515	6,4		610001 00 2000300	
AC 100 - 120V 50 - 60Hz	370 x 515	6,4		610001 00 1001300	
 One-piece toilet US-version, only in combination with SensoWash Starck C, elongated with syphonic jet action, 305 mm/12" rough-in, with Single Flush piston valve, top flush, IAPMO listed, connecting elements for SensoWash with concealed connections included, vertical outlet					
◆ 1,28 gpf (4,8 l)	375 x 715	57,0	8	213351 00 05	
Mounting set for One-piece and Two-piece toilets					
1/2"		0,48		001418 00 96	
1/2", US-version		0,48		001431 00 00	

Infobox: Further details see www.sensowash.com



SensoWash® for Starck 2 Design by Philippe Starck

Description	mm	kg	Qty.	Model-No.	Euro		
					White	- 00	
 <p>SensoWash Starck shower toilet seat Remote control included, Electromotive actuated seat and lid, Rear-, Lady- and Comfort-wash, Individual adjustment of water-, air- and seat temperature as well as spray wand position and water spray intensity, Self-cleaning spray wand, 2 individually programmable user profiles, Night light, Quick release: easy seat unit removal, On / off-button, AC 220 - 240V 50Hz</p>	Europe	370 x 515	5,7		610000 00 2100200		
	Korea	370 x 515	5,7		610000 00 2100000		
	Malaysia, Singapore	370 x 515	5,7		610000 00 2060000		
	Hong Kong, Malta, Cyprus, Arabia	370 x 515	5,7		610000 00 2070000		
	Indonesia, Thailand, Philippines, Lebanon, Jordan, Syria	370 x 515	5,7		610000 00 2041000		
	AC 100 - 120V 50 - 60Hz						
	Japan	370 x 515	5,7		610000 00 1051000		
	Taiwan	370 x 515	5,7		610000 00 1061000		
	USA, Canada	370 x 515	5,7		610000 00 1040100		
	 <p>One-piece toilet US-version, suitable for SensoWash Starck, elongated with syphonic jet action, 305 mm/12" rough-in, with Single Flush piston valve, top flush, IAPMO listed, vertical outlet</p>	1,28 gpf (4,8 l)	375 x 715	57,0	8	213301 00 05	
		Mounting set					
		for One-piece and Two-piece toilets					
					1/2"	0,48	001418 00 96
					1/2", US-version	0,48	001431 00 00
<div style="border: 1px solid black; padding: 5px;"> <p>Infobox: When using the Geberit Design Panel 115.322.11.1 please order elbow 147.236.00.1 / Further details see www.sensowash.com</p> </div>							





WonderGliss
Simply add a '1' to
the model-no.

SensoWash® for Starck 3 Design by Philippe Starck

Description	mm	kg	Qty.	Model-No.	Euro
					White - 00
 SensoWash Starck C shower toilet seat with concealed connections Remote control included, Electromotive actuated seat and lid, Rear-, Lady- and Comfort-wash, Individual adjustment of water-, air- and seat temperature as well as spray wand position and water spray intensity, Self-cleaning spray wand, 2 individually programmable user profiles, Night light, Quick release: easy seat unit removal, On / off-button AC 220 - 240V 50Hz 370 x 515 6,4 610001 00 2000300 AC 100 - 120V 50 - 60Hz 370 x 515 6,4 610001 00 1001300					
 Toilet wall mounted washdown model, only in combination with SensoWash Starck C, connecting elements for SensoWash with concealed connections included, Durafix included ♀ 6,0 l 370 x 620 29,0 12 222659 00 00					
Noise reduction gasket for wall mounted toilet 0,3 005020 00 00					
Fixing for wall mounted bidet and wall mounted toilet caps white Ø 12 x 180 0,2 006500 00 00					
Mounting set for in-wall carrier 005072 00 00					
Infobox: Mounting set # 005072 suitable for most common pre-wall carriers with horizontal support - mandatory during bare brickwork! Further details see http://pro.duravit.com / Durafix for invisible fixation is included in delivery / If pre-wall carrier not used, the fixing # 006500 is recommended / Further details see www.sensowash.com					



SensoWash® for Starck 3 Design by Philippe Starck

Description	mm	kg	Qty.	Model-No.	Euro
					White - 00
 SensoWash Starck shower toilet seat Remote control included, Electromotive actuated seat and lid, Rear-, Lady- and Comfort-wash, Individual adjustment of water-, air- and seat temperature as well as spray wand position and water spray intensity, Self-cleaning spray wand, 2 individually programmable user profiles, Night light, Quick release: easy seat unit removal, On / off-button, AC 220 - 240V 50Hz					
Europe	370 x 515	5,7		610000 00 2100200	
Korea	370 x 515	5,7		610000 00 2100000	
Malaysia, Singapore	370 x 515	5,7		610000 00 2060000	
Hong Kong, Malta, Cyprus, Arabia	370 x 515	5,7		610000 00 2070000	
Indonesia, Thailand, Philippines, Lebanon, Jordan, Syria	370 x 515	5,7		610000 00 2041000	
AC 100 - 120V 50 - 60Hz					
Japan	370 x 515	5,7		610000 00 1051000	
Taiwan	370 x 515	5,7		610000 00 1061000	
USA, Canada	370 x 515	5,7		610000 00 1040100	
 Toilet wall mounted washdown model, suitable for SensoWash Starck, Durafix included					
6,0 l	370 x 620	29,0	12	222609 00 00	
Fixing for wall mounted bidet and wall mounted toilet caps white	Ø 12 x 180	0,2		006500 00 00	
Noise reduction gasket for wall mounted toilet		0,3		005020 00 00	
Infobox: Durafix for invisible fixation is included in delivery / If pre-wall carrier not used, the fixing # 006500 is recommended / When using the Geberit Design Panel 115.322.11.1 please order elbow 147.236.00.1 / Further details see www.sensowash.com					







WonderGliss
Simply add a '1' to
the model-no.

SensoWash® for Starck 3 Design by Philippe Starck

Description	mm	kg	Qty.	Model-No.	Euro		
					White	- 00	
 SensoWash Starck C shower toilet seat with concealed connections Remote control included, Electromotive actuated seat and lid, Rear-, Lady- and Comfort-wash, Individual adjustment of water-, air- and seat temperature as well as spray wand position and water spray intensity, Self-cleaning spray wand, 2 individually programmable user profiles, Night light, Quick release: easy seat unit removal, On / off-button AC 220 - 240V 50Hz 370 x 515 6,4 610001 00 2000300 AC 100 - 120V 50 - 60Hz 370 x 515 6,4 610001 00 1001300							
 Toilet close-coupled washdown model, only in combination with SensoWash Starck C, (without cistern), Outlet for Vario connector set, for horizontal and vertical outlet, length adjustable from 70 - 200 mm, and vario connecting bend, vertical outlet from 190 - 230 mm, connecting elements for SensoWash with concealed connections included, fixings included ♠ 4,5 l 370 x 705 34,3 9 214159 00 00							
Vario connector set for horizontal and vertical outlet, length adjustable incl. excenter Ø 110 1,5 001422 00 00							
Vario connecting bend for vertical outlet Ø 100 0,7 899025 00 06							
 Cistern with Dual Flush mechanism, chrome, for side supply ♠ 6,0 l 390 x 185 13,0 27 092000 00 05 ♠ 4,5 l 390 x 185 13,0 27 092000 00 85 for bottom left supply ♠ 6,0 l 390 x 185 13,0 27 092010 00 05 ♠ 4,5 l 390 x 185 13,0 27 092010 00 85							
Connecting set only in conjunction with SensoWash C and cistern # 093510/092010 100524 00 00							
Conversion set for back supply chrome 0,5 007504 10 00							
Infobox: Further details see www.sensowash.com							

SensoWash® for Starck 3 Design by Philippe Starck



Description	mm	kg	Qty.	Model-No.	Euro	
					White	- 00
 <p>SensoWash Starck shower toilet seat Remote control included, Electro-motive actuated seat and lid, Rear-, Lady- and Comfortwash, Individual adjustment of water-, air- and seat temperature as well as spray wand position and water spray intensity, Self-cleaning spray wand, 2 individually programmable user profiles, Night light, Quick release: easy seat unit removal, On / off-button, AC 220 - 240V 50Hz</p>						
Europe	370 x 515	5,7		610000 00 2100200		
Korea	370 x 515	5,7		610000 00 2100000		
Malaysia, Singapore	370 x 515	5,7		610000 00 2060000		
Hong Kong, Malta, Cyprus, Arabia	370 x 515	5,7		610000 00 2070000		
Indonesia, Thailand, Philippines, Lebanon, Jordan, Syria	370 x 515	5,7		610000 00 2041000		
AC 100 - 120V 50 - 60Hz						
Japan	370 x 515	5,7		610000 00 1051000		
Taiwan	370 x 515	5,7		610000 00 1061000		
USA, Canada	370 x 515	5,7		610000 00 1040100		
 <p>Toilet close-coupled washdown model, suitable for SensoWash Starck, (without cistern), Outlet for Vario connector set, for horizontal and vertical outlet, length adjustable from 70 - 200 mm, and vario connecting bend, vertical outlet from 190 - 230 mm, fixings included</p>						
♻️ 4,5 l	370 x 705	34,3	9	214109 00 00		
<p>Vario connector set for horizontal and vertical outlet, length adjustable incl. excenter</p>	Ø 110	1,5		001422 00 00		
<p>Vario connecting bend for vertical outlet</p>	Ø 100	0,7		899025 00 06		
 <p>Cistern with Dual Flush mechanism, chrome, for side supply</p>						
♻️ 6,0 l	390 x 185	13,0	27	092000 00 05		
♻️ 4,5 l	390 x 185	13,0	27	092000 00 85		
for bottom left supply						
♻️ 6,0 l	390 x 185	13,0	27	092010 00 05		
♻️ 4,5 l	390 x 185	13,0	27	092010 00 85		
<p>Connecting set only in conjunction with SensoWash C and cistern # 093510/092010</p>				100524 00 00		
<p>Conversion set for back supply chrome</p>		0,5		007504 10 00		
 <p>Cistern Singapore version, with Dual Flush mechanism, chrome, bottom left supply</p>						
♻️ 4,0 l	390 x 185	13,0	40	092011 00 05		

Infobox: When using the Geberit Design Panel 115.322.11.1 please order elbow 147.236.00.1 / Further details see www.sensowash.com





WonderGliss
Simply add a '1' to
the model-no.

SensoWash® for Starck 3 Design by Philippe Starck

Description	mm	kg	Qty.	Model-No.	Euro	
					White	- 00
 <p>SensoWash Starck C shower toilet seat with concealed connections Remote control included, Electromotive actuated seat and lid, Rear-, Lady- and Comfort-wash, Individual adjustment of water-, air- and seat temperature as well as spray wand position and water spray intensity, Self-cleaning spray wand, 2 individually programmable user profiles, Night light, Quick release: easy seat unit removal, On / off-button</p>						
	AC 220 - 240V 50Hz	370 x 515	6,4		610001 00 2000300	
	AC 100 - 120V 50 - 60Hz	370 x 515	6,4		610001 00 1001300	
 <p>One-piece toilet US-version, only in combination with SensoWash Starck C, elongated with syphonic jet action, 305 mm/12" rough-in, with Single Flush mechanism, with side lever, 3"/80 mm flapper valve, connecting elements for SensoWash with concealed connections included, vertical outlet</p>						
	1,28 gpf (4,8 l)	370 x 715	52,1	6	212051 00 01	
<p>Mounting set for One-piece and Two-piece toilets</p>						
	1/2"		0,48		001416 00 00	
	1/2", US-version		0,48		001417 00 00	
<div style="border: 1px solid black; padding: 5px;"> Infobox: Further details see www.sensowash.com </div>						

SensoWash® for Starck 3 Design by Philippe Starck



Description	mm	kg	Qty.	Model-No.	Euro	
					White	- 00
 <p>SensoWash Starck shower toilet seat Remote control included, Electromotive actuated seat and lid, Rear-, Lady- and Comfort-wash, Individual adjustment of water-, air- and seat temperature as well as spray wand position and water spray intensity, Self-cleaning spray wand, 2 individually programmable user profiles, Night light, Quick release: easy seat unit removal, On / off-button, AC 220 - 240V 50Hz</p>						
Europe	370 x 515	5,7		610000 00 2100200		
Korea	370 x 515	5,7		610000 00 2100000		
Malaysia, Singapore	370 x 515	5,7		610000 00 2060000		
Hong Kong, Malta, Cyprus, Arabia	370 x 515	5,7		610000 00 2070000		
Indonesia, Thailand, Philippines, Lebanon, Jordan, Syria	370 x 515	5,7		610000 00 2041000		
AC 100 - 120V 50 - 60Hz						
Japan	370 x 515	5,7		610000 00 1051000		
Taiwan	370 x 515	5,7		610000 00 1061000		
USA, Canada	370 x 515	5,7		610000 00 1040100		
 <p>One-piece toilet US-version, suitable for SensoWash Starck, elongated with syphonic jet action, 305 mm/12" rough-in, with Single Flush mechanism, with side lever, 3"/80 mm flapper valve, vertical outlet</p>						
◆ 1,28 gpf (4,8 l)	370 x 715	52,1	6	212001 00 01		
Mounting set for One-piece and Two-piece toilets						
1/2"		0,48		001416 00 00		
1/2", US-version		0,48		001417 00 00		

Infobox: When using the Geberit Design Panel 115.322.11.1 please order elbow 147.236.00.1 / Further details see www.sensowash.com





WonderGliss
Simply add a '1' to the model-no.

SensoWash® for Starck 3 Design by Philippe Starck

Description	mm	kg	Qty.	Model-No.	Euro	
					White	- 00
 <p>SensoWash Starck C shower toilet seat with concealed connections Remote control included, Electromotive actuated seat and lid, Rear-, Lady- and Comfort-wash, Individual adjustment of water-, air- and seat temperature as well as spray wand position and water spray intensity, Self-cleaning spray wand, 2 individually programmable user profiles, Night light, Quick release: easy seat unit removal, On / off-button</p>						
	AC 220 - 240V 50Hz	370 x 515	6,4		610001 00 2000300	
	AC 100 - 120V 50 - 60Hz	370 x 515	6,4		610001 00 1001300	
 <p>One-piece toilet Japan-version, only in combination with SensoWash Starck C, elongated, 200 mm/8" rough-in, with Single Flush piston valve, top flush, JIS listed, connecting elements for SensoWash with concealed connections included, vertical outlet</p>						
	6,0 l	370 x 735	46,1	8	212451 00 01	
Infobox: Further details see www.sensowash.com						

SensoWash® for Starck 3 Design by Philippe Starck



Description	mm	kg	Qty.	Model-No.	Euro		
					White	- 00	
 <p>SensoWash Starck shower toilet seat Remote control included, Electromotive actuated seat and lid, Rear-, Lady- and Comfort-wash, Individual adjustment of water-, air- and seat temperature as well as spray wand position and water spray intensity, Self-cleaning spray wand, 2 individually programmable user profiles, Night light, Quick release: easy seat unit removal, On / off-button, AC 220 - 240V 50Hz</p>	Europe	370 x 515	5,7		610000 00 2100200		
	Korea	370 x 515	5,7		610000 00 2100000		
	Malaysia, Singapore	370 x 515	5,7		610000 00 2060000		
	Hong Kong, Malta, Cyprus, Arabia	370 x 515	5,7		610000 00 2070000		
	Indonesia, Thailand, Philippines, Lebanon, Jordan, Syria	370 x 515	5,7		610000 00 2041000		
	AC 100 - 120V 50 - 60Hz						
	Japan	370 x 515	5,7		610000 00 1051000		
	Taiwan	370 x 515	5,7		610000 00 1061000		
	USA, Canada	370 x 515	5,7		610000 00 1040100		
	 <p>One-piece toilet Japan-version, suitable for SensoWash Starck, elongated, 200 mm/8" rough-in, with Single Flush piston valve, top flush, JIS listed, vertical outlet</p>	6,0 l	370 x 735	46,1	8	212401 00 01	

Infobox: When using the Geberit Design Panel 115.322.11.1 please order elbow 147.236.00.1 / Further details see www.sensowash.com





WonderGliss
Simply add a '1' to the model-no.

SensoWash® for Starck 3 Design by Philippe Starck

Description	mm	kg	Qty.	Model-No.	Euro	
					White	- 00
 <p>SensoWash Starck C shower toilet seat with concealed connections Remote control included, Electromotive actuated seat and lid, Rear-, Lady- and Comfort-wash, Individual adjustment of water-, air- and seat temperature as well as spray wand position and water spray intensity, Self-cleaning spray wand, 2 individually programmable user profiles, Night light, Quick release: easy seat unit removal, On / off-button</p>						
AC 220 - 240V 50Hz	370 x 515	6,4		610001 00 2000300		
AC 100 - 120V 50 - 60Hz	370 x 515	6,4		610001 00 1001300		
 <p>Two-piece toilet (without cistern), US-version, only in combination with SensoWash Starck C, elongated, 305 mm/12" rough-in, IAPMO listed, connecting elements for SensoWash with concealed connections included, vertical outlet</p>						
◆ 1,28 gpf (4,8 l)	370 x 705	38,9	12	212551 00 00		
 <p>Cistern with Single Flush mechanism, with side lever, 3"/80 mm flapper valve, bottom left supply</p>						
◆ 1,28 gpf (4,8 l)		13,8	40	092040 00 04		
<p>Mounting set for One-piece and Two-piece toilets</p>						
1/2"		0,48		001416 00 00		
1/2", US-version		0,48		001417 00 00		
Infobox: Further details see www.sensowash.com						



SensoWash® for Starck 3 Design by Philippe Starck

Description	mm	kg	Qty.	Model-No.	Euro		
					White	- 00	
 <p>SensoWash Starck shower toilet seat Remote control included, Electromotive actuated seat and lid, Rear-, Lady- and Comfort-wash, Individual adjustment of water-, air- and seat temperature as well as spray wand position and water spray intensity, Self-cleaning spray wand, 2 individually programmable user profiles, Night light, Quick release: easy seat unit removal, On / off-button, AC 220 - 240V 50Hz</p>	Europe	370 x 515	5,7		610000 00 2100200		
	Korea	370 x 515	5,7		610000 00 2100000		
	Malaysia, Singapore	370 x 515	5,7		610000 00 2060000		
	Hong Kong, Malta, Cyprus, Arabia	370 x 515	5,7		610000 00 2070000		
	Indonesia, Thailand, Philippines, Lebanon, Jordan, Syria	370 x 515	5,7		610000 00 2041000		
	AC 100 - 120V 50 - 60Hz						
	Japan	370 x 515	5,7		610000 00 1051000		
	Taiwan	370 x 515	5,7		610000 00 1061000		
	USA, Canada	370 x 515	5,7		610000 00 1040100		
	 <p>Two-piece toilet (without cistern), US-version, suitable for SensoWash Starck, elongated with syphonic jet action, 305 mm/12" rough-in, vertical outlet ♠ 1,28 gpf (4,8 l)</p>	370 x 705	38,9	12		212501 00 00	
	 <p>Cistern with Single Flush mechanism, with side lever, 3"/80 mm flapper valve, bottom left supply ♠ 1,28 gpf (4,8 l)</p>			13,8	40		092040 00 04
	<p>Mounting set for One-piece and Two-piece toilets</p>						
		1/2"			0,48		001416 00 00
		1/2", US-version			0,48		001417 00 00
<div style="border: 1px solid black; padding: 5px;"> Infobox: When using the Geberit Design Panel 115.322.11.1 please order elbow 147.236.00.1 / Further details see www.sensowash.com </div>							





WonderGliss
Simply add a '1' to
the model-no.

SensoWash® for Starck 3 Design by Philippe Starck

Description	mm	kg	Qty.	Model-No.	Euro	
					White	- 00
 <p>SensoWash Starck C shower toilet seat with concealed connections Remote control included, Electromotive actuated seat and lid, Rear-, Lady- and Comfort-wash, Individual adjustment of water-, air- and seat temperature as well as spray wand position and water spray intensity, Self-cleaning spray wand, 2 individually programmable user profiles, Night light, Quick release: easy seat unit removal, On / off-button</p>						
AC 220 - 240V 50Hz	370 x 515	6,4		610001 00 2000300		
AC 100 - 120V 50 - 60Hz	370 x 515	6,4		610001 00 1001300		
 <p>Two-piece toilet (without cistern), Japan-version, only in combination with SensoWash Starck C, elongated with syphonic jet action, 200 mm/8" rough-in, JIS listed, connecting elements for SensoWash with concealed connections included, vertical outlet</p>						
6,0 l	370 x 720	33,8	12	212751 00 00		
 <p>Cistern with Single Flush piston valve, top flush, bottom left supply</p>						
6,0 l			30	093200 00 01		
Infobox: Further details see www.sensowash.com						

SensoWash® for Starck 3 Design by Philippe Starck

Description	mm	kg	Qty.	Model-No.	Euro	
					White	- 00
 <p>SensoWash Starck shower toilet seat Remote control included, Electromotive actuated seat and lid, Rear-, Lady- and Comfort-wash, Individual adjustment of water-, air- and seat temperature as well as spray wand position and water spray intensity, Self-cleaning spray wand, 2 individually programmable user profiles, Night light, Quick release: easy seat unit removal, On / off-button, AC 220 - 240V 50Hz</p>						
Europe	370 x 515	5,7		610000 00 2100200		
Korea	370 x 515	5,7		610000 00 2100000		
Malaysia, Singapore	370 x 515	5,7		610000 00 2060000		
Hong Kong, Malta, Cyprus, Arabia	370 x 515	5,7		610000 00 2070000		
Indonesia, Thailand, Philippines, Lebanon, Jordan, Syria	370 x 515	5,7		610000 00 2041000		
AC 100 - 120V 50 - 60Hz						
Japan	370 x 515	5,7		610000 00 1051000		
Taiwan	370 x 515	5,7		610000 00 1061000		
USA, Canada	370 x 515	5,7		610000 00 1040100		
 <p>Two-piece toilet (without cistern), Japan-version, suitable for SensoWash Starck, elongated with syphonic jet action, 200 mm/8" rough-in, JIS listed, vertical outlet</p>						
 <p>Cistern with Single Flush piston valve, top flush, bottom left supply</p>						
<p>♻️ 6,0 l</p>	370 x 720	33,8	12	212701 00 00		
<p>♻️ 6,0 l</p>			30	093200 00 01		

Infobox: When using the Geberit Design Panel 115.322.11.1 please order elbow 147.236.00.1 / Further details see www.sensowash.com

Important indications kitchen sinks

1. DuraCeram



A patented special mass that features greater impact resistance and robustness. DuraCeram is resistant to extremes of temperatures, does not take on odours or flavours and is also lightfast and hygienic. A perfect material for the high requirements in the kitchen.

2. WonderGliss

Kitchen ceramics with the special WonderGliss surface finish will remain clean and attractive looking for a long time to come. Thanks to the coating which is fired into the ceramics, water immediately contracts into drops and drips off, taking any other residuals substances (like e.g. lime) along. The result: less polluting deposits, less cleaning work - more fun in the kitchen! For more information please refer to www.duravit.com.



WonderGliss
Simply add a '1' to
the model-no.

3. Cleanser

A cleanser for the kitchen sinks can be ordered on www.bioboy.com. Please refrain from using Bioboy on WonderGliss surfaces as this may reduce the water repelling function.

4. Symbols

- ● 1 tap hole punched (left),
1 hole for pop-up knob punched (right)
- ● 1 tap hole punched (right),
1 hole for pop-up knob punched (left)
- ● 1 tap hole punched,
1 hole for pop-up knob punched
- ⊗ without tap hole

5. Dimensioning

All drawings contain all necessary dimensions (mm) and are subject to the general tolerances. Definite dimensions can only be taken off the final product.

6. Miscellaneous

For detailed information please refer to built-in recommendation for the flush mounting of the kitchen sinks on page 653 and/or mounting instruction see www.duravit.com. The mounting instruction is also included in delivery.

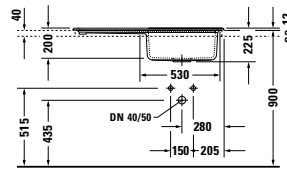
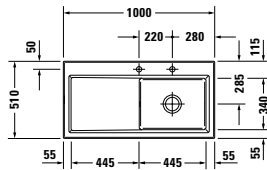
Kiora Design by Sieger Design

Outlet diameter Ø 90 mm

Tap hole / pop up diameter Ø 35 mm

Kitchen sink built-in version Kiora 60 XL R/L	mm	kg	Qty.	Model-No.	Euro	
countertop basin, with overflow, with tap platform, cable-driven waste chrome, included						
bowl on right side ● ●	1000 x 510	26,0	5	752010 .. 00	White -00 Matt Crema -27 Matt white silk -33 Pergamon -47 Anthracite matt -68	Black -08
bowl on left side ● ●	1000 x 510	26,0	5	752110 .. 00		
Accessories						
Cutting board, Epicurean black	405 x 405	3,5		005214 00 00		
Additional information						
Minimal vanity unit width: 600 mm						
countertop cutout dimension 980 x 490 mm						
The minimum thickness of the countertop is 40 mm						
cutting board is dishwasher safe and heat resistant up to 180° C						

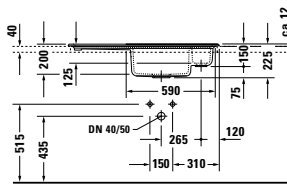
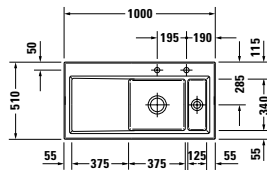

Outlet diameter Ø 90 mm

Outlet diameter Ø 58 mm

Tap hole / pop up diameter Ø 35 mm

Kitchen sink built-in version Kiora 60 R/L	mm	kg	Qty.	Model-No.	Euro	
countertop basin, with strainer bowl, with overflow, with tap platform, cable-driven waste chrome, included						
bowl on right side ● ●	1000 x 510	26,0	5	751810 .. 00	White -00 Matt Crema -27 Matt white silk -33 Pergamon -47 Anthracite matt -68	Black -08
bowl on left side ● ●	1000 x 510	26,0	5	751910 .. 00		
Accessories						
Cutting board, Epicurean black	405 x 405	3,5		005214 00 00		
Additional information						
Minimal vanity unit width: 600 mm						
countertop cutout dimension 980 x 490 mm						
The minimum thickness of the countertop is 40 mm						
cutting board is dishwasher safe and heat resistant up to 180° C						

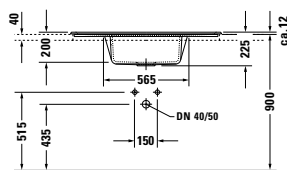
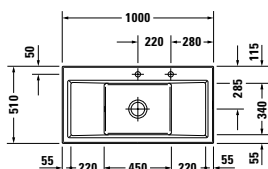

WonderGliss
Simply add a '1' to
the model-no.

Kiora Design by Sieger Design

Outlet diameter Ø 90 mm

Tap hole / pop up diameter Ø 35 mm

Kitchen sink built-in version Kiora 60 Z	mm	kg	Qty.	Model-No.	Euro	
countertop basin, with overflow, with tap platform, cable-driven waste chrome, included					White -00	Black -08
bowl central ● ●	1000 x 510	25,0	5	752210 .. 00	Matt Crema -27	
					Matt white silk -33	
					Pergamon -47	
					Anthracite matt -68	
Accessories						
Cutting board, Epicurean black	405 x 405	3,5		005214 00 00		
Additional information						
Minimal vanity unit width: 600 mm						
countertop cutout dimension 980 x 490 mm						
The minimum thickness of the countertop is 40 mm						
cutting board is dishwasher safe and heat resistant up to 180° C						

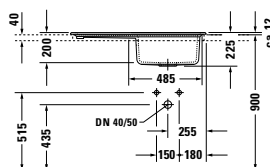
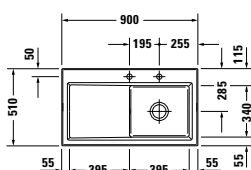

Outlet diameter Ø 90 mm

Tap hole / pop up diameter Ø 35 mm

Kitchen sink built-in version Kiora 50 R/L	mm	kg	Qty.	Model-No.	Euro	
countertop basin, with overflow, with tap platform, cable-driven waste chrome, included					White -00	Black -08
bowl on right side ● ●	900 x 510	22,5	5	751690 .. 00	Matt Crema -27	
bowl on left side ● ●	900 x 510	22,5	5	751790 .. 00	Matt white silk -33	
					Pergamon -47	
					Anthracite matt -68	
Accessories						
Cutting board, Epicurean black	405 x 405	3,5		005214 00 00		
Additional information						
Minimal vanity unit width: 500 mm						
countertop cutout dimension 880 x 490 mm						
The minimum thickness of the countertop is 40 mm						
cutting board is dishwasher safe and heat resistant up to 180° C						

Starck K Design by Philippe Starck

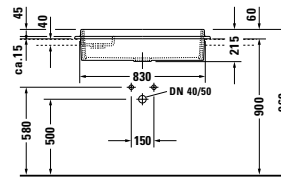
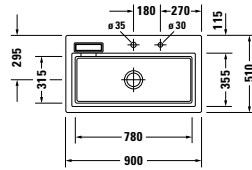

⊕ Outlet diameter Ø 90 mm

Kitchen sink built in version Starck K 90	mm	kg	Qty.	Model-No.	Euro	
countertop basin, with overflow, with tap platform, cable-driven waste chrome, included					White -00 Matt Crema -27 Matt white silk -33 Pergamon -47 Anthracite matt -68	Black -08
bowl without shelf ● ●	900 x 510	31,5	5	751290 . . 00		
Accessories						
Cutting board, fits on sink, beech oiled	470 x 350	2,48		005200 00 00		
Cutting board, fits on sink, beech oiled	380 x 350	2,06		005201 00 00		
Cutting board, fits on sink, beech oiled	280 x 350	1,7		005202 00 00		
Cutting board, fits on sink, beech oiled	190 x 350	1,06		005203 00 00		
Edge protector, for Gastronorm-container 1/1 (530 x 325 mm)				005204 00 00		
Edge protector, for Gastronorm-container 2/3 (354 x 325 mm)				005205 00 00		
Edge protector, for Gastronorm-container 1/2 (265 x 325 mm)				005206 00 00		
Edge protector, for Gastronorm-container 1/3 (176 x 325 mm)				005207 00 00		
Edge protector, for Gastronorm-container 2/8 (132 x 325 mm)				005208 00 00		
Additional information						
Minimal vanity unit width: 900 mm						
countertop cutout dimension 872 x 482 mm						
The minimum thickness of the countertop is 40 mm						
The edge protector have a permanent temperature resistance of 250°C						

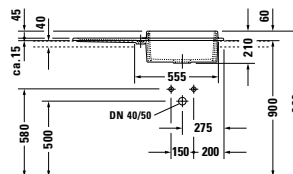
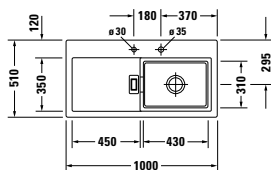
Starck K Design by Philippe Starck

Outlet diameter Ø 90 mm

Kitchen sink built in version Starck K 60 R/L	mm	kg	Qty.	Model-No.	Euro	
					White -00	Black -08
					Matt Crema -27	
					Matt white silk -33	
					Pergamon -47	
					Anthracite matt -68	

countertop basin, with overflow, with tap platform, cable-driven waste chrome, included

bowl on right side ●●	1000 x 510	26,5	5	751010 .. 00		
bowl on left side ●●	1000 x 510	26,5	5	751110 .. 00		

Accessories

Cutting board, fits on sink, beech oiled	470 x 350	2,48		005200 00 00		
Cutting board, fits on sink and shelf, beech oiled	380 x 350	2,06		005201 00 00		
Cutting board, fits on sink and shelf, beech oiled	280 x 350	1,7		005202 00 00		
Cutting board, fits on sink and shelf, beech oiled	190 x 350	1,06		005203 00 00		
Edge protector, for Gastronorm-container 2/3 (354 x 325 mm)				005205 00 00		
Edge protector, for Gastronorm-container 1/2 (265 x 325 mm)				005206 00 00		
Edge protector, for Gastronorm-container 1/3 (176 x 325 mm)				005207 00 00		
Edge protector, for Gastronorm-container 2/8 (132 x 325 mm)				005208 00 00		

Additional information

Minimal vanity unit width: 600 mm

countertop cutout dimension 972 x 482 mm

The minimum thickness of the countertop is 40 mm

The edge protector have a permanent temperature resistance of 250°C

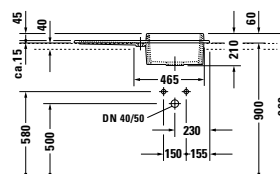
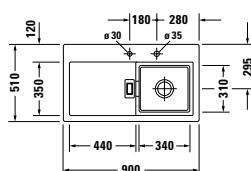

Outlet diameter Ø 90 mm

Kitchen sink built in version Starck K 50 R/L	mm	kg	Qty.	Model-No.	Euro	
					White -00	Black -08
					Matt Crema -27	
					Matt white silk -33	
					Pergamon -47	
					Anthracite matt -68	

countertop basin, with overflow, with tap platform, cable-driven waste chrome, included

bowl on right side ●●	900 x 510	24,5	5	751090 .. 00		
bowl on left side ●●	900 x 510	24,5	5	751190 .. 00		

Accessories

Cutting board, fits on sink and shelf, beech oiled	380 x 350	2,06		005201 00 00		
Cutting board, fits on sink and shelf, beech oiled	280 x 350	1,7		005202 00 00		
Cutting board, fits on sink and shelf, beech oiled	190 x 350	1,06		005203 00 00		
Edge protector, for Gastronorm-container 1/2 (265 x 325 mm)				005206 00 00		
Edge protector, for Gastronorm-container 1/3 (176 x 325 mm)				005207 00 00		
Edge protector, for Gastronorm-container 2/8 (132 x 325 mm)				005208 00 00		

Additional information

Minimal vanity unit width: 500 mm

countertop cutout dimension 872 x 482 mm

The minimum thickness of the countertop is 40 mm

The edge protector have a permanent temperature resistance of 250°C

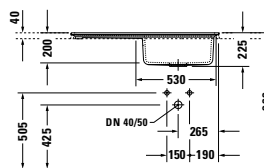
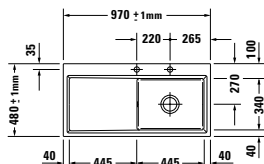
Kiora Design by Sieger Design

Outlet diameter Ø 90 mm

Tap hole / pop up diameter Ø 35 mm

Kitchen sink flush mounted Kiora 60 XL R/L	mm	kg	Qty.	Model-No.	Euro	
					White -00	Black -08
					Matt Crema -27	
					Matt white silk -33	
					Pergamon -47	
					Anthracite matt -68	

for flush mount installation in countertops, with overflow, with tap platform, cable-driven waste chrome, included

bowl on right side ● ●

970 +/-1 x 480 +/-1 22,4 5 **752010 .. 27**

bowl on left side ● ●

970 +/-1 x 480 +/-1 24,1 5 **752110 .. 27**

Accessories

Cutting board, Epicurean black

405 x 405

3,5

005214 00 00

Additional information

Minimal vanity unit width: 600 mm

for cutout dimension refer to built-in recommendation for flush mounted sinks on page 653

The minimum thickness of the countertop is 40 mm

cutting board is dishwasher safe and heat resistant up to 180° C

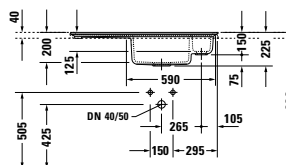
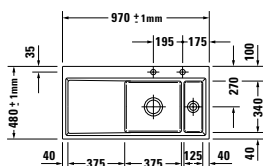

Outlet diameter Ø 90 mm

Outlet diameter Ø 58 mm

Tap hole / pop up diameter Ø 35 mm

Kitchen sink flush mounted Kiora 60 R/L	mm	kg	Qty.	Model-No.	Euro	
					White -00	Black -08
					Matt Crema -27	
					Matt white silk -33	
					Pergamon -47	
					Anthracite matt -68	

for flush mount installation in countertops, with strainer bowl, with overflow, with tap platform, cable-driven waste chrome, included

bowl on right side ● ●

970 +/-1 x 480 +/-1 23,7 5 **751810 .. 27**

bowl on left side ● ●

970 +/-1 x 480 +/-1 25,1 5 **751910 .. 27**

Accessories

Cutting board, Epicurean black

405 x 405

3,5

005214 00 00

Additional information

Minimal vanity unit width: 600 mm

for cutout dimension refer to built-in recommendation for flush mounted sinks on page 653

The minimum thickness of the countertop is 40 mm

cutting board is dishwasher safe and heat resistant up to 180° C

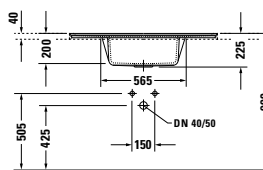
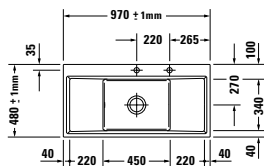

WonderGliss
Simply add a '1' to
the model-no.

Kiora Design by Sieger Design

Outlet diameter Ø 90 mm

Tap hole / pop up diameter Ø 35 mm

Kitchen sink flush mounted Kiora 60 Z	mm	kg	Qty.	Model-No.	Euro	
					White -00	Black -08
					Matt Crema -27	
					Matt white silk -33	
					Pergamon -47	
					Anthracite matt -68	

for flush mount installation in countertops, with overflow, with tap platform, cable-driven waste chrome, included bowl central ● ●

970+/-1 x 480+/-1 24,1 5 **752210 .. 27**

Accessories

Cutting board, Epicurean black

405 x 405 3,5 **005214 00 00**

Additional information

Minimal vanity unit width: 600 mm

for cutout dimension refer to built-in recommendation for flush mounted sinks on page 653

The minimum thickness of the countertop is 40 mm

cutting board is dishwasher safe and heat resistant up to 180° C

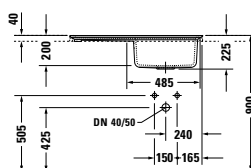
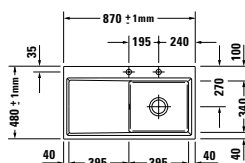

Outlet diameter Ø 90 mm

Tap hole / pop up diameter Ø 35 mm

Kitchen sink flush mounted Kiora 50 R/L	mm	kg	Qty.	Model-No.	Euro	
					White -00	Black -08
					Matt Crema -27	
					Matt white silk -33	
					Pergamon -47	
					Anthracite matt -68	

for flush mount installation in countertops, with overflow, with tap platform, cable-driven waste chrome, included bowl on right side ● ●

870 +/-1 x 480 +/-1 21,4 5 **751690 .. 27**

bowl on left side ● ●

870 +/-1 x 480 +/-1 21,4 5 **751790 .. 27**

Accessories

Cutting board, Epicurean black

405 x 405 3,5 **005214 00 00**

Additional information

Minimal vanity unit width: 500 mm

for cutout dimension refer to built-in recommendation for flush mounted sinks on page 653

The minimum thickness of the countertop is 40 mm

cutting board is dishwasher safe and heat resistant up to 180° C

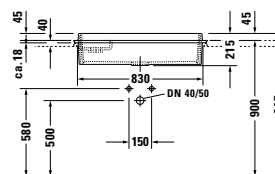
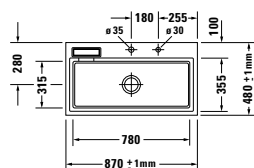
Starck K Design by Philippe Starck

Outlet diameter Ø 90 mm

Kitchen sink flush mounted Starck K 90	mm	kg	Qty.	Model-No.	Euro
					White -00 Black -08 Matt Crema -27 Matt white silk -33 Pergamon -47 Anthracite matt -68

for flush mount installation in countertops, with overflow, with tap platform, cable-driven waste chrome, included bowl without shelf ● ●

	870 +/-1 x 480 +/-1	30,5	5	751290 .. 27	
--	---------------------	------	---	--------------	--

Accessories

Cutting board, fits on sink, beech oiled	470 x 350	2,48		005200 00 00	
Cutting board, fits on sink, beech oiled	380 x 350	2,06		005201 00 00	
Cutting board, fits on sink, beech oiled	280 x 350	1,7		005202 00 00	
Cutting board, fits on sink, beech oiled	190 x 350	1,06		005203 00 00	
Edge protector, for Gastronorm-container 1/1 (530 x 325 mm)				005204 00 00	
Edge protector, for Gastronorm-container 2/3 (354 x 325 mm)				005205 00 00	
Edge protector, for Gastronorm-container 1/2 (265 x 325 mm)				005206 00 00	
Edge protector, for Gastronorm-container 1/3 (176 x 325 mm)				005207 00 00	
Edge protector, for Gastronorm-container 2/8 (132 x 325 mm)				005208 00 00	

Additional information

Minimal vanity unit width: 900 mm

for cutout dimension refer to built-in recommendation for flush mounted sinks on page 653

The minimum thickness of the countertop is 40 mm

The edge protector have a permanent temperature resistance of 250°C



WonderGliss
Simply add a '1' to
the model-no.

Starck K Design by Philippe Starck

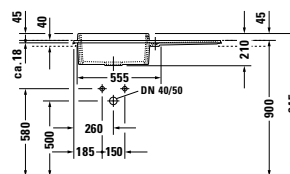
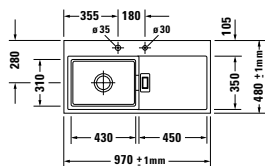

⊕ Outlet diameter Ø 90 mm

Kitchen sink flush mounted Starck K 60 L/R	mm	kg	Qty.	Model-No.	Euro	
					White -00	Black -08
					Matt Crema -27	
					Matt white silk -33	
					Pergamon -47	
					Anthracite matt -68	

for flush mount installation in countertops, with overflow, with tap platform, cable-driven waste chrome, included

bowl on left side ● ●	970 +/-1 x 480 +/-1	25,5	5	751110 .. 27		
bowl on right side ● ●	970 +/-1 x 480 +/-1	25,5	5	751010 .. 27		

Accessories

Cutting board, fits on sink, beech oiled	470 x 350	2,48		005200 00 00		
Cutting board, fits on sink and shelf, beech oiled	380 x 350	2,06		005201 00 00		
Cutting board, fits on sink and shelf, beech oiled	280 x 350	1,7		005202 00 00		
Cutting board, fits on sink and shelf, beech oiled	190 x 350	1,06		005203 00 00		
Edge protector, for Gastronorm-container 2/3 (354 x 325 mm)				005205 00 00		
Edge protector, for Gastronorm-container 1/2 (265 x 325 mm)				005206 00 00		
Edge protector, for Gastronorm-container 1/3 (176 x 325 mm)				005207 00 00		
Edge protector, for Gastronorm-container 2/8 (132 x 325 mm)				005208 00 00		

Additional information

Minimal vanity unit width: 600 mm

for cutout dimension refer to built-in recommendation for flush mounted sinks on page 653

The minimum thickness of the countertop is 40 mm

The edge protector have a permanent temperature resistance of 250°C

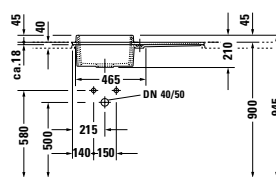
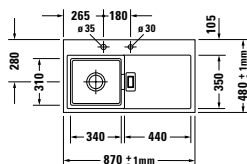
Starck K Design by Philippe Starck

Outlet diameter Ø 90 mm

Kitchen sink flush mounted Starck K 50 L/R	mm	kg	Qty.	Model-No.	Euro		
					White -00	Black	-08
					Matt Crema -27		
					Matt white silk -33		
					Pergamon -47		
					Anthracite matt -68		

for flush mount installation in countertops, with overflow, with tap platform, cable-driven waste chrome, included

bowl on left side ● ●	870 +/-1 x 480 +/-1	23,5	5	751190 .. 27			
bowl on right side ● ●	870 +/-1 x 480 +/-1	23,5	5	751090 .. 27			

Accessories

Cutting board, fits on sink and shelf, beech oiled	380 x 350	2,06		005201 00 00			
Cutting board, fits on sink and shelf, beech oiled	280 x 350	1,7		005202 00 00			
Cutting board, fits on sink and shelf, beech oiled	190 x 350	1,06		005203 00 00			
Edge protector, for Gastronorm-container 1/2 (265 x 325 mm)				005206 00 00			
Edge protector, for Gastronorm-container 1/3 (176 x 325 mm)				005207 00 00			
Edge protector, for Gastronorm-container 2/8 (132 x 325 mm)				005208 00 00			

Additional information

Minimal vanity unit width: 500 mm

for cutout dimension refer to built-in recommendation for flush mounted sinks on page 653

The minimum thickness of the countertop is 40 mm

The edge protector have a permanent temperature resistance of 250°C

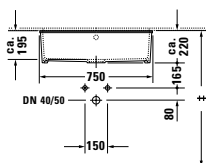
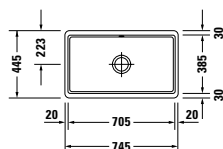
Vero Design by Duravit

 Outlet diameter \varnothing 90 mm

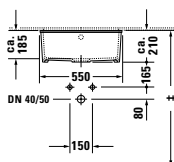
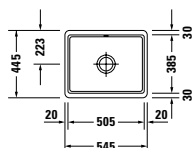
Undercounter kitchen sink Vero 80	mm	kg	Qty.	Model-No.	Euro	
					White -00	Black -08
					Matt Crema -27	
					Matt white silk -33	
					Pergamon -47	
					Anthracite matt -68	
with overflow, without tap platform, fixings and outlet connectors included						
for hand operation	745 x 445	25,4	10	751475 .. 71		
with cable-driven waste, chrome	745 x 445	25,4	10	751475 .. 72		
Additional information						
Minimal vanity unit width: 800 mm						
Countertop cutout dimension 695 x 375 mm flanging radius R15 mm						
For sink type 72 with cable-driven waste a hole \varnothing 35 mm for pop-up knob is recommended						

 Outlet diameter \varnothing 90 mm

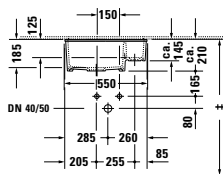
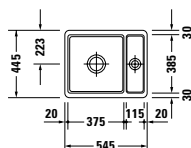
Undercounter kitchen sink Vero 60 XL	mm	kg	Qty.	Model-No.	Euro	
					White -00	Black -08
					Matt Crema -27	
					Matt white silk -33	
					Pergamon -47	
					Anthracite matt -68	
with overflow, without tap platform, fixings and outlet connectors included						
for hand operation	545 x 445	18,2	18	751455 .. 71		
with cable-driven waste, chrome	545 x 445	18,2	18	751455 .. 72		
Additional information						
Minimal vanity unit width: 600 mm						
Countertop cutout dimension 495 x 375 mm flanging radius R15 mm						
For sink type 72 with cable-driven waste a hole \varnothing 35 mm for pop-up knob is recommended						

Vero Design by Duravit

- Outlet diameter Ø 90 mm
- Outlet diameter Ø 58 mm

Undercounter kitchen sink Vero 60	mm	kg	Qty.	Model-No.	Euro	
					White -00	Black -08
					Matt Crema -27	
					Matt white silk -33	
					Pergamon -47	
					Anthracite matt -68	
with strainer bowl, with overflow, without tap platform, fixings and outlet connectors included, reversible for hand operation ☒						
	545 x 445	19,0	18	751555 .. 71		
with cable-driven waste, chrome ☒						
	545 x 445	19,0	18	751555 .. 72		

Additional information

Minimal vanity unit width: 600 mm

Countertop cutout dimension 495 x 375 mm flanging radius R15 mm

For sink type 72 with cable-driven waste a hole Ø 35 mm for pop-up knob is recommended

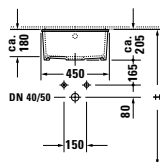
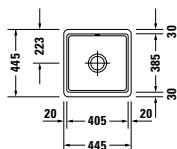

- Outlet diameter Ø 90 mm

Undercounter kitchen sink Vero 50	mm	kg	Qty.	Model-No.	Euro	
					White -00	Black -08
					Matt Crema -27	
					Matt white silk -33	
					Pergamon -47	
					Anthracite matt -68	
with overflow, without tap platform, fixings and outlet connectors included						
	445 x 445	14,0	21	751445 .. 71		
with cable-driven waste, chrome ☒						
	445 x 445	14,0	21	751445 .. 72		

Additional information











Minimal vanity unit width: 500 mm

Countertop cutout dimension 395 x 375 mm flanging radius R15 mm





For sink type 72 with cable-driven waste a hole Ø 35 mm for pop-up knob is recommended

 WonderGliss
Simply add a '1' to
the model-no.

D-Code Design by sieger design

	Description	mm	kg	Qty.	Model-No.	Euro
	Soap dish					
	chrome					
	glass shelf left, frosted glass		0,66		009917 10 00	
	glass shelf right, frosted glass		0,66		009918 10 00	
	Glass holder					
	chrome					
	glass left, frosted glass		0,61		009919 10 00	
	glass right, frosted glass		0,61		009920 10 00	
	Towel ring					
	chrome		0,38		009921 10 00	
	Towel hook					
	chrome		0,1		009904 10 00	
	Towel rail					
	two swivelling arms					
	chrome	445	0,9		009922 10 00	
	Bath towel rail					
	chrome	800	0,78		009923 10 00	
	Bath towel rail					
	chrome	600	0,7		009924 10 00	
	Towel shelf					
	chrome	630 x 220	1,58		009925 10 00	
	Paper holder					
	chrome		0,35		009926 10 00	
	Brush set					
	wall mounted,					
	frosted glass					
	chrome		1,25		009927 10 00	





D-Code Design by sieger design

	Description	mm	kg	Qty.	Model-No.	Euro
	Brush set floor standing chrome		0,9		009928 10 00	
	Cosmetic mirror 3 times magnifier chrome		0,91		009912 10 00	
	Bathtub handle chrome	250	0,72		009914 10 00	
	Spare paper holder chrome		0,33		009915 10 00	
	Soap dispenser wall mounted, frosted glass chrome		0,5		009916 10 00	

Karree Design by Duravit

	Description	mm	kg	Qty.	Model-No.	Euro
	Cosmetic mirror 3 times magnifier chrome		0,91		009912 10 00	
	Soap dish frosted glass chrome		0,75		009952 10 00	
	Soap basket chrome		0,65		009953 10 00	
	Soap dispenser wall mounted, frosted glass chrome		1,0		009954 10 00	
	Glas shelf frosted glass		1,5		009950 10 00	
	Glass holder frosted glass chrome		0,8		009951 10 00	
	Towel ring chrome		0,65		009961 10 00	
	Towel hook chrome		0,1		009904 10 00	
	Towel rail two swivelling arms chrome		0,7		009958 10 00	
	Bath towel rail chrome	600	0,65		009959 10 00	
	Bath towel rail chrome	800	0,75		009960 10 00	
	Towel shelf chrome		1,5		009962 10 00	









Karree Design by Duravit

	Description	mm	kg	Qty.	Model-No.	Euro
	Bathtub handle chrome		0,8		009963 10 00	
	Paper holder chrome		0,6		009955 10 00	
	Spare paper holder chrome		0,3		009956 10 00	
	Brush set wall mounted, frosted glass chrome		1,5		009957 10 00	

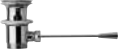
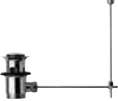









Starck 1 Design by Philippe Starck

	Description	mm	kg	Qty.	Model-No.	Euro
	Soap dish chrome		0,3		009771 10 00	
	Glas shelf chrome	600	0,9		009801 10 00	
	Glass holder chrome		0,3		009761 10 00	
	Towel ring chrome		0,6		009791 10 00	
	Towel hook chrome		0,2		009721 10 00	
	Towel rail two swivelling arms chrome	420	1,4		009722 10 00	
	Bath towel rail chrome	800	1,4		009741 10 00	
	Bath towel rail chrome	600	1,3		009731 10 00	
	Bathtub handle chrome	430	1,0		009751 10 00	
	Paper holder two arms, without cover chrome		0,4		009711 10 00	
	Brush set wall mounted chrome		1,0		009781 10 00	
	Brush set chrome		1,0		009782 10 00	
	Wall lamp light bulb max. 40 W, lampshade (White) metal parts chrome		0,7		009701 10 00	

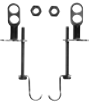

Fittings Ceramics

	Description	mm	kg	Qty.	Model-No.	Euro
	Slotted waste chrome	50	0,3		005024 10 00	
	Slotted waste chrome	80	0,4		005038 10 00	
	Push-open waste *** chrome		0,35		005052 10 00	
Infobox: *** Required in conjunction with wall mounted tap fitting, vanity unit and/or consoles						
	Pop-up basin waste chrome with horizontal lever**		0,5		005031 10 00	
Infobox: ** Required in conjunction with wall mounted tap fitting and consoles with a maximum thickness of 30 mm						
	Pop-up basin waste chrome with vertical lever***		0,5		005051 10 00	
Infobox: *** In combination with wall mounted tap and Duravit bathroom furniture						
	Drain cover chrome		0,1		005040 10 00	
	Drain cover chrome		0,08		005043 10 00	
	Overflow clip chrome				100107 00 00	
	Outlet bend with double sleeve chrome	Ø 32	0,2		005025 10 00	
	Fixing Set for stone countertops (with the exception of # 046651)		0,2		005028 00 00	
	Fixing Set for stone countertops		0,02		005037 10 00	











Fittings Ceramics

	Description	mm	kg	Qty.	Model-No.	Euro
	Space saving siphon White	1 1/4"	0,4		005073 00 00	
<div style="border: 1px solid black; padding: 2px;"> Infobox: For vanity units the space saving siphon is recommended </div>						
	Fixing for washbasins	Ø 10 x 140	0,2		695100 00 00	
	Fixing for mounting utility basin Starck 3 # 031348 without grid chrome	Ø 10 x 140	0,2		006712 10 00	
	Siphon for washbasin with outlet pipe 300 mm chrome	1 1/4"	0,6		005026 00 00	
	Design Siphon * chrome		1,5		005036 10 00	
<div style="border: 1px solid black; padding: 2px;"> Infobox: * When using this siphon please observe outlet height from upper surface of finished floor to centre of outlet in accordance with the technical specification sheet </div>						
	In-wall-siphon kit ** for washbasin Architec including connection equipment		0,6		005044 10 00	
<div style="border: 1px solid black; padding: 2px;"> Infobox: ** Mandatory for installation </div>						
	Fixing for siphon cover		0,1		005503 00 00	
	Fixing for siphon cover		0,1		005504 00 00	
	Fixing for siphon cover		0,09		005505 00 00	
	Design angle valve with rosette, chrome	1/2"	0,5		003045 10 00	
	Fixing caps white	Ø 6 x 60	0,1		006700 00 00	
	caps chrome	Ø 6 x 60	0,1		006700 10 00	

Fittings Ceramics

	Description	mm	kg	Qty.	Model-No.	Euro
	Mounting set for One-piece and Two-piece toilets 1/2", US-version		0,48		001431 00 00	
	Mounting set for One-piece and Two-piece toilets 1/2"		0,48		001418 00 96	
	Mounting set for One-piece and Two-piece toilets 1/2", US-version		0,48		001417 00 00	
	Mounting set for One-piece and Two-piece toilets 1/2"		0,48		001416 00 00	
	Vario connecting bend for vertical outlet	Ø 100	0,7		899025 00 06	
	Vario connector set for horizontal and vertical outlet, length adjustable incl. excenter	Ø 110	1,5		001422 00 00	
	Connecting bend with rosette vertical outlet	Ø 110	0,1		001428 00 00	
	Connecting pipe with rosette horizontal outlet	Ø 110	0,1		001429 00 00	
	Conversion set for back supply chrome		0,5		007504 10 00	
	concealed cistern with Dual Flush mechanism, without actuator plate for side, back or top supply		3,8		001480 00 00	



Fittings Ceramics

	Description	mm	kg	Qty.	Model-No.	Euro
	Support bracket to be built in (distance 180 mm) Suitable for solid walls for wall mounted toilet				695200 00 00	
	Noise reduction gasket for wall mounted bidet and wall mounted toilet		0,3		005019 00 00	
	Noise reduction gasket for wall mounted toilet		0,3		005020 00 00	
	Noise reduction gasket for wall mounted toilet		0,3		005064 00 00	
	Mounting set consisting of inlet/waste pipe, lip-seal, caps white for wall mounted toilet				695300 00 00	
	Dual Flush Actuator Plate Skate Air for # 001480, chrome		0,5		001481 10 00	
	Dual Flush Actuator Plate Surf for # 001480, chrome		0,5		001482 10 00	
	Fixing for wall mounted bidet and wall mounted toilet					
	caps white	Ø 12 x 180	0,2		006500 00 00	
	caps chrome	Ø 12 x 180	0,2		006500 10 00	
	Infobox: If pre-wall carrier not used, the fixing # 006500 is recommended					
	Siphon vertical outlet	Ø 50	0,2		005111 00 00	
	Siphon horizontal outlet (concealed)	Ø 50	0,2		005112 00 00	

Fittings Ceramics

	Description	mm	kg	Qty.	Model-No.	Euro
	Mounting set for urinal Ben, Jim, Bill, consisting of fixings and siphon vertical outlet				001435 10 00	
	Mounting set for urinal Ben, Jim, Bill, consisting of fixings and siphon horizontal outlet				001436 10 00	
	Fixing for urinal Ben, Jim, Bill caps chrome	Ø 10 x 140	0,2		005030 10 00	
	Fixing for urinal Dellarco, Duraplus, Utronic, Dry, Katja, 1930 caps chrome	Ø 8 x 110	0,1		006713 10 00	
	Outlet connector for McDry urinal		0,12		005006 00 00	
	Urinal screen Stainless steel		0,2		005041 10 00	
	Urinal screen Stainless steel		0,2		005042 10 00	
	Siphon for bidet with extended outlet pipe chrome	1 1/4"	0,6		005027 00 00	
	Fixing hooks for urinal # 084533 and 084229, for washbasin # 045360 for handrinse basin # 079444 and # 075244		0,3		005000 00 00	
	Fixing for floor standing bidet, floor standing toilet and siphon cover caps white and chrome	Ø 6 x 70	0,4		006701 10 00	
	Water inlet mechanism for urinals with back supply	1/2"	0,1		695800 00 00	

Fittings SensoWash®

	Description	mm	kg	Qty.	Model-No.	Euro
	ProBox Flush-mounting safety device fusing according to DIN EN 1717 1/2"				005071 00 00	
	Mounting set for in-wall carrier				005072 00 00	
	<div style="border: 1px solid black; padding: 5px;"> <p>Infobox: Mounting set # 005072 suitable for most common pre-wall carriers with horizontal support - mandatory during bare brickwork! Further details see http://pro.duravit.com</p> </div>					

Bathtubs + Well Being

Bathtubs + Well Being

Bathtubs + Well Being

Bathtubs + Well Being

Important Indications Bathtubs + Well Being

1. Additions

New Models

Series	Remark	Availability
DuraStyle	Previous models of the series Onto - bathtubs # 700231, 700233 - furniture panels # DS 8946-8949, # DS 8951-8955	available available
Sundeck	Pools # 710358, 710359 Furniture panels # SU 8682-8683, # SU 8692-8693, SU 8680-8681, # SU 8690-8691	available
Accessories	Waste and overflow with base inlet # 791226-791241	available

2. Discontinued items

Series and models

Series	Remark	Availability
2nd floor	Tray with bookend # 2F 9810, 9812-9815	
D-Code	Shower tray # 720109	from stock
Happy D.	Bathtubs # 700015-700020, # 700172-700174, 700178-700180	
Onto	Bathtubs # 700230, 700232 Panels # OT 8938, 8939, 8945, 8950, # 8777, 8778, 8782, 8783, 8787, 8788	
Paiova	Headrest # 790001310000000 Universal steps # PA 8720, 8721 Steps # PA 8722-8727	
PuraVida	Shower trays # 720077, 720078 Acrylic panels # 701081-701087, 701094 Furniture panel pricegroup 2	
Starck	Bathtubs # 700001-700003, # 700057-700062, 700088-700090, # 700117-700118, 700204-700207 Shower trays # 720005-720019, # 720030-720042, 720061 Headrest # 790000310000000	
Sundeck	Pool # 710171 Furniture panels # SU 8671-8672, # SU 8676-8677	
Accessories	Bathtub handles # 790600, 790601 Waste and overflows # 791208-791209, # 791211, 791218, 791223, # 790272-790281, 790283	

3. Special indications

When ordering bathtubs, whirltubs and pools please consider:

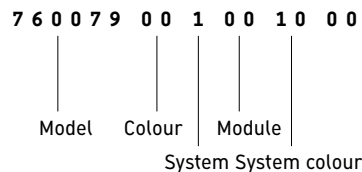

When ordering your whirltub please indicate the item number of the module requested. Based on this information the exact item number will be determined by our sales service.

When ordering a whirltub the order number is made up from:

bathtub +	7 0 0 0 7 9 0 0 0 0 0 0 0 0 0 0
whirlsystem =	+ 7 6 0 * * * 0 0 4 1 6 1 0 0 0
bathtub incl. whirlsystem (e.g. Combi-System E)	= 7 6 0 0 7 9 0 0 4 1 6 1 0 0 0

When ordering a bathtub with panel the order number is made up from:
bathtub item number +
bathtub panel item number +
colour

7 0 0 0 7 9 0 0 0 0 0 0 0 0 0
+
2 F 8 7 8 6
+
B l e a c h e d O a k - 6 5

4. Inipi and Inipi B Sauna

Please add the furniture colour code at the 5th and 6th digit of the item number, when ordering Inipi or Inipi B.

7 5 0 1 * * 0 0 1 0 0 1 0 0 0
|
Furniture colour code

5. St.Trop steam shower / Nahho floatation tub

Please add the furniture colour code at the 7th and 8th digit code for the furniture surface of the doorframe for St.Trop and for the furniture surface of the furniture cover for Nahho.

6. Antislip

Antislip coating for all Duravit shower trays. This transparent yet perceptible Antislip coating ensures a higher degree of safety when showering. Features: long-lasting, easy to clean, environmentally friendly and approved by the TÜV (German Technical Inspection Association) according to DIN 51097 and DIN EN 13845.

Please add a „1“ at the last digit of the item number when ordering Antislip.

7 2 0 1 1 5 0 0 0 0 0 0 0 0 1
|
Antislip

7. CAD drawings

CAD data of Duravit sanitary ware can be downloaded from our internet website www.duravit.com or pro.duravit.com (DXF, DWG, IGS, STP format).

8. Standard equipment of all Duravit whirlsystems

- Full system drainage
- Cable-driven waste and overflow, chrome
- Support frame
- Protection against dry-running

9. Acrylic tolerances

Due to the production process the specified nominal dimensions can vary within the tolerances according to DIN EN 14516 (bathtubs) and DIN EN 14527 (shower trays). Please take this into consideration for your planning.

10. Preinstallation sheets

Preinstallation sheets of our products can be downloaded from our internet website www.duravit.com or pro.duravit.com.

11. Application area of products

The products are to be used exclusively in the private sector. This includes usage in hotel rooms, residential homes etc. Medical usage is excluded as well as usage in public areas of hotel-spas, well being centers, etc.

Product information accessories for bathtub

LED coloured light with remote control for bathtubs*

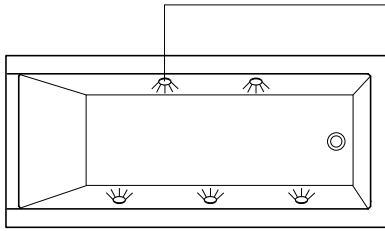

Light
Light on/off

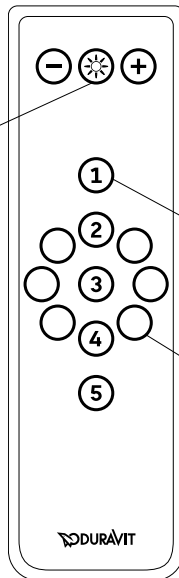

Programming buttons
Selecting a predefined coloured light programme

Colour buttons
Selecting a constant colour

Equipment

5 (10 in Blue Moon) spots

Control elements

Remote control



LED coloured light with remote control for bathtubs

Light from 5 (10 in Blue Moon) LED spots set into the side walls suffuses the water in alternating, bright colours. The 6 colours and white light plus 5 coloured lighting programmes can be selected using the remote control. The brightness of the colours can be dimmed.

A support frame is not required as it is already mounted to the bathtub. The coloured light is not suitable for bathtubs with support.

Power supply

220-230V 50/60Hz

Sound for bathtubs*

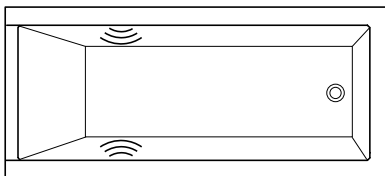

Equipment

3 structure-borne sound converter (installed under bathtub, non visible)
1 bluetooth receiver (installed under bathtub, non visible)



Sound for bathtubs

3 structure-borne sound converter create an optimal sound and music pleasure above and below the water line. The song choice and volume can be regulated with every bluetooth enabled musicplayer with A2DP profile. A support frame is not required as it is already mounted to the bathtub. There are no control elements on the rim necessary. Sound is not suitable for bathtubs with support.

Power supply

100-240V 50/60Hz

* Only available if these articles are listed on the product page

Whirlsystems product information

Air-System

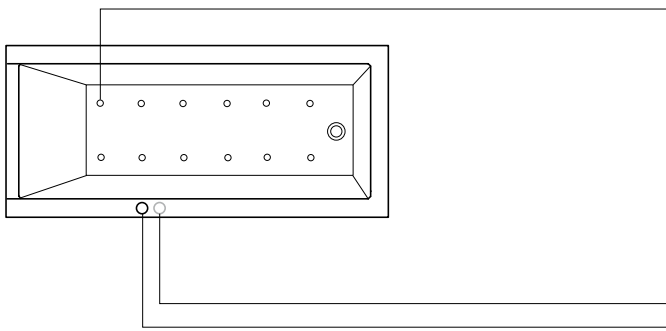

Equipment

12 floor jets (air)
Waste and overflow (without image)
Support frame (without image)

Accessories (optional)*

Waste and overflow with integrated water inlet (without image)
Waste and overflow with base inlet (without image)
LED coloured light, 5 spots (without image)
Sound (without image)

Control elements

Pneumatic switch LED coloured light (optional)
Pneumatic switch floor jets

Jet-System

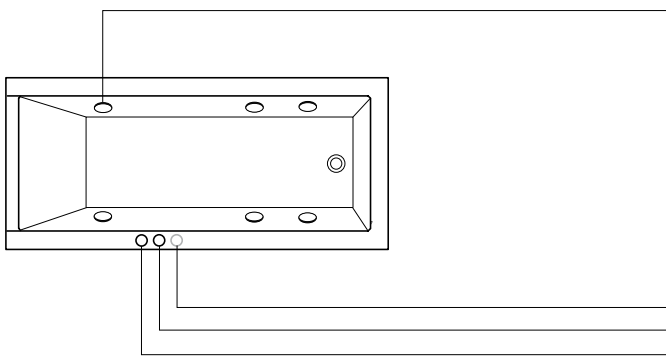

Equipment

6 adjustable side jets (mixture of air and water)
Waste and overflow (without image)
Support frame (without image)

Accessories (optional)*

Waste and overflow with integrated water inlet (without image)
Waste and overflow with base inlet (without image)
LED coloured light, 5 spots (without image)
Sound (without image)

Control elements

Pneumatic switch LED coloured light (optional)
Pneumatic switch side jets
Air regulator side jets

Combi-System P

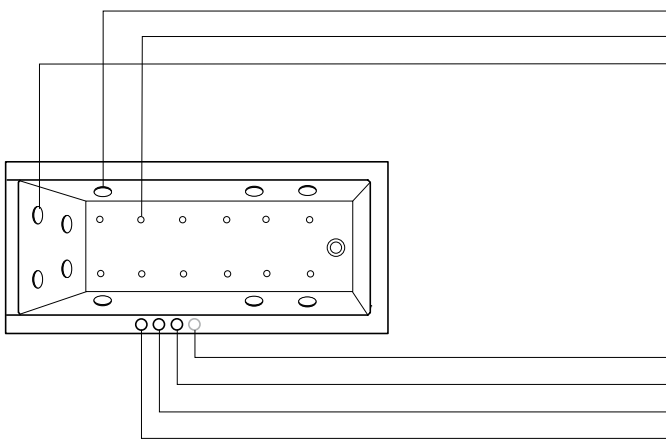

Equipment

6 adjustable side jets (mixture of air and water)
12 floor jets (air)
4 adjustable rotating back jets (mixture of air and water)
Waste and overflow (without image)
Support frame (without image)

Accessories (optional)*

Waste and overflow with integrated water inlet (without image)
Waste and overflow with base inlet (without image)
LED coloured light, 5 spots (without image)
Sound (without image)

Control elements

Pneumatic switch LED coloured light (optional)
Pneumatic switch floor jets
Pneumatic switch side and back jets
Air regulator side and back jets

Whirlsystems product information

Combi-System E

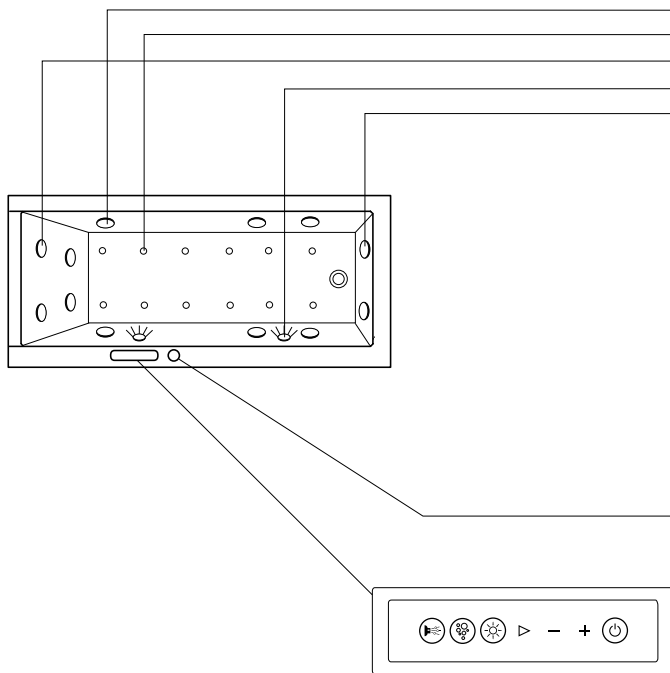

Equipment

6 adjustable side jets (mixture of air and water)
 12 floor jets (air)
 4 adjustable rotating back jets (mixture of air and water)
 LED white light, 2 spots
 2 adjustable rotating foot jets (mixture of air and water)
 Waste and overflow (without image)
 Support frame (without image)

Additional modules (optional)

Heating (without image)
 LED coloured light (instead of LED white light), 5 spots (without image)
 UV Hygiene Management (without image)

Accessories (optional)*

Waste and overflow with integrated water inlet (without image)
 Waste and overflow with base inlet (without image)
 Sound (without image)

Control elements

Diverter
 Pump performance can be concentrated to foot or back jets.

Control panel Combi-System E

The system is operated by pressing the raised symbol on the control panel.

Combi-System L

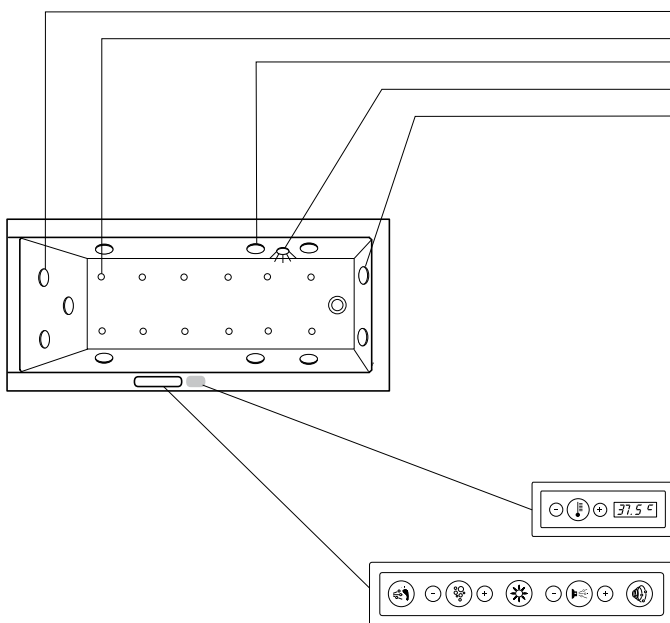

Equipment

3 adjustable rotating back jets (mixture of air and water)
 12 floor jets (air)
 6 adjustable side jets (mixture of air and water)
 White light, 1 spot
 2 adjustable rotating foot jets (mixture of air and water)
 Waste and overflow (without image)
 Support frame (without image)

Additional modules (optional)

LED coloured light (instead of white light), 5 spots (without image)
 UV Hygiene Management (without image)
 Temperature L (without image)

Accessories (optional)*

Waste and overflow with integrated water inlet (without image)
 Waste and overflow with base inlet (without image)

Control elements

Control panel Temperature L (optional)

Control panel Combi-System L

Blue backlit display.

The system is operated by pressing the raised symbols on the control panel. The operating symbols are almost invisible at first. By gently pressing the area within the stainless steel frame, the lighting comes on gradually. The functions are controlled via the now visible symbols. Once the whirl action is over, the lighting dims completely.

* Only available if these articles are listed on the product page

Whirlsystems product information

Combi-System E Blue Moon

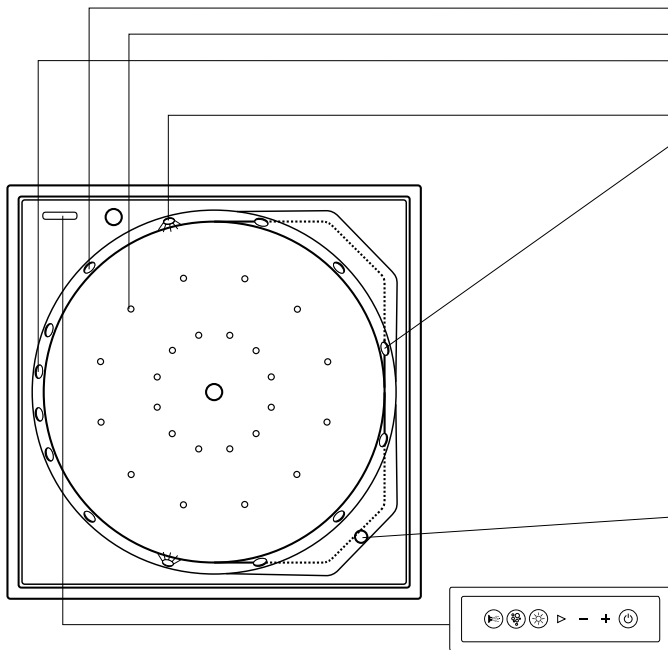

Equipment

6 adjustable side jets (mixture of air and water)
 24 floor jets (air)
 4 adjustable rotating back jets (mixture of air and water)
 (arranged in different heights)
 LED white light, 2 spots
 2 adjustable rotating foot jets (mixture of air and water)
 Waste and overflow (without image)
 Support frame (without image)

Additional modules (optional)

Heating (without image)
 LED coloured light (instead of LED white light), 10 spots (without image)
 UV Hygiene Management (without image)

Accessories (optional)

Special waste and overflow with base inlet (without image)
 Sound (without image)

Control elements

Divertor
 Pump performance can be concentrated to foot or back jets.

Control panel Combi-System E

The system is operated by pressing the raised symbol on the control panel.

Combi-System L Blue Moon

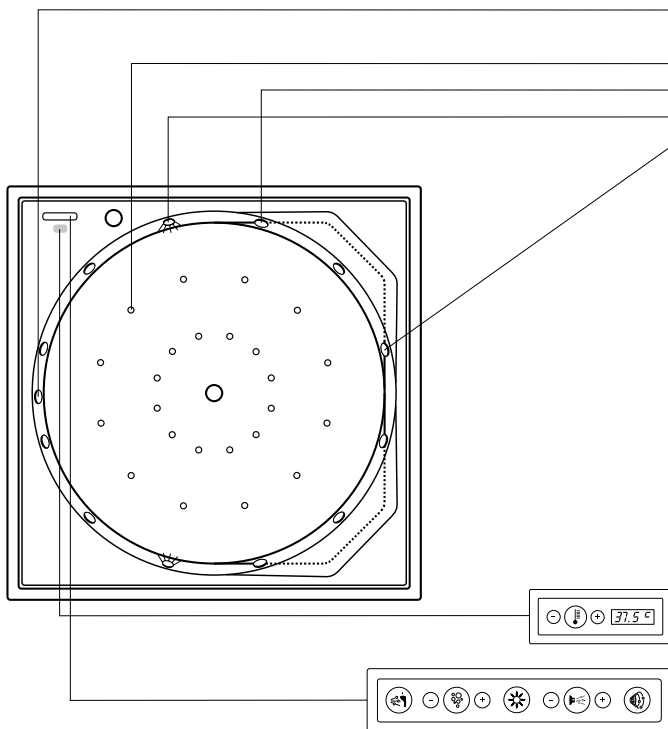

Equipment

3 adjustable rotating back jets (mixture of air and water)
 (arranged in different heights)
 24 floor jets (air)
 6 adjustable side jets (mixture of air and water)
 White light, 2 spots
 2 adjustable rotating foot jets (mixture of air and water)
 Waste and overflow (without image)
 Support frame (without image)

Additional modules (optional)

Temperature L (without image)
 LED coloured light (instead of white light), 10 spots (without image)
 UV Hygiene Management (without image)

Accessories (optional)

Special waste and overflow with base inlet (without image)

Control elements

Control panel Temperature L (optional)

Control panel Combi-System L

Blue backlit display.
 The system is operated by pressing the raised symbols on the control panel. The operating symbols are almost invisible at first. By gently pressing the area within the stainless steel frame, the lighting comes on gradually. The functions are controlled via the now visible symbols. Once the whirl action is over, the lighting dims completely.

Whirlsystems product information

Jet Project D-Code, DuraStyle

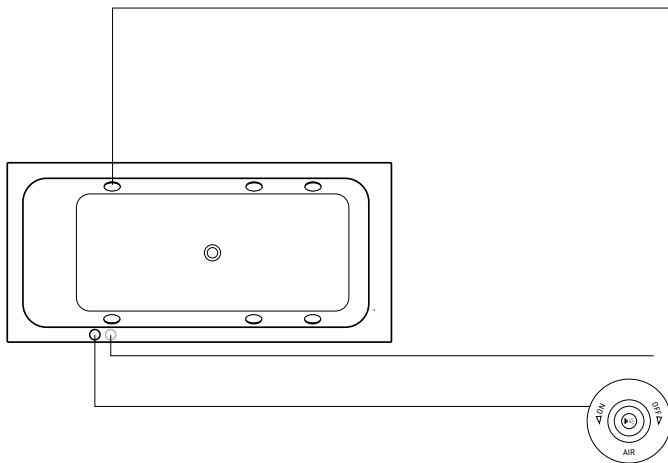

Equipment

6 adjustable side jets (mixture of air and water)
Waste and overflow (without image)
Support frame (without image)

Accessories (optional)*

Waste and overflow with integrated water inlet (without image)
Waste and overflow with base inlet (without image)
LED coloured light, 5 spots (without image)
Sound (without image)

Control elements

Pneumatic switch LED coloured light (optional)

Control panel side jets with air regulator

Durapearl-System Nahho

Built-in

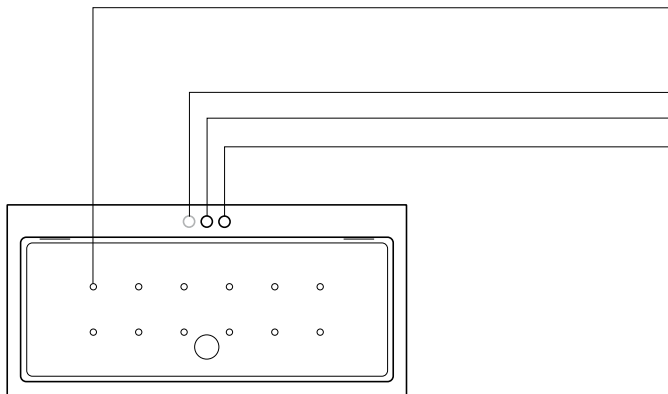

Equipment

12 Durapearl flat floor jets (mixture of air and water)

Control elements

Pneumatic switch LED coloured light (optional)
Pneumatic switch Durapearl-System
Turning handle waste and overflow

Accessories (optional)

LED coloured light, 5 spots (without image)
Waste and overflow with base inlet (without image)
Sound (without image)

With integrated panel

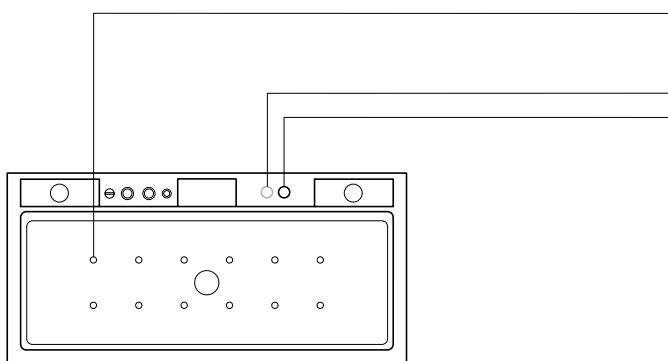

Equipment

12 Durapearl flat floor jets (mixture of air and water)

Control elements

Pneumatic switch LED coloured light (optional)
Pneumatic switch Durapearl-System

Accessories (optional)

LED coloured light, 5 spots (without image)
Sound (without image)

The figure shows the positioning of the control panel for corner right # 700286. For corner left # 700285 they are arranged mirror-inverted.

* Only available if these articles are listed on the product page

Whirlsystems product information

Whirlsystems and additional modules

Duavit whirlsystem are equipped as standard with the following: full system drainage, support frame, waste and overflow, protection against dry-running.



Floor jets (air)

Warm air is injected into the bath by 12 (24 in Blue Moon) jets embedded in the floor of the tub.



Side jets (mixture of air and water)

6 side mounted jets create maximum hydrotherapeutic action with actuated intensity of the massage, freely regulated via an air regulator which is integrated in the rim of the tub.



Durapearl flat floor jets (mixture of air and water)

12 Durapearl flat jets embedded in the floor of the tub create a sparkling mixture of air and water.



Back jets (mixture of air and water)

4 (3 in Combi-System L) adjustable rotating jets have a beneficial effect on the back.



Foot jets (mixture of air and water)

2 adjustable rotating jets are stimulating the reflex zones of the foot.



LED white light (Combi-System E)

2 LED spotlights (white light), create a cosy atmosphere in the bathroom.



White light (Combi-System L)

1 (2 in Blue Moon) halogen spot, 50 W, creates a cosy atmosphere in the bathroom.



Temperature L

Heating module with blue backlit display and control.



Heating

Electronically controlled thermal system to compensate for loss of temperature during whirl action.



LED coloured light

Light from 5 (10 in Blue Moon) LED spots set into the side walls suffuses the water in alternating, bright colours. A colour in accordance with the atmosphere. LED white light (Combi-System E) and white light (Combi-System L) are going to be replaced.



UV Hygiene Management

Simple, environmentally-friendly hygiene by means of automatic UV disinfection. Permanent monitoring of operation by optical sensor.



Sound for whirltubs

3 structure-borne sound converter create an optimal sound and music pleasure above and below the water line. The song choice and volume can be regulated with every bluetooth enabled musicplayer with A2DP profile. There are no control elements on the rim necessary. Sound is not available for Combi-System L and Jet Project D-Code.

Power supply

All whirlsystems except Combi-System L:

220-240V 50Hz

60Hz versions: Please replace "00" by "06" on 14th and 15th digit of the item number.

Combi-System L:

220-230V 50Hz

60Hz versions: Please replace "00" by "06" on 14th and 15th digit of the item number.

Whirlsystems product information

Revisability

The whirltub should be installed that way, that all important components (pump, blower and control panel) are still accessible. When an whirltub is equipped with a panel, this should be accessible and removable.

Positioning of the components of the whirlsystem

The figures show the standard configuration of the whirlsystem* with the positioning of the control panel. At the head side are the back jets (depending on the whirlsystem).

Custom version on request. Please send us a sketch showing the desired layout. Duravit will check and wherever possible confirm the feasibility.

2x3

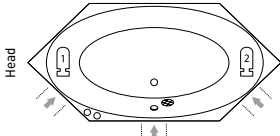

7X0023, # 7X0024

2nd floor

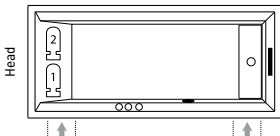

7X0074, # 7X0075

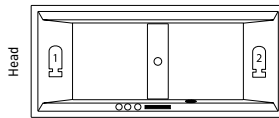

7X0076, # 7X0160, # 7X0161

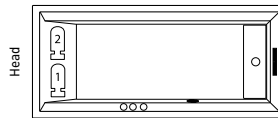

7X0079, # 7X0080

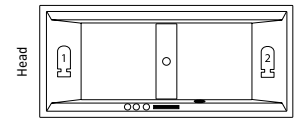

7X0081, # 7X0162, # 7X0163

Blue Moon

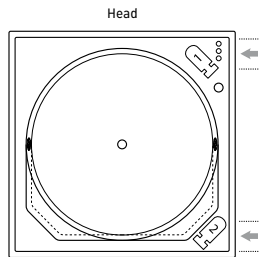

7X0143 built-in version

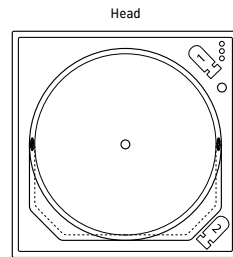

7X0143 with panel

Darling New

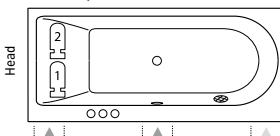

7X0238, # 7X0240, # 7X0242

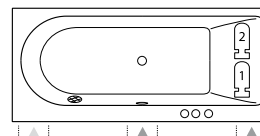

7X0239, # 7X0241, # 7X0243

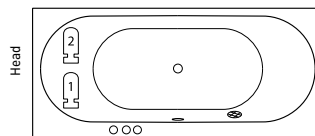

7X0244, # 7X0245

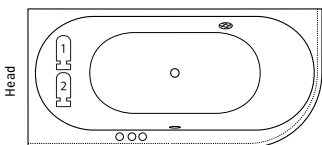

7X0246

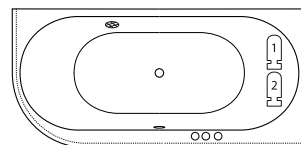

7X0247

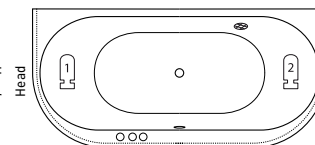

7X0248

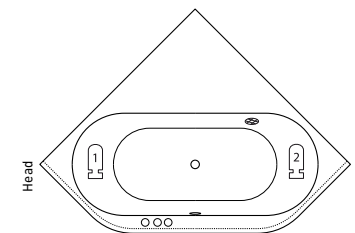

7X0249

* Please note that in case of combining tubs and whirlsystems, single components may reach over the rim of the tub. Therefore, we suggest installation into a bathtub case / Air-System, Jet-System, Combi-System P, Combi-System E and Durapeart-System: 76..., Combi-System L: 71...

Whirlsystems product information

Daro

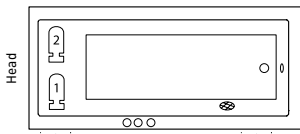

7X0027, # 7X0141

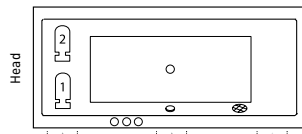

7X0028

D-Code

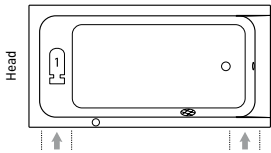

740095, # 740096,
740098, # 740100

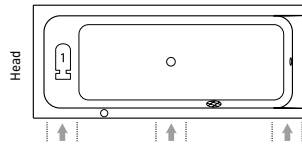

740097, # 740099

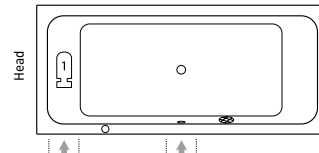

740101

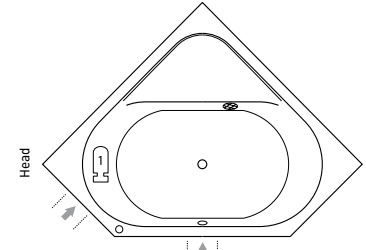

740137

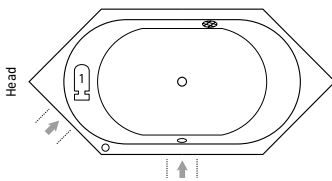

740138

DuraStyle

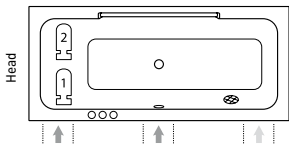

7X0292, # 7X0294, # 7X0296

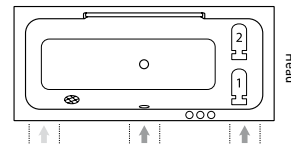

7X0293, # 7X0295, # 7X0297

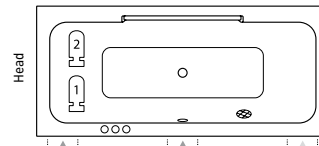

7X0298, # 7X0299

Esplanade

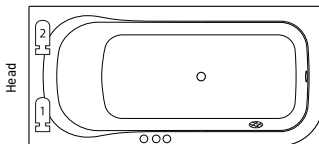

7X0281, # 7X0288

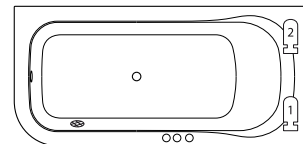

7X0282, # 7X0289

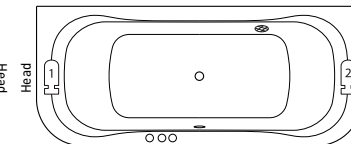

7X0283, # 7X0290

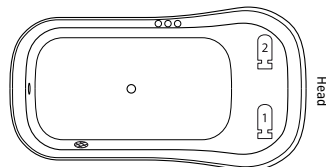

7X0284, # 7X0291

Whirlsystems product information

Happy D.2

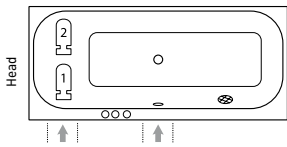

7X0308, # 7X0310, # 7X0312

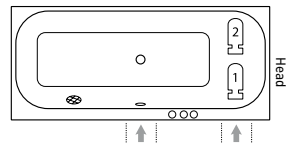

7X0309, # 7X0311, # 7X0313

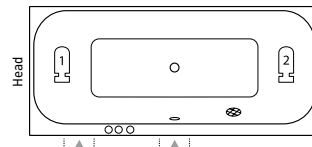

7X0314, # 7X0315

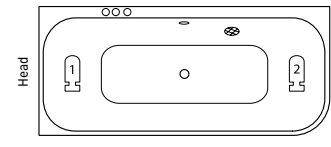

7X0316

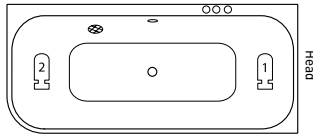

7X0317

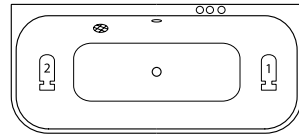

7X0318

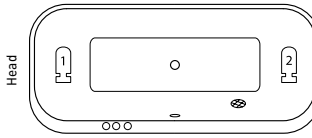

7X0319

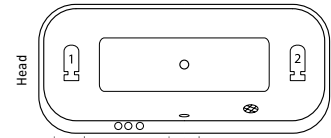

7X0320

Nahho

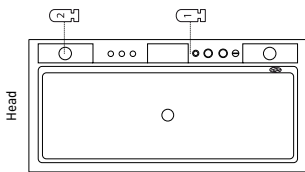

760285

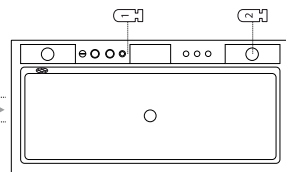

760286

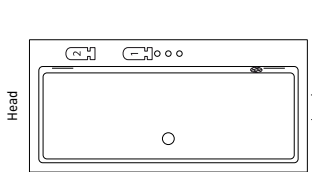

760280

Paiova

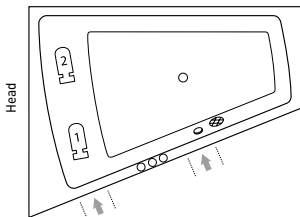

7X0212, # 7X0218
7X0214, # 7X0220
7X0216, # 7X0222

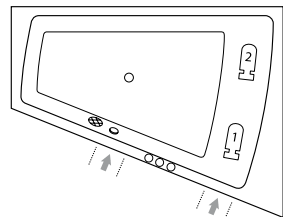

7X0213, # 7X0219
7X0215, # 7X0221
7X0217, # 7X0223

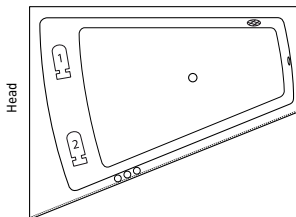

7X0264, # 7X0266, # 7X0268

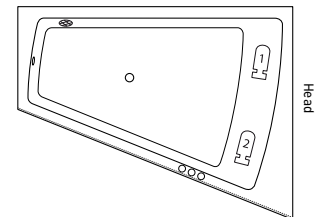

7X0265, # 7X0267, # 7X0269

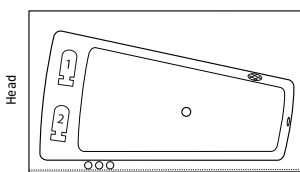

7X0270

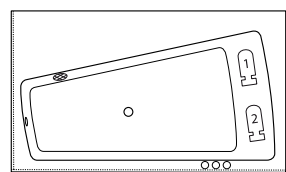

7X0271

Whirlsystems product information

PuraVida

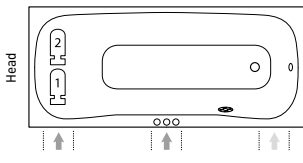

7X0181

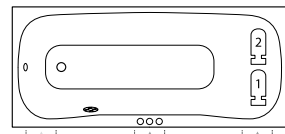

7X0198

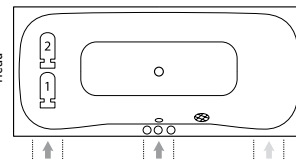

7X0182, # 7X0183

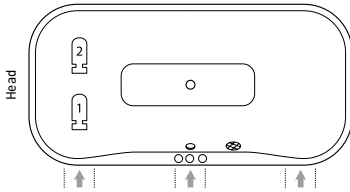

7X0184

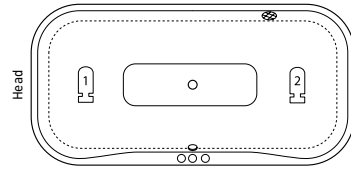

7X0185

Starck

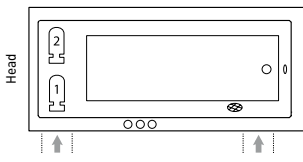

7X0050, # 7X0331, # 7X0332,
7X0333, # 7X0334, # 7X0335,
7X0336, # 7X0337

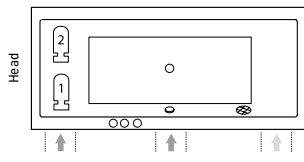

7X0052, # 7X0338, # 7X0339,
7X0340, # 7X0341

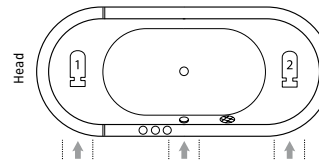

7X0009

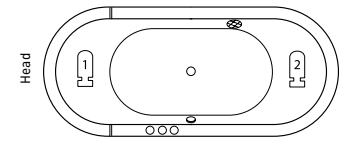

7X0010

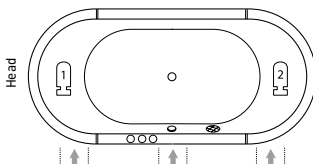

7X0011

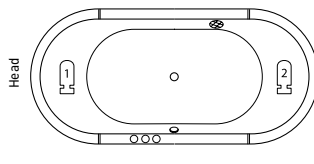

7X0012

Vero

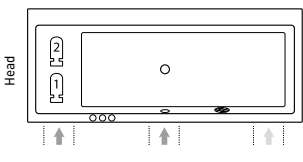

7X0133

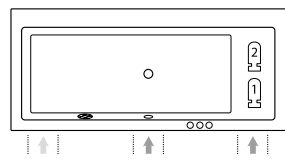

7X0134

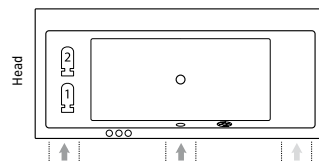

7X0135, # 7X0136

Whirlsystems product information

Sundeck

With panel

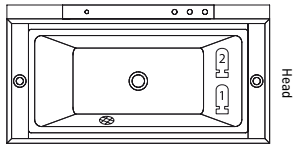

7X0066, # 7X0128

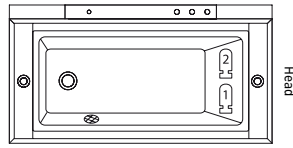

7X0127

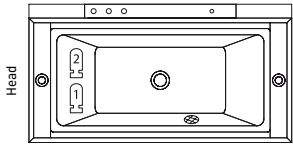

7X0066, # 7X0128

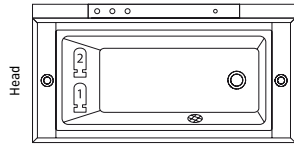

7X0127

Positioning of the control panel on the pillar

Panel for freestanding version, corner right and back-to-wall version:

The figures show the standard configuration of the whirlsystem with the positioning of the control panel (see Fig.). At the head side are the back jets (depending on the whirlsystem). Custom version on request. Please send us a sketch showing the desired layout. Duravit will check and wherever possible confirm the feasibility.

Panel for corner left:

The figures show the standard configuration of the whirlsystem with the positioning of the control panel (see Fig.). At the head side are the back jets (depending on the whirlsystem). Custom version on request. Please send us a sketch showing the desired layout. Duravit will check and wherever possible confirm the feasibility.

Drill holes for taps on the pillar:

On request, drill holes can be made at the factory for base plates for rim-mounted tap fittings. Please state the desired base plate when ordering. Duravit can supply a list of suitable pre-punched sets on request.

With rail-mount system

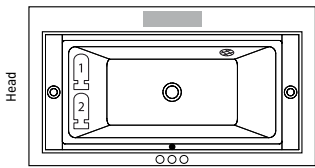

7X0065, # 7X0126

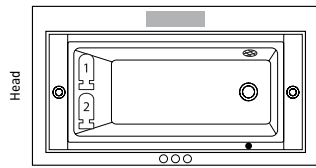

7X0125

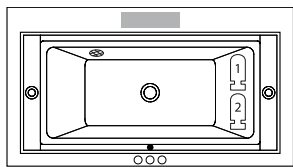

7X0065, # 7X0126

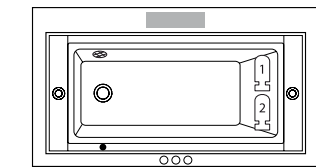

7X0125

Positioning of the control panel on tiled rim:

The figures show the standard configuration of the whirlsystem with the positioning of the control panel, placed in the middle of the front tiled rim. The pull button to operate the waste is always on the same side as the control panel (see Fig.). At the head side are the back jets (depending on the whirlsystem).

Custom version on request (see Fig.). Please make a note when ordering.

Legend



Unit 1



Unit 2*



Control panel**



Suction screen



Pull button



Tap module



Recommended
equipment covers



Recommended
equipment covers***

*only Combi-Systems / ** The number of control panels is determined by the whirlsystem and the additional modules selected / *** Only necessary for Combi-System E/L in combination with Sound and/or LED coloured light / Air-System, Jet-System, Combi-System P, Combi-System E and Durapearl-System: 76..., Combi-System L: 71...

Antislip product information

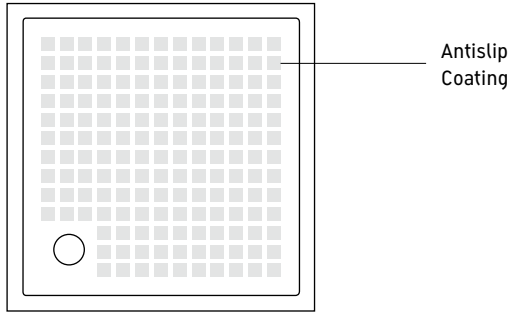

Shower tray Antislip coating. This transparent yet perceptible Antislip coating increases grip in the tray and ensures a higher degree of safety when showering. Antislip is applied ex factory. Long-lasting, easy to clean, environmentally friendly and approved by the TÜV (German Technical Inspection Association), Antislip is suitable for both private homes and the hotel industry.

TÜV Rheinland confirms Quality Class B for bare foot areas exposed to water (DIN 51097 / DIN EN 13845).

Antislip can be ordered for all Duravit shower trays – D-Code, DuraPlan, PuraVida, Starck Slimline and Inipi Ama.

When ordering a shower tray with Antislip, please give the correct details by simply adding a "1" at the last digit of the item code.

7 2 0 1 1 5 0 0 0 0 0 0 1

Antislip

2x3 Design by Duravit

Bathtub hexagon, built-in 5 mm sanitary acrylic

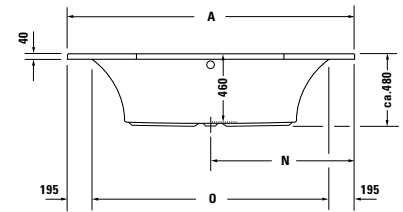
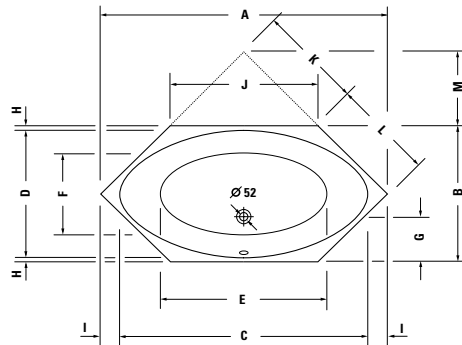

	A	B	C	D	E	F	G	H	I	J	K	L	M	N	O
700023	1900	900	1640	840	1100	500	270	30	130	1000	707	637	500	950	1510
700024	2000	1000	1700	940	1200	630	315	30	150	1000	707	707	500	1000	1610

Length mm	Width mm	Depth mm	Capacity l	Weight kg	Model-No.	Euro
						White - 00
Bathtub						
1900	900	460	145	37,0	700023 00 0 00 0000	
2000	1000	460	165	43,0	700024 00 0 00 0000	
Surcharge for whirlsystem						
Air-System					760*** 00 1 00 1000	
Jet-System					760*** 00 2 00 1000	
Combi-System P					760*** 00 3 00 1000	
Combi-System E					760*** 00 4 16 1000	
Combi-System L					710*** 00 5 00 1000	
Additional modules for whirltub						
Additional modules for Combi-System E				Module-No.		
LED coloured light (replaces LED white light)				06		
Heating				07		
UV Hygiene Management				08		
Additional modules for Combi-System L				Module-No.		
LED coloured light (replaces white light)				06		
Temperature L				07		
UV Hygiene Management				08		
Accessories for bath- and whirltub						
Bathtub anchors					790103 00 0 00 0000	
Rubber profile					790104 00 0 00 0000	
Accessories for bathtub						
Support frame, for bathtubs and shower trays, with length > 1000 mm					790100 00 0 00 0000	
Waste and overflow Quadroval, chrome					790287 00 0 00 1000	
Waste and overflow Quadroval, with water inlet, chrome					790288 00 0 00 1000	
Support, for # 700023					790418 00 0 00 0000	
Support, for # 700024					790419 00 0 00 0000	
LED coloured light, with remote control for bathtubs, (white -00, chrome -10)					790840 00 0 00 * 00	
Sound					791851 00 0 00 0000	
continued on following page						



2x3 Design by Duravit

Bathtub hexagon, built-in 5 mm sanitary acrylic

Length mm	Width mm	Depth mm	Capacity l	Weight kg	Model-No.	Euro	
						White	- 00
Bathtub							
1900	900	460	145	37,0	700023 00 0 00 0000		
2000	1000	460	165	43,0	700024 00 0 00 0000		
Accessories for whirltub							
Surcharge, for waste and overflow Quadroval, with water inlet, chrome					791205 00 0 00 1000		
LED coloured light, for whirltubs with Air-System, Jet-System, Combi-System P, Durapearl-System or Jet Project					791850 00 0 00 1000		
Sound, for whirltubs with Air-System, Jet-System, Combi-System P, Durapearl-System or Jet Project					791852 00 0 00 0000		
Sound, for whirltubs with Combi-System E					791853 00 0 00 0000		

Infobox: LED coloured light or sound is not suitable for bathtubs with support

2x3 Accessories Design by Duravit

Description	Model-No.	Euro
 <p>Waste and overflow Quadroval chrome, for 2x3 bathtubs outlet diameter 52 mm</p>	790287 00 0 00 1000	
 <p>Waste and overflow Quadroval with water inlet, chrome, for 2x3 bathtubs, (pipe interrupt necessary) outlet diameter 52 mm</p>	790288 00 0 00 1000	

2nd floor Design by sieger design

Product Information

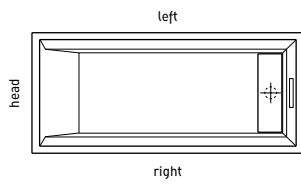

single-seat bathtubs

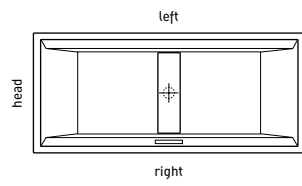

twin-seat bathtubs

Positioning the flood spout (optional)

The flood spout location depends on the position of a person using the bath (see illustration). For single-seat baths the flood spout can be located on the left or right side, in the centre of the bath. For twin-seat baths the flood spout is fitted opposite the overflow.

All 2nd floor bathtubs incl. special drain kit in chrome.

2nd floor Design by sieger design

Bathtub rectangle, built-in, with special waste and overflow
5 mm sanitary acrylic

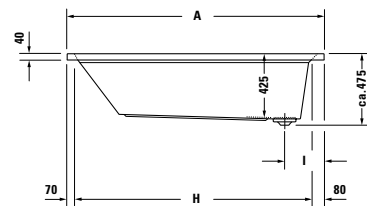
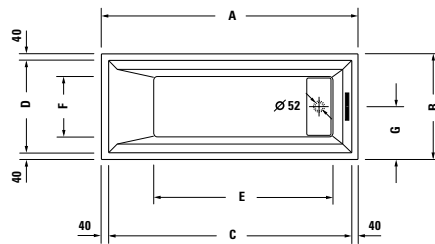

	A	B	C	D	E	F	G	H	I
700074	1700	700	1620	620	1190	400	350	1550	260
700075	1700	750	1620	670	1190	450	375	1550	280

Length mm	Width mm	Depth mm	Capacity l	Weight kg	Model-No.	Euro
						White - 00
Bathtub						
1700	700	430	190	28,0	700074 00 0 00 0000	
1700	750	430	205	33,0	700075 00 0 00 0000	
Surcharge for whirlsystem						
Air-System					760*** 00 1 00 1000	
Jet-System					760*** 00 2 00 1000	
Combi-System P					760*** 00 3 00 1000	
Combi-System E					760*** 00 4 16 1000	
Combi-System L					710*** 00 5 00 1000	
Additional modules for whirltub						
Additional modules for Combi-System E				Module-No.		
LED coloured light (replaces LED white light)				06		
Heating				07		
UV Hygiene Management				08		
Additional modules for Combi-System L				Module-No.		
LED coloured light (replaces white light)				06		
Temperature L				07		
UV Hygiene Management				08		
Accessories for bath- and whirltub						
Bathtub anchors					790103 00 0 00 0000	
Rubber profile					790104 00 0 00 0000	
Flood spout, left					790215 00 0 00 1000	
Flood spout, right					790216 00 0 00 1000	
Connection hose, for flood spout					790131 00 0 00 0000	

continued on following page

2nd floor Design by sieger design

Bathtub rectangle, built-in, with special waste and overflow
5 mm sanitary acrylic

Length mm	Width mm	Depth mm	Capacity l	Weight kg	Model-No.	Euro	
						White	- 00
Bathtub							
1700	700	430	190	28,0	700074 00 0 00 0000		
1700	750	430	205	33,0	700075 00 0 00 0000		
Accessories for bathtub							
Support frame, for bathtubs and shower trays, with length > 1000 mm					790100 00 0 00 0000		
Support, for # 700074					790455 00 0 00 0000		
Support, for # 700075					790456 00 0 00 0000		
LED coloured light, with remote control for bathtubs, (white -00, chrome -10)					790840 00 0 00 * 00		
Sound					791851 00 0 00 0000		
Suitable tub covers s.p. 510/511							
Accessories for whirltub							
LED coloured light, for whirltubs with Air-System, Jet-System, Combi-System P, Durapearl-System or Jet Project					791850 00 0 00 1000		
Sound, for whirltubs with Air-System, Jet-System, Combi-System P, Durapearl-System or Jet Project					791852 00 0 00 0000		
Sound, for whirltubs with Combi-System E					791853 00 0 00 0000		

Infobox: Connection hose 1/2" inside thread is necessary for flood spout / A pipe interrupt is necessary for the flood spout / LED coloured light or sound is not suitable for bathtubs with support / Bathtub incl. special drain kit, chrome

2nd floor Design by sieger design

Bathtub with support frame rectangle, for panel, with special waste and overflow
5 mm sanitary acrylic

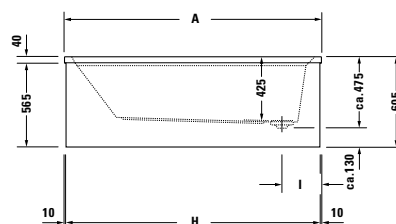
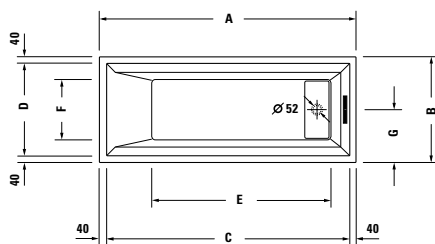

	A	B	C	D	E	F	G	H	I
700079	1700	700	1620	620	1190	400	350	1680	260
700080	1700	750	1620	670	1190	450	375	1680	280

Length mm	Width mm	Depth mm	Capacity l	Weight kg	Model-No.	Euro
						White - 00
Bathtub with support frame						
1700	700	430	190	31,0	700079 00 0 00 0000	
1700	750	430	205	36,0	700080 00 0 00 0000	
Surcharge for whirlsystem						
Air-System					760*** 00 1 00 1000	
Jet-System					760*** 00 2 00 1000	
Combi-System P					760*** 00 3 00 1000	
Combi-System E					760*** 00 4 16 1000	
Combi-System L					710*** 00 5 00 1000	
Additional modules for whirltub						
Additional modules for Combi-System E				Module-No.		
LED coloured light (replaces LED white light)				06		
Heating				07		
UV Hygiene Management				08		
Additional modules for Combi-System L				Module-No.		
LED coloured light (replaces white light)				06		
Temperature L				07		
UV Hygiene Management				08		
Necessary accessories for bath- and whirltub						
Suitable panels s.p. 267						
Accessories for bath- and whirltub						
Bathtub anchors					790103 00 0 00 0000	
Rubber profile					790104 00 0 00 0000	
Flood spout, left					790215 00 0 00 1000	
Flood spout, right					790216 00 0 00 1000	
Connection hose, for flood spout					790131 00 0 00 0000	

continued on following page

2nd floor Design by sieger design

Bathtub with support frame rectangle, for panel, with special waste and overflow
5 mm sanitary acrylic

Length mm	Width mm	Depth mm	Capacity l	Weight kg	Model-No.	Euro	
						White	- 00
Bathtub with support frame							
1700	700	430	190	31,0	700079 00 0 00 0000		
1700	750	430	205	36,0	700080 00 0 00 0000		
Accessories for bathtub							
LED coloured light, with remote control for bathtubs, (white -00, chrome -10)					790840 00 0 00 * 00		
Sound					791851 00 0 00 0000		
Suitable tub covers s.p. 510/511							
Accessories for whirltub							
LED coloured light, for whirltubs with Air-System, Jet-System, Combi-System P, Durapearl-System or Jet Project					791850 00 0 00 1000		
Sound, for whirltubs with Air-System, Jet-System, Combi-System P, Durapearl-System or Jet Project					791852 00 0 00 0000		
Sound, for whirltubs with Combi-System E					791853 00 0 00 0000		

Infobox: Connection hose 1/2" inside thread is necessary for flood spout / A pipe interrupt is necessary for the flood spout / Bathtub incl. special drain kit, chrome

2nd floor Design by sieger design

Bathtub rectangle, built-in, with special waste and overflow

5 mm sanitary acrylic

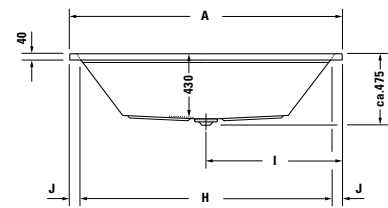
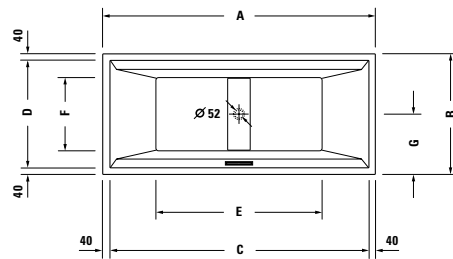

	A	B	C	D	E	F	G	H	I	J
700076	1800	800	1720	720	1100	485	400	1690	900	55
700160	1900	900	1820	820	1205	610	450	1790	950	55
700161	2000	1000	1920	920	1305	710	500	1890	1000	55

Length mm	Width mm	Depth mm	Capacity l	Weight kg	Model-No.	Euro
						White - 00
Bathtub						
1800	800	430	240	34,0	700076 00 0 00 0000	
1900	900	430	280	40,0	700160 00 0 00 0000	
2000	1000	430	320	42,0	700161 00 0 00 0000	
Surcharge for whirlsystem						
Air-System					760*** 00 1 00 1000	
Jet-System					760*** 00 2 00 1000	
Combi-System P					760*** 00 3 00 1000	
Combi-System E					760*** 00 4 16 1000	
Combi-System L					710*** 00 5 00 1000	
Additional modules for whirltub						
Additional modules for Combi-System E				Module-No.		
LED coloured light (replaces LED white light)				06		
Heating				07		
UV Hygiene Management				08		
Additional modules for Combi-System L				Module-No.		
LED coloured light (replaces white light)				06		
Temperature L				07		
UV Hygiene Management				08		
Accessories for bath- and whirltub						
Bathtub anchors					790103 00 0 00 0000	
Rubber profile					790104 00 0 00 0000	
Flood spout, left					790215 00 0 00 1000	
Connection hose, for flood spout					790131 00 0 00 0000	

continued on following page

2nd floor Design by sieger design

Bathtub rectangle, built-in, with special waste and overflow
5 mm sanitary acrylic

Length mm	Width mm	Depth mm	Capacity l	Weight kg	Model-No.	Euro	
						White	- 00
Bathtub							
1800	800	430	240	34,0	700076 00 0 00 0000		
1900	900	430	280	40,0	700160 00 0 00 0000		
2000	1000	430	320	42,0	700161 00 0 00 0000		
Accessories for bathtub							
Support frame, for bathtubs and shower trays, with length > 1000 mm					790100 00 0 00 0000		
Support, for # 700076					790457 00 0 00 0000		
Support, for # 700160					791404 00 0 00 0000		
Support, for # 700161					791405 00 0 00 0000		
LED coloured light, with remote control for bathtubs, (white -00, chrome -10)					790840 00 0 00 * 00		
Sound					791851 00 0 00 0000		
Suitable tub covers s.p. 510/511							
Accessories for whirltub							
LED coloured light, for whirltubs with Air-System, Jet-System, Combi-System P, Durapearl-System or Jet Project					791850 00 0 00 1000		
Sound, for whirltubs with Air-System, Jet-System, Combi-System P, Durapearl-System or Jet Project					791852 00 0 00 0000		
Sound, for whirltubs with Combi-System E					791853 00 0 00 0000		

Infobox: Connection hose 1/2" inside thread is necessary for flood spout / A pipe interrupt is necessary for the flood spout / LED coloured light or sound is not suitable for bathtubs with support / Bathtub incl. special drain kit, chrome

2nd floor Design by sieger design

Bathtub with support frame rectangle, for panel, with special waste and overflow 5 mm sanitary acrylic

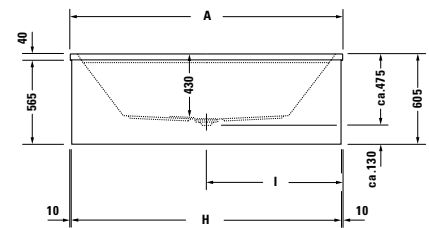
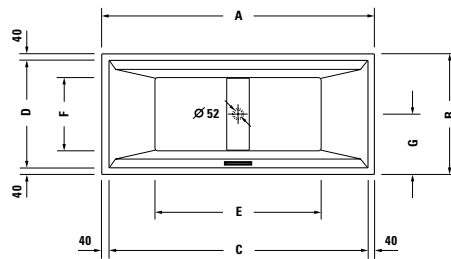

	A	B	C	D	E	F	G	H	I
700081	1800	800	1720	720	1100	485	400	1780	900
700162	1900	900	1820	820	1205	610	450	1880	950
700163	2000	1000	1920	920	1305	710	500	1980	1000

Length mm	Width mm	Depth mm	Capacity l	Weight kg	Model-No.	Euro
						White - 00
Bathtub with support frame						
1800	800	430	240	37,0	700081 00 0 00 0000	
1900	900	430	280	43,0	700162 00 0 00 0000	
2000	1000	430	320	45,0	700163 00 0 00 0000	
Surcharge for whirlsystem						
Air-System					760*** 00 1 00 1000	
Jet-System					760*** 00 2 00 1000	
Combi-System P					760*** 00 3 00 1000	
Combi-System E					760*** 00 4 16 1000	
Combi-System L					710*** 00 5 00 1000	
Additional modules for whirltub						
Additional modules for Combi-System E				Module-No.		
LED coloured light (replaces LED white light)				06		
Heating				07		
UV Hygiene Management				08		
Additional modules for Combi-System L				Module-No.		
LED coloured light (replaces white light)				06		
Temperature L				07		
UV Hygiene Management				08		
Necessary accessories for bath- and whirltub						
Suitable panels s.p. 267						
Accessories for bath- and whirltub						
Bathtub anchors					790103 00 0 00 0000	
Rubber profile					790104 00 0 00 0000	
Flood spout, left					790215 00 0 00 1000	
Connection hose, for flood spout					790131 00 0 00 0000	

continued on following page



2nd floor Design by sieger design

Bathtub with support frame rectangle, for panel, with special waste and overflow
5 mm sanitary acrylic

Length mm	Width mm	Depth mm	Capacity l	Weight kg	Model-No.	Euro	
						White	- 00
Bathtub with support frame							
1800	800	430	240	37,0	700081 00 0 00 0000		
1900	900	430	280	43,0	700162 00 0 00 0000		
2000	1000	430	320	45,0	700163 00 0 00 0000		
Accessories for bathtub							
LED coloured light, with remote control for bathtubs, (white -00, chrome -10)					790840 00 0 00 * *00		
Sound					791851 00 0 00 0000		
Suitable tub covers s.p. 510/511							
Accessories for whirltub							
LED coloured light, for whirltubs with Air-System, Jet-System, Combi-System P, Durapearl-System or Jet Project					791850 00 0 00 1000		
Sound, for whirltubs with Air-System, Jet-System, Combi-System P, Durapearl-System or Jet Project					791852 00 0 00 0000		
Sound, for whirltubs with Combi-System E					791853 00 0 00 0000		

Infobox: Connection hose 1/2" inside thread is necessary for flood spout / A pipe interrupt is necessary for the flood spout / Bathtub incl. special drain kit, chrome

2nd floor Accessories Design by sieger design

Description	Model-No.	Euro
 Flood spout		
for 2nd floor bath- and whirltubs,		
(pipe interrupt necessary)		
left	790215 00 0 00 1000	
right	790216 00 0 00 1000	
Infobox: Connection hose 1/2" inside thread is necessary for flood spout / A pipe interrupt is necessary for the flood spout		
 Connection hose		
for flood spout,		
1/2" inside thread x 3/4" outside thread		
length: 1000 mm	790131 00 0 00 0000	

2nd floor Design by sieger design

Panels for bath- and whirtubs



1700 x 700 mm



700079



1700 x 750 mm



700080

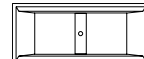

1800 x 800 mm



700081



1900 x 900 mm



700162

Model-No. panel

	Corner left	# 2F 8786	# 2F 8787	# 2F 8788	# 2F 8906
	Corner right	# 2F 8781	# 2F 8782	# 2F 8783	# 2F 8904
	Back-to-wall	# 2F 8776	# 2F 8777	# 2F 8778	# 2F 8902
	Niche	# 2F 8938	# 2F 8938	# 2F 8939	# 2F 8941
	Freestanding		# 2F 8772	# 2F 8773	# 2F 8900

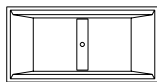

2000 x 1000 mm



700163

	Corner left	# 2F 8907			
	Corner right	# 2F 8905			
	Back-to-wall	# 2F 8903			
	Niche	# 2F 8942			
	Freestanding	# 2F 8901			

2nd floor Design by sieger design

Product Information

Panel	Decor (Pricegroup 1)	67 Rosewood	High-density-fiberboard, with laminate (HPL) pressed on both sides. Surfaces resistant to moisture.
	Acryl (Pricegroup 1)	82 Acrylic White	8 mm Acryl solid-coloured in white
	Real wood veneer (Pricegroup 2)	65 Bleached Oak	High-density-fiberboard, with real wood veneer pressed on one side and laminate (HPL) pressed on other side. Real wood veneer is a natural material, differences in colour and structure may occur. Surfaces resistant to moisture.
	Real wood veneer (Pricegroup 3)	59 Ebony 62 Anthracite Oak	High-density-fiberboard, with real wood veneer pressed on one side and laminate (HPL) pressed on other side. Real wood veneer is a natural material, differences in colour and structure may occur. Surfaces resistant to moisture.

2nd floor Design by sieger design

Description	mm	Model-No.	Euro		
			Pricegroup 1	Pricegroup 2	Pricegroup 3
Panel					
for corner left					
for # 700079 (1700 x 700 mm)	1690 x 690	2F 8786			
for # 700080 (1700 x 750 mm)	1690 x 740	2F 8787			
for # 700081 (1800 x 800 mm)	1790 x 790	2F 8788			
for # 700162 (1900 x 900 mm)	1890 x 890	2F 8906			
for # 700163 (2000 x 1000 mm)	1990 x 990	2F 8907			
Panel					
for corner right					
for # 700079 (1700 x 700 mm)	1690 x 690	2F 8781			
for # 700080 (1700 x 750 mm)	1690 x 740	2F 8782			
for # 700081 (1800 x 800 mm)	1790 x 790	2F 8783			
for # 700162 (1900 x 900 mm)	1890 x 890	2F 8904			
for # 700163 (2000 x 1000 mm)	1990 x 990	2F 8905			
Panel					
for back-to-wall version					
for # 700079 (1700 x 700 mm)	1680 x 690	2F 8776			
for # 700080 (1700 x 750 mm)	1680 x 740	2F 8777			
for # 700081 (1800 x 800 mm)	1780 x 790	2F 8778			
for # 700162 (1900 x 900 mm)	1880 x 890	2F 8902			
for # 700163 (2000 x 1000 mm)	1980 x 990	2F 8903			
Panel					
for freestanding version					
for # 700080 (1700 x 750 mm)	1680 x 730	2F 8772			
for # 700081 (1800 x 800 mm)	1780 x 780	2F 8773			
for # 700162 (1900 x 900 mm)	1880 x 880	2F 8900			
for # 700163 (2000 x 1000 mm)	1980 x 980	2F 8901			
Panel					
for niche					
for # 700079 (1700 x 700 mm)	1690	2F 8938			
for # 700080 (1700 x 750 mm)	1690	2F 8938			
for # 700081 (1800 x 800 mm)	1790	2F 8939			
for # 700162 (1900 x 900 mm)	1890	2F 8941			
for # 700163 (2000 x 1000 mm)	1990	2F 8942			

Blue Moon Design by Jochen Schmiedem

Ordering sample

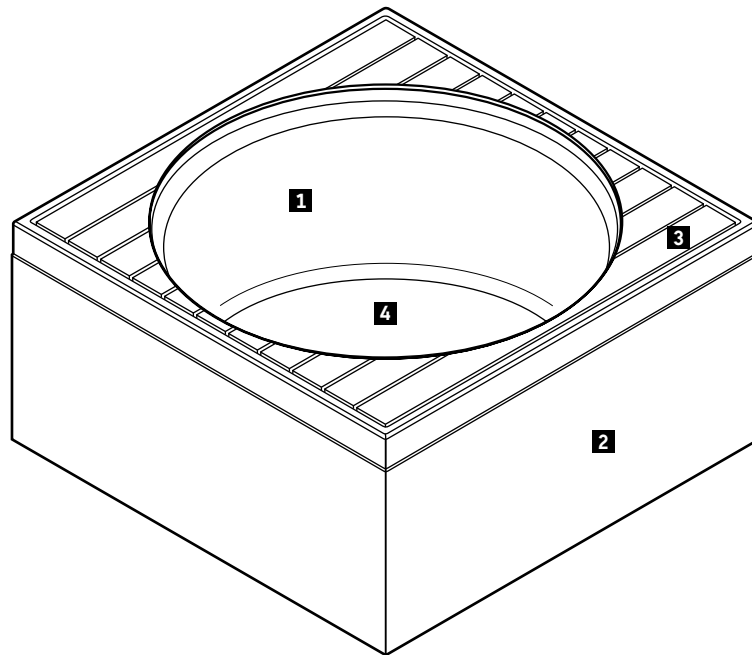

Description	Remark	Quantity	Model-No.
1 Bathtub	1800 x 1800 mm	1	# 700169 00 0 00 0000
2 Panel	1796 x 1796 x 600 mm	1	# 701061 00 0 00 0000
3 Wooden inlay Teak (real wood)	1650 x 1650 mm	1	# 790866 00 0 00 0000
4 Special waste and overflow		1	# 790247 00 0 00 1000

Blue Moon Design by Jochen Schmiedem

Bathtub built-in square, with support frame, with overflow

5 mm sanitary acrylic

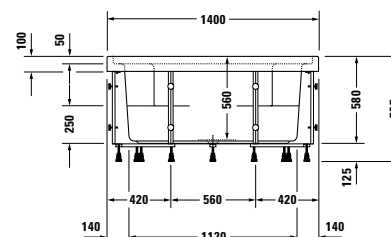
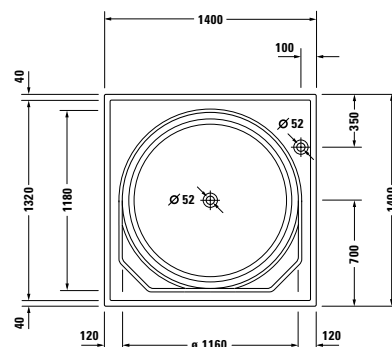

Length mm	Width mm	Depth mm	Capacity l	Weight kg	Model-No.	Euro
						White - 00
Bathtub built-in						
1400	1400	560	520	70,0	700143 00 0 00 0000	
Surcharge for whirlsystem						
Combi-System E					760*** 00 4 16 1000	
Combi-System L					710*** 00 5 00 1000	
Additional modules for whirltub						
Additional modules for Combi-System E				Module-No.		
LED coloured light (replaces LED white light)				06		
Heating				07		
UV Hygiene Management				08		
Additional modules for Combi-System L				Module-No.		
LED coloured light (replaces white light)				06		
Temperature L				07		
UV Hygiene Management				08		
Necessary accessories for bath- and whirltub						
Wooden inlay, Teak (real wood), with hinged cover					790851 00 0 02 0000	
Acrylic inlay, with hinged cover					790852 00 0 02 0000	
Necessary accessories for bathtub						
Special waste and overflow, chrome					790236 00 0 00 1000	
Special waste and overflow, with base inlet, chrome ****					791233 00 0 00 1000	
Wooden inlay, Teak (real wood)					790851 00 0 00 0000	
Acrylic inlay					790852 00 0 00 0000	
Accessories for bath- and whirltub						
Headrest, white					790003 00 0 00 0000	
Rubber profile					790104 00 0 00 0000	
Bathtub anchors, (4 pcs.) *					790123 00 0 00 0000	
Tub cover					790883 00 0 00 0000	
Bench / support rail, Teak (real wood)					790855 00 0 00 0000	
Bench / support rail, Teak (real wood), with clothes rail					790856 00 0 00 0000	
Bench / support rail, Teak (real wood), with handhold					790857 00 0 00 0000	
Bench / support rail, Teak (real wood), with clothes rail, with handhold					790858 00 0 00 0000	
Accessories for bathtub						
LED coloured light, with remote control for bathtubs, (white -00, chrome -10)					790846 00 0 00 * 00	
Sound					791851 00 0 00 0000	
Accessories for whirltub						
Surcharge, for waste and overflow, with base inlet, chrome ****					791234 00 0 00 1000	
Sound, for whirltubs with Combi-System E					791853 00 0 00 0000	

Infobox: * We recommend to use 4 bathtub anchors for the installation / **** assembled, pipe interrupt mandatory, wooden or acrylic inlay with hinged cover required / If you order the waste and overflow # 790236 00 0 00 1000 for bathtub please select the wooden inlay # 790851 00 0 00 0000 or the acrylic inlay # 790852 00 0 00 0000 / If you order the waste and overflow with base inlet # 791233 00 0 00 1000 for bathtub please select the wooden inlay with hinged cover # 790851 00 0 02 0000 or the acrylic inlay with hinged cover # 790852 00 0 02 0000. The turning handle for the operation of the base inlet is positioned under the hinged cover

Blue Moon Design by Jochen Schmiedem

Bathtub with support frame for panel square, with overflow

5 mm sanitary acrylic

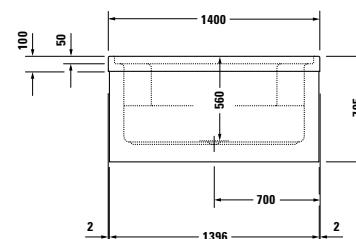
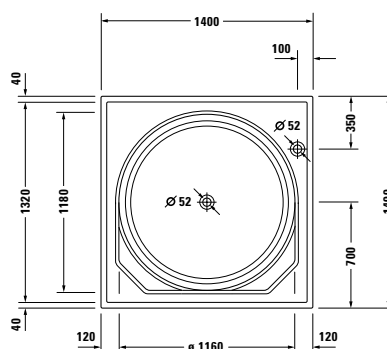

Length mm	Width mm	Depth mm	Capacity l	Weight kg	Model-No.	Euro
						White - 00
Bathtub with support frame for panel						
1400	1400	560	520	70,0	700143 00 0 00 0000	
Surcharge for whirlsystem						
Combi-System E					760*** 00 4 16 1000	
Combi-System L					710*** 00 5 00 1000	
Additional modules for whirltub						
Additional modules for Combi-System E				Module-No.		
LED coloured light (replaces LED white light)				06		
Heating				07		
UV Hygiene Management				08		
Additional modules for Combi-System L				Module-No.		
LED coloured light (replaces white light)				06		
Temperature L				07		
UV Hygiene Management				08		
Necessary accessories for bath- and whirltub						
Wooden inlay, Teak (real wood), with hinged cover					790851 00 0 02 0000	
Acrylic inlay, with hinged cover					790852 00 0 02 0000	
Acrylic panel, for corner left / right					701022 00 0 00 0000	
Acrylic panel, for back-to-wall version					701023 00 0 00 0000	
Acrylic panel, for freestanding version					701024 00 0 00 0000	
Suitable panels s.p. 280						
Necessary accessories for bathtub						
Special waste and overflow, chrome					790236 00 0 00 1000	
Special waste and overflow, with base inlet, chrome ****					791233 00 0 00 1000	
Wooden inlay, Teak (real wood)					790851 00 0 00 0000	
Acrylic inlay					790852 00 0 00 0000	
Accessories for bath- and whirltub						
Headrest, white					790003 00 0 00 0000	
Rubber profile					790104 00 0 00 0000	
Bathtub anchors, (4 pcs.) *					790123 00 0 00 0000	
Tub cover					790883 00 0 00 0000	
Bench / support rail, Teak (real wood)					790855 00 0 00 0000	
Bench / support rail, Teak (real wood), with clothes rail					790856 00 0 00 0000	
Bench / support rail, Teak (real wood), with handhold					790857 00 0 00 0000	
Bench / support rail, Teak (real wood), with clothes rail, with handhold					790858 00 0 00 0000	
Accessories for bathtub						
Storage holder for tub cover, for Blue Moon bathtubs, left					790881 00 0 00 6600	
Storage holder for tub cover, for Blue Moon bathtubs, right					790882 00 0 00 6600	
LED coloured light, with remote control for bathtubs, (white -00, chrome -10)					790846 00 0 00 * 00	
Sound					791851 00 0 00 0000	

continued on following page

Blue Moon Design by Jochen Schmiedem

Bathtub with support frame for panel square, with overflow
5 mm sanitary acrylic

Length mm	Width mm	Depth mm	Capacity l	Weight kg	Model-No.	Euro
						White - 00
Bathtub with support frame for panel						
1400	1400	560	520	70,0	700143 00 0 00 0000	
Accessories for whirltub						
Surcharge, for waste and overflow, with base inlet, chrome ****					791234 00 0 00 1000	
Sound, for whirltubs with Combi-System E					791853 00 0 00 0000	
Storage holder for tub cover, for Blue Moon whirltubs and pools, left					791805 00 0 00 6600	
Storage holder for tub cover, for Blue Moon whirltubs and pools, right					791806 00 0 00 6600	

Infobox: * We recommend to use 4 bathtub anchors for the installation / **** assembled, pipe interrupt mandatory, wooden or acrylic inlay with hinged cover required / If you order the waste and overflow # 790236 00 0 00 1000 for bathtub please select the wooden inlay # 790851 00 0 00 0000 or the acrylic inlay # 790852 00 0 00 0000 / If you order the waste and overflow with base inlet # 791233 00 0 00 1000 for bathtub please select the wooden inlay with hinged cover # 790851 00 0 02 0000 or the acrylic inlay with hinged cover # 790852 00 0 02 0000. The turning handle for the operation of the base inlet is positioned under the hinged cover

Blue Moon Design by Jochen Schmiedem

Bathtub built-in square, with support frame, with overflow
5 mm sanitary acrylic

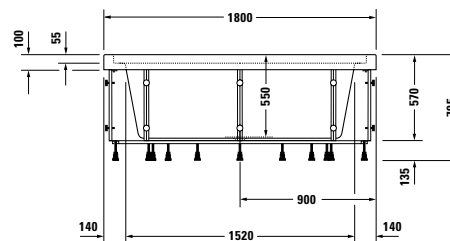
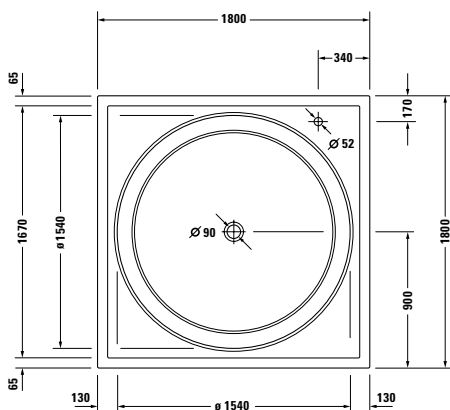

Length mm	Width mm	Depth mm	Capacity l	Weight kg	Model-No.	Euro
						White - 00
Bathtub built-in						
1800	1800	550	730	115,5	700169 00 0 00 0000	
Necessary accessories for bathtub						
Special waste and overflow, chrome					790247 00 0 00 1000	
Wooden inlay, Teak (real wood)					790866 00 0 00 0000	
Acrylic inlay					790867 00 0 00 0000	
Special waste and overflow, with base inlet, chrome ****					791236 00 0 00 1000	
Wooden inlay, Teak (real wood), with hinged cover					790866 00 0 01 0000	
Acrylic inlay, with hinged cover					790867 00 0 01 0000	
Accessories for bathtub						
Headrest, white					790004 00 0 00 0000	
Rubber profile					790104 00 0 00 0000	
Bathtub anchors, (4 pcs.) *					790123 00 0 00 0000	
Footrest, length 180 mm					790885 00 0 00 0000	
Footrest, length 250 mm					790886 00 0 00 0000	
Tub cover					790884 00 0 00 0000	
LED coloured light, with remote control for bathtubs, (white -00, chrome -10)					790846 00 0 00 * 00	
Sound					791851 00 0 00 0000	
Bench / support rail, Teak (real wood)					790868 00 0 00 0000	
Bench / support rail, Teak (real wood), with clothes rail					790869 00 0 00 0000	
Bench / support rail, Teak (real wood), with handhold					790870 00 0 00 0000	
Bench / support rail, Teak (real wood), with clothes rail, with handhold					790871 00 0 00 0000	

Infobox: * We recommend to use 4 bathtub anchors for the installation / **** assembled, pipe interrupt mandatory, wooden or acrylic inlay with hinged cover required / If you order the waste and overflow # 790247 00 0 00 1000 please select the wooden inlay # 790866 00 0 00 0000 or the acrylic inlay # 790867 00 0 00 0000 / The length of the rubber profile # 790104 is not sufficient for Blue Moon 1800 x 1800 mm. Please use two pieces / If you order the waste and overflow with base inlet # 791236 00 0 00 1000 please select the wooden inlay with hinged cover # 790866 00 0 01 0000 or the acrylic inlay with hinged cover # 790867 00 0 01 0000. The turning handle for the operation of the base inlet is positioned under the hinged cover

Blue Moon Design by Jochen Schmiedem

Bathtub with support frame for panel square, with overflow



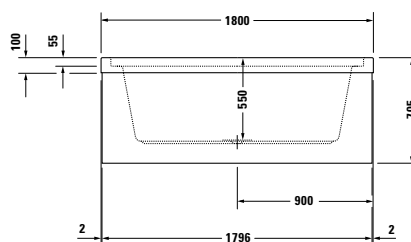
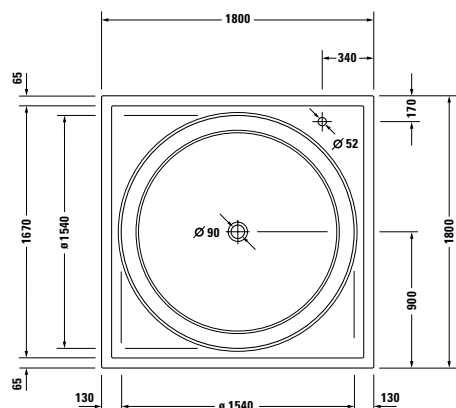

5 mm sanitary acrylic









Length mm	Width mm	Depth mm	Capacity l	Weight kg	Model-No.	Euro
						White - 00
Bathtub with support frame for panel						
1800	1800	550	730	115,5	700169 00 0 00 0000	
Necessary accessories for bathtub						
Special waste and overflow, chrome					790247 00 0 00 1000	
Wooden inlay, Teak (real wood)					790866 00 0 00 0000	
Acrylic inlay					790867 00 0 00 0000	
Special waste and overflow, with base inlet, chrome ****					791236 00 0 00 1000	
Wooden inlay, Teak (real wood), with hinged cover					790866 00 0 01 0000	
Acrylic inlay, with hinged cover					790867 00 0 01 0000	
Acrylic panel, for corner left / right					701059 00 0 00 0000	
Acrylic panel, for back-to-wall version					701060 00 0 00 0000	
Acrylic panel, for freestanding version					701061 00 0 00 0000	
Suitable panels s.p. 280						
Accessories for bathtub						
Headrest, white					790004 00 0 00 0000	
Rubber profile					790104 00 0 00 0000	
Bathtub anchors, (4 pcs.) *					790123 00 0 00 0000	
Footrest, length 180 mm					790885 00 0 00 0000	
Footrest, length 250 mm					790886 00 0 00 0000	
Tub cover					790884 00 0 00 0000	
Storage holder for tub cover, for Blue Moon bathtubs, left					790881 00 0 00 6600	
Storage holder for tub cover, for Blue Moon bathtubs, right					790882 00 0 00 6600	
LED coloured light, with remote control for bathtubs, (white -00, chrome -10)					790846 00 0 00 * 00	
Sound					791851 00 0 00 0000	
Bench / support rail, Teak (real wood)					790868 00 0 00 0000	
Bench / support rail, Teak (real wood), with clothes rail					790869 00 0 00 0000	
Bench / support rail, Teak (real wood), with handhold					790870 00 0 00 0000	
Bench / support rail, Teak (real wood), with clothes rail, with handhold					790871 00 0 00 0000	

Infobox: * We recommend to use 4 bathtub anchors for the installation / **** assembled, pipe interrupt mandatory, wooden or acrylic inlay with hinged cover required / If you order the waste and overflow # 790247 00 0 00 1000 please select the wooden inlay # 790866 00 0 00 0000 or the acrylic inlay # 790867 00 0 00 0000 / The length of the rubber profile # 790104 is not sufficient for Blue Moon 1800 x 1800 mm. Please use two pieces / If you order the waste and overflow with base inlet # 791236 00 0 00 1000 please select the wooden inlay with hinged cover # 790866 00 0 01 0000 or the acrylic inlay with hinged cover # 790867 00 0 01 0000. The turning handle for the operation of the base inlet is positioned under the hinged cover



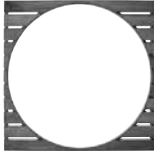
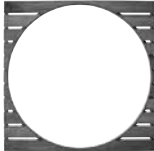





Blue Moon Accessories Design by Jochen Schmiedem

	Description	Model-No.	Euro
	<p>Special waste and overflow chrome, for Blue Moon 1400 x 1400 mm outlet diameter 52 mm</p>	<p>790236 00 0 00 1000</p>	
<p>Infobox: If you order the waste and overflow # 790236 00 0 00 1000 for bathtub please select the wooden inlay # 790851 00 0 00 0000 or the acrylic inlay # 790852 00 0 00 0000</p>			
	<p>Special waste and overflow **** with base inlet, chrome, for Blue Moon bathtub 1400 x 1400 mm outlet diameter 52 mm</p>	<p>791233 00 0 00 1000</p>	
<p>Infobox: **** assembled, pipe interrupt mandatory, wooden or acrylic inlay with hinged cover required / If you order the waste and overflow with base inlet # 791233 00 0 00 1000 for bathtub please select the wooden inlay with hinged cover # 790851 00 0 02 0000 or the acrylic inlay with hinged cover # 790852 00 0 02 0000. The turning handle for the operation of the base inlet is positioned under the hinged cover</p>			
<p>Surcharge **** for waste and overflow, with base inlet, chrome, for Blue Moon whirltubs 1400 x 1400 mm outlet diameter 52 mm</p>			
<p>Infobox: **** assembled, pipe interrupt mandatory, wooden or acrylic inlay with hinged cover required</p>			
	<p>Special waste and overflow chrome, for Blue Moon bathtub 1800 x 1800 mm outlet diameter 90 mm</p>	<p>790247 00 0 00 1000</p>	
<p>Infobox: If you order the waste and overflow # 790247 00 0 00 1000 please select the wooden inlay # 790866 00 0 00 0000 or the acrylic inlay # 790867 00 0 00 0000</p>			
<p>Special waste and overflow **** with base inlet, chrome, for Blue Moon bathtub 1800 x 1800 mm outlet diameter 90 mm</p>			
<p>Infobox: **** assembled, pipe interrupt mandatory, wooden or acrylic inlay with hinged cover required / If you order the waste and overflow with base inlet # 791236 00 0 00 1000 please select the wooden inlay with hinged cover # 790866 00 0 01 0000 or the acrylic inlay with hinged cover # 790867 00 0 01 0000. The turning handle for the operation of the base inlet is positioned under the hinged cover</p>			
	<p>Bathtub anchors * (4 pcs.) for mounting and support of bathtubs and shower trays</p>	<p>790123 00 0 00 0000</p>	
<p>Infobox: * We recommend to use 4 bathtub anchors for the installation</p>			

Blue Moon Accessories Design by Jochen Schmiedem

	Description	Model-No.	Euro
	Headrest white, material: polyurethane		
	for Blue Moon 1400 x 1400 mm	790003 00 0 00 0000	
	for Blue Moon 1800 x 1800 mm	790004 00 0 00 0000	
	Footrest for Blue Moon 1800 x 1800 mm		
	length 180 mm	790885 00 0 00 0000	
	length 250 mm	790886 00 0 00 0000	
	Wooden inlay Teak (real wood)		
	for Blue Moon bathtub 1400 x 1400 mm	790851 00 0 00 0000	
	for Blue Moon bathtub 1800 x 1800 mm	790866 00 0 00 0000	
	Wooden inlay Teak (real wood), with hinged cover		
	for Blue Moon whirltub 1400 x 1400 mm and bathtub 1400 x 1400 mm with waste and overflow with base inlet	790851 00 0 02 0000	
	for Blue Moon bathtubs 1800 x 1800 mm with waste and overflow with base inlet	790866 00 0 01 0000	
	Acrylic inlay for Blue Moon bathtub 1400 x 1400 mm	790852 00 0 00 0000	
	for Blue Moon bathtub 1800 x 1800 mm	790867 00 0 00 0000	
	Acrylic inlay with hinged cover		
	for Blue Moon whirltub 1400 x 1400 mm and bathtub 1400 x 1400 mm with waste and overflow with base inlet	790852 00 0 02 0000	
	for Blue Moon pool 1800 x 1800 mm and bathtub 1800 x 1800 mm with waste and overflow with base inlet	790867 00 0 01 0000	
	Tub cover for Blue Moon 1400 x 1400 mm	790883 00 0 00 0000	
	for Blue Moon 1800 x 1800 mm	790884 00 0 00 0000	
	Storage holder for tub cover for Blue Moon bathtubs, 1 pair, material: stainless steel high gloss polished		
	left	790881 00 0 00 6600	
	right	790882 00 0 00 6600	

Blue Moon Accessories Design by Jochen Schmiedem

	Description	Model-No.	Euro
	Storage holder for tub cover for Blue Moon whirltubs and pools, 1 pair, material: stainless steel high gloss polished		
	left	791805 00 0 00 6600	
	right	791806 00 0 00 6600	
	LED coloured light with remote control for bathtubs, for Blue Moon		
	white	790846 00 0 00 0000	
	chrome	790846 00 0 00 1000	
	Bench / support rail Teak (real wood) for Blue Moon 1400 x 1400 mm for Blue Moon 1800 x 1800 mm	 790855 00 0 00 0000 790868 00 0 00 0000	
	Bench / support rail Teak (real wood), with clothes rail for Blue Moon 1400 x 1400 mm for Blue Moon 1800 x 1800 mm	 790856 00 0 00 0000 790869 00 0 00 0000	
	Bench / support rail Teak (real wood), with handhold for Blue Moon 1400 x 1400 mm for Blue Moon 1800 x 1800 mm	 790857 00 0 00 0000 790870 00 0 00 0000	
	Bench / support rail Teak (real wood), with clothes rail, with handhold for Blue Moon 1400 x 1400 mm for Blue Moon 1800 x 1800 mm	 790858 00 0 00 0000 790871 00 0 00 0000	
	Acrylic panel for corner left / right for Blue Moon 1400 x 1400 mm for Blue Moon 1800 x 1800 mm	 701022 00 0 00 0000 701059 00 0 00 0000	
	Acrylic panel for back-to-wall version for Blue Moon 1400 x 1400 mm for Blue Moon 1800 x 1800 mm	 701023 00 0 00 0000 701060 00 0 00 0000	

Blue Moon Accessories Design by Jochen Schmiedem

Description	Model-No.		Euro
	Acrylic panel		
	for freestanding version		
	for Blue Moon 1400 x 1400 mm	701024 00 0 00 0000	
for Blue Moon 1800 x 1800 mm	701061 00 0 00 0000		

Blue Moon Design by Jochen Schmiedem

Panels for bath- and whirtubs

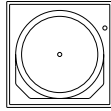

1400 x 1400 mm



700143

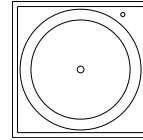

1800 x 1800 mm



700169

		Model-No. panel	Model-No. acrylic panel	Model-No. panel	Model-No. acrylic panel
	Corner left	# BM 8751	# 701022	# BM 8761	# 701059
	Corner right	# BM 8751	# 701022	# BM 8761	# 701059
	Back-to-wall	# BM 8752	# 701023	# BM 8762	# 701060
	Freestanding	# BM 8750	# 701024	# BM 8760	# 701061

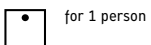

for 1 person



for 2 persons

Blue Moon Design by Jochen Schmiedem

Product Information

Panel	Decor (Pricegroup 1)	53 Chestnut Dark	High-density-fiberboard, with laminate (HPL) pressed on both sides. Surfaces resistant to moisture.
	Real wood veneer (Pricegroup 2)	13 American Walnut 24 Macassar	High-density-fiberboard, with real wood veneer pressed on one side and laminate (HPL) pressed on other side. Real wood veneer is a natural material, differences in colour and structure may occur. Surfaces resistant to moisture.
	Real wood veneer (Pricegroup 3)	62 Anthracite Oak	High-density-fiberboard, with real wood veneer pressed on one side and laminate (HPL) pressed on other side. Real wood veneer is a natural material, differences in colour and structure may occur. Surfaces resistant to moisture.

Blue Moon Design by Jochen Schmiedem

Description	mm	Model-No.	Euro		
			Pricegroup 1	Pricegroup 2	Pricegroup 3
Panel					
for corner right/ for corner left, indoor					
for # 700143 (1400 x 1400 mm)	1396 x 1396	BM 8751			
for # 700169 (1800 x 1800 mm)	1796 x 1796	BM 8761			
Panel					
for back-to-wall, indoor					
for # 700143 (1400 x 1400 mm)	1396 x 1392	BM 8752			
for # 700169 (1800 x 1800 mm)	1796 x 1792	BM 8762			
Panel					
for freestanding version, indoor					
for # 700143 (1400 x 1400 mm)	1392 x 1392	BM 8750			
for # 700169 (1800 x 1800 mm)	1792 x 1792	BM 8760			

Darling New Design by sieger design

Product Information

LED white light under bathtub rim (optional)

Under the wide bathtub rim a LED stripe is installed which suffuses the bathtub panel in indirect light. The light can be operated by touching the Duravit logo on bathtub rim. The LED white light is suitable for all Darling New bath- and whirltubs with furniture or acrylic panel (excluding built-in versions).

Power supply: 220-240V 50/60Hz

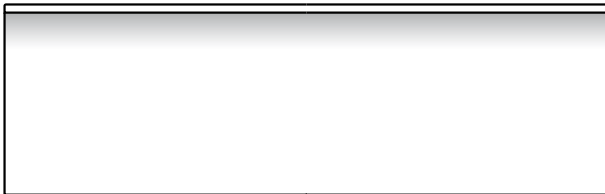

Darling New bath- and whirltubs with panel # 700238 - 700245: LED white light is installed in front area.

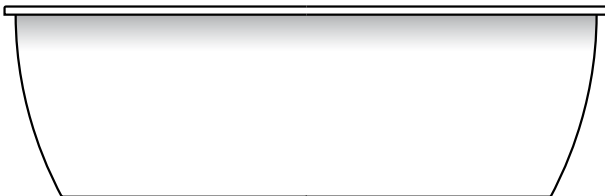

Darling New bath- and whirltubs with acrylic panel # 700246 - 700249: LED white light is installed all around.

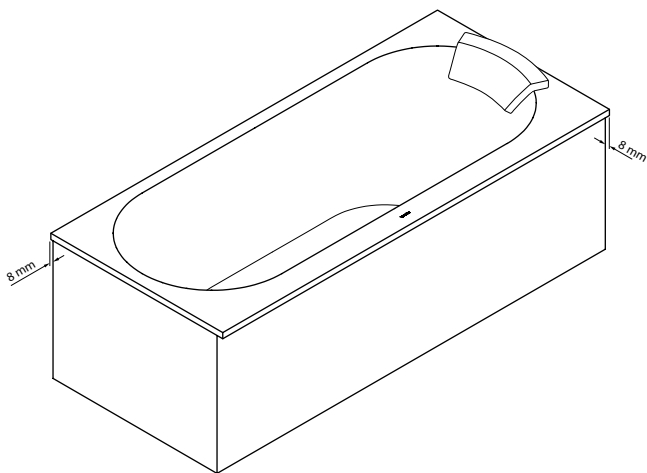

Panel

When ordering without LED white light

For the combination Darling New rectangle bathtub # 700238 - 700245 without LED white light under bathtub rim the panel with standard recess of ~ 8 mm must be ordered.

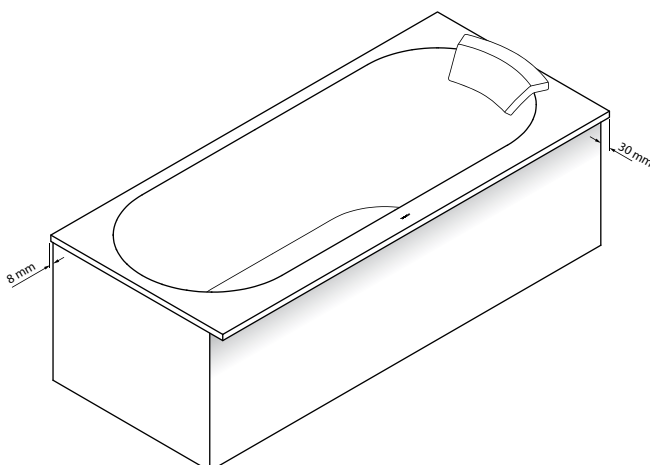

When ordering with LED white light

For the combination Darling New rectangle bathtub # 700238 - 700245 with LED white light under bathtub rim the panel with larger recess in front area of ~ 30 mm must be ordered.

Darling New Design by sieger design

Bathtub rectangle, built-in or for panel, with one backrest slope left
5 mm sanitary acrylic

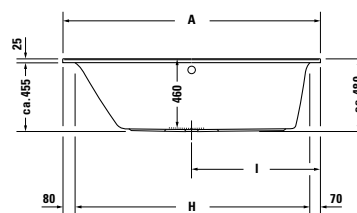
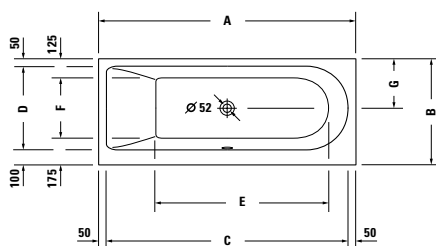

	A	B	C	D	E	F	G	H	I
700238	1600	700	1500	550	1050	400	325	1450	800
700240	1700	700	1600	550	1150	400	325	1550	850
700242	1700	750	1600	600	1150	450	350	1550	850

Length mm	Width mm	Depth mm	Capacity l	Weight kg	Model-No.	Euro
						White - 00
Bathtub						
1600	700	460	120	24,0	700238 00 0 00 0000	
1700	700	460	135	25,0	700240 00 0 00 0000	
1700	750	460	160	26,0	700242 00 0 00 0000	
Surcharge for whirlsystem						
Air-System					760*** 00 1 00 1000	
Jet-System					760*** 00 2 00 1000	
Combi-System P					760*** 00 3 00 1000	
Combi-System E					760*** 00 4 16 1000	
Combi-System L					710*** 00 5 00 1000	
Additional modules for whirltub						
Additional modules for Combi-System E				Module-No.		
LED coloured light (replaces LED white light)				06		
Heating				07		
UV Hygiene Management				08		
Additional modules for Combi-System L				Module-No.		
LED coloured light (replaces white light)				06		
Temperature L				07		
UV Hygiene Management				08		
Accessories for bath- and whirltub						
Headrest, straight, white					790007 00 0 00 0000	
Bathtub anchors					790103 00 0 00 0000	
Rubber profile					790104 00 0 00 0000	
LED white light, under bathtub rim **					791847 00 0 00 0000	
Suitable panels s.p. 295						

continued on following page

Darling New Design by sieger design

Bathtub rectangle, built-in or for panel, with one backrest slope left
5 mm sanitary acrylic

Length mm	Width mm	Depth mm	Capacity l	Weight kg	Model-No.	Euro	
						White	- 00
Bathtub							
1600	700	460	120	24,0	700238 00 0 00 0000		
1700	700	460	135	25,0	700240 00 0 00 0000		
1700	750	460	160	26,0	700242 00 0 00 0000		
Accessories for bathtub							
Support frame, for bathtubs and shower trays, with length > 1000 mm					790100 00 0 00 0000		
Waste and overflow Quadroval, chrome					790289 00 0 00 1000		
Waste and overflow Quadroval, with water inlet, chrome					790290 00 0 00 1000		
Support, for # 700238					791431 00 0 00 0000		
Support, for # 700240					791433 00 0 00 0000		
Support, for # 700242					791435 00 0 00 0000		
LED coloured light, with remote control for bathtubs, (white -00, chrome -10)					790840 00 0 00 * 00		
Sound					791851 00 0 00 0000		
Suitable tub covers s.p. 510/511							
Accessories for whirltub							
Surcharge, for waste and overflow Quadroval, with water inlet, chrome					791206 00 0 00 1000		
LED coloured light, for whirltubs with Air-System, Jet-System, Combi-System P, Durapearl-System or Jet Project					791850 00 0 00 1000		
Sound, for whirltubs with Air-System, Jet-System, Combi-System P, Durapearl-System or Jet Project					791852 00 0 00 0000		
Sound, for whirltubs with Combi-System E					791853 00 0 00 0000		

Infobox: LED coloured light or sound is not suitable for bathtubs with support / ** LED white light under bathtub rim only available for tubs with panel, no built-in version possible

Darling New Design by sieger design

Bathtub rectangle, built-in or for panel, with one backrest slope right
5 mm sanitary acrylic

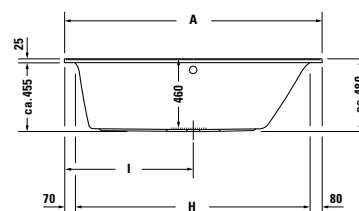
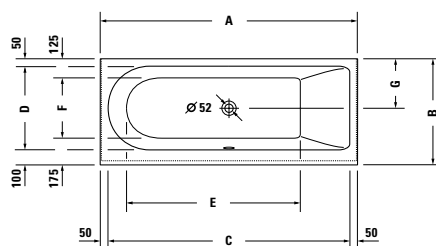

	A	B	C	D	E	F	G	H	I
700239	1600	700	1500	550	1050	400	325	1450	800
700241	1700	700	1600	550	1150	400	325	1550	850
700243	1700	750	1600	600	1150	450	350	1550	850

Length mm	Width mm	Depth mm	Capacity l	Weight kg	Model-No.	Euro
						White - 00
Bathtub						
1600	700	460	120	24,0	700239 00 0 00 0000	
1700	700	460	135	25,0	700241 00 0 00 0000	
1700	750	460	160	26,0	700243 00 0 00 0000	
Surcharge for whirlsystem						
Air-System					760*** 00 1 00 1000	
Jet-System					760*** 00 2 00 1000	
Combi-System P					760*** 00 3 00 1000	
Combi-System E					760*** 00 4 16 1000	
Combi-System L					710*** 00 5 00 1000	
Additional modules for whirltub						
Additional modules for Combi-System E				Module-No.		
LED coloured light (replaces LED white light)				06		
Heating				07		
UV Hygiene Management				08		
Additional modules for Combi-System L				Module-No.		
LED coloured light (replaces white light)				06		
Temperature L				07		
UV Hygiene Management				08		
Accessories for bath- and whirltub						
Headrest, straight, white					790007 00 0 00 0000	
Bathtub anchors					790103 00 0 00 0000	
Rubber profile					790104 00 0 00 0000	
LED white light, under bathtub rim **					791847 00 0 00 0000	
Suitable panels s.p. 295						

continued on following page

Darling New Design by sieger design

Bathtub rectangle, built-in or for panel, with one backrest slope right
5 mm sanitary acrylic

Length mm	Width mm	Depth mm	Capacity l	Weight kg	Model-No.	Euro	
						White	- 00
Bathtub							
1600	700	460	120	24,0	700239 00 0 00 0000		
1700	700	460	135	25,0	700241 00 0 00 0000		
1700	750	460	160	26,0	700243 00 0 00 0000		
Accessories for bathtub							
Support frame, for bathtubs and shower trays, with length > 1000 mm					790100 00 0 00 0000		
Waste and overflow Quadroval, chrome					790289 00 0 00 1000		
Waste and overflow Quadroval, with water inlet, chrome					790290 00 0 00 1000		
Support, for # 700239					791432 00 0 00 0000		
Support, for # 700241					791434 00 0 00 0000		
Support, for # 700243					791436 00 0 00 0000		
LED coloured light, with remote control for bathtubs, (white -00, chrome -10)					790840 00 0 00 * *00		
Sound					791851 00 0 00 0000		
Suitable tub covers s.p. 510/511							
Accessories for whirltub							
Surcharge, for waste and overflow Quadroval, with water inlet, chrome					791206 00 0 00 1000		
LED coloured light, for whirltubs with Air-System, Jet-System, Combi-System P, Durapearl-System or Jet Project					791850 00 0 00 1000		
Sound, for whirltubs with Air-System, Jet-System, Combi-System P, Durapearl-System or Jet Project					791852 00 0 00 0000		
Sound, for whirltubs with Combi-System E					791853 00 0 00 0000		

Infobox: LED coloured light or sound is not suitable for bathtubs with support / ** LED white light under bathtub rim only available for tubs with panel, no built-in version possible

Darling New Design by sieger design

Bathtub rectangle, built-in or for panel, with two backrest slopes

5 mm sanitary acrylic

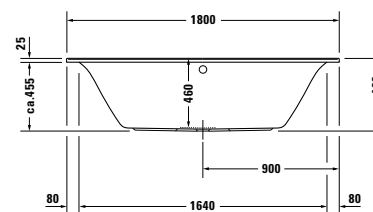
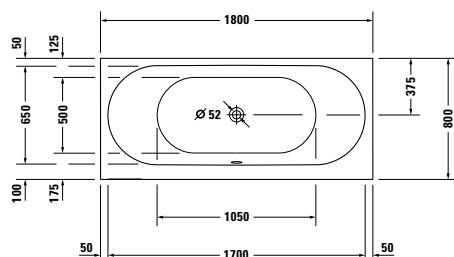

Length mm	Width mm	Depth mm	Capacity l	Weight kg	Model-No.	Euro
						White - 00
Bathtub						
1800	800	460	165	28,0	700244 00 0 00 0000	
Surcharge for whirlsystem						
Air-System					760*** 00 1 00 1000	
Jet-System					760*** 00 2 00 1000	
Combi-System P					760*** 00 3 00 1000	
Combi-System E					760*** 00 4 16 1000	
Combi-System L					710*** 00 5 00 1000	
Additional modules for whirltub						
Additional modules for Combi-System E				Module-No.		
LED coloured light (replaces LED white light)				06		
Heating				07		
UV Hygiene Management				08		
Additional modules for Combi-System L				Module-No.		
LED coloured light (replaces white light)				06		
Temperature L				07		
UV Hygiene Management				08		
Accessories for bath- and whirltub						
Headrest, curved, white					790008 00 0 00 0000	
Bathtub anchors					790103 00 0 00 0000	
Rubber profile					790104 00 0 00 0000	
LED white light, under bathtub rim **					791847 00 0 00 0000	
Suitable panels s.p. 295						
Accessories for bathtub						
Support frame, for bathtubs and shower trays, with length > 1000 mm					790100 00 0 00 0000	
Waste and overflow Quadroval, chrome					790289 00 0 00 1000	
Waste and overflow Quadroval, with water inlet, chrome					790290 00 0 00 1000	
Waste and overflow, with base inlet, chrome *					791226 00 0 00 1000	
Support, for # 700244					791437 00 0 00 0000	
LED coloured light, with remote control for bathtubs, (white -00, chrome -10)					790840 00 0 00 * 00	
Sound					791851 00 0 00 0000	
Suitable tub covers s.p. 510/511						
Accessories for whirltub						
Surcharge, for waste and overflow Quadroval, with water inlet, chrome					791206 00 0 00 1000	
Surcharge, for waste and overflow, with base inlet, chrome *					791227 00 0 00 1000	
LED coloured light, for whirltubs with Air-System, Jet-System, Combi-System P, Durapearl-System or Jet Project					791850 00 0 00 1000	
Sound, for whirltubs with Air-System, Jet-System, Combi-System P, Durapearl-System or Jet Project					791852 00 0 00 0000	
Sound, for whirltubs with Combi-System E					791853 00 0 00 0000	

Infobox: LED coloured light or sound is not suitable for bathtubs with support / ** LED white light under bathtub rim only available for tubs with panel, no built-in version possible / * pipe interrupt mandatory

Darling New Design by sieger design

Bathtub rectangle, built-in or for panel, with two backrest slopes

5 mm sanitary acrylic

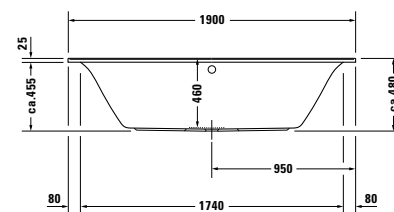
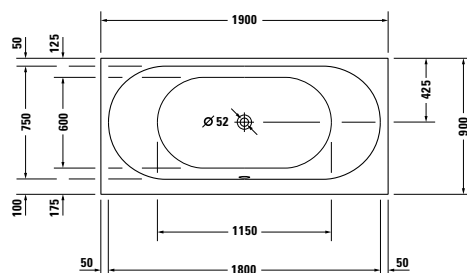

Length mm	Width mm	Depth mm	Capacity l	Weight kg	Model-No.	Euro
						White - 00
Bathtub						
1900	900	460	170	32,0	700245 00 0 00 0000	
Surcharge for whirlsystem						
Air-System					760*** 00 1 00 1000	
Jet-System					760*** 00 2 00 1000	
Combi-System P					760*** 00 3 00 1000	
Combi-System E					760*** 00 4 16 1000	
Combi-System L					710*** 00 5 00 1000	
Additional modules for whirltub						
Additional modules for Combi-System E				Module-No.		
LED coloured light (replaces LED white light)				06		
Heating				07		
UV Hygiene Management				08		
Additional modules for Combi-System L				Module-No.		
LED coloured light (replaces white light)				06		
Temperature L				07		
UV Hygiene Management				08		
Accessories for bath- and whirltub						
Headrest, curved, white					790008 00 0 00 0000	
Bathtub anchors					790103 00 0 00 0000	
Rubber profile					790104 00 0 00 0000	
LED white light, under bathtub rim **					791847 00 0 00 0000	
Suitable panels s.p. 295						
Accessories for bathtub						
Support frame, for bathtubs and shower trays, with length > 1000 mm					790100 00 0 00 0000	
Waste and overflow Quadroval, chrome					790293 00 0 00 1000	
Waste and overflow Quadroval, with water inlet, chrome					790294 00 0 00 1000	
Waste and overflow, with base inlet, chrome *					791226 00 0 00 1000	
Support, for # 700245					791438 00 0 00 0000	
LED coloured light, with remote control for bathtubs, (white -00, chrome -10)					790840 00 0 00 * 00	
Sound					791851 00 0 00 0000	
Accessories for whirltub						
Surcharge, for waste and overflow Quadroval, with water inlet, chrome					791206 00 0 00 1000	
Surcharge, for waste and overflow, with base inlet, chrome *					791227 00 0 00 1000	
LED coloured light, for whirltubs with Air-System, Jet-System, Combi-System P, Durapearl-System or Jet Project					791850 00 0 00 1000	
Sound, for whirltubs with Air-System, Jet-System, Combi-System P, Durapearl-System or Jet Project					791852 00 0 00 0000	
Sound, for whirltubs with Combi-System E					791853 00 0 00 0000	

Infobox: LED coloured light or sound is not suitable for bathtubs with support / ** LED white light under bathtub rim only available for tubs with panel, no built-in version possible / * pipe interrupt mandatory

Darling New Design by sieger design

Bathtub corner left, with acrylic panel and support frame

5 mm sanitary acrylic

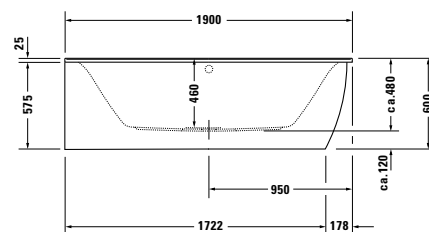
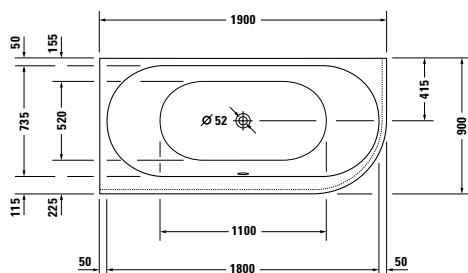

Length mm	Width mm	Depth mm	Capacity l	Weight kg	Model-No.	Euro
						White - 00
Bathtub						
1900	900	460	185	41,0	700246 00 0 00 0000	
Surcharge for whirlsystem						
Air-System					760*** 00 1 00 1000	
Jet-System					760*** 00 2 00 1000	
Combi-System P					760*** 00 3 00 1000	
Combi-System E					760*** 00 4 16 1000	
Combi-System L					710*** 00 5 00 1000	
Additional modules for whirltub						
Additional modules for Combi-System E				Module-No.		
LED coloured light (replaces LED white light)				06		
Heating				07		
UV Hygiene Management				08		
Additional modules for Combi-System L				Module-No.		
LED coloured light (replaces white light)				06		
Temperature L				07		
UV Hygiene Management				08		
Accessories for bath- and whirltub						
Headrest, curved, white					790008 00 0 00 0000	
Bathtub anchors					790103 00 0 00 0000	
Rubber profile					790104 00 0 00 0000	
LED white light, under bathtub rim					791848 00 0 00 0000	
Accessories for bathtub						
Waste and overflow Quadroval, chrome					790293 00 0 00 1000	
Waste and overflow Quadroval, with water inlet, chrome					790294 00 0 00 1000	
Waste and overflow, with base inlet, chrome *					791226 00 0 00 1000	
LED coloured light, with remote control for bathtubs, (white -00, chrome -10)					790840 00 0 00 * 00	
Sound					791851 00 0 00 0000	
Accessories for whirltub						
Surcharge, for waste and overflow Quadroval, with water inlet, chrome					791206 00 0 00 1000	
Surcharge, for waste and overflow, with base inlet, chrome *					791227 00 0 00 1000	
LED coloured light, for whirltubs with Air-System, Jet-System, Combi-System P, Durapearl-System or Jet Project					791850 00 0 00 1000	
Sound, for whirltubs with Air-System, Jet-System, Combi-System P, Durapearl-System or Jet Project					791852 00 0 00 0000	
Sound, for whirltubs with Combi-System E					791853 00 0 00 0000	

Infobox: * pipe interrupt mandatory

Darling New Design by sieger design

Bathtub corner right, with acrylic panel and support frame

5 mm sanitary acrylic

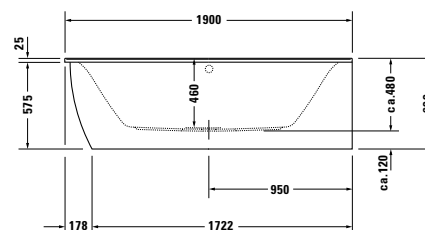
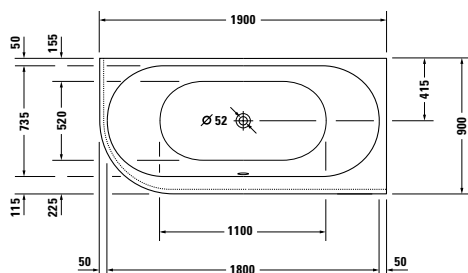

Length mm	Width mm	Depth mm	Capacity l	Weight kg	Model-No.	Euro
						White - 00
Bathtub						
1900	900	460	185	41,0	700247 00 0 00 0000	
Surcharge for whirlsystem						
Air-System					760*** 00 1 00 1000	
Jet-System					760*** 00 2 00 1000	
Combi-System P					760*** 00 3 00 1000	
Combi-System E					760*** 00 4 16 1000	
Combi-System L					710*** 00 5 00 1000	
Additional modules for whirltub						
Additional modules for Combi-System E				Module-No.		
LED coloured light (replaces LED white light)				06		
Heating				07		
UV Hygiene Management				08		
Additional modules for Combi-System L				Module-No.		
LED coloured light (replaces white light)				06		
Temperature L				07		
UV Hygiene Management				08		
Accessories for bath- and whirltub						
Headrest, curved, white					790008 00 0 00 0000	
Bathtub anchors					790103 00 0 00 0000	
Rubber profile					790104 00 0 00 0000	
LED white light, under bathtub rim					791848 00 0 00 0000	
Accessories for bathtub						
Waste and overflow Quadroval, chrome					790293 00 0 00 1000	
Waste and overflow Quadroval, with water inlet, chrome					790294 00 0 00 1000	
Waste and overflow, with base inlet, chrome *					791226 00 0 00 1000	
LED coloured light, with remote control for bathtubs, (white -00, chrome -10)					790840 00 0 00 * 00	
Sound					791851 00 0 00 0000	
Accessories for whirltub						
Surcharge, for waste and overflow Quadroval, with water inlet, chrome					791206 00 0 00 1000	
Surcharge, for waste and overflow, with base inlet, chrome *					791227 00 0 00 1000	
LED coloured light, for whirltubs with Air-System, Jet-System, Combi-System P, Durapearl-System or Jet Project					791850 00 0 00 1000	
Sound, for whirltubs with Air-System, Jet-System, Combi-System P, Durapearl-System or Jet Project					791852 00 0 00 0000	
Sound, for whirltubs with Combi-System E					791853 00 0 00 0000	

Infobox: * pipe interrupt mandatory

Darling New Design by sieger design

Bathtub back-to-wall, with acrylic panel and support frame

5 mm sanitary acrylic

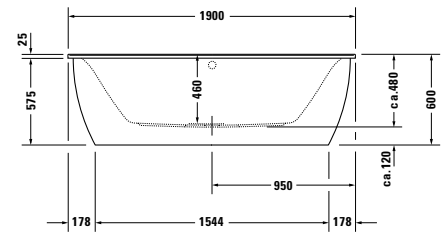
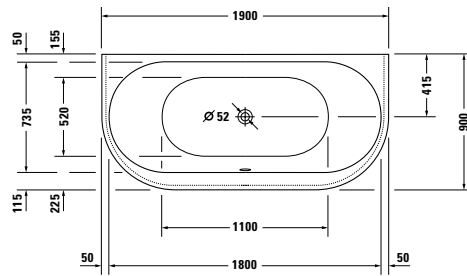

Length mm	Width mm	Depth mm	Capacity l	Weight kg	Model-No.	Euro
						White - 00
Bathtub						
1900	900	460	170	38,0	700248 00 0 00 0000	
Surcharge for whirlsystem						
Air-System					760*** 00 1 00 1000	
Jet-System					760*** 00 2 00 1000	
Combi-System P					760*** 00 3 00 1000	
Combi-System E					760*** 00 4 16 1000	
Combi-System L					710*** 00 5 00 1000	
Additional modules for whirltub						
Additional modules for Combi-System E				Module-No.		
LED coloured light (replaces LED white light)				06		
Heating				07		
UV Hygiene Management				08		
Additional modules for Combi-System L				Module-No.		
LED coloured light (replaces white light)				06		
Temperature L				07		
UV Hygiene Management				08		
Accessories for bath- and whirltub						
Headrest, curved, white					790008 00 0 00 0000	
Bathtub anchors					790103 00 0 00 0000	
Rubber profile					790104 00 0 00 0000	
LED white light, under bathtub rim					791849 00 0 00 0000	
Accessories for bathtub						
Waste and overflow Quadroval, chrome					790293 00 0 00 1000	
Waste and overflow Quadroval, with water inlet, chrome					790294 00 0 00 1000	
Waste and overflow, with base inlet, chrome *					791226 00 0 00 1000	
LED coloured light, with remote control for bathtubs, (white -00, chrome -10)					790840 00 0 00 * 00	
Sound					791851 00 0 00 0000	
Accessories for whirltub						
Surcharge, for waste and overflow Quadroval, with water inlet, chrome					791206 00 0 00 1000	
Surcharge, for waste and overflow, with base inlet, chrome *					791227 00 0 00 1000	
LED coloured light, for whirltubs with Air-System, Jet-System, Combi-System P, Durapearl-System or Jet Project					791850 00 0 00 1000	
Sound, for whirltubs with Air-System, Jet-System, Combi-System P, Durapearl-System or Jet Project					791852 00 0 00 0000	
Sound, for whirltubs with Combi-System E					791853 00 0 00 0000	

Infobox: * pipe interrupt mandatory

Darling New Design by sieger design

Bathtub corner, with acrylic panel and support frame



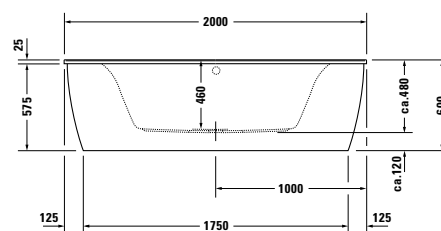
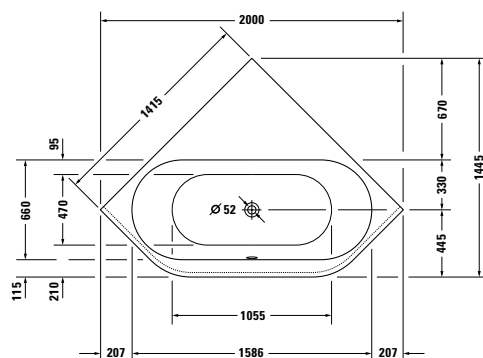

5 mm sanitary acrylic



Length mm	Width mm	Depth mm	Capacity l	Weight kg	Model-No.	Euro
						White - 00
Bathtub						
1415	1415	460	140	43,0	700249 00 0 00 0000	
Surcharge for whirlsystem						
Air-System					760*** 00 1 00 1000	
Jet-System					760*** 00 2 00 1000	
Combi-System P					760*** 00 3 00 1000	
Combi-System E					760*** 00 4 16 1000	
Combi-System L					710*** 00 5 00 1000	
Additional modules for whirltub						
Additional modules for Combi-System E				Module-No.		
LED coloured light (replaces LED white light)				06		
Heating				07		
UV Hygiene Management				08		
Additional modules for Combi-System L				Module-No.		
LED coloured light (replaces white light)				06		
Temperature L				07		
UV Hygiene Management				08		
Accessories for bath- and whirltub						
Headrest, curved, white					790008 00 0 00 0000	
Bathtub anchors					790103 00 0 00 0000	
Rubber profile					790104 00 0 00 0000	
LED white light, under bathtub rim					791848 00 0 00 0000	
Accessories for bathtub						
Waste and overflow Quadroval, chrome					790289 00 0 00 1000	
Waste and overflow Quadroval, with water inlet, chrome					790290 00 0 00 1000	
Waste and overflow, with base inlet, chrome *					791226 00 0 00 1000	
LED coloured light, with remote control for bathtubs, (white -00, chrome -10)					790840 00 0 00 * 00	
Sound					791851 00 0 00 0000	
Accessories for whirltub						
Surcharge, for waste and overflow Quadroval, with water inlet, chrome					791206 00 0 00 1000	
Surcharge, for waste and overflow, with base inlet, chrome *					791227 00 0 00 1000	
LED coloured light, for whirltubs with Air-System, Jet-System, Combi-System P, Durapearl-System or Jet Project					791850 00 0 00 1000	
Sound, for whirltubs with Air-System, Jet-System, Combi-System P, Durapearl-System or Jet Project					791852 00 0 00 0000	
Sound, for whirltubs with Combi-System E					791853 00 0 00 0000	

Infobox: * pipe interrupt mandatory

Darling New Accessories Design by sieger design

	Description	Model-No.	Euro
	Headrest straight, white, for # 700238 - 700243 material: polyurethane	790007 00 0 00 0000	
	Headrest curved, white, for # 700244 - 700249 material: polyurethane	790008 00 0 00 0000	
	LED white light ** under bathtub rim for # 700238 - 700245	791847 00 0 00 0000	
Infobox: ** LED white light under bathtub rim only available for tubs with panel, no built-in version possible			
	LED white light under bathtub rim for # 700246, 700247, 700249 for # 700248	791848 00 0 00 0000	791849 00 0 00 0000

Darling New Design by sieger design

Panels for bath- and whirtubs

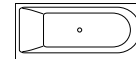
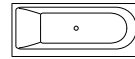
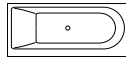

1600 x 700 mm

1700 x 700 mm

1700 x 750 mm



700238

700240

700242

700239

700241

700243

Model-No. panel		without LED white light	for LED white light	without LED white light	for LED white light	without LED white light	for LED white light
	Corner left	# DN 8785	# DN 8995	# DN 8786	# DN 8996	# DN 8787	# DN 8997
	Corner right	# DN 8780	# DN 8990	# DN 8781	# DN 8991	# DN 8782	# DN 8992
	Back-to-wall	# DN 8775	# DN 8965	# DN 8776	# DN 8966	# DN 8777	# DN 8967
	Niche	# DN 8937	# DN 8937	# DN 8938	# DN 8938	# DN 8938	# DN 8938

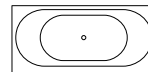
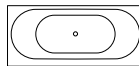

1800 x 800 mm

1900 x 900 mm



700244

700245

without LED white light

for LED white light

without LED white light

for LED white light

	Corner left	# DN 8788	# DN 8998	# DN 8906	# DN 8999
	Corner right	# DN 8783	# DN 8993	# DN 8904	# DN 8994
	Back-to-wall	# DN 8778	# DN 8968	# DN 8902	# DN 8969
	Niche	# DN 8939	# DN 8939	# DN 8941	# DN 8941

Please consider the product information of Darling New / A support frame is required for the installation of the panel. The support frame must be ordered separately / The LED white light has to be ordered separately

Darling New Design by sieger design

Product Information

Panel	Decor	14 Terra 31 Pine Silver 51 Pine Terra	High-density-fiberboard, with laminate (HPL) pressed on both sides. Surface resistant to moisture.
	Acryl	82 Acrylic White	8 mm Acryl solid-coloured in white

Darling New Design by sieger design

Description	mm	Model-No.	Euro
Panel			
for corner left,			
bathtub without LED white light			
for # 700238 (1600 x 700 mm)	1590 x 690	DN 8785	
for # 700239 (1600 x 700 mm)	1590 x 690	DN 8785	
for # 700240 (1700 x 700 mm)	1690 x 690	DN 8786	
for # 700241 (1700 x 700 mm)	1690 x 690	DN 8786	
for # 700242 (1700 x 750 mm)	1690 x 740	DN 8787	
for # 700243 (1700 x 750 mm)	1690 x 740	DN 8787	
for # 700244 (1800 x 800 mm)	1790 x 790	DN 8788	
for # 700245 (1900 x 900 mm)	1890 x 890	DN 8906	
bathtub with LED white light			
for # 700238 (1600 x 700 mm)	1590 x 670	DN 8995	
for # 700239 (1600 x 700 mm)	1590 x 670	DN 8995	
for # 700240 (1700 x 700 mm)	1690 x 670	DN 8996	
for # 700241 (1700 x 700 mm)	1690 x 670	DN 8996	
for # 700242 (1700 x 750 mm)	1690 x 720	DN 8997	
for # 700243 (1700 x 750 mm)	1690 x 720	DN 8997	
for # 700244 (1800 x 800 mm)	1790 x 770	DN 8998	
for # 700245 (1900 x 900 mm)	1890 x 870	DN 8999	

Infobox: A support frame is required for the installation of the panel. The support frame must be ordered separately / Heights of Darling New series:
Height bathtub panel = 555 mm, Height bathtub panel incl. 20 mm shadow gap = 575 mm, overall height incl. 25 mm bathtub trim = 600 mm

Panel			
for corner right,			
bathtub without LED white light			
for # 700238 (1600 x 700 mm)	1590 x 690	DN 8780	
for # 700239 (1600 x 700 mm)	1590 x 690	DN 8780	
for # 700240 (1700 x 700 mm)	1690 x 690	DN 8781	
for # 700241 (1700 x 700 mm)	1690 x 690	DN 8781	
for # 700242 (1700 x 750 mm)	1690 x 740	DN 8782	
for # 700243 (1700 x 750 mm)	1690 x 740	DN 8782	
for # 700244 (1800 x 800 mm)	1790 x 790	DN 8783	
for # 700245 (1900 x 900 mm)	1890 x 890	DN 8904	
bathtub with LED white light			
for # 700238 (1600 x 700 mm)	1590 x 670	DN 8990	
for # 700239 (1600 x 700 mm)	1590 x 670	DN 8990	
for # 700240 (1700 x 700 mm)	1690 x 670	DN 8991	
for # 700241 (1700 x 700 mm)	1690 x 670	DN 8991	
for # 700242 (1700 x 750 mm)	1690 x 720	DN 8992	
for # 700243 (1700 x 750 mm)	1690 x 720	DN 8992	
for # 700244 (1800 x 800 mm)	1790 x 770	DN 8993	
for # 700245 (1900 x 900 mm)	1890 x 870	DN 8994	

Infobox: A support frame is required for the installation of the panel. The support frame must be ordered separately / Heights of Darling New series:
Height bathtub panel = 555 mm, Height bathtub panel incl. 20 mm shadow gap = 575 mm, overall height incl. 25 mm bathtub trim = 600 mm

Darling New Design by sieger design

Description	mm	Model-No.	Euro
Panel			
for back-to-wall version, bathtub without LED white light			
for # 700238 (1600 x 700 mm)	1580 x 690	DN 8775	
for # 700239 (1600 x 700 mm)	1580 x 690	DN 8775	
for # 700240 (1700 x 700 mm)	1680 x 690	DN 8776	
for # 700241 (1700 x 700 mm)	1680 x 690	DN 8776	
for # 700242 (1700 x 750 mm)	1680 x 740	DN 8777	
for # 700243 (1700 x 750 mm)	1680 x 740	DN 8777	
for # 700244 (1800 x 800 mm)	1780 x 790	DN 8778	
for # 700245 (1900 x 900 mm)	1880 x 890	DN 8902	
bathtub with LED white light			
for # 700238 (1600 x 700 mm)	1580 x 670	DN 8965	
for # 700239 (1600 x 700 mm)	1580 x 670	DN 8965	
for # 700240 (1700 x 700 mm)	1680 x 670	DN 8966	
for # 700241 (1700 x 700 mm)	1680 x 670	DN 8966	
for # 700242 (1700 x 750 mm)	1680 x 720	DN 8967	
for # 700243 (1700 x 750 mm)	1680 x 720	DN 8967	
for # 700244 (1800 x 800 mm)	1780 x 770	DN 8968	
for # 700245 (1900 x 900 mm)	1880 x 870	DN 8969	

Infobox: A support frame is required for the installation of the panel. The support frame must be ordered separately / Heights of Darling New series:
Height bathtub panel = 555 mm, Height bathtub panel incl. 20 mm shadow gap = 575 mm, overall height incl. 25 mm bathtub trim = 600 mm

Panel			
for niche, bathtub with and without LED white light			
for # 700238 (1600 x 700 mm)	1590	DN 8937	
for # 700239 (1600 x 700 mm)	1590	DN 8937	
for # 700240 (1700 x 700 mm)	1690	DN 8938	
for # 700241 (1700 x 700 mm)	1690	DN 8938	
for # 700242 (1700 x 750 mm)	1690	DN 8938	
for # 700243 (1700 x 750 mm)	1690	DN 8938	
for # 700244 (1800 x 800 mm)	1775	DN 8939	
for # 700245 (1900 x 900 mm)	1890	DN 8941	

Infobox: A support frame is required for the installation of the panel. The support frame must be ordered separately / Heights of Darling New series:
Height bathtub panel = 555 mm, Height bathtub panel incl. 20 mm shadow gap = 575 mm, overall height incl. 25 mm bathtub trim = 600 mm

Daro Design by Duravit

Bathtub rectangle, built-in
5 mm sanitary acrylic

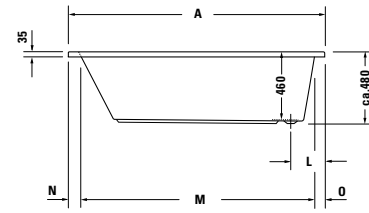
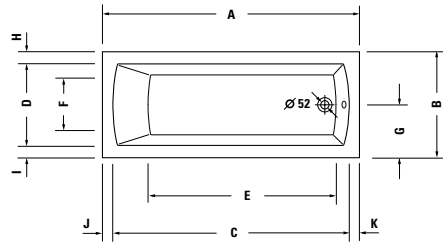

	A	B	C	D	E	F	G	H	I	J	K	L	M	N	O
700141	1700	700	1570	550	1245	400	350	75	75	65	65	240	1560	75	65
700027	1700	750	1570	600	1240	400	375	75	75	65	65	240	1540	85	75

Length mm	Width mm	Depth mm	Capacity l	Weight kg	Model-No.	Euro
						White - 00
Bathtub						
1700	700	460	150	26,0	700141 00 0 00 0000	
1700	750	460	160	30,0	700027 00 0 00 0000	
Surcharge for whirlsystem						
Air-System					760*** 00 1 00 1000	
Jet-System					760*** 00 2 00 1000	
Combi-System P					760*** 00 3 00 1000	
Combi-System E					760*** 00 4 16 1000	
Combi-System L					710*** 00 5 00 1000	
Additional modules for whirltub						
Additional modules for Combi-System E				Module-No.		
LED coloured light (replaces LED white light)				06		
Heating				07		
UV Hygiene Management				08		
Additional modules for Combi-System L				Module-No.		
LED coloured light (replaces white light)				06		
Temperature L				07		
UV Hygiene Management				08		
Accessories for bath- and whirltub						
Bathtub anchors					790103 00 0 00 0000	
Rubber profile					790104 00 0 00 0000	

continued on following page

Daro Design by Duravit

Bathtub rectangle, built-in
5 mm sanitary acrylic

Length mm	Width mm	Depth mm	Capacity l	Weight kg	Model-No.	Euro	
						White	- 00
Bathtub							
1700	700	460	150	26,0	700141 00 0 00 0000		
1700	750	460	160	30,0	700027 00 0 00 0000		
Accessories for bathtub							
Support frame, for bathtubs and shower trays, with length > 1000 mm					790100 00 0 00 0000		
Waste and overflow Quadroval, chrome					790285 00 0 00 1000		
Waste and overflow Quadroval, with water inlet, chrome					790286 00 0 00 1000		
Support, for # 700141					790468 00 0 00 0000		
Support, for # 700027					790420 00 0 00 0000		
LED coloured light, with remote control for bathtubs, (white -00, chrome -10)					790840 00 0 00 * 00		
Sound					791851 00 0 00 0000		
Suitable tub covers s.p. 510/511							
Accessories for whirltub							
Surcharge, for waste and overflow Quadroval, with water inlet, chrome					791205 00 0 00 1000		
LED coloured light, for whirltubs with Air-System, Jet-System, Combi-System P, Durapearl-System or Jet Project					791850 00 0 00 1000		
Sound, for whirltubs with Air-System, Jet-System, Combi-System P, Durapearl-System or Jet Project					791852 00 0 00 0000		
Sound, for whirltubs with Combi-System E					791853 00 0 00 0000		

Infobox: LED coloured light or sound is not suitable for bathtubs with support

Daro Design by Duravit

Bathtub rectangle, built-in
5 mm sanitary acrylic

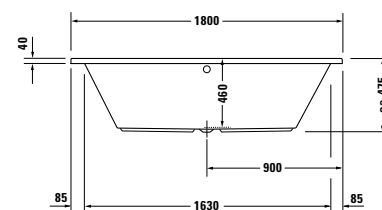
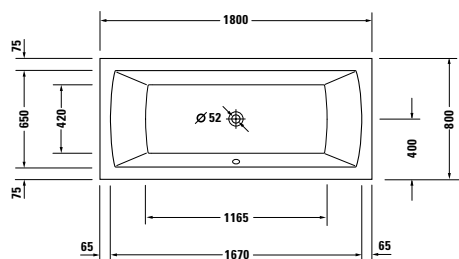

Length mm	Width mm	Depth mm	Capacity l	Weight kg	Model-No.	Euro
						White - 00
Bathtub						
1800	800	460	185	33,0	700028 00 0 00 0000	
Surcharge for whirlsystem						
Air-System					760*** 00 1 00 1000	
Jet-System					760*** 00 2 00 1000	
Combi-System P					760*** 00 3 00 1000	
Combi-System E					760*** 00 4 16 1000	
Combi-System L					710*** 00 5 00 1000	
Additional modules for whirltub						
Additional modules for Combi-System E				Module-No.		
LED coloured light (replaces LED white light)				06		
Heating				07		
UV Hygiene Management				08		
Additional modules for Combi-System L				Module-No.		
LED coloured light (replaces white light)				06		
Temperature L				07		
UV Hygiene Management				08		
Accessories for bath- and whirltub						
Bathtub anchors					790103 00 0 00 0000	
Rubber profile					790104 00 0 00 0000	
Accessories for bathtub						
Support frame, for bathtubs and shower trays, with length > 1000 mm					790100 00 0 00 0000	
Waste and overflow Quadroval, chrome					790289 00 0 00 1000	
Waste and overflow Quadroval, with water inlet, chrome					790290 00 0 00 1000	
Support, for # 700028					790421 00 0 00 0000	
LED coloured light, with remote control for bathtubs, (white -00, chrome -10)					790840 00 0 00 * 00	
Sound					791851 00 0 00 0000	
Suitable tub covers s.p. 510/511						
Accessories for whirltub						
Surcharge, for waste and overflow Quadroval, with water inlet, chrome					791206 00 0 00 1000	
LED coloured light, for whirltubs with Air-System, Jet-System, Combi-System P, Durapearl-System or Jet Project					791850 00 0 00 1000	
Sound, for whirltubs with Air-System, Jet-System, Combi-System P, Durapearl-System or Jet Project					791852 00 0 00 0000	
Sound, for whirltubs with Combi-System E					791853 00 0 00 0000	

Infobox: LED coloured light or sound is not suitable for bathtubs with support

D-Code Design by sieger design

Bathtub rectangle, built-in, outlet in foot area

4 mm sanitary acrylic

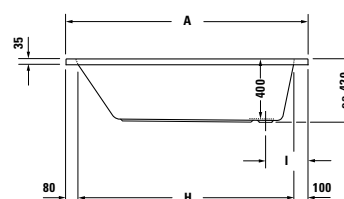
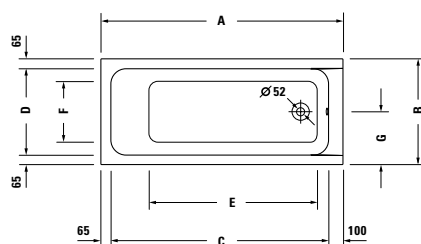

	A	B	C	D	E	F	G	H	I
700095	1500	750	1335	620	1015	460	375	1320	290
700096	1600	700	1435	570	1115	400	350	1420	280
700098	1700	700	1535	570	1210	400	350	1520	275
700100	1700	750	1535	620	1200	430	375	1520	280

Length mm	Width mm	Depth mm	Capacity l	Weight kg	Model-No.	Euro
						White - 00
Bathtub						
1500	750	400	95	17,5	700095 00 0 00 0000	
1600	700	400	100	17,5	700096 00 0 00 0000	
1700	700	400	110	19,5	700098 00 0 00 0000	
1700	750	400	120	20,0	700100 00 0 00 0000	
Surcharge for whirlsystem						
Jet Project					740* * 00 2 00 1000	
Accessories for bath- and whirltub						
Bathtub anchors					790125 00 0 00 0000	
Rubber profile					790126 00 0 00 0000	
Accessories for bathtub						
Support frame, for bathtubs and shower trays, with length > 1000 mm					790127 00 0 00 0000	
Waste and overflow, for outlet sidewise, chrome					790225 00 0 00 1000	
Support, for # 700095					790469 00 0 00 0000	
Support, for # 700096					790470 00 0 00 0000	
Support, for # 700098					790472 00 0 00 0000	
Support, for # 700100					790474 00 0 00 0000	
Suitable tub covers s.p. 510/511						
Suitable panels s.p. 308/309						
Accessories for whirltub						
Suitable panels s.p. 308/309						

D-Code Design by sieger design

Bathtub rectangle, built-in, central outlet

4 mm sanitary acrylic

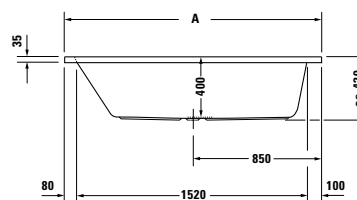
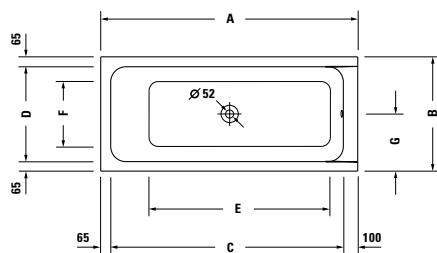

	A	B	C	D	E	F	G
700097	1700	700	1535	570	1210	400	350
700099	1700	750	1535	620	1200	430	375

Length mm	Width mm	Depth mm	Capacity l	Weight kg	Model-No.	Euro
						White - 00
Bathtub						
1700	700	400	110	19,5	700097 00 0 00 0000	
1700	750	400	120	20,0	700099 00 0 00 0000	
Surcharge for whirlsystem						
Jet Project					740** 00 2 00 1000	
Accessories for bath- and whirtub						
Bathtub anchors					790125 00 0 00 0000	
Rubber profile					790126 00 0 00 0000	
Accessories for bathtub						
Support frame, for bathtubs and shower trays, with length > 1000 mm					790127 00 0 00 0000	
Waste and overflow, for central outlet, with elongated bowden cable, chrome					790227 00 0 00 1000	
Support, for # 700097					790471 00 0 00 0000	
Support, for # 700099					790473 00 0 00 0000	
Suitable tub covers s.p. 510/511						
Suitable panels s.p. 308/309						
Accessories for whirltub						
Suitable panels s.p. 308/309						

D-Code Design by sieger design

Bathtub rectangle, built-in, central outlet

4 mm sanitary acrylic

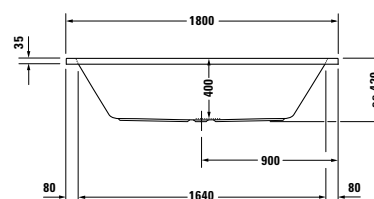
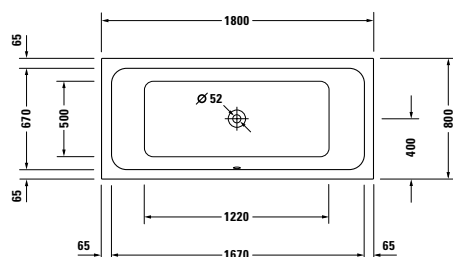

Length mm	Width mm	Depth mm	Capacity l	Weight kg	Model-No.	Euro
						White - 00
Bathtub						
1800	800	400	150	23,5	700101 00 0 00 0000	
Surcharge for whirlsystem						
Jet Project					740** 00 2 00 1000	
Accessories for bath- and whirtub						
Bathtub anchors					790125 00 0 00 0000	
Rubber profile					790126 00 0 00 0000	
Accessories for bathtub						
Support frame, for bathtubs and shower trays, with length > 1000 mm					790127 00 0 00 0000	
Waste and overflow, for central outlet, chrome					790226 00 0 00 1000	
Support, for # 700101					790475 00 0 00 0000	
Suitable tub covers s.p. 510/511						
Suitable panels s.p. 308/309						
Accessories for whirtub						
Suitable panels s.p. 308/309						

D-Code Design by sieger design

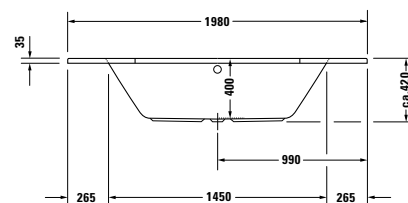
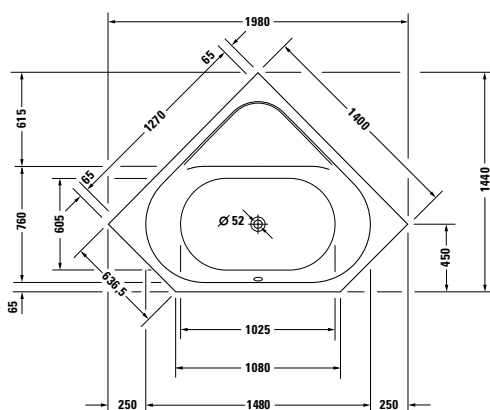
Bathtub corner, built-in
 4 mm sanitary acrylic





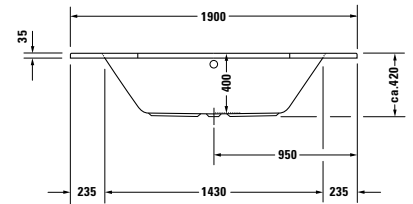
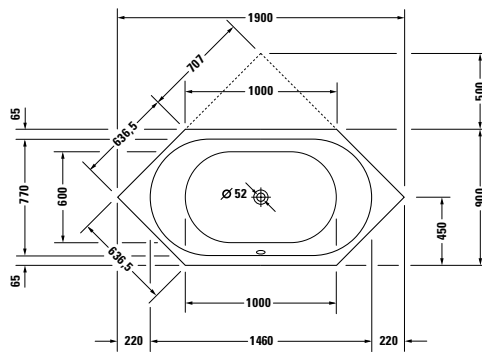



Length mm	Width mm	Depth mm	Capacity l	Weight kg	Model-No.	Euro
						White - 00
Bathtub						
1400	1400	400	140	26,0	700137 00 0 00 0000	
Surcharge for whirlsystem						
Jet Project					740** 00 2 00 1000	
Accessories for bath- and whirtub						
Bathtub anchors					790125 00 0 00 0000	
Rubber profile					790126 00 0 00 0000	
Accessories for bathtub						
Support frame, for corner bathtub					790128 00 0 00 0000	
Waste and overflow, for central outlet, chrome					790226 00 0 00 1000	
Support, for # 700137					790476 00 0 00 0000	

D-Code Design by sieger design





Bathtub hexagon, built-in
 4 mm sanitary acrylic

Length mm	Width mm	Depth mm	Capacity l	Weight kg	Model-No.	Euro
						White - 00
Bathtub						
1900	900	400	140	26,5	700138 00 0 00 0000	
Surcharge for whirlsystem						
Jet Project					740** 00 2 00 1000	
Accessories for bath- and whirtub						
Bathtub anchors					790125 00 0 00 0000	
Rubber profile					790126 00 0 00 0000	
Accessories for bathtub						
Support frame, for bathtubs and shower trays, with length > 1000 mm					790127 00 0 00 0000	
Waste and overflow, for central outlet, chrome					790226 00 0 00 1000	
Support, for # 700138					790477 00 0 00 0000	

D-Code Accessories Design by sieger design

	Description	Model-No.	Euro
	Bathtub anchors for mounting and support of bathtubs and shower trays 3 pieces	790125 00 0 00 0000	
	Rubber profile for noise reduction and sealing against moisture length: 3300 mm	790126 00 0 00 0000	
	Support frame for bathtubs and shower trays, with length > 1000 mm, height-adjustable from 115 - 180 mm 2 pieces	790127 00 0 00 0000	
	Support frame for corner bathtub height-adjustable from 115 - 180 mm	790128 00 0 00 0000	
	Waste and overflow for outlet sidewise, chrome, for bathtubs outlet diameter 52 mm	790225 00 0 00 1000	
	Waste and overflow for central outlet, chrome, for bathtubs outlet diameter 52 mm	790226 00 0 00 1000	
	Waste and overflow for central outlet, with elongated bowden cable, chrome, for bathtubs outlet diameter 52 mm	790227 00 0 00 1000	

D-Code Accessories Design by sieger design

	Description	Model-No.	Euro
	Panel *		
	front,		
	for bathtubs		
	1500 mm	701025 00 0 00 0000	
	1600 mm	701026 00 0 00 0000	
1700 mm	701027 00 0 00 0000		
1800 mm	701028 00 0 00 0000		
Infobox: * We recommend to use the rubber profile and the bathtub anchors for the installation of the panels. A special support frame and the required mounting material are included in the delivery of the panels. The support frame # 790127 is not required			
	Panel *		
	right,		
	for bathtubs		
	700 mm	701031 00 0 00 0000	
750 mm	701032 00 0 00 0000		
800 mm	701033 00 0 00 0000		
Infobox: * We recommend to use the rubber profile and the bathtub anchors for the installation of the panels. A special support frame and the required mounting material are included in the delivery of the panels. The support frame # 790127 is not required			
	Panel *		
	left,		
	for bathtubs		
	700 mm	701035 00 0 00 0000	
750 mm	701036 00 0 00 0000		
800 mm	701037 00 0 00 0000		
Infobox: * We recommend to use the rubber profile and the bathtub anchors for the installation of the panels. A special support frame and the required mounting material are included in the delivery of the panels. The support frame # 790127 is not required			
	Panel **		
	front,		
	for whirltubs		
	1500 mm	703012 00 0 00 0000	
	1600 mm	703013 00 0 00 0000	
1700 mm	703014 00 0 00 0000		
1800 mm	703015 00 0 00 0000		
Infobox: ** We recommend to use the rubber profile and the bathtub anchors for the installation of the panels. It is not possible to mount panels to a whirltub that has already been delivered			
	Panel **		
	right,		
	for whirltubs		
	700 mm	703016 00 0 00 0000	
750 mm	703017 00 0 00 0000		
800 mm	703018 00 0 00 0000		
Infobox: ** We recommend to use the rubber profile and the bathtub anchors for the installation of the panels. It is not possible to mount panels to a whirltub that has already been delivered			

D-Code Accessories Design by sieger design

Description	Model-No.	Euro
	Panel **	
	left, for whirltubs	
	700 mm	703019 00 0 00 0000
	750 mm	703020 00 0 00 0000
800 mm	703021 00 0 00 0000	
Infobox: ** We recommend to use the rubber profile and the bathtub anchors for the installation of the panels. It is not possible to mount panels to a whirltub that has already been delivered		

DuraStyle Design by Matteo Thun

Bathtub rectangle, built-in or for panel, with one backrest slope left
5 mm sanitary acrylic

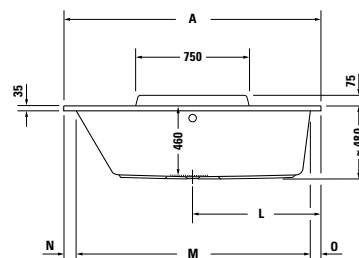
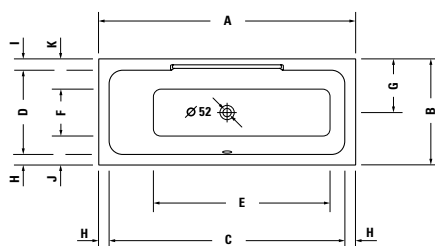

	A	B	C	D	E	F	G	H	I	J	K	L	M	N	O
700292	1600	700	1460	555	1070	310	355	70	75	190	200	800	1450	80	70
700294	1700	700	1560	555	1170	310	355	70	75	190	200	850	1550	80	70
700296	1700	750	1540	570	1080	285	385	80	100	220	245	850	1530	90	80

Length mm	Width mm	Depth mm	Capacity l	Weight kg	Model-No.	Euro
						White - 00
Bathtub						
1600	700	460	130	27,0	700292 00 0 00 0000	
1700	700	460	140	29,0	700294 00 0 00 0000	
1700	750	460	170	30,0	700296 00 0 00 0000	
Surcharge for whirlsystem						
Air-System					760*** 00 1 00 1000	
Jet Project					740*** 00 2 00 1000	
Jet-System					760*** 00 2 00 1000	
Combi-System P					760*** 00 3 00 1000	
Combi-System E					760*** 00 4 16 1000	
Combi-System L					710*** 00 5 00 1000	
Additional modules for whirltub						
Additional modules for Combi-System E				Module-No.		
LED coloured light (replaces LED white light)				06		
Heating				07		
UV Hygiene Management				08		
Additional modules for Combi-System L				Module-No.		
LED coloured light (replaces white light)				06		
Temperature L				07		
UV Hygiene Management				08		
Accessories for bath- and whirltub						
Bathtub anchors					790103 00 0 00 0000	
Rubber profile					790104 00 0 00 0000	
Suitable panels s.p. 319						

continued on following page

DuraStyle Design by Matteo Thun

Bathtub rectangle, built-in or for panel, with one backrest slope left
 5 mm sanitary acrylic

Length mm	Width mm	Depth mm	Capacity l	Weight kg	Model-No.	Euro	
						White	- 00
Bathtub							
1600	700	460	130	27,0	700292 00 0 00 0000		
1700	700	460	140	29,0	700294 00 0 00 0000		
1700	750	460	170	30,0	700296 00 0 00 0000		
Accessories for bathtub							
Support frame, for bathtubs and shower trays, with length > 1000 mm					790100 00 0 00 0000		
Waste and overflow Quadroval, chrome					790289 00 0 00 1000		
Waste and overflow Quadroval, with water inlet, chrome					790290 00 0 00 1000		
Support, for # 700292 / 700293					791460 00 0 00 0000		
Support, for # 700294 / 700295					791462 00 0 00 0000		
Support, for # 700296 / 700297					791464 00 0 00 0000		
LED coloured light, with remote control for bathtubs, (white -00, chrome -10)					790840 00 0 00 * *00		
Sound					791851 00 0 00 0000		
Accessories for whirltub							
Surcharge, for waste and overflow Quadroval, with water inlet, chrome					791206 00 0 00 1000		
Surcharge, for waste and overflow, with water inlet, for whirltubs with Jet Project, chrome					790253 00 0 00 1000		
LED coloured light, for whirltubs with Air-System, Jet-System, Combi-System P, Durapearl-System or Jet Project					791850 00 0 00 1000		
Sound, for whirltubs with Air-System, Jet-System, Combi-System P, Durapearl-System or Jet Project					791852 00 0 00 0000		
Sound, for whirltubs with Combi-System E					791853 00 0 00 0000		

Infobox: LED coloured light or sound is not suitable for bathtubs with support

DuraStyle Design by Matteo Thun

Bathtub rectangle, built-in or for panel, with one backrest slope right
5 mm sanitary acrylic

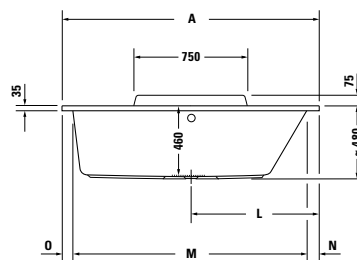
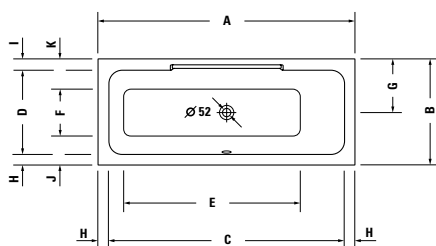

	A	B	C	D	E	F	G	H	I	J	K	L	M	N	O
700293	1600	700	1460	555	1070	310	355	70	75	190	200	800	1450	80	70
700295	1700	700	1560	555	1170	310	355	70	75	190	200	850	1550	80	70
700297	1700	750	1540	570	1080	285	385	80	100	220	245	850	1530	90	80

Length mm	Width mm	Depth mm	Capacity l	Weight kg	Model-No.	Euro
						White - 00
Bathtub						
1600	700	460	130	27,0	700293 00 0 00 0000	
1700	700	460	140	29,0	700295 00 0 00 0000	
1700	750	460	170	30,0	700297 00 0 00 0000	
Surcharge for whirlsystem						
Air-System					760*** 00 1 00 1000	
Jet Project					740*** 00 2 00 1000	
Jet-System					760*** 00 2 00 1000	
Combi-System P					760*** 00 3 00 1000	
Combi-System E					760*** 00 4 16 1000	
Combi-System L					710*** 00 5 00 1000	
Additional modules for whirltub						
Additional modules for Combi-System E				Module-No.		
LED coloured light (replaces LED white light)				06		
Heating				07		
UV Hygiene Management				08		
Additional modules for Combi-System L				Module-No.		
LED coloured light (replaces white light)				06		
Temperature L				07		
UV Hygiene Management				08		
Accessories for bath- and whirltub						
Bathtub anchors					790103 00 0 00 0000	
Rubber profile					790104 00 0 00 0000	
Suitable panels s.p. 319						

continued on following page

DuraStyle Design by Matteo Thun

Bathtub rectangle, built-in or for panel, with one backrest slope right
 5 mm sanitary acrylic

Length mm	Width mm	Depth mm	Capacity l	Weight kg	Model-No.	Euro	
						White	- 00
Bathtub							
1600	700	460	130	27,0	700293 00 0 00 0000		
1700	700	460	140	29,0	700295 00 0 00 0000		
1700	750	460	170	30,0	700297 00 0 00 0000		
Accessories for bathtub							
Support frame, for bathtubs and shower trays, with length > 1000 mm					790100 00 0 00 0000		
Waste and overflow Quadroval, chrome					790289 00 0 00 1000		
Waste and overflow Quadroval, with water inlet, chrome					790290 00 0 00 1000		
Support, for # 700292 / 700293					791460 00 0 00 0000		
Support, for # 700294 / 700295					791462 00 0 00 0000		
Support, for # 700296 / 700297					791464 00 0 00 0000		
LED coloured light, with remote control for bathtubs, (white -00, chrome -10)					790840 00 0 00 * 00		
Sound					791851 00 0 00 0000		
Accessories for whirltub							
Surcharge, for waste and overflow Quadroval, with water inlet, chrome					791206 00 0 00 1000		
Surcharge, for waste and overflow, with water inlet, for whirltubs with Jet Project, chrome					790253 00 0 00 1000		
LED coloured light, for whirltubs with Air-System, Jet-System, Combi-System P, Durapearl-System or Jet Project					791850 00 0 00 1000		
Sound, for whirltubs with Air-System, Jet-System, Combi-System P, Durapearl-System or Jet Project					791852 00 0 00 0000		
Sound, for whirltubs with Combi-System E					791853 00 0 00 0000		

Infobox: LED coloured light or sound is not suitable for bathtubs with support

DuraStyle Design by Matteo Thun

Bathtub rectangle, built-in or for panel, with two backrest slopes

5 mm sanitary acrylic

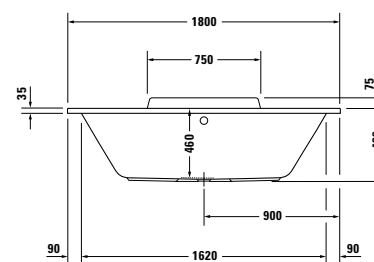
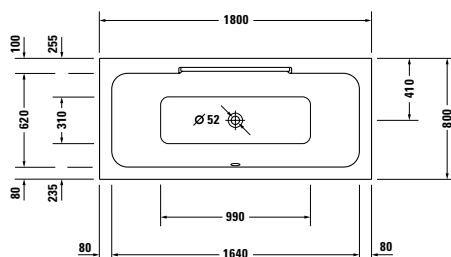

Length mm	Width mm	Depth mm	Capacity l	Weight kg	Model-No.	Euro
						White - 00
Bathtub						
1800	800	460	180	34,0	700298 00 0 00 0000	
Surcharge for whirlsystem						
Air-System					760*** 00 1 00 1000	
Jet Project					740*** 00 2 00 1000	
Jet-System					760*** 00 2 00 1000	
Combi-System P					760*** 00 3 00 1000	
Combi-System E					760*** 00 4 16 1000	
Combi-System L					710*** 00 5 00 1000	
Additional modules for whirltub						
Additional modules for Combi-System E				Module-No.		
LED coloured light (replaces LED white light)				06		
Heating				07		
UV Hygiene Management				08		
Additional modules for Combi-System L				Module-No.		
LED coloured light (replaces white light)				06		
Temperature L				07		
UV Hygiene Management				08		
Accessories for bath- and whirltub						
Bathtub anchors					790103 00 0 00 0000	
Rubber profile					790104 00 0 00 0000	
Suitable panels s.p. 319						
Accessories for bathtub						
Support frame, for bathtubs and shower trays, with length > 1000 mm					790100 00 0 00 0000	
Waste and overflow Quadroval, chrome					790289 00 0 00 1000	
Waste and overflow Quadroval, with water inlet, chrome					790290 00 0 00 1000	
Waste and overflow, with base inlet, chrome *					791226 00 0 00 1000	
Support, for # 700298					791466 00 0 00 0000	
LED coloured light, with remote control for bathtubs, (white -00, chrome -10)					790840 00 0 00 * *00	
Sound					791851 00 0 00 0000	
Accessories for whirltub						
Surcharge, for waste and overflow Quadroval, with water inlet, chrome					791206 00 0 00 1000	
Surcharge, for waste and overflow, with water inlet, for whirltubs with Jet Project, chrome					790254 00 0 00 1000	
Surcharge, for waste and overflow, with base inlet, chrome *					791227 00 0 00 1000	
Surcharge, for waste and overflow, with base inlet, for whirltubs with Jet Project, chrome *					791232 00 0 00 1000	
LED coloured light, for whirltubs with Air-System, Jet-System, Combi-System P, Durapearl-System or Jet Project					791850 00 0 00 1000	
Sound, for whirltubs with Air-System, Jet-System, Combi-System P, Durapearl-System or Jet Project					791852 00 0 00 0000	
Sound, for whirltubs with Combi-System E					791853 00 0 00 0000	

Infobox: LED coloured light or sound is not suitable for bathtubs with support / * pipe interrupt mandatory

DuraStyle Design by Matteo Thun

Bathtub rectangle, built-in or for panel, with two backrest slopes

5 mm sanitary acrylic

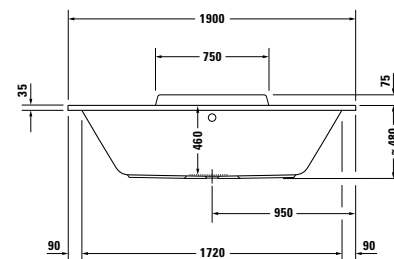
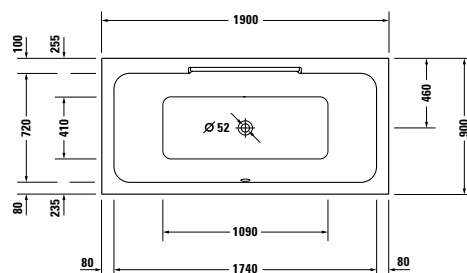

Length mm	Width mm	Depth mm	Capacity l	Weight kg	Model-No.	Euro
						White - 00
Bathtub						
1900	900	460	250	40,0	700299 00 0 00 0000	
Surcharge for whirlsystem						
Air-System					760*** 00 1 00 1000	
Jet Project					740*** 00 2 00 1000	
Jet-System					760*** 00 2 00 1000	
Combi-System P					760*** 00 3 00 1000	
Combi-System E					760*** 00 4 16 1000	
Combi-System L					710*** 00 5 00 1000	
Additional modules for whirltub						
Additional modules for Combi-System E				Module-No.		
LED coloured light (replaces LED white light)				06		
Heating				07		
UV Hygiene Management				08		
Additional modules for Combi-System L				Module-No.		
LED coloured light (replaces white light)				06		
Temperature L				07		
UV Hygiene Management				08		
Accessories for bath- and whirltub						
Bathtub anchors					790103 00 0 00 0000	
Rubber profile					790104 00 0 00 0000	
Suitable panels s.p. 319						
Accessories for bathtub						
Support frame, for bathtubs and shower trays, with length > 1000 mm					790100 00 0 00 0000	
Waste and overflow Quadroval, chrome					790293 00 0 00 1000	
Waste and overflow Quadroval, with water inlet, chrome					790294 00 0 00 1000	
Waste and overflow, with base inlet, chrome *					791226 00 0 00 1000	
Support, for # 700299					791467 00 0 00 0000	
LED coloured light, with remote control for bathtubs, (white -00, chrome -10)					790840 00 0 00 * 00	
Sound					791851 00 0 00 0000	
Accessories for whirltub						
Surcharge, for waste and overflow Quadroval, with water inlet, chrome					791206 00 0 00 1000	
Surcharge, for waste and overflow, with water inlet, for whirltubs with Jet Project, chrome					790254 00 0 00 1000	
Surcharge, for waste and overflow, with base inlet, chrome *					791227 00 0 00 1000	
Surcharge, for waste and overflow, with base inlet, for whirltubs with Jet Project, chrome *					791232 00 0 00 1000	
LED coloured light, for whirltubs with Air-System, Jet-System, Combi-System P, Durapearl-System or Jet Project					791850 00 0 00 1000	
Sound, for whirltubs with Air-System, Jet-System, Combi-System P, Durapearl-System or Jet Project					791852 00 0 00 0000	
Sound, for whirltubs with Combi-System E					791853 00 0 00 0000	

Infobox: LED coloured light or sound is not suitable for bathtubs with support / * pipe interrupt mandatory

DuraStyle Design by Matteo Thun

Bathtub rectangle, built-in or for panel

5 mm sanitary acrylic

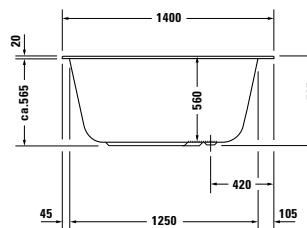
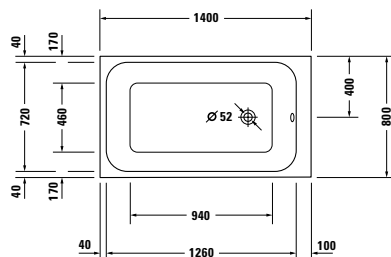

Length mm	Width mm	Depth mm	Capacity l	Weight kg	Model-No.	Euro
						White - 00
Bathtub						
1400	800	560	220	25,0	700233 00 0 00 0000	
Accessories for bathtub						
Support frame, for bathtubs and shower trays, with length > 1500 mm					790105 00 0 00 0000	
Bathtub anchors					790103 00 0 00 0000	
Rubber profile					790104 00 0 00 0000	
Waste and overflow Quadroval, chrome					791201 00 0 00 1000	
Waste and overflow Quadroval, with water inlet, chrome					791202 00 0 00 1000	
Waste and overflow, with base inlet, chrome *					791226 00 0 00 1000	
Support, for # 700233					791427 00 0 00 0000	
Support, conical for # 700233					791430 00 0 00 0000	
Surcharge, for drillings of the tub rim for faucet					790650 00 0 00 0000	
LED coloured light, with remote control for bathtubs, (white -00, chrome -10)					790840 00 0 00 * *00	
Sound					791851 00 0 00 0000	
Suitable panels s.p. 319						

Infobox: LED coloured light or sound is not suitable for bathtubs with support / LED coloured light or sound is not suitable for bathtubs with conical panel / * pipe interrupt mandatory

DuraStyle Design by Matteo Thun



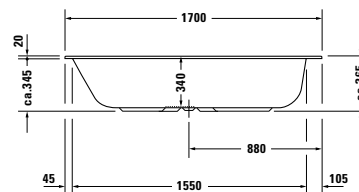
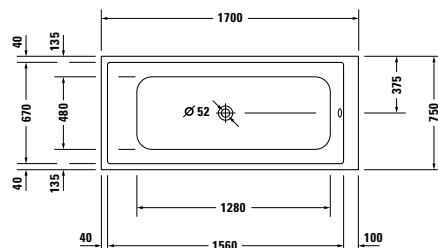

Bathtub rectangle, built-in or for panel
5 mm sanitary acrylic



Length mm	Width mm	Depth mm	Capacity l	Weight kg	Model-No.	Euro
						White - 00
Bathtub						
1700	750	340	110	23,0	700231 00 0 00 0000	
Accessories for bathtub						
Support frame, for bathtubs and shower trays, with length > 1500 mm					790105 00 0 00 0000	
Bathtub anchors					790103 00 0 00 0000	
Rubber profile					790104 00 0 00 0000	
Waste and overflow Quadroval, chrome					791203 00 0 00 1000	
Waste and overflow Quadroval, with water inlet, chrome					791204 00 0 00 1000	
Waste and overflow, with base inlet, chrome *					791230 00 0 00 1000	
Support, for # 700231					791425 00 0 00 0000	
Surcharge, for drillings of the tub rim for faucet					790650 00 0 00 0000	
LED coloured light, with remote control for bathtubs, (white -00, chrome -10)					790840 00 0 00 * 00	
Sound					791851 00 0 00 0000	
Suitable panels s.p. 319						
Suitable tub covers s.p. 510/511						

Infobox: LED coloured light or sound is not suitable for bathtubs with support / * pipe interrupt mandatory

DuraStyle Accessories Design by Matteo Thun

	Description	Model-No.	Euro
	Waste and overflow Quadroval chrome, for DuraStyle # 700233 outlet diameter 52 mm	791201 00 0 00 1000	
	Waste and overflow Quadroval with water inlet, chrome, for DuraStyle # 700233 outlet diameter 52 mm	791202 00 0 00 1000	
	Waste and overflow Quadroval chrome, for DuraStyle # 700231 outlet diameter 52 mm	791203 00 0 00 1000	
	Waste and overflow Quadroval with water inlet, chrome, for DuraStyle # 700231 outlet diameter 52 mm	791204 00 0 00 1000	

DuraStyle Design by Matteo Thun

Panels for bath- and whirltubs

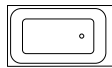

1400 x 800 mm



700233

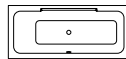

1600 x 700 mm



700292

700293

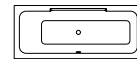

1700 x 700 mm



700294

700295

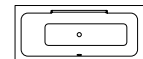

1700 x 750 mm



700296

700297

Model-No. panel



Corner left

DS 8953

DS 8785

DS 8786

DS 8787



Corner right

DS 8952

DS 8780

DS 8781

DS 8782



Back-to-wall

DS 8954

DS 8775

DS 8776

DS 8777



Niche

DS 8955

DS 8937

DS 8938

DS 8938



Freestanding, conical

DS 8951

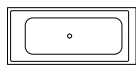

1700 x 750 mm



700231

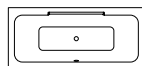

1800 x 800 mm



700298

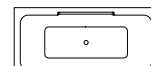

1900 x 900 mm



700299



Corner left

DS 8947

DS 8788

DS 8906



Corner right

DS 8946

DS 8783

DS 8904



Back-to-wall

DS 8948

DS 8778

DS 8902



Niche

DS 8949

DS 8939

DS 8941

A support frame is required for the installation of the panel. The support frame must be ordered separately

DuraStyle Design by Matteo Thun**Product Information**

Panel	Decor	43 Basalt Matt 52 European Oak 53 Chestnut Dark	High-density-fiberboard, with laminate (HPL) pressed on both sides. Surface resistant to moisture.
	Acryl	82 Acrylic White	8 mm Acryl solid-coloured in white

DuraStyle Design by Matteo Thun

Description	mm	Model-No.	Euro
Panel			
for corner left			
for # 700233 (1400 x 800 mm) ***	1390 x 790	DS 8953	
for # 700292 (1600 x 700 mm)	1590 x 690	DS 8785	
for # 700293 (1600 x 700 mm)	1590 x 690	DS 8785	
for # 700294 (1700 x 700 mm)	1690 x 690	DS 8786	
for # 700295 (1700 x 700 mm)	1690 x 690	DS 8786	
for # 700296 (1700 x 750 mm)	1690 x 740	DS 8787	
for # 700297 (1700 x 750 mm)	1690 x 740	DS 8787	
for # 700231 (1700 x 750 mm) **	1690 x 740	DS 8947	
for # 700298 (1800 x 800 mm)	1790 x 790	DS 8788	
for # 700299 (1900 x 900 mm)	1890 x 890	DS 8906	

Infobox: A support frame is required for the installation of the panel. The support frame must be ordered separately / Heights of DuraStyle series: Height bathtub panel = 555 mm, Height bathtub panel incl. 10 mm shadow gap = 565 mm, overall height incl. 35 mm bathtub rim = 600 mm / ** Heights of DuraStyle series: Height bathtub panel 445 mm, Height bathtub panel incl. 15 mm shadow gap = 470 mm, overall height incl. 20 mm bathtub trim = 490 mm / *** Heights of DuraStyle series: Height bathtub panel 680 mm, Height bathtub panel incl. 15 mm shadow gap = 695 mm, overall height incl. 20 mm bathtub trim = 715 mm

Panel			
for corner right			
for # 700233 (1400 x 800 mm) ***	1390 x 790	DS 8952	
for # 700292 (1600 x 700 mm)	1590 x 690	DS 8780	
for # 700293 (1600 x 700 mm)	1590 x 690	DS 8780	
for # 700294 (1700 x 700 mm)	1690 x 690	DS 8781	
for # 700295 (1700 x 700 mm)	1690 x 690	DS 8781	
for # 700296 (1700 x 750 mm)	1690 x 740	DS 8782	
for # 700297 (1700 x 750 mm)	1690 x 740	DS 8782	
for # 700231 (1700 x 750 mm) **	1690 x 740	DS 8946	
for # 700298 (1800 x 800 mm)	1790 x 790	DS 8783	
for # 700299 (1900 x 900 mm)	1890 x 890	DS 8904	

Infobox: A support frame is required for the installation of the panel. The support frame must be ordered separately / Heights of DuraStyle series: Height bathtub panel = 555 mm, Height bathtub panel incl. 10 mm shadow gap = 565 mm, overall height incl. 35 mm bathtub rim = 600 mm / ** Heights of DuraStyle series: Height bathtub panel 445 mm, Height bathtub panel incl. 15 mm shadow gap = 470 mm, overall height incl. 20 mm bathtub trim = 490 mm / *** Heights of DuraStyle series: Height bathtub panel 680 mm, Height bathtub panel incl. 15 mm shadow gap = 695 mm, overall height incl. 20 mm bathtub trim = 715 mm

Panel			
for back-to-wall version			
for # 700233 (1400 x 800 mm) ***	1380 x 790	DS 8954	
for # 700292 (1600 x 700 mm)	1580 x 690	DS 8775	
for # 700293 (1600 x 700 mm)	1580 x 690	DS 8775	
for # 700294 (1700 x 700 mm)	1580 x 690	DS 8776	
for # 700295 (1700 x 700 mm)	1580 x 690	DS 8776	
for # 700296 (1700 x 750 mm)	1680 x 740	DS 8777	
for # 700297 (1700 x 750 mm)	1680 x 740	DS 8777	
for # 700231 (1700 x 750 mm) **	1680 x 740	DS 8948	
for # 700298 (1800 x 800 mm)	1780 x 790	DS 8778	
for # 700299 (1900 x 900 mm)	1880 x 890	DS 8902	

Infobox: A support frame is required for the installation of the panel. The support frame must be ordered separately / Heights of DuraStyle series: Height bathtub panel = 555 mm, Height bathtub panel incl. 10 mm shadow gap = 565 mm, overall height incl. 35 mm bathtub rim = 600 mm / ** Heights of DuraStyle series: Height bathtub panel 445 mm, Height bathtub panel incl. 15 mm shadow gap = 470 mm, overall height incl. 20 mm bathtub trim = 490 mm / *** Heights of DuraStyle series: Height bathtub panel 680 mm, Height bathtub panel incl. 15 mm shadow gap = 695 mm, overall height incl. 20 mm bathtub trim = 715 mm

DuraStyle Design by Matteo Thun

Description	mm	Model-No.	Euro
Panel			
for niche			
for # 700233 (1400 x 800 mm) ***	1390	DS 8955	
for # 700292 (1600 x 700 mm)	1590	DS 8937	
for # 700293 (1600 x 700 mm)	1590	DS 8937	
for # 700294 (1700 x 700 mm)	1690	DS 8938	
for # 700295 (1700 x 700 mm)	1690	DS 8938	
for # 700296 (1700 x 750 mm)	1690	DS 8938	
for # 700297 (1700 x 750 mm)	1690	DS 8938	
for # 700231 (1700 x 750 mm) **	1690	DS 8949	
for # 700298 (1800 x 800 mm)	1790	DS 8939	
for # 700299 (1900 x 900 mm)	1890	DS 8941	

Infobox: A support frame is required for the installation of the panel. The support frame must be ordered separately / Heights of DuraStyle series: Height bathtub panel = 555 mm, Height bathtub panel incl. 10 mm shadow gap = 565 mm, overall height incl. 35 mm bathtub rim = 600 mm / ** Heights of DuraStyle series: Height bathtub panel 445 mm, Height bathtub panel incl. 15 mm shadow gap = 470 mm, overall height incl. 20 mm bathtub trim = 490 mm / *** Heights of DuraStyle series: Height bathtub panel 680 mm, Height bathtub panel incl. 15 mm shadow gap = 695 mm, overall height incl. 20 mm bathtub trim = 715 mm

Panel			
for freestanding bathtub, conical			
for # 700233 (1400 x 800 mm) ***	1380 x 780	DS 8951	

Infobox: A support frame is required for the installation of the panel. The support frame must be ordered separately / *** Heights of DuraStyle series: Height bathtub panel 680 mm, Height bathtub panel incl. 15 mm shadow gap = 695 mm, overall height incl. 20 mm bathtub trim = 715 mm

Esplanade Design by Sergei Tchoban

Product Information

Panel **Real wood veneer** **05** Oak

Base: solid wood, multiplex curved pasted plywood. Outside: real wood veneer, colourless lacquered. Interior finish: laminate (HPL) in (37) White Aluminium. Real wood veneer is a natural material, differences in colour and structure may occur. Surface resistant to moisture.

Esplanade Design by Sergei Tchoban

Bathtub corner left, with acrylic panel and support frame

5 mm sanitary acrylic

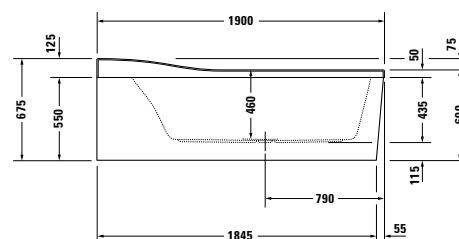
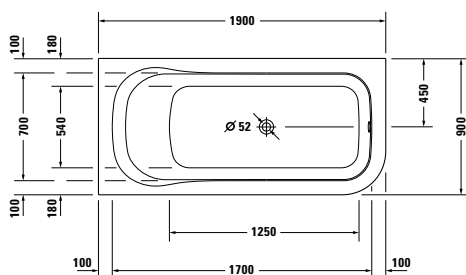

Length mm	Width mm	Depth mm	Capacity l	Weight kg	Model-No.	Euro
						White - 00
Bathtub						
1900	900	460	290	88,0	700281 00 0 00 0000	
Surcharge for whirlsystem						
Air-System					760*** 00 1 00 1000	
Jet-System					760*** 00 2 00 1000	
Combi-System P					760*** 00 3 00 1000	
Combi-System E					760*** 00 4 16 1000	
Combi-System L					710*** 00 5 00 1000	
Additional modules for whirltub						
Additional modules for Combi-System E				Module-No.		
LED coloured light (replaces LED white light)				06		
Heating				07		
UV Hygiene Management				08		
Additional modules for Combi-System L				Module-No.		
LED coloured light (replaces white light)				06		
Temperature L				07		
UV Hygiene Management				08		
Accessories for bath- and whirltub						
Headrest, white					790005 00 0 00 0000	
Bathtub anchors					790103 00 0 00 0000	
Rubber profile					790104 00 0 00 0000	
Accessories for bathtub						
Waste and overflow Quadroval, chrome					790297 00 0 00 1000	
Waste and overflow Quadroval, with water inlet, chrome					790298 00 0 00 1000	
Waste and overflow, with base inlet, chrome *					791230 00 0 00 1000	
Surcharge, for drillings of the tub rim for faucet, (not possible for whirltub)					790650 00 0 00 0000	
LED coloured light, with remote control for bathtubs, (white -00, chrome -10)					790840 00 0 00 * 00	
Sound					791851 00 0 00 0000	
Accessories for whirltub						
Surcharge, for waste and overflow Quadroval, with water inlet, chrome					791207 00 0 00 1000	
Surcharge, for waste and overflow, with base inlet, chrome *					791231 00 0 00 1000	
LED coloured light, for whirltubs with Air-System, Jet-System, Combi-System P, Durapearl-System or Jet Project					791850 00 0 00 1000	
Sound, for whirltubs with Air-System, Jet-System, Combi-System P, Durapearl-System or Jet Project					791852 00 0 00 0000	
Sound, for whirltubs with Combi-System E					791853 00 0 00 0000	

Infobox: * pipe interrupt mandatory

Esplanade Design by Sergei Tchoban

Bathtub corner right, with acrylic panel and support frame

5 mm sanitary acrylic

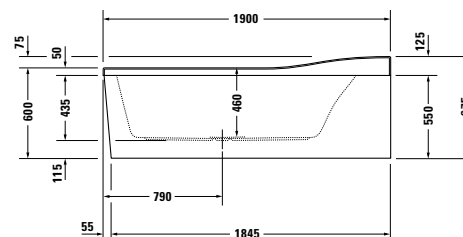
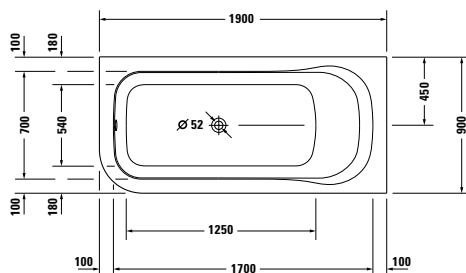

Length mm	Width mm	Depth mm	Capacity l	Weight kg	Model-No.	Euro
						White - 00
Bathtub						
1900	900	460	290	88,0	700282 00 0 00 0000	
Surcharge for whirlsystem						
Air-System					760*** 00 1 00 1000	
Jet-System					760*** 00 2 00 1000	
Combi-System P					760*** 00 3 00 1000	
Combi-System E					760*** 00 4 16 1000	
Combi-System L					710*** 00 5 00 1000	
Additional modules for whirltub						
Additional modules for Combi-System E				Module-No.		
LED coloured light (replaces LED white light)				06		
Heating				07		
UV Hygiene Management				08		
Additional modules for Combi-System L				Module-No.		
LED coloured light (replaces white light)				06		
Temperature L				07		
UV Hygiene Management				08		
Accessories for bath- and whirltub						
Headrest, white					790005 00 0 00 0000	
Bathtub anchors					790103 00 0 00 0000	
Rubber profile					790104 00 0 00 0000	
Accessories for bathtub						
Waste and overflow Quadroval, chrome					790297 00 0 00 1000	
Waste and overflow Quadroval, with water inlet, chrome					790298 00 0 00 1000	
Waste and overflow, with base inlet, chrome *					791230 00 0 00 1000	
Surcharge, for drillings of the tub rim for faucet, (not possible for whirltub)					790650 00 0 00 0000	
LED coloured light, with remote control for bathtubs, (white -00, chrome -10)					790840 00 0 00 * 00	
Sound					791851 00 0 00 0000	
Accessories for whirltub						
Surcharge, for waste and overflow Quadroval, with water inlet, chrome					791207 00 0 00 1000	
Surcharge, for waste and overflow, with base inlet, chrome *					791231 00 0 00 1000	
LED coloured light, for whirltubs with Air-System, Jet-System, Combi-System P, Durapearl-System or Jet Project					791850 00 0 00 1000	
Sound, for whirltubs with Air-System, Jet-System, Combi-System P, Durapearl-System or Jet Project					791852 00 0 00 0000	
Sound, for whirltubs with Combi-System E					791853 00 0 00 0000	

Info: * pipe interrupt mandatory

Esplanade Design by Sergei Tchoban

Bathtub back-to-wall, with acrylic panel and support frame

5 mm sanitary acrylic

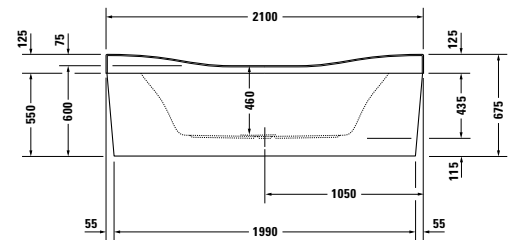
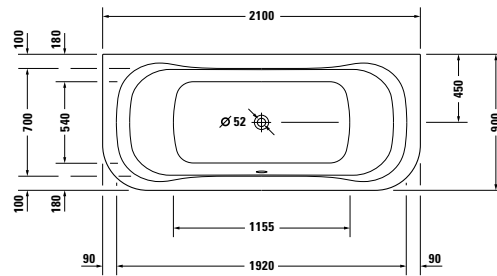

Length mm	Width mm	Depth mm	Capacity l	Weight kg	Model-No.	Euro
						White - 00
Bathtub						
2100	900	460	285	96,0	700283 00 0 00 0000	
Surcharge for whirlsystem						
Air-System					760*** 00 1 00 1000	
Jet-System					760*** 00 2 00 1000	
Combi-System P					760*** 00 3 00 1000	
Combi-System E					760*** 00 4 16 1000	
Combi-System L					710*** 00 5 00 1000	
Additional modules for whirltub						
Additional modules for Combi-System E				Module-No.		
LED coloured light (replaces LED white light)				06		
Heating				07		
UV Hygiene Management				08		
Additional modules for Combi-System L				Module-No.		
LED coloured light (replaces white light)				06		
Temperature L				07		
UV Hygiene Management				08		
Accessories for bath- and whirltub						
Headrest, white					790005 00 0 00 0000	
Bathtub anchors					790103 00 0 00 0000	
Rubber profile					790104 00 0 00 0000	
Accessories for bathtub						
Waste and overflow Quadroval, chrome					790293 00 0 00 1000	
Waste and overflow Quadroval, with water inlet, chrome					790294 00 0 00 1000	
Waste and overflow, with base inlet, chrome *					791230 00 0 00 1000	
Surcharge, for drillings of the tub rim for faucet, (not possible for whirltub)					790650 00 0 00 0000	
LED coloured light, with remote control for bathtubs, (white -00, chrome -10)					790840 00 0 00 * 00	
Sound					791851 00 0 00 0000	
Accessories for whirltub						
Surcharge, for waste and overflow Quadroval, with water inlet, chrome					791207 00 0 00 1000	
Surcharge, for waste and overflow, with base inlet, chrome *					791231 00 0 00 1000	
LED coloured light, for whirltubs with Air-System, Jet-System, Combi-System P, Durapearl-System or Jet Project					791850 00 0 00 1000	
Sound, for whirltubs with Air-System, Jet-System, Combi-System P, Durapearl-System or Jet Project					791852 00 0 00 0000	
Sound, for whirltubs with Combi-System E					791853 00 0 00 0000	

Infobox: * pipe interrupt mandatory

Esplanade Design by Sergei Tchoban

Bathtub freestanding, with acrylic panel and support frame

5 mm sanitary acrylic

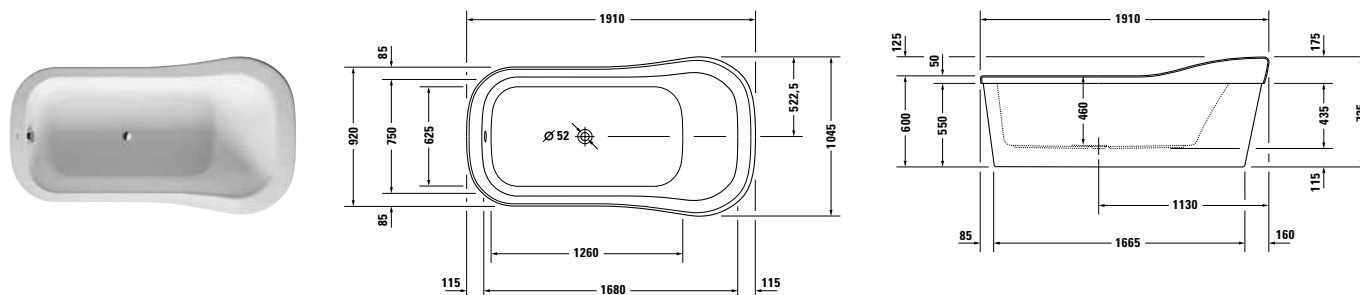

Length mm	Width mm	Depth mm	Capacity l	Weight kg	Model-No.	Euro
						White - 00
Bathtub						
1910	1045	460	307	96,0	700284 00 0 00 0000	
Surcharge for whirlsystem						
Air-System					760*** 00 1 00 1000	
Jet-System					760*** 00 2 00 1000	
Combi-System P					760*** 00 3 00 1000	
Combi-System E					760*** 00 4 16 1000	
Combi-System L					710*** 00 5 00 1000	
Additional modules for whirltub						
Additional modules for Combi-System E				Module-No.		
LED coloured light (replaces LED white light)				06		
Heating				07		
UV Hygiene Management				08		
Additional modules for Combi-System L				Module-No.		
LED coloured light (replaces white light)				06		
Temperature L				07		
UV Hygiene Management				08		
Accessories for bath- and whirltub						
Headrest, white					790005 00 0 00 0000	
Accessories for bathtub						
Waste and overflow Quadroval, chrome					790299 00 0 00 1000	
Waste and overflow Quadroval, with water inlet, chrome					791200 00 0 00 1000	
Waste and overflow, with base inlet, chrome *					791235 00 0 00 1000	
LED coloured light, with remote control for bathtubs, (white -00, chrome -10)					790840 00 0 00 * 00	
Sound					791851 00 0 00 0000	
Accessories for whirltub						
Surcharge, for waste and overflow Quadroval, with water inlet, chrome					791207 00 0 00 1000	
Surcharge, for waste and overflow, with base inlet, chrome *					791231 00 0 00 1000	
LED coloured light, for whirltubs with Air-System, Jet-System, Combi-System P, Durapearl-System or Jet Project					791850 00 0 00 1000	
Sound, for whirltubs with Air-System, Jet-System, Combi-System P, Durapearl-System or Jet Project					791852 00 0 00 0000	
Sound, for whirltubs with Combi-System E					791853 00 0 00 0000	

Infobox: * pipe interrupt mandatory

Esplanade Design by Sergei Tchoban

Bathtub corner left, with panel and support frame, in Oak
5 mm sanitary acrylic

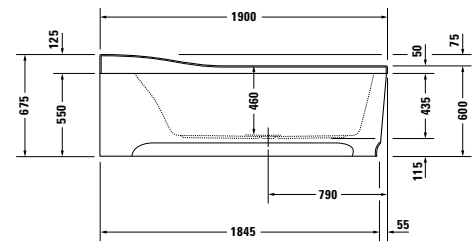
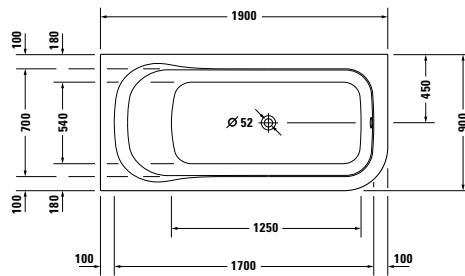

Length mm	Width mm	Depth mm	Capacity l	Weight kg	Model-No.	Euro
						White - 00
Bathtub						
1900	900	460	290	81,0	700288 05 0 00 0000	
Surcharge for whirlsystem						
Air-System					760*** 05 1 00 1000	
Jet-System					760*** 05 2 00 1000	
Combi-System P					760*** 05 3 00 1000	
Combi-System E					760*** 05 4 16 1000	
Combi-System L					710*** 05 5 00 1000	
Additional modules for whirltub						
Additional modules for Combi-System E				Module-No.		
LED coloured light (replaces LED white light)				06		
Heating				07		
UV Hygiene Management				08		
Additional modules for Combi-System L				Module-No.		
LED coloured light (replaces white light)				06		
Temperature L				07		
UV Hygiene Management				08		
Accessories for bath- and whirltub						
Headrest, white					790005 00 0 00 0000	
Bathtub anchors					790103 00 0 00 0000	
Rubber profile					790104 00 0 00 0000	
Accessories for bathtub						
Waste and overflow Quadroval, chrome					790297 00 0 00 1000	
Waste and overflow Quadroval, with water inlet, chrome					790298 00 0 00 1000	
Waste and overflow, with base inlet, chrome *					791230 00 0 00 1000	
Surcharge, for drillings of the tub rim for faucet, (not possible for whirltub)					790650 00 0 00 0000	
LED coloured light, with remote control for bathtubs, (white -00, chrome -10)					790840 00 0 00 * 00	
Sound					791851 00 0 00 0000	
Accessories for whirltub						
Surcharge, for waste and overflow Quadroval, with water inlet, chrome					791207 00 0 00 1000	
Surcharge, for waste and overflow, with base inlet, chrome *					791231 00 0 00 1000	
LED coloured light, for whirltubs with Air-System, Jet-System, Combi-System P, Durapearl-System or Jet Project					791850 00 0 00 1000	
Sound, for whirltubs with Air-System, Jet-System, Combi-System P, Durapearl-System or Jet Project					791852 00 0 00 0000	
Sound, for whirltubs with Combi-System E					791853 00 0 00 0000	

Infobox: * pipe interrupt mandatory

Esplanade Design by Sergei Tchoban

Bathtub corner right, with panel and support frame, in Oak

5 mm sanitary acrylic

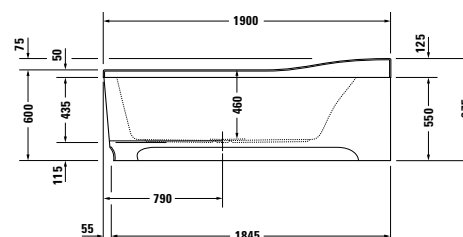
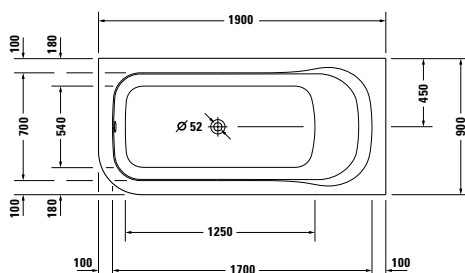

Length mm	Width mm	Depth mm	Capacity l	Weight kg	Model-No.	Euro
						White - 00
Bathtub						
1900	900	460	290	81,0	700289 05 0 00 0000	
Surcharge for whirlsystem						
Air-System					760*** 05 1 00 1000	
Jet-System					760*** 05 2 00 1000	
Combi-System P					760*** 05 3 00 1000	
Combi-System E					760*** 05 4 16 1000	
Combi-System L					710*** 05 5 00 1000	
Additional modules for whirltub						
Additional modules for Combi-System E				Module-No.		
LED coloured light (replaces LED white light)				06		
Heating				07		
UV Hygiene Management				08		
Additional modules for Combi-System L				Module-No.		
LED coloured light (replaces white light)				06		
Temperature L				07		
UV Hygiene Management				08		
Accessories for bath- and whirltub						
Headrest, white					790005 00 0 00 0000	
Bathtub anchors					790103 00 0 00 0000	
Rubber profile					790104 00 0 00 0000	
Accessories for bathtub						
Waste and overflow Quadroval, chrome					790297 00 0 00 1000	
Waste and overflow Quadroval, with water inlet, chrome					790298 00 0 00 1000	
Waste and overflow, with base inlet, chrome *					791230 00 0 00 1000	
Surcharge, for drillings of the tub rim for faucet, (not possible for whirltub)					790650 00 0 00 0000	
LED coloured light, with remote control for bathtubs, (white -00, chrome -10)					790840 00 0 00 * 00	
Sound					791851 00 0 00 0000	
Accessories for whirltub						
Surcharge, for waste and overflow Quadroval, with water inlet, chrome					791207 00 0 00 1000	
Surcharge, for waste and overflow, with base inlet, chrome *					791231 00 0 00 1000	
LED coloured light, for whirltubs with Air-System, Jet-System, Combi-System P, Durapearl-System or Jet Project					791850 00 0 00 1000	
Sound, for whirltubs with Air-System, Jet-System, Combi-System P, Durapearl-System or Jet Project					791852 00 0 00 0000	
Sound, for whirltubs with Combi-System E					791853 00 0 00 0000	

Infobox: * pipe interrupt mandatory

Esplanade Design by Sergei Tchoban

Bathtub back-to-wall, with panel and support frame, in Oak

5 mm sanitary acrylic

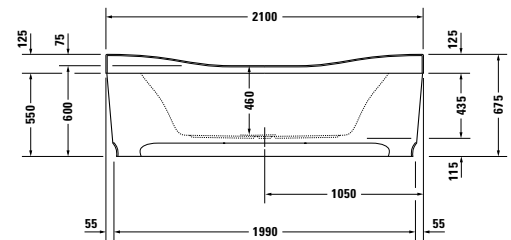
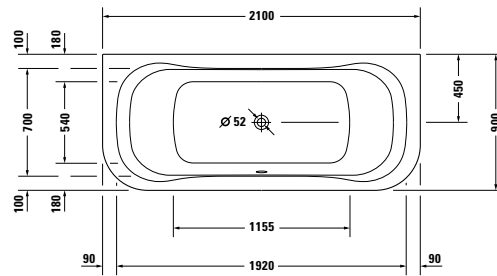

Length mm	Width mm	Depth mm	Capacity l	Weight kg	Model-No.	Euro
						White - 00
Bathtub						
2100	900	460	285	94,0	700290 05 0 00 0000	
Surcharge for whirlsystem						
Air-System					760*** 05 1 00 1000	
Jet-System					760*** 05 2 00 1000	
Combi-System P					760*** 05 3 00 1000	
Combi-System E					760*** 05 4 16 1000	
Combi-System L					710*** 05 5 00 1000	
Additional modules for whirltub						
Additional modules for Combi-System E				Module-No.		
LED coloured light (replaces LED white light)				06		
Heating				07		
UV Hygiene Management				08		
Additional modules for Combi-System L				Module-No.		
LED coloured light (replaces white light)				06		
Temperature L				07		
UV Hygiene Management				08		
Accessories for bath- and whirltub						
Headrest, white					790005 00 0 00 0000	
Bathtub anchors					790103 00 0 00 0000	
Rubber profile					790104 00 0 00 0000	
Accessories for bathtub						
Waste and overflow Quadroval, chrome					790293 00 0 00 1000	
Waste and overflow Quadroval, with water inlet, chrome					790294 00 0 00 1000	
Waste and overflow, with base inlet, chrome *					791230 00 0 00 1000	
Surcharge, for drillings of the tub rim for faucet, (not possible for whirltub)					790650 00 0 00 0000	
LED coloured light, with remote control for bathtubs, (white -00, chrome -10)					790840 00 0 00 * 00	
Sound					791851 00 0 00 0000	
Accessories for whirltub						
Surcharge, for waste and overflow Quadroval, with water inlet, chrome					791207 00 0 00 1000	
Surcharge, for waste and overflow, with base inlet, chrome *					791231 00 0 00 1000	
LED coloured light, for whirltubs with Air-System, Jet-System, Combi-System P, Durapearl-System or Jet Project					791850 00 0 00 1000	
Sound, for whirltubs with Air-System, Jet-System, Combi-System P, Durapearl-System or Jet Project					791852 00 0 00 0000	
Sound, for whirltubs with Combi-System E					791853 00 0 00 0000	

Infobox: * pipe interrupt mandatory

Esplanade Design by Sergei Tchoban

Bathtub freestanding, with panel and support frame, in Oak

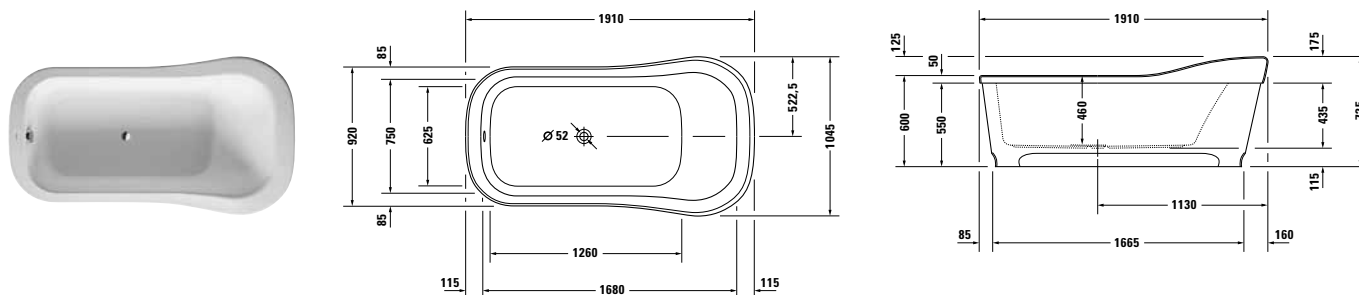

5 mm sanitary acrylic



Length mm	Width mm	Depth mm	Capacity l	Weight kg	Model-No.	Euro
						White - 00
Bathtub						
1910	1045	460	307	88,0	700291 05 0 00 0000	
Surcharge for whirlsystem						
Air-System					760*** 05 1 00 1000	
Jet-System					760*** 05 2 00 1000	
Combi-System P					760*** 05 3 00 1000	
Combi-System E					760*** 05 4 16 1000	
Combi-System L					710*** 05 5 00 1000	
Additional modules for whirltub						
Additional modules for Combi-System E				Module-No.		
LED coloured light (replaces LED white light)				06		
Heating				07		
UV Hygiene Management				08		
Additional modules for Combi-System L				Module-No.		
LED coloured light (replaces white light)				06		
Temperature L				07		
UV Hygiene Management				08		
Accessories for bath- and whirltub						
Headrest, white					790005 00 0 00 0000	
Accessories for bathtub						
Waste and overflow Quadroval, chrome					790299 00 0 00 1000	
Waste and overflow Quadroval, with water inlet, chrome					791200 00 0 00 1000	
Waste and overflow, with base inlet, chrome *					791235 00 0 00 1000	
LED coloured light, with remote control for bathtubs, (white -00, chrome -10)					790840 00 0 00 * 00	
Sound					791851 00 0 00 0000	
Accessories for whirltub						
Surcharge, for waste and overflow Quadroval, with water inlet, chrome					791207 00 0 00 1000	
Surcharge, for waste and overflow, with base inlet, chrome *					791231 00 0 00 1000	
LED coloured light, for whirltubs with Air-System, Jet-System, Combi-System P, Durapearl-System or Jet Project					791850 00 0 00 1000	
Sound, for whirltubs with Air-System, Jet-System, Combi-System P, Durapearl-System or Jet Project					791852 00 0 00 0000	
Sound, for whirltubs with Combi-System E					791853 00 0 00 0000	

Infobox: * pipe interrupt mandatory

Esplanade Accessories Design by Sergei Tchoban

	Description	Model-No.	Euro
	Headrest white, for Esplanade material: polyurethane	790005 00 0 00 0000	
	Waste and overflow Quadroval chrome, for bathtubs outlet diameter 52 mm	790297 00 0 00 1000	
	Waste and overflow Quadroval with water inlet, chrome, for bathtubs, (pipe interrupt necessary) outlet diameter 52 mm	790298 00 0 00 1000	

Happy D.2 Design by sieger design

Bathtub rectangle, built-in, with one backrest slope left
5 mm sanitary acrylic

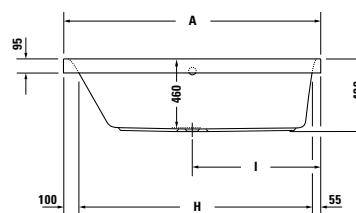
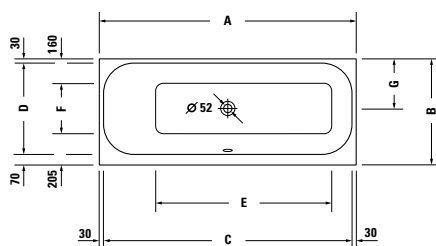

	A	B	C	D	E	F	G	H	I
700308	1600	700	1540	600	1055	335	330	1445	800
700310	1700	700	1640	600	1165	335	330	1545	850
700312	1700	750	1640	650	1165	385	355	1545	850

Length mm	Width mm	Depth mm	Capacity l	Weight kg	Model-No.	Euro
						White - 00
Bathtub						
1600	700	460	145	32,0	700308 00 0 00 0000	
1700	700	460	150	34,0	700310 00 0 00 0000	
1700	750	460	180	36,0	700312 00 0 00 0000	
Surcharge for whirlsystem						
Air-System					760*** 00 1 00 1000	
Jet-System					760*** 00 2 00 1000	
Combi-System P					760*** 00 3 00 1000	
Combi-System E					760*** 00 4 16 1000	
Combi-System L					710*** 00 5 00 1000	
Additional modules for whirltub						
Additional modules for Combi-System E				Module-No.		
LED coloured light (replaces LED white light)				06		
Heating				07		
UV Hygiene Management				08		
Additional modules for Combi-System L				Module-No.		
LED coloured light (replaces white light)				06		
Temperature L				07		
UV Hygiene Management				08		
Accessories for bath- and whirltub						
Headrest, white					790009 00 0 00 0000	
Bathtub anchors					790103 00 0 00 0000	
Rubber profile					790104 00 0 00 0000	

continued on following page

Happy D.2 Design by sieger design

Bathtub rectangle, built-in, with one backrest slope left
5 mm sanitary acrylic

Length mm	Width mm	Depth mm	Capacity l	Weight kg	Model-No.	Euro	
						White	- 00
Bathtub							
1600	700	460	145	32,0	700308 00 0 00 0000		
1700	700	460	150	34,0	700310 00 0 00 0000		
1700	750	460	180	36,0	700312 00 0 00 0000		
Accessories for bathtub							
Support frame, for bathtubs and shower trays, with length > 1000 mm					790100 00 0 00 0000		
Waste and overflow Quadroval, chrome					791221 00 0 00 1000		
Waste and overflow Quadroval, with water inlet, chrome					791222 00 0 00 1000		
Support, for # 700308 / 700309					791468 00 0 00 0000		
Support, for # 700310 / 700311					791470 00 0 00 0000		
Support, for # 700312 / 700313					791472 00 0 00 0000		
LED coloured light, with remote control for bathtubs, (white -00, chrome -10)					790840 00 0 00 * 00		
Sound					791851 00 0 00 0000		
Suitable tub covers s.p. 510/511							
Accessories for whirltub							
Surcharge, for waste and overflow Quadroval, with water inlet, chrome					791206 00 0 00 1000		
LED coloured light, for whirltubs with Air-System, Jet-System, Combi-System P, Durapearl-System or Jet Project					791850 00 0 00 1000		
Sound, for whirltubs with Air-System, Jet-System, Combi-System P, Durapearl-System or Jet Project					791852 00 0 00 0000		
Sound, for whirltubs with Combi-System E					791853 00 0 00 0000		

Infobox: LED coloured light or sound is not suitable for bathtubs with support

Happy D.2 Design by sieger design

Bathtub rectangle, built-in, with one backrest slope right

5 mm sanitary acrylic

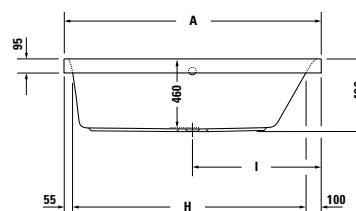
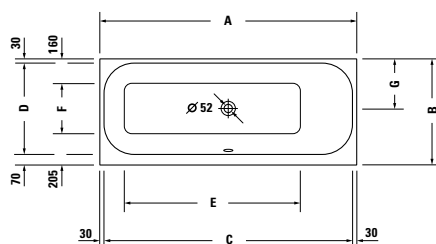

	A	B	C	D	E	F	G	H	I
700309	1600	700	1540	600	1055	335	330	1445	800
700311	1700	700	1640	600	1165	335	330	1545	850
700313	1700	750	1640	650	1165	385	355	1545	850

Length mm	Width mm	Depth mm	Capacity l	Weight kg	Model-No.	Euro
						White - 00
Bathtub						
1600	700	460	145	32,0	700309 00 0 00 0000	
1700	700	460	150	34,0	700311 00 0 00 0000	
1700	750	460	180	36,0	700313 00 0 00 0000	
Surcharge for whirlsystem						
Air-System					760*** 00 1 00 1000	
Jet-System					760*** 00 2 00 1000	
Combi-System P					760*** 00 3 00 1000	
Combi-System E					760*** 00 4 16 1000	
Combi-System L					710*** 00 5 00 1000	
Additional modules for whirltub						
Additional modules for Combi-System E				Module-No.		
LED coloured light (replaces LED white light)				06		
Heating				07		
UV Hygiene Management				08		
Additional modules for Combi-System L				Module-No.		
LED coloured light (replaces white light)				06		
Temperature L				07		
UV Hygiene Management				08		
Accessories for bath- and whirltub						
Headrest, white					790009 00 0 00 0000	
Bathtub anchors					790103 00 0 00 0000	
Rubber profile					790104 00 0 00 0000	

continued on following page

Happy D.2 Design by sieger design

Bathtub rectangle, built-in, with one backrest slope right
5 mm sanitary acrylic

Length mm	Width mm	Depth mm	Capacity l	Weight kg	Model-No.	Euro	
						White	- 00
Bathtub							
1600	700	460	145	32,0	700309 00 0 00 0000		
1700	700	460	150	34,0	700311 00 0 00 0000		
1700	750	460	180	36,0	700313 00 0 00 0000		
Accessories for bathtub							
Support frame, for bathtubs and shower trays, with length > 1000 mm					790100 00 0 00 0000		
Waste and overflow Quadroval, chrome					791221 00 0 00 1000		
Waste and overflow Quadroval, with water inlet, chrome					791222 00 0 00 1000		
Support, for # 700308 / 700309					791468 00 0 00 0000		
Support, for # 700310 / 700311					791470 00 0 00 0000		
Support, for # 700312 / 700313					791472 00 0 00 0000		
LED coloured light, with remote control for bathtubs, (white -00, chrome -10)					790840 00 0 00 * 00		
Sound					791851 00 0 00 0000		
Suitable tub covers s.p. 510/511							
Accessories for whirltub							
Surcharge, for waste and overflow Quadroval, with water inlet, chrome					791206 00 0 00 1000		
LED coloured light, for whirltubs with Air-System, Jet-System, Combi-System P, Durapearl-System or Jet Project					791850 00 0 00 1000		
Sound, for whirltubs with Air-System, Jet-System, Combi-System P, Durapearl-System or Jet Project					791852 00 0 00 0000		
Sound, for whirltubs with Combi-System E					791853 00 0 00 0000		

Infobox: LED coloured light or sound is not suitable for bathtubs with support

Happy D.2 Design by sieger design

Bathtub rectangle, built-in, with two backrest slopes
5 mm sanitary acrylic

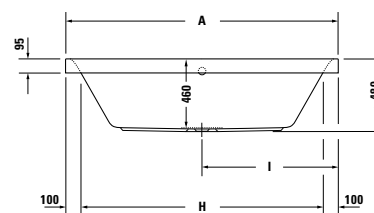
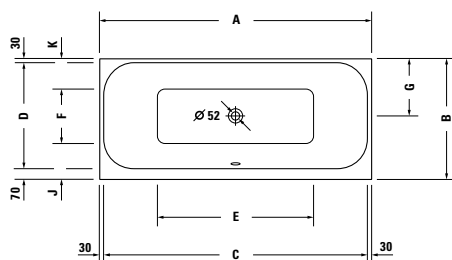

	A	B	C	D	E	F	G	H	I	J	K
700314	1800	800	1740	700	1030	360	380	1600	900	240	200
700315	1900	900	1840	800	1130	465	430	1700	950	235	200

Length mm	Width mm	Depth mm	Capacity l	Weight kg	Model-No.	Euro
						White - 00
Bathtub						
1800	800	460	180	39,0	700314 00 0 00 0000	
1900	900	460	260	41,0	700315 00 0 00 0000	
Surcharge for whirlsystem						
Air-System					760*** 00 1 00 1000	
Jet-System					760*** 00 2 00 1000	
Combi-System P					760*** 00 3 00 1000	
Combi-System E					760*** 00 4 16 1000	
Combi-System L					710*** 00 5 00 1000	
Additional modules for whirltub						
Additional modules for Combi-System E				Module-No.		
LED coloured light (replaces LED white light)				06		
Heating				07		
UV Hygiene Management				08		
Additional modules for Combi-System L				Module-No.		
LED coloured light (replaces white light)				06		
Temperature L				07		
UV Hygiene Management				08		
Accessories for bath- and whirltub						
Headrest, white					790009 00 0 00 0000	
Bathtub anchors					790103 00 0 00 0000	
Rubber profile					790104 00 0 00 0000	
continued on following page						

Happy D.2 Design by sieger design

Bathtub rectangle, built-in, with two backrest slopes
5 mm sanitary acrylic

Length mm	Width mm	Depth mm	Capacity l	Weight kg	Model-No.	Euro	
						White	- 00
Bathtub							
1800	800	460	180	39,0	700314 00 0 00 0000		
1900	900	460	260	41,0	700315 00 0 00 0000		
Accessories for bathtub							
Support frame, for bathtubs and shower trays, with length > 1000 mm					790100 00 0 00 0000		
Waste and overflow Quadroval, chrome					791221 00 0 00 1000		
Waste and overflow Quadroval, with water inlet, chrome					791222 00 0 00 1000		
Waste and overflow, with base inlet, chrome *					791226 00 0 00 1000		
Support, for # 700314					791474 00 0 00 0000		
Support, for # 700315					791475 00 0 00 0000		
LED coloured light, with remote control for bathtubs, (white -00, chrome -10)					790840 00 0 00 * 00		
Sound					791851 00 0 00 0000		
Suitable tub covers s.p. 510/511							
Accessories for whirltub							
Surcharge, for waste and overflow Quadroval, with water inlet, chrome					791206 00 0 00 1000		
Surcharge, for waste and overflow, with base inlet, chrome *					791227 00 0 00 1000		
LED coloured light, for whirltubs with Air-System, Jet-System, Combi-System P, Durapearl-System or Jet Project					791850 00 0 00 1000		
Sound, for whirltubs with Air-System, Jet-System, Combi-System P, Durapearl-System or Jet Project					791852 00 0 00 0000		
Sound, for whirltubs with Combi-System E					791853 00 0 00 0000		

Infobox: * pipe interrupt mandatory / LED coloured light or sound is not suitable for bathtubs with support

Happy D.2 Design by sieger design

Bathtub corner left, with integrated acrylic panel and support frame

5 mm sanitary acrylic

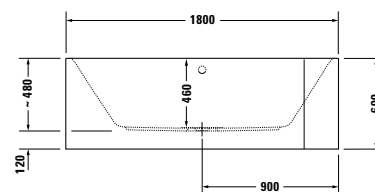
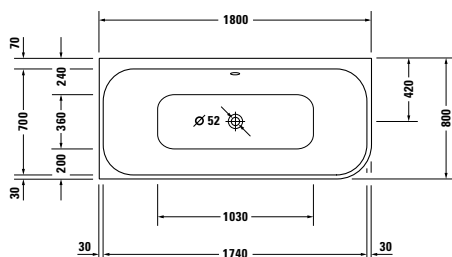

Length mm	Width mm	Depth mm	Capacity l	Weight kg	Model-No.	Euro
						White - 00
Bathtub						
1800	800	460	180	64,0	700316 00 0 00 0000	
Surcharge for whirlsystem						
Air-System					760*** 00 1 00 1000	
Jet-System					760*** 00 2 00 1000	
Combi-System P					760*** 00 3 00 1000	
Combi-System E					760*** 00 4 16 1000	
Combi-System L					710*** 00 5 00 1000	
Additional modules for whirltub						
Additional modules for Combi-System E				Module-No.		
LED coloured light (replaces LED white light)				06		
Heating				07		
UV Hygiene Management				08		
Additional modules for Combi-System L				Module-No.		
LED coloured light (replaces white light)				06		
Temperature L				07		
UV Hygiene Management				08		
Accessories for bath- and whirltub						
Headrest, white					790009 00 0 00 0000	
Rubber profile					790104 00 0 00 0000	
Accessories for bathtub						
Waste and overflow Quadroval, chrome					791219 00 0 00 1000	
Waste and overflow Quadroval, with water inlet, chrome					791220 00 0 00 1000	
Waste and overflow, with base inlet, chrome *					791228 00 0 00 1000	
LED coloured light, with remote control for bathtubs, (white -00, chrome -10)					790840 00 0 00 * 00	
Sound					791851 00 0 00 0000	
Accessories for whirltub						
Surcharge, for waste and overflow Quadroval, with water inlet, chrome					791206 00 0 00 1000	
Surcharge, for waste and overflow, with base inlet, chrome *					791229 00 0 00 1000	
LED coloured light, for whirltubs with Air-System, Jet-System, Combi-System P, Durapearl-System or Jet Project					791850 00 0 00 1000	
Sound, for whirltubs with Air-System, Jet-System, Combi-System P, Durapearl-System or Jet Project					791852 00 0 00 0000	
Sound, for whirltubs with Combi-System E					791853 00 0 00 0000	

Infobox: Please note that the integrated panel has a draft angle due to the production process, i.e. it runs not vertical down / * pipe interrupt mandatory

Happy D.2 Design by sieger design

Bathtub corner right, with integrated acrylic panel and support frame

5 mm sanitary acrylic

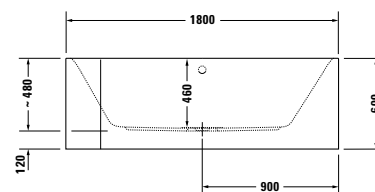
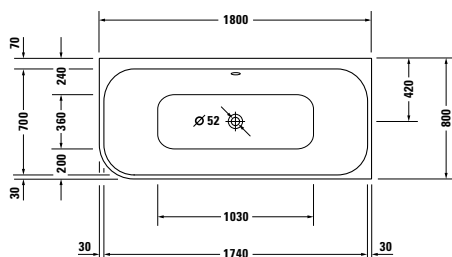

Length mm	Width mm	Depth mm	Capacity l	Weight kg	Model-No.	Euro
						White - 00
Bathtub						
1800	800	460	180	64,0	700317 00 0 00 0000	
Surcharge for whirlsystem						
Air-System					760*** 00 1 00 1000	
Jet-System					760*** 00 2 00 1000	
Combi-System P					760*** 00 3 00 1000	
Combi-System E					760*** 00 4 16 1000	
Combi-System L					710*** 00 5 00 1000	
Additional modules for whirltub						
Additional modules for Combi-System E				Module-No.		
LED coloured light (replaces LED white light)				06		
Heating				07		
UV Hygiene Management				08		
Additional modules for Combi-System L				Module-No.		
LED coloured light (replaces white light)				06		
Temperature L				07		
UV Hygiene Management				08		
Accessories for bath- and whirltub						
Headrest, white					790009 00 0 00 0000	
Rubber profile					790104 00 0 00 0000	
Accessories for bathtub						
Waste and overflow Quadroval, chrome					791219 00 0 00 1000	
Waste and overflow Quadroval, with water inlet, chrome					791220 00 0 00 1000	
Waste and overflow, with base inlet, chrome *					791228 00 0 00 1000	
LED coloured light, with remote control for bathtubs, (white -00, chrome -10)					790840 00 0 00 * 00	
Sound					791851 00 0 00 0000	
Accessories for whirltub						
Surcharge, for waste and overflow Quadroval, with water inlet, chrome					791206 00 0 00 1000	
Surcharge, for waste and overflow, with base inlet, chrome *					791229 00 0 00 1000	
LED coloured light, for whirltubs with Air-System, Jet-System, Combi-System P, Durapearl-System or Jet Project					791850 00 0 00 1000	
Sound, for whirltubs with Air-System, Jet-System, Combi-System P, Durapearl-System or Jet Project					791852 00 0 00 0000	
Sound, for whirltubs with Combi-System E					791853 00 0 00 0000	

Infobox: Please note that the integrated panel has a draft angle due to the production process, i.e. it runs not vertical down / * pipe interrupt mandatory

Happy D.2 Design by sieger design

Bathtub back-to-wall, with integrated acrylic panel and support frame

5 mm sanitary acrylic

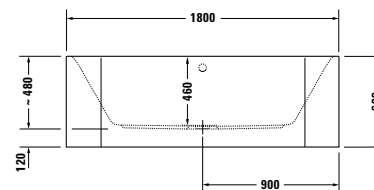
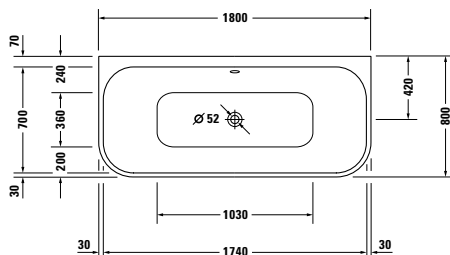

Length mm	Width mm	Depth mm	Capacity l	Weight kg	Model-No.	Euro
						White - 00
Bathtub						
1800	800	460	180	68,0	700318 00 0 00 0000	
Surcharge for whirlsystem						
Air-System					760*** 00 1 00 1000	
Jet-System					760*** 00 2 00 1000	
Combi-System P					760*** 00 3 00 1000	
Combi-System E					760*** 00 4 16 1000	
Combi-System L					710*** 00 5 00 1000	
Additional modules for whirltub						
Additional modules for Combi-System E				Module-No.		
LED coloured light (replaces LED white light)				06		
Heating				07		
UV Hygiene Management				08		
Additional modules for Combi-System L				Module-No.		
LED coloured light (replaces white light)				06		
Temperature L				07		
UV Hygiene Management				08		
Accessories for bath- and whirltub						
Headrest, white					790009 00 0 00 0000	
Rubber profile					790104 00 0 00 0000	
Accessories for bathtub						
Waste and overflow Quadroval, chrome					791219 00 0 00 1000	
Waste and overflow Quadroval, with water inlet, chrome					791220 00 0 00 1000	
Waste and overflow, with base inlet, chrome *					791228 00 0 00 1000	
LED coloured light, with remote control for bathtubs, (white -00, chrome -10)					790840 00 0 00 * 00	
Sound					791851 00 0 00 0000	
Accessories for whirltub						
Surcharge, for waste and overflow Quadroval, with water inlet, chrome					791206 00 0 00 1000	
Surcharge, for waste and overflow, with base inlet, chrome *					791229 00 0 00 1000	
LED coloured light, for whirltubs with Air-System, Jet-System, Combi-System P, Durapearl-System or Jet Project					791850 00 0 00 1000	
Sound, for whirltubs with Air-System, Jet-System, Combi-System P, Durapearl-System or Jet Project					791852 00 0 00 0000	
Sound, for whirltubs with Combi-System E					791853 00 0 00 0000	

Infobox: Please note that the integrated panel has a draft angle due to the production process, i.e. it runs not vertical down / * pipe interrupt mandatory

Happy D.2 Design by sieger design

Bathtub freestanding, with acrylic panel and support frame

5 mm sanitary acrylic

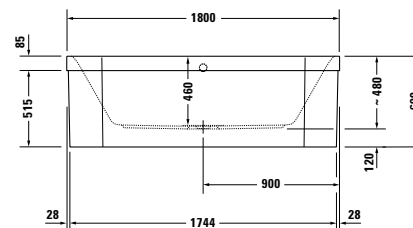
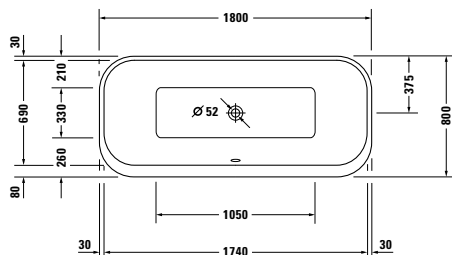

Length mm	Width mm	Depth mm	Capacity l	Weight kg	Model-No.	Euro
						White - 00
Bathtub						
1800	800	460	170	78,0	700319 00 0 00 0000	
Surcharge for whirlsystem						
Air-System					760*** 00 1 00 1000	
Jet-System					760*** 00 2 00 1000	
Combi-System P					760*** 00 3 00 1000	
Combi-System E					760*** 00 4 16 1000	
Combi-System L					710*** 00 5 00 1000	
Additional modules for whirltub						
Additional modules for Combi-System E				Module-No.		
LED coloured light (replaces LED white light)				06		
Heating				07		
UV Hygiene Management				08		
Additional modules for Combi-System L				Module-No.		
LED coloured light (replaces white light)				06		
Temperature L				07		
UV Hygiene Management				08		
Accessories for bath- and whirltub						
Headrest, white					790009 00 0 00 0000	
Accessories for bathtub						
Waste and overflow Quadroval, chrome					791219 00 0 00 1000	
Waste and overflow Quadroval, with water inlet, chrome					791220 00 0 00 1000	
Waste and overflow, with base inlet, chrome *					791228 00 0 00 1000	
LED coloured light, with remote control for bathtubs, (white -00, chrome -10)					790840 00 0 00 * 00	
Sound					791851 00 0 00 0000	
Accessories for whirltub						
Surcharge, for waste and overflow Quadroval, with water inlet, chrome					791206 00 0 00 1000	
Surcharge, for waste and overflow, with base inlet, chrome *					791229 00 0 00 1000	
LED coloured light, for whirltubs with Air-System, Jet-System, Combi-System P, Durapearl-System or Jet Project					791850 00 0 00 1000	
Sound, for whirltubs with Air-System, Jet-System, Combi-System P, Durapearl-System or Jet Project					791852 00 0 00 0000	
Sound, for whirltubs with Combi-System E					791853 00 0 00 0000	

Infobox: * pipe interrupt mandatory

Happy D.2 Design by sieger design

Bathtub lay-on version, with two backrest slopes



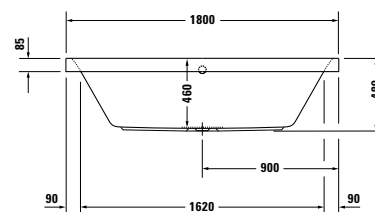
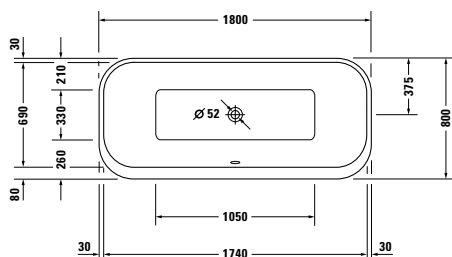

5 mm sanitary acrylic



Length mm	Width mm	Depth mm	Capacity l	Weight kg	Model-No.	Euro
						White - 00
Bathtub						
1800	800	460	170	37,0	700320 00 0 00 0000	
Surcharge for whirlsystem						
Air-System					760*** 00 1 00 1000	
Jet-System					760*** 00 2 00 1000	
Combi-System P					760*** 00 3 00 1000	
Combi-System E					760*** 00 4 16 1000	
Combi-System L					710*** 00 5 00 1000	
Additional modules for whirltub						
Additional modules for Combi-System E				Module-No.		
LED coloured light (replaces LED white light)				06		
Heating				07		
UV Hygiene Management				08		
Additional modules for Combi-System L				Module-No.		
LED coloured light (replaces white light)				06		
Temperature L				07		
UV Hygiene Management				08		
Accessories for bath- and whirltub						
Headrest, white					790009 00 0 00 0000	
Accessories for bathtub						
Support frame, for bathtubs and shower trays, with length > 1000 mm					790100 00 0 00 0000	
Waste and overflow Quadroval, chrome					791221 00 0 00 1000	
Waste and overflow Quadroval, with water inlet, chrome					791222 00 0 00 1000	
Waste and overflow, with base inlet, chrome *					791226 00 0 00 1000	
Support, für # 700320					791476 00 0 00 0000	
LED coloured light, with remote control for bathtubs, (white -00, chrome -10)					790840 00 0 00 * 00	
Sound					791851 00 0 00 0000	
Accessories for whirltub						
Surcharge, for waste and overflow Quadroval, with water inlet, chrome					791206 00 0 00 1000	
Surcharge, for waste and overflow, with base inlet, chrome *					791227 00 0 00 1000	
LED coloured light, for whirltubs with Air-System, Jet-System, Combi-System P, Durapearl-System or Jet Project					791850 00 0 00 1000	
Sound, for whirltubs with Air-System, Jet-System, Combi-System P, Durapearl-System or Jet Project					791852 00 0 00 0000	
Sound, for whirltubs with Combi-System E					791853 00 0 00 0000	

Infobox: * pipe interrupt mandatory / LED coloured light or sound is not suitable for bathtubs with support

Happy D.2 Accessories Design by sieger design

	Description	Model-No.	Euro
	<p>Headrest white, for Happy D.2 material: polyurethane</p>	790009 00 0 00 0000	
	<p>Waste and overflow Quadroval chrome, for Happy D.2 bathtubs, bowden cable 700 mm outlet diameter 52 mm</p>	791221 00 0 00 1000	
	<p>Waste and overflow Quadroval with water inlet, chrome, for Happy D.2 bathtubs, bowden cable 700 mm, (pipe interrupt necessary) outlet diameter 52 mm</p>	791222 00 0 00 1000	
	<p>Waste and overflow Quadroval chrome, for Happy D.2 freestanding bathtub and bath- tubs with integrated panel, bowden cable 700 mm outlet diameter 52 mm</p>	791219 00 0 00 1000	
	<p>Waste and overflow Quadroval with water inlet, chrome, for Happy D.2 freestanding bathtub and bath- tubs with integrated panel, bowden cable 700 mm, (pipe interrupt necessary) outlet diameter 52 mm</p>	791220 00 0 00 1000	

Nahho Design by E00S

Product Information

Nahho without whirlsystem, built-in

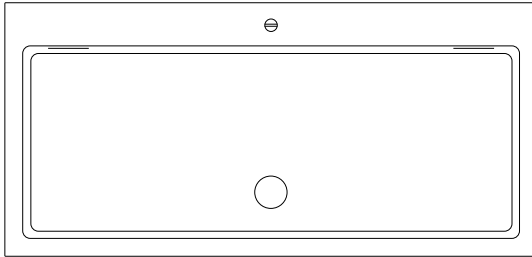

Positioning turning handle of waste and overflow with base inlet on the rim

Without ordering surcharge for drillings of the tub rim for faucet # 790650

The figure shows the standard position of the turning handle for the operation of the base inlet when ordering Nahho built-in without drillings of the tub rim for faucet # 790650. On request, other positions are possible. Please send us a sketch showing the desired position.

When ordering surcharge for drillings of the tub rim for faucet # 790650

Please note the order sheet for drilling tap holes on page 654/655. Please add the desired position of the turning handle in the order sheet for drilling tap holes. We recommend to position the turning handle of the base inlet to the left or to the right of the tap.

Nahho with integrated panel

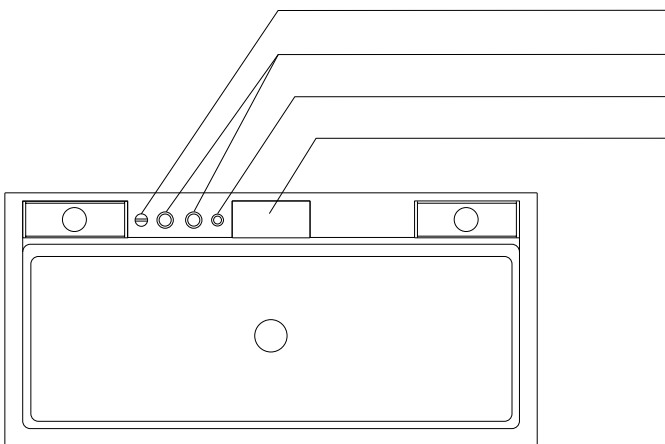

Positioning taps and turning handle of waste and overflow

- Turning handle waste and overflow
- Axor Starck 2-hole thermostatic bath mixer
- Axor Starck baton hand shower
- 2nd floor flood spout

The figure shows the standard position of the taps and the turning handle for the operation of the waste and overflow for Nahho with integrated panel, corner right # 700286. For corner left # 700285 the taps and the turning handle are arranged mirror-inverted. Other positions are not possible.

Information regarding scope of delivery

The following taps are included in the delivery of our Nahho floatation tubs with integrated panel (see also Infobox on the product site):

- Axor Starck 2-hole thermostatic bath mixer with concealed part
- Axor Starck baton hand shower with metal hose
- 2nd floor flood spout

The application of other taps is not possible.

Positioning spotlights of coloured light with remote control

2 of 5 spots are positioned in the overflow basins under the furniture cover. 3 further spots are set into the side wall of the tub that faces the wall.

Nahho Design by E00S

Product Information

Furniture cover	Decor	18 White Matt	Compact laminated panel, with laminate (HPL) pressed on both sides and lacquered in structure finish. Surface resistant to moisture.
	Decor	49 Graphite Matt	Compact laminated panel, with laminate (HPL) pressed on both sides. Surface resistant to moisture.
Fittings		brass	chromed, with SoftClose

Nahho Design by E00S

Floation tub rectangle, built-in, with special waste and overflow

5 mm sanitary acrylic

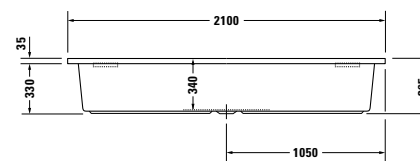
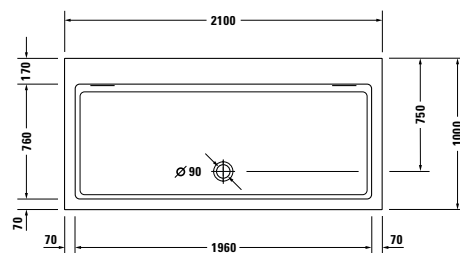

Length mm	Width mm	Depth mm	Capacity l	Weight kg	Model-No.	Euro
						White - 00
Floation tub						
2100	1000	340	310	56,0	700280 00 0 00 1000	
Surcharge for whirlsystem						
Durapearl-System					760** 00 9 00 1000	
Necessary accessories for floation tub						
Support frame					790157 00 0 00 0000	
Accessories for floation tub without and with whirlsystem						
Headrest, Graphite matt					790006 49 0 00 0000	
Bathtub anchors					790103 00 0 00 0000	
Rubber profile					790104 00 0 00 0000	
Shower screen, OpenSpace, corner left, transparent glass					770006 00 0 00 0000	
Shower screen, OpenSpace, corner left, mirror glass					770006 00 0 10 0000	
Shower screen, OpenSpace, corner right, transparent glass					770007 00 0 00 0000	
Shower screen, OpenSpace, corner right, mirror glass					770007 00 0 10 0000	
Accessories for floation tub without whirlsystem						
Surcharge, for waste and overflow, with base inlet, chrome *					791240 00 0 00 1000	
Surcharge, for drillings of the tub rim for faucet, (not possible for whirltub)					790650 00 0 00 0000	
LED coloured light, with remote control for bathtubs, (white -00, chrome -10)					790840 00 0 00 * 00	
Sound					791851 00 0 00 0000	
Accessories for floation tub with whirlsystem						
Surcharge, for waste and overflow, with base inlet, chrome *					791241 00 0 00 1000	
LED coloured light, for whirltubs with Air-System, Jet-System, Combi-System P, Durapearl-System or Jet Project					791850 00 0 00 1000	
Sound, for whirltubs with Air-System, Jet-System, Combi-System P, Durapearl-System or Jet Project					791852 00 0 00 0000	
Infobox: * assembled, pipe interrupt mandatory / For product information to OpenSpace please refer to chapter shower screens / If the waste and overflow with base inlet # 791240 is ordered, the support frame will already be included						

Nahho Design by E00S

Floation tub corner left, with integrated acrylic panel and support frame

5 mm sanitary acrylic

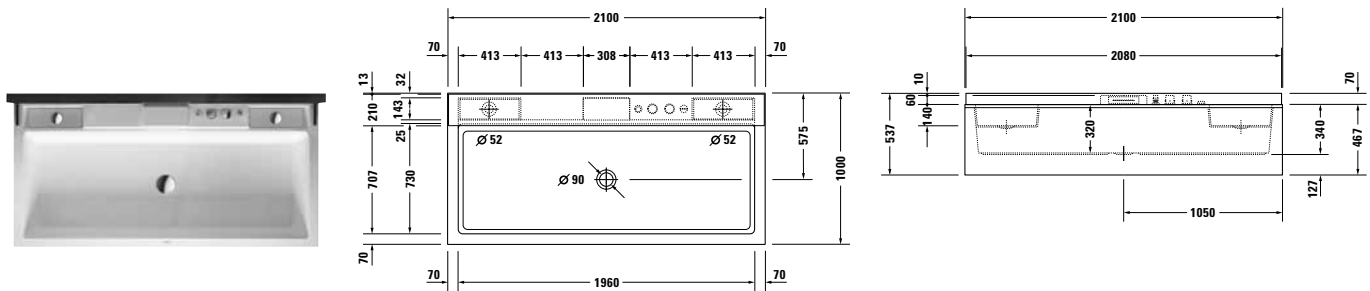

Length mm	Width mm	Depth mm	Capacity l	Weight kg	Model-No.	Euro
						White - 00
Floation tub						
2100	1000	320	310	115,0	700285 ** 0 00 1000	
Surcharge for whirlsystem						
Durapearl-System					760**** 9 00 1000	
Accessories for floation tub without and with whirlsystem						
Headrest, Graphite matt					790006 49 0 00 0000	
Bathtub anchors					790103 00 0 00 0000	
Rubber profile					790104 00 0 00 0000	
Acrylic panel, sidewise, left, (for back-to-wall version)					701126 00 0 00 0000	
Accessories for floation tub without whirlsystem						
LED coloured light, with remote control for bathtubs, (white -00, chrome -10)					790840 00 0 00 * *00	
Sound					791851 00 0 00 0000	
Accessories for floation tub with whirlsystem						
LED coloured light, for whirltubs with Air-System, Jet-System, Combi-System P, Durapearl-System or Jet Project					791850 00 0 00 1000	
Sound, for whirltubs with Air-System, Jet-System, Combi-System P, Durapearl-System or Jet Project					791852 00 0 00 0000	

Infobox: included in delivery:

- furniture cover in respective furnitur surface (18) White Matt or (49) Graphite Matt (Please add the furnitur colour code at the 7th and 8th digit of the item number when ordering Nahho.)
- Axor Starck 2-hole thermostic bath mixer with concealed part
- Axor Starck baton hand shower with metal hose
- 2nd floor flood spout
- special waste and overflow

Nahho Design by E00S

Floation tub corner right, with integrated acrylic panel and support frame

5 mm sanitary acrylic

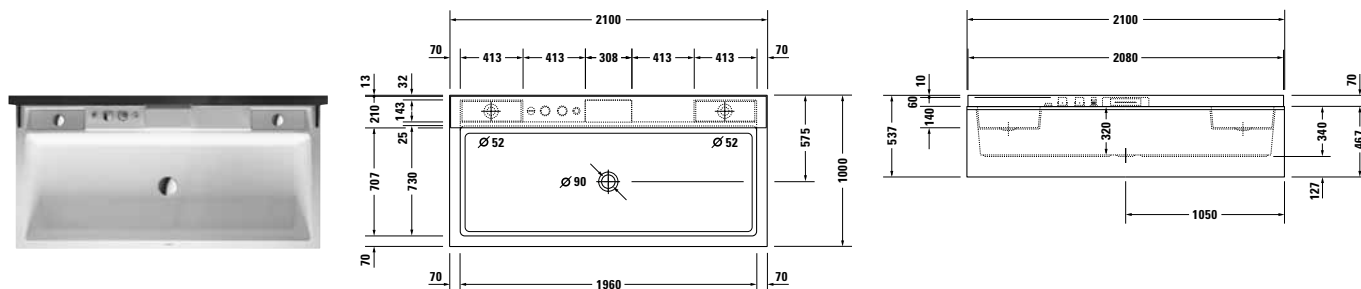

Length mm	Width mm	Depth mm	Capacity l	Weight kg	Model-No.	Euro
						White - 00
Floation tub						
2100	1000	320	310	115,0	700286 ** 0 00 1000	
Surcharge for whirlsystem						
Durapearl-System					760**** 9 00 1000	
Accessories for floation tub without and with whirlsystem						
Headrest, Graphite matt					790006 49 0 00 0000	
Bathtub anchors					790103 00 0 00 0000	
Rubber profile					790104 00 0 00 0000	
Acrylic panel, sidewise, right, (for back-to-wall version)					701127 00 0 00 0000	
Accessories for floation tub without whirlsystem						
LED coloured light, with remote control for bathtubs, (white -00, chrome -10)					790840 00 0 00 * *00	
Sound					791851 00 0 00 0000	
Accessories for floation tub with whirlsystem						
LED coloured light, for whirltubs with Air-System, Jet-System, Combi-System P, Durapearl-System or Jet Project					791850 00 0 00 1000	
Sound, for whirltubs with Air-System, Jet-System, Combi-System P, Durapearl-System or Jet Project					791852 00 0 00 0000	

Infobox: included in delivery:

- furniture cover in respective furnitur surface (18) White Matt or (49) Graphite Matt (Please add the furnitur colour code at the 7th and 8th digit of the item number when ordering Nahho.)
- Axor Starck 2-hole thermostic bath mixer with concealed part
- Axor Starck baton hand shower with metal hose
- 2nd floor flood spout
- special waste and overflow

Nahho Design by E00S

Acrylic panels for floatation tubs

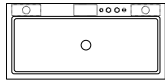

2100 x 1000 mm



700285

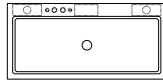



2100 x 1000 mm





700286

Model.-No. acrylic panel

	Corner left	Acrylic panel already included	
	Corner right	Acrylic panel already included	
	Back-to-wall	# 701126	# 701127

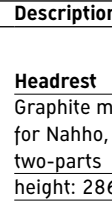
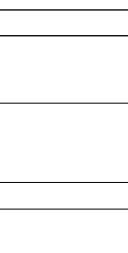
Nahho Accessories Design by E00S

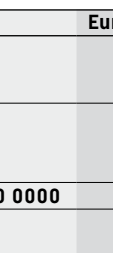
	Description	Model-No.	Euro
	Headrest Graphite matt, for Nahho, two-parts height: 286 mm	790006 49 0 00 0000	
	Support frame for Nahho built-in, height-adjustable from 120 - 190 mm 4 pieces	790157 00 0 00 0000	
	Surcharge * for waste and overflow, with base inlet, chrome outlet diameter 90 mm for Nahho built-in without whirlsystem for Nahho built-in with whirlsystem	791240 00 0 00 1000	791241 00 0 00 1000
Infobox: * assembled, pipe interrupt mandatory / If the waste and overflow with base inlet # 791240 is ordered, the support frame will already be included			
	Shower screen OpenSpace, corner left, for Nahho built-in, dimensions: 1700 x 1050 mm, glass thickness 8 mm, tempered safety glass transparent glass mirror glass	770006 00 0 00 0000	770006 00 0 10 0000
Infobox: For product information to OpenSpace please refer to chapter shower screens			
	Shower screen OpenSpace, corner right, for Nahho built-in, dimensions: 1700 x 1050 mm, glass thickness 8 mm, tempered safety glass transparent glass mirror glass	770007 00 0 00 0000	770007 00 0 10 0000
Infobox: For product information to OpenSpace please refer to chapter shower screens			
	Acrylic panel sidewise, left, (for back-to-wall version) for Nahho with integrated panel	701126 00 0 00 0000	

Nahho Accessories Design by E00S

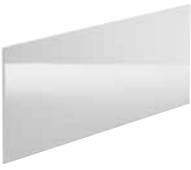
Description	Model-No.		Euro
	Acrylic panel		
sidewise,			
right,			
(for back-to-wall version)			
for Nahho with integrated panel			
	701127 00 0 00 0000		

Paiova Design by E00S

Bathtub Monolith, for corner left, with integrated acrylic panel and support frame

5 mm sanitary acrylic

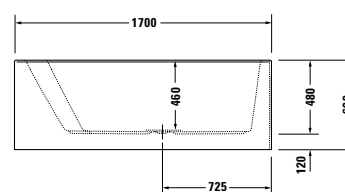
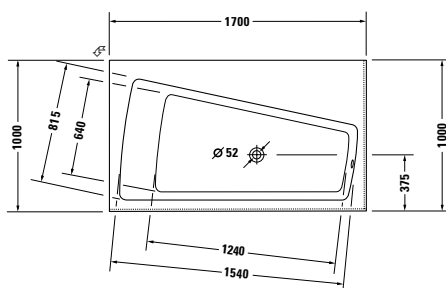

Length mm	Width mm	Depth mm	Capacity l	Weight kg	Model-No.	Euro
						White - 00
Bathtub						
1700	1000	460	195	76,3	700270 00 0 00 0000	
Surcharge for whirlsystem						
Air-System					760*** 00 1 00 1000	
Jet-System					760*** 00 2 00 1000	
Combi-System P					760*** 00 3 00 1000	
Combi-System E					760*** 00 4 16 1000	
Combi-System L					710*** 00 5 00 1000	
Additional modules for whirltub						
Additional modules for Combi-System E				Module-No.		
LED coloured light (replaces LED white light)				06		
Heating				07		
UV Hygiene Management				08		
Additional modules for Combi-System L				Module-No.		
LED coloured light (replaces white light)				06		
Temperature L				07		
UV Hygiene Management				08		
Accessories for bath- and whirltub						
Headrest, white					790001 00 0 00 0000	
Bathtub anchors					790103 00 0 00 0000	
Rubber profile					790104 00 0 00 0000	
Acrylic panel, sidewise, left, (for back-to-wall version)					701121 00 0 00 0000	
Accessories for bathtub						
Waste and overflow Quadroval, chrome					790299 00 0 00 1000	
Waste and overflow Quadroval, with water inlet, chrome					791200 00 0 00 1000	
Waste and overflow, with base inlet, chrome *					791235 00 0 00 1000	
Surcharge, for drillings of the tub rim for faucet, (not possible for whirltub)					790650 00 0 00 0000	
LED coloured light, with remote control for bathtubs, (white -00, chrome -10)					790840 00 0 00 * 00	
Sound					791851 00 0 00 0000	
Accessories for whirltub						
Surcharge, for waste and overflow Quadroval, with water inlet, chrome					791207 00 0 00 1000	
Surcharge, for waste and overflow, with base inlet, chrome *					791231 00 0 00 1000	
LED coloured light, for whirltubs with Air-System, Jet-System, Combi-System P, Durapearl-System or Jet Project					791850 00 0 00 1000	
Sound, for whirltubs with Air-System, Jet-System, Combi-System P, Durapearl-System or Jet Project					791852 00 0 00 0000	
Sound, for whirltubs with Combi-System E					791853 00 0 00 0000	

Infobox: * pipe interrupt mandatory

Paiova Design by E00S

Bathtub Monolith, for corner right, with integrated acrylic panel and support frame

5 mm sanitary acrylic

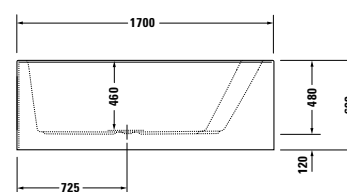
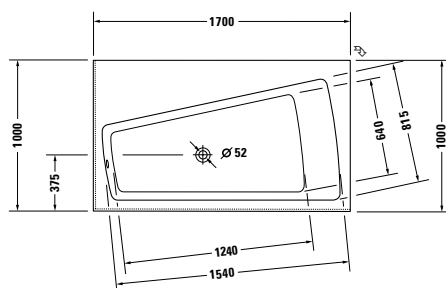

Length mm	Width mm	Depth mm	Capacity l	Weight kg	Model-No.	Euro
						White - 00
Bathtub						
1700	1000	460	195	76,3	700271 00 0 00 0000	
Surcharge for whirlsystem						
Air-System					760*** 00 1 00 1000	
Jet-System					760*** 00 2 00 1000	
Combi-System P					760*** 00 3 00 1000	
Combi-System E					760*** 00 4 16 1000	
Combi-System L					710*** 00 5 00 1000	
Additional modules for whirltub						
Additional modules for Combi-System E				Module-No.		
LED coloured light (replaces LED white light)				06		
Heating				07		
UV Hygiene Management				08		
Additional modules for Combi-System L				Module-No.		
LED coloured light (replaces white light)				06		
Temperature L				07		
UV Hygiene Management				08		
Accessories for bath- and whirltub						
Headrest, white					790001 00 0 00 0000	
Bathtub anchors					790103 00 0 00 0000	
Rubber profile					790104 00 0 00 0000	
Acrylic panel, sidewise, right, (for back-to-wall version)					701120 00 0 00 0000	
Accessories for bathtub						
Waste and overflow Quadroval, chrome					790299 00 0 00 1000	
Waste and overflow Quadroval, with water inlet, chrome					791200 00 0 00 1000	
Waste and overflow, with base inlet, chrome *					791235 00 0 00 1000	
Surcharge, for drillings of the tub rim for faucet, (not possible for whirltub)					790650 00 0 00 0000	
LED coloured light, with remote control for bathtubs, (white -00, chrome -10)					790840 00 0 00 * *00	
Sound					791851 00 0 00 0000	
Accessories for whirltub						
Surcharge, for waste and overflow Quadroval, with water inlet, chrome					791207 00 0 00 1000	
Surcharge, for waste and overflow, with base inlet, chrome *					791231 00 0 00 1000	
LED coloured light, for whirltubs with Air-System, Jet-System, Combi-System P, Durapearl-System or Jet Project					791850 00 0 00 1000	
Sound, for whirltubs with Air-System, Jet-System, Combi-System P, Durapearl-System or Jet Project					791852 00 0 00 0000	
Sound, for whirltubs with Combi-System E					791853 00 0 00 0000	

Infobox: * pipe interrupt mandatory

Paiova Design by E00S

Bathtub corner left, built-in

5 mm sanitary acrylic

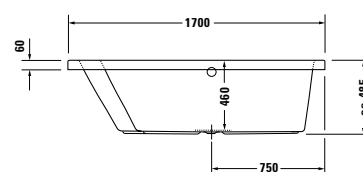
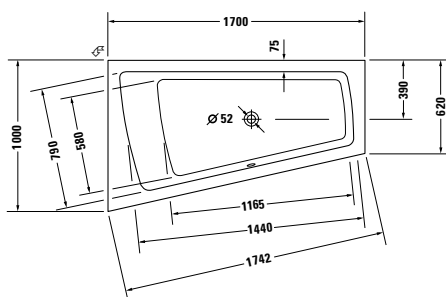

Length mm	Width mm	Depth mm	Capacity l	Weight kg	Model-No.	Euro
						White - 00
Bathtub						
1700	1000	460	180	31,0	700212 00 0 00 0000	
Surcharge for whirlsystem						
Air-System					760*** 00 1 00 1000	
Jet-System					760*** 00 2 00 1000	
Combi-System P					760*** 00 3 00 1000	
Combi-System E					760*** 00 4 16 1000	
Combi-System L					710*** 00 5 00 1000	
Additional modules for whirltub						
Additional modules for Combi-System E				Module-No.		
LED coloured light (replaces LED white light)				06		
Heating				07		
UV Hygiene Management				08		
Additional modules for Combi-System L				Module-No.		
LED coloured light (replaces white light)				06		
Temperature L				07		
UV Hygiene Management				08		
Accessories for bath- and whirltub						
Headrest, white					790001 00 0 00 0000	
Bathtub anchors					790103 00 0 00 0000	
Rubber profile					790104 00 0 00 0000	
Accessories for bathtub						
Support frame, for bathtubs and shower trays, with length > 1000 mm					790100 00 0 00 0000	
Waste and overflow Quadroval, chrome					790289 00 0 00 1000	
Waste and overflow Quadroval, with water inlet, chrome					790290 00 0 00 1000	
Waste and overflow, with base inlet, chrome *					791226 00 0 00 1000	
Support, for # 700212					791418 00 0 00 0000	
LED coloured light, with remote control for bathtubs, (white -00, chrome -10)					790840 00 0 00 * 00	
Sound					791851 00 0 00 0000	
Accessories for whirltub						
Surcharge, for waste and overflow Quadroval, with water inlet, chrome					791206 00 0 00 1000	
Surcharge, for waste and overflow, with base inlet, chrome *					791227 00 0 00 1000	
LED coloured light, for whirltubs with Air-System, Jet-System, Combi-System P, Durapearl-System or Jet Project					791850 00 0 00 1000	
Sound, for whirltubs with Air-System, Jet-System, Combi-System P, Durapearl-System or Jet Project					791852 00 0 00 0000	
Sound, for whirltubs with Combi-System E					791853 00 0 00 0000	

Infobox: * pipe interrupt mandatory / LED coloured light or sound is not suitable for bathtubs with support

Paiova Design by E00S

Bathtub corner left, with support frame for panel

5 mm sanitary acrylic

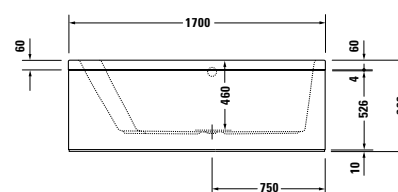
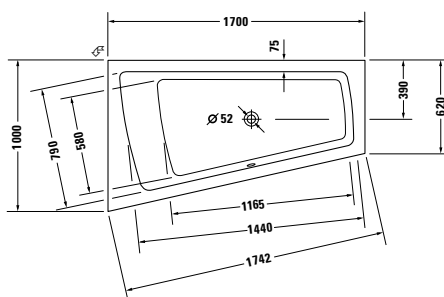

Length mm	Width mm	Depth mm	Capacity l	Weight kg	Model-No.	Euro
						White - 00
Bathtub						
1700	1000	460	180	46,0	700218 00 0 00 0000	
Surcharge for whirlsystem						
Air-System					760*** 00 1 00 1000	
Jet-System					760*** 00 2 00 1000	
Combi-System P					760*** 00 3 00 1000	
Combi-System E					760*** 00 4 16 1000	
Combi-System L					710*** 00 5 00 1000	
Additional modules for whirltub						
Additional modules for Combi-System E				Module-No.		
LED coloured light (replaces LED white light)				06		
Heating				07		
UV Hygiene Management				08		
Additional modules for Combi-System L				Module-No.		
LED coloured light (replaces white light)				06		
Temperature L				07		
UV Hygiene Management				08		
Necessary accessories for bath- and whirltub						
Suitable panels s.p. 374						
Accessories for bath- and whirltub						
Headrest, white					790001 00 0 00 0000	
Bathtub anchors					790103 00 0 00 0000	
Rubber profile					790104 00 0 00 0000	
Accessories for bathtub						
Waste and overflow Quadroval, chrome					790289 00 0 00 1000	
Waste and overflow Quadroval, with water inlet, chrome					790290 00 0 00 1000	
Waste and overflow, with base inlet, chrome *					791226 00 0 00 1000	
LED coloured light, with remote control for bathtubs, (white -00, chrome -10)					790840 00 0 00 * 00	
Sound					791851 00 0 00 0000	
Accessories for whirltub						
Surcharge, for waste and overflow Quadroval, with water inlet, chrome					791206 00 0 00 1000	
Surcharge, for waste and overflow, with base inlet, chrome *					791227 00 0 00 1000	
LED coloured light, for whirltubs with Air-System, Jet-System, Combi-System P, Durapearl-System or Jet Project					791850 00 0 00 1000	
Sound, for whirltubs with Air-System, Jet-System, Combi-System P, Durapearl-System or Jet Project					791852 00 0 00 0000	
Sound, for whirltubs with Combi-System E					791853 00 0 00 0000	

Infobox: * pipe interrupt mandatory

Paiova Design by E00S

Bathtub corner left, with integrated acrylic panel and support frame

5 mm sanitary acrylic

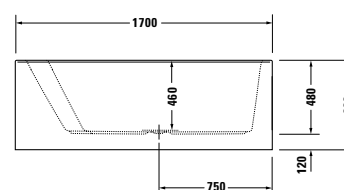
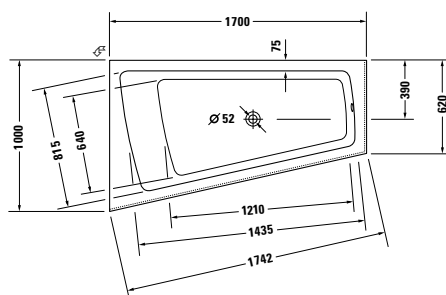

Length mm	Width mm	Depth mm	Capacity l	Weight kg	Model-No.	Euro
						White - 00
Bathtub						
1700	1000	460	170	68,0	700264 00 0 00 0000	
Surcharge for whirlsystem						
Air-System					760*** 00 1 00 1000	
Jet-System					760*** 00 2 00 1000	
Combi-System P					760*** 00 3 00 1000	
Combi-System E					760*** 00 4 16 1000	
Combi-System L					710*** 00 5 00 1000	
Additional modules for whirltub						
Additional modules for Combi-System E				Module-No.		
LED coloured light (replaces LED white light)				06		
Heating				07		
UV Hygiene Management				08		
Additional modules for Combi-System L				Module-No.		
LED coloured light (replaces white light)				06		
Temperature L				07		
UV Hygiene Management				08		
Accessories for bath- and whirltub						
Headrest, white					790001 00 0 00 0000	
Bathtub anchors					790103 00 0 00 0000	
Rubber profile					790104 00 0 00 0000	
Accessories for bathtub						
Waste and overflow Quadroval, chrome					790299 00 0 00 1000	
Waste and overflow Quadroval, with water inlet, chrome					791200 00 0 00 1000	
Waste and overflow, with base inlet, chrome *					791235 00 0 00 1000	
LED coloured light, with remote control for bathtubs, (white -00, chrome -10)					790840 00 0 00 * 00	
Sound					791851 00 0 00 0000	
Accessories for whirltub						
Surcharge, for waste and overflow Quadroval, with water inlet, chrome					791207 00 0 00 1000	
Surcharge, for waste and overflow, with base inlet, chrome *					791231 00 0 00 1000	
LED coloured light, for whirltubs with Air-System, Jet-System, Combi-System P, Durapearl-System or Jet Project					791850 00 0 00 1000	
Sound, for whirltubs with Air-System, Jet-System, Combi-System P, Durapearl-System or Jet Project					791852 00 0 00 0000	
Sound, for whirltubs with Combi-System E					791853 00 0 00 0000	

Infobox: * pipe interrupt mandatory

Paiova Design by E00S

Bathtub corner right, built-in

5 mm sanitary acrylic

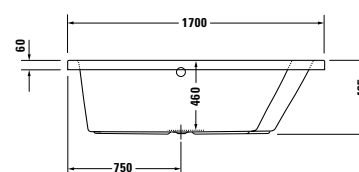
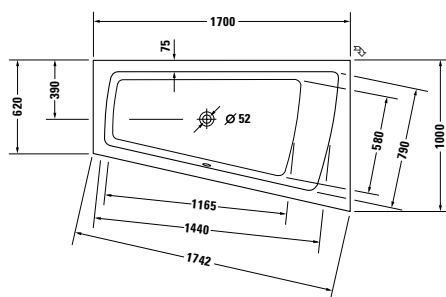

Length mm	Width mm	Depth mm	Capacity l	Weight kg	Model-No.	Euro
						White - 00
Bathtub						
1700	1000	460	180	31,0	700213 00 0 00 0000	
Surcharge for whirlsystem						
Air-System					760*** 00 1 00 1000	
Jet-System					760*** 00 2 00 1000	
Combi-System P					760*** 00 3 00 1000	
Combi-System E					760*** 00 4 16 1000	
Combi-System L					710*** 00 5 00 1000	
Additional modules for whirltub						
Additional modules for Combi-System E				Module-No.		
LED coloured light (replaces LED white light)				06		
Heating				07		
UV Hygiene Management				08		
Additional modules for Combi-System L				Module-No.		
LED coloured light (replaces white light)				06		
Temperature L				07		
UV Hygiene Management				08		
Accessories for bath- and whirltub						
Headrest, white					790001 00 0 00 0000	
Bathtub anchors					790103 00 0 00 0000	
Rubber profile					790104 00 0 00 0000	
Accessories for bathtub						
Support frame, for bathtubs and shower trays, with length > 1000 mm					790100 00 0 00 0000	
Waste and overflow Quadroval, chrome					790289 00 0 00 1000	
Waste and overflow Quadroval, with water inlet, chrome					790290 00 0 00 1000	
Waste and overflow, with base inlet, chrome *					791226 00 0 00 1000	
Support, for # 700213					791419 00 0 00 0000	
LED coloured light, with remote control for bathtubs, (white -00, chrome -10)					790840 00 0 00 * *00	
Sound					791851 00 0 00 0000	
Accessories for whirltub						
Surcharge, for waste and overflow Quadroval, with water inlet, chrome					791206 00 0 00 1000	
Surcharge, for waste and overflow, with base inlet, chrome *					791227 00 0 00 1000	
LED coloured light, for whirltubs with Air-System, Jet-System, Combi-System P, Durapearl-System or Jet Project					791850 00 0 00 1000	
Sound, for whirltubs with Air-System, Jet-System, Combi-System P, Durapearl-System or Jet Project					791852 00 0 00 0000	
Sound, for whirltubs with Combi-System E					791853 00 0 00 0000	

Infobox: * pipe interrupt mandatory / LED coloured light or sound is not suitable for bathtubs with support

Paiova Design by E00S

Bathtub corner right, with support frame for panel

5 mm sanitary acrylic

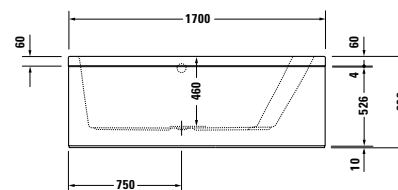
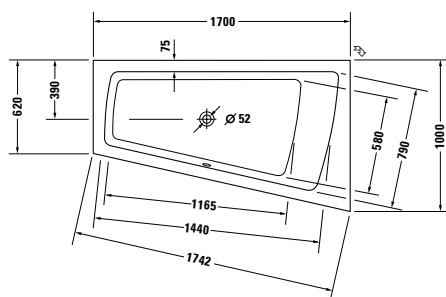

Length mm	Width mm	Depth mm	Capacity l	Weight kg	Model-No.	Euro
						White - 00
Bathtub						
1700	1000	460	180	46,0	700219 00 0 00 0000	
Surcharge for whirlsystem						
Air-System					760*** 00 1 00 1000	
Jet-System					760*** 00 2 00 1000	
Combi-System P					760*** 00 3 00 1000	
Combi-System E					760*** 00 4 16 1000	
Combi-System L					710*** 00 5 00 1000	
Additional modules for whirltub						
Additional modules for Combi-System E				Module-No.		
LED coloured light (replaces LED white light)				06		
Heating				07		
UV Hygiene Management				08		
Additional modules for Combi-System L				Module-No.		
LED coloured light (replaces white light)				06		
Temperature L				07		
UV Hygiene Management				08		
Necessary accessories for bath- and whirltub						
Suitable panels s.p. 374						
Accessories for bath- and whirltub						
Headrest, white					790001 00 0 00 0000	
Bathtub anchors					790103 00 0 00 0000	
Rubber profile					790104 00 0 00 0000	
Accessories for bathtub						
Waste and overflow Quadroval, chrome					790289 00 0 00 1000	
Waste and overflow Quadroval, with water inlet, chrome					790290 00 0 00 1000	
Waste and overflow, with base inlet, chrome *					791226 00 0 00 1000	
LED coloured light, with remote control for bathtubs, (white -00, chrome -10)					790840 00 0 00 * 00	
Sound					791851 00 0 00 0000	
Accessories for whirltub						
Surcharge, for waste and overflow Quadroval, with water inlet, chrome					791206 00 0 00 1000	
Surcharge, for waste and overflow, with base inlet, chrome *					791227 00 0 00 1000	
LED coloured light, for whirltubs with Air-System, Jet-System, Combi-System P, Durapearl-System or Jet Project					791850 00 0 00 1000	
Sound, for whirltubs with Air-System, Jet-System, Combi-System P, Durapearl-System or Jet Project					791852 00 0 00 0000	
Sound, for whirltubs with Combi-System E					791853 00 0 00 0000	

Infobox: * pipe interrupt mandatory

Paiova Design by E00S

Bathtub corner right, with integrated acrylic panel and support frame

5 mm sanitary acrylic

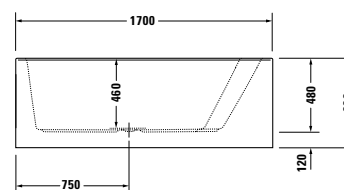
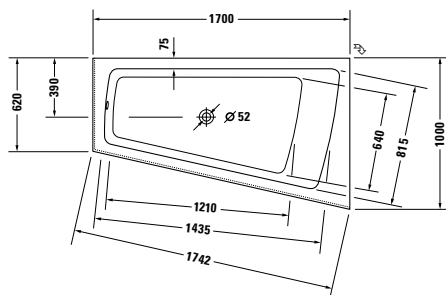

Length mm	Width mm	Depth mm	Capacity l	Weight kg	Model-No.	Euro
						White - 00
Bathtub						
1700	1000	460	170	68,0	700265 00 0 00 0000	
Surcharge for whirlsystem						
Air-System					760*** 00 1 00 1000	
Jet-System					760*** 00 2 00 1000	
Combi-System P					760*** 00 3 00 1000	
Combi-System E					760*** 00 4 16 1000	
Combi-System L					710*** 00 5 00 1000	
Additional modules for whirltub						
Additional modules for Combi-System E				Module-No.		
LED coloured light (replaces LED white light)				06		
Heating				07		
UV Hygiene Management				08		
Additional modules for Combi-System L				Module-No.		
LED coloured light (replaces white light)				06		
Temperature L				07		
UV Hygiene Management				08		
Accessories for bath- and whirltub						
Headrest, white					790001 00 0 00 0000	
Bathtub anchors					790103 00 0 00 0000	
Rubber profile					790104 00 0 00 0000	
Accessories for bathtub						
Waste and overflow Quadroval, chrome					790299 00 0 00 1000	
Waste and overflow Quadroval, with water inlet, chrome					791200 00 0 00 1000	
Waste and overflow, with base inlet, chrome *					791235 00 0 00 1000	
LED coloured light, with remote control for bathtubs, (white -00, chrome -10)					790840 00 0 00 * 00	
Sound					791851 00 0 00 0000	
Accessories for whirltub						
Surcharge, for waste and overflow Quadroval, with water inlet, chrome					791207 00 0 00 1000	
Surcharge, for waste and overflow, with base inlet, chrome *					791231 00 0 00 1000	
LED coloured light, for whirltubs with Air-System, Jet-System, Combi-System P, Durapearl-System or Jet Project					791850 00 0 00 1000	
Sound, for whirltubs with Air-System, Jet-System, Combi-System P, Durapearl-System or Jet Project					791852 00 0 00 0000	
Sound, for whirltubs with Combi-System E					791853 00 0 00 0000	

Infobox: * pipe interrupt mandatory

Paiova Design by E00S

Bathtub corner left, built-in
5 mm sanitary acrylic

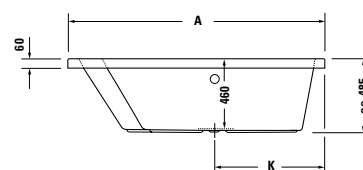
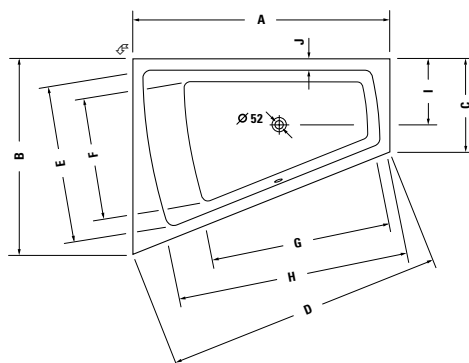

	A	B	C	D	E	F	G	H	I	J	K
700214	1700	1300	620	1830	1045	795	1190	1545	440	75	730
700216	1800	1400	680	1937	1140	870	1320	1620	465	75	780

Length mm	Width mm	Depth mm	Capacity l	Weight kg	Model-No.	Euro
						White - 00
Bathtub						
1700	1300	460	235	40,0	700214 00 0 00 0000	
1800	1400	460	315	45,0	700216 00 0 00 0000	
Surcharge for whirlsystem						
Air-System					760*** 00 1 00 1000	
Jet-System					760*** 00 2 00 1000	
Combi-System P					760*** 00 3 00 1000	
Combi-System E					760*** 00 4 16 1000	
Combi-System L					710*** 00 5 00 1000	
Additional modules for whirltub						
Additional modules for Combi-System E				Module-No.		
LED coloured light (replaces LED white light)				06		
Heating				07		
UV Hygiene Management				08		
Additional modules for Combi-System L				Module-No.		
LED coloured light (replaces white light)				06		
Temperature L				07		
UV Hygiene Management				08		
Accessories for bath- and whirltub						
Headrest, white					790001 00 0 00 0000	
Bathtub anchors					790103 00 0 00 0000	
Rubber profile					790104 00 0 00 0000	
continued on following page						

Paiova Design by E00S

Bathtub corner left, built-in

5 mm sanitary acrylic

Length mm	Width mm	Depth mm	Capacity l	Weight kg	Model-No.	Euro	
						White	- 00
Bathtub							
1700	1300	460	235	40,0	700214 00 0 00 0000		
1800	1400	460	315	45,0	700216 00 0 00 0000		
Accessories for bathtub							
Support frame, for bathtubs and shower trays, with length > 1500 mm					790105 00 0 00 0000		
Waste and overflow Quadroval, chrome					790293 00 0 00 1000		
Waste and overflow Quadroval, with water inlet, chrome					790294 00 0 00 1000		
Waste and overflow, with base inlet, chrome *					791230 00 0 00 1000		
Support, for # 700214					791420 00 0 00 0000		
Support, for # 700216					791422 00 0 00 0000		
LED coloured light, with remote control for bathtubs, (white -00, chrome -10)					790840 00 0 00 * 00		
Sound					791851 00 0 00 0000		
Accessories for whirltub							
Surcharge, for waste and overflow Quadroval, with water inlet, chrome					791206 00 0 00 1000		
Surcharge, for waste and overflow, with base inlet, chrome *					791231 00 0 00 1000		
LED coloured light, for whirltubs with Air-System, Jet-System, Combi-System P, Durapearl-System or Jet Project					791850 00 0 00 1000		
Sound, for whirltubs with Air-System, Jet-System, Combi-System P, Durapearl-System or Jet Project					791852 00 0 00 0000		
Sound, for whirltubs with Combi-System E					791853 00 0 00 0000		

Infobox: * pipe interrupt mandatory / LED coloured light or sound is not suitable for bathtubs with support
--

Paiova Design by E00S

Bathtub corner left, with support frame for panel

5 mm sanitary acrylic

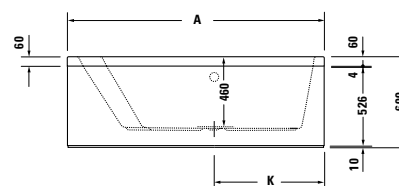
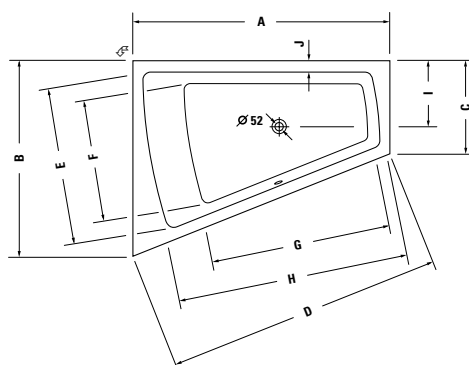

	A	B	C	D	E	F	G	H	I	J	K
700220	1700	1300	620	1830	1045	795	1190	1545	440	75	730
700222	1800	1400	680	1937	1140	870	1320	1620	465	75	780

Length mm	Width mm	Depth mm	Capacity l	Weight kg	Model-No.	Euro
						White - 00
Bathtub						
1700	1300	460	235	55,0	700220 00 0 00 0000	
1800	1400	460	315	60,0	700222 00 0 00 0000	
Surcharge for whirlsystem						
Air-System					760*** 00 1 00 1000	
Jet-System					760*** 00 2 00 1000	
Combi-System P					760*** 00 3 00 1000	
Combi-System E					760*** 00 4 16 1000	
Combi-System L					710*** 00 5 00 1000	
Additional modules for whirltub						
Additional modules for Combi-System E				Module-No.		
LED coloured light (replaces LED white light)				06		
Heating				07		
UV Hygiene Management				08		
Additional modules for Combi-System L				Module-No.		
LED coloured light (replaces white light)				06		
Temperature L				07		
UV Hygiene Management				08		
Necessary accessories for bath- and whirltub						
Suitable panels s.p. 374						
Accessories for bath- and whirltub						
Headrest, white					790001 00 0 00 0000	
Bathtub anchors					790103 00 0 00 0000	
Rubber profile					790104 00 0 00 0000	

continued on following page

Paiova Design by E00S

Bathtub corner left, with support frame for panel

5 mm sanitary acrylic

Length mm	Width mm	Depth mm	Capacity l	Weight kg	Model-No.	Euro	
						White	- 00
Bathtub							
1700	1300	460	235	55,0	700220 00 0 00 0000		
1800	1400	460	315	60,0	700222 00 0 00 0000		
Accessories for bathtub							
Waste and overflow Quadroval, chrome					790293 00 0 00 1000		
Waste and overflow Quadroval, with water inlet, chrome					790294 00 0 00 1000		
Waste and overflow, with base inlet, chrome *					791230 00 0 00 1000		
LED coloured light, with remote control for bathtubs, (white -00, chrome -10)					790840 00 0 00 * 00		
Sound					791851 00 0 00 0000		
Accessories for whirltub							
Surcharge, for waste and overflow Quadroval, with water inlet, chrome					791206 00 0 00 1000		
Surcharge, for waste and overflow, with base inlet, chrome *					791231 00 0 00 1000		
LED coloured light, for whirltubs with Air-System, Jet-System, Combi-System P, Durapearl-System or Jet Project					791850 00 0 00 1000		
Sound, for whirltubs with Air-System, Jet-System, Combi-System P, Durapearl-System or Jet Project					791852 00 0 00 0000		
Sound, for whirltubs with Combi-System E					791853 00 0 00 0000		

Infobox: * pipe interrupt mandatory

Paiova Design by E00S

Bathtub corner left, with integrated acrylic panel and support frame

5 mm sanitary acrylic

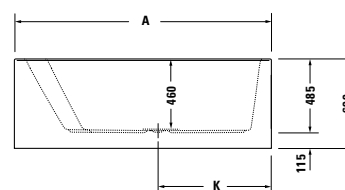
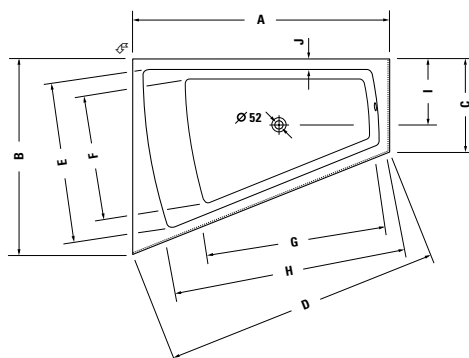

	A	B	C	D	E	F	G	H	I	J	K
700266	1700	1300	620	1830	1045	830	1215	1515	435	75	730
700268	1800	1400	680	1937	1140	870	1320	1620	465	75	780

Length mm	Width mm	Depth mm	Capacity l	Weight kg	Model-No.	Euro
						White - 00
Bathtub						
1700	1300	460	225	70,5	700266 00 0 00 0000	
1800	1400	460	295	80,0	700268 00 0 00 0000	
Surcharge for whirlsystem						
Air-System					760*** 00 1 00 1000	
Jet-System					760*** 00 2 00 1000	
Combi-System P					760*** 00 3 00 1000	
Combi-System E					760*** 00 4 16 1000	
Combi-System L					710*** 00 5 00 1000	
Additional modules for whirltub						
Additional modules for Combi-System E				Module-No.		
LED coloured light (replaces LED white light)				06		
Heating				07		
UV Hygiene Management				08		
Additional modules for Combi-System L				Module-No.		
LED coloured light (replaces white light)				06		
Temperature L				07		
UV Hygiene Management				08		
Accessories for bath- and whirltub						
Headrest, white					790001 00 0 00 0000	
Bathtub anchors					790103 00 0 00 0000	
Rubber profile					790104 00 0 00 0000	
Accessories for bathtub						
Waste and overflow Quadroval, chrome					790299 00 0 00 1000	
Waste and overflow Quadroval, with water inlet, chrome					791200 00 0 00 1000	
Waste and overflow, with base inlet, chrome *					791235 00 0 00 1000	
LED coloured light, with remote control for bathtubs, (white -00, chrome -10)					790840 00 0 00 * 00	
Sound					791851 00 0 00 0000	
continued on following page						

Paiova Design by E00S

Bathtub corner left, with integrated acrylic panel and support frame
5 mm sanitary acrylic

Length mm	Width mm	Depth mm	Capacity l	Weight kg	Model-No.	Euro	
						White	- 00
Bathtub							
1700	1300	460	225	70,5	700266 00 0 00 0000		
1800	1400	460	295	80,0	700268 00 0 00 0000		
Accessories for whirltub							
Surcharge, for waste and overflow Quadroval, with water inlet, chrome					791207 00 0 00 1000		
Surcharge, for waste and overflow, with base inlet, chrome *					791231 00 0 00 1000		
LED coloured light, for whirltubs with Air-System, Jet-System, Combi-System P, Durapearl-System or Jet Project					791850 00 0 00 1000		
Sound, for whirltubs with Air-System, Jet-System, Combi-System P, Durapearl-System or Jet Project					791852 00 0 00 0000		
Sound, for whirltubs with Combi-System E					791853 00 0 00 0000		

Infobox: * pipe interrupt mandatory

Paiova Design by E00S

Bathtub corner right, built-in
5 mm sanitary acrylic

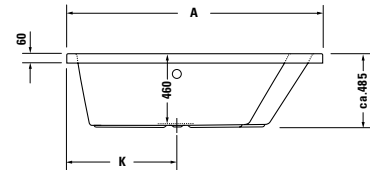
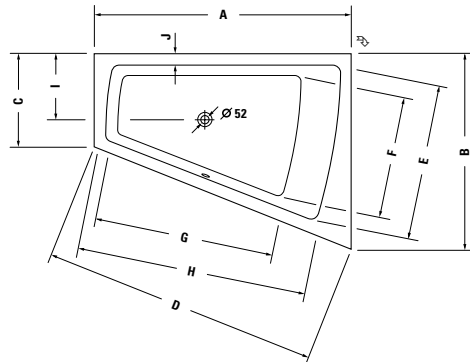

	A	B	C	D	E	F	G	H	I	J	K
700215	1700	1300	620	1830	1045	795	1190	1545	440	75	730
700217	1800	1400	680	1937	1140	870	1320	1620	465	75	780

Length mm	Width mm	Depth mm	Capacity l	Weight kg	Model-No.	Euro
						White - 00
Bathtub						
1700	1300	460	235	40,0	700215 00 0 00 0000	
1800	1400	460	315	45,0	700217 00 0 00 0000	
Surcharge for whirlsystem						
Air-System					760*** 00 1 00 1000	
Jet-System					760*** 00 2 00 1000	
Combi-System P					760*** 00 3 00 1000	
Combi-System E					760*** 00 4 16 1000	
Combi-System L					710*** 00 5 00 1000	
Additional modules for whirltub						
Additional modules for Combi-System E				Module-No.		
LED coloured light (replaces LED white light)				06		
Heating				07		
UV Hygiene Management				08		
Additional modules for Combi-System L				Module-No.		
LED coloured light (replaces white light)				06		
Temperature L				07		
UV Hygiene Management				08		
Accessories for bath- and whirltub						
Headrest, white					790001 00 0 00 0000	
Bathtub anchors					790103 00 0 00 0000	
Rubber profile					790104 00 0 00 0000	
continued on following page						

Paiova Design by E00S

Bathtub corner right, built-in
 5 mm sanitary acrylic

Length mm	Width mm	Depth mm	Capacity l	Weight kg	Model-No.	Euro	
						White	- 00
Bathtub							
1700	1300	460	235	40,0	700215 00 0 00 0000		
1800	1400	460	315	45,0	700217 00 0 00 0000		
Accessories for bathtub							
Support frame, for bathtubs and shower trays, with length > 1500 mm					790105 00 0 00 0000		
Waste and overflow Quadroval, chrome					790293 00 0 00 1000		
Waste and overflow Quadroval, with water inlet, chrome					790294 00 0 00 1000		
Waste and overflow, with base inlet, chrome *					791230 00 0 00 1000		
Support, for # 700215					791421 00 0 00 0000		
Support, for # 700217					791423 00 0 00 0000		
LED coloured light, with remote control for bathtubs, (white -00, chrome -10)					790840 00 0 00 * *00		
Sound					791851 00 0 00 0000		
Accessories for whirltub							
Surcharge, for waste and overflow Quadroval, with water inlet, chrome					791206 00 0 00 1000		
Surcharge, for waste and overflow, with base inlet, chrome *					791231 00 0 00 1000		
LED coloured light, for whirltubs with Air-System, Jet-System, Combi-System P, Durapearl-System or Jet Project					791850 00 0 00 1000		
Sound, for whirltubs with Air-System, Jet-System, Combi-System P, Durapearl-System or Jet Project					791852 00 0 00 0000		
Sound, for whirltubs with Combi-System E					791853 00 0 00 0000		

Infobox: * pipe interrupt mandatory / LED coloured light or sound is not suitable for bathtubs with support

Paiova Design by E00S

Bathtub corner right, with support frame for panel

5 mm sanitary acrylic

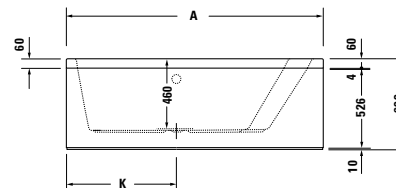
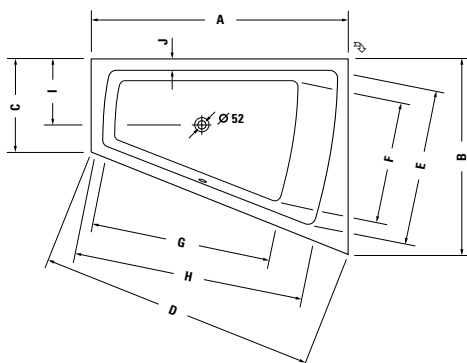

	A	B	C	D	E	F	G	H	I	J	K
700221	1700	1300	620	1830	1045	795	1190	1545	440	75	730
700223	1800	1400	680	1937	1140	870	1320	1620	465	75	780

Length mm	Width mm	Depth mm	Capacity l	Weight kg	Model-No.	Euro
						White - 00
Bathtub						
1700	1300	460	235	55,0	700221 00 0 00 0000	
1800	1400	460	315	60,0	700223 00 0 00 0000	
Surcharge for whirlsystem						
Air-System					760*** 00 1 00 1000	
Jet-System					760*** 00 2 00 1000	
Combi-System P					760*** 00 3 00 1000	
Combi-System E					760*** 00 4 16 1000	
Combi-System L					710*** 00 5 00 1000	
Additional modules for whirtub						
Additional modules for Combi-System E				Module-No.		
LED coloured light (replaces LED white light)				06		
Heating				07		
UV Hygiene Management				08		
Additional modules for Combi-System L				Module-No.		
LED coloured light (replaces white light)				06		
Temperature L				07		
UV Hygiene Management				08		
Necessary accessories for bath- and whirtub						
Suitable panels s.p. 374						
Accessories for bath- and whirtub						
Headrest, white					790001 00 0 00 0000	
Bathtub anchors					790103 00 0 00 0000	
Rubber profile					790104 00 0 00 0000	

continued on following page

Paiova Design by E00S

Bathtub corner right, with support frame for panel

5 mm sanitary acrylic

Length mm	Width mm	Depth mm	Capacity l	Weight kg	Model-No.	Euro	
						White	- 00
Bathtub							
1700	1300	460	235	55,0	700221 00 0 00 0000		
1800	1400	460	315	60,0	700223 00 0 00 0000		
Accessories for bathtub							
Waste and overflow Quadroval, chrome					790293 00 0 00 1000		
Waste and overflow Quadroval, with water inlet, chrome					790294 00 0 00 1000		
Waste and overflow, with base inlet, chrome *					791230 00 0 00 1000		
LED coloured light, with remote control for bathtubs, (white -00, chrome -10)					790840 00 0 00 * 00		
Sound					791851 00 0 00 0000		
Accessories for whirltub							
Surcharge, for waste and overflow Quadroval, with water inlet, chrome					791206 00 0 00 1000		
Surcharge, for waste and overflow, with base inlet, chrome *					791231 00 0 00 1000		
LED coloured light, for whirltubs with Air-System, Jet-System, Combi-System P, Durapearl-System or Jet Project					791850 00 0 00 1000		
Sound, for whirltubs with Air-System, Jet-System, Combi-System P, Durapearl-System or Jet Project					791852 00 0 00 0000		
Sound, for whirltubs with Combi-System E					791853 00 0 00 0000		

Infobox: * pipe interrupt mandatory

Paiova Design by E00S

Bathtub corner right, with integrated acrylic panel and support frame

5 mm sanitary acrylic

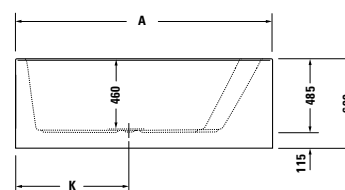
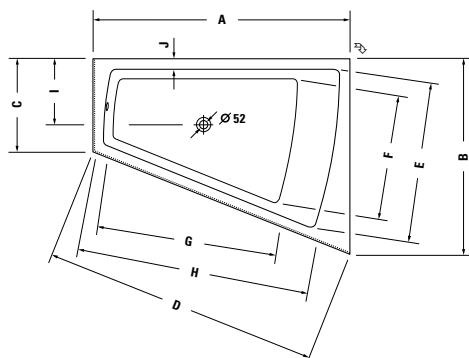

	A	B	C	D	E	F	G	H	I	J	K
700267	1700	1300	620	1830	1045	830	1215	1515	435	75	730
700269	1800	1400	680	1937	1140	870	1320	1620	465	75	780

Length mm	Width mm	Depth mm	Capacity l	Weight kg	Model-No.	Euro
						White - 00
Bathtub						
1700	1300	460	225	70,5	700267 00 0 00 0000	
1800	1400	460	295	80,0	700269 00 0 00 0000	
Surcharge for whirlsystem						
Air-System					760*** 00 1 00 1000	
Jet-System					760*** 00 2 00 1000	
Combi-System P					760*** 00 3 00 1000	
Combi-System E					760*** 00 4 16 1000	
Combi-System L					710*** 00 5 00 1000	
Additional modules for whirltub						
Additional modules for Combi-System E				Module-No.		
LED coloured light (replaces LED white light)				06		
Heating				07		
UV Hygiene Management				08		
Additional modules for Combi-System L				Module-No.		
LED coloured light (replaces white light)				06		
Temperature L				07		
UV Hygiene Management				08		
Accessories for bath- and whirltub						
Headrest, white					790001 00 0 00 0000	
Bathtub anchors					790103 00 0 00 0000	
Rubber profile					790104 00 0 00 0000	
Accessories for bathtub						
Waste and overflow Quadroval, chrome					790299 00 0 00 1000	
Waste and overflow Quadroval, with water inlet, chrome					791200 00 0 00 1000	
Waste and overflow, with base inlet, chrome *					791235 00 0 00 1000	
LED coloured light, with remote control for bathtubs, (white -00, chrome -10)					790840 00 0 00 * 00	
Sound					791851 00 0 00 0000	
continued on following page						



Paiova Design by E00S

Bathtub corner right, with integrated acrylic panel and support frame
5 mm sanitary acrylic

Length mm	Width mm	Depth mm	Capacity l	Weight kg	Model-No.	Euro	
						White	- 00
Bathtub							
1700	1300	460	225	70,5	700267 00 0 00 0000		
1800	1400	460	295	80,0	700269 00 0 00 0000		
Accessories for whirltub							
Surcharge, for waste and overflow Quadroval, with water inlet, chrome					791207 00 0 00 1000		
Surcharge, for waste and overflow, with base inlet, chrome *					791231 00 0 00 1000		
LED coloured light, for whirltubs with Air-System, Jet-System, Combi-System P, Durapearl-System or Jet Project					791850 00 0 00 1000		
Sound, for whirltubs with Air-System, Jet-System, Combi-System P, Durapearl-System or Jet Project					791852 00 0 00 0000		
Sound, for whirltubs with Combi-System E					791853 00 0 00 0000		

Infobox: * pipe interrupt mandatory

Paiova Accessories Design by E00S

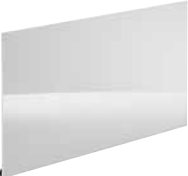
	Description	Model-No.	Euro
	Headrest white, for Paiova material: polyurethane	790001 00 0 00 0000	
	Acrylic panel sidewise, left, (for back-to-wall version) for # 700270	701121 00 0 00 0000	
	Acrylic panel sidewise, right, (for back-to-wall version) for # 700271	701120 00 0 00 0000	

Paiova Design by E00S

Panels for bath- and whirltubs

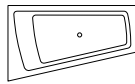

1700 x 1000 mm



700218

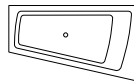

1700 x 1000 mm



700219

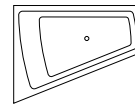

1700 x 1300 mm



700220

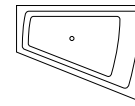

1700 x 1300 mm



700221

Model-No. panel



Corner left

PA 8714

PA 8710



Corner right

PA 8715

PA 8711

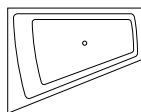

1800 x 1400 mm



700222

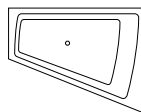

1800 x 1400 mm



700223



Corner left

PA 8712



Corner right

PA 8713

Acrylic panels for bath- and whirltubs

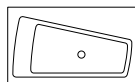

1700 x 1000 mm



700270

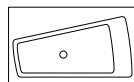

1700 x 1000 mm



700271

Model-No. acrylic panel



Corner left

**Acrylic panel
already included**



Corner right

**Acrylic panel
already included**



Back-to-wall

701121



Back-to-wall

701120



for 1 person



for 2 persons, side by side

Paiova Design by E00S

Product Information

Panel	Decor (Pricegroup 1)	53 Chestnut Dark 67 Rosewood	High-density-fiberboard, with laminate (HPL) pressed on both sides. Surfaces resistant to moisture.
	Acryl (Pricegroup 1)	82 Acrylic White	8 mm Acryl solid-coloured in white
	Real wood veneer (Pricegroup 2)	13 American Walnut 24 Macassar 26 American Cherry Tree 65 Bleached Oak	High-density-fiberboard, with real wood veneer pressed on one side and laminate (HPL) pressed on other side. Real wood veneer is a natural material, differences in colour and structure may occur. Surfaces resistant to moisture.
	Real wood veneer (Pricegroup 3)	12 Brushed Oak 59 Ebony 62 Anthracite Oak 69 Brushed Walnut	High-density-fiberboard, with real wood veneer pressed on one side and laminate (HPL) pressed on other side. Real wood veneer is a natural material, differences in colour and structure may occur. Surfaces resistant to moisture.

Paiova Design by E00S

Description	mm	Model-No.	Euro		
			Pricegroup 1	Pricegroup 2	Pricegroup 3
Panel					
for corner left					
for # 700218 (1700 x 1000 mm)		PA 8714			
for # 700220 (1700 x 1300 mm)		PA 8710			
for # 700222 (1800 x 1400 mm)		PA 8712			
Panel					
for corner right					
for # 700219 (1700 x 1000 mm)		PA 8715			
for # 700221 (1700 x 1300 mm)		PA 8711			
for # 700223 (1800 x 1400 mm)		PA 8713			

PuraVida Design by Phoenix Design

Bathtub rectangle, built-in or for panel, with one backrest slope left

5 mm sanitary acrylic

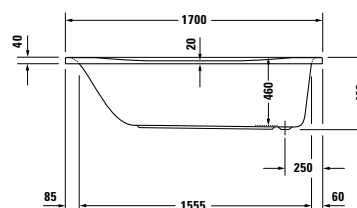
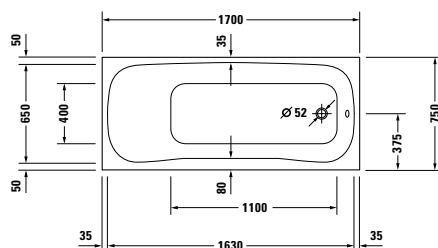

Length mm	Width mm	Depth mm	Capacity l	Weight kg	Model-No.	Euro
						White - 00
Bathtub						
1700	750	460	227	25,0	700181 00 0 00 0000	
Surcharge for whirlsystem						
Air-System					760*** 00 1 00 1000	
Jet-System					760*** 00 2 00 1000	
Combi-System P					760*** 00 3 00 1000	
Combi-System E					760*** 00 4 16 1000	
Combi-System L					710*** 00 5 00 1000	
Additional modules for whirltub						
Additional modules for Combi-System E				Module-No.		
LED coloured light (replaces LED white light)				06		
Heating				07		
UV Hygiene Management				08		
Additional modules for Combi-System L				Module-No.		
LED coloured light (replaces white light)				06		
Temperature L				07		
UV Hygiene Management				08		
Accessories for bath- and whirltub						
Bathtub anchors					790103 00 0 00 0000	
Rubber profile					790104 00 0 00 0000	
Suitable panels s.p. 383						
Accessories for bathtub						
Support frame, for bathtubs and shower trays, with length > 1000 mm					790100 00 0 00 0000	
Waste and overflow Quadroval, chrome					790285 00 0 00 1000	
Waste and overflow Quadroval, with water inlet, chrome					790286 00 0 00 1000	
Support, for # 700181 / # 700198					791920 00 0 00 0000	
LED coloured light, with remote control for bathtubs, (white -00, chrome -10)					790840 00 0 00 * 00	
Sound					791851 00 0 00 0000	
Accessories for whirltub						
Surcharge, for waste and overflow Quadroval, with water inlet, chrome					791205 00 0 00 1000	
LED coloured light, for whirltubs with Air-System, Jet-System, Combi-System P, Durapearl-System or Jet Project					791850 00 0 00 1000	
Sound, for whirltubs with Air-System, Jet-System, Combi-System P, Durapearl-System or Jet Project					791852 00 0 00 0000	
Sound, for whirltubs with Combi-System E					791853 00 0 00 0000	

Infobox: LED coloured light or sound is not suitable for bathtubs with support

PuraVida Design by Phoenix Design

Bathtub rectangle, built-in or for panel, with one backrest slope right
5 mm sanitary acrylic

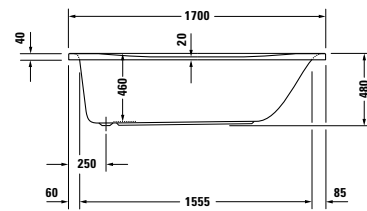
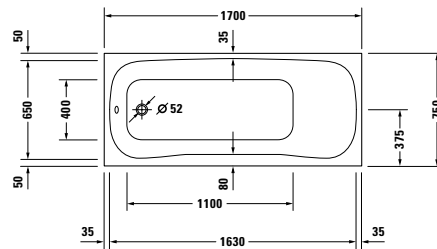

Length mm	Width mm	Depth mm	Capacity l	Weight kg	Model-No.	Euro
						White - 00
Bathtub						
1700	750	460	227	25,0	700198 00 0 00 0000	
Surcharge for whirlsystem						
Air-System					760*** 00 1 00 1000	
Jet-System					760*** 00 2 00 1000	
Combi-System P					760*** 00 3 00 1000	
Combi-System E					760*** 00 4 16 1000	
Combi-System L					710*** 00 5 00 1000	
Additional modules for whirltub						
Additional modules for Combi-System E				Module-No.		
LED coloured light (replaces LED white light)				06		
Heating				07		
UV Hygiene Management				08		
Additional modules for Combi-System L				Module-No.		
LED coloured light (replaces white light)				06		
Temperature L				07		
UV Hygiene Management				08		
Accessories for bath- and whirltub						
Bathtub anchors					790103 00 0 00 0000	
Rubber profile					790104 00 0 00 0000	
Suitable panels s.p. 383						
Accessories for bathtub						
Support frame, for bathtubs and shower trays, with length > 1000 mm					790100 00 0 00 0000	
Waste and overflow Quadroval, chrome					790285 00 0 00 1000	
Waste and overflow Quadroval, with water inlet, chrome					790286 00 0 00 1000	
Support, for # 700181 / # 700198					791920 00 0 00 0000	
LED coloured light, with remote control for bathtubs, (white -00, chrome -10)					790840 00 0 00 * *00	
Sound					791851 00 0 00 0000	
Accessories for whirltub						
Surcharge, for waste and overflow Quadroval, with water inlet, chrome					791205 00 0 00 1000	
LED coloured light, for whirltubs with Air-System, Jet-System, Combi-System P, Durapearl-System or Jet Project					791850 00 0 00 1000	
Sound, for whirltubs with Air-System, Jet-System, Combi-System P, Durapearl-System or Jet Project					791852 00 0 00 0000	
Sound, for whirltubs with Combi-System E					791853 00 0 00 0000	
Infobox: LED coloured light or sound is not suitable for bathtubs with support						

PuraVida Design by Phoenix Design

Bathtub rectangle, built-in or for panel
5 mm sanitary acrylic

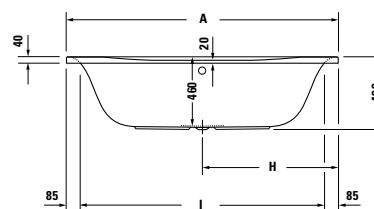
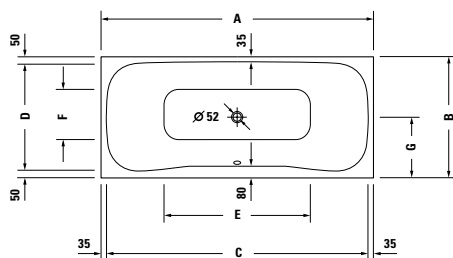

	A	B	C	D	E	F	G	H	I
700182	1800	800	1730	700	965	330	400	900	1630
700183	1900	900	1830	800	910	350	450	950	1730

Length mm	Width mm	Depth mm	Capacity l	Weight kg	Model-No.	Euro
						White - 00
Bathtub						
1800	800	460	196	27,0	700182 00 0 00 0000	
1900	900	460	236	30,0	700183 00 0 00 0000	
Surcharge for whirlsystem						
Air-System					760*** 00 1 00 1000	
Jet-System					760*** 00 2 00 1000	
Combi-System P					760*** 00 3 00 1000	
Combi-System E					760*** 00 4 16 1000	
Combi-System L					710*** 00 5 00 1000	
Additional modules for whirltub						
Additional modules for Combi-System E				Module-No.		
LED coloured light (replaces LED white light)				06		
Heating				07		
UV Hygiene Management				08		
Additional modules for Combi-System L				Module-No.		
LED coloured light (replaces white light)				06		
Temperature L				07		
UV Hygiene Management				08		
Accessories for bath- and whirltub						
Bathtub anchors					790103 00 0 00 0000	
Rubber profile					790104 00 0 00 0000	
Suitable panels s.p. 383						
continued on following page						

PuraVida Design by Phoenix Design

Bathtub rectangle, built-in or for panel
 5 mm sanitary acrylic

Length mm	Width mm	Depth mm	Capacity l	Weight kg	Model-No.	Euro	
						White	- 00
Bathtub							
1800	800	460	196	27,0	700182 00 0 00 0000		
1900	900	460	236	30,0	700183 00 0 00 0000		
Accessories for bathtub							
Support frame, for bathtubs and shower trays, with length > 1000 mm					790100 00 0 00 0000		
Waste and overflow Quadroval, chrome					790289 00 0 00 1000		
Waste and overflow Quadroval, with water inlet, chrome					790290 00 0 00 1000		
Waste and overflow, with base inlet, chrome *					791226 00 0 00 1000		
Support, for # 700182					791922 00 0 00 0000		
Support, for # 700183					791923 00 0 00 0000		
LED coloured light, with remote control for bathtubs, (white -00, chrome -10)					790840 00 0 00 * *00		
Sound					791851 00 0 00 0000		
Accessories for whirltub							
Surcharge, for waste and overflow Quadroval, with water inlet, chrome					791206 00 0 00 1000		
Surcharge, for waste and overflow, with base inlet, chrome *					791227 00 0 00 1000		
LED coloured light, for whirltubs with Air-System, Jet-System, Combi-System P, Durapearl-System or Jet Project					791850 00 0 00 1000		
Sound, for whirltubs with Air-System, Jet-System, Combi-System P, Durapearl-System or Jet Project					791852 00 0 00 0000		
Sound, for whirltubs with Combi-System E					791853 00 0 00 0000		

Infobox: * pipe interrupt mandatory / LED coloured light or sound is not suitable for bathtubs with support

PuraVida Design by Phoenix Design

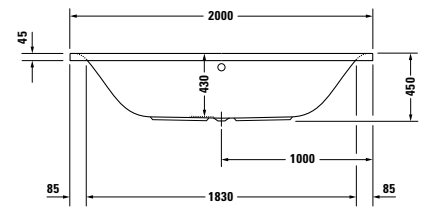
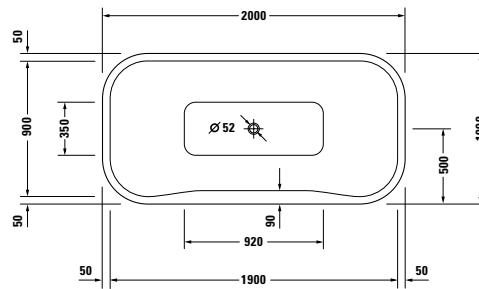
Bathtub rectangle, lay-on version
 5 mm sanitary acrylic

Length mm	Width mm	Depth mm	Capacity l	Weight kg	Model-No.	Euro
						White - 00
Bathtub						
2000	1000	430	245	36,0	700184 00 0 00 0000	
Surcharge for whirlsystem						
Air-System					760*** 00 1 00 1000	
Jet-System					760*** 00 2 00 1000	
Combi-System P					760*** 00 3 00 1000	
Combi-System E					760*** 00 4 16 1000	
Combi-System L					710*** 00 5 00 1000	
Additional modules for whirltub						
Additional modules for Combi-System E				Module-No.		
LED coloured light (replaces LED white light)				06		
Heating				07		
UV Hygiene Management				08		
Additional modules for Combi-System L				Module-No.		
LED coloured light (replaces white light)				06		
Temperature L				07		
UV Hygiene Management				08		
Accessories for bath- and whirltub						
Bathtub anchors					790103 00 0 00 0000	
Rubber profile					790104 00 0 00 0000	
Accessories for bathtub						
Support frame, for bathtubs and shower trays, with length > 1000 mm					790100 00 0 00 0000	
Waste and overflow Quadroval, chrome					790293 00 0 00 1000	
Waste and overflow Quadroval, with water inlet, chrome					790294 00 0 00 1000	
Waste and overflow, with base inlet, chrome *					791226 00 0 00 1000	
Support, for # 700184					791924 00 0 00 0000	
LED coloured light, with remote control for bathtubs, (white -00, chrome -10)					790840 00 0 00 * 00	
Sound					791851 00 0 00 0000	
Accessories for whirltub						
Surcharge, for waste and overflow Quadroval, with water inlet, chrome					791206 00 0 00 1000	
Surcharge, for waste and overflow, with base inlet, chrome *					791227 00 0 00 1000	
LED coloured light, for whirltubs with Air-System, Jet-System, Combi-System P, Durapearl-System or Jet Project					791850 00 0 00 1000	
Sound, for whirltubs with Air-System, Jet-System, Combi-System P, Durapearl-System or Jet Project					791852 00 0 00 0000	
Sound, for whirltubs with Combi-System E					791853 00 0 00 0000	

Infobox: * pipe interrupt mandatory / LED coloured light or sound is not suitable for bathtubs with support

PuraVida Design by Phoenix Design

Bathtub rectangle, freestanding, with acrylic panel and support frame

5 mm sanitary acrylic

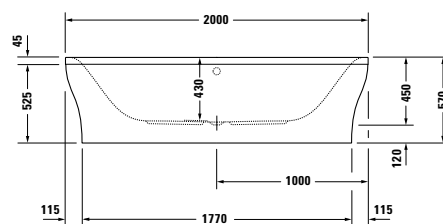
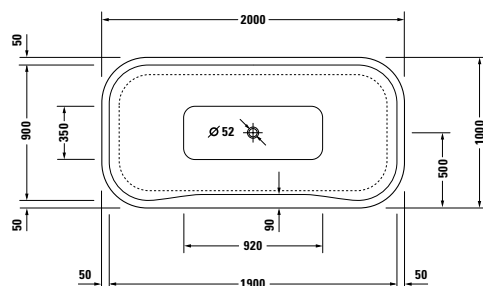

Length mm	Width mm	Depth mm	Capacity l	Weight kg	Model-No.	Euro
						White - 00
Bathtub						
2000	1000	430	245	72,0	700185 00 0 00 0000	
Surcharge for whirlsystem						
Air-System					760*** 00 1 00 1000	
Jet-System					760*** 00 2 00 1000	
Combi-System P					760*** 00 3 00 1000	
Combi-System E					760*** 00 4 16 1000	
Combi-System L					710*** 00 5 00 1000	
Additional modules for whirltub						
Additional modules for Combi-System E				Module-No.		
LED coloured light (replaces LED white light)				06		
Heating				07		
UV Hygiene Management				08		
Additional modules for Combi-System L				Module-No.		
LED coloured light (replaces white light)				06		
Temperature L				07		
UV Hygiene Management				08		
Accessories for bathtub						
Waste and overflow Quadroval, chrome					790295 00 0 00 1000	
Waste and overflow Quadroval, with water inlet, chrome					790296 00 0 00 1000	
Waste and overflow, with base inlet, chrome *					791228 00 0 00 1000	
LED coloured light, with remote control for bathtubs, (white -00, chrome -10)					790840 00 0 00 * 00	
Sound					791851 00 0 00 0000	
Accessories for whirltub						
Surcharge, for waste and overflow Quadroval, with water inlet, chrome					791206 00 0 00 1000	
Surcharge, for waste and overflow, with base inlet, chrome *					791229 00 0 00 1000	
LED coloured light, for whirltubs with Air-System, Jet-System, Combi-System P, Durapearl-System or Jet Project					791850 00 0 00 1000	
Sound, for whirltubs with Air-System, Jet-System, Combi-System P, Durapearl-System or Jet Project					791852 00 0 00 0000	
Sound, for whirltubs with Combi-System E					791853 00 0 00 0000	

Infobox: * pipe interrupt mandatory

PuraVida Design by Phoenix Design

Panels for bath- and whirltubs



1700 x 750 mm



700181

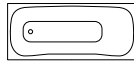

1700 x 750 mm



700198

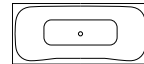

1800 x 800 mm



700182

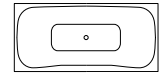

1900 x 900 mm



700183

Model-No. panel



Corner left

PV 8976

PV 8977

PV 8978



Corner right

PV 8973

PV 8974

PV 8975



Back-to-wall

PV 8970

PV 8970

PV 8971

PV 8972



Niche

PV 8979

PV 8979

PV 8980

PV 8981

A support frame is required for the installation of the panel. The support frame must be ordered separately

PuraVida Design by Phoenix Design

Product Information

Panel	Acryl (Pricegroup 1)	82 Acrylic White	8 mm Acryl solid-coloured in white
Shadow gap	Lacquer (Pricegroup 1)	40 Black High Gloss 85 White High Gloss 88 Red High Gloss	Compact laminated panel. Lacquered opaque in several coats on one side. Surface resistant to moisture.
	Real wood veneer (Pricegroup 1)	59 Ebony	Compact laminated panel, with real wood veneer pressed on one side. Real wood veneer is a natural material, differences in colour and structure may occur. Surface resistant to moisture.
	Laminate (Pricegroup 1)	70 Aluminium	Compact laminated panel, with laminate (HPL) pressed on both sides. Differences in colour and structure may occur. Surfaces resistant to moisture.

PuraVida Design by Phoenix Design

Description	mm	Model-No.	Euro
Panel			
for back-to-wall version			
for # 700181 (1700 x 750 mm)	1684 x 742	PV 8970	
for # 700198 (1700 X 750 mm)	1684 x 742	PV 8970	
for # 700182 (1800 x 800 mm)	1784 x 792	PV 8971	
for # 700183 (1900 x 900 mm)	1884 x 892	PV 8972	
Infobox: A support frame is required for the installation of the panel. The support frame must be ordered separately / Panel only available in 82 Acrylic White / Colour shadow gap: all PuraVida colours possible			
Panel			
for corner right			
for # 700198 (1700 X 750 mm)	1692 x 742	PV 8973	
for # 700182 (1800 x 800 mm)	1792 x 792	PV 8974	
for # 700183 (1900 x 900 mm)	1892 x 892	PV 8975	
Infobox: A support frame is required for the installation of the panel. The support frame must be ordered separately / Panel only available in 82 Acrylic White / Colour shadow gap: all PuraVida colours possible			
Panel			
for corner left			
for # 700181 (1700 x 750 mm)	1692 x 742	PV 8976	
for # 700182 (1800 x 800 mm)	1792 x 792	PV 8977	
for # 700183 (1900 x 900 mm)	1892 x 892	PV 8978	
Infobox: A support frame is required for the installation of the panel. The support frame must be ordered separately / Panel only available in 82 Acrylic White / Colour shadow gap: all PuraVida colours possible			
Panel			
for niche			
for # 700181 (1700 x 750 mm)	1675	PV 8979	
for # 700198 (1700 X 750 mm)	1675	PV 8979	
for # 700182 (1800 x 800 mm)	1775	PV 8980	
for # 700183 (1900 x 900 mm)	1875	PV 8981	
Infobox: A support frame is required for the installation of the panel. The support frame must be ordered separately / Panel only available in 82 Acrylic White / Colour shadow gap: all PuraVida colours possible			

Starck Design by Philippe Starck

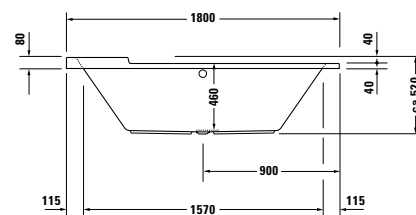
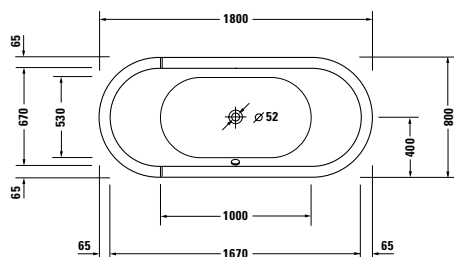
Bathtub oval, built-in
 5 mm sanitary acrylic

Length mm	Width mm	Depth mm	Capacity l	Weight kg	Model-No.	Euro
						White - 00
Bathtub						
1800	800	460	170	26,0	700009 00 0 00 0000	
Surcharge for whirlsystem						
Air-System					760*** 00 1 00 1000	
Jet-System					760*** 00 2 00 1000	
Combi-System P					760*** 00 3 00 1000	
Combi-System E					760*** 00 4 16 1000	
Combi-System L					710*** 00 5 00 1000	
Additional modules for whirltub						
Additional modules for Combi-System E				Module-No.		
LED coloured light (replaces LED white light)				06		
Heating				07		
UV Hygiene Management				08		
Additional modules for Combi-System L				Module-No.		
LED coloured light (replaces white light)				06		
Temperature L				07		
UV Hygiene Management				08		
Accessories for bathtub						
Support frame, for bathtubs and shower trays, with length > 1000 mm					790100 00 0 00 0000	
Waste and overflow Quadroval, chrome					790293 00 0 00 1000	
Waste and overflow Quadroval, with water inlet, chrome					790294 00 0 00 1000	
Waste and overflow, with base inlet, chrome *					791226 00 0 00 1000	
Support, for # 700009					790414 00 0 00 0000	
LED coloured light, with remote control for bathtubs, (white -00, chrome -10)					790840 00 0 00 * *00	
Sound					791851 00 0 00 0000	
Accessories for whirltub						
Surcharge, for waste and overflow Quadroval, with water inlet, chrome					791206 00 0 00 1000	
Surcharge, for waste and overflow, with base inlet, chrome *					791227 00 0 00 1000	
LED coloured light, for whirltubs with Air-System, Jet-System, Combi-System P, Durapearl-System or Jet Project					791850 00 0 00 1000	
Sound, for whirltubs with Air-System, Jet-System, Combi-System P, Durapearl-System or Jet Project					791852 00 0 00 0000	
Sound, for whirltubs with Combi-System E					791853 00 0 00 0000	

Infobox: * pipe interrupt mandatory / LED coloured light or sound is not suitable for bathtubs with support

Starck Design by Philippe Starck

Bathtub oval, freestanding, with acrylic panel and support frame

5 mm sanitary acrylic

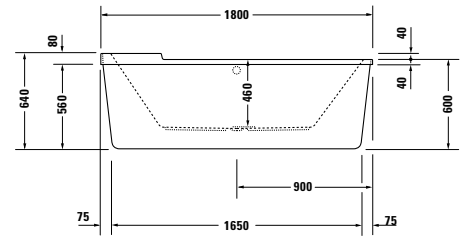
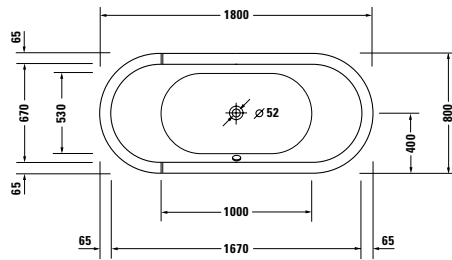

Length mm	Width mm	Depth mm	Capacity l	Weight kg	Model-No.	Euro
						White - 00
Bathtub						
1800	800	460	170	58,0	700010 00 0 00 0000	
Surcharge for whirlsystem						
Air-System					760*** 00 1 00 1000	
Jet-System					760*** 00 2 00 1000	
Combi-System P					760*** 00 3 00 1000	
Combi-System E					760*** 00 4 16 1000	
Combi-System L					710*** 00 5 00 1000	
Additional modules for whirltub						
Additional modules for Combi-System E				Module-No.		
LED coloured light (replaces LED white light)				06		
Heating				07		
UV Hygiene Management				08		
Additional modules for Combi-System L				Module-No.		
LED coloured light (replaces white light)				06		
Temperature L				07		
UV Hygiene Management				08		
Accessories for bathtub						
Waste and overflow Quadroval, chrome					790295 00 0 00 1000	
Waste and overflow Quadroval, with water inlet, chrome					790296 00 0 00 1000	
Waste and overflow, with base inlet, chrome *					791228 00 0 00 1000	
LED coloured light, with remote control for bathtubs, (white -00, chrome -10)					790840 00 0 00 * 00	
Sound					791851 00 0 00 0000	
Accessories for whirltub						
Surcharge, for waste and overflow Quadroval, with water inlet, chrome					791210 00 0 00 1000	
Surcharge, for waste and overflow, with base inlet, chrome *					791229 00 0 00 1000	
LED coloured light, for whirltubs with Air-System, Jet-System, Combi-System P, Durapearl-System or Jet Project					791850 00 0 00 1000	
Sound, for whirltubs with Air-System, Jet-System, Combi-System P, Durapearl-System or Jet Project					791852 00 0 00 0000	
Sound, for whirltubs with Combi-System E					791853 00 0 00 0000	

Infobox: * pipe interrupt mandatory

Starck Design by Philippe Starck

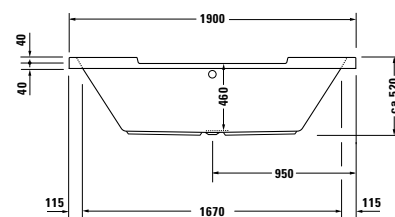
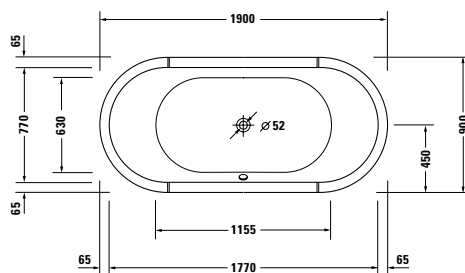
Bathtub oval, built-in
 5 mm sanitary acrylic

Length mm	Width mm	Depth mm	Capacity l	Weight kg	Model-No.	Euro
						White - 00
Bathtub						
1900	900	460	225	32,0	700011 00 0 00 0000	
Surcharge for whirlsystem						
Air-System					760*** 00 1 00 1000	
Jet-System					760*** 00 2 00 1000	
Combi-System P					760*** 00 3 00 1000	
Combi-System E					760*** 00 4 16 1000	
Combi-System L					710*** 00 5 00 1000	
Additional modules for whirltub						
Additional modules for Combi-System E				Module-No.		
LED coloured light (replaces LED white light)				06		
Heating				07		
UV Hygiene Management				08		
Additional modules for Combi-System L				Module-No.		
LED coloured light (replaces white light)				06		
Temperature L				07		
UV Hygiene Management				08		
Accessories for bathtub						
Support frame, for bathtubs and shower trays, with length > 1000 mm					790100 00 0 00 0000	
Waste and overflow Quadroval, chrome					790293 00 0 00 1000	
Waste and overflow Quadroval, with water inlet, chrome					790294 00 0 00 1000	
Waste and overflow, with base inlet, chrome *					791226 00 0 00 1000	
Support, for # 700011					790415 00 0 00 0000	
LED coloured light, with remote control for bathtubs, (white -00, chrome -10)					790840 00 0 00 * *00	
Sound					791851 00 0 00 0000	
Accessories for whirltub						
Surcharge, for waste and overflow Quadroval, with water inlet, chrome					791206 00 0 00 1000	
Surcharge, for waste and overflow, with base inlet, chrome *					791227 00 0 00 1000	
LED coloured light, for whirltubs with Air-System, Jet-System, Combi-System P, Durapearl-System or Jet Project					791850 00 0 00 1000	
Sound, for whirltubs with Air-System, Jet-System, Combi-System P, Durapearl-System or Jet Project					791852 00 0 00 0000	
Sound, for whirltubs with Combi-System E					791853 00 0 00 0000	

Infobox: * pipe interrupt mandatory / LED coloured light or sound is not suitable for bathtubs with support

Starck Design by Philippe Starck

Bathtub oval, freestanding, with acrylic panel and support frame

5 mm sanitary acrylic

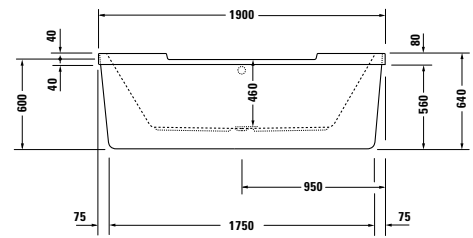
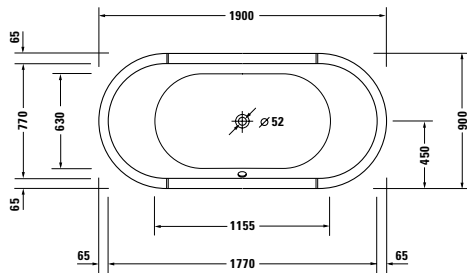

Length mm	Width mm	Depth mm	Capacity l	Weight kg	Model-No.	Euro
						White - 00
Bathtub						
1900	900	460	225	72,0	700012 00 0 00 0000	
Surcharge for whirlsystem						
Air-System					760*** 00 1 00 1000	
Jet-System					760*** 00 2 00 1000	
Combi-System P					760*** 00 3 00 1000	
Combi-System E					760*** 00 4 16 1000	
Combi-System L					710*** 00 5 00 1000	
Additional modules for whirltub						
Additional modules for Combi-System E				Module-No.		
LED coloured light (replaces LED white light)				06		
Heating				07		
UV Hygiene Management				08		
Additional modules for Combi-System L				Module-No.		
LED coloured light (replaces white light)				06		
Temperature L				07		
UV Hygiene Management				08		
Accessories for bathtub						
Waste and overflow Quadroval, chrome					790295 00 0 00 1000	
Waste and overflow Quadroval, with water inlet, chrome					790296 00 0 00 1000	
Waste and overflow, with base inlet, chrome *					791228 00 0 00 1000	
LED coloured light, with remote control for bathtubs, (white -00, chrome -10)					790840 00 0 00 * 00	
Sound					791851 00 0 00 0000	
Accessories for whirltub						
Surcharge, for waste and overflow Quadroval, with water inlet, chrome					791210 00 0 00 1000	
Surcharge, for waste and overflow, with base inlet, chrome *					791229 00 0 00 1000	
LED coloured light, for whirltubs with Air-System, Jet-System, Combi-System P, Durapearl-System or Jet Project					791850 00 0 00 1000	
Sound, for whirltubs with Air-System, Jet-System, Combi-System P, Durapearl-System or Jet Project					791852 00 0 00 0000	
Sound, for whirltubs with Combi-System E					791853 00 0 00 0000	

Infobox: * pipe interrupt mandatory

Starck Design by Philippe Starck

Bathtub rectangle, built-in or for panel, without backrest slope, with overflow
5 mm sanitary acrylic

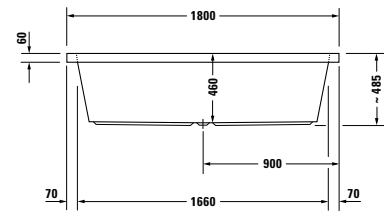
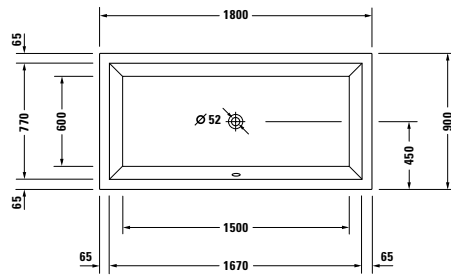

Length mm	Width mm	Depth mm	Capacity l	Weight kg	Model-No.	Euro
						White - 00
Bathtub						
1800	900	460	356	45,5	700048 00 0 00 0000	
Accessories for bathtub						
Support frame, for bathtubs and shower trays, with length > 1000 mm					790100 00 0 00 0000	
Bathtub anchors					790103 00 0 00 0000	
Rubber profile					790104 00 0 00 0000	
Waste and overflow Quadroval, chrome					790293 00 0 00 1000	
Waste and overflow Quadroval, with water inlet, chrome					790294 00 0 00 1000	
Support, for # 700048 / 700050 / 700052					790450 00 0 00 0000	
LED coloured light, with remote control for bathtubs, (white -00, chrome -10)					790840 00 0 00 * *00	
Sound					791851 00 0 00 0000	
Suitable panels s.p. 400						

Infobox: LED coloured light or sound is not suitable for bathtubs with support

Starck Design by Philippe Starck

Bathtub rectangle, built-in or for panel, with one backrest slope, with overflow
5 mm sanitary acrylic

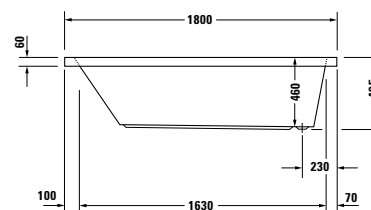
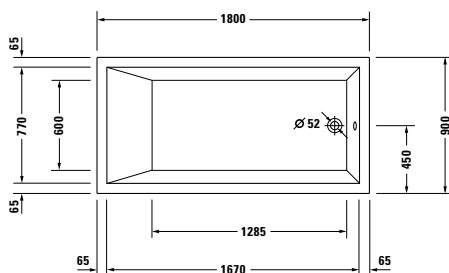

Length mm	Width mm	Depth mm	Capacity l	Weight kg	Model-No.	Euro
						White - 00
Bathtub						
1800	900	460	301	43,0	700050 00 0 00 0000	
Surcharge for whirlsystem						
Air-System					760*** 00 1 00 1000	
Jet-System					760*** 00 2 00 1000	
Combi-System P					760*** 00 3 00 1000	
Combi-System E					760*** 00 4 16 1000	
Combi-System L					710*** 00 5 00 1000	
Additional modules for whirltub						
Additional modules for Combi-System E				Module-No.		
LED coloured light (replaces LED white light)				06		
Heating				07		
UV Hygiene Management				08		
Additional modules for Combi-System L				Module-No.		
LED coloured light (replaces white light)				06		
Temperature L				07		
UV Hygiene Management				08		
Accessories for bath- and whirltub						
Bathtub anchors					790103 00 0 00 0000	
Rubber profile					790104 00 0 00 0000	
Suitable panels s.p. 400						
Accessories for bathtub						
Support frame, for bathtubs and shower trays, with length > 1000 mm					790100 00 0 00 0000	
Waste and overflow Quadroval, chrome					790285 00 0 00 1000	
Waste and overflow Quadroval, with water inlet, chrome					790286 00 0 00 1000	
Support, for # 700048 / 700050 / 700052					790450 00 0 00 0000	
LED coloured light, with remote control for bathtubs, (white -00, chrome -10)					790840 00 0 00 * 00	
Sound					791851 00 0 00 0000	
Accessories for whirltub						
Surcharge, for waste and overflow Quadroval, with water inlet, chrome					791205 00 0 00 1000	
LED coloured light, for whirltubs with Air-System, Jet-System, Combi-System P, Durapearl-System or Jet Project					791850 00 0 00 1000	
Sound, for whirltubs with Air-System, Jet-System, Combi-System P, Durapearl-System or Jet Project					791852 00 0 00 0000	
Sound, for whirltubs with Combi-System E					791853 00 0 00 0000	

Infobox: LED coloured light or sound is not suitable for bathtubs with support

Starck Design by Philippe Starck

Bathtub rectangle, built-in or for panel, with two backrest slopes, with overflow
5 mm sanitary acrylic

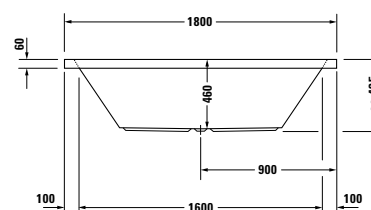
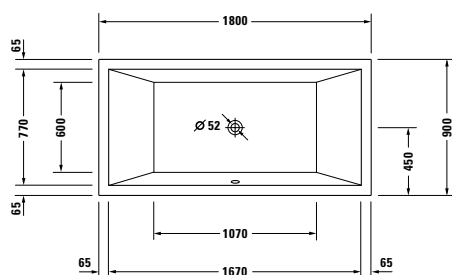

Length mm	Width mm	Depth mm	Capacity l	Weight kg	Model-No.	Euro
						White - 00
Bathtub						
1800	900	460	252	42,5	700052 00 0 00 0000	
Surcharge for whirlsystem						
Air-System					760*** 00 1 00 1000	
Jet-System					760*** 00 2 00 1000	
Combi-System P					760*** 00 3 00 1000	
Combi-System E					760*** 00 4 16 1000	
Combi-System L					710*** 00 5 00 1000	
Additional modules for whirltub						
Additional modules for Combi-System E				Module-No.		
LED coloured light (replaces LED white light)				06		
Heating				07		
UV Hygiene Management				08		
Additional modules for Combi-System L				Module-No.		
LED coloured light (replaces white light)				06		
Temperature L				07		
UV Hygiene Management				08		
Accessories for bath- and whirltub						
Bathtub anchors					790103 00 0 00 0000	
Rubber profile					790104 00 0 00 0000	
Suitable panels s.p. 400						
Accessories for bathtub						
Support frame, for bathtubs and shower trays, with length > 1000 mm					790100 00 0 00 0000	
Waste and overflow Quadroval, chrome					790293 00 0 00 1000	
Waste and overflow Quadroval, with water inlet, chrome					790294 00 0 00 1000	
Support, for # 700048 / 700050 / 700052					790450 00 0 00 0000	
LED coloured light, with remote control for bathtubs, (white -00, chrome -10)					790840 00 0 00 * *00	
Sound					791851 00 0 00 0000	
Accessories for whirltub						
Surcharge, for waste and overflow Quadroval, with water inlet, chrome					791206 00 0 00 1000	
LED coloured light, for whirltubs with Air-System, Jet-System, Combi-System P, Durapearl-System or Jet Project					791850 00 0 00 1000	
Sound, for whirltubs with Air-System, Jet-System, Combi-System P, Durapearl-System or Jet Project					791852 00 0 00 0000	
Sound, for whirltubs with Combi-System E					791853 00 0 00 0000	
Infobox: LED coloured light or sound is not suitable for bathtubs with support						

Starck Design by Philippe Starck

Bathtub rectangle, built-in or for panel
5 mm sanitary acrylic

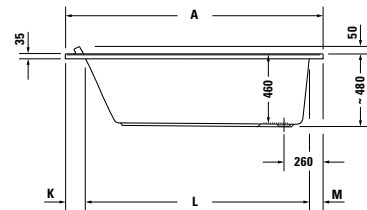
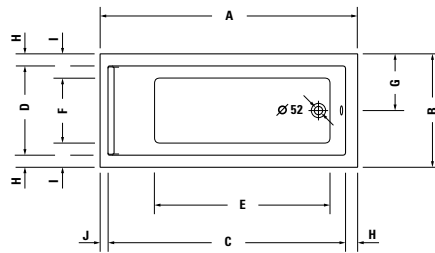

	A	B	C	D	E	F	G	H	I	J	K	L	M	N
700331	1500	700	1380	560	910	350	350	70	175	50	130	1290	80	1480
700332	1500	750	1380	610	910	400	375	70	175	50	130	1290	80	1480
700333	1600	700	1480	560	1025	360	350	70	170	50	130	1390	80	1580
700334	1700	700	1580	560	1160	360	350	70	170	50	130	1490	80	1680
700335	1700	750	1570	590	1160	390	375	80	180	50	130	1490	80	1680
700336	1700	800	1570	640	1160	440	400	80	180	50	130	1490	80	1680
700337	1700	900	1570	740	1160	540	450	80	180	50	130	1490	80	1680

Length mm	Width mm	Depth mm	Capacity l	Weight kg	Model-No.	Euro	
						White	- 00
Bathtub							
1500	700	460	196	24	700331 00 0 00 0000		
1500	750	460	210	24,5	700332 00 0 00 0000		
1600	700	460	210	26	700333 00 0 00 0000		
1700	700	460	230	27,5	700334 00 0 00 0000		
1700	750	460	240	29	700335 00 0 00 0000		
1700	800	460	261	29,5	700336 00 0 00 0000		
1700	900	460	296	33,5	700337 00 0 00 0000		
Surcharge for whirlsystem							
Air-System					760*** 00 1 00 1000		
Jet-System					760*** 00 2 00 1000		
Combi-System P					760*** 00 3 00 1000		
Combi-System E					760*** 00 4 16 1000		
Combi-System L					710*** 00 5 00 1000		
Additional modules for whirltub							
Additional modules for Combi-System E					Module-No.		
LED coloured light (replaces LED white light)					06		
Heating					07		
UV Hygiene Management					08		
Additional modules for Combi-System L					Module-No.		
LED coloured light (replaces white light)					06		
Temperature L					07		
UV Hygiene Management					08		
Accessories for bath- and whirtub							
Headrest, white					790010 00 0 00 0000		
Bathtub anchors					790103 00 0 00 0000		
Rubber profile					790104 00 0 00 0000		
Suitable panels s.p. 399							
continued on following page							

Starck Design by Philippe Starck

Bathtub rectangle, built-in or for panel
 5 mm sanitary acrylic

Length mm	Width mm	Depth mm	Capacity l	Weight kg	Model-No.	Euro	
						White	- 00
Bathtub							
1500	700	460	196	24	700331 00 0 00 0000		
1500	750	460	210	24,5	700332 00 0 00 0000		
1600	700	460	210	26	700333 00 0 00 0000		
1700	700	460	230	27,5	700334 00 0 00 0000		
1700	750	460	240	29	700335 00 0 00 0000		
1700	800	460	261	29,5	700336 00 0 00 0000		
1700	900	460	296	33,5	700337 00 0 00 0000		
Accessories for bathtub							
Support frame, for bathtubs and shower trays, with length > 1000 mm					790100 00 0 00 0000		
Waste and overflow Quadroval, chrome					790285 00 0 00 1000		
Waste and overflow Quadroval, with water inlet, chrome					790286 00 0 00 1000		
Support, for # 700331					791439 00 0 00 0000		
Support, for # 700332					791440 00 0 00 0000		
Support, for # 700333					791441 00 0 00 0000		
Support, for # 700334					791442 00 0 00 0000		
Support, for # 700335					791443 00 0 00 0000		
Support, for # 700336					791444 00 0 00 0000		
Support, for # 700337					791445 00 0 00 0000		
LED coloured light, with remote control for bathtubs, (white -00, chrome -10)					790840 00 0 00 * 00		
Sound					791851 00 0 00 0000		
Suitable tub covers s.p. 510/511							
Suitable panels s.p. 398							
Accessories for whirltub							
Surcharge, for waste and overflow Quadroval, with water inlet, chrome					791205 00 0 00 1000		
LED coloured light, for whirltubs with Air-System, Jet-System, Combi-System P, Durapearl-System or Jet Project					791850 00 0 00 1000		
Sound, for whirltubs with Air-System, Jet-System, Combi-System P, Durapearl-System or Jet Project					791852 00 0 00 0000		
Sound, for whirltubs with Combi-System E					791853 00 0 00 0000		
Suitable panels s.p. 398							

Infobox: LED coloured light or sound is not suitable for bathtubs with support

Starck Design by Philippe Starck

Bathtub rectangle, built-in or for panel

5 mm sanitary acrylic

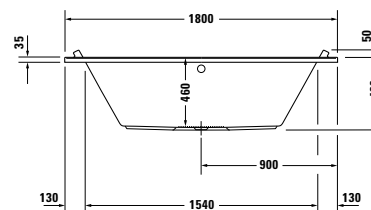
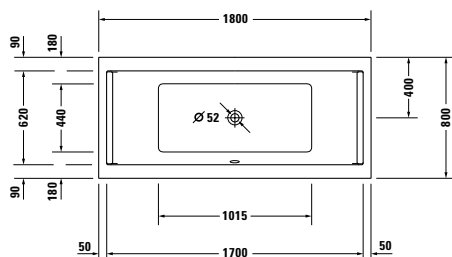

Length mm	Width mm	Depth mm	Capacity l	Weight kg	Model-No.	Euro
						White - 00
Bathtub						
1800	800	460	249	31,5	700338 00 0 00 0000	
Surcharge for whirlsystem						
Air-System					760*** 00 1 00 1000	
Jet-System					760*** 00 2 00 1000	
Combi-System P					760*** 00 3 00 1000	
Combi-System E					760*** 00 4 16 1000	
Combi-System L					710*** 00 5 00 1000	
Additional modules for whirltub						
Additional modules for Combi-System E				Module-No.		
LED coloured light (replaces LED white light)				06		
Heating				07		
UV Hygiene Management				08		
Additional modules for Combi-System L				Module-No.		
LED coloured light (replaces white light)				06		
Temperature L				07		
UV Hygiene Management				08		
Accessories for bath- and whirltub						
Headrest, white					790010 00 0 00 0000	
Bathtub anchors					790103 00 0 00 0000	
Rubber profile					790104 00 0 00 0000	
Suitable panels s.p. 400						
Accessories for bathtub						
Support frame, for bathtubs and shower trays, with length > 1000 mm					790100 00 0 00 0000	
Waste and overflow Quadroval, chrome					790289 00 0 00 1000	
Waste and overflow Quadroval, with water inlet, chrome					790290 00 0 00 1000	
Waste and overflow, with base inlet, chrome *					791226 00 0 00 1000	
Support, for # 700340					791446 00 0 00 0000	
LED coloured light, with remote control for bathtubs, (white -00, chrome -10)					790840 00 0 00 * *00	
Sound					791851 00 0 00 0000	
Suitable tub covers s.p. 510/511						
Suitable panels s.p. 398						
Accessories for whirltub						
Surcharge, for waste and overflow Quadroval, with water inlet, chrome					791206 00 0 00 1000	
Surcharge, for waste and overflow, with base inlet, chrome *					791227 00 0 00 1000	
LED coloured light, for whirltubs with Air-System, Jet-System, Combi-System P, Durapearl-System or Jet Project					791850 00 0 00 1000	
Sound, for whirltubs with Air-System, Jet-System, Combi-System P, Durapearl-System or Jet Project					791852 00 0 00 0000	
Sound, for whirltubs with Combi-System E					791853 00 0 00 0000	
Suitable panels s.p. 398						

Infobox: * pipe interrupt mandatory / LED coloured light or sound is not suitable for bathtubs with support

Starck Design by Philippe Starck

Bathtub rectangle, built-in or for panel
5 mm sanitary acrylic

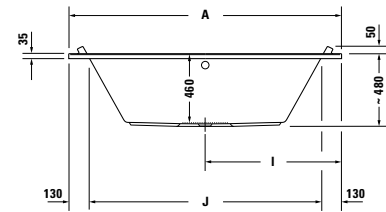
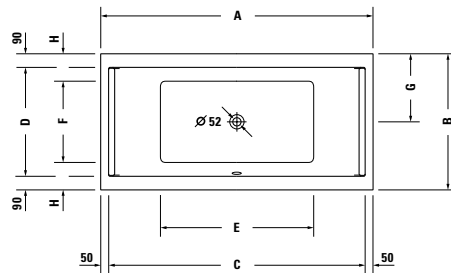

	A	B	C	D	E	F	G	H	I	J
700339	1800	900	1700	620	1015	540	400	180	900	1540
700340	1900	900	1800	720	1115	540	450	180	950	1640
700341	2000	1000	1900	820	1215	640	500	180	1000	1740

Length mm	Width mm	Depth mm	Capacity l	Weight kg	Model-No.	Euro
						White - 00
Bathtub						
1800	900	460	287	32,5	700339 00 0 00 0000	
1900	900	460	316	33,6	700340 00 0 00 0000	
2000	1000	460	384	39,5	700341 00 0 00 0000	
Surcharge for whirlsystem						
Air-System					760*** 00 1 00 1000	
Jet-System					760*** 00 2 00 1000	
Combi-System P					760*** 00 3 00 1000	
Combi-System E					760*** 00 4 16 1000	
Combi-System L					710*** 00 5 00 1000	
Additional modules for whirltub						
Additional modules for Combi-System E				Module-No.		
LED coloured light (replaces LED white light)				06		
Heating				07		
UV Hygiene Management				08		
Additional modules for Combi-System L				Module-No.		
LED coloured light (replaces white light)				06		
Temperature L				07		
UV Hygiene Management				08		
Accessories for bath- and whirltub						
Headrest, white					790010 00 0 00 0000	
Bathtub anchors					790103 00 0 00 0000	
Rubber profile					790104 00 0 00 0000	
Suitable panels s.p. 400						

continued on following page





Starck Design by Philippe Starck

Bathtub rectangle, built-in or for panel
 5 mm sanitary acrylic

Length mm	Width mm	Depth mm	Capacity l	Weight kg	Model-No.	Euro	
						White	- 00
Bathtub							
1800	900	460	287	32,5	700339 00 0 00 0000		
1900	900	460	316	33,6	700340 00 0 00 0000		
2000	1000	460	384	39,5	700341 00 0 00 0000		
Accessories for bathtub							
Support frame, for bathtubs and shower trays, with length > 1000 mm					790100 00 0 00 0000		
Waste and overflow Quadroval, chrome					790293 00 0 00 1000		
Waste and overflow Quadroval, with water inlet, chrome					790294 00 0 00 1000		
Waste and overflow, with base inlet, chrome *					791226 00 0 00 1000		
Support, for # 700339					791447 00 0 00 0000		
Support, for # 700340					791448 00 0 00 0000		
Support, for # 700341					791449 00 0 00 0000		
LED coloured light, with remote control for bathtubs, (white -00, chrome -10)					790840 00 0 00 * 00		
Sound					791851 00 0 00 0000		
Suitable panels s.p. 398							
Accessories for whirltub							
Surcharge, for waste and overflow Quadroval, with water inlet, chrome					791206 00 0 00 1000		
Surcharge, for waste and overflow, with base inlet, chrome *					791227 00 0 00 1000		
LED coloured light, for whirltubs with Air-System, Jet-System, Combi-System P, Durapearl-System or Jet Project					791850 00 0 00 1000		
Sound, for whirltubs with Air-System, Jet-System, Combi-System P, Durapearl-System or Jet Project					791852 00 0 00 0000		
Sound, for whirltubs with Combi-System E					791853 00 0 00 0000		
Suitable panels s.p. 398							

Infobox: * pipe interrupt mandatory / LED coloured light or sound is not suitable for bathtubs with support

Starck Accessories Design by Philippe Starck

	Description	Model-No.	Euro
	Headrest white, for Starck material: polyurethane	790010 00 0 00 0000	
	Acrylic panel front, for bathtubs 1500 mm 1600 mm 1700 mm 1800 mm 1900 mm 2000 mm	701065 00 0 00 0000 701066 00 0 00 0000 701067 00 0 00 0000 701068 00 0 00 0000 701069 00 0 00 0000 701070 00 0 00 0000	
Info box: The support frame # 790100 00 0 00 0000 is not included in the scope of delivery of the Starck acrylic panel and needs to be ordered separately			
	Acrylic panel sidewise, for bathtubs 700 mm 750 mm 800 mm 900 mm 1000 mm	701071 00 0 00 0000 701072 00 0 00 0000 701073 00 0 00 0000 701074 00 0 00 0000 701075 00 0 00 0000	
Info box: The support frame # 790100 00 0 00 0000 is not included in the scope of delivery of the Starck acrylic panel and needs to be ordered separately			
	Acrylic panel front, for whirltubs 1500 mm 1600 mm 1700 mm 1800 mm 1900 mm 2000 mm	703032 00 0 00 0000 703033 00 0 00 0000 703034 00 0 00 0000 703035 00 0 00 0000 703036 00 0 00 0000 703037 00 0 00 0000	
	Acrylic panel sidewise, for whirltubs 700 mm 750 mm 800 mm 900 mm 1000 mm	703038 00 0 00 0000 703039 00 0 00 0000 703040 00 0 00 0000 703041 00 0 00 0000 703042 00 0 00 0000	

Starck Design by Philippe Starck

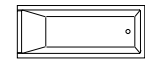
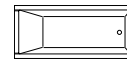
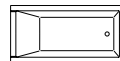
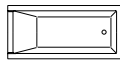
Panels for bath- and whirltubs

1500 x 700 mm

700331

1500 x 750 mm





700332

1600 x 700 mm

700333

1700 x 700 mm

700334
Model-No. panel

	Corner left	# ST 8908	# ST 8909	# ST 8785	# ST 8786
	Corner right	# ST 8915	# ST 8916	# ST 8780	# ST 8781
	Back-to-wall	# ST 8922	# ST 8923	# ST 8775	# ST 8776
	Niche	# ST 8936	# ST 8936	# ST 8937	# ST 8938

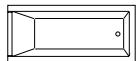

1700 x 750 mm





700335

1700 x 800 mm

700336

1700 x 900 mm

700337

	Corner left	# ST 8787	# ST 8910	# ST 8911
	Corner right	# ST 8782	# ST 8917	# ST 8918
	Back-to-wall	# ST 8777	# ST 8924	# ST 8925
	Niche	# ST 8938	# ST 8938	# ST 8938

A support frame is required for the installation of the panel. The support frame must be ordered separately

Starck Design by Philippe Starck

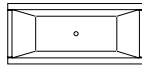
Panels for bath- and whirltubs

1800 x 800 mm

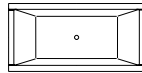
700338

1800 x 900 mm

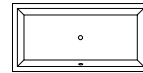
700339

1800 x 900 mm

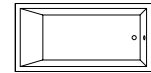
700048

1800 x 900 mm

700050
Model-No. panel

Corner left

ST 8788
ST 8912
ST 8912
ST 8912



Corner right

ST 8783
ST 8919
ST 8919
ST 8919

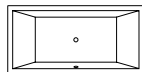

Back-to-wall

ST 8778
ST 8926
ST 8926
ST 8926

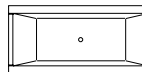

Niche

ST 8939
ST 8939
ST 8939
ST 8939

1800 x 900 mm

700052

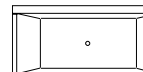
1900 x 900 mm

700340

2000 x 1000 mm

700341

Corner left

ST 8912
ST 8906
ST 8907

Corner right

ST 8919
ST 8904
ST 8905

Back-to-wall

ST 8926
ST 8902
ST 8903

Niche

ST 8939
ST 8941
ST 8942

A support frame is required for the installation of the panel. The support frame must be ordered separately

Starck Design by Philippe Starck

Product Information

Panel	Decor (Pricegroup 1)	43 Basalt Matt 49 Graphite Matt 50 Garnet Red Matt 53 Chestnut Dark 79 Natural Walnut	High-density-fiberboard, with laminate (HPL) pressed on both sides. Surfaces resistant to moisture.
	Acryl (Pricegroup 1)	82 Acrylic White	8 mm Acryl solid-coloured in white
	Real wood veneer (Pricegroup 2)	13 American Walnut 24 Macassar 26 American Cherry Tree 65 Bleached Oak	High-density-fiberboard, with real wood veneer pressed on one side and laminate (HPL) pressed on other side. Real wood veneer is a natural material, differences in colour and structure may occur. Surfaces resistant to moisture.
	Real wood veneer (Pricegroup 3)	05 Oak 12 Brushed Oak 62 Anthracite Oak 69 Brushed Walnut	High-density-fiberboard, with real wood veneer pressed on one side and laminate (HPL) pressed on other side. Real wood veneer is a natural material, differences in colour and structure may occur. Surfaces resistant to moisture.

Starck Design by Philippe Starck

Description	mm	Model-No.	Euro		
			Pricegroup 1	Pricegroup 2	Pricegroup 3
Panel					
for corner left					
for # 700331 (1500 x 700 mm)	1490 x 690	ST 8908			
for # 700332 (1500 x 750 mm)	1490 x 740	ST 8909			
for # 700333 (1600 x 700 mm)	1590 x 690	ST 8785			
for # 700334 (1700 x 700 mm)	1690 x 690	ST 8786			
for # 700335 (1700 x 750 mm)	1690 x 740	ST 8787			
for # 700336 (1700 x 800 mm)	1690 x 790	ST 8910			
for # 700337 (1700 x 900 mm)	1690 x 890	ST 8911			
for # 700338 (1800 x 800 mm)	1790 x 790	ST 8788			
for # 700048 (1800 x 900 mm)	1790 x 890	ST 8912			
for # 700050 (1800 x 900 mm)	1790 x 890	ST 8912			
for # 700052 (1800 x 900 mm)	1790 x 890	ST 8912			
for # 700339 (1800 x 900 mm)	1790 x 890	ST 8912			
for # 700340 (1900 x 900 mm)	1890 x 890	ST 8906			
for # 700341 (2000 x 1000 mm)	1990 x 990	ST 8907			

Infobox: A support frame is required for the installation of the panel. The support frame must be ordered separately / A support frame is required for the installation of the panel. The support frame must be ordered separately / Heights of Starck series: Height bathtub panel = 555 mm, Height bathtub panel incl. 10 mm shadow gap = 565 mm, overall height incl. bathtub rim 35 mm (for # 700048, 700050, 700052 60 mm) = 600 mm (625 mm)

Panel					
for corner right					
for # 700331 (1500 x 700 mm)	1490 x 690	ST 8915			
for # 700332 (1500 x 750 mm)	1490 x 740	ST 8916			
for # 700333 (1600 x 700 mm)	1590 x 690	ST 8780			
for # 700334 (1700 x 700 mm)	1690 x 690	ST 8781			
for # 700335 (1700 x 750 mm)	1690 x 740	ST 8782			
for # 700336 (1700 x 800 mm)	1690 x 790	ST 8917			
for # 700337 (1700 x 900 mm)	1690 x 890	ST 8918			
for # 700338 (1800 x 800 mm)	1790 x 790	ST 8783			
for # 700048 (1800 x 900 mm)	1790 x 890	ST 8919			
for # 700050 (1800 x 900 mm)	1790 x 890	ST 8919			
for # 700052 (1800 x 900 mm)	1790 x 890	ST 8919			
for # 700339 (1800 x 900 mm)	1790 x 890	ST 8919			
for # 700340 (1900 x 900 mm)	1890 x 890	ST 8904			
for # 700341 (2000 x 1000 mm)	1990 x 990	ST 8905			

Infobox: A support frame is required for the installation of the panel. The support frame must be ordered separately / Heights of Starck series: Height bathtub panel = 555 mm, Height bathtub panel incl. 10 mm shadow gap = 565 mm, overall height incl. bathtub rim 35 mm (for # 700048, 700050, 700052 60 mm) = 600 mm (625 mm)

Starck Design by Philippe Starck

Description	mm	Model-No.	Euro		
			Pricegroup 1	Pricegroup 2	Pricegroup 3
Panel					
for back-to-wall version					
for # 700331 (1500 x 700 mm)	1480 x 690	ST 8922			
for # 700332 (1500 x 750 mm)	1480 x 740	ST 8923			
for # 700333 (1600 x 700 mm)	1580 x 690	ST 8775			
for # 700334 (1700 x 700 mm)	1680 x 690	ST 8776			
for # 700335 (1700 x 750 mm)	1680 x 740	ST 8777			
for # 700336 (1700 x 800 mm)	1680 x 790	ST 8924			
for # 700337 (1700 x 900 mm)	1680 x 890	ST 8925			
for # 700338 (1800 x 800 mm)	1780 x 790	ST 8778			
for # 700048 (1800 x 900 mm)	1780 x 890	ST 8926			
for # 700050 (1800 x 900 mm)	1780 x 890	ST 8926			
for # 700052 (1800 x 900 mm)	1780 x 890	ST 8926			
for # 700339 (1800 x 900 mm)	1780 x 890	ST 8926			
for # 700340 (1900 x 900 mm)	1880 x 890	ST 8902			
for # 700341 (2000 x 1000 mm)	1980 x 990	ST 8903			

Infobox: A support frame is required for the installation of the panel. The support frame must be ordered separately / A support frame is required for the installation of the panel. The support frame must be ordered separately / Heights of Starck series: Height bathtub panel = 555 mm, Height bathtub panel incl. 10 mm shadow gap = 565 mm, overall height incl. bathtub rim 35 mm (for # 700048, 700050, 700052 60 mm) = 600 mm (625 mm)

Panel					
for niche					
for # 700331 (1500 x 700 mm)	1490	ST 8936			
for # 700332 (1500 x 750 mm)	1490	ST 8936			
for # 700333 (1600 x 700 mm)	1590	ST 8937			
for # 700334 (1700 x 700 mm)	1690	ST 8938			
for # 700335 (1700 x 750 mm)	1690	ST 8938			
for # 700336 (1700 x 800 mm)	1690	ST 8938			
for # 700337 (1700 x 900 mm)	1690	ST 8938			
for # 700338 (1800 x 800 mm)	1790	ST 8939			
for # 700048 (1800 x 900 mm)	1790	ST 8939			
for # 700050 (1800 x 900 mm)	1790	ST 8939			
for # 700052 (1800 x 900 mm)	1790	ST 8939			
for # 700339 (1800 x 900 mm)	1790	ST 8939			
for # 700340 (1900 x 900 mm)	1890	ST 8941			
for # 700341 (2000 x 1000 mm)	1990	ST 8942			

Infobox: A support frame is required for the installation of the panel. The support frame must be ordered separately / Heights of Starck series: Height bathtub panel = 555 mm, Height bathtub panel incl. 10 mm shadow gap = 565 mm, overall height incl. bathtub rim 35 mm (for # 700048, 700050, 700052 60 mm) = 600 mm (625 mm)

Sundeck Design by E00S

Product Information

Sundeck built-in version with rail-mount system

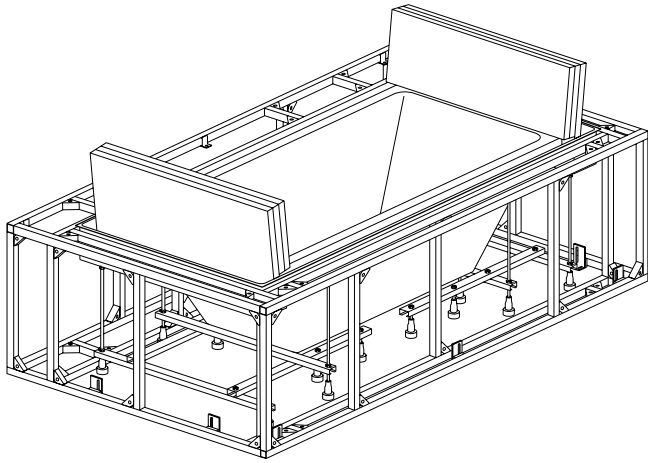

For bathtubs you can order either the support or rail-mount system. For whirltubs, the rail-mount system is obligatory and included.

All built-in versions (corner, back-to-wall, freestanding) are possible, as the rail-mount system is mounted all around.

Ordering the tap module is optional. Up to 4 hole faucets can be placed on the tiled surround (faucets tile-mounted and rim-mounted can be used). For rim-mounted faucets the tap module is necessary. Water inlet must be 210 mm minimum. The tap module includes a mounting plate and a box for hoses.

Sundeck bath- and whirltubs with base inlet

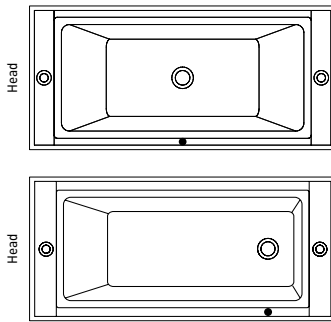

Location of the pull button in overflow channel:

The figure shows the standard location of the pull button in the overflow channel. The pull button operates the waste. On request, other locations on the opposite side are possible. We advise to always position the pull button in the front. Please send us a sketch showing the desired location.

Sundeck whirlsystems

Please consider the product information of Sundeck whirlsystems on page 252.

Legend



Pull button

Sundeck Design by E00S

Ordering Sample

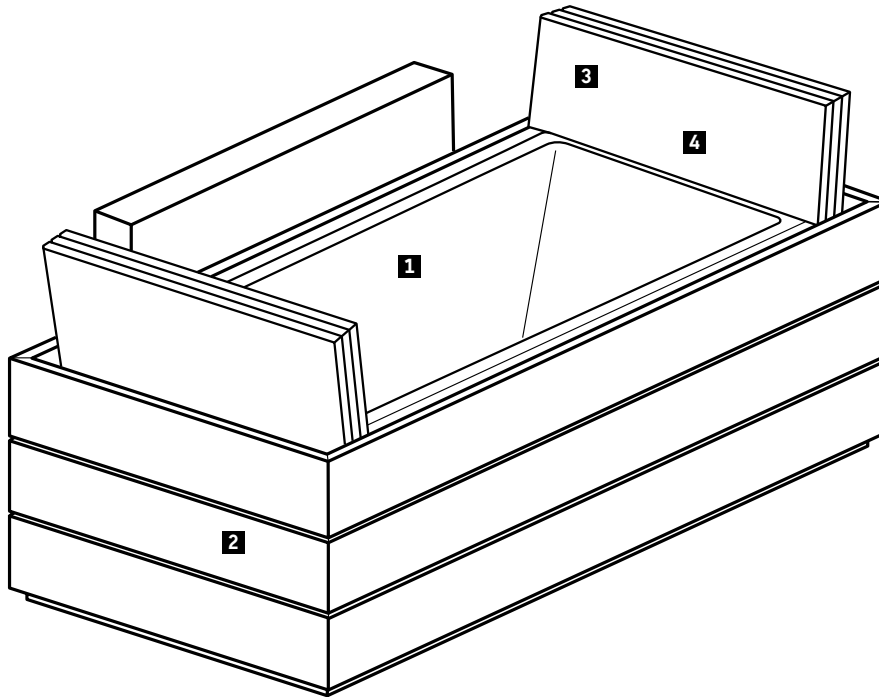

Description	Remark	Quantity	Model-No.
1 Bathtub	1855 x 855 mm	1	# 700127 00 0 00 0000
2 Panel with short pillar	1900 x 1000 x 765 mm	1	# SU 8842
3 Foldable relaxing deck	1855 x 855 mm	1	# 790831 00 0 00 0000
4 Waste and overflow (not visible)		1	# 790213 00 0 00 1000

Bathtub rectangle, built-in, with two backrest slopes, incl. fixation for foldable relaxing deck
5 mm sanitary acrylic

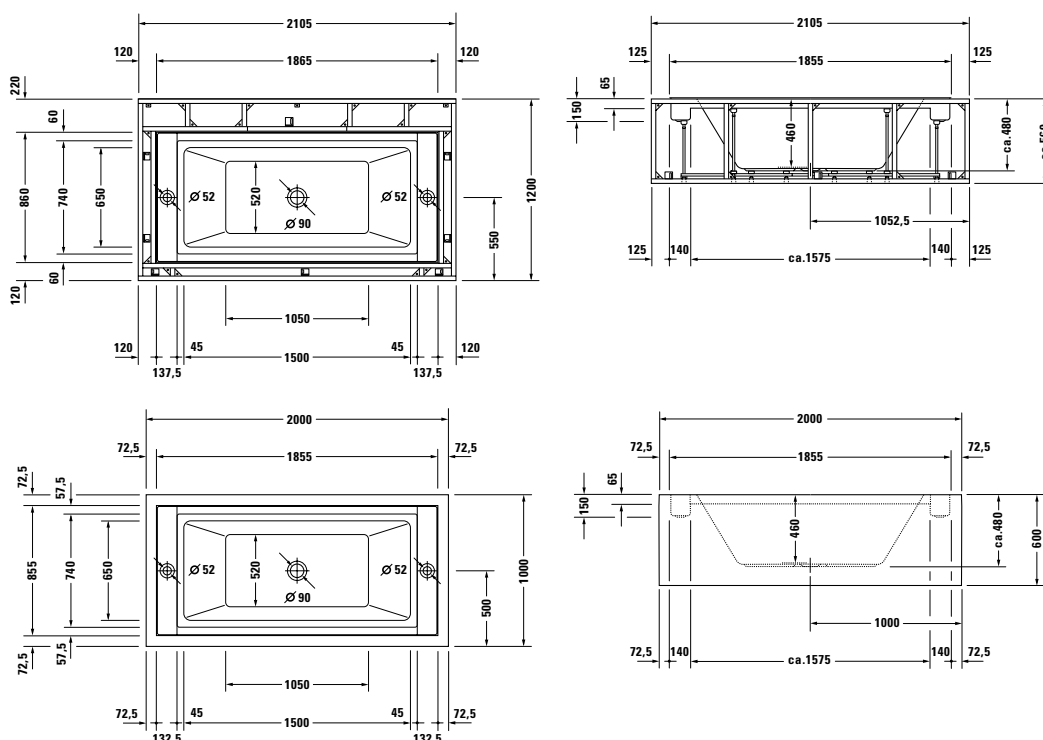

Length mm	Width mm	Depth mm	Capacity l	Weight kg	Model-No.	Euro
						White - 00
Bathtub						
1855	855	460	244	45,0	700065 00 0 00 0000	
Surcharge for whirlsystem						
Air-System					760** 00 1 00 1000	
Jet-System					760** 00 2 00 1000	
Combi-System P					760** 00 3 00 1000	
Combi-System E					760** 00 4 16 1000	
Combi-System L					710** 00 5 00 1000	
Additional modules for whirltub						
Additional modules for Combi-System E				Module-No.		
LED coloured light (replaces LED white light)				06		
Heating				07		
UV Hygiene Management				08		
Additional modules for Combi-System L				Module-No.		
LED coloured light (replaces white light)				06		
Temperature L				07		
UV Hygiene Management				08		
Necessary accessories for bath- and whirltub						
Foldable relaxing deck, cushioned, white, for # 700065, 700066, 700125, 700127					790831 00 0 00 0000	
Necessary accessories for bathtub						
Waste and overflow, with push-open valve, chrome					790213 00 0 00 1000	
Waste and overflow, with base inlet, chrome *					791237 00 0 00 1000	
Rail-mount system, for # 700065 **					790153 00 0 00 0000	
Support, for # 700065					790453 00 0 00 0000	
Accessories for bath- and whirltub						
Step, cushioned, white					790832 00 0 00 0000	
Bolster, white					790002 00 0 00 0000	
Tap module **					790155 00 0 00 0000	
continued on following page						

Sundeck Design by E00S

Bathtub rectangle, built-in, with two backrest slopes, incl. fixation for foldable relaxing deck
5 mm sanitary acrylic

Length mm	Width mm	Depth mm	Capacity l	Weight kg	Model-No.	Euro	
						White	- 00
Bathtub							
1855	855	460	244	45,0	700065 00 0 00 0000		
Accessories for bathtub							
LED coloured light, with remote control for bathtubs, (white -00, chrome -10)					790840 00 0 00 * *00		
Sound					791851 00 0 00 0000		
Accessories for whirltub							
Surcharge, for waste and overflow, with base inlet, chrome *					791239 00 0 00 1000		
LED coloured light, for whirltubs with Air-System, Jet-System, Combi-System P, Durapearl-System or Jet Project					791850 00 0 00 1000		
Sound, for whirltubs with Air-System, Jet-System, Combi-System P, Durapearl-System or Jet Project					791852 00 0 00 0000		
Sound, for whirltubs with Combi-System E					791853 00 0 00 0000		

Infobox: * assembled, pipe interrupt mandatory / ** When ordering rail-mount system and tap module please refer to page 404 / LED coloured light or sound is not suitable for bathtubs with support / No overflow hole, but overflow channel / Tub only available with foldable relaxing deck / Bathtub built-in version only available with styrofoam support or rail-mount system / Please order either # 790213 00 0 00 1000 or # 791237 00 0 00 1000 / For whirltubs the rail-mount system is included in delivery

Bathtub rectangle, built-in, with one backrest slope, incl. fixation for foldable relaxing deck
5 mm sanitary acrylic

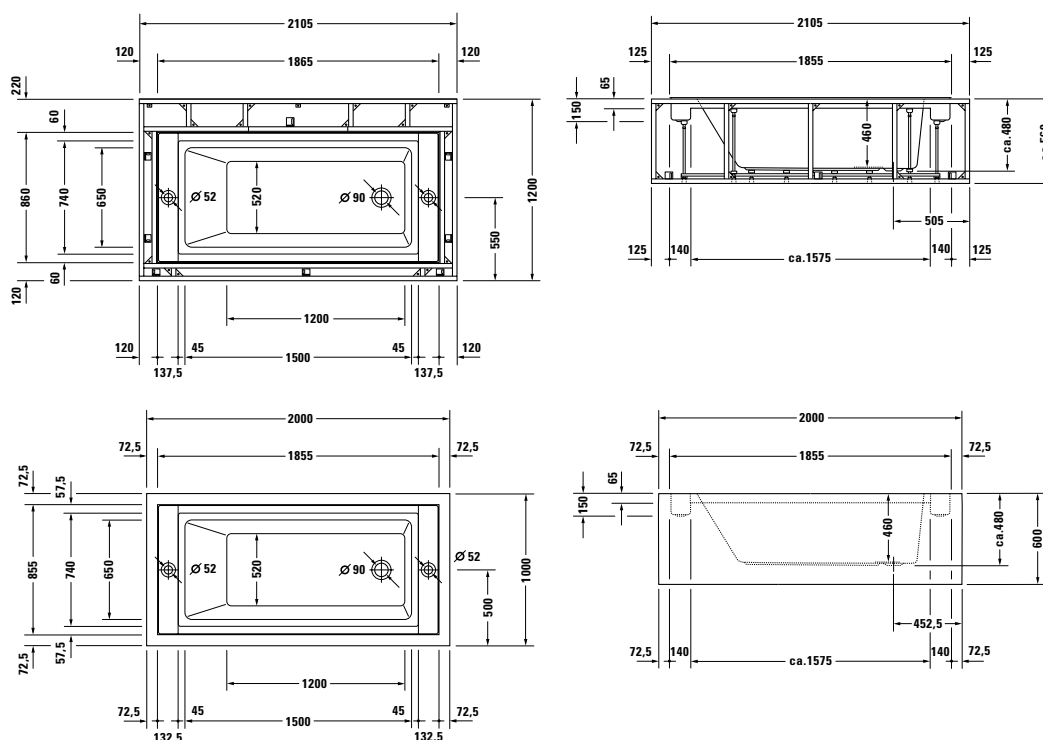

Length mm	Width mm	Depth mm	Capacity l	Weight kg	Model-No.	Euro
						White - 00
Bathtub						
1855	855	460	315	45,0	700125 00 0 00 0000	
Surcharge for whirlsystem						
Air-System					760** 00 1 00 1000	
Jet-System					760** 00 2 00 1000	
Combi-System P					760** 00 3 00 1000	
Combi-System E					760** 00 4 16 1000	
Combi-System L					710** 00 5 00 1000	
Additional modules for whirltub						
Additional modules for Combi-System E				Module-No.		
LED coloured light (replaces LED white light)				06		
Heating				07		
UV Hygiene Management				08		
Additional modules for Combi-System L				Module-No.		
LED coloured light (replaces white light)				06		
Temperature L				07		
UV Hygiene Management				08		
Necessary accessories for bath- and whirltub						
Foldable relaxing deck, cushioned, white, for # 700065, 700066, 700125, 700127					790831 00 0 00 0000	
Necessary accessories for bathtub						
Waste and overflow, with push-open valve, chrome					790213 00 0 00 1000	
Waste and overflow, with base inlet, chrome *					791237 00 0 00 1000	
Rail-mount system, for # 700125 **					790156 00 0 00 0000	
Support, for # 700125					790495 00 0 00 0000	
Accessories for bath- and whirltub						
Step, cushioned, white					790832 00 0 00 0000	
Bolster, white					790002 00 0 00 0000	
Tap module **					790155 00 0 00 0000	

continued on following page

Sundeck Design by E00S

Bathtub rectangle, built-in, with one backrest slope, incl. fixation for foldable relaxing deck
5 mm sanitary acrylic

Length mm	Width mm	Depth mm	Capacity l	Weight kg	Model-No.	Euro	
						White	- 00
Bathtub							
1855	855	460	315	45,0	700125 00 0 00 0000		
Accessories for bathtub							
LED coloured light, with remote control for bathtubs, (white -00, chrome -10)					790840 00 0 00 * *00		
Sound					791851 00 0 00 0000		
Accessories for whirltub							
Surcharge, for waste and overflow, with base inlet, chrome *					791239 00 0 00 1000		
LED coloured light, for whirltubs with Air-System, Jet-System, Combi-System P, Durapearl-System or Jet Project					791850 00 0 00 1000		
Sound, for whirltubs with Air-System, Jet-System, Combi-System P, Durapearl-System or Jet Project					791852 00 0 00 0000		
Sound, for whirltubs with Combi-System E					791853 00 0 00 0000		

Infobox: * assembled, pipe interrupt mandatory / ** When ordering rail-mount system and tap module please refer to page 404 / LED coloured light or sound is not suitable for bathtubs with support / No overflow hole, but overflow channel / Tub only available with foldable relaxing deck / Bathtub built-in version only available with styrofoam support or rail-mount system / Please order either # 790213 00 0 00 1000 or # 791237 00 0 00 1000 / For whirltubs the rail-mount system is included in delivery

Sundeck Design by E00S

Bathtub rectangle, built-in, with two backrest slopes, incl. fixation for foldable relaxing deck
5 mm sanitary acrylic

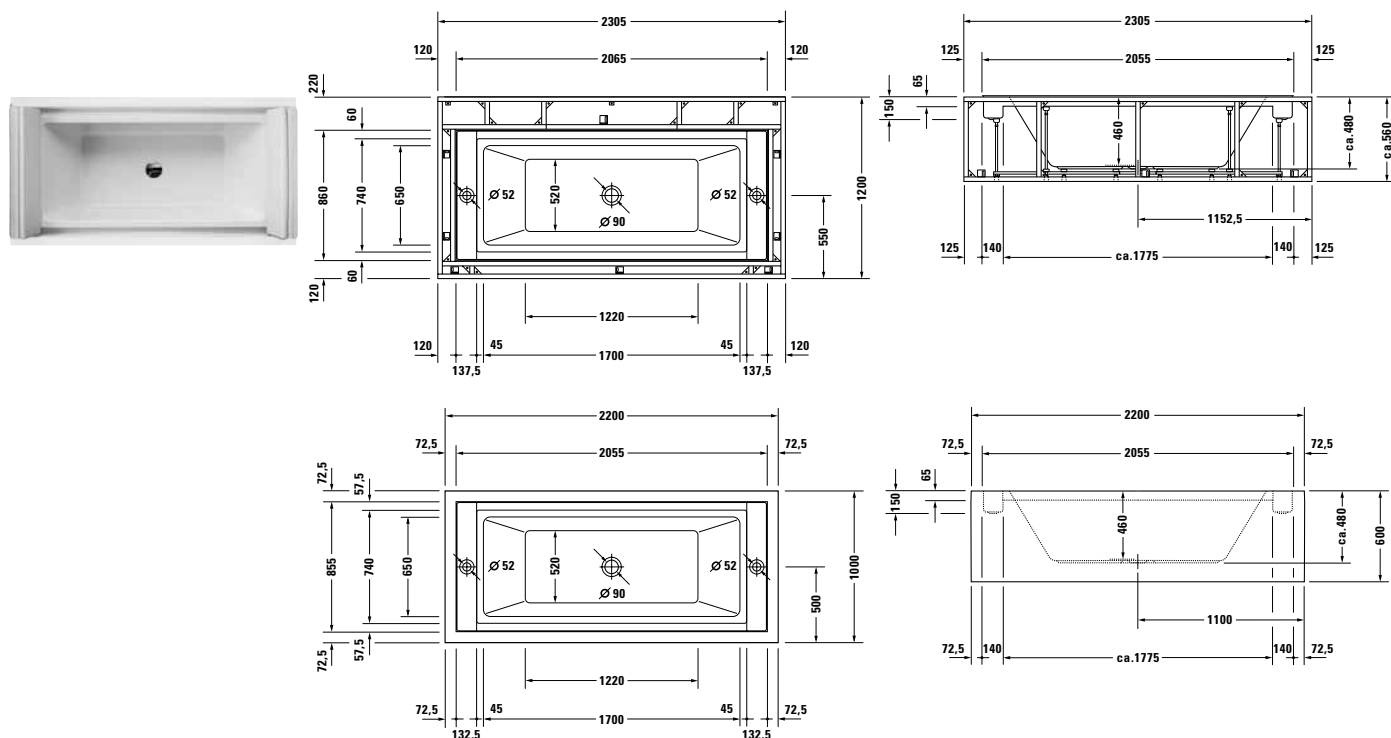

Length mm	Width mm	Depth mm	Capacity l	Weight kg	Model-No.	Euro
						White - 00
Bathtub						
2055	855	460	345	55,0	700126 00 0 00 0000	
Surcharge for whirlsystem						
Air-System					760** 00 1 00 1000	
Jet-System					760** 00 2 00 1000	
Combi-System P					760** 00 3 00 1000	
Combi-System E					760** 00 4 16 1000	
Combi-System L					710** 00 5 00 1000	
Additional modules for whirltub						
Additional modules for Combi-System E				Module-No.		
LED coloured light (replaces LED white light)				06		
Heating				07		
UV Hygiene Management				08		
Additional modules for Combi-System L				Module-No.		
LED coloured light (replaces white light)				06		
Temperature L				07		
UV Hygiene Management				08		
Necessary accessories for bath- and whirltub						
Foldable relaxing deck, cushioned, white, for # 700126, 700128					790848 00 0 00 0000	
Necessary accessories for bathtub						
Waste and overflow, with push-open valve, chrome					790213 00 0 00 1000	
Waste and overflow, with base inlet, chrome *					791237 00 0 00 1000	
Rail-mount system, for # 700126 **					790154 00 0 00 0000	
Support, for # 700126					790496 00 0 00 0000	
Accessories for bath- and whirltub						
Step, cushioned, white					790832 00 0 00 0000	
Bolster, white					790002 00 0 00 0000	
Tap module **					790155 00 0 00 0000	
continued on following page						

Sundeck Design by E00S

Bathtub rectangle, built-in, with two backrest slopes, incl. fixation for foldable relaxing deck
 5 mm sanitary acrylic

Length mm	Width mm	Depth mm	Capacity l	Weight kg	Model-No.	Euro	
						White	- 00
Bathtub							
2055	855	460	345	55,0	700126 00 0 00 0000		
Accessories for bathtub							
LED coloured light, with remote control for bathtubs, (white -00, chrome -10)					790840 00 0 00 * *00		
Sound					791851 00 0 00 0000		
Accessories for whirltub							
Surcharge, for waste and overflow, with base inlet, chrome *					791239 00 0 00 1000		
LED coloured light, for whirltubs with Air-System, Jet-System, Combi-System P, Durapearl-System or Jet Project					791850 00 0 00 1000		
Sound, for whirltubs with Air-System, Jet-System, Combi-System P, Durapearl-System or Jet Project					791852 00 0 00 0000		
Sound, for whirltubs with Combi-System E					791853 00 0 00 0000		

Infobox: * assembled, pipe interrupt mandatory / ** When ordering rail-mount system and tap module please refer to page 404 / LED coloured light or sound is not suitable for bathtubs with support / No overflow hole, but overflow channel / Tub only available with foldable relaxing deck / Bathtub built-in version only available with styrofoam support or rail-mount system / Please order either # 790213 00 0 00 1000 or # 791237 00 0 00 1000 / For whirltubs the rail-mount system is included in delivery

Sundeck Design by E00S

Bathtub rectangle, built-in, with two backrest slopes, incl. fixation for foldable relaxing deck
5 mm sanitary acrylic

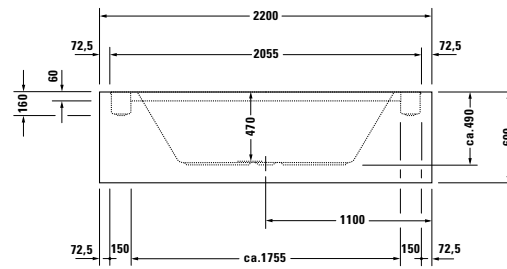
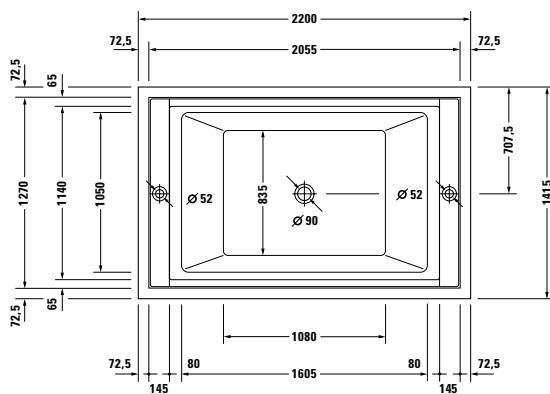
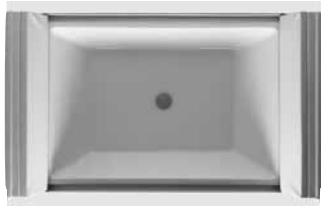

Length mm	Width mm	Depth mm	Capacity l	Weight kg	Model-No.	Euro
						White - 00
Bathtub						
2055	1270	470	493	68,0	700196 00 0 00 0000	
Necessary accessories for bathtub						
Waste and overflow, with push-open valve, chrome					790213 00 0 00 1000	
Waste and overflow, with base inlet, chrome *					791237 00 0 00 1000	
Foldable relaxing deck, cushioned, white					790875 00 0 00 0000	
Support, for # 700196					791406 00 0 00 0000	
Accessories for bathtub						
Step, cushioned, white					790832 00 0 00 0000	
Bolster, white					790002 00 0 00 0000	
LED coloured light, with remote control for bathtubs, (white -00, chrome -10)					790840 00 0 00 * 00	

Infobox: * assembled, pipe interrupt mandatory / No overflow hole, but overflow channel / Tub only available with foldable relaxing deck / Built-in version only available with styrofoam support / Please order either # 790213 00 0 00 1000 or # 791237 00 0 00 1000

Sundeck Design by E00S

Bathtub rectangle, with support frame for panel, with two backrest slopes, incl. fixation for foldable relaxing deck
5 mm sanitary acrylic

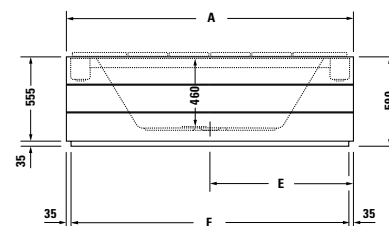
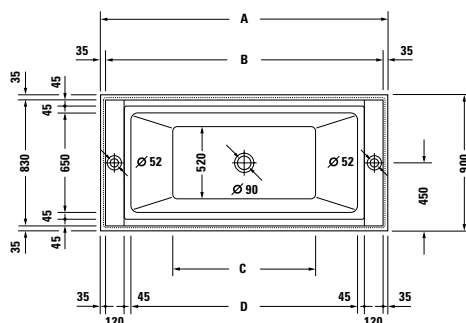

	A	B	C	D	E	F
700066	1900	1830	1050	1500	950	1830
700128	2100	2030	1220	1700	1050	2030

Length mm	Width mm	Depth mm	Capacity l	Weight kg	Model-No.	Euro
						White - 00
Bathtub						
1855	855	460	244	58,0	700066 00 0 00 0000	
2055	855	460	345	65,0	700128 00 0 00 0000	
Necessary accessories for bathtub						
Waste and overflow, with push-open valve, chrome					790213 00 0 00 1000	
Waste and overflow, with base inlet, chrome *					791237 00 0 00 1000	
Foldable relaxing deck, cushioned, white, for # 700065, 700066, 700125, 700127					790831 00 0 00 0000	
Foldable relaxing deck, cushioned, white, for # 700126, 700128					790848 00 0 00 0000	
Suitable panels s.p. 424						
Accessories for bathtub						
Step, cushioned, white					790832 00 0 00 0000	
Bolster, white					790002 00 0 00 0000	
LED coloured light, with remote control for bathtubs, (white -00, chrome -10)					790840 00 0 00 * *00	
Sound					791851 00 0 00 0000	
Persenning, for freestanding version, for panel without pillar, blue, for # 700066, 700127					790842 00 0 00 0000	
Persenning, for freestanding version, for panel without pillar, blue, for # 700128					790859 00 0 00 0000	

Infobox: * assembled, pipe interrupt mandatory / No overflow hole, but overflow channel / Tub only available with foldable relaxing deck / Please order either # 790213 00 0 00 1000 or # 791237 00 0 00 1000

Sundeck Design by E00S

Bathtub rectangle, with support frame for panel, with two backrest slopes, incl. fixation for foldable relaxing deck
5 mm sanitary acrylic

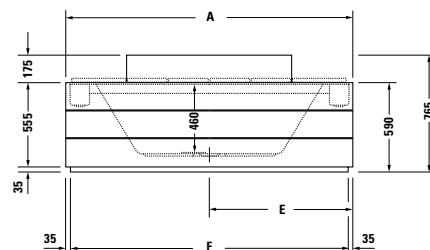
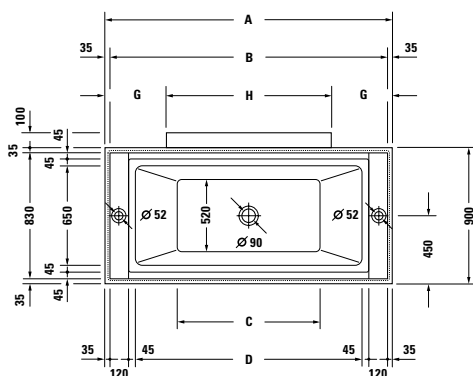

	A	B	C	D	E	F	G	H
700066	1900	1830	1050	1500	950	1830	405	1090
700128	2100	2030	1220	1700	1050	2030	505	1090

Length mm	Width mm	Depth mm	Capacity l	Weight kg	Model-No.	Euro
						White - 00
Bathtub						
1855	855	460	244	58,0	700066 00 0 00 0000	
2055	855	460	345	65,0	700128 00 0 00 0000	
Surcharge for whirlsystem						
Air-System					760*** 00 1 00 1000	
Jet-System					760*** 00 2 00 1000	
Combi-System P					760*** 00 3 00 1000	
Combi-System E					760*** 00 4 16 1000	
Combi-System L					710*** 00 5 00 1000	
Additional modules for whirltub						
Additional modules for Combi-System E				Module-No.		
LED coloured light (replaces LED white light)				06		
Heating				07		
UV Hygiene Management				08		
Additional modules for Combi-System L				Module-No.		
LED coloured light (replaces white light)				06		
Temperature L				07		
UV Hygiene Management				08		
Necessary accessories for bath- and whirltub						
Foldable relaxing deck, cushioned, white, for # 700065, 700066, 700125, 700127					790831 00 0 00 0000	
Foldable relaxing deck, cushioned, white, for # 700126, 700128					790848 00 0 00 0000	
Suitable panels s.p. 424						
Necessary accessories for bathtub						
Waste and overflow, with push-open valve, chrome					790213 00 0 00 1000	
Waste and overflow, with base inlet, chrome *					791237 00 0 00 1000	

continued on following page

Sundeck Design by E00S

Bathtub rectangle, with support frame for panel, with two backrest slopes, incl. fixation for foldable relaxing deck
5 mm sanitary acrylic

Length mm	Width mm	Depth mm	Capacity l	Weight kg	Model-No.	Euro	
						White	- 00
Bathtub							
1855	855	460	244	58,0	700066 00 0 00 0000		
2055	855	460	345	65,0	700128 00 0 00 0000		
Accessories for bath- and whirltub							
Step, cushioned, white					790832 00 0 00 0000		
Bolster, white					790002 00 0 00 0000		
Persenning, for freestanding version, for panel with short pillar, blue, for # 700066, 700127					790843 00 0 00 0000		
Persenning, for freestanding version, for panel with short pillar, blue, for # 700128					790860 00 0 00 0000		
Accessories for bathtub							
LED coloured light, with remote control for bathtubs, (white -00, chrome -10)					790840 00 0 00 * *00		
Sound					791851 00 0 00 0000		
Accessories for whirltub							
Surcharge, for waste and overflow, with base inlet, chrome *					791238 00 0 00 1000		
LED coloured light, for whirltubs with Air-System, Jet-System, Combi-System P, Durapearl-System or Jet Project					791850 00 0 00 1000		
Sound, for whirltubs with Air-System, Jet-System, Combi-System P, Durapearl-System or Jet Project					791852 00 0 00 0000		
Sound, for whirltubs with Combi-System E					791853 00 0 00 0000		

Infobox: * assembled, pipe interrupt mandatory / No overflow hole, but overflow channel / Tub only available with foldable relaxing deck / Please order either # 790213 00 0 00 1000 or # 791237 00 0 00 1000

Sundeck Design by E00S

Bathtub rectangle, with support frame for panel, with two backrest slopes, incl. fixation for foldable relaxing deck
5 mm sanitary acrylic

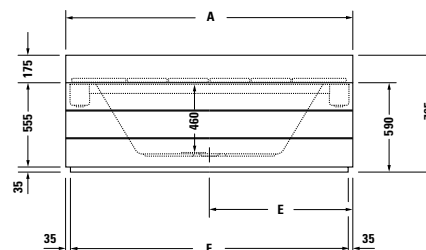
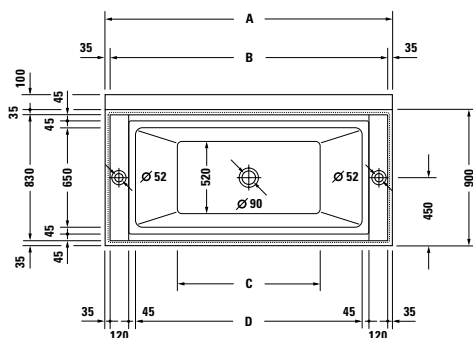

	A	B	C	D	E	F
700066	1900	1830	1050	1500	950	1830
700128	2100	2030	1220	1700	1050	2030

Length mm	Width mm	Depth mm	Capacity l	Weight kg	Model-No.	Euro
						White - 00
Bathtub						
1855	855	460	244	58,0	700066 00 0 00 0000	
2055	855	460	345	65,0	700128 00 0 00 0000	
Surcharge for whirlsystem						
Air-System					760*** 00 1 00 1000	
Jet-System					760*** 00 2 00 1000	
Combi-System P					760*** 00 3 00 1000	
Combi-System E					760*** 00 4 16 1000	
Combi-System L					710*** 00 5 00 1000	
Additional modules for whirltub						
Additional modules for Combi-System E				Module-No.		
LED coloured light (replaces LED white light)				06		
Heating				07		
UV Hygiene Management				08		
Additional modules for Combi-System L				Module-No.		
LED coloured light (replaces white light)				06		
Temperature L				07		
UV Hygiene Management				08		
Necessary accessories for bath- and whirltub						
Foldable relaxing deck, cushioned, white, for # 700065, 700066, 700125, 700127					790831 00 0 00 0000	
Foldable relaxing deck, cushioned, white, for # 700126, 700128					790848 00 0 00 0000	
Suitable panels s.p. 424						
Necessary accessories for bathtub						
Waste and overflow, with push-open valve, chrome					790213 00 0 00 1000	
Waste and overflow, with base inlet, chrome *					791237 00 0 00 1000	

continued on following page

Sundeck Design by E00S

Bathtub rectangle, with support frame for panel, with two backrest slopes, incl. fixation for foldable relaxing deck
5 mm sanitary acrylic

Length mm	Width mm	Depth mm	Capacity l	Weight kg	Model-No.	Euro	
						White	- 00
Bathtub							
1855	855	460	244	58,0	700066 00 0 00 0000		
2055	855	460	345	65,0	700128 00 0 00 0000		
Accessories for bath- and whirltub							
Step, cushioned, white					790832 00 0 00 0000		
Bolster, white					790002 00 0 00 0000		
Persenning, for freestanding version, for panel with long pillar, blue, for # 700066, 700127					790844 00 0 00 0000		
Persenning, for freestanding version, for panel with long pillar, blue, for # 700128					790861 00 0 00 0000		
Accessories for bathtub							
LED coloured light, with remote control for bathtubs, (white -00, chrome -10)					790840 00 0 00 * *00		
Sound					791851 00 0 00 0000		
Accessories for whirltub							
Surcharge, for waste and overflow, with base inlet, chrome *					791238 00 0 00 1000		
LED coloured light, for whirltubs with Air-System, Jet-System, Combi-System P, Durapearl-System or Jet Project					791850 00 0 00 1000		
Sound, for whirltubs with Air-System, Jet-System, Combi-System P, Durapearl-System or Jet Project					791852 00 0 00 0000		
Sound, for whirltubs with Combi-System E					791853 00 0 00 0000		

Infobox: * assembled, pipe interrupt mandatory / No overflow hole, but overflow channel / Tub only available with foldable relaxing deck / Please order either # 790213 00 0 00 1000 or # 791237 00 0 00 1000

Sundeck Design by E00S

Bathtub rectangle, with support frame for panel, with one backrest slope, incl. fixation for foldable relaxing deck
5 mm sanitary acrylic

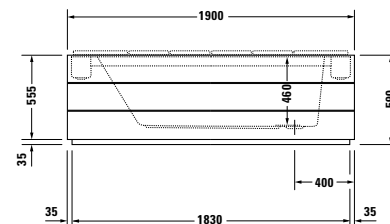
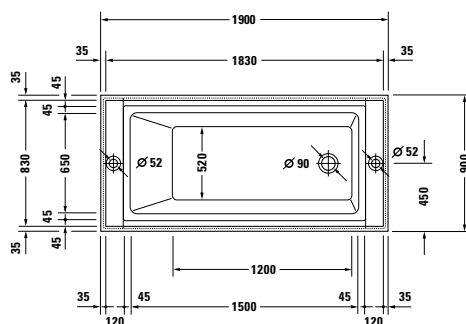

Length mm	Width mm	Depth mm	Capacity l	Weight kg	Model-No.	Euro
						White - 00
Bathtub						
1855	855	460	315	58,0	700127 00 0 00 0000	
Necessary accessories for bathtub						
Waste and overflow, with push-open valve, chrome					790213 00 0 00 1000	
Waste and overflow, with base inlet, chrome *					791237 00 0 00 1000	
Foldable relaxing deck, cushioned, white, for # 700065, 700066, 700125, 700127					790831 00 0 00 0000	
Suitable panels s.p. 424						
Accessories for bathtub						
Step, cushioned, white					790832 00 0 00 0000	
Bolster, white					790002 00 0 00 0000	
LED coloured light, with remote control for bathtubs, (white -00, chrome -10)					790840 00 0 00 * 00	
Sound					791851 00 0 00 0000	
Persenning, for freestanding version, for panel without pillar, blue, for # 700066, 700127					790842 00 0 00 0000	

Infobox: * assembled, pipe interrupt mandatory / Please order either # 790213 00 0 00 1000 or # 791237 00 0 00 1000 / No overflow hole, but overflow channel / Tub only available with foldable relaxing deck

Sundeck Design by E00S

Bathtub rectangle, with support frame for panel, with one backrest slope, incl. fixation for foldable relaxing deck
5 mm sanitary acrylic

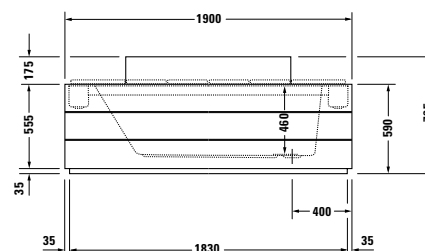
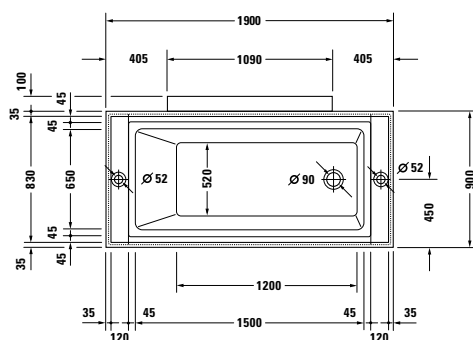

Length mm	Width mm	Depth mm	Capacity l	Weight kg	Model-No.	Euro
						White - 00
Bathtub						
1855	855	460	315	58,0	700127 00 0 00 0000	
Surcharge for whirlsystem						
Air-System					760*** 00 1 00 1000	
Jet-System					760*** 00 2 00 1000	
Combi-System P					760*** 00 3 00 1000	
Combi-System E					760*** 00 4 16 1000	
Combi-System L					710*** 00 5 00 1000	
Additional modules for whirltub						
Additional modules for Combi-System E				Module-No.		
LED coloured light (replaces LED white light)				06		
Heating				07		
UV Hygiene Management				08		
Additional modules for Combi-System L				Module-No.		
LED coloured light (replaces white light)				06		
Temperature L				07		
UV Hygiene Management				08		
Necessary accessories for bath- and whirltub						
Foldable relaxing deck, cushioned, white, for # 700065, 700066, 700125, 700127					790831 00 0 00 0000	
Suitable panels s.p. 424						
Necessary accessories for bathtub						
Waste and overflow, with push-open valve, chrome					790213 00 0 00 1000	
Waste and overflow, with base inlet, chrome *					791237 00 0 00 1000	
Accessories for bath- and whirltub						
Step, cushioned, white					790832 00 0 00 0000	
Bolster, white					790002 00 0 00 0000	
Persenning, for freestanding version, for panel with short pillar, blue, for # 700066, 700127					790843 00 0 00 0000	
Accessories for bathtub						
LED coloured light, with remote control for bathtubs, (white -00, chrome -10)					790840 00 0 00 * 00	
Sound					791851 00 0 00 0000	
Accessories for whirltub						
Surcharge, for waste and overflow, with base inlet, chrome *					791238 00 0 00 1000	
LED coloured light, for whirltubs with Air-System, Jet-System, Combi-System P, Durapearl-System or Jet Project					791850 00 0 00 1000	
Sound, for whirltubs with Air-System, Jet-System, Combi-System P, Durapearl-System or Jet Project					791852 00 0 00 0000	
Sound, for whirltubs with Combi-System E					791853 00 0 00 0000	

Infobox: * assembled, pipe interrupt mandatory / No overflow hole, but overflow channel / Tub only available with foldable relaxing deck / Please order either # 790213 00 0 00 1000 or # 791237 00 0 00 1000

Sundeck Design by E00S

Bathtub rectangle, with support frame for panel, with one backrest slope, incl. fixation for foldable relaxing deck
5 mm sanitary acrylic

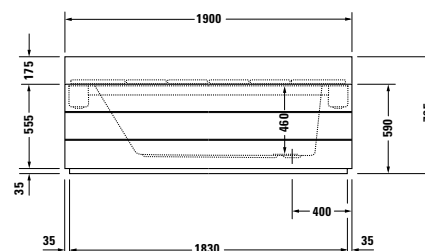
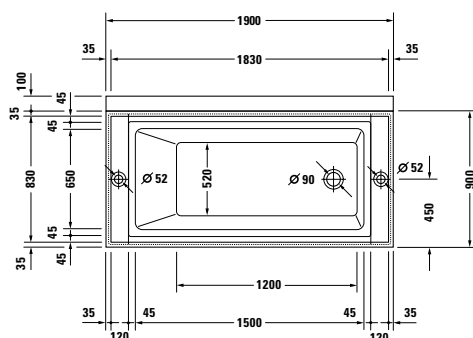

Length mm	Width mm	Depth mm	Capacity l	Weight kg	Model-No.	Euro
						White - 00
Bathtub						
1855	855	460	315	58,0	700127 00 0 00 0000	
Surcharge for whirlsystem						
Air-System					760*** 00 1 00 1000	
Jet-System					760*** 00 2 00 1000	
Combi-System P					760*** 00 3 00 1000	
Combi-System E					760*** 00 4 16 1000	
Combi-System L					710*** 00 5 00 1000	
Additional modules for whirltub						
Additional modules for Combi-System E				Module-No.		
LED coloured light (replaces LED white light)				06		
Heating				07		
UV Hygiene Management				08		
Additional modules for Combi-System L				Module-No.		
LED coloured light (replaces white light)				06		
Temperature L				07		
UV Hygiene Management				08		
Necessary accessories for bath- and whirltub						
Foldable relaxing deck, cushioned, white, for # 700065, 700066, 700125, 700127					790831 00 0 00 0000	
Suitable panels s.p. 424						
Necessary accessories for bathtub						
Waste and overflow, with push-open valve, chrome					790213 00 0 00 1000	
Waste and overflow, with base inlet, chrome *					791237 00 0 00 1000	
Accessories for bath- and whirltub						
Step, cushioned, white					790832 00 0 00 0000	
Bolster, white					790002 00 0 00 0000	
Persenning, for freestanding version, for panel with long pillar, blue, for # 700066, 700127					790844 00 0 00 0000	
Accessories for bathtub						
LED coloured light, with remote control for bathtubs, (white -00, chrome -10)					790840 00 0 00 * 00	
Sound					791851 00 0 00 0000	
Accessories for whirltub						
Surcharge, for waste and overflow, with base inlet, chrome *					791238 00 0 00 1000	
LED coloured light, for whirltubs with Air-System, Jet-System, Combi-System P, Durapearl-System or Jet Project					791850 00 0 00 1000	
Sound, for whirltubs with Air-System, Jet-System, Combi-System P, Durapearl-System or Jet Project					791852 00 0 00 0000	
Sound, for whirltubs with Combi-System E					791853 00 0 00 0000	

Infobox: * assembled, pipe interrupt mandatory / No overflow hole, but overflow channel / Tub only available with foldable relaxing deck / Please order either # 790213 00 0 00 1000 or # 791237 00 0 00 1000

Sundeck Design by E00S



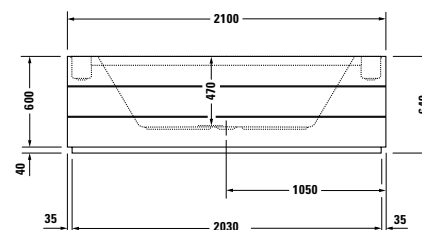
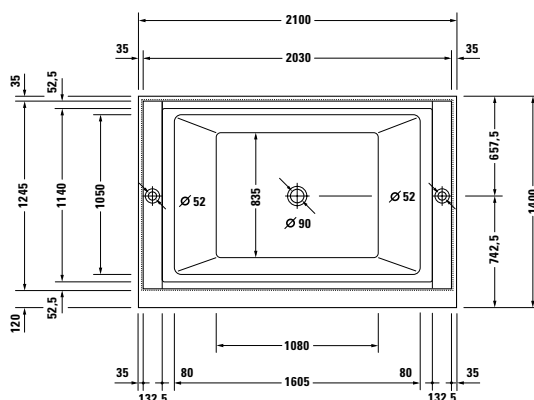





Bathtub rectangle, with support frame for panel, with two backrest slopes, incl. fixation for foldable relaxing deck
5 mm sanitary acrylic



Length mm	Width mm	Depth mm	Capacity l	Weight kg	Model-No.	Euro
						White - 00
Bathtub						
2055	1270	470	493	80,0	700197 00 0 00 0000	
Necessary accessories for bathtub						
Waste and overflow, with push-open valve, chrome					790213 00 0 00 1000	
Waste and overflow, with base inlet, chrome *					791237 00 0 00 1000	
Foldable relaxing deck, cushioned, white					790875 00 0 00 0000	
Suitable panels s.p. 424						
Accessories for bathtub						
Step, cushioned, white					790832 00 0 00 0000	
Bolster, white					790002 00 0 00 0000	
LED coloured light, with remote control for bathtubs, (white -00, chrome -10)					790840 00 0 00 * 00	
Sound					791851 00 0 00 0000	
Persenning, for freestanding version, for panel without pillar, blue					790876 00 0 00 0000	
Persenning, for corner left, for panel without pillar, blue					791811 00 0 00 0000	
Persenning, for corner right, for panel without pillar, blue					791812 00 0 00 0000	
Persenning, for back-to-wall version, for panel without pillar, blue					791813 00 0 00 0000	

Infobox: * assembled, pipe interrupt mandatory / No overflow hole, but overflow channel / Tub only available with foldable relaxing deck / Please order either # 790213 00 0 00 1000 or # 791237 00 0 00 1000

Sundeck Accessories Design by E00S

	Description	Model-No.	Euro
	Waste and overflow with push-open valve, chrome, for Sundeck outlet diameter 90 mm	790213 00 0 00 1000	
	Waste and overflow * with base inlet, chrome for Sundeck outlet diameter 90 mm	791237 00 0 00 1000	
Infobox: * assembled, pipe interrupt mandatory			
	Surcharge * for waste and overflow, with base inlet, chrome outlet diameter 90 mm for whirltubs with panel for whirltubs with rail-mount system	791238 00 0 00 1000	791239 00 0 00 1000
Infobox: * assembled, pipe interrupt mandatory			
	Rail-mount system ** for built-in version, for Sundeck bath- and whirltubs for # 700065 for # 700125 for # 700126	790153 00 0 00 0000	790156 00 0 00 0000
790154 00 0 00 0000			
Infobox: ** When ordering rail-mount system and tap module please refer to page 404			
	Tap module ** for rail-mount system	790155 00 0 00 0000	
Infobox: ** When ordering rail-mount system and tap module please refer to page 404			
	Bolster white for Sundeck	790002 00 0 00 0000	
	Step cushioned, white for Sundeck	790832 00 0 00 0000	
	Foldable relaxing deck cushioned, white for # 700065, 700066, 700125, 700127 for # 700126, 700128 for # 700196, 700197, 710358, 710359	790831 00 0 00 0000	790848 00 0 00 0000
790875 00 0 00 0000			

Sundeck Accessories Design by E00S

	Description	Model-No.	Euro
	Persenning for freestanding version, for panel without pillar, blue		
	for # 700066, 700127	790842 00 0 00 0000	
	for # 700128	790859 00 0 00 0000	
	Persenning for freestanding version, for panel with short pillar, blue		
	for # 700066, 700127	790843 00 0 00 0000	
	for # 700128	790860 00 0 00 0000	
	Persenning for freestanding version, for panel with long pillar, blue		
	for # 700066, 700127	790844 00 0 00 0000	
	for # 700128	790861 00 0 00 0000	
	Persenning for panel without pillar, for # 700197, blue		
	for freestanding version	790876 00 0 00 0000	
	for corner left	791811 00 0 00 0000	
	for corner right	791812 00 0 00 0000	
	for back-to-wall version	791813 00 0 00 0000	

Sundeck Design by E00S

Panels for bath- and whirltubs

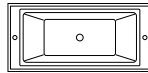

1855 x 855 mm



700066

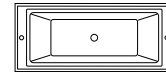

2055 x 855 mm



700128

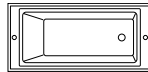

1855 x 855 mm



700127

Model-No. panel		Indoor	Outdoor	Indoor	Outdoor
	Corner L/R, Back-to-wall	# SU 8837*		# SU 8660*	
	Freestanding	# SU 8840*	# SU 8845*	# SU 8650*	# SU 8655*
	Corner L/R, Back-to-wall, with long pillar	# SU 8855		# SU 8666	
	Freestanding with long pillar	# SU 8844	# SU 8849*	# SU 8654	# SU 8659*
	Freestanding with short pillar	# SU 8842	# SU 8847*	# SU 8652	# SU 8657*

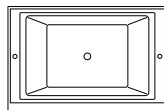

2055 x 1270 mm



700197

		Indoor	Outdoor
	Corner L/R, Back-to-wall	# SU 8669	# SU 8674
	Freestanding	# SU 8670	# SU 8675

* These panels are not suitable for bathtubs with whirlsystems

Sundeck Design by E00S

Product Information

Panel Pillar	Decor (Pricegroup 1)	53 Chestnut Dark	Compact laminated panel, with laminate (HPL) pressed on one side. Surfaces resistant to moisture.
	Real wood veneer (Pricegroup 2)	13 American Walnut 24 Macassar	Compact laminated panel, with real wood veneer pressed on one side. Real wood veneer is a natural material, differences in colour and structure may occur. Surfaces resistant to moisture.
	Real wood veneer (Pricegroup 3)	62 Anthracite Oak	Compact laminated panel, with real wood veneer pressed on one side. Real wood veneer is a natural material, differences in colour and structure may occur. Surfaces resistant to moisture.
	Decor Outdoor Version (Pricegroup 4)	01 Cherry Tree 02 Wengé	Compact laminated panel, with laminate (HPL) pressed on one side. This HPL is developed for outdoor use. It is resistant to UV-radiation and has an overall weatherability.
Folding Relaxing Deck Step (cushioned) Bolster		00 White	Base board, sheathed in foamed plastic material and covered with marine-quality protective padding.

Sundeck Design by E00S

Description	mm	Model-No.	Euro			
			Pricegroup 1	Pricegroup 2	Pricegroup 3	Pricegroup 4
Panel for corner left / right, back-to-wall version, without pillar for # 700066 (1855 x 855 mm), for # 700127 (1855 x 855 mm)	1900 x 900	SU 8837				
Infobox: These panels are not suitable for bathtubs with whirlsystem						
Panel for freestanding version, without pillar for # 700066 (1855 x 855 mm), for # 700127 (1855 x 855 mm)	1900 x 900	SU 8840				
Infobox: These panels are not suitable for bathtubs with whirlsystem						
Panel for freestanding version, without pillar, outdoor for # 700066 (1855 x 855 mm), for # 700127 (1855 x 855 mm)	1900 x 900	SU 8845				
Infobox: Panels of price group 4 are suitable for outdoor use / These panels are not suitable for bathtubs with whirlsystem						
Panel for corner left / right, back-to-wall version, with long pillar for # 700066 (1855 x 855 mm), for # 700127 (1855 x 855 mm)	1900 x 1000	SU 8855				
Infobox: 280 € surcharge for panel in combination with whirlsystem						
Panel for freestanding version, with long pillar for # 700066 (1855 x 855 mm), for # 700127 (1855 x 855 mm)	1900 x 1000	SU 8844				
Infobox: 280 € surcharge for panel in combination with whirlsystem						
Panel for freestanding version, with long pillar, outdoor for # 700066 (1855 x 855 mm), for # 700127 (1855 x 855 mm)	1900 x 1000	SU 8849				
Infobox: Panels of price group 4 are suitable for outdoor use / These panels are not suitable for bathtubs with whirlsystem						

Sundeck Design by E00S

Description	mm	Model-No.	Euro			
			Pricegroup 1	Pricegroup 2	Pricegroup 3	Pricegroup 4
Panel						
for freestanding version, with short pillar						
for # 700066 (1855 x 855 mm), for # 700127 (1855 x 855 mm)	1900 x 1000	SU 8842				
Infobox: 280 € surcharge for panel in combination with whirlsystem						
Panel						
for freestanding version, with short pillar, outdoor						
for # 700066 (1855 x 855 mm), for # 700127 (1855 x 855 mm)	1900 x 1000	SU 8847				
Infobox: Panels of price group 4 are suitable for outdoor use / These panels are not suitable for bathtubs with whirlsystem						
Panel						
for corner left / right, back-to-wall version, without pillar						
for # 700128 (2055 x 855 mm)	2100 x 900	SU 8660				
Infobox: These panels are not suitable for bathtubs with whirlsystem						
Panel						
for freestanding version, without pillar						
for # 700128 (2055 x 855 mm)	2100 x 900	SU 8650				
Infobox: These panels are not suitable for bathtubs with whirlsystem						
Panel						
for freestanding version, without pillar, outdoor						
for # 700128 (2055 x 855 mm)	2100 x 900	SU 8655				
Infobox: Panels of price group 4 are suitable for outdoor use / These panels are not suitable for bathtubs with whirlsystem						
Panel						
for corner left / right, back-to-wall version, with long pillar						
for # 700128 (2055 x 855 mm)	2100 x 1000	SU 8666				
Infobox: 280 € surcharge for panel in combination with whirlsystem						
Panel						
for freestanding version, with long pillar						
for # 700128 (2055 x 855 mm)	2100 x 1000	SU 8654				
Infobox: 280 € surcharge for panel in combination with whirlsystem						

Sundeck Design by E00S

Description	mm	Model-No.	Euro			
			Pricegroup 1	Pricegroup 2	Pricegroup 3	Pricegroup 4
Panel for freestanding version, with long pillar, outdoor						
for # 700128 (2055 x 855 mm)	2100 x 1000	SU 8659				
Infobox: Panels of price group 4 are suitable for outdoor use / These panels are not suitable for bathtubs with whirlsystem						
Panel for freestanding version, with short pillar						
for # 700128 (2055 x 855 mm)	2100 x 1000	SU 8652				
Infobox: 280 € surcharge for panel in combination with whirlsystem						
Panel for freestanding version, with short pillar, outdoor						
for # 700128 (2055 x 855 mm)	2100 x 1000	SU 8657				
Infobox: Panels of price group 4 are suitable for outdoor use / These panels are not suitable for bathtubs with whirlsystem						
Panel for corner left / right, back-to-wall version, without pillar						
for # 700197 (2055 x 1270 mm)	2100 x 1400	SU 8669				
Panel for freestanding version, without pillar						
for # 700197 (2055 x 1270 mm)	2100 x 1400	SU 8670				
Panel for corner left / right, back-to-wall version, without pillar, outdoor						
for # 700197 (2055 x 1270 mm)	2100 x 1400	SU 8674				
Panel for freestanding version, without pillar, outdoor						
for # 700197 (2055 x 1270 mm)	2100 x 1400	SU 8675				

Vero Design by Duravit

Bathtub rectangle, built-in or for panel, with one backrest slope left
5 mm sanitary acrylic

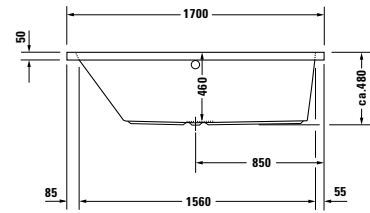
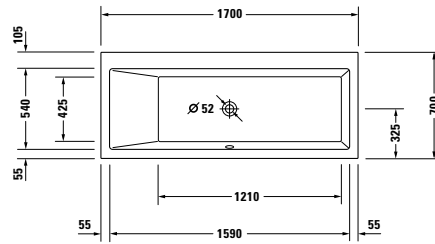

Length mm	Width mm	Depth mm	Capacity l	Weight kg	Model-No.	Euro
						White - 00
Bathtub						
1700	700	460	145	28,0	700131 00 0 00 0000	
Accessories for bathtub						
Support frame, for bathtubs and shower trays, with length > 1000 mm					790100 00 0 00 0000	
Bathtub anchors					790103 00 0 00 0000	
Rubber profile					790104 00 0 00 0000	
Waste and overflow Quadroval, chrome					790289 00 0 00 1000	
Waste and overflow Quadroval, with water inlet, chrome					790290 00 0 00 1000	
Support, for # 700131					790489 00 0 00 0000	
Surcharge, for drillings of the tub rim for faucet, (not possible for whirltub)					790650 00 0 00 0000	
LED coloured light, with remote control for bathtubs, (white -00, chrome -10)					790840 00 0 00 * *00	
Sound					791851 00 0 00 0000	
Suitable panels s.p. 435						

Infobox: LED coloured light or sound is not suitable for bathtubs with support

Vero Design by Duravit

Bathtub rectangle, built-in or for panel, with one backrest slope right
5 mm sanitary acrylic

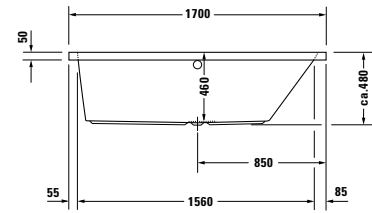
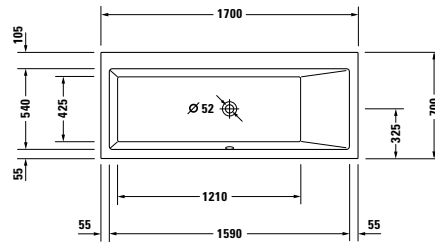

Length mm	Width mm	Depth mm	Capacity l	Weight kg	Model-No.	Euro
						White - 00
Bathtub						
1700	700	460	145	28,0	700132 00 0 00 0000	
Accessories for bathtub						
Support frame, for bathtubs and shower trays, with length > 1000 mm					790100 00 0 00 0000	
Bathtub anchors					790103 00 0 00 0000	
Rubber profile					790104 00 0 00 0000	
Waste and overflow Quadroval, chrome					790289 00 0 00 1000	
Waste and overflow Quadroval, with water inlet, chrome					790290 00 0 00 1000	
Support, for # 700132					790490 00 0 00 0000	
Surcharge, for drillings of the tub rim for faucet, (not possible for whirltub)					790650 00 0 00 0000	
LED coloured light, with remote control for bathtubs, (white -00, chrome -10)					790840 00 0 00 * *00	
Sound					791851 00 0 00 0000	
Suitable panels s.p. 435						

Infobox: LED coloured light or sound is not suitable for bathtubs with support

Vero Design by Duravit

Bathtub rectangle, built-in or for panel, with one backrest slope left

5 mm sanitary acrylic

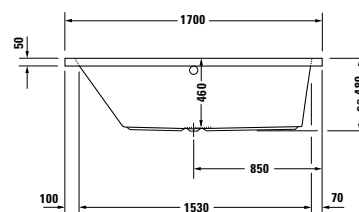
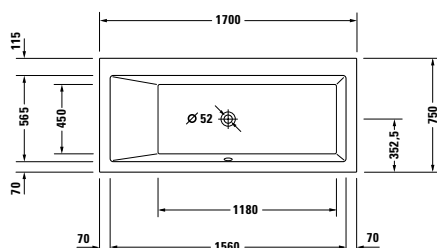

Length mm	Width mm	Depth mm	Capacity l	Weight kg	Model-No.	Euro
						White - 00
Bathtub						
1700	750	460	160	30,0	700133 00 0 00 0000	
Surcharge for whirlsystem						
Air-System					760*** 00 1 00 1000	
Jet-System					760*** 00 2 00 1000	
Combi-System P					760*** 00 3 00 1000	
Combi-System E					760*** 00 4 16 1000	
Combi-System L					710*** 00 5 00 1000	
Additional modules for whirltub						
Additional modules for Combi-System E				Module-No.		
LED coloured light (replaces LED white light)				06		
Heating				07		
UV Hygiene Management				08		
Additional modules for Combi-System L				Module-No.		
LED coloured light (replaces white light)				06		
Temperature L				07		
UV Hygiene Management				08		
Accessories for bath- and whirltub						
Bathtub anchors					790103 00 0 00 0000	
Rubber profile					790104 00 0 00 0000	
Suitable panels s.p. 435						
Accessories for bathtub						
Support frame, for bathtubs and shower trays, with length > 1000 mm					790100 00 0 00 0000	
Waste and overflow Quadroval, chrome					790289 00 0 00 1000	
Waste and overflow Quadroval, with water inlet, chrome					790290 00 0 00 1000	
Support, for # 700133					790491 00 0 00 0000	
Surcharge, for drillings of the tub rim for faucet, (not possible for whirltub)					790650 00 0 00 0000	
LED coloured light, with remote control for bathtubs, (white -00, chrome -10)					790840 00 0 00 *00	
Sound					791851 00 0 00 0000	
Suitable tub covers s.p. 510/511						
Accessories for whirltub						
Surcharge, for waste and overflow Quadroval, with water inlet, chrome					791206 00 0 00 1000	
LED coloured light, for whirltubs with Air-System, Jet-System, Combi-System P, Durapearl-System or Jet Project					791850 00 0 00 1000	
Sound, for whirltubs with Air-System, Jet-System, Combi-System P, Durapearl-System or Jet Project					791852 00 0 00 0000	
Sound, for whirltubs with Combi-System E					791853 00 0 00 0000	

Infobox: LED coloured light or sound is not suitable for bathtubs with support

Vero Design by Duravit

Bathtub rectangle, built-in or for panel, with one backrest slope right
5 mm sanitary acrylic

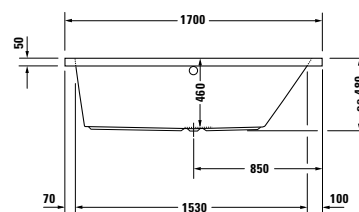
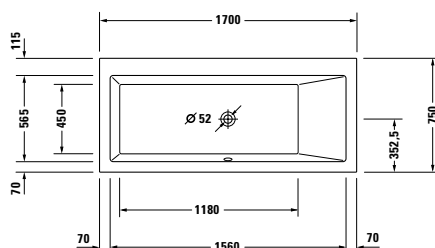

Length mm	Width mm	Depth mm	Capacity l	Weight kg	Model-No.	Euro
						White - 00
Bathtub						
1700	750	460	160	30,0	700134 00 0 00 0000	
Surcharge for whirlsystem						
Air-System					760*** 00 1 00 1000	
Jet-System					760*** 00 2 00 1000	
Combi-System P					760*** 00 3 00 1000	
Combi-System E					760*** 00 4 16 1000	
Combi-System L					710*** 00 5 00 1000	
Additional modules for whirltub						
Additional modules for Combi-System E				Module-No.		
LED coloured light (replaces LED white light)				06		
Heating				07		
UV Hygiene Management				08		
Additional modules for Combi-System L				Module-No.		
LED coloured light (replaces white light)				06		
Temperature L				07		
UV Hygiene Management				08		
Accessories for bath- and whirltub						
Bathtub anchors					790103 00 0 00 0000	
Rubber profile					790104 00 0 00 0000	
Suitable panels s.p. 435						
Accessories for bathtub						
Support frame, for bathtubs and shower trays, with length > 1000 mm					790100 00 0 00 0000	
Waste and overflow Quadroval, chrome					790289 00 0 00 1000	
Waste and overflow Quadroval, with water inlet, chrome					790290 00 0 00 1000	
Support, for # 700134					790492 00 0 00 0000	
Surcharge, for drillings of the tub rim for faucet, (not possible for whirltub)					790650 00 0 00 0000	
LED coloured light, with remote control for bathtubs, (white -00, chrome -10)					790840 00 0 00 * 00	
Sound					791851 00 0 00 0000	
Suitable tub covers s.p. 510/511						
Accessories for whirltub						
Surcharge, for waste and overflow Quadroval, with water inlet, chrome					791206 00 0 00 1000	
LED coloured light, for whirltubs with Air-System, Jet-System, Combi-System P, Durapearl-System or Jet Project					791850 00 0 00 1000	
Sound, for whirltubs with Air-System, Jet-System, Combi-System P, Durapearl-System or Jet Project					791852 00 0 00 0000	
Sound, for whirltubs with Combi-System E					791853 00 0 00 0000	

Infobox: LED coloured light or sound is not suitable for bathtubs with support

Vero Design by Duravit

Bathtub rectangle, built-in or for panel, with two backrest slopes

5 mm sanitary acrylic

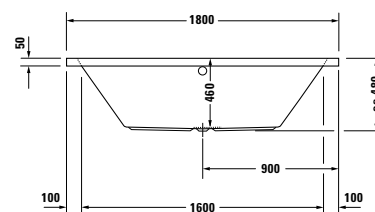
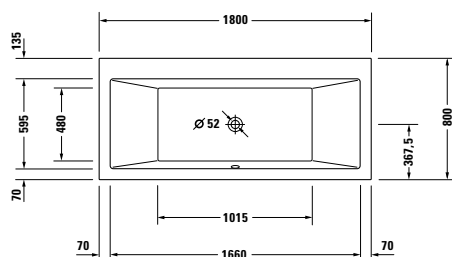

Length mm	Width mm	Depth mm	Capacity l	Weight kg	Model-No.	Euro
						White - 00
Bathtub						
1800	800	460	165	38,0	700135 00 0 00 0000	
Surcharge for whirlsystem						
Air-System					760*** 00 1 00 1000	
Jet-System					760*** 00 2 00 1000	
Combi-System P					760*** 00 3 00 1000	
Combi-System E					760*** 00 4 16 1000	
Combi-System L					710*** 00 5 00 1000	
Additional modules for whirltub						
Additional modules for Combi-System E				Module-No.		
LED coloured light (replaces LED white light)				06		
Heating				07		
UV Hygiene Management				08		
Additional modules for Combi-System L				Module-No.		
LED coloured light (replaces white light)				06		
Temperature L				07		
UV Hygiene Management				08		
Accessories for bath- and whirltub						
Bathtub anchors					790103 00 0 00 0000	
Rubber profile					790104 00 0 00 0000	
Suitable panels s.p. 435						
Accessories for bathtub						
Support frame, for bathtubs and shower trays, with length > 1000 mm					790100 00 0 00 0000	
Waste and overflow Quadroval, chrome					790289 00 0 00 1000	
Waste and overflow Quadroval, with water inlet, chrome					790290 00 0 00 1000	
Waste and overflow, with base inlet, chrome *					791226 00 0 00 1000	
Support, for # 700135					790493 00 0 00 0000	
Surcharge, for drillings of the tub rim for faucet, (not possible for whirltub)					790650 00 0 00 0000	
LED coloured light, with remote control for bathtubs, (white -00, chrome -10)					790840 00 0 00 * *00	
Sound					791851 00 0 00 0000	
Suitable tub covers s.p. 510/511						
Accessories for whirltub						
Surcharge, for waste and overflow Quadroval, with water inlet, chrome					791206 00 0 00 1000	
Surcharge, for waste and overflow, with base inlet, chrome *					791227 00 0 00 1000	
LED coloured light, for whirltubs with Air-System, Jet-System, Combi-System P, Durapearl-System or Jet Project					791850 00 0 00 1000	
Sound, for whirltubs with Air-System, Jet-System, Combi-System P, Durapearl-System or Jet Project					791852 00 0 00 0000	
Sound, for whirltubs with Combi-System E					791853 00 0 00 0000	

Infobox: * pipe interrupt mandatory / LED coloured light or sound is not suitable for bathtubs with support

Vero Design by Duravit

Bathtub rectangle, built-in or for panel, with two backrest slopes

5 mm sanitary acrylic

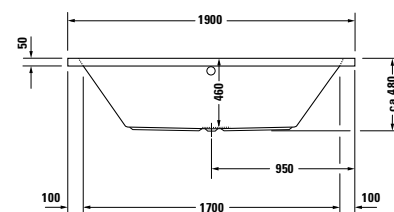
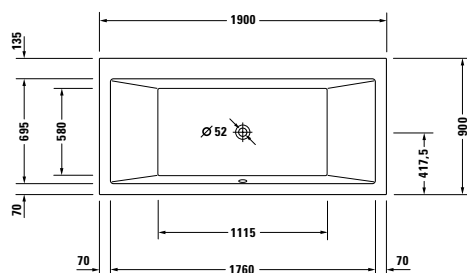

Length mm	Width mm	Depth mm	Capacity l	Weight kg	Model-No.	Euro
						White - 00
Bathtub						
1900	900	460	225	43,0	700136 00 0 00 0000	
Surcharge for whirlsystem						
Air-System					760*** 00 1 00 1000	
Jet-System					760*** 00 2 00 1000	
Combi-System P					760*** 00 3 00 1000	
Combi-System E					760*** 00 4 16 1000	
Combi-System L					710*** 00 5 00 1000	
Additional modules for whirltub						
Additional modules for Combi-System E				Module-No.		
LED coloured light (replaces LED white light)				06		
Heating				07		
UV Hygiene Management				08		
Additional modules for Combi-System L				Module-No.		
LED coloured light (replaces white light)				06		
Temperature L				07		
UV Hygiene Management				08		
Accessories for bath- and whirltub						
Bathtub anchors					790103 00 0 00 0000	
Rubber profile					790104 00 0 00 0000	
Suitable panels s.p. 435						
Accessories for bathtub						
Support frame, for bathtubs and shower trays, with length > 1000 mm					790100 00 0 00 0000	
Waste and overflow Quadroval, chrome					790293 00 0 00 1000	
Waste and overflow Quadroval, with water inlet, chrome					790294 00 0 00 1000	
Waste and overflow, with base inlet, chrome *					791226 00 0 00 1000	
Support, for # 700136					790494 00 0 00 0000	
Surcharge, for drillings of the tub rim for faucet, (not possible for whirltub)					790650 00 0 00 0000	
LED coloured light, with remote control for bathtubs, (white -00, chrome -10)					790840 00 0 00 * 00	
Sound					791851 00 0 00 0000	
Accessories for whirltub						
Surcharge, for waste and overflow Quadroval, with water inlet, chrome					791206 00 0 00 1000	
Surcharge, for waste and overflow, with base inlet, chrome *					791227 00 0 00 1000	
LED coloured light, for whirltubs with Air-System, Jet-System, Combi-System P, Durapearl-System or Jet Project					791850 00 0 00 1000	
Sound, for whirltubs with Air-System, Jet-System, Combi-System P, Durapearl-System or Jet Project					791852 00 0 00 0000	
Sound, for whirltubs with Combi-System E					791853 00 0 00 0000	

Infobox: * pipe interrupt mandatory / LED coloured light or sound is not suitable for bathtubs with support

Vero Design by Duravit

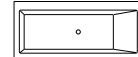
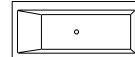
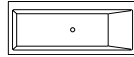
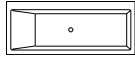
Panels for bath- and whirtubs

1700 x 700 mm

1700 x 700 mm

1700 x 750 mm

1700 x 750 mm

700131
700132
700133
700134
Model-No. panel

Corner left

VE 8786
VE 8786
VE 8787
VE 8787



Corner right

VE 8781
VE 8781
VE 8782
VE 8782

Back-to-wall

VE 8776
VE 8776
VE 8777
VE 8777

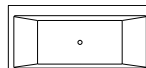
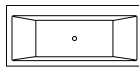
Niche

VE 8938
VE 8938
VE 8938
VE 8938

1800 x 800 mm

1900 x 900 mm

700135
700136

Corner left

VE 8788
VE 8906

Corner right

VE 8783
VE 8904

Back-to-wall

VE 8778
VE 8902

Niche

VE 8939
VE 8941

A support frame is required for the installation of the panel. The support frame must be ordered separately

Vero Design by Duravit

Product Information

Panel	Decor (Pricegroup 1)	43 Basalt Matt 49 Graphite Matt 50 Garnet Red Matt 53 Chestnut Dark 79 Natural Walnut	High-density-fiberboard, with laminate (HPL) pressed on both sides. Surfaces resistant to moisture.
	Acryl (Pricegroup 1)	82 Acrylic White	8 mm Acryl solid-coloured in white
	Real wood veneer (Pricegroup 2)	13 American Walnut 24 Macassar 26 American Cherry Tree 65 Bleached Oak	High-density-fiberboard, with real wood veneer pressed on one side and laminate (HPL) pressed on other side. Real wood veneer is a natural material, differences in colour and structure may occur. Surfaces resistant to moisture.
	Real wood veneer (Pricegroup 3)	05 Oak 12 Brushed Oak 62 Anthracite Oak 69 Brushed Walnut	High-density-fiberboard, with real wood veneer pressed on one side and laminate (HPL) pressed on other side. Real wood veneer is a natural material, differences in colour and structure may occur. Surfaces resistant to moisture.

Vero Design by Duravit

Description	mm	Model-No.	Euro		
			Pricegroup 1	Pricegroup 2	Pricegroup 3
Panel					
for corner left					
for # 700131 (1700 x 700 mm)	1690 x 690	VE 8786			
for # 700132 (1700 x 700 mm)	1690 x 690	VE 8786			
for # 700133 (1700 x 750 mm)	1690 x 740	VE 8787			
for # 700134 (1700 x 750 mm)	1690 x 740	VE 8787			
for # 700135 (1800 x 800 mm)	1790 x 790	VE 8788			
for # 700136 (1900 x 900 mm)	1890 x 890	VE 8906			
Infobox: A support frame is required for the installation of the panel. The support frame must be ordered separately / Heights of Vero series: Height bathtub panel = 555 mm, Height bathtub panel incl. shadow gap = 565 mm, overall height incl. 50 mm bathtub trim Vero = 615 mm					
Panel					
for corner right					
for # 700131 (1700 x 700 mm)	1690 x 690	VE 8781			
for # 700132 (1700 x 700 mm)	1690 x 690	VE 8781			
for # 700133 (1700 x 750 mm)	1690 x 740	VE 8782			
for # 700134 (1700 x 750 mm)	1690 x 740	VE 8782			
for # 700135 (1800 x 800 mm)	1790 x 790	VE 8783			
for # 700136 (1900 x 900 mm)	1890 x 890	VE 8904			
Infobox: A support frame is required for the installation of the panel. The support frame must be ordered separately / Heights of Vero series: Height bathtub panel = 555 mm, Height bathtub panel incl. shadow gap = 565 mm, overall height incl. 50 mm bathtub trim Vero = 615 mm					
Panel					
for back-to-wall version					
for # 700131 (1700 x 700 mm)	1680 x 690	VE 8776			
for # 700132 (1700 x 700 mm)	1680 x 690	VE 8776			
for # 700133 (1700 x 750 mm)	1680 x 740	VE 8777			
for # 700134 (1700 x 750 mm)	1680 x 740	VE 8777			
for # 700135 (1800 x 800 mm)	1780 x 790	VE 8778			
for # 700136 (1900 x 900 mm)	1880 x 890	VE 8902			
Infobox: A support frame is required for the installation of the panel. The support frame must be ordered separately / Heights of Vero series: Height bathtub panel = 555 mm, Height bathtub panel incl. shadow gap = 565 mm, overall height incl. 50 mm bathtub trim Vero = 615 mm					
Panel					
for niche					
for # 700131 (1700 x 700 mm)	B: 1690	VE 8938			
for # 700132 (1700 x 700 mm)	B: 1690	VE 8938			
for # 700133 (1700 x 750 mm)	B: 1690	VE 8938			
for # 700134 (1700 x 750 mm)	B: 1690	VE 8938			
for # 700135 (1800 x 800 mm)	B: 1790	VE 8939			
for # 700136 (1900 x 900 mm)	B: 1890	VE 8941			
Infobox: A support frame is required for the installation of the panel. The support frame must be ordered separately / Heights of Vero series: Height bathtub panel = 555 mm, Height bathtub panel incl. shadow gap = 565 mm, overall height incl. 50 mm bathtub trim Vero = 615 mm					

D-Code Design by sieger design

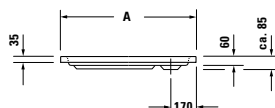
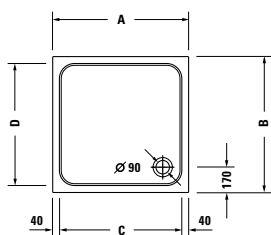
Shower tray square
 3,2 mm sanitary acrylic

	A	B	C	D
720101	800	800	720	720
720102	900	900	820	820
720103	1000	1000	920	920

Length mm	Width mm	Height mm	Weight kg	Model-No.	Euro	
					White	- 00
800	800	85	11,0	720101 00 0 00 0000		
900	900	85	13,5	720102 00 0 00 0000		
1000	1000	85	16,5	720103 00 0 00 0000		
with Antislip						
800	800	85	11,0	720101 00 0 00 0001		
900	900	85	13,5	720102 00 0 00 0001		
1000	1000	85	16,5	720103 00 0 00 0001		
Accessories for shower tray						
Bathtub anchors				790125 00 0 00 0000		
Rubber profile				790126 00 0 00 0000		
Support frame for shower trays, for shower trays, with length ≤ 1000 mm				790129 00 0 00 0000		
Outlet drain, chrome				791217 00 0 00 1000		
Support, for # 720101				790478 00 0 00 0000		
Support, for # 720102				790479 00 0 00 0000		
Support, for # 720103				790480 00 0 00 0000		

D-Code Design by sieger design

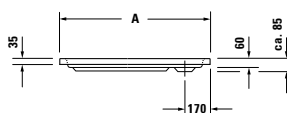
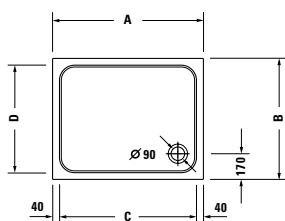
Shower tray rectangle
 3,2 mm sanitary acrylic

	A	B	C	D
720104	900	750	820	670
720105	900	800	820	720
720106	1000	800	920	720
720107	1000	900	920	820

Length mm	Width mm	Height mm	Weight kg	Model-No.	Euro	
					White	- 00
900	750	85	12,0	720104 00 0 00 0000		
900	800	85	12,5	720105 00 0 00 0000		
1000	800	85	13,5	720106 00 0 00 0000		
1000	900	85	14,5	720107 00 0 00 0000		
with Antislip						
900	750	85	12,0	720104 00 0 00 0001		
900	800	85	12,5	720105 00 0 00 0001		
1000	800	85	13,5	720106 00 0 00 0001		
1000	900	85	14,5	720107 00 0 00 0001		
Accessories for shower tray						
Bathtub anchors				790125 00 0 00 0000		
Rubber profile				790126 00 0 00 0000		
Support frame for shower trays, for shower trays, with length ≤ 1000 mm				790129 00 0 00 0000		
Outlet drain, chrome				791217 00 0 00 1000		
Support, for # 720104				790481 00 0 00 0000		
Support, for # 720105				790482 00 0 00 0000		
Support, for # 720106				790483 00 0 00 0000		
Support, for # 720107				790484 00 0 00 0000		

D-Code Design by sieger design

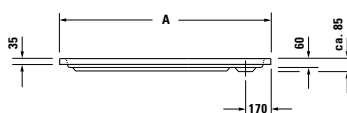
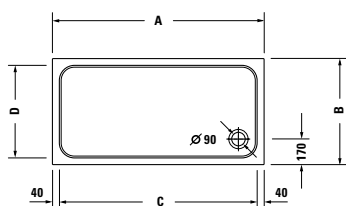
Shower tray rectangle
 3,2 mm sanitary acrylic

	A	B	C	D
720093	1000	700	920	620
720094	1200	700	1120	620
720113	1200	800	1120	720
720095	1400	700	1320	620
720096	1700	700	1620	620

Length mm	Width mm	Height mm	Weight kg	Model-No.	Euro	
					White	- 00
1000	700	85	14,0	720093 00 0 00 0000		
1200	700	85	16,0	720094 00 0 00 0000		
1200	800	85	20,5	720113 00 0 00 0000		
1400	700	85	19,0	720095 00 0 00 0000		
1700	700	85	27,5	720096 00 0 00 0000		
with Antislip						
1000	700	85	14,0	720093 00 0 00 0001		
1200	700	85	16,0	720094 00 0 00 0001		
1200	800	85	20,5	720113 00 0 00 0001		
1400	700	85	19,0	720095 00 0 00 0001		
1700	700	85	27,5	720096 00 0 00 0001		
Accessories for shower tray						
Bathtub anchors				790125 00 0 00 0000		
Rubber profile				790126 00 0 00 0000		
Support frame for shower trays, for shower trays, with length ≤ 1000 mm				790129 00 0 00 0000		
Support frame, for bathtubs and shower trays, with length > 1000 mm				790127 00 0 00 0000		
Support frame, for shower trays, with length > 1500 mm				790158 00 0 00 0000		
Outlet drain, chrome				791217 00 0 00 1000		
Support, for # 720093				791451 00 0 00 0000		
Support, for # 720094				791452 00 0 00 0000		
Support, for # 720113				791459 00 0 00 0000		
Support, for # 720095				791453 00 0 00 0000		
Support, for # 720096				791454 00 0 00 0000		

D-Code Design by sieger design

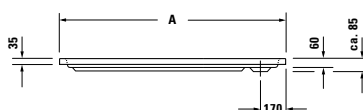
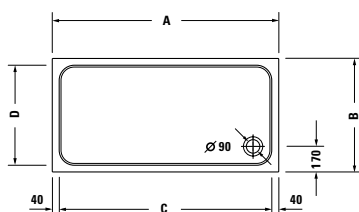
Shower tray rectangle
 3,2 mm sanitary acrylic

	A	B	C	D
720097	1100	750	1020	670
720098	1300	750	1220	670
720099	1500	750	1420	670
720100	1700	750	1620	670

Length mm	Width mm	Height mm	Weight kg	Model-No.	Euro	
					White	- 00
1100	750	85	16,0	720097 00 0 00 0000		
1300	750	85	18,0	720098 00 0 00 0000		
1500	750	85	24,5	720099 00 0 00 0000		
1700	750	85	28,0	720100 00 0 00 0000		
with Antislip						
1100	750	85	16,0	720097 00 0 00 0001		
1300	750	85	18,0	720098 00 0 00 0001		
1500	750	85	24,5	720099 00 0 00 0001		
1700	750	85	28,0	720100 00 0 00 0001		
Accessories for shower tray						
Bathtub anchors				790125 00 0 00 0000		
Rubber profile				790126 00 0 00 0000		
Support frame, for bathtubs and shower trays, with length > 1000 mm				790127 00 0 00 0000		
Support frame, for shower trays, with length > 1500 mm				790158 00 0 00 0000		
Outlet drain, chrome				791217 00 0 00 1000		
Support, for # 720097				791455 00 0 00 0000		
Support, for # 720098				791456 00 0 00 0000		
Support, for # 720099				791457 00 0 00 0000		
Support, for # 720100				791458 00 0 00 0000		





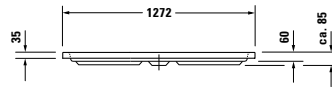
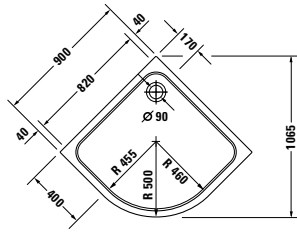

D-Code Design by sieger design

Shower tray quarter circle
3,2 mm sanitary acrylic



Length mm	Width mm	Height mm	Weight kg	Model-No.	Euro
					White - 00
900	900	85	15,0	720108 00 0 00 0000	
with Antislip					
900	900	85	15,0	720108 00 0 00 0001	
Accessories for shower tray					
Bathtub anchors				790125 00 0 00 0000	
Rubber profile				790126 00 0 00 0000	
Support frame for shower trays, for shower trays, with length ≤ 1000 mm				790129 00 0 00 0000	
Outlet drain, chrome				791217 00 0 00 1000	
Support, for # 720108				790485 00 0 00 0000	

D-Code Accessories Design by sieger design

	Description	Model-No.	Euro
	Bathtub anchors for mounting and support of bathtubs and shower trays 3 pieces	790125 00 0 00 0000	
	Rubber profile for noise reduction and sealing against moisture length: 3300 mm	790126 00 0 00 0000	
	Support frame for shower trays for shower trays, with length \leq 1000 mm height-adjustable from 125 - 185 mm	790129 00 0 00 0000	
	Support frame for bathtubs and shower trays, with length > 1000 mm, height-adjustable from 115 - 180 mm 2 pieces	790127 00 0 00 0000	
	Support frame for shower trays, with length > 1500 mm, height-adjustable from 115 - 180 mm 3 pieces	790158 00 0 00 0000	
	Outlet drain chrome outlet diameter 90 mm	791217 00 0 00 1000	

Ordering Sample

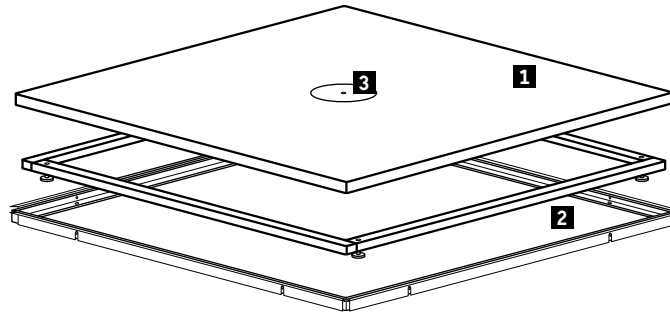

Description	Remark	Quantity	Model-No.
1 Flush Fitting Shower Tray	800 x 800 mm	1	# 720079
2 Mounting set for # 720079 (border frame, support frame)		1	# 790137
3 Outlet drain for Flush Fitting Shower Trays, horizontal outlet		1	# 790261
Mounting foam for supports, 400 ml	for Shower Trays \geq 900 mm	1	# 790340

DuraPlan Design by Prof. Frank Huster

Flush Fitted Shower Tray square

4 mm sanitary acrylic

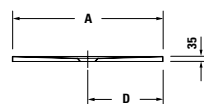
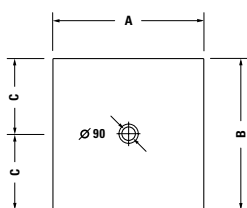

	A	B	C	D
720079	793	793	396,5	396,5
720082	893	893	446,5	446,5
720085	993	993	496,5	496,5
720089	1193	1193	596,5	596,5

Length mm	Width mm	Height mm	Weight kg	Model-No.	Euro	
					White	- 00
800	800	35	12,7	720079 00 0 00 0000		
900	900	35	16,1	720082 00 0 00 0000		
1000	1000	35	19,0	720085 00 0 00 0000		
1200	1200	35	27,7	720089 00 0 00 0000		
with Antislip						
800	800	35	12,7	720079 00 0 00 0001		
900	900	35	16,1	720082 00 0 00 0001		
1000	1000	35	19,0	720085 00 0 00 0001		
1200	1200	35	27,7	720089 00 0 00 0001		
Accessories for shower tray						
Mounting set, for # 720079*				790137 00 0 00 0000		
Mounting set, for # 720082*				790140 00 0 00 0000		
Mounting set, for # 720085*				790143 00 0 00 0000		
Mounting set, for # 720089*				790147 00 0 00 0000		
Outlet drain, horizontal outlet, (white -00, chrome -10)				790261 00 0 00 * *00		
Outlet drain, vertical outlet, (white -00, chrome -10)				790262 00 0 00 * *00		
Firestop collar, for # 790262***				790151 00 0 00 0000		
Mounting foam for supports, 400 ml				790340 00 0 00 0000		

Infobox: * Mounting set including support frame and border frame to limit the screed floor and the position of shower tray. Excluding the materials for sealing layer/ *** Fire resistance class: R90 (Installation in walls), R90 / R120 (Installation in ceilings) according to DIN 4102-11/ Observe preinstallation sheet

DuraPlan Design by Prof. Frank Huster

Flush Fitted Shower Tray rectangle

4 mm sanitary acrylic

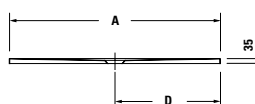
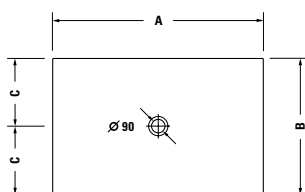

	A	B	C	D
720080	893	743	371,5	446,5
720081	893	793	396,5	446,5
720083	993	793	396,5	496,5
720084	993	893	446,5	496,5
720086	1193	793	396,5	596,5
720087	1193	893	446,5	596,5
720088	1193	993	496,5	596,5
720090	1393	743	371,5	696,5
720091	1393	893	446,5	696,5
720092	1593	893	446,5	796,5

Length mm	Width mm	Height mm	Weight kg	Model-No.	Euro	
					White	- 00
900	750	35	13,65	720080 00 0 00 0000		
900	800	35	13,9	720081 00 0 00 0000		
1000	800	35	16,3	720083 00 0 00 0000		
1000	900	35	17,8	720084 00 0 00 0000		
1200	800	35	20,5	720086 00 0 00 0000		
1200	900	35	22,3	720087 00 0 00 0000		
1200	1000	35	24,75	720088 00 0 00 0000		
1400	750	35	25,0	720090 00 0 00 0000		
1400	900	35	26,1	720091 00 0 00 0000		
1600	900	35	28,7	720092 00 0 00 0000		

with Antislip

900	750	35	13,65	720080 00 0 00 0001		
900	800	35	13,9	720081 00 0 00 0001		
1000	800	35	16,3	720083 00 0 00 0001		
1000	900	35	17,8	720084 00 0 00 0001		
1200	800	35	20,5	720086 00 0 00 0001		
1200	900	35	22,3	720087 00 0 00 0001		
1200	1000	35	24,75	720088 00 0 00 0001		
1400	750	35	25,0	720090 00 0 00 0001		
1400	900	35	26,1	720091 00 0 00 0001		
1600	900	35	28,7	720092 00 0 00 0001		

Accessories for shower tray

Mounting set, for # 720080*	790138 00 0 00 0000		
Mounting set, for # 720081*	790139 00 0 00 0000		
Mounting set, for # 720083*	790141 00 0 00 0000		
Mounting set, for # 720084*	790142 00 0 00 0000		
Mounting set, for # 720086*	790144 00 0 00 0000		
Mounting set, for # 720087*	790145 00 0 00 0000		
Mounting set, for # 720088*	790146 00 0 00 0000		
Mounting set, for # 720090*	790148 00 0 00 0000		
Mounting set, for # 720091*	790149 00 0 00 0000		
Mounting set, for # 720092*	790150 00 0 00 0000		
Outlet drain, horizontal outlet, (white -00, chrome -10)	790261 00 0 00 * *00		
Outlet drain, vertical outlet, (white -00, chrome -10)	790262 00 0 00 * *00		
Firestop collar, for # 790262***	790151 00 0 00 0000		
Mounting foam for supports, 400 ml	790340 00 0 00 0000		

Infobox: * Mounting set including support frame and border frame to limit the screed floor and the position of shower tray. Excluding the materials for sealing layer/ *** Fire resistance class: R90 (Installation in walls), R90 / R120 (Installation in ceilings) according to DIN 4102-11/ Observe preinstallation sheet

DuraPlan Accessories Design by Prof. Frank Huster

	Description	Model-No.	Euro
	Mounting set* for # 720079 for # 720080 for # 720081 for # 720082 for # 720083 for # 720084 for # 720085 for # 720086 for # 720087 for # 720088 for # 720089 for # 720090 for # 720091 for # 720092	790137 00 0 00 0000 790138 00 0 00 0000 790139 00 0 00 0000 790140 00 0 00 0000 790141 00 0 00 0000 790142 00 0 00 0000 790143 00 0 00 0000 790144 00 0 00 0000 790145 00 0 00 0000 790146 00 0 00 0000 790147 00 0 00 0000 790148 00 0 00 0000 790149 00 0 00 0000 790150 00 0 00 0000	
Infobox: * Mounting set including support frame and border frame to limit the screed floor and the position of shower tray. Excluding the materials for sealing layer			
	Outlet drain horizontal outlet, for flush fitted shower trays, 0,7 l/s (according to DIN EN 1253), outlet diameter 90 mm white chrome	790261 00 0 00 0000 790261 00 0 00 1000	
	Outlet drain vertical outlet, for flush fitted shower trays, 1,0 l/s (according to DIN EN 1253), outlet diameter 90 mm white chrome	790262 00 0 00 0000 790262 00 0 00 1000	
	Firestop collar*** for # 790262	790151 00 0 00 0000	
Infobox: *** Fire resistance class: R90 (Installation in walls), R90 / R120 (Installation in ceilings) according to DIN 4102-11			
	Mounting foam for supports 400 ml 1 bottle	790340 00 0 00 0000	

Starck Slimline Design by Philippe Starck

Shower tray square
4 mm sanitary acrylic

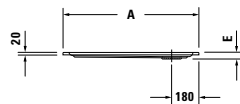
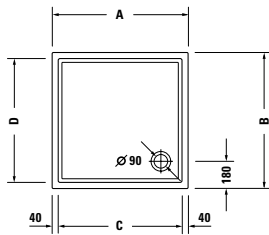

	A	B	C	D	E
720114	800	800	720	720	45
720115	900	900	820	820	45
720116	1000	1000	920	920	50

Length mm	Width mm	Height mm	Weight kg	Model-No.	Euro	
					White	- 00
800	800	45	13,5	720114 00 0 00 0000		
900	900	45	15,8	720115 00 0 00 0000		
1000	1000	50	18,2	720116 00 0 00 0000		
with Antislip						
800	800	45	13,5	720114 00 0 00 0001		
900	900	45	15,8	720115 00 0 00 0001		
1000	1000	50	18,2	720116 00 0 00 0001		
Accessories for shower tray						
Support frame for shower trays, height-adjustable from 85 - 105 mm				790101 00 0 00 0000		
Support frame for shower trays, height-adjustable from 100 - 185 mm				790102 00 0 00 0000		
Bathtub anchors				790103 00 0 00 0000		
Rubber profile				790104 00 0 00 0000		
Outlet drain, horizontal outlet, chrome				790263 00 0 00 1000		
Outlet drain, vertical outlet, chrome				790269 00 0 00 1000		
Support, for # 720114				791477 00 0 00 0000		
Support, for # 720115				791478 00 0 00 0000		
Support, for # 720116				791479 00 0 00 0000		

Starck Slimline Design by Philippe Starck

Shower tray rectangle 4 mm sanitary acrylic

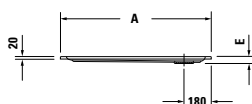
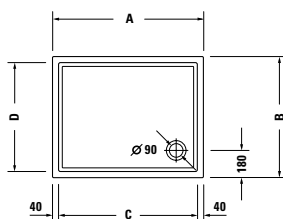

	A	B	C	D	E
720117	900	750	820	670	45
720118	900	800	820	720	45
720119	1000	800	920	720	50
720120	1000	900	920	820	50
720121	1200	800	1120	720	55
720122	1200	900	1120	820	55
720123	1200	1000	1120	920	55
720124	1400	700	1320	620	55
720125	1400	750	1320	670	55
720126	1400	900	1320	820	55

Length mm	Width mm	Height mm	Weight kg	Model-No.	Euro	
					White	- 00
900	750	45	13,5	720117 00 0 00 0000		
900	800	45	14,7	720118 00 0 00 0000		
1000	800	50	15,2	720119 00 0 00 0000		
1000	900	50	17,0	720120 00 0 00 0000		
1200	800	55	21,0	720121 00 0 00 0000		
1200	900	55	22,3	720122 00 0 00 0000		
1200	1000	55	23,8	720123 00 0 00 0000		
1400	700	55	25,6	720124 00 0 00 0000		
1400	750	55	25,9	720125 00 0 00 0000		
1400	900	55	27,5	720126 00 0 00 0000		
with Antislip						
900	750	45	13,5	720117 00 0 00 0001		
900	800	45	14,7	720118 00 0 00 0001		
1000	800	50	15,2	720119 00 0 00 0001		
1000	900	50	17,0	720120 00 0 00 0001		
1200	800	55	21,0	720121 00 0 00 0001		
1200	900	55	22,3	720122 00 0 00 0001		
1200	1000	55	23,8	720123 00 0 00 0001		
1400	700	55	25,6	720124 00 0 00 0001		
1400	750	55	25,9	720125 00 0 00 0001		
1400	900	55	27,5	720126 00 0 00 0001		
Accessories for shower tray						
Support frame, for bathtubs and shower trays, with length > 1000 mm				790100 00 0 00 0000		
Support frame for shower trays, height-adjustable from 85 - 105 mm				790101 00 0 00 0000		
Support frame for shower trays, height-adjustable from 100 - 185 mm				790102 00 0 00 0000		
Bathtub anchors				790103 00 0 00 0000		
Rubber profile				790104 00 0 00 0000		
Outlet drain, horizontal outlet, chrome				790263 00 0 00 1000		
Outlet drain, vertical outlet, chrome				790269 00 0 00 1000		
Support, for # 720117				791480 00 0 00 0000		
Support, for # 720118				791481 00 0 00 0000		
Support, for # 720119				791482 00 0 00 0000		
Support, for # 720120				791483 00 0 00 0000		
Support, for # 720121				791484 00 0 00 0000		
Support, for # 720122				791485 00 0 00 0000		
Support, for # 720123				791486 00 0 00 0000		
Support, for # 720124				791487 00 0 00 0000		
Support, for # 720125				791488 00 0 00 0000		
Support, for # 720126				791489 00 0 00 0000		

Starck Slimline Design by Philippe Starck

Shower tray rectangle
4 mm sanitary acrylic



	A	B	C	D	E
720127	1500	700	1420	620	55
720128	1500	750	1420	670	60
720129	1600	700	1520	620	60
720130	1600	750	1520	670	60
720131	1600	900	1520	820	60
720132	1700	750	1620	670	60
720133	1700	900	1620	820	60
720134	1800	900	1720	820	65

Length mm	Width mm	Height mm	Weight kg	Model-No.	Euro	
					White	- 00
1500	700	55	24,0	720127 00 0 00 0000		
1500	750	60	28,0	720128 00 0 00 0000		
1600	700	60	30,5	720129 00 0 00 0000		
1600	750	60	31,5	720130 00 0 00 0000		
1600	900	60	30,5	720131 00 0 00 0000		
1700	750	60	27,0	720132 00 0 00 0000		
1700	900	60	30,0	720133 00 0 00 0000		
1800	900	65	37,0	720134 00 0 00 0000		

with Antislip

1500	700	55	24,0	720127 00 0 00 0001		
1500	750	60	28,0	720128 00 0 00 0001		
1600	700	60	30,5	720129 00 0 00 0001		
1600	750	60	31,5	720130 00 0 00 0001		
1600	900	60	30,5	720131 00 0 00 0001		
1700	750	60	27,0	720132 00 0 00 0001		
1700	900	60	30,0	720133 00 0 00 0001		
1800	900	65	37,0	720134 00 0 00 0001		

Accessories for shower tray

Support frame, for bathtubs and shower trays, with length > 1500 mm	790105 00 0 00 0000	
Bathtub anchors	790103 00 0 00 0000	
Rubber profile	790104 00 0 00 0000	
Outlet drain, horizontal outlet, chrome	790263 00 0 00 1000	
Outlet drain, vertical outlet, chrome	790269 00 0 00 1000	
Support, for # 720127	791490 00 0 00 0000	
Support, for # 720128	791491 00 0 00 0000	
Support, for # 720129	791492 00 0 00 0000	
Support, for # 720130	791493 00 0 00 0000	
Support, for # 720131	791494 00 0 00 0000	
Support, for # 720132	791495 00 0 00 0000	
Support, for # 720133	791496 00 0 00 0000	
Support, for # 720134	791497 00 0 00 0000	

Starck Slimline Design by Philippe Starck

Shower tray quarter circle, R55 4 mm sanitary acrylic

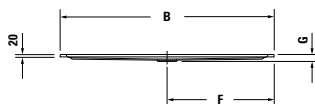
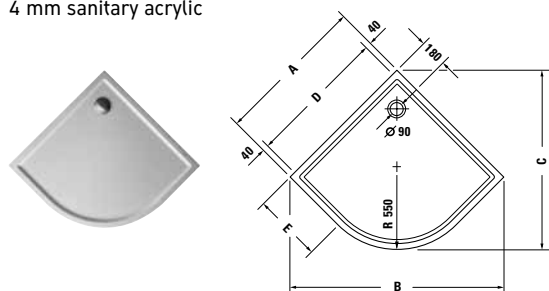

	A	B	C	D	E	F	G
720135	900	1267	1042	820	350	634	45
720136	1000	1408	1184	920	450	704	45

Length mm	Width mm	Height mm	Weight kg	Model-No.	Euro	
					White	- 00
900	900	45	15,3	720135 00 0 00 0000		
1000	1000	45	18,5	720136 00 0 00 0000		
with Antislip						
900	900	45	15,3	720135 00 0 00 0001		
1000	1000	45	18,5	720136 00 0 00 0001		
Accessories for shower tray						
Support frame for shower trays, height-adjustable from 85 - 105 mm				790101 00 0 00 0000		
Support frame for shower trays, height-adjustable from 100 - 185 mm				790102 00 0 00 0000		
Bathtub anchors				790103 00 0 00 0000		
Rubber profile				790104 00 0 00 0000		
Outlet drain, horizontal outlet, chrome				790263 00 0 00 1000		
Outlet drain, vertical outlet, chrome				790269 00 0 00 1000		
Support, for # 720135				791498 00 0 00 0000		
Support, for # 720136				791499 00 0 00 0000		

Starck Slimline Design by Philippe Starck

Shower tray quarter circle, R55
4 mm sanitary acrylic

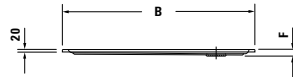
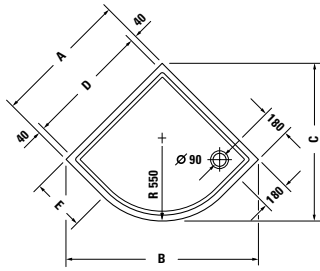

	A	B	C	D	E	F
720137	900	1267	1042	820	350	45
720138	1000	1408	1184	920	450	45

Length mm	Width mm	Height mm	Weight kg	Model-No.	Euro	
					White	- 00
900	900	45	15,3	720137 00 0 00 0000		
1000	1000	45	15,8	720138 00 0 00 0000		
with Antislip						
900	900	45	15,3	720137 00 0 00 0001		
1000	1000	45	15,8	720138 00 0 00 0001		
Accessories for shower tray						
Support frame for shower trays, height-adjustable from 85 - 105 mm				790101 00 0 00 0000		
Support frame for shower trays, height-adjustable from 100 - 185 mm				790102 00 0 00 0000		
Bathtub anchors				790103 00 0 00 0000		
Rubber profile				790104 00 0 00 0000		
Outlet drain, horizontal outlet, chrome				790263 00 0 00 1000		
Outlet drain, vertical outlet, chrome				790269 00 0 00 1000		
Support, for # 720137				791500 00 0 00 0000		
Support, for # 720138				791501 00 0 00 0000		

Starck Slimline Design by Philippe Starck

Shower tray pentagon
4 mm sanitary acrylic

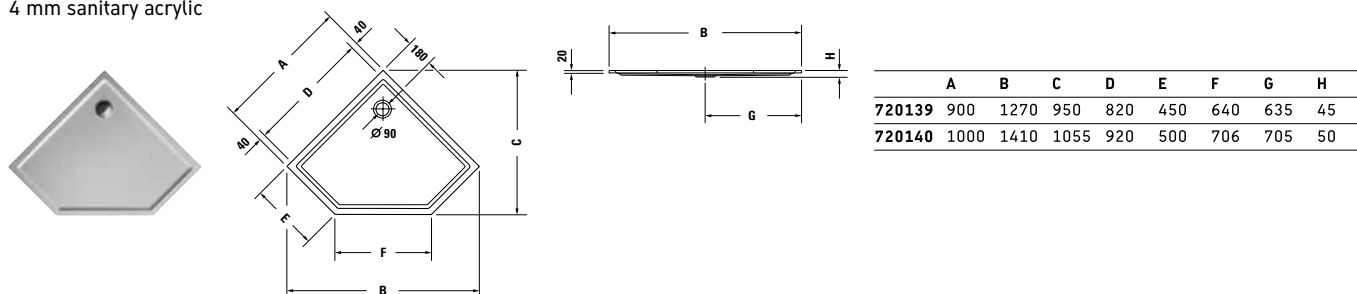

Length mm	Width mm	Height mm	Weight kg	Model-No.	Euro
					White - 00
900	900	45	15,3	720139 00 0 00 0000	
1000	1000	50	18,5	720140 00 0 00 0000	
with Antislip					
900	900	45	15,3	720139 00 0 00 0001	
1000	1000	50	18,5	720140 00 0 00 0001	
Accessories for shower tray					
Support frame for shower trays, height-adjustable from 85 - 105 mm				790101 00 0 00 0000	
Support frame for shower trays, height-adjustable from 100 - 185 mm				790102 00 0 00 0000	
Bathtub anchors				790103 00 0 00 0000	
Rubber profile				790104 00 0 00 0000	
Outlet drain, horizontal outlet, chrome				790263 00 0 00 1000	
Outlet drain, vertical outlet, chrome				790269 00 0 00 1000	
Support, for # 720139				791502 00 0 00 0000	
Support, for # 720140				791503 00 0 00 0000	

OpenSpace Product Information

Tap side

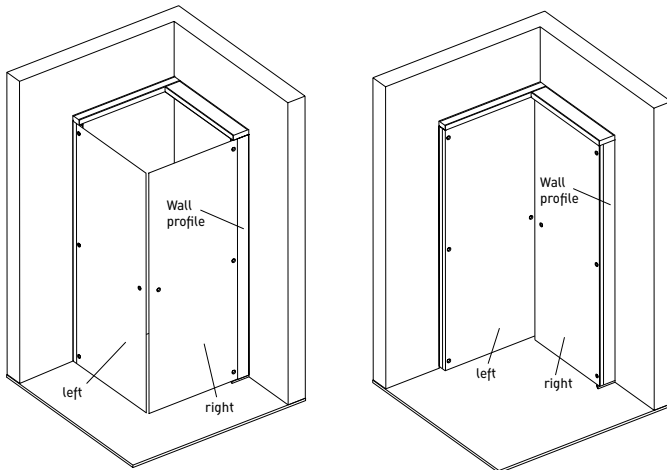

The glass doors of OpenSpace can be folded away after use. So OpenSpace transforms into a discreet wall panel which tidily conceals tap fittings and shower attachments.

The taps can be either positioned on the left or on the right side. The tap side is taken from the perspective of a person standing in front of the OpenSpace shower screen. For the type with tap left the deeper wall profile is assembled on the left. For the type with tap right the deeper wall profile is assembled on the right. Please consider this when ordering your OpenSpace shower screen. On site the tap side is no more changeable.

Before ordering an OpenSpace shower screen check the structural conditions with the help of the pre-installation data sheet.

Selection of taps

The deeper wall profile is constructed for the assembly of taps. The tap parts on the wall can be up to 125 mm deep.

As a shower set consisting of shower bar and hand shower can have a depth of more than 125 mm a special quench holder with conical adapter is included in the delivery of every OpenSpace shower screen. Thus a multitude of standard hand showers are applicable and a clash of hand shower and glass folded towards the wall is avoided.

Please consider the instructions in the pre-installation data sheet for the selection of your taps.

Water-tightness

The doors of OpenSpace directly rest on the shower tray or the tiled floor by the rise and fall hinge mechanism. Thereby a splash guard is largely achieved.

Construction-conditioned, absolute water-tightness can't be ensured for frameless glass shower screens that are sealed by means of flexible plastic sealing strips.

Doors that can be opened outwards can cause water drops.

Technical information

OpenSpace complies with the technical requirements of the valid EN 14428.

Glass

8 mm toughened safety glass manufactured to EN 12150-1, transparent glass or optional mirror glass for tap side

Profiles

Aluminium, finish chrome optics high-gloss, with rise and fall hinge mechanism, 180° swivelling range

Application area

For shower trays or tiled shower areas

Adjusting range

Vertical tolerances up to 18 mm can be adjusted.

Quench holder

Chromed brass, included in delivery, only suitable for hand showers with conical adapter

Door handle

Chromed ABS, included in delivery, optionally mountable



Door handle (inside view)

Installation dimensions

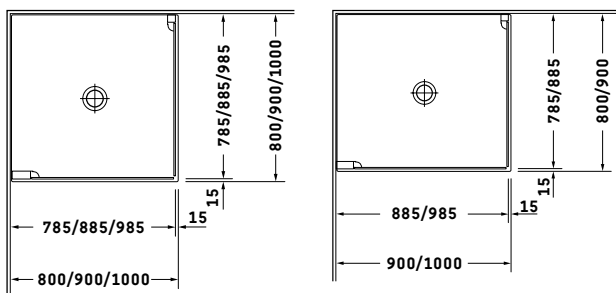

OpenSpace square, tap left
(for tap right mirror-inverted)

OpenSpace rectangle, tap left
(for tap right mirror-inverted)

The figures show the required installation dimensions of the shower tray / area (= measured length dimension and width dimension from tiled wall to the front edge of the installed shower tray / area) for the available dimensions of OpenSpace.

The dimensions of OpenSpace consider that the shower screen is offset towards the inside by 15 mm from the outer edge of shower tray / area for the benefit of the water-tightness.

OpenSpace Design by E00S

Shower screen square, tap left

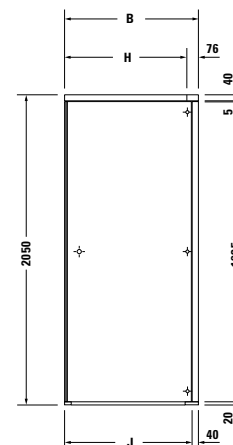
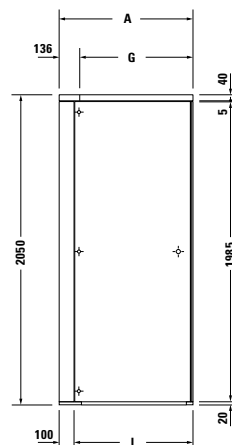
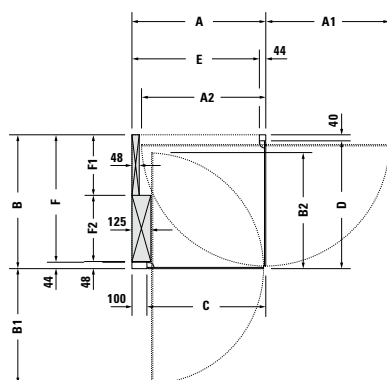

Mounting area for taps on the wall: Please consider the specified maximum projection for the areas F1 and F2.

	A	A1	A2	B	B1	B2	C	D	E	F	F1	F2	G	H	I	J
770001	785	725	727	785	665	667	685	745	741	741	390	347	649	709	685	745
770002	885	825	827	885	765	767	785	845	841	841	400	437	749	809	785	845
770003	985	925	927	985	865	867	885	945	941	941	410	527	849	909	885	945

Description	Length mm	Width mm	Height mm	Weight kg	Model-No.	Euro
for shower tray 800 x 800 mm						
transparent glass	785	785	2050	75,0	770001 00 0 00 0000	
transparent and mirror glass	785	785	2050	75,0	770001 00 0 10 0000	
for shower tray 900 x 900 mm						
transparent glass	885	885	2050	85,0	770002 00 0 00 0000	
transparent and mirror glass	885	885	2050	85,0	770002 00 0 10 0000	
for shower tray 1000 x 1000 mm						
transparent glass	985	985	2050	95,0	770003 00 0 00 0000	
transparent and mirror glass	985	985	2050	95,0	770003 00 0 10 0000	

Infobox: The dimensions indicated for the shower trays refer to the installation dimensions, i.e. the measured length dimension and width dimension of the installed shower tray after tiling

OpenSpace Design by E00S

Shower screen square, tap right

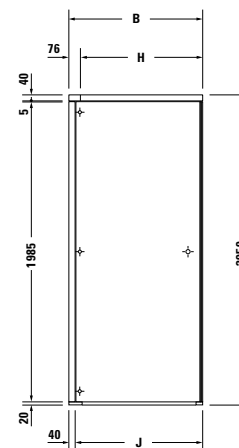
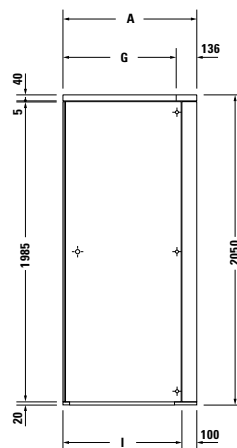
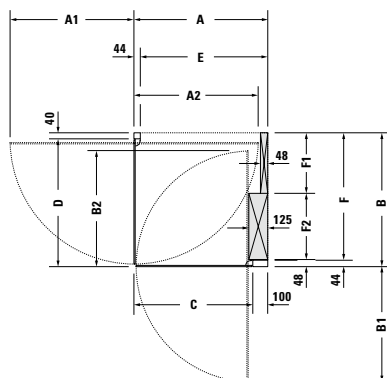

☒ **Mounting area for taps on the wall:** Please consider the specified maximum projection for the areas F1 and F2.

	A	A1	A2	B	B1	B2	C	D	E	F	F1	F2	G	H	I	J
770001	785	725	727	785	665	667	685	745	741	741	390	347	649	709	685	745
770002	885	825	827	885	765	767	785	845	841	841	400	437	749	809	785	845
770003	985	925	927	985	865	867	885	945	941	941	410	527	849	909	885	945

Description	Length mm	Width mm	Height mm	Weight kg	Model-No.	Euro
for shower tray 800 x 800 mm						
transparent glass	785	785	2050	75,0	770001 00 0 01 0000	
transparent and mirror glass	785	785	2050	75,0	770001 00 0 11 0000	
for shower tray 900 x 900 mm						
transparent glass	885	885	2050	85,0	770002 00 0 01 0000	
transparent and mirror glass	885	885	2050	85,0	770002 00 0 11 0000	
for shower tray 1000 x 1000 mm						
transparent glass	985	985	2050	95,0	770003 00 0 01 0000	
transparent and mirror glass	985	985	2050	95,0	770003 00 0 11 0000	

Infobox: The dimensions indicated for the shower trays refer to the installation dimensions, i.e. the measured length dimension and width dimension of the installed shower tray after tiling

OpenSpace Design by E00S

Shower screen rectangle, tap left

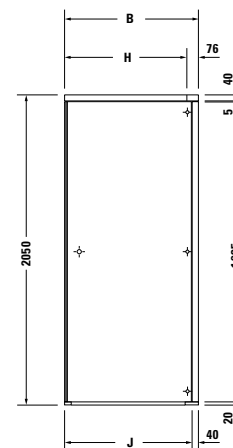
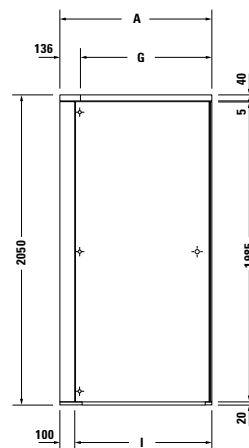
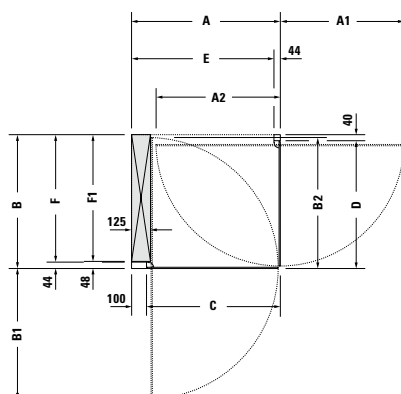

☒ **Mounting area for taps on the wall:** Please consider the specified maximum projection for the area F1.

	A	A1	A2	B	B1	B2	C	D	E	F	F1	G	H	I	J
770004	885	725	727	785	765	767	785	745	841	741	737	749	709	785	745
770005	985	825	827	885	865	867	885	845	941	841	837	849	809	885	845

Description	Length mm	Width mm	Height mm	Weight kg	Model-No.	Euro
for shower tray 900 x 800 mm						
transparent glass	885	785	2050	80,0	770004 00 0 00 0000	
transparent and mirror glass	885	785	2050	80,0	770004 00 0 10 0000	
for shower tray 1000 x 900 mm						
transparent glass	985	885	2050	90,0	770005 00 0 00 0000	
transparent and mirror glass	985	885	2050	90,0	770005 00 0 10 0000	

Infobox: The dimensions indicated for the shower trays refer to the installation dimensions, i.e. the measured length dimension and width dimension of the installed shower tray after tiling

OpenSpace Design by E00S

Shower screen rectangle, tap right

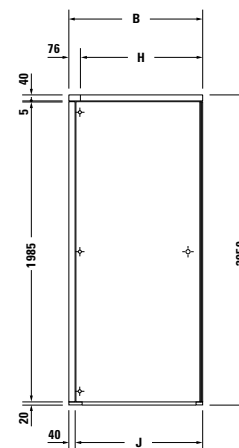
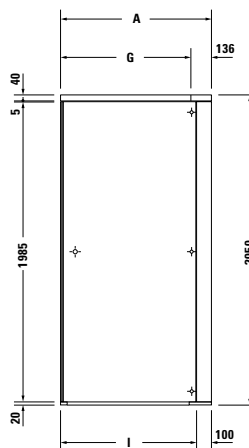
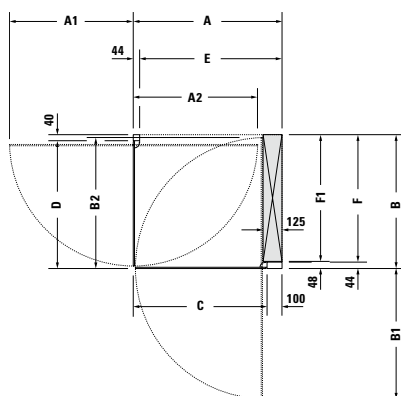

☒ **Mounting area for taps on the wall:** Please consider the specified maximum projection for the area F1.

	A	A1	A2	B	B1	B2	C	D	E	F	F1	G	H	I	J
770004	885	725	727	785	765	767	785	745	841	741	737	749	709	785	745
770005	985	825	827	885	865	867	885	845	941	841	837	849	809	885	845

Description	Length mm	Width mm	Height mm	Weight kg	Model-No.	Euro
for shower tray 900 x 800 mm						
transparent glass	885	785	2050	80,0	770004 00 0 01 0000	
transparent and mirror glass	885	785	2050	80,0	770004 00 0 11 0000	
for shower tray 1000 x 900 mm						
transparent glass	985	885	2050	90,0	770005 00 0 01 0000	
transparent and mirror glass	985	885	2050	90,0	770005 00 0 11 0000	

Infobox: The dimensions indicated for the shower trays refer to the installation dimensions, i.e. the measured length dimension and width dimension of the installed shower tray after tiling

OpenSpace Design by E00S

Shower screen, corner left

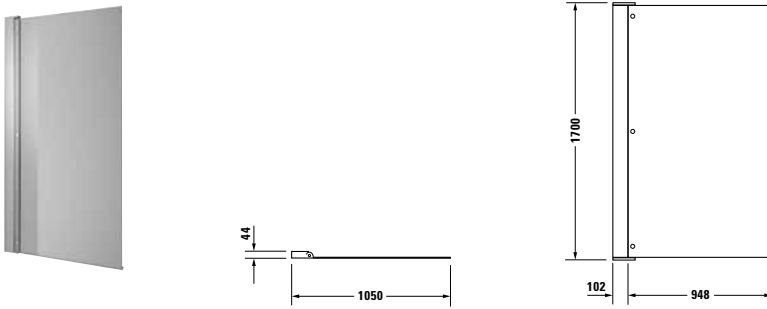

Description	Width mm	Height mm	Weight kg	Model-No.	Euro
for Nahho built-in					
transparent glass	1050	1700	40,0	770006 00 0 00 0000	
transparent and mirror glass	1050	1700	40,0	770006 00 0 10 0000	

Infobox: 8 mm toughened safety glass

OpenSpace Design by E00S

Shower screen, corner right

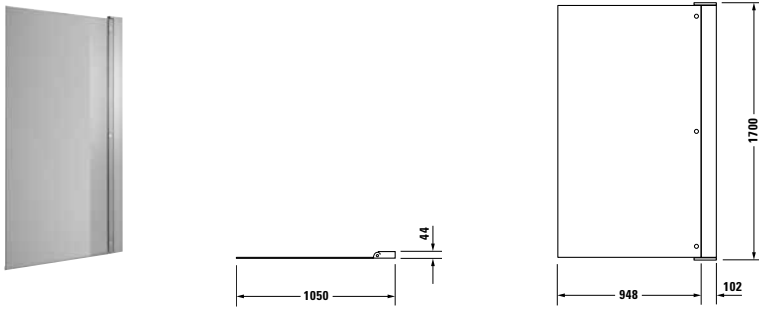

Description	Width mm	Height mm	Weight kg	Model-No.	Euro
for Nahho built-in					
transparent glass	1050	1700	40,0	770007 00 0 00 0000	
transparent and mirror glass	1050	1700	40,0	770007 00 0 10 0000	

Infobox: 8 mm toughened safety glass

Pool Product Information

Combi-Pool Blue Moon

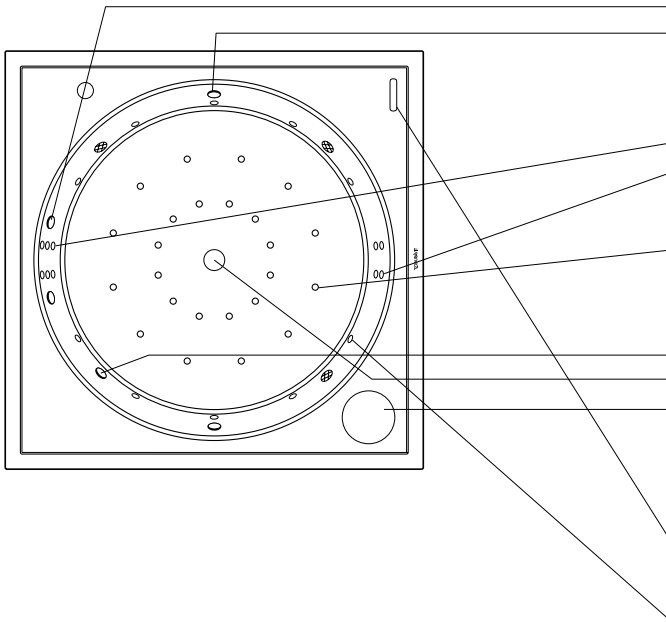

Equipment

Whirl circuit Power

- 2 powerful back-massage jets (mixture of air and water)
- 2 powerful side-mounted jets (mixture of air and water)
- All four jets are adjustable at the nozzle.

Whirl circuit Relax

- 6 adjustable back-massage jets (mixture of air and water)
- 4 adjustable rotating foot-massage jets (mixture of air and water)

Whirl circuit Emotion

- 24 circularly arranged Durapearl floor jets with three functions (a sparkling mix of water and air, only water, only air)

Circuit for hygiene and temperature

- 1 inlet jet for water from the circuit for hygiene and temperature
- 1 floor suction
- 1 cartridge filter
- Ozone generator and heating

Control elements

- Remote control Combi-Pool
- Control panel Combi-Pool under a hinged cover of the inlay

Coloured light

- 10 LED-spotlights with 6 colours and 5 coloured lighting programmes

Additional modules (optional)

- Water supply through inlet jet (only for indoor use)
- Integrated filling (only for indoor use)
- Ground plate (for outdoor usage)

Accessories (optional)

- Tub cover (also recommended for insulation)
- Storage holder for tub cover
- Isolating buoyant film

Pool Product Information

Combi-Pool Sundeck

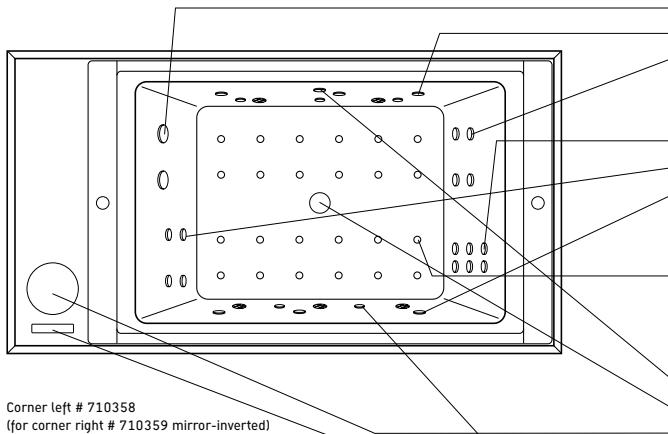

Equipment

Whirl circuit Power

- 2 powerful back-massage jets, adjustable at the nozzle (mixt. of air+water)
- 3 side-mounted jets (mixture of air and water)
- 4 rotating foot-massage jets (mixture of air and water)

Whirl circuit Relax

- 6 adjustable back-massage jets (mixture of air and water)
- 4 adjustable rotating foot-massage jets (mixture of air and water)
- 3 adjustable side-mounted jets (mixture of air and water)

Whirl circuit Emotion

- 24 Durapearl floor jets with three functions
(a sparkling mix of water and air, only water, only air)

Circuit for hygiene and temperature

- 1 inlet jet for water from the circuit for hygiene and temperature
- 1 floor suction
- 1 cartridge filter
- Ozone generator and heating

Control elements

- Remote control Combi-Pool
- Control panel Combi-Pool hidden below the cushioned cover

Coloured light

- 5 LED-spotlights with 6 colours and 5 coloured lighting programmes

Additional modules (optional)

- Water supply through inlet jet (only for indoor use)
- Integrated filling (only for indoor use)
- Ground plate (for outdoor usage)

Accessories (optional)

- Isolating buoyant film

Pool Product Information

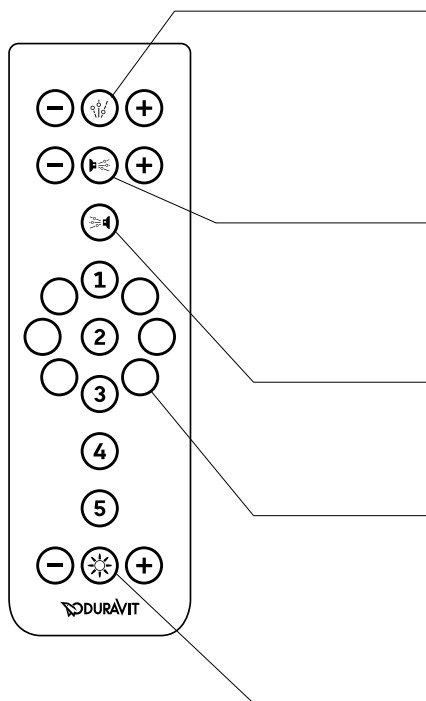

Remote Control

Emotion

The Emotion key switches on the new Durapearl effect with its 3 functions: the sparkling mixture of air and water, the refined jets of water or the classical warm air effect. The plus or minus keys may be used to regulate intensity.

Relax

The circulation setting Relax uses jets located in the foot and back areas as well as side-mounted jets in the Sundeck pool to give a calming, relaxing massage. The plus or minus keys may be used to regulate intensity.

Power

A strong power massage, the intensity of which can be regulated as desired at the large power jet itself during bathing.

Coloured light and whirl scenarios

Light from 10 (5 in Sundeck) side-mounted LED spotlights suffuse the tub with intensive colours. The colour ring allows to select between 6 colours. Coloured lighting programmes are started using keys 1 – 5, but may also be used in combination with coordinated massage programmes.

Light

Dimmable white light provides pleasant lighting. The plus or minus keys may be used to dim the brightness of all (coloured and white light).

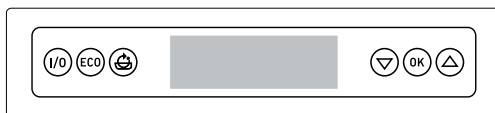

Operating the display is done by pressing the raised symbols. The keys have a blue backlit display depending on the operation mode. The menu tree may be navigated using the arrow keys and settings may be made easily and simply. The menu tree is available in different languages which are shown on the blue backlit LCD display. The following languages are available on the display: English, German, French, Italian, Spanish, Portuguese.

Optionally, there are two more displays available with the following languages:

791859 00 0 00 0000 for English, Dutch, Danish, Norwegian, Swedish
 # 791860 00 0 00 0000 for English, Polish, Czech, Slovakian, Hungarian, Turkish.

Pool Product Information

Blue Moon

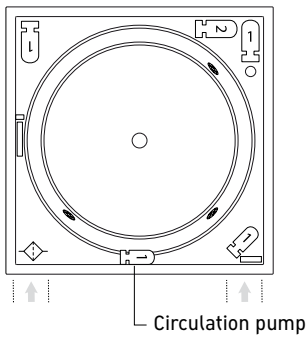

710169

References for Blue Moon and Sundeck with poolsystem

- The technical compartment which carries the display is wether placed on the left (# 700358) or on the right side (# 700359).
- The poolsystem is only available with panel.
- We recommend panels with insulation for the outdoor application.

Power supply

220-240V 50Hz

60Hz versions: Please replace "00" by "06" on 14th and 15th digit of the item code.

Sundeck

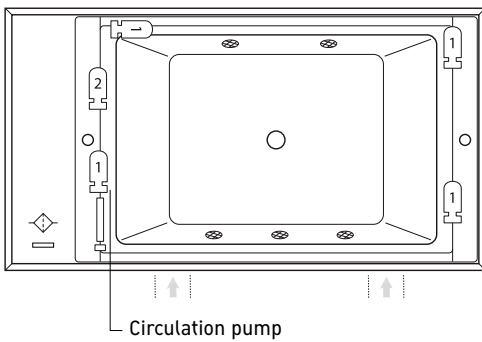

710358 corner left

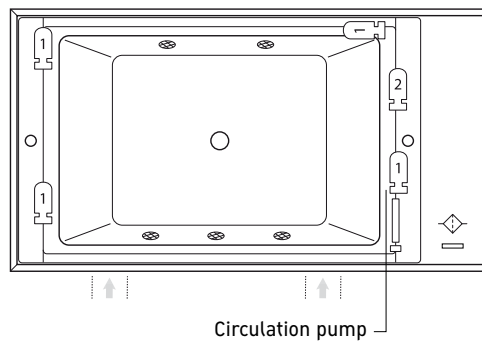

710359 corner right

Legend



Blue Moon Design by Jochen Schmiedem

Ordering Sample Pool

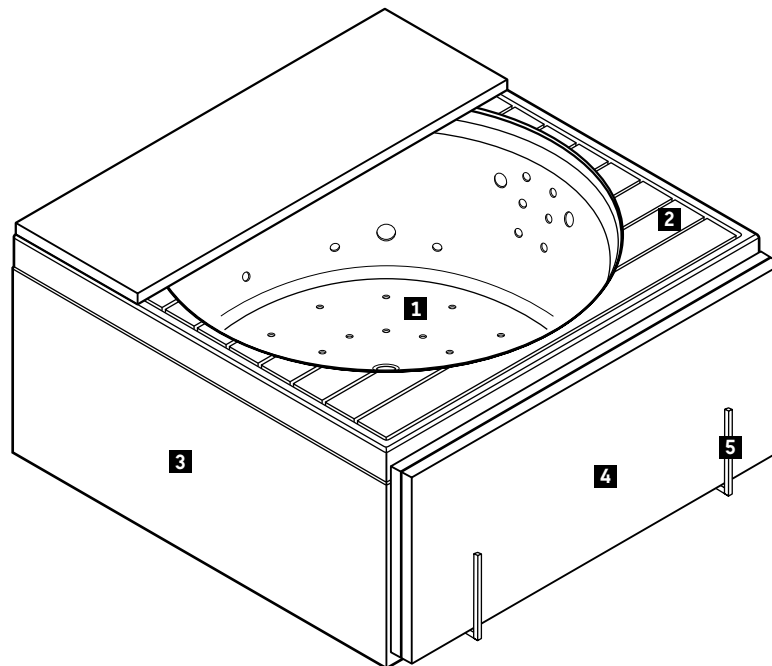

Description	Remark	Quantity	Model-No.
1 Pool with ground plate	1800 x 1800 mm	1	# 710169 00 8 00 0000 Module-No. 10
2 Wooden inlay Teak (decor) with hinged cover	for pool 1800 x 1800 mm	1	# 790880 00 0 01 0000
3 Acrylic panel with isolation for freestanding version	for pool 1800 x 1800 mm	1	# 701093 00 0 00 0000
4 Tub cover	1800 x 1800 mm	1	# 790884 00 0 00 0000
5 Storage holder for tub cover, right	for whirltubs and pools	1	# 791806 00 0 00 6600

Additional information:

The following are always recommended in poolsystems to save on energy consumption:

- insulating buoyant film (indoor application)
- tub cover combined with insulating buoyant film (outdoor application)
- persenning (outdoor application)
- poolsystem with ground plate (outdoor application)
- panels without insulating (sufficient for indoor application)
- panels with insulating (outdoor application)

Blue Moon Design by Jochen Schmiedem

Pool square, with support frame for panel, with overflow
5 mm sanitary acrylic

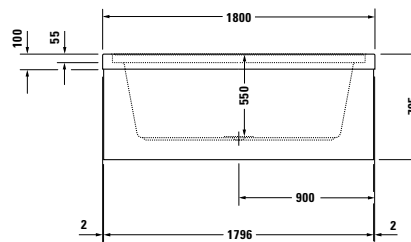
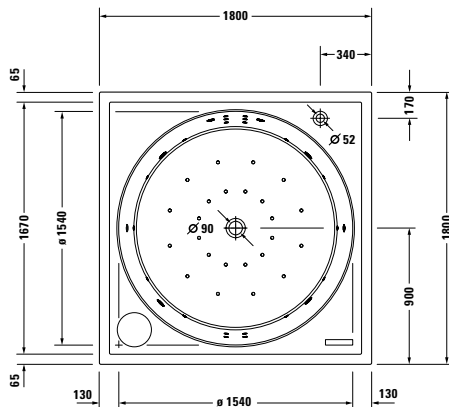

Length mm	Width mm	Depth mm	Capacity l	Weight kg	Model-No.	Euro
1800	1800	550	730	230,0		White - 00
Pool						
Combi-Pool					710169 00 8 00 0000	
Modules for pool						
Additional modules for Combi-Pool				Module-No.		
Water supply through inlet jet (only for indoor)				09		
Ground plate				10		
Integrated filling (only for indoor)				11		
Necessary accessories for pool						
Wooden inlay, Teak (decor), with hinged cover					790880 00 0 01 0000	
Acrylic inlay, with hinged cover					790867 00 0 01 0000	
Acrylic panel, for corner left / right					701059 00 0 00 0000	
Acrylic panel, for back-to-wall version					701060 00 0 00 0000	
Acrylic panel, for freestanding version					701061 00 0 00 0000	
Acrylic panel, with insulation, for corner left / right, (for outdoor application)					701091 00 0 00 0000	
Acrylic panel, with insulation, for back-to-wall version, (for outdoor application)					701092 00 0 00 0000	
Acrylic panel, with insulation, for freestanding version, (for outdoor application)					701093 00 0 00 0000	
Suitable panels s.p. 471						

continued on following page









Blue Moon Design by Jochen Schmiedem

Pool square, with support frame for panel, with overflow
5 mm sanitary acrylic

Length mm	Width mm	Depth mm	Capacity l	Weight kg	Model-No.	Euro	
						White	- 00
1800	1800	550	730	230,0			
Pool							
Combi-Pool (white -00)						710169 00 8 00 0000	
Accessories for pool							
Headrest, white						790004 00 0 00 0000	
Rubber profile						790104 00 0 00 0000	
Bathtub anchors, (4 pcs.) *						790123 00 0 00 0000	
Footrest, length 180 mm						790885 00 0 00 0000	
Footrest, length 250 mm						790886 00 0 00 0000	
Tub cover						790884 00 0 00 0000	
Storage holder for tub cover, for Blue Moon whirltubs and pools, left						791805 00 0 00 6600	
Storage holder for tub cover, for Blue Moon whirltubs and pools, right						791806 00 0 00 6600	
Insulating buoyant film						791808 00 0 00 0000	
Persenning, for corner left / right						791803 00 0 00 0000	
Persenning, for back-to-wall version						791804 00 0 00 0000	
Persenning, for freestanding version						790878 00 0 00 0000	
Bench / support rail, Teak (decor)						790887 00 0 00 0000	
Bench / support rail, Teak (decor), with clothes rail						790888 00 0 00 0000	
Bench / support rail, Teak (decor), with handhold						790889 00 0 00 0000	
Bench / support rail, Teak (decor), with clothes rail, with handhold						790890 00 0 00 0000	
Replacement cartridge, for filter						790598 00 0 00 0000	
Control panel, with languages EN, NL, DA, NO, SV, (instead of standard equipment)						791859 00 0 00 0000	
Control panel, with languages EN, PL, CZ, SK, HU, TR, (instead of standard equipment)						791860 00 0 00 0000	

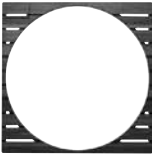
Infobox: * We recommend to use 4 bathtub anchors for the installation / The length of the rubber profile # 790104 is not sufficient for Blue Moon 1800 x 1800 mm. Please use two pieces







Blue Moon Accessories Design by Jochen Schmiedem

	Description	Model-No.	Euro
	Bathtub anchors * (4 pcs.) for mounting and support of bathtubs and shower trays	790123 00 0 00 0000	
Infobox: * We recommend to use 4 bathtub anchors for the installation			
	Rubber profile or noise reduction and sealing against moisture length: 3300 mm	790104 00 0 00 0000	
	Headrest white, material: polyurethane for Blue Moon 1800 x 1800 mm	790004 00 0 00 0000	
	Footrest for Blue Moon 1800 x 1800 mm length 180 mm length 250 mm	790885 00 0 00 0000	790886 00 0 00 0000
	Wooden inlay Teak (decor), with hinged cover, also suitable for outdoor application for Blue Moon pool 1800 x 1800 mm	790880 00 0 01 0000	
	Acrylic inlay with hinged cover for Blue Moon pool 1800 x 1800 mm and bathtub 1800 x 1800 mm with waste and overflow with base inlet	790867 00 0 01 0000	
	Tub cover for Blue Moon 1800 x 1800 mm	790884 00 0 00 0000	
	Storage holder for tub cover for Blue Moon whirltubs and pools, 1 pair, material: stainless steel high gloss polished left right	791805 00 0 00 6600	791806 00 0 00 6600
	Insulating buoyant film for Blue Moon pool 1800 x 1800 mm	791808 00 0 00 0000	
	Control panel with languages EN, NL, DA, NO, SV, (instead of standard equipment) for pools	791859 00 0 00 0000	

Blue Moon Accessories Design by Jochen Schmiedem

	Description	Model-No.	Euro
	Control panel with languages EN, PL, CZ, SK, HU, TR, (instead of standard equipment) for pools	791860 00 0 00 0000	
	Persenning for corner left / right for Blue Moon pool 1800 x 1800 mm	791803 00 0 00 0000	
	Persenning for back-to-wall version for Blue Moon pool 1800 x 1800 mm	791804 00 0 00 0000	
	Persenning for freestanding version for Blue Moon pool 1800 x 1800 mm	790878 00 0 00 0000	
	Bench / support rail Teak (decor), also suitable for outdoor application for Blue Moon 1800 x 1800 mm	790887 00 0 00 0000	
	Bench / support rail Teak (decor), with clothes rail, also suitable for outdoor application for Blue Moon 1800 x 1800 mm	790888 00 0 00 0000	
	Bench / support rail Teak (decor), with handhold, also suitable for outdoor application for Blue Moon 1800 x 1800 mm	790889 00 0 00 0000	
	Bench / support rail Teak (decor), with clothes rail, with handhold, also suitable for outdoor application for Blue Moon 1800 x 1800 mm	790890 00 0 00 0000	

Blue Moon Accessories Design by Jochen Schmiedem

	Description	Model-No.	Euro
	Acrylic panel for corner left / right for Blue Moon 1800 x 1800 mm	701059 00 0 00 0000	
	Acrylic panel with insulation, for corner left / right, (for outdoor application) for Blue Moon pool 1800 x 1800 mm	701091 00 0 00 0000	
	Acrylic panel for back-to-wall version for Blue Moon 1800 x 1800 mm	701060 00 0 00 0000	
	Acrylic panel with insulation, for back-to-wall version, (for outdoor application) for Blue Moon pool 1800 x 1800 mm	701092 00 0 00 0000	
	Acrylic panel for freestanding version for Blue Moon 1800 x 1800 mm	701061 00 0 00 0000	
	Acrylic panel with insulation, for freestanding version, (for outdoor application) for Blue Moon pool 1800 x 1800 mm	701093 00 0 00 0000	
	Replacement cartridge for filter for Blue Moon pool 1800 x 1800 mm	790598 00 0 00 0000	

Blue Moon Design by Jochen Schmiedem



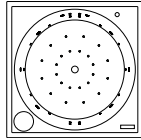

Panels for pool



1800 x 1800 mm



710169

		Model-No. Furniture panel indoor	Model-No. Acrylic panel indoor	Model-No. Furniture panel outdoor	Model-No. Acrylic panel outdoor
	Corner left	# BM 8761	# 701059	# BM 8763	# 701091
	Corner right	# BM 8761	# 701059	# BM 8763	# 701091
	Back-to-wall	# BM 8762	# 701060	# BM 8765	# 701092
	Freestanding	# BM 8760	# 701061	# BM 8764	# 701093

Blue Moon Design by Jochen Schmiedem

Product Information

Panel	Decor (Pricegroup 1)	53 Chestnut Dark	High-density-fiberboard, with laminate (HPL) pressed on both sides. Surfaces resistant to moisture.
	Real wood veneer (Pricegroup 2)	13 American Walnut 24 Macassar	High-density-fiberboard, with real wood veneer pressed on one side and laminate (HPL) pressed on other side. Real wood veneer is a natural material, differences in colour and structure may occur. Surfaces resistant to moisture.
	Real wood veneer (Pricegroup 3)	62 Anthracite Oak	High-density-fiberboard, with real wood veneer pressed on one side and laminate (HPL) pressed on other side. Real wood veneer is a natural material, differences in colour and structure may occur. Surfaces resistant to moisture.
	Decor Outdoor Version (Pricegroup 4)	01 Cherry Tree 02 Wengé	Compact laminated panel, with laminate (HPL) pressed on one side. This HPL is developed for outdoor use. It is resistant to UV-radiation and has an overall weatherability.

Blue Moon Design by Jochen Schmiedem

Description	mm	Model-No.	Euro			
			Pricegroup 1	Pricegroup 2	Pricegroup 3	Pricegroup 4
Panel for corner right/ for corner left, indoor						
for # 700169 (1800 x 1800 mm)	1796 x 1796	BM 8761				
Panel for back-to-wall, indoor						
for # 700169 (1800 x 1800 mm)	1796 x 1792	BM 8762				
Panel for freestanding version, indoor						
for # 700169 (1800 x 1800 mm)	1792 x 1792	BM 8760				
Panel for corner right/ for corner left, outdoor						
for # 700169 (1800 x 1800 mm)	1796 x 1796	BM 8763				
Panel for back-to-wall, outdoor						
for # 700169 (1800 x 1800 mm)	1796 x 1792	BM 8765				
Panel for freestanding version, outdoor						
for # 700169 (1800 x 1800 mm)	1792 x 1792	BM 8764				

Sundeck Design by E00S

Ordering Sample Pool

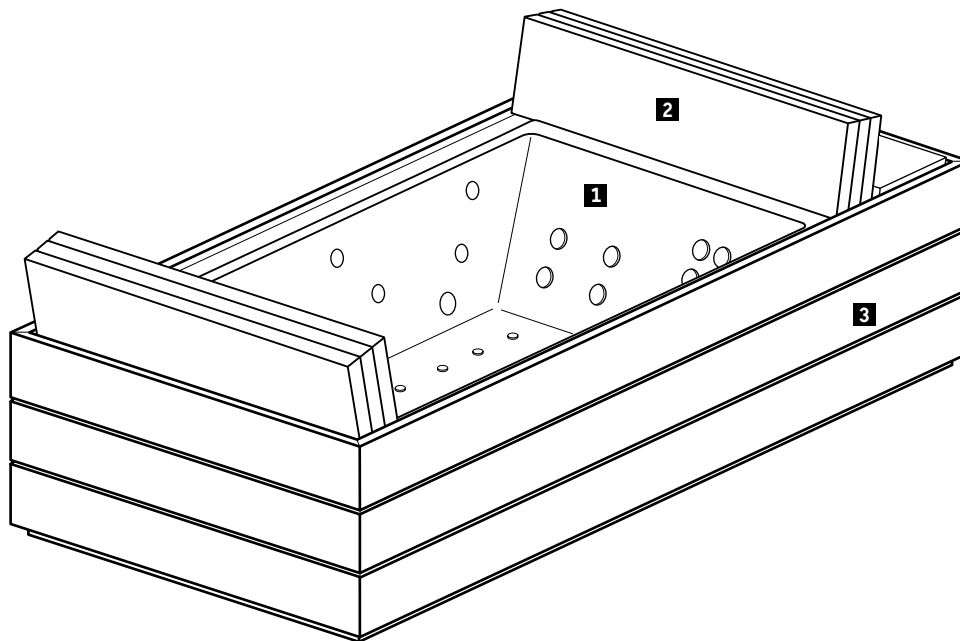

Description	Remark	Quantity	Model-No.
1 Sundeck Pool, corner right with ground plate	2410 x 1315 mm	1	# 710359 00 8 00 0000 Module-No. 10
2 Sundeck foldable relaxing deck	for pool 2410 x 1315 mm	1	# 790875 00 0 00 0000
3 Panel with insulation for freestanding version	for pool 2410 x 1315 mm	1	# SU 8693
Persenning (no illustration)	for pool 2410 x 1315 mm	1	# 791870 00 0 00 0000

Additional information:

The following are always recommended in poolsystems to save on energy consumption:

- insulating buoyant film (indoor application)
- insulating buoyant film and persenning (outdoor application)
- poolsystem with ground plate (outdoor application)
- panels without insulating (sufficient for indoor application)
- panels with insulating (outdoor application)

Sundeck Design by E00S

Pool corner left, rectangle, with support frame for panel, with two backrest slopes, incl. fixation for foldable relaxing deck
5 mm sanitary acrylic

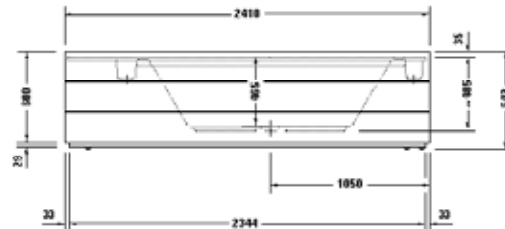
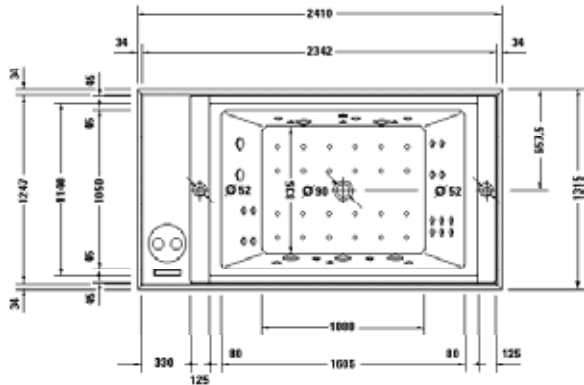

Length mm	Width mm	Depth mm	Capacity l	Weight kg	Model-No.	Euro
2365	1270	470	493	233,0		White - 00
Pool						
Combi-Pool (white -00)						710358 00 8 00 0000
Modules for Pool						
Additional modules for Combi-Pool				Module-No.		
Water supply through inlet jet (only for indoor)				09		
Ground plate				10		
Integrated filling (only for indoor)				11		
Necessary accessories for pool						
Foldable relaxing deck, cushioned, white						790875 00 0 00 0000
Suitable panels s.p. 478						
Accessories for pool						
Step, cushioned, white						790832 00 0 00 0000
Bolster, white						790002 00 0 00 0000
Insulating buoyant film						791809 00 0 00 0000
Persenning, for freestanding version, for panel without pillar, blue						791870 00 0 00 0000
Persenning, for corner left, for panel without pillar, blue						791867 00 0 00 0000
Persenning, for back-to-wall version, for panel without pillar, blue						791869 00 0 00 0000
Replacement cartridge, for filter						790598 00 0 00 0000
Control panel, with languages EN, NL, DA, NO, SV, (instead of standard equipment)						791859 00 0 00 0000
Control panel, with the languages EN, PL, CZ, SK, HU, TR, (instead of standard equipment)						791860 00 0 00 0000

Infobox: No overflow hole, but overflow channel / Tub only available with foldable relaxing deck

Sundeck Design by E00S

Pool corner right, rectangle, with support frame for panel, with two backrest slopes, incl. fixation for foldable relaxing deck
5 mm sanitary acrylic

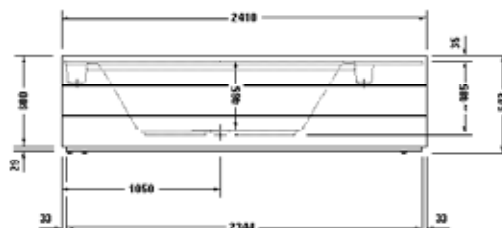
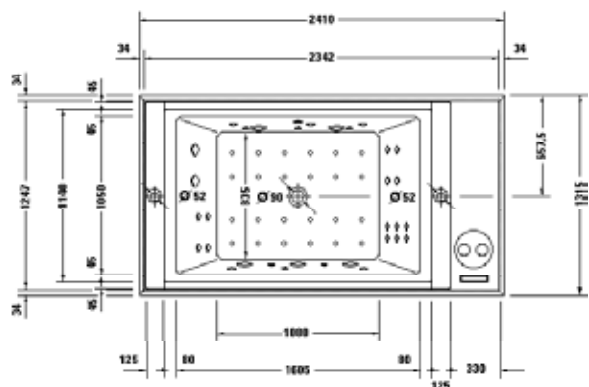

Length mm	Width mm	Depth mm	Capacity l	Weight kg	Model-No.	Euro
2365	1270	470	493	233,0		White - 00
Pool						
Combi-Pool (white -00)					710359 00 8 00 0000	
Modules for Pool						
Additional modules for Combi-Pool				Module-No.		
Water supply through inlet jet (only for indoor)				09		
Ground plate				10		
Integrated filling (only for indoor)				11		
Necessary accessories for pool						
Foldable relaxing deck, cushioned, white					790875 00 0 00 0000	
Suitable panels s.p. 478						
Accessories for pool						
Step, cushioned, white					790832 00 0 00 0000	
Bolster, white					790002 00 0 00 0000	
Insulating buoyant film					791809 00 0 00 0000	
Persenning, for freestanding version, for panel without pillar, blue					791870 00 0 00 0000	
Persenning, for corner right, for panel without pillar, blue					791868 00 0 00 0000	
Persenning, for back-to-wall version, for panel without pillar, blue					791869 00 0 00 0000	
Replacement cartridge, for filter					790598 00 0 00 0000	
Control panel, with languages EN, NL, DA, NO, SV, (instead of standard equipment)					791859 00 0 00 0000	
Control panel, with the languages EN, PL, CZ, SK, HU, TR, (instead of standard equipment)					791860 00 0 00 0000	

Infobox: No overflow hole, but overflow channel / Tub only available with foldable relaxing deck

Sundeck Accessories Design by E00S

	Description	Model-No.	Euro
	Bolster white for Sundeck	790002 00 0 00 0000	
	Step cushioned, white for Sundeck	790832 00 0 00 0000	
	Foldable relaxing deck cushioned, white for # 700196, 700197, 710358, 710359	790875 00 0 00 0000	
	Insulating buoyant film for Sundeck pool	791809 00 0 00 0000	
	Control panel with languages EN, NL, DA, NO, SV, (instead of standard equipment) for pools	791859 00 0 00 0000	
	Control panel with languages EN, PL, CZ, SK, HU, TR, (instead of standard equipment) for pools	791860 00 0 00 0000	
	Persenning for panel without pillar, for # 710358, 710359, blue for freestanding version	791870 00 0 00 0000	
	for corner left	791867 00 0 00 0000	
	for corner right	791868 00 0 00 0000	
	for back-to-wall version	791869 00 0 00 0000	
	Replacement cartridge for filter for pool	790598 00 0 00 0000	

Sundeck Design by E00S



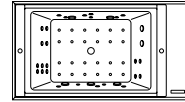
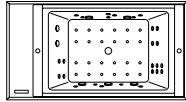

Panels for pools



710358



710359

Model-No. panel		Indoor	Outdoor	Indoor	Outdoor
	Corner left	# SU 8680	# SU 8690		
	Corner right			# SU 8681	# SU 8691
	Back-to-wall	# SU 8682	# SU 8692	# SU 8682	# SU 8692
	Freestanding	# SU 8683	# SU 8693	# SU 8683	# SU 8693

Sundeck Design by E00S

Product Information

Panel	Decor (Pricegroup 1)	53 Chestnut Dark	Compact laminated panel, with laminate (HPL) pressed on one side. Surfaces resistant to moisture.
	Real wood veneer (Pricegroup 2)	13 American Walnut 24 Macassar	Compact laminated panel, with real wood veneer pressed on one side. Real wood veneer is a natural material, differences in colour and structure may occur. Surfaces resistant to moisture.
	Real wood veneer (Pricegroup 3)	62 Anthracite Oak	Compact laminated panel, with real wood veneer pressed on one side. Real wood veneer is a natural material, differences in colour and structure may occur. Surfaces resistant to moisture.
	Decor Outdoor Version (Pricegroup 4)	01 Cherry Tree 02 Wengé	Compact laminated panel, with laminate (HPL) pressed on one side. This HPL is developed for outdoor use. It is resistant to UV-radiation and has an overall weatherability.
Folding Relaxing Deck Step (cushioned) Bolster		00 White	Base board, sheathed in foamed plastic material and covered with marine-quality protective padding.

Sundeck Design by E00S

Description	mm	Model-No.	Euro			
			Pricegroup 1	Pricegroup 2	Pricegroup 3	Pricegroup 4
Panel for corner left, indoor						
for # 710358 (2365 x 1270 mm)	2410 x 1315	SU 8680				
Panel for corner right, indoor						
for # 710359 (2365 x 1270 mm)	2410 x 1315	SU 8681				
Panel for back-to-wall, indoor						
for # 710358 (2365 x 1270 mm), for # 710359 (2365 x 1270 mm)	2410 x 1315	SU 8682				
Panel for freestanding version, indoor						
for # 710358 (2365 x 1270 mm), for # 710359 (2365 x 1270 mm)	2410 x 1315	SU 8683				
Panel for corner left, outdoor						
for # 710358 (2365 x 1270 mm)	2410 x 1315	SU 8690				
Panel for corner right, outdoor						
for # 710359 (2365 x 1270 mm)	2410 x 1315	SU 8691				
Panel for back-to-wall, outdoor						
for # 710358 (2365 x 1270 mm), for # 710359 (2365 x 1270 mm)	2410 x 1315	SU 8692				
Panel for freestanding version, outdoor						
for # 710358 (2365 x 1270 mm), for # 710359 (2365 x 1270 mm)	2410 x 1315	SU 8693				

Sauna Product Information

Inipi

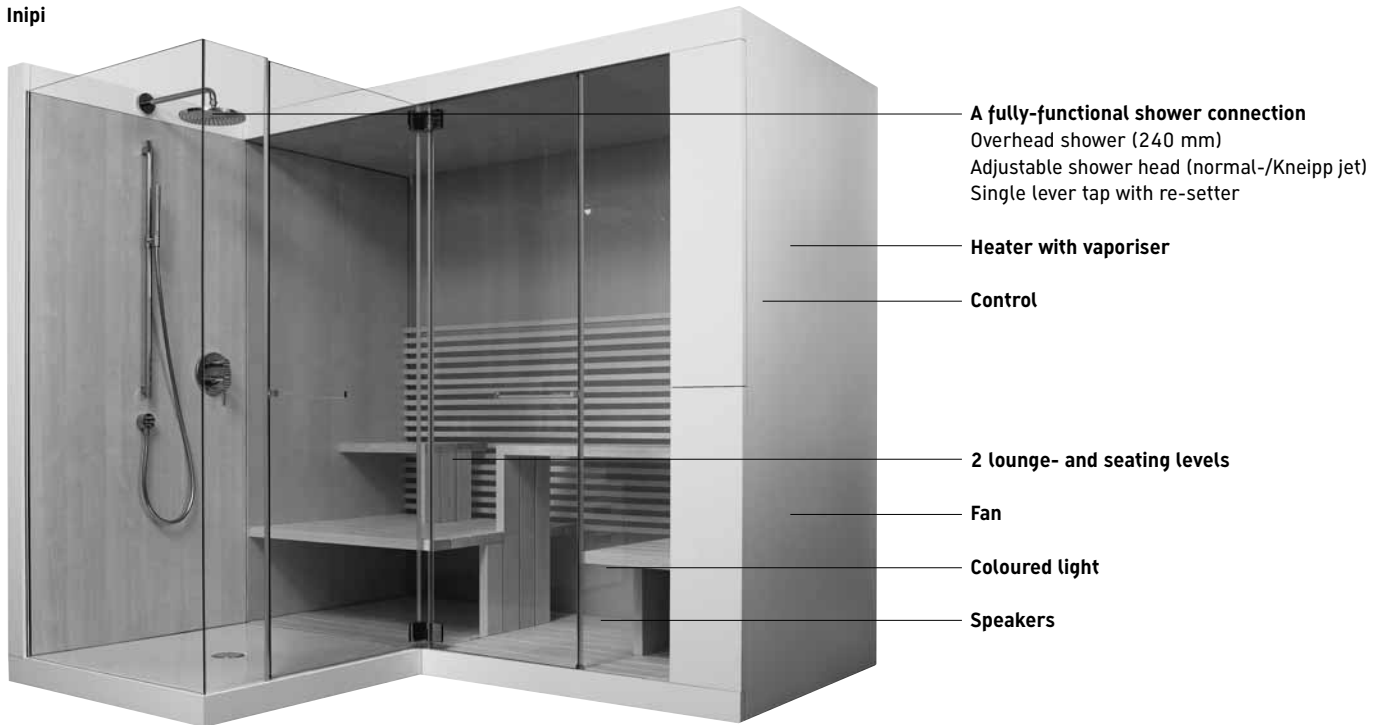

A fully-functional shower connection
Overhead shower (240 mm)
Adjustable shower head (normal-/Kneipp jet)
Single lever tap with re-setter

Heater with vaporiser

Control

2 lounge- and seating levels

Fan

Coloured light

Speakers

All Inipi sauna models have the following standard equipment:

- heater 3.8 kW
- vaporising unit with ceramic sauna stones 1 kW
- coloured light
- control panel, hidden behind a panel, with 2" display
- remote control in stone-optics and surfaces with backlit keys and large 2" display with charging unit (contact-free charging)
- user-friendly menu navigation
- individual temperature- and air humidity settings and programmes
- direct selection of coloured light programmes or permanent colours
- sound module with radio, sound settings and AUX connection
- direct selection of predefined scenarios (mix of music, soundscapes, coloured lights, temperature and air humidity)
- pouring of water at the touch of a button
- various language settings
- removable bucket for pouring water
- Inipi upper seat element, aspen wood
- Inipi lower seat element, aspen wood
- 2 Inipi headrests, aspen wood (not for # 7509** and # 7510**)

Those models with a shower connection have the following Hansgrohe taps included in the delivery:

- overhead shower (240 mm)
- adjustable shower head (normal-/Kneipp jet)
- shower bar with shower hose
- single lever tap with re-setter

Accessories

- stepping platform for Inipi Ama with shower connection front
- surcharge for sauna roof in furniture surface

Versions

All Inipi models are available as both back-to-wall and corner versions as well as a freestanding version complete with a rear wall. The exterior casing can be made using different furniture surfaces ranging from décor to high gloss to real wood veneer surfaces.

All of the technology is installed on an extendable unit. Hidden behind the hinged front panel on the upper right is the control panel, a removable bucket for pouring water, a shelf and an audio connection for mp3 or other music players.

Power supply

220-240V 50/60Hz

Sauna Product Information

Inipi

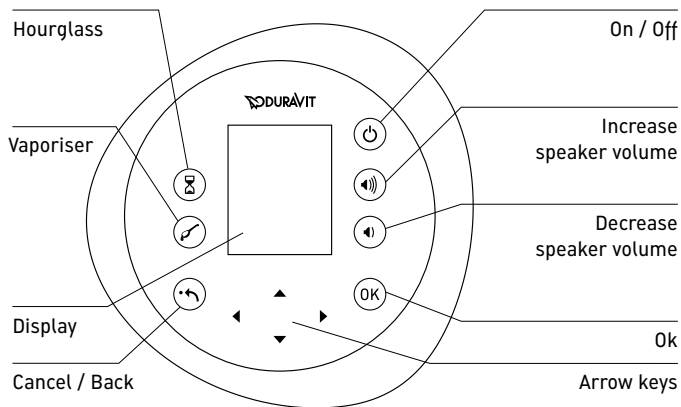

Remote control with display

The simple and logical menu navigation system on the remote control can be used to select and control all sauna functions. In addition, personal user settings can be saved in a user profile and different users can select their preferred programme with the touch of a button. The remote control can be charged contact-free by placing it on the loading unit.

Control panel with display

The control panel, integrated into a side wall, is hidden under a panel. Just like the remote control, this control panel may be used to select and start all sauna functions.

Heater with vaporiser

The sauna heater is hidden behind a cover on the right hand side of the sauna and is used to heat up the sauna from room temperature to the desired temperature. The temperature may be set independently and combined with the desired air humidity.

Pouring of water

The vaporisation function is integrated into the heater. When triggering the pouring of water by selecting the correct key on the remote control or the control panel water flows on the ceramic sauna stones of the vaporiser.

Coloured light

A coloured light system is integrated into the sauna as standard. This is made up of LED elements that light up the entire rear wall of the sauna. You may choose between single colours or a colour program and vary the intensity of the colours.

Sound

The sauna has a sound system which may be used while having a sauna or when the sauna is not in use. You may choose from various sound settings, the radio or your favourite music.

Radio

Radio with 3 disc spaces. Automatic and manual search in MW and FM frequencies.

Predefined scenarios

5 predefined scenarios (Desert, Jungle, Asia, Mediterranean, Indian) provide thematic soundscapes combined with a suitable temperature, air humidity and coloured light.

Sauna Product Information

Inipi B

2365 x 1170 x 2130 mm # 7511** / 2365 x 1186 x 2130 mm # 7512**

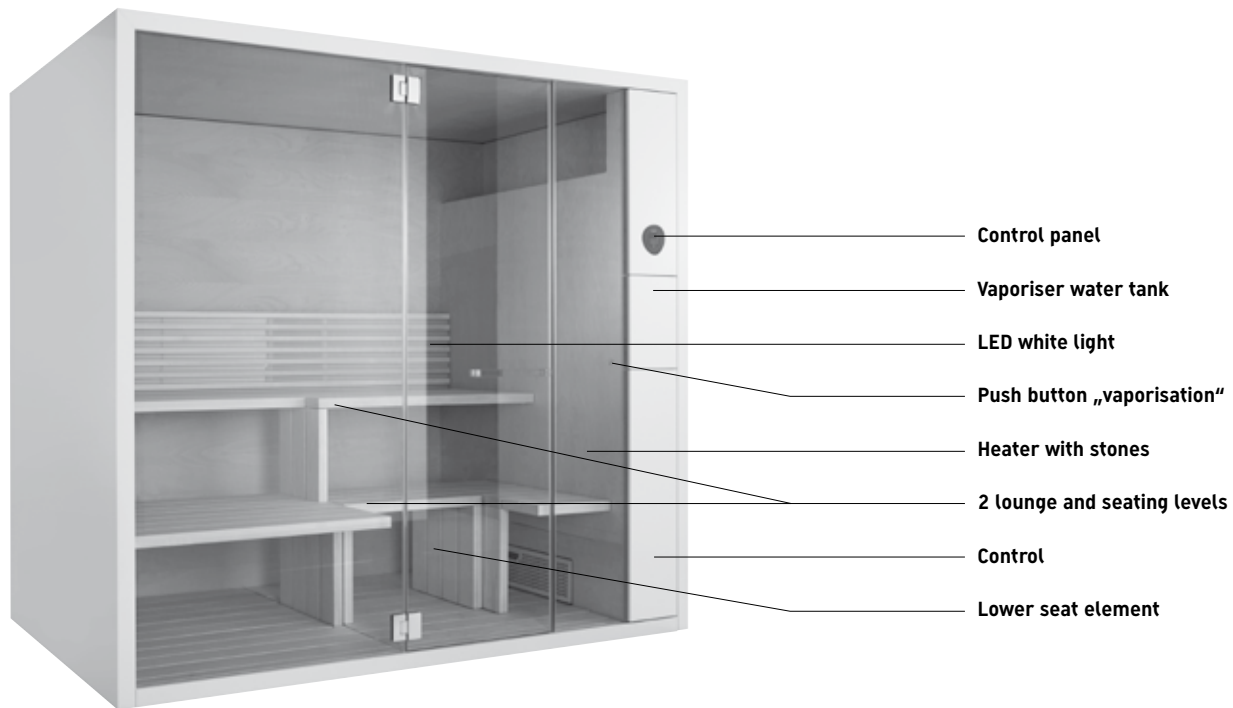

Inipi B Super Compact 1175 x 1170 x 2130 mm # 7513** / # 7514**

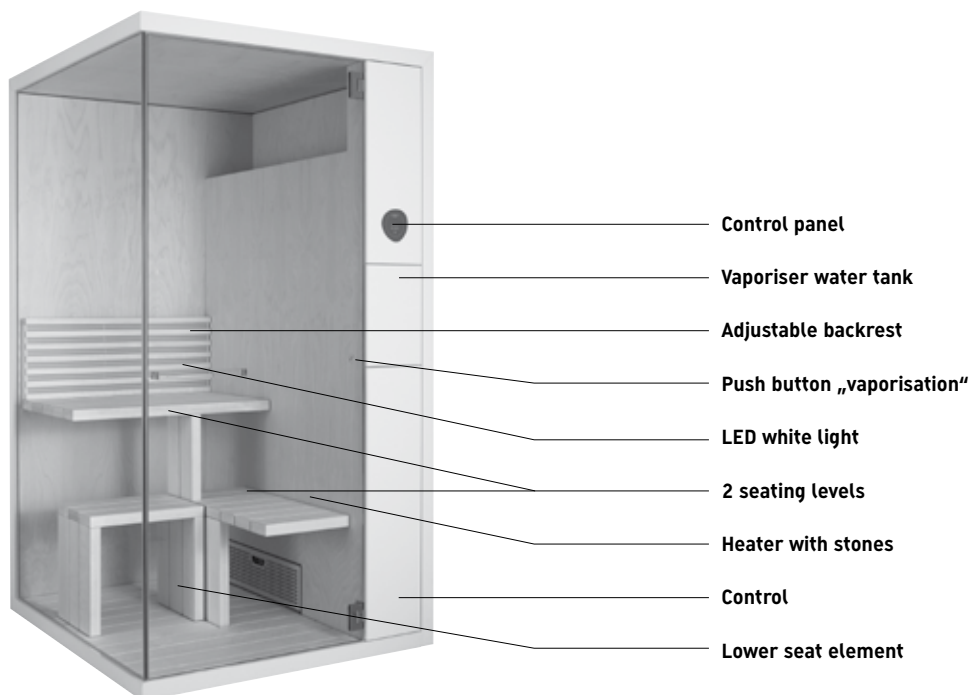

** Please add the furniture colour code at the 5th and 6th digit code when ordering / Furniture surfaces see end of price list

Sauna Product Information

Inipi B

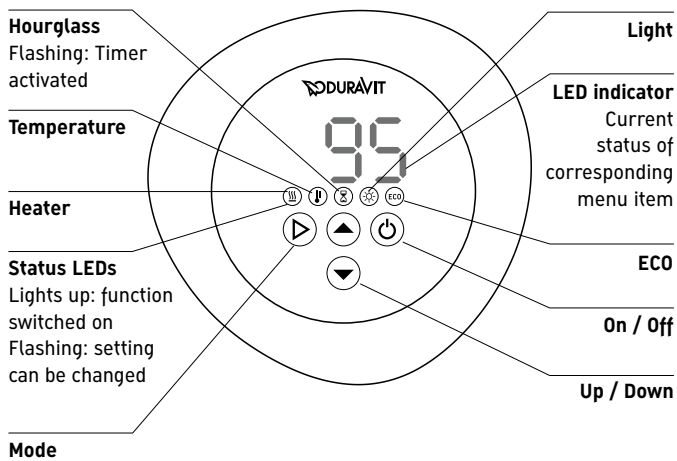

Control panel

The control panel in "stone" optics is integrated in the side wall outside. The control panel may be used to select and start all functions except the vaporisation.

Heater with stones

The heater with stones is hidden in the side wall. The timer allows you to start the heater automatically within the next 24 hours. During the cooling down and relaxing phases an ECO mode for the heater can be selected to save heat energy.

Vaporisation

Vaporisation is triggered by pressing the push button „vaporisation“ inside the side wall. The intensity of the vaporisation depends on the time the push button is pressed.

LED white light

Inipi B has a LED white light as standard. The LED elements illuminate the backrest of the upper seating level.

Inipi B sauna models have the following standard equipment:

- Heater with stones 6kW (# 7511** and # 7512**) or 3,6kW (# 7513** and # 7514**)
- Backrest illuminated with LED white light, backrest of # 7513** and # 7514** adjustable
- Control panel outside
- Vaporisation by push button inside
- Removable vaporiser water tank behind furniture cover outside
- Headrest, aspen wood (not for # 7513** and # 7514**)
- Lower seat element, aspen wood

Accessories for # 7511** / # 7512**

- Surcharge for roof in furniture surface



Power supply

- # 7511** / # 7512** 380-415V 50/60Hz
- # 7513** / # 7514** 220-240V 50/60Hz

Sauna Product Information

	Inipi	Inipi B	Inipi B Super Compact
Material of interior			
Seating made of aspen	●	●	●
Side walls and ceiling made of birch	●	●	●
Rear wall made of birch	-	●	●
Rear wall made of glass	●	-	-
Floor grid made of aspen	●	●	●
Functions			
Individual setting of temperature	●	●	●
Individual setting of air humidity	●	-	-
Vaporisation by button on the inner face of the side wall	-	●	●
Vaporisation by button on remote control or control panel	●	-	-
White light	●	●	●
Coloured light with programmes and individual setting of colours	●	-	-
Sound module with radio, soundscapes and AUX-In connection	●	-	-
Comfort			
Remote control	●	-	-
Timer	●	●	●
ECO function	-	●	●
Hourglass	●	●	●
Removable vaporizer water tank	●	●	●
Adjustable backrest	-	-	●
Extendable unit with technology in the side wall	●	-	-
Specifications			
Rated voltage	220 - 240 V	380 - 415 V	220 - 240 V
Frequency	50/60 Hz	50/60 Hz	50/60 Hz
Max. rated power	4,8 kW	6,6 kW	4,1 kW
Rated power of heater	3,8 kW	6 kW	3,6 kW
Rated power of the vaporising unit	1 kW	-	-
Protection class	IP X5	IP X4	IP X4
Operating temperature	15 - 40°C	15 - 40°C	15 - 40°C

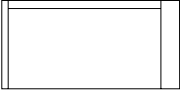
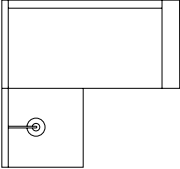
Inipi Design by E00S

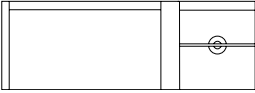
		Back-to-wall and corner version	Freestanding version
	without shower	# 7509	# 7510
	without shower	# 7501	# 7502
	with shower connection front	# 7503	# 7504
	with shower connection left	# 7505	# 7506
	with shower connection right	# 7507	# 7508

Inipi Design by E00S

Product Information

Sauna Platform Sauna roof	Decor (Pricegroup 1)	53 Chestnut Dark	Compressed three-ply chipboard, with laminate (HPL) pressed on both sides. ABS-Edge material.
	Decor (Pricegroup 2)	22 White High Gloss	Compressed three-ply chipboard, with laminate (HPL) pressed on both sides. ABS-Edge material.
	Real wood veneer (Pricegroup 3)	13 American Walnut 24 Macassar 59 Ebony 65 Bleached Oak	Compressed three-ply chipboard, with real wood veneer pressed on both sides. Trim in real wood veneer.

Inipi Design by E00S

Inipi Sauna

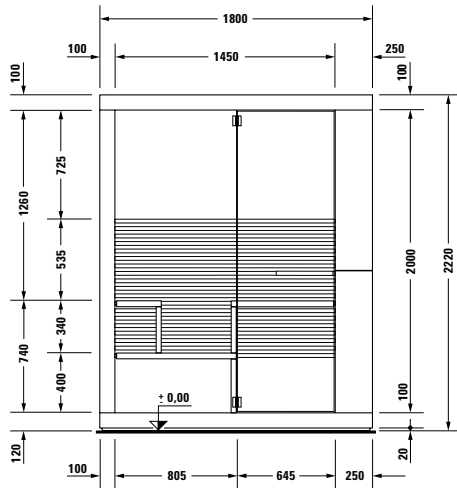
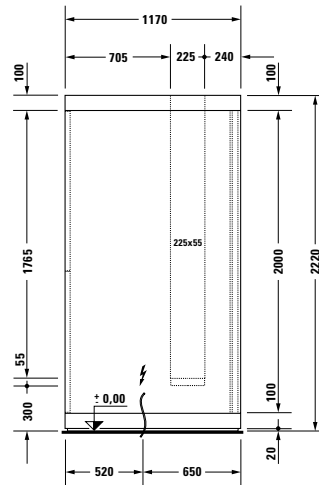
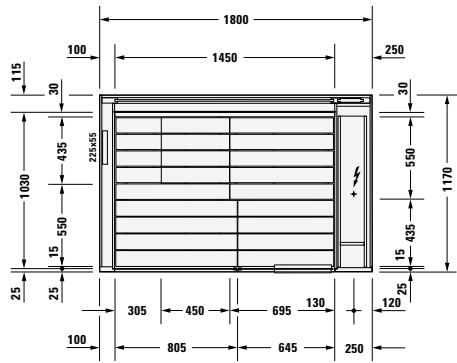

for freestanding version # 7510** width + 16 mm

Inipi Design by E00S

Inipi Sauna

Length mm	Width mm	Height mm	Weight	Model-No.	Euro		
					Pricegroup 1	Pricegroup 2	Pricegroup 3
1800	1170	2220	700,0				
Inipi Sauna							
back-to-wall and corner version				7509* * 00 1 01 1000			
freestanding version				7510* * 00 1 01 1000			
Accessories for Sauna							
Surcharge, for sauna roof, in furniture surface				7917* * 00 0 00 0000			

Infobox: Power supply 220-240V 50/60Hz / Please add the furniture colour code at the 5th and 6th digit code when ordering

Inipi Design by E00S

Inipi Sauna

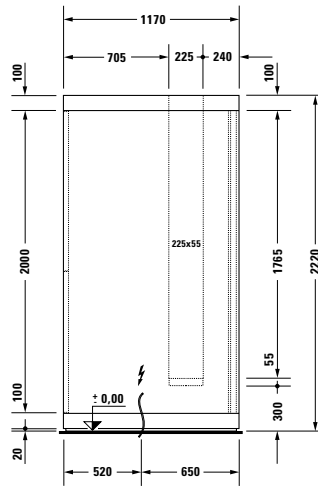
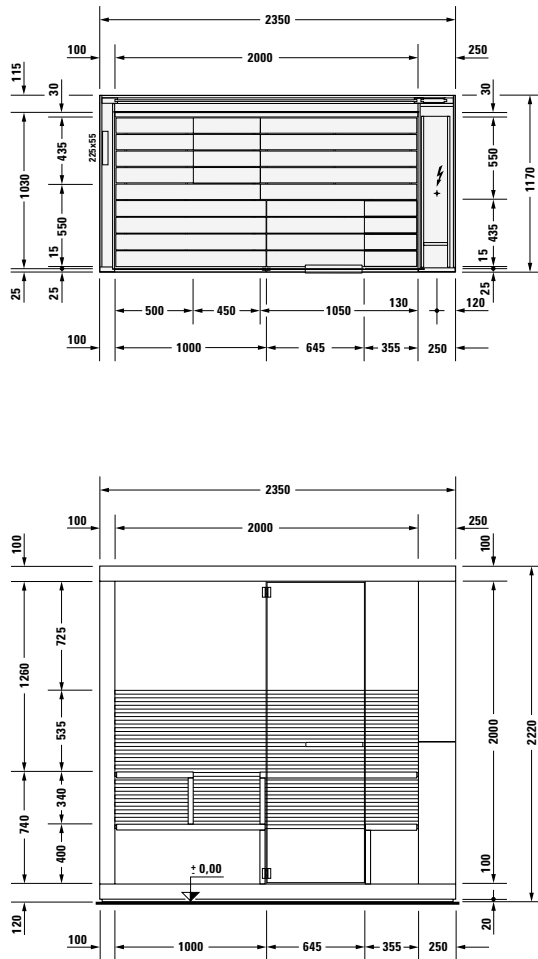

for freestanding version # 7502** width + 16 mm

Inipi Design by E00S

Inipi Sauna

Length mm	Width mm	Height mm	Weight	Model-No.	Euro		
					Pricegroup 1	Pricegroup 2	Pricegroup 3
2350	1170	2220	800,0				
Inipi Sauna							
back-to-wall and corner version				7501* * 00 1 01 1000			
freestanding version				7502* * 00 1 01 1000			
Accessories for Sauna							
Surcharge, for sauna roof, in furniture surface				7916* * 00 0 00 0000			

Infobox: Power supply 220-240V 50/60Hz / Please add the furniture colour code at the 5th and 6th digit code when ordering

Inipi Design by E00S

Inipi Ama Sauna, with shower connection front

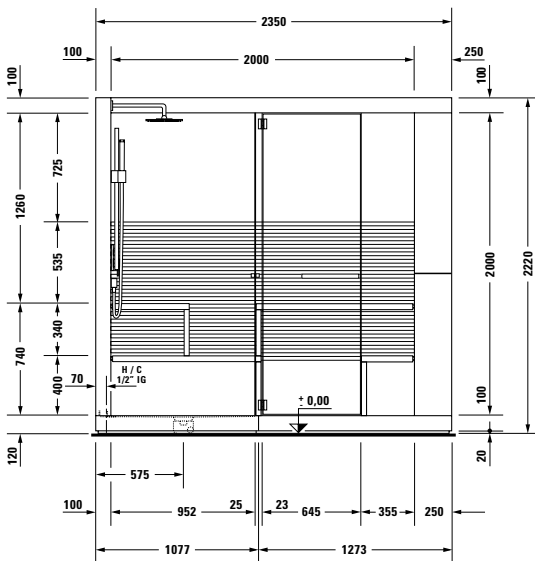
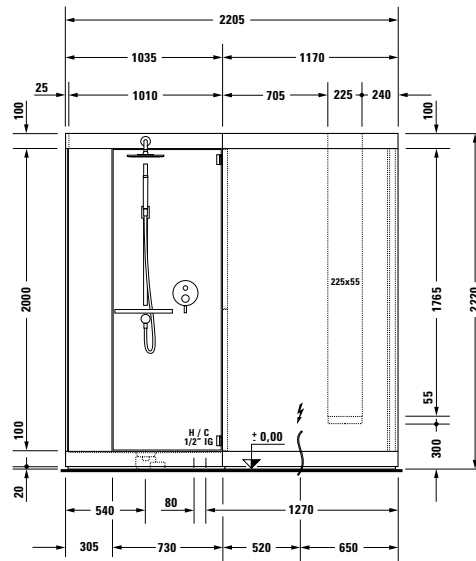
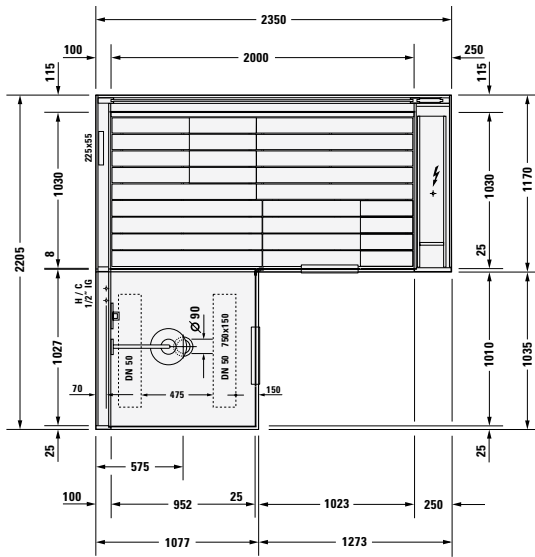

for freestanding version # 7504** width + 16 mm

Inipi Design by E00S

Inipi Ama Sauna, with shower connection front

Length mm	Width mm	Height mm	Weight	Model-No.	Euro		
					Pricegroup 1	Pricegroup 2	Pricegroup 3
2350	2205	2220	950,0				
Inipi Ama Sauna							
back-to-wall and corner version				7503* * 00 1 01 1000			
freestanding version				7504* * 00 1 01 1000			
Inipi Ama Sauna with Antislip							
back-to-wall and corner version				7503* * 00 1 01 1001			
freestanding version				7504* * 00 1 01 1001			
Accessories for Sauna							
Surcharge, for sauna roof, in furniture surface				7916* * 00 0 00 0000			
Platform for shower connection front				7915* * 00 0 00 0000			

Infobox: Power supply 220-240V 50/60Hz / Please add the furniture colour code at the 5th and 6th digit code when ordering
--

Inipi Design by E00S

Inipi Ama Sauna, with shower connection left

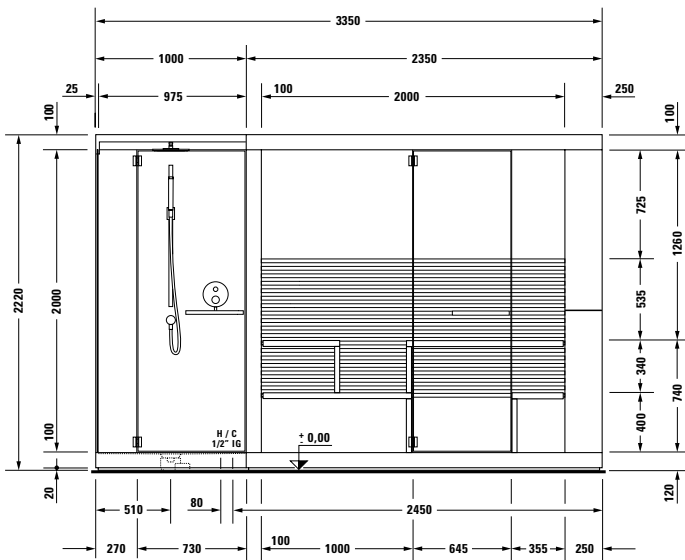
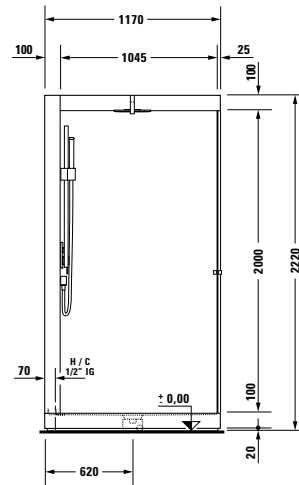
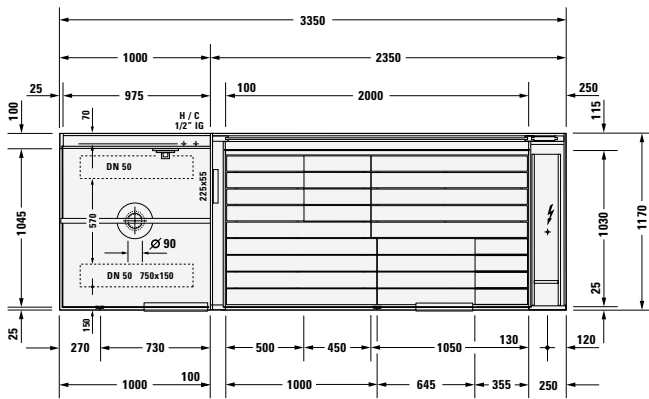

for freestanding version # 7506** width + 16 mm

Inipi Design by E00S

Inipi Ama Sauna, with shower connection left

Length mm	Width mm	Height mm	Weight	Model-No.	Euro		
					Pricegroup 1	Pricegroup 2	Pricegroup 3
3350	1170	2220	950,0				
Inipi Ama Sauna							
back-to-wall and corner version				7505* * 00 1 01 1000			
freestanding version				7506* * 00 1 01 1000			
Inipi Ama Sauna with Antislip							
back-to-wall and corner version				7505* * 00 1 01 1001			
freestanding version				7506* * 00 1 01 1001			
Accessories for Sauna							
Surcharge, for sauna roof, in furniture surface				7916* * 00 0 00 0000			

Infobox: Power supply 220-240V 50/60Hz / Please add the furniture colour code at the 5th and 6th digit code when ordering

Inipi Design by E00S

Inipi Ama Sauna, with shower connection right

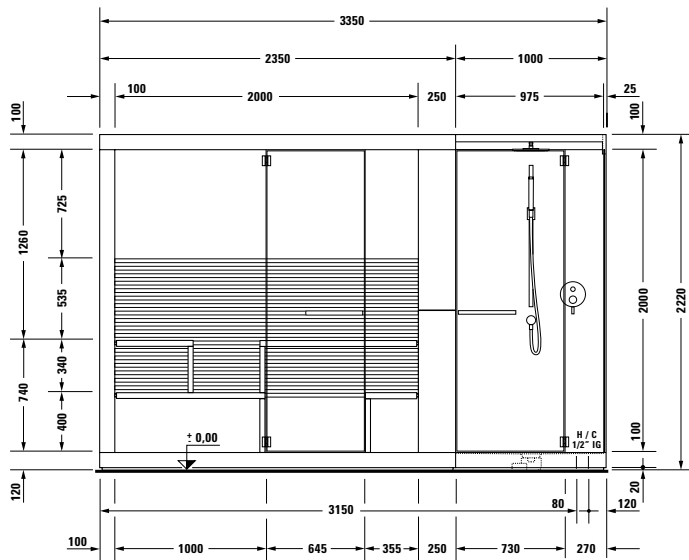
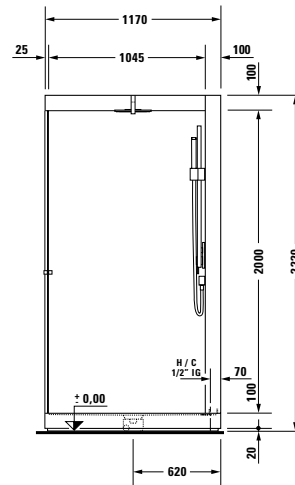
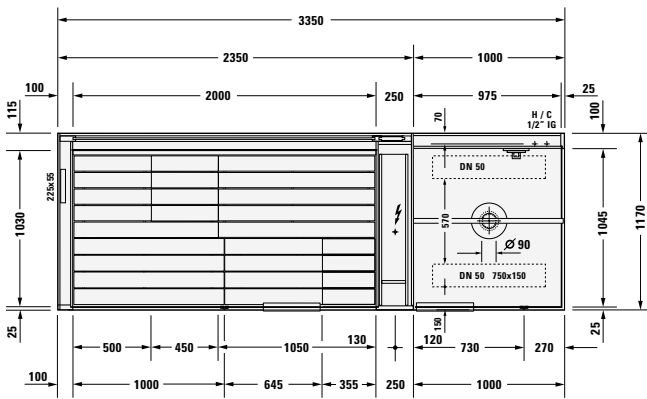

for freestanding version # 7508** width + 16 mm

Inipi Design by E00S

Inipi Ama Sauna, with shower connection right

Length mm	Width mm	Height mm	Weight	Model-No.	Euro		
					Pricegroup 1	Pricegroup 2	Pricegroup 3
3350	1170	2220	950,0				
Inipi Ama Sauna							
back-to-wall and corner version				7507* * 00 1 01 1000			
freestanding version				7508* * 00 1 01 1000			
Inipi Ama Sauna with Antislip							
back-to-wall and corner version				7507* * 00 1 01 1001			
freestanding version				7508* * 00 1 01 1001			
Accessories for Sauna							
Surcharge, for sauna roof, in furniture surface				7916* * 00 0 00 0000			

Infobox: Power supply 220-240V 50/60Hz / Please add the furniture colour code at the 5th and 6th digit code when ordering

Inipi B Design by E00S

Available models

2365 x 1170 x 2130 mm

1175 x 1170 x 2130 mm

Corner left



7511

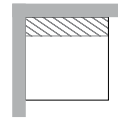

7513

Corner right



7511

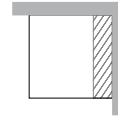

7513

Back-to-wall

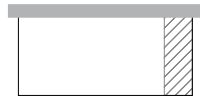

7511

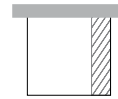

7514

Freestanding



7512*

* Width + 16 mm

Inipi B Design by E00S

Product Information

Sauna Sauna roof	Decor (Pricegroup 1)	22 White High Gloss	High-compressed three-ply chipboard, directly coated with melamine resin decor on both sides. ABS-Edge material.
	Real wood veneer (Pricegroup 2)	13 American Walnut	High-compressed three-ply chipboard, with real wood veneer pressed on one side. Trim in real wood veneer.

Inipi B Design by E00S

Sauna Super Compact

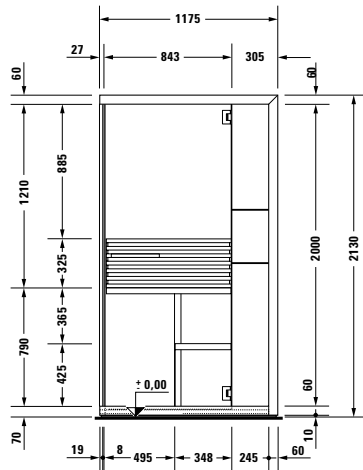
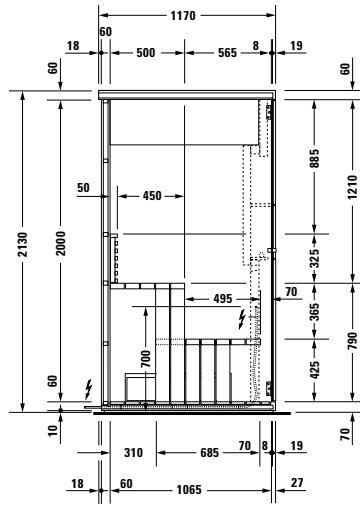
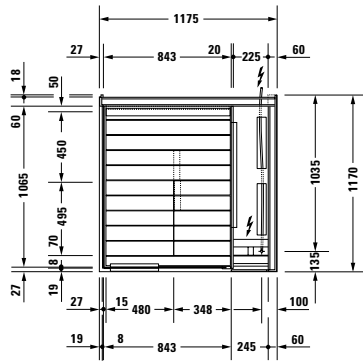

Inipi B Design by E00S

Sauna Super Compact

Length mm	Width mm	Height mm	Weight	Model-No.	Euro	
					Pricegroup 1	Pricegroup 2
1175	1170	2130	350,0			
Sauna Super Compact						
corner				7513* * 00 1 00 1000		
back-to-wall				7514* * 00 1 00 1000		

Infobox: Power supply 220-240V 50/60Hz / Please add the furniture colour code at the 5th and 6th digit code when ordering

Inipi B Design by E00S

Sauna

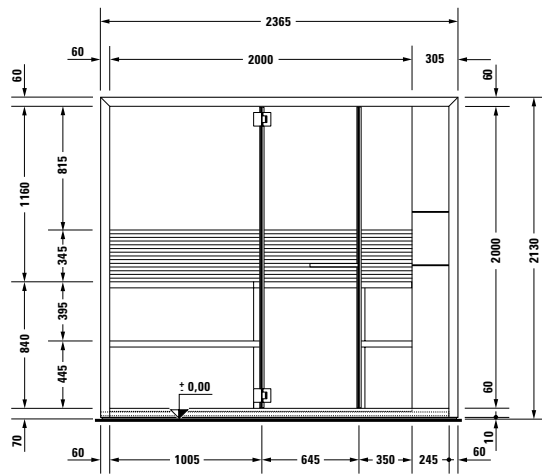
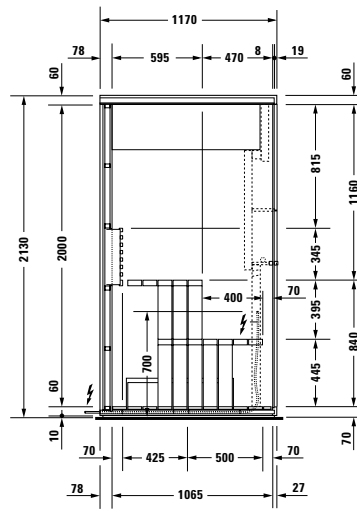
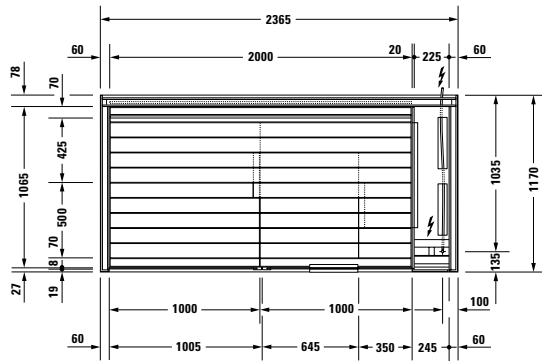

for freestanding version # 7512** width + 16 mm

Inipi B Design by E00S

Sauna

Length mm	Width mm	Height mm	Weight	Model-No.	Euro	
					Pricegroup 1	Pricegroup 2
2365	1170	2130	570,0			
Sauna						
corner and back-to-wall				7511* * 00 1 01 1000		
freestanding				7512* * 00 1 01 1000		
Accessories for Sauna						
Surcharge, for sauna roof, in furniture surface				7920* * 00 0 00 0000		

Infobox: Power supply 380-415V 50/60Hz / Please add the furniture colour code at the 5th and 6th digit code when ordering

St.Trop Product Information



Lighting

Linear white illumination creates a pleasant lighting mood in the cabin.



Overhead shower

With a showerhead diameter of 240 mm, the overhead shower produces a burst of summer rain.



Handshower

The hand shower offers two jets, normal and clear stream.



Steam

The powerful steam generator fills the cabin quickly with dense steam.

St.Trop steam showers have the following standard equipment:

- Illumination
- Stool, Design by Philippe Starck
- Axor Starck taps
- Toughened safety glass
- Full system drainage

Power supply: 220-240V 50/60Hz

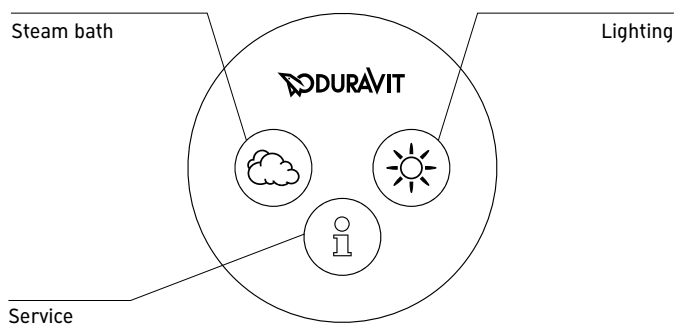

Control panel

By pressing the symbols for steam and illumination, both features can be started and stopped again. The information key displays service notifications and allows to adjust basic settings.

St. Trop Design by Philippe Starck

Product Information

Surface Doorframe	Decor	14 Terra 22 White High Gloss 31 Pine Silver 43 Basalt Matt 49 Graphite Matt 50 Garnet Red Matt 51 Pine Terra 52 European Oak 53 Chestnut Dark 67 Rosewood	Compact laminated panel, with laminate (HPL) pressed on one side. Surface resistant to moisture.
	Real wood veneer	05 Oak 13 Americ. Walnut 24 Macassar 26 Americ. Cherry Tree 59 Ebony 62 Anthracite Oak 65 Bleached Oak	Compact laminated panel, with real wood veneer pressed on one side. Real wood veneer is a natural material, differences in colour and stucture may occur. Surfaces resistant to moisture.
	Lacquer	40 Black High Gloss 56 Silk 85 White High Gloss 86 Cappuccino High Gloss 88 Red High Gloss	Compact laminated panel. Lacquered opaque in several coats on one side. Surface resistant to moisture.

St.Trop Design by Philippe Starck

Steam shower back-to-wall

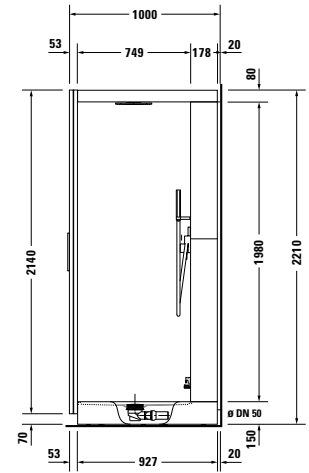
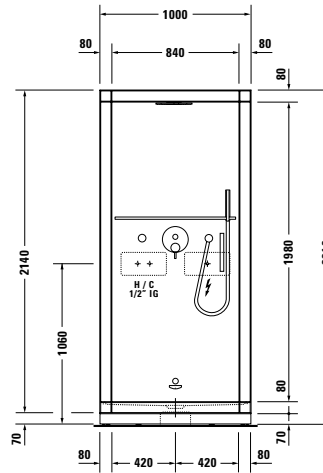
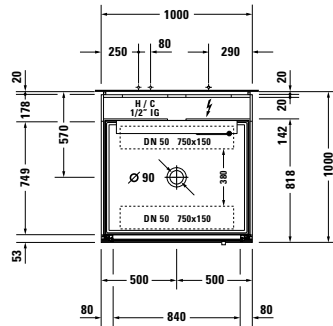

Length mm	Width mm	Height mm	Weight kg	Model-No.	Euro
1000	1000	2210	235,0		
Steam shower					
back-to-wall, hinges left				730009 ** 1 00 1000	
back-to-wall, hinges right				730009 ** 2 00 1000	
Accessories for steam shower					
Replacement limescale filter				790592 00 0 00 0000	

Infobox: Please add the furniture colour code for the surface of the door frame at the 7th and 8th digit code when ordering St.Trop / The stool is included in the delivery

St.Trop Design by Philippe Starck

Steam shower corner left

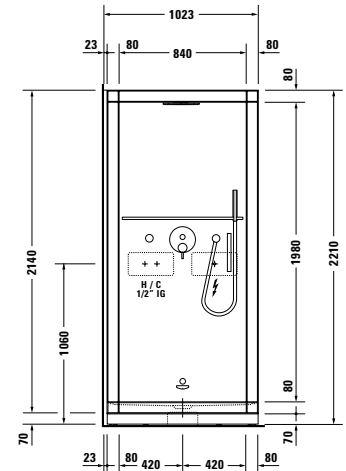
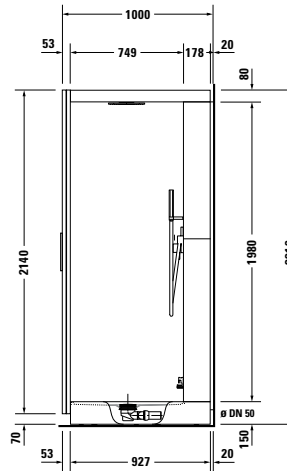
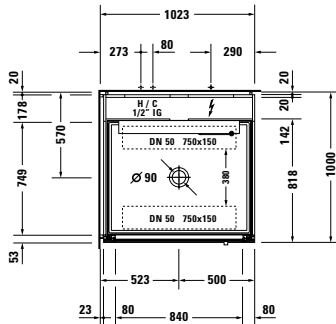

Length mm	Width mm	Height mm	Weight kg	Model-No.	Euro
1000	1000	2210	222,0		
Steam shower					
corner left, hinges left				730010 ** 0 00 1000	
Accessories for steam shower					
Replacement limescale filter				790592 00 0 00 0000	

Infobox: Please add the furniture colour code for the surface of the door frame at the 7th and 8th digit code when ordering St.Trop / The stool is included in the delivery

St.Trop Design by Philippe Starck

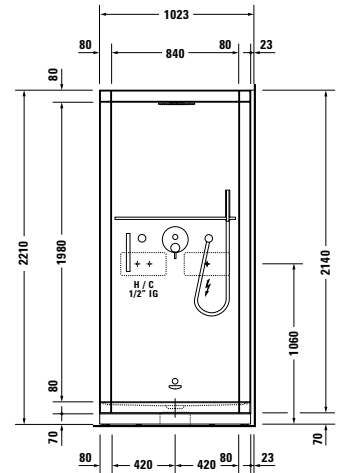
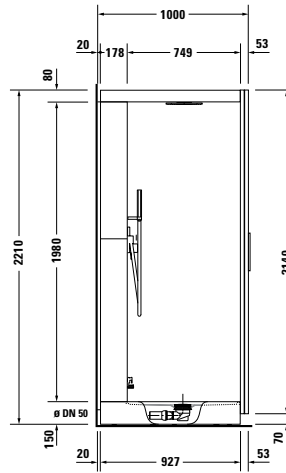
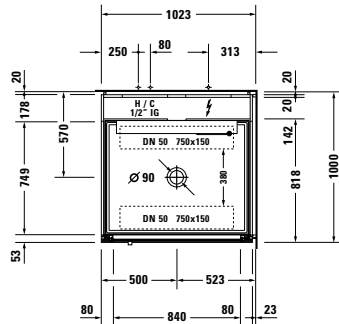

Steam shower corner right



Length mm	Width mm	Height mm	Weight kg	Model-No.	Euro
1000	1000	2210	222,0		
Steam shower					
corner right, hinges right				730011 ** 0 00 1000	
Accessories for steam shower					
Replacement limescale filter				790592 00 0 00 0000	

Infobox: Please add the furniture colour code for the surface of the door frame at the 7th and 8th digit code when ordering St.Trop / The stool is included in the delivery

St.Trop Accessories Design by Philippe Starck

	Description	Model-No.	Euro
	Stool Height: 510 mm for steam shower St.Trop	791846 00 0 00 0000	
	Replacement limescale filter for steam shower St.Trop	790592 00 0 00 0000	









Tub covers Design by E00S

Description	Model-No.	Euro
		
Tub cover, 2 pcs.		
700 x 395 mm, for Darling New # 700238, 700239, D-Code # 700096, Happy D.2 # 700308, 700309, Starck # 700334		
white	791861 00 0 00 0000	
anthracite	791861 68 0 00 0000	
750 x 395 mm, for Starck # 700335		
white	791863 00 0 00 0000	
anthracite	791863 68 0 00 0000	
750 x 425 mm, for 2nd floor # 700075, 700080, Darling New # 700242, 700243, Daro # 700027, D-Code # 700099, 700100, Happy D.2 # 700312, 700313, DuraStyle # 700231, Vero # 700133, 700134		
white	791824 00 0 00 0000	
anthracite	791824 68 0 00 0000	
800 x 395 mm, for Starck # 700338		
white	791865 00 0 00 0000	
anthracite	791865 68 0 00 0000	
800 x 450 mm, for 2nd floor # 700076, 700081, Darling New # 700244, Daro # 700028, D-Code # 700101, Happy D.2 # 700314, Vero # 700135		
white	791828 00 0 00 0000	
anthracite	791828 68 0 00 0000	
Infobox: To cover your bathtub completely, four single elements are required		







Tub covers Design by E00S

Description	Model-No.	Euro
 Tub cover with cut-out for hand shower tube, 2 pcs.		
700 x 395 mm, for Darling New # 700238, 700239, D-Code # 700096, Happy D.2 # 700308, 700309, Starck # 700334		
white	791862 00 0 00 0000	
anthracite	791862 68 0 00 0000	
750 x 395 mm, for Starck # 700335		
white	791864 00 0 00 0000	
anthracite	791864 68 0 00 0000	
750 x 425 mm, for 2nd floor # 700075, 700080, Darling New # 700242, 700243, Daro # 700027, D-Code # 700099, 700100, Happy D.2 # 700312, 700313, DuraStyle # 700231, Vero # 700133, 700134		
white	791825 00 0 00 0000	
anthracite	791825 68 0 00 0000	
800 x 395 mm, for Starck # 700338		
white	791866 00 0 00 0000	
anthracite	791866 68 0 00 0000	
800 x 450 mm, for 2nd floor # 700076, 700081, Darling New # 700244, Daro # 700028, D-Code # 700101, Happy D.2 # 700314, Vero # 700135		
white	791829 00 0 00 0000	
anthracite	791829 68 0 00 0000	
Infobox: To cover your bathtub completely, four single elements are required		









Fittings

	Description	Model-No.	Euro
	Support frame for bathtubs and shower trays, with length > 1000 mm, height-adjustable from 120 - 190 mm 2 pieces	790100 00 0 00 0000	
	Support frame for bathtubs and shower trays, with length > 1500 mm, height-adjustable from 120 - 190 mm 3 pieces	790105 00 0 00 0000	
	Bathtub anchors for mounting and support of bathtubs and shower trays 3 pieces	790103 00 0 00 0000	
	Rubber profile for noise reduction and sealing against moisture length: 3300 mm	790104 00 0 00 0000	
	Waste and overflow Quadroval chrome, for bathtubs with outlet sidewise, length of bowden cable 530 mm outlet diameter 52 mm	790285 00 0 00 1000	
	Waste and overflow Quadroval with water inlet, chrome, for bathtubs with outlet sidewise, length of bowden cable 530 mm, (pipe interrupt necessary) outlet diameter 52 mm	790286 00 0 00 1000	
	Waste and overflow Quadroval chrome, for bathtubs with central outlet, outlet diameter 52 mm length of bowden cable 650 mm length of bowden cable 850 mm	790289 00 0 00 1000 790293 00 0 00 1000	
	Waste and overflow Quadroval with water inlet, chrome, for bathtubs with central outlet, outlet diameter 52 mm, (pipe interrupt necessary) length of bowden cable 650 mm length of bowden cable 850 mm	790290 00 0 00 1000 790294 00 0 00 1000	

Fittings

	Description	Model-No.	Euro
	Waste and overflow Quadroval chrome, for freestanding bathtubs, outlet diameter 52 mm		
	length of bowden cable 650 mm	790291 00 0 00 1000	
	length of bowden cable 850 mm	790295 00 0 00 1000	
	length of bowden cable 1100 mm	790299 00 0 00 1000	
	Waste and overflow Quadroval with water inlet, chrome, for freestanding bathtubs, outlet diameter 52 mm, (pipe interrupt necessary)		
	length of bowden cable 650 mm	790292 00 0 00 1000	
	length of bowden cable 850 mm	790296 00 0 00 1000	
	length of bowden cable 1100 mm	791200 00 0 00 1000	
	Waste and overflow * with base inlet, chrome, outlet diameter 52 mm		
	for bathtubs	791226 00 0 00 1000	
	for freestanding bathtubs	791228 00 0 00 1000	
	Infobox: * pipe interrupt mandatory		
	Waste and overflow * with base inlet, chrome, long version, outlet diameter 52 mm		
	for bathtubs	791230 00 0 00 1000	
	for freestanding bathtubs	791235 00 0 00 1000	
	Infobox: * pipe interrupt mandatory		
	Surcharge for waste and overflow Quadroval, with water inlet, chrome, for whirltubs, outlet diameter 52 mm, (pipe interrupt necessary)		
	length of bowden cable 550 mm	791205 00 0 00 1000	
	length of bowden cable 1100 mm	791207 00 0 00 1000	
	Surcharge for waste and overflow Quadroval, with water inlet, chrome, for whirltubs, outlet diameter 52 mm, (pipe interrupt necessary)		
	long version	791206 00 0 00 1000	
	with connection hose for water inlet	791210 00 0 00 1000	

Fittings

	Description	Model-No.	Euro
	Surcharge * for waste and overflow, with base inlet, chrome, outlet diameter 52 mm		
	for whirltubs	791227 00 0 00 1000	
	for freestanding whirltubs	791229 00 0 00 1000	
	Infobox: * pipe interrupt mandatory		
	Surcharge * for waste and overflow, with base inlet, chrome, for whirltubs, long version outlet diameter 52 mm		
		791231 00 0 00 1000	
	Infobox: * pipe interrupt mandatory		
	Flush-mounting duct interrupt model A2, EN 1717, chrome 3/4"		
		790114 00 0 00 1000	
	Connection hose for water inlet, 3/4" inside thread x 3/4" inside thread length: 1000 mm		
		790115 00 0 00 0000	
	LED coloured light with remote control for bathtubs		
	white chrome	790840 00 0 00 0000 790840 00 0 00 1000	
	LED coloured light for whirltubs with Air-System, Jet-System, Combi-System P, Durapearl-System or Jet Project		
		791850 00 0 00 1000	
	Sound for bathtubs		
	for whirltubs with Air-System, Jet-System, Combi-System P, Durapearl-System or Jet Project	791851 00 0 00 0000	
	for whirltubs with Combi-System E	791852 00 0 00 0000 791853 00 0 00 0000	
	Support frame for shower trays height-adjustable from 85 - 105 mm height-adjustable from 100 - 185 mm		
		790101 00 0 00 0000 790102 00 0 00 0000	

Fittings

	Description	Model-No.	Euro
	Outlet drain horizontal outlet, chrome outlet diameter 90 mm	790263 00 0 00 1000	
	Outlet drain vertical outlet, chrome outlet diameter 90 mm	790269 00 0 00 1000	
	Care kit for acrylic surfaces, for basic cleaning and removing persistent stains Contents: acrylic care agent, grinding paste, polishing paste	790301 00 0 00 0000	
	Care and maintenance kit for acrylic surfaces, for correcting scratches and other superficial damage Contents: acrylic care agent, acrylic resin, hardener, grinding paste, polishing paste	790302 00 0 00 0000	
	Mounting foam for supports 400 ml 1 bottle	790340 00 0 00 0000	
	Installation set for freestanding bath- and whirltubs	790850 00 0 00 0000	

Bathroom furniture

Bathroom furniture

Bathroom furniture

Bathroom furniture

Important Indications Bathroom Furniture

1. Structure of the pricelist

All models are type-ordered
Type-number consists of:

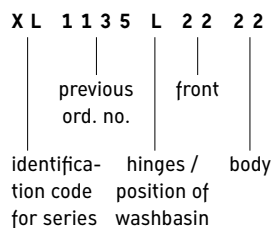

Note: Please indicate the „0“ at the according point for models without hinges. Please set the body colour as well as front colour for models without a front.

model-no. = identification code for series + previous ord. no.
If furniture are offered in various colours, all necessary information for the ordering process are mentioned in an ordering example.

2. Ordering system Duravit

2.1. Individual specifications

- series
- front colour
- body colour
- colour for consoles, countertops and shelves

2.2. Model-related specifications

- model number
- door hinges
 - L = hinge on the left side
 - R = hinge on the right side
 - 0 = no hinge
- position of washbasin
 - L = washbasin on the left side
 - R = washbasin on the right side
 - M = washbasin centred
 - B = washbasin on both sides
- for variable models, indication of the width
- model-no. ceramic for consoles
- position low cabinets or vanity units for consoles

2.3. Drawings, sketches

Detailed drawings for ordering of countertops or variable consoles are absolutely necessary. Please use order sheet and check list.

2.4. Duravit individual

Variations of articles and materials within the available product range are possible. If necessary please attach a sketch. On request we provide a proposal.

3. Additions

New models

Series	Remark	Availability
DuraStyle	Vanity unit # DS 6396, 6397	available
	Mirror # DS 7266	available
	Previous models of the series Onto	
	- consoles # DS 828C, 829C	available
	- shelves with drawer # DS 8270-8273	available
	- seat cushion # DS 9938	available

4. Out of product range

Discontinued series and models

Series	Remark
2nd floor	Wall board # 2F 9405 - 9407
Darling New	Vanity unit # DN 6450 - 6451, # DN 6463 - 6465, # DN 6466 - 6468, # DN 6473 - 6475, # DN 6476 - 6478, # DN 6863 - 6865, # DN 6873 - 6875, Low cabinet # DN 6770 - 6772, # DN 6780 - 6782 Console # DN 800C - 803C, # DN 810C - 813C complete series
Happy D. Ketho	mirror # KT 7230 - 7233 vanity unit # KT 6631 - 6634 # KT 6675 - 6678 complete series
Mirrorwall Onto	Vanity unit # OT 6672 Low cabinet for console # OT 2540 - 2542 Mirror with lighting # OT 7279 - 7282 Tall cabinet # OT 1280
Starck X-Large	Vanity unit # S1 9516, S1 9518, S1 9524 Vanity unit # XL 6360 - 6363 Countertop # XL 065C - 067C Vanity unit # XL 6246, XL 6017, XL 6016, XL 6217 Low cabinet # XL 2202 - 2203, XL 2224 - 2227, XL 2204 - 2207, XL 2216, XL 2564 Console XL 063C, XL 068C, XL 064C, XL 069C mirror # XL 7210 - 7214 mirror cabinet # XL 7092, XL 7094 - 7096 Wall Cabinet # XL 4760 - 4761 Wall board # XL 9405 - 9407 Mobile storage # XL 2700 - 2701 Plastic box drawer # XL 9956 - 9959 Tall cabinet # XL 1100, XL 1104, XL 1112, XL 1118, XL 1127, XL 1130 Plinth Frame # XL 8601 - 8604
Light and mirrors	# LM 9698 - 9699, # LM 9952 - 9953

5. Warranty

Duravit grants a warranty period of 5 years for all ceramic sanitary ware, 2 years for all bathroom furniture, providing that the installation is carried out by a certified plumber. Please note that parts subject to wear and tear are excluded.

Bathroom Furniture Product Specifications

All furniture parts correspond in construction and workmanship to the requirements laid down in DIN 68935 and the E1 directive on toxic substances with regard to formaldehyde emissions.

I. Technical Product Specifications

1. Panel for mirror ground plate, body and rear panel

These are 38, 19, 16 and 8 mm thick, back panels are set in grooves, recessed and bonded.

Further information is available in the detailed product information for the various series.

2. Real wood veneer

Fronts, Bodies, Consoles, Shelf under washbasin trim, Washbasin trims:

Possible variations concerning structure, veining, pores and colour are manifestations of the genuineness of the natural material wood and preclude any cause for complaint.

Further information can be obtained from the detailed product information for the individual series.

3. Consoles

Detailed information is included in the description of the individual series.

4. Shelves

Glass shelves, thickness: 6 mm, height-adjustable.

5. Drawers

5.1. Drawers for series 2nd floor, Darling New, DuraStyle, Fogo, Ketho, PuraVida, Starck, X-Large

Silver steel frames; roller guide with extended self-closing action; strong lateral support; casters of noise-reducing plastic; steel guide tracks. Two dimensional adjustment of the drawer's covering is possible. Elegant cover of the adjusting mechanism with DURAVIT logo. Base and rear panel in the colour of the body; drawers can be easily removed for cleaning purposes.

5.2. Drawers for Delos and Happy D.2

Anthracite colored steel frames; roller guide with extended self-closing action; strong lateral support; casters of noise-reducing plastic; steel guide tracks. Three-dimensional adjustment of the drawers's covering possible. Elegant cover of the adjusting mechanism with DURAVIT logo. Base and rear panel in the colour of the body; drawers can be easily removed for cleaning purposes. The interior system is optional.

6. Hinges

Full metal hinges with three-dimensional adjustment. 107° opening angle. Doors are easily unhinged. Thanks to clip-on mechanism, no tools are necessary. Elegant cover with DURAVIT logo.

7. Suspension brackets

7.1. Cabinet suspension

Concealed by the rear panel, easy to adjust two-dimensionally. Maximum load 65 kg each, with slip-resistant combination hook for track and hook suspension.

7.2. Mirror suspension

Height-adjustable fixing; integrated in the mirror's rear panel.

7.3. Washbasin vanity unit suspension

Easily adjustable in two dimensions; maximum load 65 kg each, with slip-resistant combination hook for track and hook suspension. After the adjustment, vanity units with a width of more than 100 cm are protected additionally by a special fixing.

8. Wire articles

Glossy chrome-plated finish of railings and removable laundry basket.

9. Crystal mirrors

Ground and polished edges; high quality standards exceeding DIN 1238. Crystal mirrors ought to be cleaned only with a soft and dry cloth; wipe off marks with a slightly damp cloth or chamois leather; window cleaner and other acrid cleaning agents can damage the silver coating and preclude any cause for complaint.

II. Mounting Aids

1. Mounting accessories

Screws, dowels, cover caps and installation tracks are included with the respective model.

Installation only by skilled professionals. Provided screws and dowels have to be reviewed for applicability in appropriate wall, if necessary they have to be replaced by capable material on site.

2. Mounting and care instructions

Are included in the respective consignment.

2nd floor Design by sieger design

Product Information

Fronts Body Body Mirror Cabinet Edges Mirror	Decor (Pricegroup 1)	67 Rosewood	High-compressed three-ply chipboard, directly coated with melamine resin decor on both sides. ABS- or Acrylic-Edge material. Surfaces resistant to moisture.
	Real wood veneer (Pricegroup 2)	59 Ebony 62 Anthracite Oak 65 Bleached Oak	High-compressed three-ply chipboard, with real wood veneer pressed on both sides. Trim in real wood veneer. Surfaces resistant to moisture. Real wood veneer is a natural material, differences in colour and structure may occur.
	Lacquer (Pricegroup 3)	85 White High Gloss	High-compressed MDF boards. Lacquered opaque in several coats. Inside: directly coated with melamine resin decor. Surface resistant to moisture.
Wallboards	Decor (Pricegroup 1)	67 Rosewood	Description of material see Fronts (Decor).
	Real wood veneer (Pricegroup 2)	59 Ebony 62 Anthracite Oak 65 Bleached Oak	Description of material see Fronts (Real wood veneer).
	Lacquer (Pricegroup 3)	85 White High Gloss	High-compressed MDF boards. Lacquered opaque in several coats. Surface resistant to moisture.
Shelves	Decor (Pricegroup 1)	67 Rosewood	Compact laminated panel, with laminate (HPL) pressed on both sides.
	Real wood veneer (Pricegroup 2)	59 Ebony 62 Anthracite Oak 65 Bleached Oak	High-compressed laminated panel, with real wood veneer pressed on both sides. Real wood veneer is a natural material, differences in colour and structure may occur.
	Lacquer (Pricegroup 3)	85 White High Gloss	High-compressed MDF boards. Lacquered opaque in several coats. Surface resistant to moisture.
Ceiling panel (for pivotable mirror with lighting)	Decor	85 White High Gloss	High-compressed MDF boards with thermofront surface. Ground frame consists of multiple glued plywood, ABS-Edge material in Aluminium White (37). Surface resistant to moisture.
Handles Suspension for - grip - pivotable mirror with lighting		10 Chrome	Metal, chrome.

2nd floor Design by sieger design

Ordering Sample

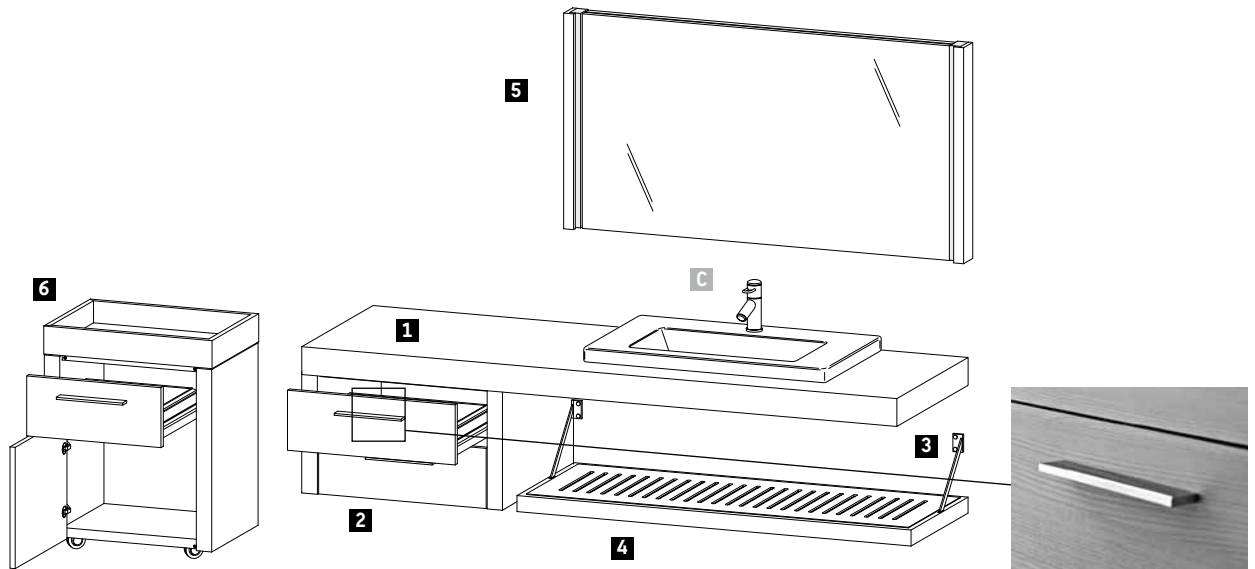

2nd floor

Body
Vanity Unit
Mobile Storage
Console
Mirror

59 Ebony

Description	Remark	Quantity	Model-No.
1 Console	Width 1900 mm	1	# 2F 856C 0 59 59
2 Low cabinet for console		1	# 2F 9276 0 59 59
3 Console support 100 mm installation in wall		1	# 2F 9926 0 00 00
4 Shelf		1	# 2F 6443 0 59 59
5 Mirror with lighting		1	# 2F 9648 0 59 59
6 Mobile Storage unit		1	# 2F 9272 L 59 59
C 2nd floor 800 mm		1	# 049180 00 27

2nd floor Design by sieger design

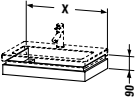
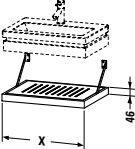
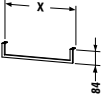
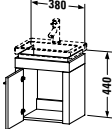
Description	mm	Model-No.	Euro		
			Pricegroup 1	Pricegroup 2	Pricegroup 3
					
Washbasin trim					
for 2nd floor # 079040, (not ground)	380 x 290	2F 6405			
for 2nd floor # 049160, (not ground)	580 x 420	2F 6406			
for 2nd floor # 049180, (not ground)	780 x 490	2F 6407			
for 2nd floor # 049112, (not ground)	1180 x 490	2F 6408			
<hr/>					
					
Shelf					
1 grid, 2 fixation, chrome					
under washbasin trim # 2F 6405	380 x 270	2F 6440			
under washbasin trim # 2F 6406	580 x 400	2F 6441			
under washbasin trim # 2F 6407	780 x 440	2F 6442			
under washbasin trim # 2F 6408	1184 x 440	2F 6443			
<hr/>					
Infobox: Strength of shelf in 85 White High Gloss: 38 mm					
<hr/>					
					
Towel rail					
under trims, square tube, chromed, 14 mm					
	500	2F 9985			
	1000	2F 9986			
<hr/>					
					
Vanity unit wall-mounted					
1 door					
for 2nd floor # 079040, (not ground)	380 x 290	2F 6445 L/R			
<hr/>					
Infobox: Space saving siphon # 005073 is recommended / Required specification for ordering: - Hinges left (L) / right (R)					

2nd floor Design by sieger design

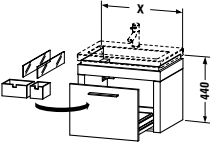
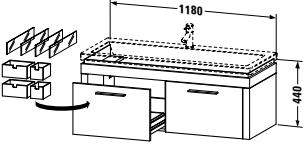
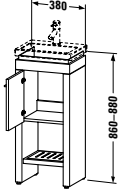
Description	mm	Model-No.	Euro		
			Pricegroup 1	Pricegroup 2	Pricegroup 3
 <p>Vanity unit wall-mounted 1 pull-out compartment, compartment consists of glass dividers and box drawers (small/large) for 2nd floor # 049160, (not ground) 580 x 420 2F 6446 for 2nd floor # 049180, (not ground) 780 x 490 2F 6447</p> <p>Infobox: Space saving siphon # 005073 is recommended</p>					
 <p>Vanity unit wall-mounted 2 pull-out compartments, 4 glass divider-box drawers, 2 box drawers large, 2 box drawers small for 2nd floor # 049112, (not ground) 1180 x 490 2F 6448</p> <p>Infobox: Space saving siphon # 005073 is recommended</p>					
 <p>Vanity unit floor-standing 1 door, 1 grid for 2nd floor # 079040, (not ground) 380 x 290 2F 6455 L/R</p> <p>Infobox: Space saving siphon # 005073 is recommended / Required specification for ordering: - Hinges left (L) / right (R)</p>					

2nd floor Design by sieger design

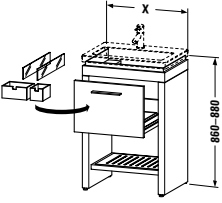
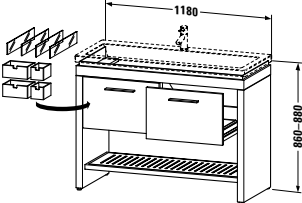
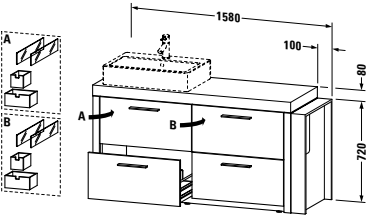
Description	mm	Model-No.	Euro		
			Pricegroup 1	Pricegroup 2	Pricegroup 3
 <p>Vanity unit floor-standing 1 pull-out compartment, 1 grid, compartment consists of glass dividers and box drawers (small/large) for 2nd floor # 049160, (not ground) 580 x 420 2F 6456 for 2nd floor # 049180, (not ground) 780 x 490 2F 6457</p>					
Infobox: Space saving siphon # 005073 is recommended					
 <p>Vanity unit floor-standing 2 pull-out compartments, 1 grid, 4 glass divider-box drawers, 2 box drawers large, 2 box drawers small for 2nd floor # 049112, (not ground) 1180 x 490 2F 6458</p>					
Infobox: Space saving siphon # 005073 is recommended					
 <p>Vanity unit floor-standing 1 console, width fix including one cut-out, (position: outer edge console), back panel one unit, 4 box drawers (upper ones including compartment for sundries), 4 glass divider-box drawers, 1 cover for wall connection (width = 100 mm) revisable, 2 box drawers large 2 box drawers small 1580 x 580 2F 6424 L/R</p>					
Infobox: Required Specifications for the order: - Please indicate L/R: L = wall connection is on left side when you stand in front of drawers R = wall connection is on right side when you stand in front of drawers - model-no. ceramic 2nd floor: # 034760, Vero: # 031555, 045250, 045260 / If connecting-kit # 2F 9970 is ordered vanity unit # 2F 6424 -6427 will be delivered pre-installed. Exactly measures wall connections please refer to technical details					

2nd floor Design by sieger design

Description	mm	Model-No.	Euro		
			Pricegroup 1	Pricegroup 2	Pricegroup 3
<p>Vanity unit floor-standing</p> <p>1 console, width fix including two cut-outs, back panel one unit, 4 box drawers (upper ones including compartment for sundries), 4 glass divider-box drawers, 1 cover for wall connection (width = 100 mm) revisable, 2 box drawers large 2 box drawers small</p> <p>1580 x 580</p> <p>2F 6425 L/R</p>					

Infobox: Required Specifications for the order:

- Please indicate L/R: L = wall connection is on left side when you stand in front of drawers R = wall connection is on right side when you stand in front of drawers
- model-no. ceramic 2nd floor: # 034760, Vero: # 031555, 045250, 045260 / If connecting-kit # 2F 9970 is ordered vanity unit # 2F 6424 -6427 will be delivered pre-installed. Exactly measures wall connections please refer to technical details

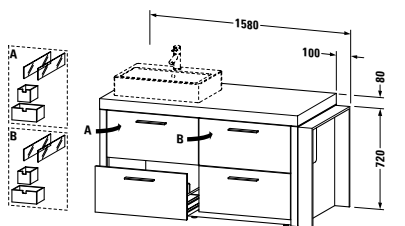

Vanity unit floor-standing including lighting

- 1 console,
width fix including one cut-out,
(position: outer edge console),
4 box drawers (upper ones including compartment for sundries),
1 lighted shelf (D = 161 mm) on back panel,
(back panel illuminated,
division of shelves equates drawer front),
2 T5 lighting 3500 kelvin light colour, 21 W,
4 glass divider-box drawers,
2 box drawers large,
2 box drawers small

1 cover for wall connection (width = 100 mm) revisable 1580 x 810 **2F 6426 L/R**

Infobox: Required Specifications for the order:

- Please indicate L/R: L = wall connection is on left side when you stand in front of drawers R = wall connection is on right side when you stand in front of drawers
- model-no. ceramic 2nd floor: # 034760, Vero: # 031555, 045250, 045260 / If connecting-kit # 2F 9970 is ordered vanity unit # 2F 6424 -6427 will be delivered pre-installed. Exactly measures wall connections please refer to technical details

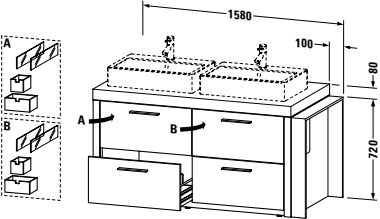
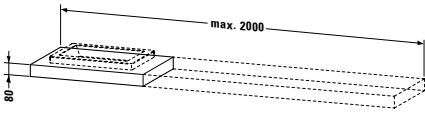

2nd floor Design by sieger design

Description	mm	Model-No.	Euro		
			Pricegroup 1	Pricegroup 2	Pricegroup 3
 <p>Vanity unit floor-standing including lighting</p> <p>1 console, width fix including two cut-outs, 4 box drawers (upper ones including compartment for sundries), (back panel illuminated, division of shelves equates drawer front), 1 lighted shelf (D = 161 mm) on back panel, 2 T5 lighting 3500 kelvin light colour, 21 W, 4 glass divider-box drawers, 2 box drawers large, 2 box drawers small 1 cover for wall connection (width = 100 mm) revisable</p>	1580 x 810	2F 6427 L/R			
<p>Infobox: Required Specifications for the order:</p> <ul style="list-style-type: none"> - Please indicate L/R: L = wall connection is on left side when you stand in front of drawers R = wall connection is on right side when you stand in front of drawers - model-no. ceramic 2nd floor: # 034760, Vero: # 031555, 045250, 045260 / If connecting-kit # 2F 9970 is ordered vanity unit # 2F 6424 -6427 will be delivered pre-installed. Exactly measures wall connections please refer to technical details 					
<p>Connecting kit</p> <p>complete connecting kit including fixing material for headwater and drain outlet adapted for # 2F 6424-6427</p>		2F 9970			
<p>Infobox: If connecting-kit # 2F 9970 is ordered vanity unit # 2F 6424 -6427 will be delivered pre-installed. Exactly measures wall connections please refer to technical details</p>					
 <p>Console</p> <p>1 console with one cut-out, Width min. see ordering information, Width max 2000 mm</p>	550	2F 856C			
<p>Infobox: Required specification for the order:</p> <ul style="list-style-type: none"> - overall width - dimension between axes from left side - model-no ceramic and min. width, please see page 665/666 - exactly position of floor cabinets / console supports <p>Please indicate exact meassures and drawings please refer to order sheet page 668</p>					

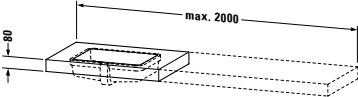
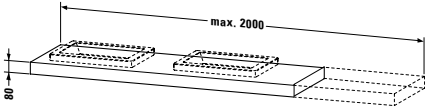
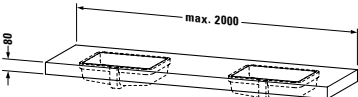
2nd floor Design by sieger design

Description	mm	Model-No.	Euro		
			Pricegroup 1	Pricegroup 2	Pricegroup 3
 <p>Console for undercounter basin bonded 1 console with one cut-out, Width min. see ordering information, Width max 2000 mm basic price till 800 mm, for undercounter basin bonded 550 2F 857C price per section of 100 mm</p>					
<p>Infobox: Required specification for the order:</p> <ul style="list-style-type: none"> - overall width - dimension between axes from left side - model.-no ceramic and min. width, please see page 666 - exactly position of floor cabinets / console supports <p>Please indicate exact meassures and drawings please refer to order sheet page 668 / For undercounter basin bonded, price includes the assembly of the washbasin on the console / For undercounter basin bonded, following surface isn't available: 85 White High Gloss</p>					
 <p>Console 1 console with two cut-outs, Width min. see ordering information, Width max 2000 mm basic price till 800 mm, for vanity basin and washbowl 550 2F 858C price per section of 100 mm</p>					
<p>Infobox: Required specification for the order:</p> <ul style="list-style-type: none"> - overall width - dimension between axes from left side - model.-no ceramic and min. width, please see page 665/666 - exactly position of floor cabinets / console supports <p>Please indicate exact meassures and drawings please refer to order sheet page 668</p>					
 <p>Console for undercounter basin bonded 1 console with two cut-outs, Width min. see ordering information, Width max 2000 mm basic price till 800 mm, for undercounter basin bonded 550 2F 859C price per section of 100 mm</p>					
<p>Infobox: Required specification for the order:</p> <ul style="list-style-type: none"> - overall width - dimension between axes from left side - model.-no ceramic and min. width, please see page 666 - exactly position of floor cabinets / console supports <p>Please indicate exact meassures and drawings please refer to order sheet page 668 / For undercounter basin bonded, price includes the assembly of the washbasin on the console / For undercounter basin bonded, following surface isn't available: 85 White High Gloss</p>					

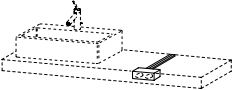
2nd floor Design by sieger design

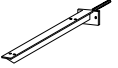
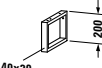
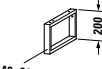
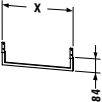
Description	mm	Model-No.	Euro		
			Pricegroup 1	Pricegroup 2	Pricegroup 3
 <p>Socket beneath console mountable beneath console, incl. 1 connecting cable (1,5 m) including fixing</p>		2F 9907			
Infobox: External dimensions of double socket: height = 45 mm, width = 140 mm, depth = 80 mm					
 <p>Console Support 1 console support-bracket, mountable beneath console grey, powder-coated</p>	40 x 425	2F 9902			
 <p>Console support 100 mm installation in wall 1 console support (depth without pin) grey, powder-coated</p>	90 x 420	2F 9926			
Infobox: For using the console support for a dry lining wall, it's necessary to arm the wall					
 <p>Console Support 1 console support-towel rail, for installation beneath a depth reduced console chrome</p>	40 x 340	2F 9904			
 <p>Console Support 1 console support-towel rail, mountable beneath console chrome</p>	40 x 480	2F 9903			
 <p>Towel rail under consoles, square tube, chromed, 14 mm</p>	500 1000	2F 9983 2F 9984			

2nd floor Design by sieger design

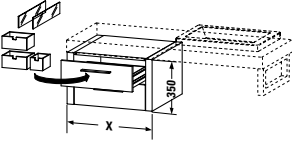
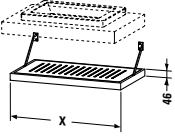
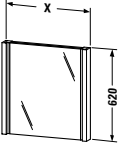
Description	mm	Model-No.	Euro		
			Pricegroup 1	Pricegroup 2	Pricegroup 3
 <p>Low cabinet for console under consoles, 2 drawers without compartment</p>	400 x 550	2F 9275			
<p>1 box drawer small, 2 glass divider-box drawers, 2 box drawers large</p>	600 x 550	2F 9276			
 <p>Shelf under consoles, 2 fixation, chrome</p>	580 x 440	2F 6439			
	780 x 440	2F 6442			
	1180 x 440	2F 6443			
Infobox: Strength of shelf in 85 White High Gloss: 38 mm					
 <p>Mirror with lighting IP 44, 2 T5 lighting 3500 kelvin light colour, 14 W, 1 sensor switch bottom right</p>	400 x 72	2F 9645			
	600 x 72	2F 9646			
	800 x 72	2F 9647			
	1200 x 72	2F 9648			
Infobox: Distance between sensor and reflecting surfaces = minimum 75 mm					

2nd floor Design by sieger design

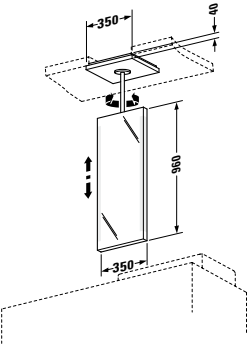
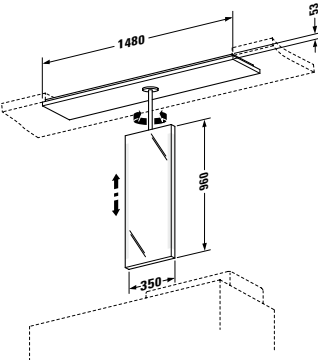
Description	mm	Model-No.	Euro		
			Pricegroup 1	Pricegroup 2	Pricegroup 3
 <p>Mirror element with lighting IP 44, 1 mirror with lighting, installed central on ceiling panel, 45° pivotable on left and right side, chromed suspension continuous adjustable (ceiling height 2300 -3000 mm), 2 T5 lighting 3500 kelvin light colour, 21 W, switch (touch LED) central below is coevally LED night light including light sensor ceiling panel (D = 350 x W = 350 mm)</p>	350 x 36	2F 9642			
 <p>Mirror element with lighting IP 44, 1 mirror with lighting, installed central on ceiling panel, 45° pivotable on left and right side, chromed suspension continuous adjustable (ceiling height 2300 -3000 mm), 2 T5 lighting 3500 kelvin light colour, 21 W, switch (touch LED) central below is coevally LED night light including light sensor ceiling panel (D = 300 mm x W = 1480 mm)</p>	350 x 36	2F 9638			

2nd floor Design by sieger design

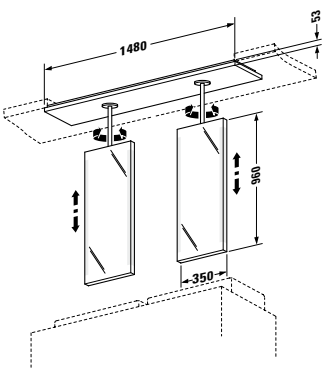
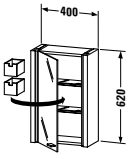
Description	mm	Model-No.	Euro		
			Pricegroup 1	Pricegroup 2	Pricegroup 3
 <p>Mirror with lighting IP 44, 2 mirrors with lighting, position of mirror is behind washbasin, 45° pivotable, chromed suspension is continuously adjustable in height (ceiling height 2300 - 3000 mm), 4 T5 lighting 3500 kelvin light colour, 21 W, switch (touch LED) central below is coevally LED night light including light sensor ceiling panel (D = 300 mm x W = 1480 mm)</p>	350 x 36	2F 9639			
 <p>Mirror cabinet IP 44, 1 mirror door, 2 glass shelves, 2 railing bars, 2 box drawers small, 1 cosmetic mirror, 1 magnet bar, 2 T5 lighting 3500 kelvin light colour, 14 W, 1 sensor switch bottom right, socket inside body in real wood veneer/melamine resin/lacquer</p>	400 x 200	2F 9650 L/R			
<div style="border: 1px solid black; padding: 5px;"> <p>Infobox: Distance between sensor and reflecting surfaces = minimum 75 mm / Required specification for ordering: - Hinges left (L) / right (R)</p> </div>					

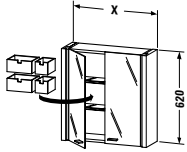
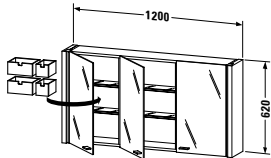
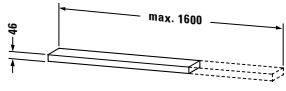

2nd floor Design by sieger design

Description	mm	Model-No.	Euro		
			Pricegroup 1	Pricegroup 2	Pricegroup 3
 <p>Mirror cabinet IP 44, 2 mirror doors, 2 glass shelves, 2 railing bars, 2 box drawers large, 2 box drawers small, 1 cosmetic mirror, 1 magnet bar, 2 T5 lighting 3500 kelvin light colour, 14 W, 1 sensor switch bottom right, socket inside</p>					
body in real wood veneer/melamine resin/lacquer	600 x 200	2F 9651			
body in real wood veneer/melamine resin/lacquer	800 x 200	2F 9652			
Infobox: Distance between sensor and reflecting surfaces = minimum 75 mm					
 <p>Mirror cabinet IP 44, 3 mirror doors, 4 glass shelves, 4 rails, 2 box drawers large, 2 box drawers small, 1 cosmetic mirror, 1 magnet bar, 2 T5 lighting 3500 kelvin light colour, 14 W, 1 sensor switch bottom right, socket inside</p>					
body in real wood veneer/melamine resin/lacquer	1200 x 200	2F 9653			
Infobox: Distance between sensor and reflecting surfaces = minimum 75 mm					
 <p>Wall board fixation with locking pin, 1 shelf, Width min. 600 mm, Width max. 1600 mm</p>					
basic price for 600 mm	600-1600 x 200	2F 9408			
price per section of 100 mm					

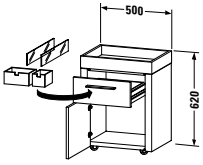
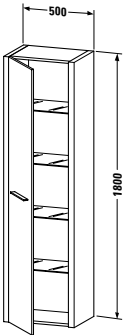
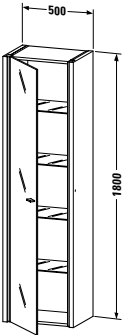
2nd floor Design by sieger design

Description	mm	Model-No.	Euro		
			Pricegroup 1	Pricegroup 2	Pricegroup 3
 <p>Mobile storage unit 1 drawer, 1 door, 2 glass divider-box drawers, 1 box drawer large, 1 box drawer small wooden tray above</p>	500 x 360	2F 9272 L/R			
Infobox: Required specification for ordering: - Hinges left (L) / right (R)					
 <p>Tall cabinet 1 door 4 glass shelves</p>	500 x 360	2F 9156 L/R			
Infobox: Required specification for ordering: - Hinges left (L) / right (R)					
 <p>Tall cabinet including lighting 1 mirror door, 4 glass shelves, 4 T5 lighting 3500 kelvin light colour, 21 W, 1 socket inside opposite hinges sensor switch lateral outside opposite hinges</p>	500 x 360	2F 9157 L/R			
Infobox: Distance between sensor and reflecting surfaces = minimum 75 mm / Required specification for ordering: - Hinges left (L) / right (R)					

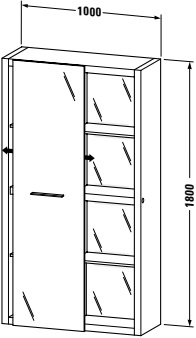
2nd floor Design by sieger design

Description	mm	Model-No.	Euro		
			Pricegroup 1	Pricegroup 2	Pricegroup 3
 <p>Tall cabinet including lighting 1 sliding door mirror (VSG safety glass) width = 508 mm, 1 lighted back panel, 3 T5 lighting 3500 kelvin light colour, 21 W, 6 shelves (not adjustable), 1 socket inside bottom right side, 1 center wall sensor switch, lateral outside</p>	1000 x 360	2F 9158 L/R			
Infobox: Distance between sensor and reflecting surfaces = minimum 75 mm / Please indicate left (L) / right (R) for position sensor switch, picture top is with sensor switch on right side					
 <p>Box drawer 1 box drawer large height: 90 mm</p>	160 x 120	2F 9913			
 <p>Box drawer 1 box drawer small height: 90 mm</p>	80 x 120	2F 9914			

Darling New Design by sieger design

Product Information

Fronts	Decor	14 Terra 15 Spring 18 White Matt 29 Azur 31 Pine Silver 51 Pine Terra	High-compressed three-ply chipboard, directly coated with melamine resin decor on both sides. ABS-Edge material. Surface resistant to moisture.
Body Body mirror cabinet	Decor	14 Terra 18 White Matt 31 Pine Silver 51 Pine Terra	High-compressed three-ply chipboard, directly coated with melamine resin decor on both sides. ABS-Edge material. Surface resistant to moisture.
Body Shadow gab	Decor	37 White Aluminium	ABS- Edge material or high-compressed three-ply chipboard, directly coated with melamine resin decor on both sides. Surface resistant to moisture.
Wall boards, mirror shelves, cover plates vanity units, semi-tall cabinet and mobil storage unit	Structured Coating	14 Terra 15 Spring 18 White Matt 29 Azur	High-compressed MDF boards. On all sides lacquered opaque in several coats. Surface resistant to moisture.
Edges mirror ground plate	Decor	37 White Aluminium	ABS-Edge material
Lamps and handles		Aluminium	Silver anodised
Handles mirror cabinet		Zinc diecasting	Silver anodised

Darling New Design by sieger design

Ordering Sample

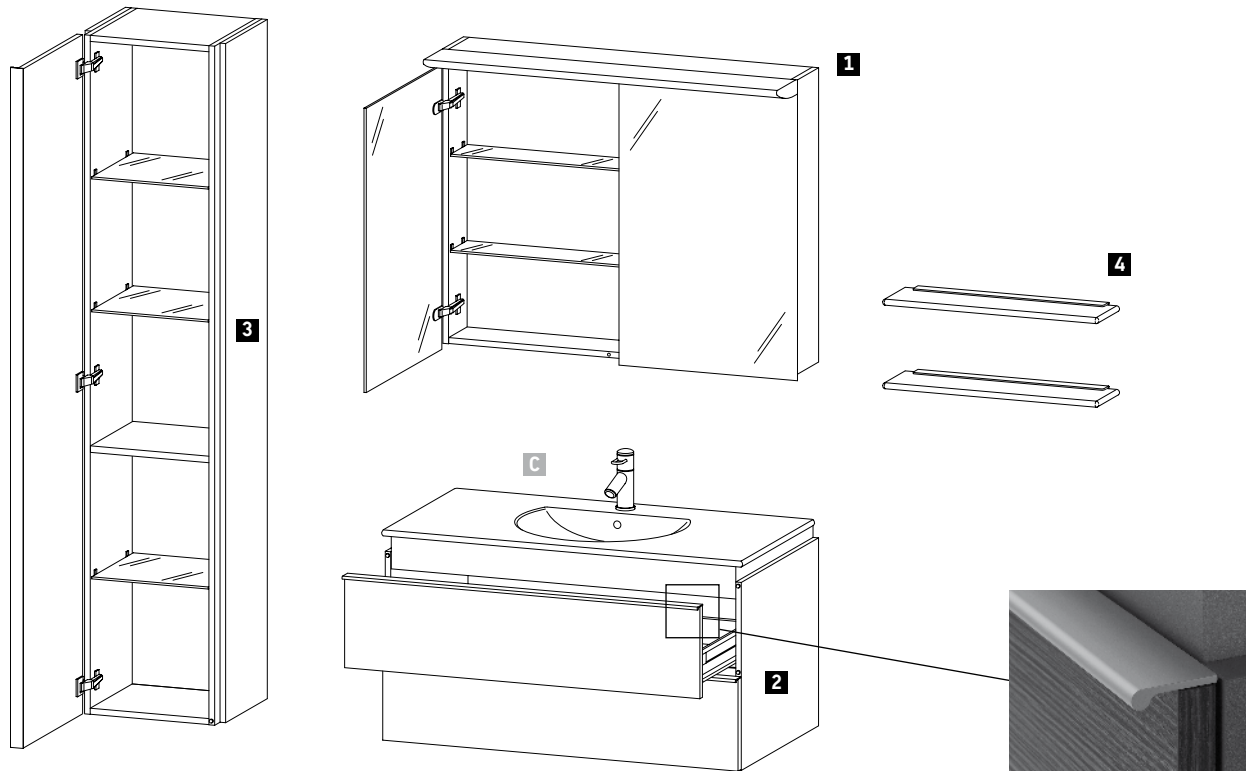

Darling New
 Body, Fronts
 Wall board
 Mirror cabinet, tall cabinet

18 White Matt
15 Spring
18 White Matt

Description	Remark	Quantity	Model-No.
1 Mirror cabinet	Width 1000 mm	1	# DN 7537 0 18 18
2 Vanity unit wall-mounted	Width 1000 mm	1	# DN 6472 0 18 18
3 Tall cabinet	Width 400 mm	1	# DN 1274 L 18 18
4 Wall board	Width 600 mm	2	# DN 7905 0 15 15
C Darling New Furniture washbasin, 1030 mm		1	# 049910 00 00

Darling New Design by sieger design

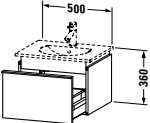
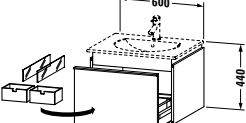
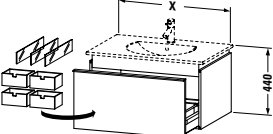
Description	mm	Model-No.	Euro		
					
Vanity unit wall-mounted 1 pull-out compartment, with siphon cut-out and apron for Darling New # 049953	500 x 430	DN 6454			
Infobox: Required specification for ordering: - Body colour - Front colour					
					
Vanity unit wall-mounted 1 pull-out compartment, 2 glass divider-box drawers, 2 box drawers large for Darling New # 049963	600 x 520	DN 6460			
Infobox: Space saving siphon # 005073 is recommended / Required specification for ordering: - Body colour - Front colour					
					
Vanity unit wall-mounted 1 pull-out compartment, 3 glass divider-box drawers, 4 box drawers large for Darling New # 049983 for Darling New # 049910	800 x 545 1000 x 545	DN 6461 DN 6462			
Infobox: Space saving siphon # 005073 is recommended / Required specification for ordering: - Body colour - Front colour					

Darling New Design by sieger design

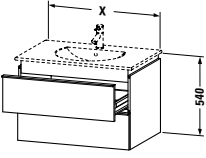
Description	mm	Model-No.	Euro
 <p>Vanity unit wall-mounted 2 drawers, (1 x including cut out for siphon and siphon cover) for Darling New # 049963 600 x 520 DN 6470 for Darling New # 049983 800 x 545 DN 6471 for Darling New # 049910 1000 x 545 DN 6472</p>			

Infobox: Required specification for ordering:

- Body colour
- Front colour

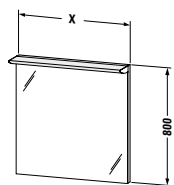

Mirror with lighting

IP 44,
 T5 lighting 3500 kelvin light colour,
 1 sensor switch bottom right

1 lamp 600 mm, 14 W	600 x 170	DN 7255
1 lamp 800 mm, 14 W	800 x 170	DN 7256
1 lamp 1000 mm, 21 W	1000 x 170	DN 7257
1 lamp 1200 mm, 28 W	1200 x 170	DN 7258
1 lamp 1500 mm, 35 W	1500 x 170	DN 7265

Infobox: Distance between sensor and reflecting surfaces = minimum 75 mm

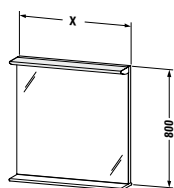

Mirror with lighting

IP 44,
 1 wooden shelf,
 T5 lighting 3500 kelvin light colour,
 1 sensor switch bottom right

1 lamp 600 mm, 14 W	600 x 170	DN 7275
1 lamp 800 mm, 14 W	800 x 170	DN 7276
1 lamp 1000 mm, 21 W	1000 x 170	DN 7277
1 lamp 1200 mm, 28 W	1200 x 170	DN 7278
1 lamp 1500 mm, 35 W	1500 x 170	DN 7285

Infobox: Distance between sensor and reflecting surfaces = minimum 75 mm

Darling New Design by sieger design

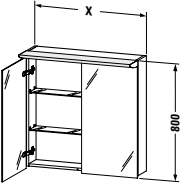
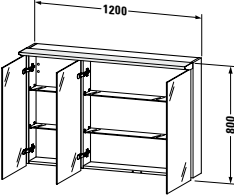
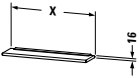
Description	mm	Model-No.	Euro
 <p>Mirror cabinet IP 44, 2 mirror doors, 2 glass shelves, T5 lighting 3500 kelvin light colour, socket inside, 1 sensor switch bottom right</p>			
1 lamp 600 mm, 14 W	600 x 270	DN 7535	
1 lamp 800 mm, 14 W	800 x 270	DN 7536	
1 lamp 1000 mm, 21 W	1000 x 270	DN 7537	
Infobox: Handels attached, including fixing for installation on mirror glass as needed / Distance between sensor and reflecting surfaces = minimum 75 mm			
 <p>Mirror cabinet IP 44, 3 mirror doors, 4 glass shelves, T5 lighting 3500 kelvin light colour, socket inside, 1 sensor switch bottom right</p>			
1 lamp 1200 mm, 28 W	1200 x 270	DN 7538	
Infobox: Handels attached, including fixing for installation on mirror glass as needed / Distance between sensor and reflecting surfaces = minimum 75 mm			
 <p>Wall board 1 shelf, fixation with aluminium profile</p>			
	600 x 160	DN 7905	
	800 x 160	DN 7906	

Darling New Design by sieger design

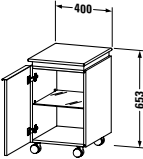
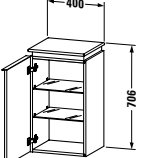
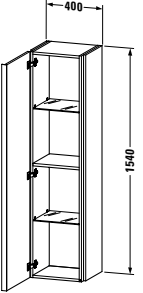
Description	mm	Model-No.	Euro		
					
Mobile storage unit					
1 door					
1 glass shelf	400 x 460	DN 2525 L/R			
Infobox: Required specification for ordering: - Hinges left (L) / right (R) - Front colour - Body colour - surface cover plate					
					
Semi-tall cabinet					
1 wooden door,					
2 glass shelves					
width 430 mm (opened)	400 x 340	DN 1270 L/R			
Infobox: Required specification for ordering: - Hinges left (L) / right (R) - Body colour - Front colour - surface cover plate					
					
Tall cabinet					
1 wooden door,					
2 glass shelves					
1 wooden shelf	400 x 340	DN 1272 L/R			
Infobox: Required specification for ordering: - Hinges left (L) / right (R) - Body colour - Front colour					

Darling New Design by sieger design

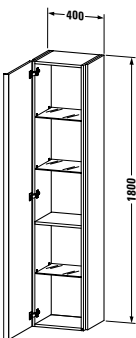
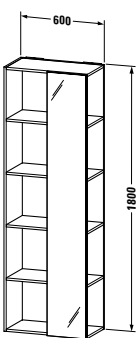
Description	mm	Model-No.	Euro
 <p>Tall cabinet 1 wooden door, 3 glass shelves 1 wooden shelf</p>	400 x 340	DN 1274 L/R	
<p>Infobox: Required specification for ordering: - Hinges left (L) / right (R) - Body colour - Front colour</p>			
 <p>Shelf tall mirror 4 wooden shelves</p>	600 x 340	DN 1276 L/R	
<p>Infobox: Required specification for ordering: - mirror left (L) / right (R)</p>			

Delos Design by E00S

Product Information

Fronts	Real wood veneer (Pricegroup 1)	12 Brushed Oak 69 Brushed Walnut	High-compressed three-ply chipboard, with real wood veneer pressed on both sides. Trim in real wood veneer. Surface resistant to moisture. Real wood veneer is a natural material, differences in colour and structure may occur.
	Lacquer (Pricegroup 2)	85 White High Gloss	High-compressed MDF boards. Outside one-sided laquered opaque in several coats and highly polished. Interior finish: Lacquered opaque in several coats. Surface resistant to moisture.
Body	Real wood veneer (Pricegroup 1)	12 Brushed Oak 69 Brushed Walnut	High-compressed three-ply chipboard, with real wood veneer pressed on one side. Trim in real wood veneer. Interior finish: Laminate (HPL) in (57) Black Diamond. Surface resistant to moisture. Real wood veneer is a natural material, differences in colour and structure may occur.
	Lacquer (Pricegroup 2)	85 White High Gloss	High-compressed MDF boards. Outside one-sided lacquered opaque in several coats and highly polished. Interior finish: Laminate (HPL) in (57) Black Diamond. Surface resistant to moisture.
Consoles	Real wood veneer (Pricegroup 1)	12 Brushed Oak 69 Brushed Walnut	High-compressed three-ply chipboard, with real wood veneer pressed on one side. Trim in real wood veneer. Surface resistant to moisture. Real wood veneer is a natural material, differences in colour and structure may occur.
	Lacquer (Pricegroup 2)	85 White High Gloss	High-compressed MDF boards. Outside one-sided laquered opaque in several coats and highly polished. Interior finish: Laminate (HPL) in (57) Black Diamond. Surface resistant to moisture.
Mirror/Mirror cabinet with lighting			LED light technology, 3500 Kelvin light colour. Sensor switch at the side (mirror) or bottom right (mirror cabinet) for on/off function
Edges Mirror ground plate	Decor	Chrome	ABS-Edge material
Body Mirror Cabinet		Mirror coated	Mirror glass
Extension mechanism		handleless	Tip-on fitting Automatic opening by conscious contact.
Interior System		Maple or walnut solid wood	The interior system with a material mix in acryl glass and solid wood is available in maple or walnut. There is an individually designed interior system for each cabinet width. There are always two boxes and one box cover in the interior systems for drawers with or without siphon cut-out plus a small tray wave system for cosmetic products. A special field for a hair dryer is integrated off a width of 750 mm. The interior system for drawer without siphon cut-out includes always a big tray wave system to lay in bigger bottles. Off a width of 800 mm there is also an special field for a hair dryer integrated. The interior system for a pull-out compartment always includes a support for hair brushes and comb. There is a wood grid to fix bottles off a width of 750 mm. Each size of the cabinet have a individual layout of the interior systems to use the optimum storage space. The bottom, the box cover the small and big wave plus the special support for hair brushes and comb have a special anti-slip lacquer.
Soundsystem			The 2.1 system with 2 flat drive speakers, 1 active bass and 1 passive bass create a high-quality listening experience, espacially matched to the bathroom situation. Output power: 2x5 Watt (tweeter/midrange), 1x25 Watt (active bass with one passive radiator-principle). The technical components of the soundsystem are invisibly integrated into the LED Mirror cabinet, with a loss of the useable volume of 55 mm in height. The control of the soundsystem is independent of the illumination. Music streaming and control is compatible with all Bluetooth enabled devices, that support the A2DP profile (stereo audio profiles). The standby power consumption is less than 0.5 Watt.

Furniture Surfaces see end of pricelist

Delos Design by E00S

Ordering Sample

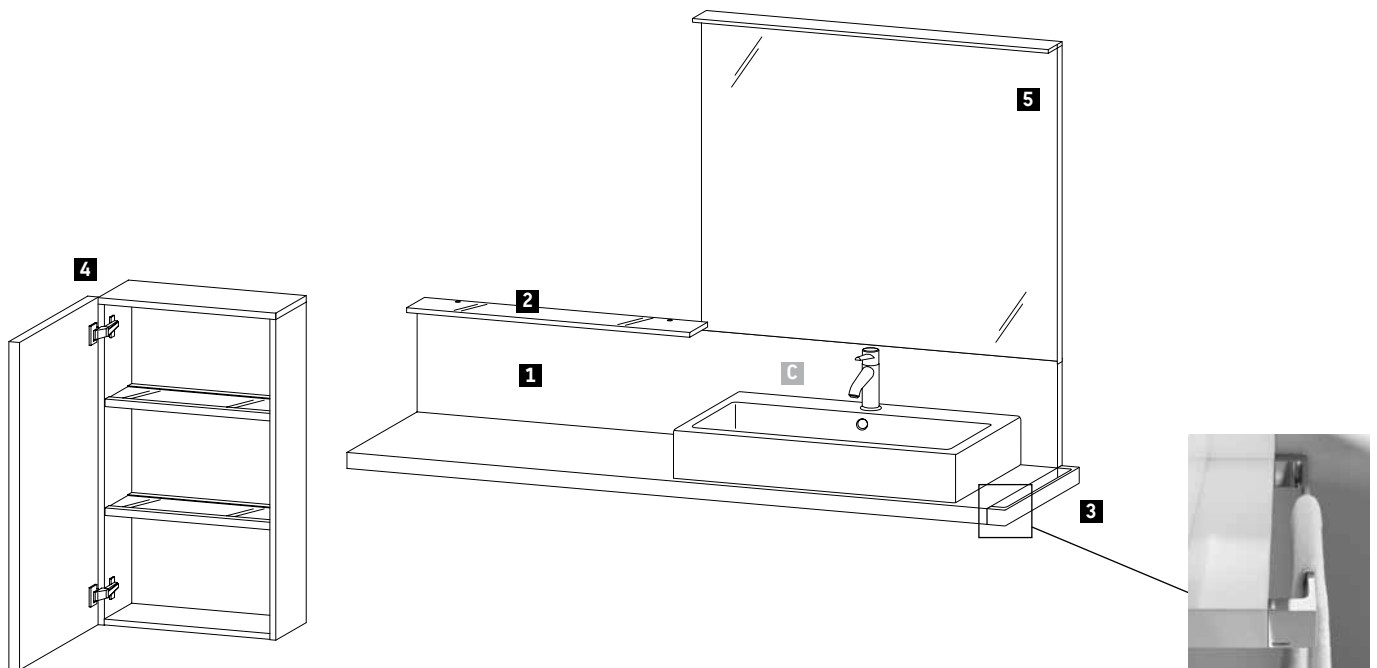

Delos



Console and back panel
Semi-tall cabinet

69 Brushed Walnut



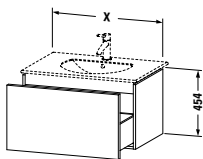

69 Brushed Walnut

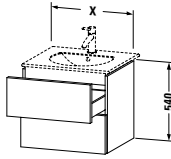
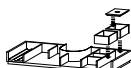
Description	Remark	Quantity	Model-No.
1 Console + back panel for above counter basin and countertop basin	Width 1800 mm	1	# DL 040C 0 69 69
2 Glass shelf	Width 800 mm	1	# DL 9905 0 00 00
3 Towel rail		1	# DL 9990 0 00 00
4 Semi-tall cabinet	Height 880 mm	1	# DL 1288 L 69 69
5 Mirror with lighting	Width 1000 mm	1	# DL 7243 0 00 00
C Vero 800 mm		1	# 045480 00 27

Delos Design by E00S

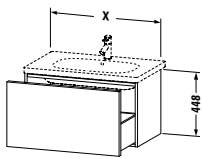
Description	mm	Model-No.	Euro	
			Pricegroup 1	Pricegroup 2
 <p>Vanity unit wall-mounted 1 pull-out compartment</p> <p>for Darling New # 049953 500 x 426 DL 6230 for Darling New # 049963 600 x 516 DL 6231 for Darling New # 049983 800 x 541 DL 6232 for Darling New # 049910 1000 x 541 DL 6233</p>  <p>Additional modules Interior system for pull-out compartment in maple or walnut solid wood for cabinet widths 550 - 650 mm for cabinet widths 750 - 950 mm for cabinet widths 1000 - 1200 mm</p> <div style="border: 1px solid black; padding: 5px;"> <p>Infobox: Space saving siphon # 005073 is recommended / Including handleless Tip-On technology / Required specification for ordering: - interior system yes / no - maple or walnut</p> </div>				
 <p>Vanity unit wall-mounted 2 drawers, upper drawer including cut-out for siphon and siphon cover</p> <p>for Darling New # 049953 500 x 426 DL 6330 for Darling New # 049963 600 x 516 DL 6331 for Darling New # 049983 800 x 541 DL 6332 for Darling New # 049910 1000 x 541 DL 6333</p>  <p>Additional modules Interior system for drawer in maple or walnut solid wood including siphon cut-out for cabinet widths 550 - 650 mm including siphon cut-out for cabinet widths 750 - 950 mm including siphon cut-out for cabinet widths 1000 - 1200 mm without siphon cut-out for cabinet widths 550 - 650 mm without siphon cut-out for cabinet widths 750 - 950 mm without siphon cut-out for cabinet widths 1000 - 1200 mm</p> <div style="border: 1px solid black; padding: 5px;"> <p>Infobox: Including handleless Tip-On technology / Required specification for ordering: - interior system yes / no - maple or walnut</p> </div>				

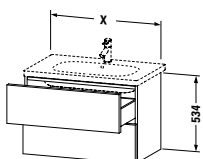
Delos Design by E00S

Description	mm	Model-No.	Euro																					
			Pricegroup 1	Pricegroup 2																				
 <p>Vanity unit wall-mounted 1 pull-out compartment</p> <table border="1"> <tr> <td>for D-Code # 034265</td> <td>600 x 460</td> <td>DL 6234</td> <td></td> <td></td> </tr> <tr> <td>for D-Code # 034285</td> <td>800 x 460</td> <td>DL 6235</td> <td></td> <td></td> </tr> <tr> <td>for D-Code # 034210</td> <td>1000 x 460</td> <td>DL 6236</td> <td></td> <td></td> </tr> <tr> <td>for D-Code # 034812</td> <td>1150 x 460</td> <td>DL 6237</td> <td></td> <td></td> </tr> </table>	for D-Code # 034265	600 x 460	DL 6234			for D-Code # 034285	800 x 460	DL 6235			for D-Code # 034210	1000 x 460	DL 6236			for D-Code # 034812	1150 x 460	DL 6237						
for D-Code # 034265	600 x 460	DL 6234																						
for D-Code # 034285	800 x 460	DL 6235																						
for D-Code # 034210	1000 x 460	DL 6236																						
for D-Code # 034812	1150 x 460	DL 6237																						
 <p>Additional modules Interior system for pull-out compartment in maple or walnut solid wood for cabinet widths 550 - 650 mm for cabinet widths 750 - 950 mm for cabinet widths 1000 - 1200 mm</p>																								
<p>Infobox: Space saving siphon # 005073 is recommended / Including handleless Tip-On technology / Required specification for ordering: - interior system yes / no - maple or walnut</p>																								
 <p>Vanity unit wall-mounted 2 drawers, upper drawer including cut-out for siphon and siphon cover</p> <table border="1"> <tr> <td>for D-Code # 034265</td> <td>600 x 460</td> <td>DL 6334</td> <td></td> <td></td> </tr> <tr> <td>for D-Code # 034285</td> <td>800 x 460</td> <td>DL 6335</td> <td></td> <td></td> </tr> <tr> <td>for D-Code # 034210</td> <td>1000 x 460</td> <td>DL 6336</td> <td></td> <td></td> </tr> <tr> <td>for D-Code # 034812</td> <td>1150 x 460</td> <td>DL 6337</td> <td></td> <td></td> </tr> </table>	for D-Code # 034265	600 x 460	DL 6334			for D-Code # 034285	800 x 460	DL 6335			for D-Code # 034210	1000 x 460	DL 6336			for D-Code # 034812	1150 x 460	DL 6337						
for D-Code # 034265	600 x 460	DL 6334																						
for D-Code # 034285	800 x 460	DL 6335																						
for D-Code # 034210	1000 x 460	DL 6336																						
for D-Code # 034812	1150 x 460	DL 6337																						
 <p>Additional modules Interior system for drawer in maple or walnut solid wood including siphon cut-out for cabinet widths 550 - 650 mm including siphon cut-out for cabinet widths 750 - 950 mm including siphon cut-out for cabinet widths 1000 - 1200 mm without siphon cut-out for cabinet widths 550 - 650 mm without siphon cut-out for cabinet widths 750 - 950 mm without siphon cut-out for cabinet widths 1000 - 1200 mm</p>																								
<p>Infobox: Including handleless Tip-On technology / Required specification for ordering: - interior system yes / no - maple or walnut</p>																								

Delos Design by E00S

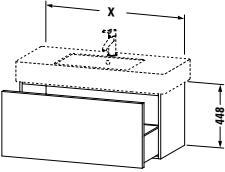
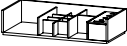
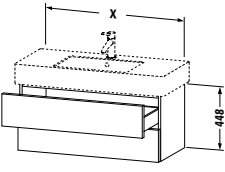
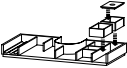
Description	mm	Model-No.	Euro	
			Pricegroup 1	Pricegroup 2
 <p>Vanity unit wall-mounted 1 pull-out compartment for Vero # 032985 (not ground) 800 x 470 DL 6220 for Vero # 032910 (not ground) 1000 x 470 DL 6221 for Vero # 032912 (not ground) 1200 x 470 DL 6222</p>				
 <p>Additional modules Interior system for pull-out compartment in maple or walnut solid wood for cabinet widths 750 - 950 mm for cabinet widths 1000 - 1200 mm</p>				
<div style="border: 1px solid black; padding: 5px;"> <p>Infobox: Space saving siphon # 005073 is recommended / Including handleless Tip-On technology / Required specification for ordering: - interior system yes / no - maple or walnut</p> </div>				
 <p>Vanity unit wall-mounted 2 drawers, upper drawer including cut-out for siphon and siphon cover for Vero # 032985 (not ground) 800 x 470 DL 6320 for Vero # 032910 (not ground) 1000 x 470 DL 6321 for Vero # 032912 (not ground) 1200 x 470 DL 6322</p>				
 <p>Additional modules Interior system for drawer in maple or walnut solid wood including siphon cut-out for cabinet widths 750 - 950 mm including siphon cut-out for cabinet widths 1000 - 1200 mm without siphon cut-out for cabinet widths 750 - 950 mm without siphon cut-out for cabinet widths 1000 - 1200 mm</p>				
<div style="border: 1px solid black; padding: 5px;"> <p>Infobox: Including handleless Tip-On technology / Required specification for ordering: - interior system yes / no - maple or walnut</p> </div>				

Delos Design by E00S

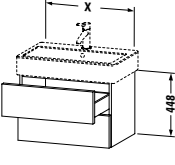
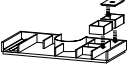
Description	mm	Model-No.	Euro	
			Pricegroup 1	Pricegroup 2
 <p>Vanity unit wall-mounted 1 pull-out compartment</p> <p>for Vero # 045450 (not ground) 450 x 445 DL 6223 for Vero # 045460 (not ground) 550 x 445 DL 6224 for Vero # 045470 (not ground) 650 x 445 DL 6225 for Vero # 045480 (not ground) 750 x 445 DL 6226 for Vero # 045410 (not ground) 950 x 445 DL 6227 for Vero # 045412 (not ground) 1150 x 445 DL 6228</p>				
 <p>Additional modules Interior system for pull-out compartment in maple or walnut solid wood</p> <p>for cabinet widths 550 - 650 mm for cabinet widths 750 - 950 mm for cabinet widths 1000 - 1200 mm</p>				
<p>Infobox: Space saving siphon # 005073 is recommended / Including handleless Tip-On technology / Required specification for ordering: - interior system yes / no - maple or walnut</p>				
 <p>Vanity unit wall-mounted 2 drawers</p> <p>for Vero # 045450 (not ground) 450 x 445 DL 6323 for Vero # 045460 (not ground) 550 x 445 DL 6324 for Vero # 045470 (not ground) 650 x 445 DL 6325 for Vero # 045480 (not ground) 750 x 445 DL 6326 for Vero # 045410 (not ground) 950 x 445 DL 6327 for Vero # 045412 (not ground) 1150 x 445 DL 6328</p>				
 <p>Additional modules Interior system for drawer in maple or walnut solid wood</p> <p>including siphon cut-out for cabinet widths 550 - 650 mm including siphon cut-out for cabinet widths 750 - 950 mm including siphon cut-out for cabinet widths 1000 - 1200 mm without siphon cut-out for cabinet widths 550-650 without siphon cut-out for cabinet widths 750 - 950 mm without siphon cut-out for cabinet widths 1000 - 1200 mm</p>				
<p>Infobox: Including handleless Tip-On technology / Required specification for ordering: - interior system yes / no - maple or walnut</p>				

Delos Design by E00S

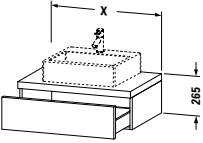
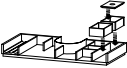
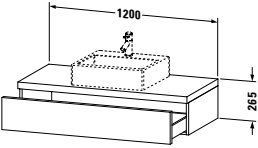
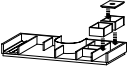
Description	mm	Model-No.	Euro	
			Pricegroup 1	Pricegroup 2
 <p>Console including drawer for wash bowls 1 countertop including one central cut-out, 1 drawer beneath console, 2 console supports</p>				
	600 x 565	DL 6787		
	800 x 565	DL 6788		
	1000 x 565	DL 6789		
 <p>Additional modules Interior system for drawer in maple or walnut solid wood including siphon cut-out for cabinet widths 550 - 650 mm including siphon cut-out for cabinet widths 750 - 950 mm including siphon cut-out for cabinet widths 1000 - 1200 mm</p>				
<p>Infobox: Space saving siphon # 005073 is recommended / Including handleless Tip-On technology / Required specification for ordering: - Model-no. ceramic, please see page 657</p>				
 <p>Console including drawer for wash bowls 1 countertop including one central cut-out, 1 drawer beneath console, 3 console supports</p>				
	1200 x 565	DL 6790		
 <p>Additional modules Interior system for drawer in maple or walnut solid wood including siphon cut-out for cabinet widths 1000 - 1200 mm</p>				
<p>Infobox: Space saving siphon # 005073 is recommended / Including handleless Tip-On technology / Required specification for ordering: - Model-no. ceramic, please see page 657</p>				

Delos Design by E00S

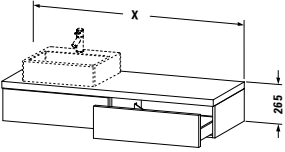
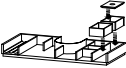
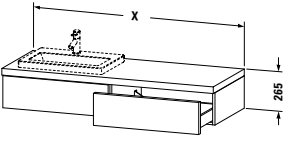
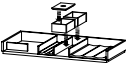
Description	mm	Model-No.	Euro	
			Pricegroup 1	Pricegroup 2
 <p>Console including drawer for wash bowls countertop including one cut-out, 2 drawers beneath console, 3 console supports</p>	<p>1500 x 565</p> <p>1800 x 565</p>	<p>DL 6791 L/R</p> <p>DL 6792 L/R</p>		
 <p>Additional modules Interior system for drawer in maple or walnut solid wood including siphon cut-out for cabinet widths 750 - 950 mm without siphon cut-out for cabinet widths 750 - 950 mm</p>				
<p>Infobox: Space saving siphon # 005073 is recommended / Including handleless Tip-On technology / Required specification for ordering: - L/R = Washbasin left or right possible - Model-no. ceramic, please see page 657</p>				
 <p>Console including drawer for vanity basin countertop including one cut-out, 1 drawer beneath console, 1 cover beneath console, 3 console supports</p>	<p>1500 x 565</p> <p>1800 x 565</p>	<p>DL 6891 L/R</p> <p>DL 6892 L/R</p>		
 <p>Additional modules Interior system for drawer in maple or walnut solid wood without siphon cut-out for cabinet widths 750 - 950 mm</p>				
<p>Infobox: Space saving siphon # 005073 is recommended / Including handleless Tip-On technology / Required specification for ordering: - L/R = Washbasin left or right possible - Model-no. ceramic, please see page 658</p>				

Delos Design by E00S

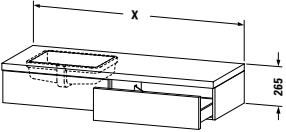
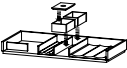
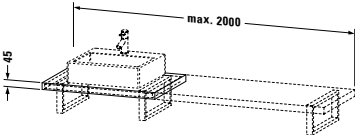
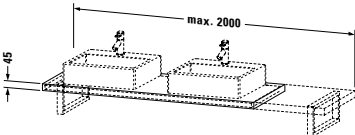
Description	mm	Model-No.	Euro	
			Pricegroup 1	Pricegroup 2
 <p>Console including drawer for undercounter basin bonded countertop including one cut-out, 1 drawer beneath console, 1 cover beneath console, 3 console supports</p>	1500 x 565 1800 x 565	DL 6991 L/R DL 6992 L/R		
 <p>Additional modules Interior system for drawer in maple or walnut solid wood without siphon cut-out for cabinet widths 750 - 950 mm</p>				
<p>Infobox: Space saving siphon # 005073 is recommended / Including handleless Tip-On technology / Required specification for ordering: - L/R = Washbasin left or right possible - Model-no. ceramic, please see page 658 / For undercounter basin bonded, following surface isn't available: 85 White High Gloss</p>				
 <p>Console for above counter basin and countertop basin 1 console with one cut-out, Width min. see ordering information, Width max 2000 mm basic price till 800 mm, for back-to-wall price per section of 100 mm</p>	565	DL 020C		
<p>Infobox: Required specification for the order: - overall width - dimension between axes from left side - model-no ceramic and min. width, please see page 665/666 - exactly position of floor cabinets / console supports Please indicate exact measures and drawings please refer to order sheet page 669</p>				
 <p>Console for above counter basin and countertop basin 1 console with two cut-outs, Width min. see ordering information, Width max 2000 mm basic price till 800 mm, for back-to-wall price per section of 100 mm</p>	565	DL 023C		
<p>Infobox: Required specification for the order: - overall width - dimension between axes from left side - model-no ceramic and min. width, please see page 665/666 - exactly position of floor cabinets / console supports Please indicate exact measures and drawings please refer to order sheet page 669</p>				

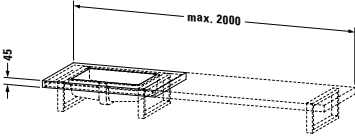
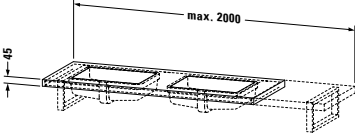
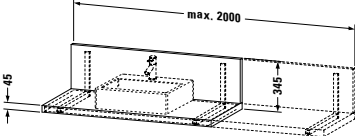

Delos Design by E00S

Description	mm	Model-No.	Euro	
			Pricegroup 1	Pricegroup 2
 <p>Console for undercounter basin bonded 1 console with one cut-out, Width min. see ordering information, Width max 2000 mm basic price till 800 mm, for back-to-wall price per section of 100 mm</p>	565	DL 030C		
<p>Infobox: Required specification for the order:</p> <ul style="list-style-type: none"> - overall width - dimension between axes from left side - model.-no ceramic and min. width, please see page 666 - exactly position of floor cabinets / console supports <p>Please indicate exact measures and drawings please refer to order sheet page 669 / For undercounter basin bonded, price includes the assembly of the washbasin on the console / For undercounter basin bonded, following surface isn't available: 85 White High Gloss</p>				
 <p>Console for undercounter basin bonded 1 console with two cut-outs, Width min. see ordering information, Width max 2000 mm basic price till 800 mm, for back-to-wall price per section of 100 mm</p>	565	DL 033C		
<p>Infobox: Required specification for the order:</p> <ul style="list-style-type: none"> - overall width - dimension between axes from left side - model.-no ceramic and min. width, please see page 666 - exactly position of floor cabinets / console supports <p>Please indicate exact measures and drawings please refer to order sheet page 669 / For undercounter basin bonded, price includes the assembly of the washbasin on the console / For undercounter basin bonded, following surface isn't available: 85 White High Gloss</p>				
 <p>Console + back panel for above counter basin and countertop basin 1 console with one cut-out, Width min. 800 mm, Width max. 2000 mm basic price till 800 mm, for back-to-wall price per section of 100 mm</p>	565	DL 040C		
<p>Infobox: including carrier system for console and rear panel / Indication of measures and drawings, please refer to order sheet page 669 / Required specification for ordering:</p> <ul style="list-style-type: none"> - overall width - dimension between axes from left side - number and position of floor cabinets - Model-no. ceramic, please see page 665/666 				

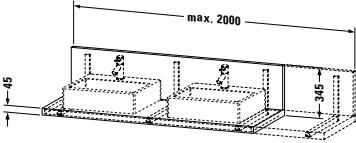
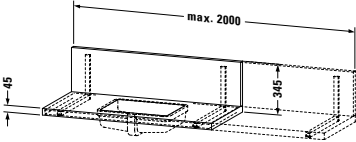
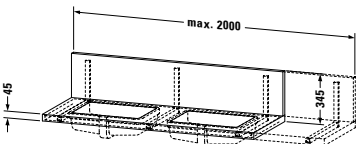
Delos Design by E00S

Description	mm	Model-No.	Euro	
			Pricegroup 1	Pricegroup 2
 <p>Console + back panel for above counter basin and countertop basin 1 console with two cut-outs, Width min. 800 mm, Width max. 2000 mm basic price till 800 mm, for back-to-wall 565 DL 043C price per section of 100 mm</p>				
<p>Infobox: including carrier system for console and rear panel / Indication of measures and drawings, please refer to order sheet page 669 / Required specification for ordering:</p> <ul style="list-style-type: none"> - overall width - dimension between axes from left side - number and position of floor cabinets - Model-no. ceramic, please see page 665/666 				
 <p>Console + back panel for undercounter basin bonded 1 console with one cut-out, Width min. 800 mm, Width max. 2000 mm basic price till 800 mm, for back-to-wall 565 DL 050C price per section of 100 mm</p>				
<p>Infobox: including carrier system for console and rear panel / Indication of measures and drawings, please refer to order sheet page 669 / Required specification for ordering:</p> <ul style="list-style-type: none"> - overall width - dimension between axes from left side - number and position of floor cabinets - Model-no. ceramic, please see page 666 <p>For undercounter basin bonded, following surface isn't available: 85 White High Gloss</p>				
 <p>Console + back panel for undercounter basin bonded 1 console with two cut-outs, Width min. 800 mm, Width max. 2000 mm basic price till 800 mm, for back-to-wall 565 DL 053C price per section of 100 mm</p>				
<p>Infobox: including carrier system for console and rear panel / Indication of measures and drawings, please refer to order sheet page 669 / Required specification for ordering:</p> <ul style="list-style-type: none"> - overall width - dimension between axes from left side - number and position of floor cabinets - Model-no. ceramic, please see page 666 <p>For undercounter basin bonded, following surface isn't available: 85 White High Gloss</p>				

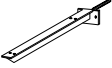
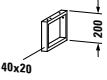
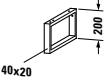
Delos Design by E00S

Description	mm	Model-No.	Euro	
			Pricegroup 1	Pricegroup 2
 <p>Console Support 1 console support-bracket, mountable beneath console grey, powder-coated</p>	40 x 425	DL 9902		
 <p>Console support 100 mm installation in wall 1 console support (depth without pin) grey, powder-coated</p>	90 x 420	DL 9926		
Infobox: For using console support on a drywall, a suitable subconstruction is required				
 <p>Console Support 1 console support-towel rail, for installation beneath a depth reduced console chrome</p>	40 x 340	DL 9904		
 <p>Console Support 1 console support-towel rail, mountable beneath console chrome</p>	40 x 480	DL 9903		
 <p>Towel rail Surface chrome with Duravit Logo (on both sides)</p>	52 x 565	DL 9990		

Delos Design by E00S

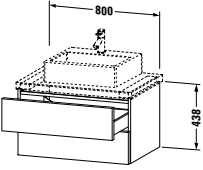
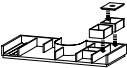
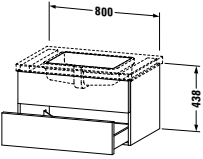
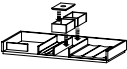
Description	mm	Model-No.	Euro	
			Pricegroup 1	Pricegroup 2
 <p>Vanity unit for console 2 drawers, upper drawer including cut-out for siphon and siphon cover</p>	800 x 565	DL 6799		
 <p>Additional modules Interior system for drawer in maple or walnut solid wood including siphon cut-out for cabinet widths 750 - 950 mm without siphon cut-out for cabinet widths 750 - 950 mm</p>				
<p>Infobox: Console not included in delivery, please order separately / Highriser are not applicable / Including handleless Tip-On technology / Required specification for ordering: - interior system yes / no - maple or walnut</p>				
 <p>Vanity unit wall-mounted for undercounter basin bonded 1 cover 1 drawer</p>	800 x 565	DL 6899		
 <p>Additional modules Interior system for drawer in maple or walnut solid wood without siphon cut-out for cabinet widths 750 - 950 mm</p>				
<p>Infobox: Including handleless Tip-On technology / Required specification for ordering: - interior system yes / no - maple or walnut</p>				

Delos Design by E00S

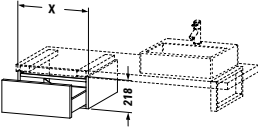
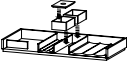
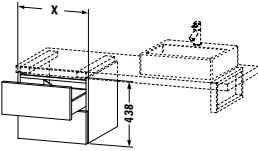
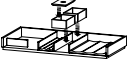
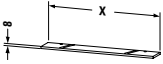
Description	mm	Model-No.	Euro	
			Pricegroup 1	Pricegroup 2
				
Low cabinet for console				
1 drawer				
	500 x 565	DL 6746		
	600 x 565	DL 6747		
				
Additional modules				
Interior system for drawer in maple or walnut solid wood without siphon cut-out for cabinet widths 550-650 mm				
Infobox: Console not included in delivery, please order separately / Including handleless Tip-On technology / Required specification for ordering: - interior system yes / no - maple or walnut				
				
Low cabinet for console				
2 drawers				
	500 x 565	DL 6846		
	600 x 565	DL 6847		
				
Additional modules				
Interior system for drawer in maple or walnut solid wood without siphon cut-out for cabinet widths 550-650 mm				
Infobox: Console not included in delivery, please order separately / Including handleless Tip-On technology / Required specification for ordering: - interior system yes / no - maple or walnut				
				
Glass shelf				
fixings included, 1 glass shelf, Clear glass, Material thickness = 8 mm, Width min. 400 mm, Width max. 1200 mm				
basic price for 600 mm	130	DL 9905		
price per section of 100 mm				

Delos Design by E00S

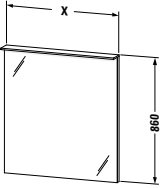
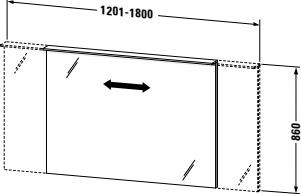
Description	mm	Model-No.	Euro	
			Pricegroup 1	Pricegroup 2
				
Mirror with lighting				
IP 44,				
1 sensor switch optional L/R/0				
LED module 3500 Kelvin light colour, 11 W	450 x 36/105	DL 7240 L/R/0		
LED module 3500 Kelvin light colour, 15 W	600 x 36/105	DL 7241 L/R/0		
LED module 3500 Kelvin light colour, 20 W	800 x 36/105	DL 7242 L/R/0		
LED module 3500 Kelvin light colour, 26 W	1000 x 36/105	DL 7243 L/R/0		
LED module 3500 Kelvin light colour, 33 W	1200 x 36/105	DL 7244 L/R/0		
Additional modules				
LED dimming function				
Infobox: Distance between sensor and reflecting surfaces = minimum 75 mm / L = sensor switch left R = sensor switch right 0 = without sensor switch (for console + back panel in niche)				
				
Mirror with lighting (width variable)				
IP 44,				
1 sensor switch optional L/R/0				
LED module 3500 Kelvin light colour, 33-51 W	1201-1800 x 36/105	DL 7246 L/R/0		
Additional modules				
LED dimming function				
Infobox: Distance between sensor and reflecting surfaces = minimum 75 mm / L = sensor switch left R = sensor switch right 0 = without sensor switch (for console + back panel in niche)				

Delos Design by E00S

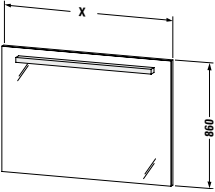
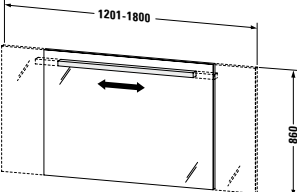
Description	mm	Model-No.	Euro																										
			Pricegroup 1	Pricegroup 2																									
 <p>Mirror with lighting IP 44, 1 sensor switch optional L/R/0, T5 lighting 3500 kelvin light colour</p> <table border="1"> <tr> <td>1 lamp 430 mm, 8 W</td> <td>450 x 23/76</td> <td>DL 7340 L/R/0</td> <td></td> <td></td> </tr> <tr> <td>1 lamp 430 mm, 8 W</td> <td>600 x 23/76</td> <td>DL 7341 L/R/0</td> <td></td> <td></td> </tr> <tr> <td>1 lamp 630 mm, 13 W</td> <td>800 x 23/76</td> <td>DL 7342 L/R/0</td> <td></td> <td></td> </tr> <tr> <td>1 lamp 630 mm, 13 W</td> <td>1000 x 23/76</td> <td>DL 7343 L/R/0</td> <td></td> <td></td> </tr> <tr> <td>1 lamp 960 mm, 21 W</td> <td>1200 x 23/76</td> <td>DL 7344 L/R/0</td> <td></td> <td></td> </tr> </table>	1 lamp 430 mm, 8 W	450 x 23/76	DL 7340 L/R/0			1 lamp 430 mm, 8 W	600 x 23/76	DL 7341 L/R/0			1 lamp 630 mm, 13 W	800 x 23/76	DL 7342 L/R/0			1 lamp 630 mm, 13 W	1000 x 23/76	DL 7343 L/R/0			1 lamp 960 mm, 21 W	1200 x 23/76	DL 7344 L/R/0						
1 lamp 430 mm, 8 W	450 x 23/76	DL 7340 L/R/0																											
1 lamp 430 mm, 8 W	600 x 23/76	DL 7341 L/R/0																											
1 lamp 630 mm, 13 W	800 x 23/76	DL 7342 L/R/0																											
1 lamp 630 mm, 13 W	1000 x 23/76	DL 7343 L/R/0																											
1 lamp 960 mm, 21 W	1200 x 23/76	DL 7344 L/R/0																											
<p>Infobox: Distance between sensor and reflecting surfaces = minimum 75 mm / L = sensor switch left R = sensor switch right 0 = without sensor switch (for console + back panel in niche)</p>																													
 <p>Mirror with lighting (width variable) IP 44, 1 sensor switch optional L/R/0, T5 lighting 3500 kelvin light colour, 21 W, for width 1201 - 1500 mm fluorescent tube central and 960 mm long, for width 1501 - 1800 mm fluorescent tube central and 1270 mm long</p> <table border="1"> <tr> <td></td> <td>1201-1800 x 23/76</td> <td>DL 7346 L/R/0</td> <td></td> <td></td> </tr> </table>		1201-1800 x 23/76	DL 7346 L/R/0																										
	1201-1800 x 23/76	DL 7346 L/R/0																											
<p>Infobox: Distance between sensor and reflecting surfaces = minimum 75 mm / L = sensor switch left R = sensor switch right 0 = without sensor switch (for console + back panel in niche)</p>																													

Delos Design by E00S

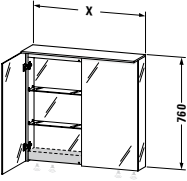
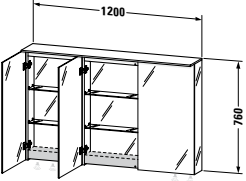
Description	mm	Model-No.	Euro	
			Pricegroup 1	Pricegroup 2
 <p>Mirror cabinet IP 44, 2 mirror doors, back panel inside mirror glass, 2 glass shelves (clear glass), 1 sensor switch bottom right, one socket unit with flap lid in top end</p>				
LED module 3500 Kelvin light colour, 13 W	600 x 138/208	DL 7541		
LED module 3500 Kelvin light colour, 20 W	800 x 138/208	DL 7542		
LED module 3500 Kelvin light colour, 26 W	1000 x 138/208	DL 7543		
LED module 3500 Kelvin light colour, 13 W incl. Soundsystem	600 x 138/208	DL 7641		
LED module 3500 Kelvin light colour, 20 W incl. Soundsystem	800 x 138/208	DL 7642		
LED module 3500 Kelvin light colour, 26 W incl. Soundsystem	1000 x 138/208	DL 7643		
Additional modules LED dimming function				
Infobox: Distance between sensor and reflecting surfaces = minimum 75 mm / LED dimming function is already included in the mirror cabinet with Soundsystem				
 <p>Mirror cabinet IP 44, 3 mirror doors, back panel inside mirror glass, 4 glass shelves (clear glass), 1 sensor switch bottom right, one socket unit with flap lid in top end</p>				
LED module 3500 Kelvin light colour, 31 W	1200 x 138/208	DL 7544		
LED module 3500 Kelvin light colour, 31 W incl. Soundsystem	1200 x 138/208	DL 7644		
Additional modules LED dimming function				
Infobox: Distance between sensor and reflecting surfaces = minimum 75 mm / LED dimming function is already included in the mirror cabinet with Soundsystem				

Delos Design by E00S

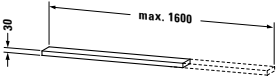
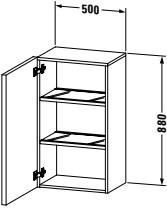
Description	mm	Model-No.	Euro	
			Pricegroup 1	Pricegroup 2
 <p>Box in maple or walnut solid wood 1 Box, Material mix in acryl glass and solild wood (optionally in maple or walnut)</p>	185 x 100	DL 9910		
<p>Infobox: Maximum use of space per shelf crosswise: 600 mm = 3 pieces/ 800mm = 4 pieces/ 1000 mm = 5 pieces/ 1200 mm = 6 pieces / Required specification for ordering: - surface</p>				
 <p>Wall board 1 shelf, fixation with locking pin, Width min. 600 mm, Width max. 1600 mm</p>	600-1600 x 130	DL 7910		
<p>Infobox: Material thickness = 30 mm</p>				
 <p>Semi-tall cabinet 2 glass shelves with alu carrier system</p>	500 x 250 500 x 370	DL 1288 L/R DL 1289 L/R		
<p>Infobox: Attention should be paid to the overhang of 18 mm, depending on hinge left (L) / right (R) / Required specification for ordering: - Hinges left (L) / right (R)</p>				

Delos Design by E00S

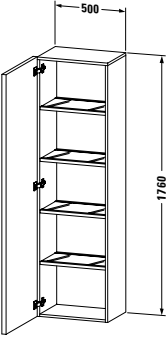
Description	mm	Model-No.	Euro	
			Pricegroup 1	Pricegroup 2
 <p>Tall cabinet 4 glass shelves with alu carrier system</p>	500 x 250	DL 1290 L/R		
	500 x 370	DL 1291 L/R		
	<p>Infobox: Attention should be paid to the overhang of 18 mm, depending on hinge left (L) / right (R) / Please keep 30 mm space to the wall / Required specification for ordering: - Hinges left (L) / right (R)</p>			

DuraStyle Design by Matteo Thun

Product Information

Fronts	Decor	18 White Matt 43 Basalt Matt 52 European Oak 53 Chestnut Dark	High-compressed three-ply chipboard, directly coated with melamine resin decor on both sides, ABS-Edge material. Surface resistant to moisture.
Body	Decor	18 White Matt 43 Basalt Matt 52 European Oak 53 Chestnut Dark	High-compressed three-ply chipboard, directly coated with melamine resin decor on both sides, ABS-Edge material. Surface resistant to moisture. Handel cover integrated, execution corpus colour.
Consoles	Decor	18 White Matt 43 Basalt Matt 52 European Oak 53 Chestnut Dark	Base: solid wood, multiplex curved pasted plywood, with laminate (HPL) pressed on both sides, all edges and cutouts for towels consists of plywood, waterproofed sealed with oil (colour-coordinated to the laminate). Surface resistant to moisture.
Mirror with lighting			LED light technology, 3500 Kelvin light colour. Sensor switch bottom right for on/off function.
Edges mirror ground plate	Decor	37 White Aluminium	ABS-edge material
Body furniture accessoires	Real wood massive (Pricegroup 1)	76 European Oak solid wood	Body frame massive lacquered.
	Real wood massive (Pricegroup 2)	77 Americ. Walnut solid wood	Body frame massive lacquered.
Shelf furniture accessoires	Decor	18 White Matt 43 Basalt Matt	Shelves from high-compressed three-ply chipboard with melamine resin decor pressed on both sides, ABS-Edge material. Surface resistant to moisture.
Seat Cushion		White	Synthetic Leather

Ordering Sample

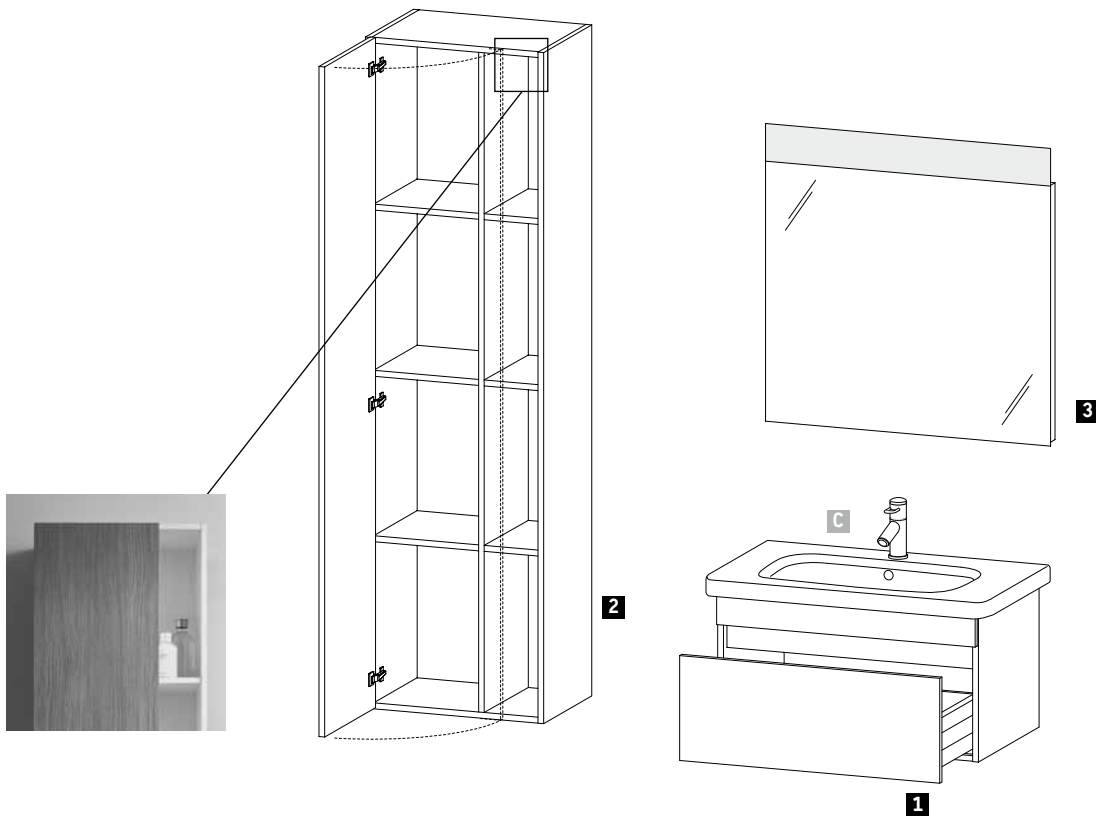

DuraStyle
 Vanity Unit
 Tall cabinet
 Mirror with lighting

53 Chestnut dark
43 Basalte Matt

Description	Remark	Quantity	Model-No.
1 Vanity unit wall-mounted	Width 730 mm	1	# DS 6381 0 53 43
2 Tall cabinet	Width 500 mm	1	# DS 1249 L 53 43
3 Mirror with lighting	Width 800 mm	1	# DS 7268 0 00 00
C DuraStyle 800 mm		1	# 232080 00 00

DuraStyle Design by Matteo Thun

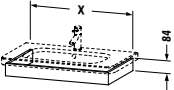
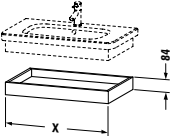
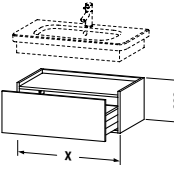
Description	mm	Model-No.	Euro	
			Pricegroup 1	Pricegroup 2
				
Washbasin trim				
for DuraStyle # 232065	580 x 448	DS 6080		
for DuraStyle # 232080	730 x 448	DS 6081		
for DuraStyle # 232010	930 x 448	DS 6082		
for DuraStyle # 232012	1130 x 448	DS 6083		
Infobox: Height of Washbasin trim = 84 mm				
				
Shelf wall-mounted				
included console support # DS 9926				
for DuraStyle # 232065	580 x 448	DS 6180		
for DuraStyle # 232080	730 x 448	DS 6181		
for DuraStyle # 232010	930 x 448	DS 6182		
for DuraStyle # 232012	1130 x 448	DS 6183		
Infobox: Required specification for ordering: - Body colour - surface inlaying plate / height shelf = 84 mm				
				
Low cabinet				
1 pull-out compartment				
for DuraStyle # 232065	580 x 448	DS 6280		
for DuraStyle # 232080	730 x 448	DS 6281		
for DuraStyle # 232010	930 x 448	DS 6282		
for DuraStyle # 232012	1130 x 448	DS 6283		
Infobox: Required specification for ordering: - Body colour - surface inlaying plate				

DuraStyle Design by Matteo Thun

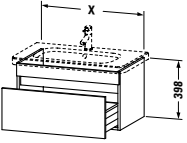
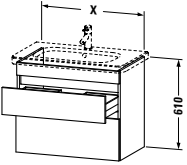
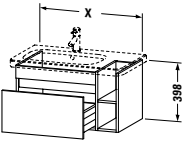
Description	mm	Model-No.	Euro	
			Pricegroup 1	Pricegroup 2
 <p>Vanity unit wall-mounted 1 pull-out compartment</p>				
for DuraStyle # 232065	580 x 448	DS 6380		
for DuraStyle # 232080	730 x 448	DS 6381		
for DuraStyle # 232010	930 x 448	DS 6382		
for DuraStyle # 232012	1130 x 448	DS 6395		
Infobox: Required specification for ordering: - Front colour - Body colour				
 <p>Vanity unit wall-mounted 2 drawers, upper drawer including cut-out for siphon and siphon cover</p>				
for DuraStyle # 232065	580 x 448	DS 6480		
for DuraStyle # 232080	730 x 448	DS 6481		
for DuraStyle # 232010	930 x 448	DS 6482		
for DuraStyle # 232012	1130 x 448	DS 6495		
Infobox: Required specification for ordering: - Front colour - Body colour				
 <p>Vanity unit wall-mounted 1 pull-out compartment</p>				
for DuraStyle # 232680 basin right	730 x 448	DS 6393		
for DuraStyle # 232580 basin left	730 x 448	DS 6394		
for DuraStyle # 232610 basin right	930 x 448	DS 6396		
for DuraStyle # 232510 basin left	930 x 448	DS 6397		

DuraStyle Design by Matteo Thun

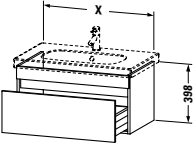
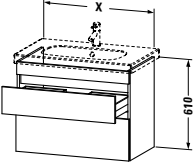
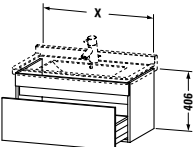
Description	mm	Model-No.	Euro																					
			Pricegroup 1	Pricegroup 2																				
 <p>Vanity unit wall-mounted 1 pull-out compartment</p> <table border="1"> <tr> <td>for D-Code # 034265</td> <td>600 x 453</td> <td>DS 6383</td> <td></td> <td></td> </tr> <tr> <td>for D-Code # 034285</td> <td>800 x 453</td> <td>DS 6384</td> <td></td> <td></td> </tr> <tr> <td>for D-Code # 034210</td> <td>1000 x 453</td> <td>DS 6385</td> <td></td> <td></td> </tr> <tr> <td>for D-Code # 034812</td> <td>1150 x 453</td> <td>DS 6386</td> <td></td> <td></td> </tr> </table> <p>Infobox: Required specification for ordering: - Front colour - Body colour</p>	for D-Code # 034265	600 x 453	DS 6383			for D-Code # 034285	800 x 453	DS 6384			for D-Code # 034210	1000 x 453	DS 6385			for D-Code # 034812	1150 x 453	DS 6386						
for D-Code # 034265	600 x 453	DS 6383																						
for D-Code # 034285	800 x 453	DS 6384																						
for D-Code # 034210	1000 x 453	DS 6385																						
for D-Code # 034812	1150 x 453	DS 6386																						
 <p>Vanity unit wall-mounted 2 drawers, upper drawer including cut-out for siphon and siphon cover</p> <table border="1"> <tr> <td>for D-Code # 034265</td> <td>600 x 453</td> <td>DS 6483</td> <td></td> <td></td> </tr> <tr> <td>for D-Code # 034285</td> <td>800 x 453</td> <td>DS 6484</td> <td></td> <td></td> </tr> <tr> <td>for D-Code # 034210</td> <td>1000 x 453</td> <td>DS 6485</td> <td></td> <td></td> </tr> <tr> <td>for D-Code # 034812</td> <td>1150 x 453</td> <td>DS 6486</td> <td></td> <td></td> </tr> </table> <p>Infobox: Required specification for ordering: - Front colour - Body colour</p>	for D-Code # 034265	600 x 453	DS 6483			for D-Code # 034285	800 x 453	DS 6484			for D-Code # 034210	1000 x 453	DS 6485			for D-Code # 034812	1150 x 453	DS 6486						
for D-Code # 034265	600 x 453	DS 6483																						
for D-Code # 034285	800 x 453	DS 6484																						
for D-Code # 034210	1000 x 453	DS 6485																						
for D-Code # 034812	1150 x 453	DS 6486																						
 <p>Vanity unit wall-mounted 1 pull-out compartment</p> <table border="1"> <tr> <td>for Starck 3 # 030470</td> <td>650 x 470</td> <td>DS 6387</td> <td></td> <td></td> </tr> <tr> <td>for Starck 3 # 030480</td> <td>800 x 470</td> <td>DS 6388</td> <td></td> <td></td> </tr> <tr> <td>for Starck 3 # 030410</td> <td>1000 x 470</td> <td>DS 6389</td> <td></td> <td></td> </tr> <tr> <td>for Starck 3 # 033213</td> <td>1200 x 470</td> <td>DS 6390</td> <td></td> <td></td> </tr> </table> <p>Infobox: Required specification for ordering: - Front colour - Body colour</p>	for Starck 3 # 030470	650 x 470	DS 6387			for Starck 3 # 030480	800 x 470	DS 6388			for Starck 3 # 030410	1000 x 470	DS 6389			for Starck 3 # 033213	1200 x 470	DS 6390						
for Starck 3 # 030470	650 x 470	DS 6387																						
for Starck 3 # 030480	800 x 470	DS 6388																						
for Starck 3 # 030410	1000 x 470	DS 6389																						
for Starck 3 # 033213	1200 x 470	DS 6390																						

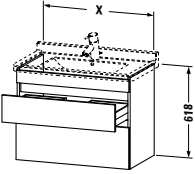
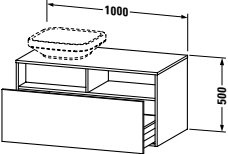
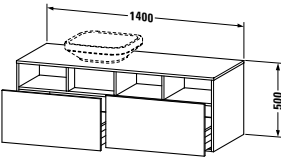

DuraStyle Design by Matteo Thun

Description	mm	Model-No.	Euro																					
			Pricegroup 1	Pricegroup 2																				
 <p>Vanity unit wall-mounted 2 drawers, upper drawer including cut-out for siphon and siphon cover</p> <table border="1"> <tr> <td>for Starck 3 # 030470</td> <td>650 x 470</td> <td>DS 6487</td> <td></td> <td></td> </tr> <tr> <td>for Starck 3 # 030480</td> <td>800 x 470</td> <td>DS 6488</td> <td></td> <td></td> </tr> <tr> <td>for Starck 3 # 030410</td> <td>1000 x 470</td> <td>DS 6489</td> <td></td> <td></td> </tr> <tr> <td>for Starck 3 # 033213</td> <td>1200 x 470</td> <td>DS 6490</td> <td></td> <td></td> </tr> </table>	for Starck 3 # 030470	650 x 470	DS 6487			for Starck 3 # 030480	800 x 470	DS 6488			for Starck 3 # 030410	1000 x 470	DS 6489			for Starck 3 # 033213	1200 x 470	DS 6490						
for Starck 3 # 030470	650 x 470	DS 6487																						
for Starck 3 # 030480	800 x 470	DS 6488																						
for Starck 3 # 030410	1000 x 470	DS 6489																						
for Starck 3 # 033213	1200 x 470	DS 6490																						
<p>Infobox: Required specification for ordering: - Front colour - Body colour</p>																								
 <p>Vanity unit wall-mounted 1 pull-out compartment countertop including one cut-out</p> <table border="1"> <tr> <td></td> <td>1000 x 550</td> <td>DS 6784 L/R</td> <td></td> <td></td> </tr> </table>		1000 x 550	DS 6784 L/R																					
	1000 x 550	DS 6784 L/R																						
<p>Infobox: Required specification for ordering: - Front colour - Body colour - L/R = Washbasin left or right possible - Model-no. ceramic, please see page 661 / Space saving siphon # 005073 is recommended / # 037243 for tap hole sideways or for wall mounted tap fitting</p>																								
 <p>Vanity unit wall-mounted 2 pull-out compartments 1 console with one cut-out</p> <table border="1"> <tr> <td></td> <td>1400 x 550</td> <td>DS 6785 L/R</td> <td></td> <td></td> </tr> </table>		1400 x 550	DS 6785 L/R																					
	1400 x 550	DS 6785 L/R																						
<p>Infobox: Required specification for ordering: - Front colour - Body colour - L/R = Washbasin left or right possible - Model-no. ceramic, please see page 661 / Space saving siphon # 005073 is recommended / # 037243 for tap hole sideways or for wall mounted tap fitting</p>																								

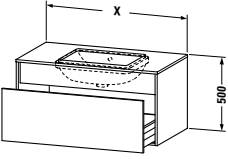
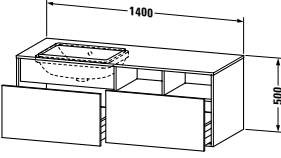
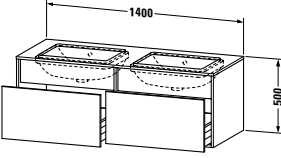

DuraStyle Design by Matteo Thun

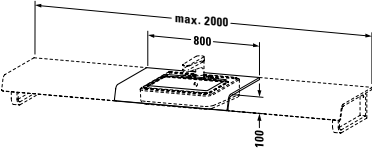
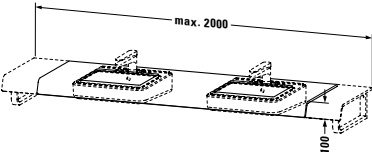
Description	mm	Model-No.	Euro	
			Pricegroup 1	Pricegroup 2
 <p>Vanity unit wall-mounted for undercounter basin bonded 1 pull-out compartment, for 1 undercounter basin bonded, central incl. siphon cover</p>	<p>800 x 550</p> <p>1000 x 550</p>	<p>DS 6883</p> <p>DS 6884</p>		
<p>Infobox: Required specification for ordering:</p> <ul style="list-style-type: none"> - Front colour - Body colour - Model-no. ceramic, please see page 661 / Space saving siphon # 005073 is recommended 				
 <p>Vanity unit wall-mounted for undercounter basin bonded 2 pull-out compartments for 1 undercounter basin bonded, inclusive siphon cover</p>	<p>1400 x 550</p>	<p>DS 6885 L/R</p>		
<p>Infobox: Required specification for ordering:</p> <ul style="list-style-type: none"> - Front colour - Body colour - L/R = Washbasin left or right possible - Model-no. ceramic, please see page 661 / Space saving siphon # 005073 is recommended 				
 <p>Vanity unit wall-mounted for undercounter basin bonded 2 pull-out compartments for 2 undercounter basins bonded, inclusive siphon cover</p>	<p>1400 x 550</p>	<p>DS 6885 B</p>		
<p>Infobox: Required specification for ordering:</p> <ul style="list-style-type: none"> - Front colour - Body colour - B = basin on both sides - Model-no. ceramic, please see page 661 / Space saving siphon # 005073 is recommended 				

DuraStyle Design by Matteo Thun

Description	mm	Model-No.	Euro	
			Pricegroup 1	Pricegroup 2
 <p>Console 1 console with one cut-out, Width min. see ordering information, Width max 2000 mm basic price till 800 mm price per section of 100 mm</p>	550	DS 828C		
<p>Additional modules Towel rail cutout in splay or console surface</p>				
<p>Infobox: Indication of measures and drawings, please refer to order sheet page 672 / Required specification for ordering:</p> <ul style="list-style-type: none"> - overall width - dimension between axes from left side - number and position of floor cabinets - number and position of console supports - Vanity units are not mountable together - Model-no. ceramic, please see page 670 - 0, 1 or 3 tap holes / For additional towel rail cutout please note ordering information, see page 671 / Consoles with a width of more than 2001 mm, price on request 				
 <p>Console 1 console with two cut-outs, Width min. see ordering information, Width max 2000 mm basic price till 800 mm price per section of 100 mm</p>	550	DS 829C		
<p>Additional modules Towel rail cutout in splay or console surface</p>				
<p>Infobox: Indication of measures and drawings, please refer to order sheet page 672 / Required specification for ordering:</p> <ul style="list-style-type: none"> - overall width - dimension between axes from left side - number and position of floor cabinets - number and position of console supports - Vanity units are not mountable together - Model-no. ceramic, please see page 670 - 0, 1 or 3 tap holes / For additional towel rail cutout please note ordering information, see page 671 / Consoles with a width of more than 2001 mm, price on request 				
 <p>Console Support 1 console support-bracket, mountable beneath console grey, powder-coated</p>	40 x 425	DS 9902		

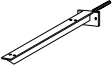
DuraStyle Design by Matteo Thun

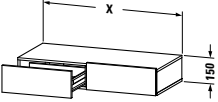
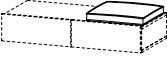
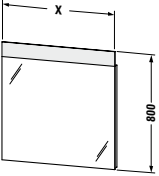
Description	mm	Model-No.	Euro	
			Pricegroup 1	Pricegroup 2
 <p>Console support 100 mm installation in wall 1 console support (depth without pin) grey, powder-coated</p>	420 x 90	DS 9926		
Infobox: For using the console support for a dry lining wall, it's necessary to arm the wall				
 <p>Console Support 1 console support-towel rail, mountable beneath console chrome</p>	40 x 480	DS 9933		
 <p>Shelf with drawer incl. console supports</p>				
2 drawers	1000 x 440	DS 8270		
2 drawers	1200 x 440	DS 8271		
3 drawers	1500 x 440	DS 8272		
3 drawers	1800 x 440	DS 8273		
 <p>Seat cushion for shelf with drawer</p>	400 x 400	DS 9938		
 <p>Mirror with lighting IP 44, 1 sensor switch bottom right</p>				
LED module 3500 Kelvin light colour, 11 W	440 x 40	DS 7266		
LED module 3500 Kelvin light colour, 14 W	600 x 40	DS 7267		
LED module 3500 Kelvin light colour, 18 W	800 x 40	DS 7268		
LED module 3500 Kelvin light colour, 22 W	1000 x 40	DS 7269		
LED module 3500 Kelvin light colour, 28 W	1200 x 40	DS 7270		
LED module 3500 Kelvin light colour, 33 W	1400 x 40	DS 7271		
<p>Additional modules LED dimming function</p>				
Infobox: Distance between sensor and reflecting surfaces = minimum 75 mm				

DuraStyle Design by Matteo Thun

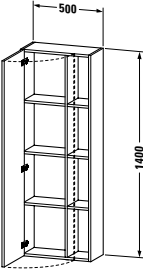
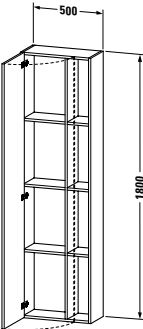
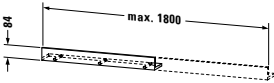
Description	mm	Model-No.	Euro	
			Pricegroup 1	Pricegroup 2
 <p>Tall cabinet 1 revolving door, 3 shelves</p>	<p>500 x 240</p> <p>500 x 360</p>	<p>DS 1238 L/R</p> <p>DS 1239 L/R</p>		
Infobox: Please keep 20 mm space to the wall / In case of extension to furniture a space of 20 mm is necessary / Required specification for ordering: - Hinges left (L) / right (R)				
 <p>Tall cabinet 1 revolving door, 3 shelves</p>	<p>500 x 240</p> <p>500 x 360</p>	<p>DS 1248 L/R</p> <p>DS 1249 L/R</p>		
Infobox: Please keep 20 mm space to the wall / In case of extension to furniture a space of 20 mm is necessary / Required specification for ordering: - Hinges left (L) / right (R)				
 <p>Wall board 1 shelf, fixation with locking pin, Width max. 1800 mm Basic price till 600 mm price per section of 100 mm</p>	<p>600 - 1800 x 130</p>	<p>DS 7911</p>		
Infobox: Material thickness = 16 mm				

DuraStyle Design by Matteo Thun

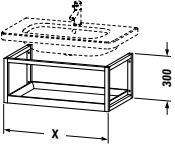
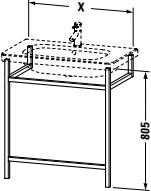
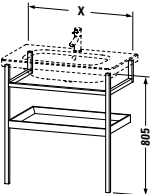
Description	mm	Model-No.	Euro	
			Pricegroup 1	Pricegroup 2
				
Furniture - Accessoires shelf wallmounted				
for DuraStyle # 232065	600 x 440	DS 9871		
for DuraStyle # 232080	750 x 440	DS 9872		
for DuraStyle # 232010	950 x 440	DS 9873		
for DuraStyle # 232012	1140 x 440	DS 9874		
Infobox: body optional in oak or american walnut solid wood / shelf colour possible in decor 18 white matt / 43 basalt matt inclusive fixation to wall / Required specification for ordering: - Body colour - shelf colour				
				
Furniture - Accessoires towel rail				
for DuraStyle # 232065	590 x 440	DS 9891		
for DuraStyle # 232080	740 x 440	DS 9892		
for DuraStyle # 232010	940 x 440	DS 9893		
for DuraStyle # 232012	1140 x 440	DS 9894		
Infobox: body optional in oak or american walnut solid wood / inclusive fixation / Required specification for ordering: - Body colour				
				
Furniture - Accessoires towel rail with included shelf				
for DuraStyle # 232065	590 x 440	DS 9881		
for DuraStyle # 232080	740 x 440	DS 9882		
for DuraStyle # 232010	940 x 440	DS 9883		
for DuraStyle # 232012	1140 x 440	DS 9884		
Infobox: body optional in oak or american walnut solid wood / shelf colour possible in decor 18 white matt / 43 basalt matt inclusive fixation to wall / Required specification for ordering: - Body colour - shelf colour				

Esplanade Design by Sergei Tchoban

Product Information

Fronts	Real wood veneer (pricegroup 1)	05 Oak	Base: solid wood, multiplex curved pasted plywood. Outside real wood veneer, colourless lacquered. Interior finish: laminate (HPL) in (37) White Aluminium. Real wood veneer is a natural material, differences in colour and structure may occur. Surface resistant to moisture.
	Lacquer (pricegroup 2)	56 Silk	Base: solid wood, multiplex curved pasted plywood. Outside lacquered opaque in several coats. Interior finish: laminate (HPL) in (37) White Aluminium. Surface resistant to moisture.
Body	Real wood veneer (pricegroup 1)	05 Oak	High-compressed MDF boards. Outside real wood veneer, colourless lacquered. Trim in real wood veneer. Interior finish: laminate (HPL) in (37) White Aluminium. Real wood veneer is a natural material, differences in colour and structure may occur. Surface resistant to moisture.
	Lacquer (pricegroup 2)	56 Silk	High-compressed MDF boards. Outside lacquered opaque in several coats. Interior finish: laminate (HPL) in (37) White Aluminium. Surface resistant to moisture.
Edges Mirror ground plate	Real wood veneer (pricegroup 1)	05 Oak	Realwood veneer, lacquered.
	Lacquer (pricegroup 2)	56 Silk	Lacquered opaque in several coats.
Handles frame		Zinc diecasting	Chrome
Handles loop		Leather (cow leather)	Dark brown

Esplanade Design by Sergei Tchoban

Ordering Sample

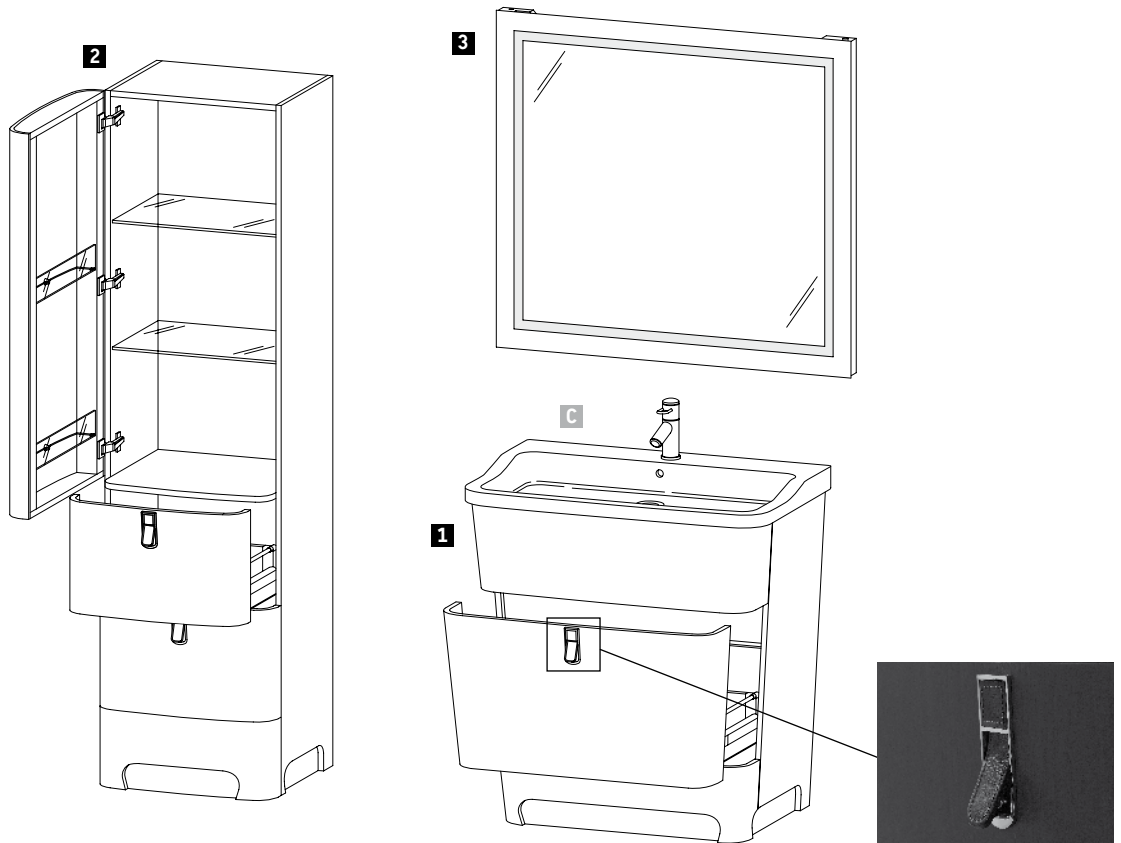

Esplanade

Fronts



Body

Edges Mirror Ground Plate

05 Oak

Description	Remark	Quantity	Model-No.
1 Vanity unit floor standing	Width 810 mm	1	# ES 9051 0 05 05
2 Tall cabinet	Width 500 mm	1	# ES 9055 L 05 05
3 Mirror with lighting	Width 1000 mm	1	# ES 9091 0 05 05
C Esplanade 850 mm		1	# 262285 00 00

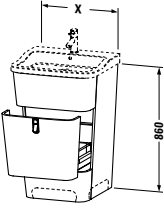
Esplanade Design by Sergei Tchoban

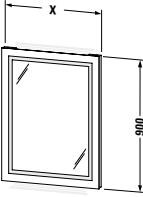
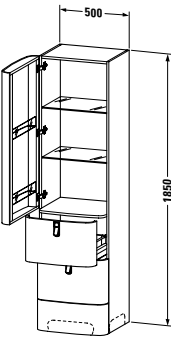
Description	mm	Model-No.	Euro	
			Pricegroup 1	Pricegroup 2
 <p>Vanity unit floor-standing 1 pull-out compartment for Esplanade # 262260 for Esplanade # 262285</p>	<p>560 x 510 810 x 510</p>	<p>ES 9050 ES 9051</p>		
<p>Infobox: Siphon # 005026 is recommended</p>				
 <p>Divider-box drawer to apply on anti-slip mat inside drawer</p>	<p>200 x 373</p>	<p>ES 9922</p>		
 <p>Mirror with lighting IP 44, LED lighting (4-sided) 3300K, 1 sensor switch LED module 3500 Kelvin light colour, 26 W LED module 3500 Kelvin light colour, 31 W</p>	<p>700 x 42 1000 x 42</p>	<p>ES 9090 ES 9091</p>		
<p>Infobox: Distance between sensor and reflecting surfaces = minimum 75 mm</p>				
 <p>Tall cabinet 1 door, 2 pull-out compartments 2 shelves</p>	<p>500 x 430</p>	<p>ES 9055 L/R</p>		
<p>Infobox: Required specification for ordering: - Hinges left (L) / right (R)</p>				

Fogo Design by Duravit

Product Information

Fronts Body Consoles Edges Mirror ground plate Body Mirror Cabinet	Real wood veneer	13 American Walnut 24 Macassar 26 American Cherry Tree 65 Bleached Oak	High-compressed three-ply chipboard, with real wood veneer pressed on one side. Trim in real wood veneer. Surface resistant to moisture. Real wood veneer is a natural material, differences in colour and structure may occur.
Handle		10 Chrome	Metal, chrome
Fronts Modules Waste bin		Frosted White	Plastic material
Trims Body Modules Waste bin		Aluminium	Silver anodised
Side Body Modules (Built-in version)	Decor	37 Aluminium White	High-compressed three-ply chipboard, directly coated with melamine resin decor on both sides, ABS-Edge material. Surface resistant to moisture.
Side Body Modules (Surface mount version)	Real wood veneer	13 American Walnut 24 Macassar 26 American Cherry Tree 65 Bleached Oak	High-compressed three-ply chipboard, with real wood veneer pressed on one side. Trim in real wood veneer. Surface resistant to moisture. Real wood veneer is a natural material, differences in colour and structure may occur.

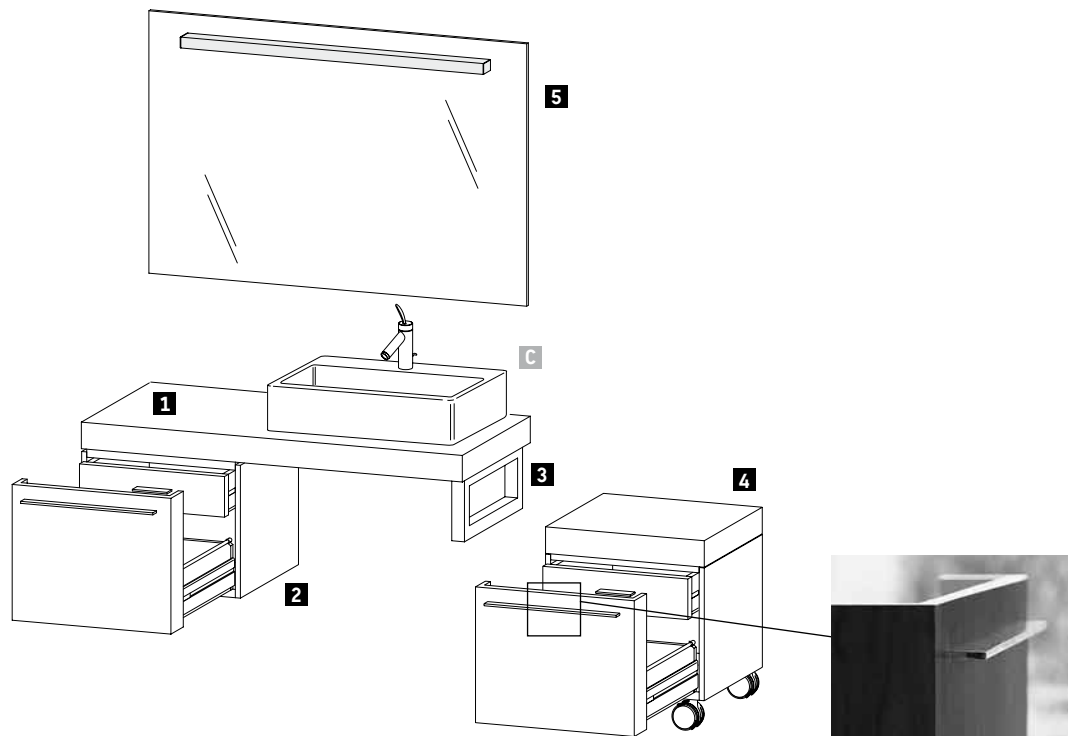
Ordering Sample

Fogo

Front + Body
Vanity Unit
Mobile Storage
Console
Mirror

13 American Walnut

Description	Remark	Quantity	Model-No.
1 Console (with one cut-out)	L = 1200 mm, with cut-out for Vero # 045460 00 27	1	# FO 089C 0 13 13
2 Low cabinet for consoles		1	# FO 9542 0 13 13
3 Console support (Towel rail)		1	# FO 9903 0 00 00
4 Mobile Storage unit		1	# FO 9543 0 13 13
5 Mirror with lighting		1	# FO 9680 0 13 13
C Vero 600 mm		1	# 045460 00 27

Fogo Design by Duravit

Description	mm	Model-No.	Euro
Vanity unit wall-mounted			
1 drawer including compartment, compartment consists of glass dividers and box drawers (small/large)			
for Vero # 045450, (not ground), without compartment	450 x 445/363	FO 9553	
for Vero # 045460, (not ground)	550 x 445/363	FO 9554	
for Vero # 045480, (not ground)	750 x 445/363	FO 9555	
for Vero # 045410, (not ground)	950 x 445/363	FO 9556	
for Vero # 045412, (not ground)	1150 x 445/363	FO 9557	
Infobox: Space saving siphon # 005073 is recommended			
Vanity unit wall-mounted			
1 pull-out compartment, 3 glass divider-box drawers, 2 box drawers large, 2 box drawers small			
for Vero # 032985, (not ground)	800 x 462/380	FO 9572	
for Vero # 032910, (not ground)	1000 x 462/380	FO 9573	
for Vero # 032912, (not ground)	1200 x 462/380	FO 9574	
Infobox: Space saving siphon # 005073 is recommended			
Console including drawer for wash bowls			
1 drawer beneath console, 1 cover beneath console, 2 console supports			
1 cut-out left side for washbowls	900 x 360	FO 8370	
1 cut-out right side for washbowls	900 x 360	FO 8371	
1 cut-out left side for washbowls	1000 x 360	FO 8372	
1 cut-out right side for washbowls	1000 x 360	FO 8373	
1 cut-out left side for washbowls	1100 x 360	FO 8374	
1 cut-out right side for washbowls	1100 x 360	FO 8375	
Infobox: Siphon # 005026 is recommended / Required specification for ordering: - Model-no. ceramic, please see page 660			

Fogo Design by Duravit

Description	mm	Model-No.	Euro
Console including drawer for wash bowls			
1 drawer beneath console,			
1 cover beneath console,			
3 console supports			
1 cut-out left side for washbowls	1200 x 360	FO 8377	
1 cut-out right side for washbowls	1200 x 360	FO 8378	
1 cut-out left side for washbowls	1300 x 360	FO 8380	
1 cut-out right side for washbowls	1300 x 360	FO 8381	
1 cut-out left side for washbowls	1400 x 360	FO 8383	
1 cut-out right side for washbowls	1400 x 360	FO 8384	
Infobox: Siphon # 005026 is recommended / Required specification for ordering: - Model-no. ceramic, please see page 660			
Console including drawer for wash bowls			
2 drawers beneath console,			
1 cover beneath console,			
4 console supports,			
1 cut-out central for washbowls	1400 x 360	FO 8382	
	1600 x 360	FO 8385	
	1800 x 360	FO 8388	
Infobox: Siphon # 005026 is recommended / Required specification for ordering: - Model-no. ceramic, please see page 660			
Console incl. drawer for semi-recessed washbasins			
1 drawer beneath console,			
1 cover beneath console,			
3 console supports			
1 cut-out left side for semi-recessed washbasin	1200 x 360	FO 8377	
1 cut-out right side for semi-recessed washbasin	1200 x 360	FO 8378	
1 cut-out left side for semi-recessed washbasin	1300 x 360	FO 8380	
1 cut-out right side for semi-recessed washbasin	1300 x 360	FO 8381	
1 cut-out left side for semi-recessed washbasin	1400 x 360	FO 8383	
1 cut-out right side for semi-recessed washbasin	1400 x 360	FO 8384	
Infobox: Siphon # 005026 respectively Design Siphon # 0050361 is recommended / Required specification for ordering: - Model-no. ceramic, please see page 660			

Fogo Design by Duravit

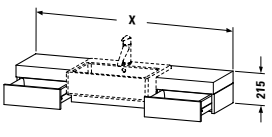
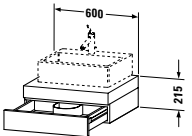
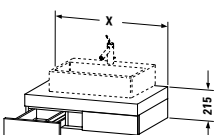
Description	mm	Model-No.	Euro
			
Console incl. drawer for semi-recessed washbasins 2 drawers beneath console, 1 cover beneath console, 4 console supports, 1 cut-out central for semi-recessed washbasin			
	1400 x 360	FO 8382	
	1600 x 360	FO 8385	
	1800 x 360	FO 8388	
Infobox: Siphon # 005026 respectively Design Siphon # 0050361 is recommended / Required specification for ordering: - Model-no. ceramic, please see page 660			
			
Console including drawers 1 drawer beneath console, 2 console supports, 1 cut-out central 1 siphon cover			
	600 x 550	FO 8520	
Infobox: Drawer including cut-out for siphon / Siphon # 005026 respectively Design Siphon # 0050361 is recommended / For installation of a high-riser: maximale space between highriser and wall = 100 mm / Required specification for ordering: - Model-no. ceramic, please see page 659			
			
Console including drawers 2 drawers beneath console, 2 console supports, 1 cut-out central			
	800 x 550	FO 8521	
	1000 x 550	FO 8522	
	1200 x 550	FO 8523	
Infobox: Room for siphon by asymmetric drawers / Siphon # 005026 respectively Design Siphon # 0050361 is recommended / For installation of a high-riser: maximale space between highriser and wall = 100 mm / Required specification for ordering: - Model-no. ceramic, please see page 659			

Fogo Design by Duravit

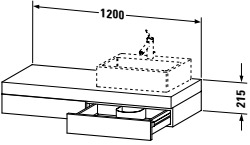
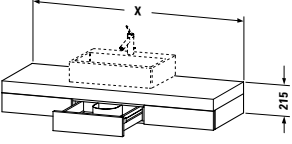
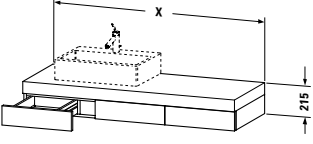
Description	mm	Model-No.	Euro
			
Console including drawers			
2 drawers beneath console,			
2 console supports,			
1 siphon cover			
1 cut-out left side	1200 x 550	FO 8524	
1 cut-out right side	1200 x 550	FO 8525	
Infobox: Drawer including cut-out and siphon cover / Siphon # 005026 respectively Design Siphon # 0050361 is recommended / For installation of a highriser: maximale space between highriser and wall = 100 mm / Required specification for ordering: - Model-no. ceramic, please see page 659			
			
Console including drawers			
3 drawers beneath consoles,			
3 console supports,			
1 siphon cover,			
1 cut-out central	1500 x 550	FO 8527	
	1800 x 550	FO 8531	
Infobox: Drawer central including cut-out for siphon / Siphon # 005026 respectively Design Siphon # 0050361 is recommended / For installation of a highriser: maximale space between highriser and wall = 100 mm / Required specification for ordering: - Model-no. ceramic, please see page 659			
			
Console including drawers			
3 drawers beneath consoles,			
3 console supports			
1 cut-out left side	1500 x 550	FO 8528	
1 cut-out right side	1500 x 550	FO 8529	
1 cut-out left side	1800 x 550	FO 8532	
1 cut-out right side	1800 x 550	FO 8533	
Infobox: Room for siphon by asymeric drawers / Siphon # 005026 respectively Design Siphon # 0050361 is recommended / For installation of a highriser: maximale space between highriser and wall = 100 mm / For using console support on a drywall, a suitable subconstruction is required / Required specification for ordering: - Model-no. ceramic, please see page 659			

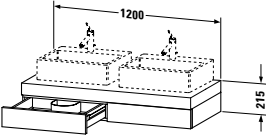
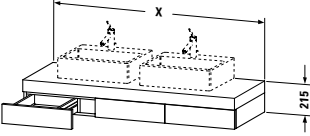
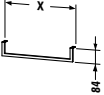

Fogo Design by Duravit

Description	mm	Model-No.	Euro		
					
Console including drawers					
2 drawers beneath console,					
2 console supports					
2 cut-outs	1200 x 550	FO 8526			
Infobox: Both drawers including cut-out for siphon / Siphon # 005026 respectively Design Siphon # 0050361 is recommended / For installation of a highriser: maximale space between highriser and wall = 100 mm / Required specification for ordering: - Model-no. ceramic, please see page 659					
					
Console including drawers					
3 drawers beneath consoles,					
3 console supports,					
2 cut-outs	1500 x 550	FO 8530			
	1800 x 550	FO 8534			
Infobox: Room for siphon by asymmetric drawers / Siphon # 005026 respectively Design Siphon # 0050361 is recommended / For installation of a highriser: maximale space between highriser and wall = 100 mm / Required specification for ordering: - Model-no. ceramic, please see page 659					
					
Towel rail					
under consoles including drawers,					
square tube, chromed, 14 mm	500	FO 9985			
	1000	FO 9986			

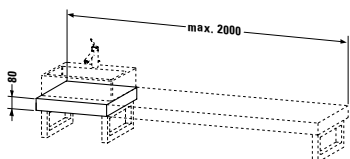
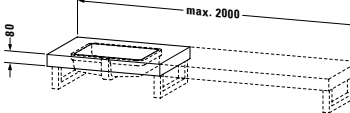
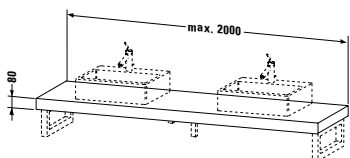
Fogo Design by Duravit

Description	mm	Model-No.	Euro		
					
Console					
1 console with one cut-out, Width min. see ordering information, Width max 2000 mm					
basic price till 800 mm, for vanity basin and washbowl price per section of 100 mm	550	FO 089C			
Infobox: Required specification for the order: - overall width - dimension between axes from left side - model.-no ceramic and min. width, please see page 665/666 - exactly position of floor cabinets / console supports Please indicate exact measures and drawings please refer to order sheet page 668					
					
Console for undercounter basin bonded					
1 console with one cut-out, Width min. see ordering information, Width max 2000 mm					
basic price till 800 mm, for undercounter basin bonded price per section of 100 mm	550	FO 090C			
Infobox: Required specification for the order: - overall width - dimension between axes from left side - model.-no ceramic and min. width, please see page 666 - exactly position of floor cabinets / console supports Please indicate exact measures and drawings please refer to order sheet page 668 / For undercounter basin bonded, price includes the assembly of the washbasin on the console					
					
Console					
1 console with two cut-outs, Width min. see ordering information, Width max 2000 mm					
basic price till 800 mm, for vanity basin and washbowl price per section of 100 mm	550	FO 079C			
Infobox: Required specification for the order: - overall width - dimension between axes from left side - model.-no ceramic and min. width, please see page 665/666 - exactly position of floor cabinets / console supports Please indicate exact measures and drawings please refer to order sheet page 668					

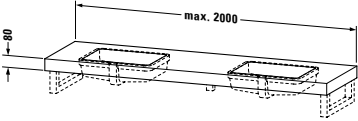
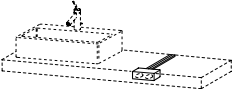
Fogo Design by Duravit

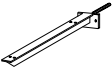
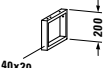
Description	mm	Model-No.	Euro
			
Console for undercounter basin bonded 1 console with two cut-outs, Width min. see ordering information, Width max 2000 mm basic price till 800 mm, for undercounter basin bonded 550 price per section of 100 mm		FO 091C	
Infobox: Required specification for the order: - overall width - dimension between axes from left side - model-no ceramic and min. width, please see page 666 - exactly position of floor cabinets / console supports Please indicate exact measures and drawings please refer to order sheet page 668 / For undercounter basin bonded, price includes the assembly of the washbasin on the console			
			
Socket beneath console mountable beneath console, incl. 1 connecting cable (1,5 m) including fixing		FO 9907	
Infobox: External dimensions of double socket: height = 45 mm, width = 140 mm, depth = 80 mm			
			
Console Support 1 console support-bracket, mountable beneath console grey, powder-coated	40 x 425	FO 9902	
			
Console support 100 mm installation in wall 1 console support (depth without pin) grey, powder-coated	90 x 420	FO 9926	
Infobox: For using the console support for a dry lining wall, it's necessary to arm the wall			
			
Console Support 1 console support-towel rail, for installation beneath a depth reduced console chrome	40 x 340	FO 9904	

Fogo Design by Duravit

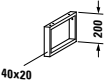
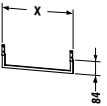
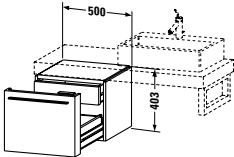
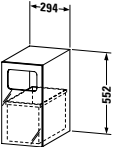
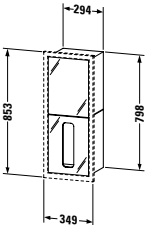
Description	mm	Model-No.	Euro
			
Console Support 1 console support-towel rail, mountable beneath console chrome	40 x 480	FO 9903	
			
Towel rail under consoles, square tube, chromed, 14 mm	500	FO 9983	
	1000	FO 9984	
			
Low cabinet for console mountable beneath console, 1 pull-out compartment + inside drawer handle	500 x 550	FO 9542	
			
Waste bin beneath console	294 x 490	FO 6807	
			
Modul storage unit, paper towel dispenser each with invisible integrated ma- gnetic locking system built-in version incl. cover frame	294 x 200	FO 6802	
surface mount version	294 x 200	FO 6803	
Infobox: Overall dimension # FO 6802 incl. cover frame: Width = 349 mm, Height = 853 mm, Depth = 165 mm			

Fogo Design by Duravit

Description	mm	Model-No.	Euro
Modul Storage unit, paper towel dispenser, soap dispenser each with invisible integrated magnetic locking system			
built-in version incl. cover frame	294 x 200	FO 6805	
surface mount version	294 x 200	FO 6806	
Infobox: Overall dimension # FO 6805 incl. cover frame: Width = 349 mm, Height = 1243 mm, Depth = 165 mm			
Mirror with lighting IP 44, 1 sensor switch bottom right, T5 lighting 3500 kelvin light colour			
1 lamp 430 mm, 8 W	597 x 23/76	FO 9614	
1 lamp 630 mm, 13 W	797 x 23/76	FO 9615	
1 lamp 630 mm, 13 W	997 x 23/76	FO 9616	
1 lamp 960 mm, 21 W	1200 x 23/76	FO 9680	
1 lamp 1270 mm, 28 W	1500 x 23/76	FO 9681	
1 lamp 1270 mm, 28 W	1800 x 23/76	FO 9682	
Infobox: Distance between sensor and reflecting surfaces = minimum 75 mm			
Mirror with lighting (width variable) IP 44, 1 sensor switch bottom right, for width 1201 - 1500 mm fluorescent tube central and 960 mm long, T5 lighting 3500 kelvin light colour, 21 W, for width 1501 - 1800 mm fluorescent tube central and 1270 mm long			
	1201-1800 x 23/76	FO 9620	
Infobox: Distance between sensor and reflecting surfaces = minimum 75 mm			

Fogo Design by Duravit

Description	mm	Model-No.	Euro
Mirror cabinet IP 44, 2 mirror doors, 2 glass shelves, 1 lamp (T5 3500 kelvin light colour, 13 W), 1 sensor switch bottom right, 1 socket unit, width 800 mm (opened)			
wooden underfloor	600 x 210/263	FO 9672	
illuminated glass floor, lamp for glass floor, T2 lighting 4500 kelvin light colour, 13 W	600 x 210/263	FO 9673	
Infobox: Distance between sensor and reflecting surfaces = minimum 75 mm			
Mirror cabinet IP 44, 2 mirror doors, 2 glass shelves, 1 lamp (T5 3500 kelvin light colour, 14 W), 1 sensor switch bottom right, 1 socket unit, width 1000 mm (opened)			
wooden underfloor	800 x 210/263	FO 9674	
illuminated glass floor, lamp for glass floor, T2 lighting 4500 kelvin light colour, 13 W	800 x 210/263	FO 9675	
Infobox: Distance between sensor and reflecting surfaces = minimum 75 mm			

Fogo Design by Duravit

Description	mm	Model-No.	Euro
Mirror cabinet IP 44, 2 mirror doors, 2 glass shelves, 1 lamp (T5 3500 kelvin light colour, 21 W), 1 sensor switch bottom right, 1 socket unit, width 1200 mm (opened)			
wooden underfloor	1000 x 210/263	FO 9676	
illuminated glass floor, lamp for glass floor, T2 lighting 4500 kelvin light colour, 23 W	1000 x 210/263	FO 9677	
Info box: Distance between sensor and reflecting surfaces = minimum 75 mm			
Mirror cabinet IP 44, 3 mirror doors, 4 glass shelves, 1 lamp (T5 3500 kelvin light colour, 21 W), 1 sensor switch bottom right, 1 socket unit, width 1400 mm (opened)			
wooden underfloor	1200 x 210/263	FO 9678	
illuminated glass floor, lamp for glass floor, T2 lighting 4500 kelvin light colour, 13 W	1200 x 210/263	FO 9679	
Info box: Distance between sensor and reflecting surfaces = minimum 75 mm			
Mobile storage unit 1 countertop, 1 pull-out compartment + inside drawer 4 wheels	500 x 550	FO 9543	

Fogo Design by Duravit

Description	mm	Model-No.	Euro		
Semi-tall cabinet 2 glass shelves, 2 glass shelves with lip in door width 630 mm (opened)	500 x 250	FO 9550 L/R			
Infobox: Required specification for ordering: - Hinges left (L) / right (R)					
Tall cabinet 4 glass shelves, 4 glass shelves with lip in door width 630 mm (opened)	500 x 250	FO 9546 L/R			
Infobox: Required specification for ordering: - Hinges left (L) / right (R)					
Tall cabinet 3 glass shelves, 1 wooden shelf, 4 glass shelves with lip in door width 630 mm (opened)	500 x 420	FO 9547 L/R			
Infobox: Required specification for ordering: - Hinges left (L) / right (R)					

Happy D.2 Design by sieger design

Product Information

Front Body	Decor (Pricegroup 1)	22 White High Gloss 52 European Oak 75 Linen	High-compressed three-ply chipboard, with laminate (HPL) pressed on both sides, ABS-Edge material. Moulded parts: with melamine edge at top / bottom. Surface resistant to moisture. Compact wooden fronts for # H2 6268 / H2 6364 - H2 6366: Base solid wood. High-compressed MDF boards pressed with laminate (HPL).
	Real wood veneer (Pricegroup 2)	13 American Walnut 26 American Cherry Tree 72 Brushed Dark Oak	High-compressed three-ply chipboard, with real wood veneer pressed on one side and laminate (HPL) in (57) Black Diamond on the other side. Surface resistant to moisture. Real wood veneer is a natural material, differences in colour and structure may occur. Fronts: Base solid wood. High-compressed MDF boards pressed with real wood veneer.
Console	Decor (Pricegroup 1)	22 White High Gloss 52 European Oak 75 Linen	High-compressed three-ply chipboard, with laminate (HPL) pressed on both sides, ABS-Edge material. Surface resistant to moisture.
	Real wood veneer (Pricegroup 2)	13 American Walnut 26 American Cherry Tree 72 Brushed Dark Oak	High-compressed three-ply chipboard, with real wood veneer pressed on one side and laminate (HPL) in (57) Black Diamond on the other side. Trim in real wood veneer. Real wood veneer is a natural material, differences in colour and structure may occur.
Mirror/ Mirror cabinet with lighting			LED light technology, 3500 Kelvin light colour. Sensor switch bottom right for on/off function.
Edges Mirror ground plate Body Mirror Cabinet	Decor (Pricegroup 1)	22 White High Gloss 52 European Oak 75 Linen	ABS-Edge material
	Real wood veneer (Pricegroup 2)	13 American Walnut 26 American Cherry Tree 72 Brushed Dark Oak	Description of material see fronts (Real wood veneer)
Handle	10 Chrome		Metal, chrome.
Interior System	Maple or walnut solid wood		The interior system with a material mix in acryl glass and solid wood is available in maple or walnut. There is an individually designed interior system for each cabinet width. There are always two boxes and one box cover in the interior systems for drawers with or without siphon cut-out plus a small tray wave system for cosmetic products. A special field for a hair dryer is integrated off a width of 750 mm. The interior system for drawer without siphon cut-out includes always a big tray wave system to lay in bigger bottles. Off a width of 800 mm there is also a special field for a hair dryer integrated. The interior system for a pull-out compartment always includes a support for hair brushes and comb. There is a wood grid to fix bottles off a width of 750 mm. Each size of the cabinet have a individual layout of the interior systems to use the optimum storage space. The bottom, the box cover the small and big wave plus the special support for hair brushes and comb have a special anti-slip lacquer.
Soundsystem			The 2.1 system with 2 flat drive speakers, 1 active bass and 1 passive bass create a high-quality listening experience, especially matched to the bathroom situation. Output power: 2x5 Watt (tweeter/midrange), 1x25 Watt (active bass with one passive radiator-principle). The technical components of the soundsystem are invisibly integrated into the LED Mirror cabinet, with a loss of the useable volume of 55 mm in height. The control of the soundsystem is independent of the illumination. Music streaming and control is compatible with all Bluetooth enabled devices, that support the A2DP profile (stereo audio profiles). The standby power consumption is less than 0.5 Watt.

Happy D.2 Design by sieger design

Ordering sample

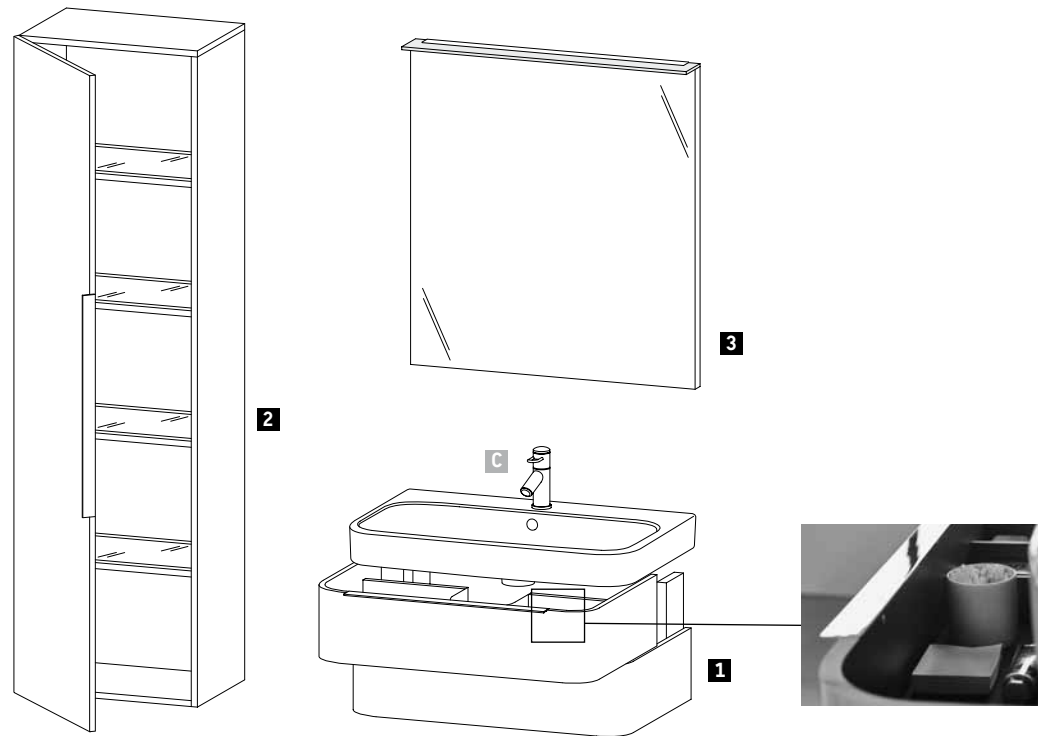

Happy D.2
Vanity unit
Tall cabinet
Mirror

72 Brushed Dark Oak

Description	Remark	Quantity	Model-No.
1 Vanity unit wall-mounted	Width 775 mm	1	# H2 6365 0 72 72
2 Tall cabinet	Width 500 mm	1	# H2 9253 L 72 72
3 Mirror with lighting	Width 800 mm	1	# H2 7294 0 72 72
C Furniture washbasin Happy D.2	Width 800 mm	1	# 231880 00 00

Happy D.2 Design by sieger design

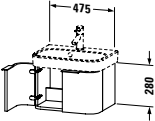
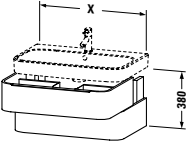
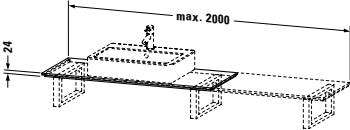
Description	mm	Model-No.	Euro	
			Pricegroup 1	Pricegroup 2
 <p>Vanity unit wall-mounted 2 doors for Happy D.2 # 071050 (not ground)</p>	475 x 350	H2 6268		
Infobox: Space saving siphon # 005073 is recommended				
 <p>Vanity unit wall-mounted 2 drawers, upper drawer including cut-out for siphon and siphon cover for Happy D.2 # 231865 (not ground) for Happy D.2 # 231880 (not ground) for Happy D.2 # 231810 (not ground)</p>	625 x 480 775 x 480 975 x 480	H2 6364 H2 6365 H2 6366		
Additional modules Interior system for drawer in maple or walnut solid wood including siphon cut out for cabinet widths 625 mm including siphon cut out for cabinet widths 775 mm including siphon cut out for cabinet widths 975 mm without siphon cut out for cabinet widths 625 mm without siphon cut out for cabinet widths 775 mm without siphon cut out for cabinet widths 975 mm				
Infobox: Space saving siphon # 005073 is recommended / framed recess = 13 mm / Required specification for ordering: - interior system yes / no - maple or walnut				
 <p>Console for above counter basin 1 console with one cut-out, Width min. see ordering information, Width max 2000 mm basic price for 800 mm, for back-to-wall basic price for 800 mm, for corner left basic price for 800 mm, for corner right basic price for 800 mm, for niche price per section of 100 mm</p>	480 480 480 480	H2 010C H2 011C H2 012C H2 013C		
Infobox: Required specification for ordering: - overall width - dimension between axes from left side - Model-no. ceramic and min. width, please see page 667 - exactly position of floor cabinets/console supports / Please indicate exact measures and drawing please refer to order sheet page 668 / Console tops delivered uncut possible				

Happy D.2 Design by sieger design

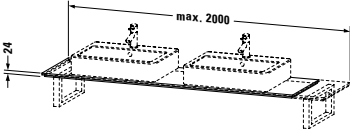
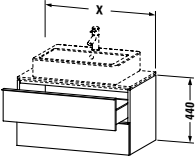
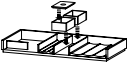
Description	mm	Model-No.	Euro	
			Pricegroup 1	Pricegroup 2
				
Console for above counter basin 1 console with two cut-outs, Width min. see ordering information, Width max 2000 mm				
basic price for 800 mm, for back-to-wall	480	H2 015C		
basic price for 800 mm, for corner left	480	H2 016C		
basic price for 800 mm, for corner right	480	H2 017C		
basic price for 800 mm, for niche	480	H2 018C		
price per section of 100 mm				
Infobox: Required specification for ordering: - overall width - dimension between axes from left side - Model-no. ceramic and min. width, please see page 667 - exactly position of floor cabinets/console supports / Please indicate exact measures and drawing please refer to order sheet page 668				
				
Vanity unit for console 2 drawers, upper drawer including cut-out for siphon and siphon cover				
	600 x 478	H2 6310		
	800 x 478	H2 6311		
	1000 x 478	H2 6312		
				
Additional modules Interior system for drawer in maple or walnut solid wood including siphon cut out for cabinet widths 600 mm including siphon cut out for cabinet widths 800 mm including siphon cut out for cabinet widths 1000 mm without siphon cut out for cabinet widths 600 mm without siphon cut out for cabinet widths 800 mm without siphon cut out for cabinet widths 1000 mm				
Infobox: Console not included in delivery, please order separately / Highriser are not applicable / Required specification for ordering: - interior system yes / no - maple or walnut				



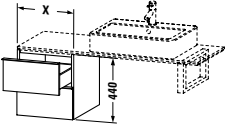
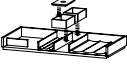
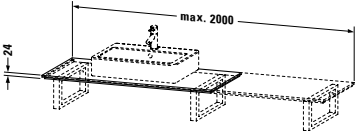

Happy D.2 Design by sieger design

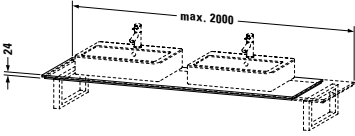
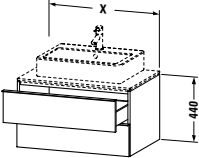
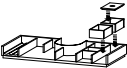
Description	mm	Model-No.	Euro	
			Pricegroup 1	Pricegroup 2
				
Low cabinet for console				
2 drawers				
	300 x 478	H2 6840		
	400 x 478	H2 6841		
	500 x 478	H2 6842		
	600 x 478	H2 6843		
				
Additional modules				
Interior system for drawer in maple or walnut solid wood				
without siphon cut out for cabinet widths 600 mm				
Infobox: Console not included in delivery, please order separately / Required specification for ordering: - interior system yes / no - maple or walnut				
				
Console for above counter basin and countertop basin				
1 console with one cut-out,				
Width min. see ordering information,				
Width max 2000 mm				
basic price for 800 mm, for back-to-wall	550	H2 025C		
basic price for 800 mm, for corner left	550	H2 026C		
basic price for 800 mm, for corner right	550	H2 027C		
basic price for 800 mm, for niche	550	H2 028C		
price per section of 100 mm				
Infobox: Required specification for ordering: - overall width - dimension between axes from left side - Model-no. ceramic and min. width, please see page 665/666 - exactly position of floor cabinets/console supports / Please indicate exact measures and drawing please refer to order sheet page 668 / Console tops delivered uncut possible				

Happy D.2 Design by sieger design

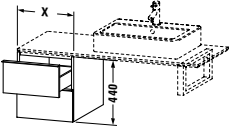
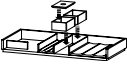
Description	mm	Model-No.	Euro	
			Pricegroup 1	Pricegroup 2
				
Console for above counter basin and countertop basin				
1 console with two cut-outs, Width min. see ordering information, Width max 2000 mm				
basic price for 800 mm, for back-to-wall	550	H2 045C		
basic price for 800 mm, for corner left	550	H2 046C		
basic price for 800 mm, for corner right	550	H2 047C		
basic price for 800 mm, for niche	550	H2 048C		
price per section of 100 mm				
Infobox: Required specification for ordering: - overall width - dimension between axes from left side - Model-no. ceramic and min. width, please see page 665/666 - exactly position of floor cabinets/console supports / Please indicate exact measures and drawing please refer to order sheet page 668				
				
Vanity unit for console				
2 drawers, upper drawer including cut-out for siphon and siphon cover				
	600 x 548	H2 6300		
	800 x 548	H2 6301		
	1000 x 548	H2 6302		
				
Additional modules				
Interior system for drawer in maple or walnut solid wood				
including siphon cut out for cabinet widths 600 mm				
including siphon cut out for cabinet widths 800 mm				
including siphon cut out for cabinet widths 1000 mm				
without siphon cut out for cabinet widths 600 mm				
without siphon cut out for cabinet widths 800 mm				
without siphon cut out for cabinet widths 1000 mm				
Infobox: Console not included in delivery, please order separately / Highriser are not applicable / Required specification for ordering: - interior system yes / no - maple or walnut				

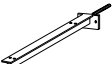
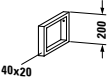
Happy D.2 Design by sieger design

Description	mm	Model-No.	Euro	
			Pricegroup 1	Pricegroup 2
 <p>Low cabinet for console 2 drawers</p>				
	300 x 548	H2 6830		
	400 x 548	H2 6831		
	500 x 548	H2 6832		
	600 x 548	H2 6833		
 <p>Additional modules Interior system for drawer in maple or walnut solid wood without siphon cut out for cabinet widths 600 mm</p>				
<p>Infobox: Console not included in delivery, please order separately / Required specification for ordering: - interior system yes / no - maple or walnut</p>				
 <p>Console Support 1 console support-bracket, mountable beneath console 480 mm / 550 mm depths grey, powder-coated</p>	40 x 425	H2 9902		
 <p>Console support 100 mm installation in wall 1 console support (depth without pin), mountable beneath console 480 mm / 550 mm depths grey, powder-coated</p>	90 x 420	H2 9926		
<p>Infobox: For using console support on a drywall, a suitable subconstruction is required</p>				
 <p>Console Support 1 console support-towel rail, mountable beneath console 480 mm depths chrome</p>	40 x 455	H2 9917		
 <p>Console Support 1 console support-towel rail, mountable beneath console 550 mm depths chrome</p>	40 x 480	H2 9903		

Happy D.2 Design by sieger design

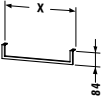
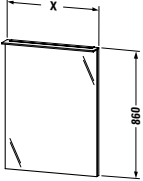
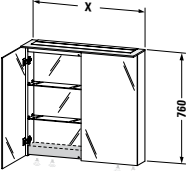
Description	mm	Model-No.	Euro	
			Pricegroup 1	Pricegroup 2
 <p>Towel rail mountable beneath console 480 mm / 550 mm depths, square tube, chromed, 14 mm</p>	500 x 14 1000 x 14	H2 9985 H2 9986		
 <p>Mirror with lighting IP 44, 1 sensor switch bottom right</p>	500 x 36/105 650 x 36/105 800 x 36/105 1000 x 36/105	H2 7291 H2 7293 H2 7294 H2 7295		
<p>Additional modules LED dimming function</p>				
<p>Infobox: Distance between sensor and reflecting surfaces = minimum 75 mm</p>				
 <p>Mirror cabinet IP 44, 2 mirror doors, back panel inside mirror glass, 2 glass shelves (clear glass), 1 sensor switch bottom right, one socket unit with flap lid in top end</p>	650 x 138/208 800 x 138/208 1000 x 138/208 650 x 138/208 800 x 138/208 1000 x 138/208	H2 7593 H2 7594 H2 7595 H2 7693 H2 7694 H2 7695		
<p>Additional modules LED dimming function</p>				
<p>Infobox: Distance between sensor and reflecting surfaces = minimum 75 mm / LED dimming function is already included in the mirror cabinet with Soundsystem</p>				

Happy D.2 Design by sieger design

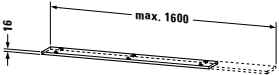
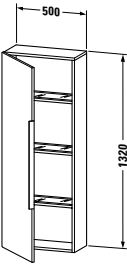
Description	mm	Model-No.	Euro	
			Pricegroup 1	Pricegroup 2
 <p>Box in maple or walnut solid wood 1 Box, Material mix in acryl glass and solid wood (optionally in maple or walnut)</p>	185 x 100	H2 9910		
<p>Infobox: Maximum use of space per shelf crosswise: 600 mm = 3 pieces/ 800mm = 4 pieces/ 1000 mm = 5 pieces/ 1200 mm = 6 pieces / Required specification for ordering: - maple or walnut</p>				
 <p>Wall board 1 shelf, fixation with locking pin, Width min. 600 mm, Width max. 1600 mm basic price for 600 mm price per section of 100 mm</p>	600-1600 x 160	H2 7912		
<p>Infobox: Material thickness = 16 mm</p>				
 <p>Semi-tall cabinet 3 glass shelves with alu carrier system</p>	500 x 240 500 x 360	H2 9250 L/R H2 9251 L/R		
<p>Infobox: Required specification for ordering: - hinges left (L) / right (R)</p>				

Happy D.2 Design by sieger design

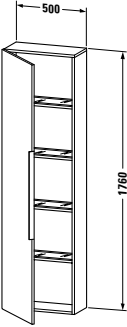
Description	mm	Model-No.	Euro		
			Pricegroup 1	Pricegroup 2	
 <p>Tall cabinet 4 glass shelves with alu carrier system</p>	500 x 240	H2 9252 L/R			
	500 x 360	H2 9253 L/R			
	Infobox: Required specification for ordering: - hinges left (L) / right (R)				

Ketho Design by Christian Werner

Product Information

Fronts	Decor	18 White Matt	High-compressed three-ply chipboard, directly coated with melamine resin decor on both sides, ABS-Edge material. Surface resistant to moisture.
Body		43 Basalt Matt	
Body Mirror Cabinet		49 Graphite Matt	
		50 Garnet Red Matt	
Edges Mirror ground plate	Decor	37 Aluminium White	ABS - Edge material
Mirror with lighting			LED light technology, 3500 Kelvin light colour. Sensor switch bottom right for on/off function.
Handle bar		Aluminium	Silver anodised
Handle mirror cabinets		Zinc diecasting	Silver anodised

Ordering Sample

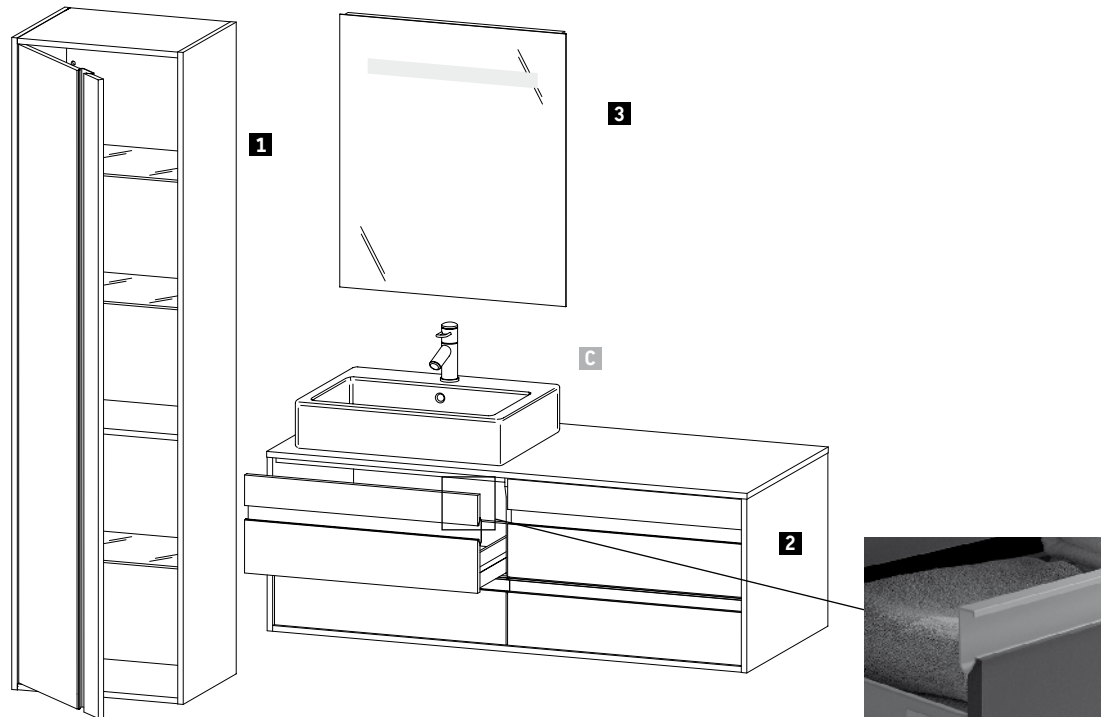

Ketho
Body
Tall cabinet
Vanity unit

49 Graphite Matt

Description	Remark	Quantity	Model-No.
1 Tall Cabinet	Height 1800 mm	1	# KT 1265 L 49 49
2 Vanity unit wall mounted	Width 1400 mm	1	# KT 6657 L 49 49
3 Mirror with lighting	Width 650 mm	1	# KT 7330 0 00 00
C Vero		1	# 045260 00 00

Ketho Design by Christian Werner

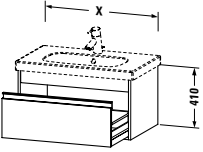
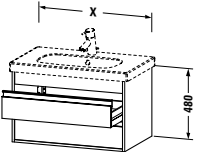
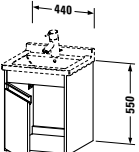
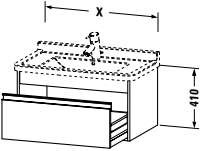
Description	mm	Model-No.	Euro																
 <p>Vanity unit wall-mounted 1 box drawer with siphon cut-out and cover</p> <table border="1"> <tr> <td>for D-Code # 034265</td> <td>600 x 455</td> <td>KT 6670</td> <td></td> </tr> <tr> <td>for D-Code # 034285</td> <td>800 x 455</td> <td>KT 6667</td> <td></td> </tr> <tr> <td>for D-Code # 034210</td> <td>1000 x 455</td> <td>KT 6668</td> <td></td> </tr> <tr> <td>for D-Code # 034812</td> <td>1150 x 455</td> <td>KT 6669</td> <td></td> </tr> </table> <p>InfoBox: Space saving siphon # 005073 is recommended</p>	for D-Code # 034265	600 x 455	KT 6670		for D-Code # 034285	800 x 455	KT 6667		for D-Code # 034210	1000 x 455	KT 6668		for D-Code # 034812	1150 x 455	KT 6669				
for D-Code # 034265	600 x 455	KT 6670																	
for D-Code # 034285	800 x 455	KT 6667																	
for D-Code # 034210	1000 x 455	KT 6668																	
for D-Code # 034812	1150 x 455	KT 6669																	
 <p>Vanity unit wall-mounted 2 drawers, upper drawer including cut-out for siphon and siphon cover</p> <table border="1"> <tr> <td>for D-Code # 034265</td> <td>600 x 455</td> <td>KT 6650</td> <td></td> </tr> <tr> <td>for D-Code # 034285</td> <td>800 x 455</td> <td>KT 6647</td> <td></td> </tr> <tr> <td>for D-Code # 034210</td> <td>1000 x 455</td> <td>KT 6648</td> <td></td> </tr> <tr> <td>for D-Code # 034812</td> <td>1150 x 455</td> <td>KT 6649</td> <td></td> </tr> </table> <p>InfoBox: Siphon # 005026 is recommended</p>	for D-Code # 034265	600 x 455	KT 6650		for D-Code # 034285	800 x 455	KT 6647		for D-Code # 034210	1000 x 455	KT 6648		for D-Code # 034812	1150 x 455	KT 6649				
for D-Code # 034265	600 x 455	KT 6650																	
for D-Code # 034285	800 x 455	KT 6647																	
for D-Code # 034210	1000 x 455	KT 6648																	
for D-Code # 034812	1150 x 455	KT 6649																	
 <p>Vanity unit wall-mounted 1 door</p> <table border="1"> <tr> <td>for Starck 3 # 030348</td> <td>440 x 455</td> <td>KT 6662 L/R</td> <td></td> </tr> </table> <p>InfoBox: Space saving siphon # 005073 is recommended / Required specification for ordering: - Hinges left (L) / right (R)</p>	for Starck 3 # 030348	440 x 455	KT 6662 L/R																
for Starck 3 # 030348	440 x 455	KT 6662 L/R																	
 <p>Vanity unit wall-mounted 1 box drawer with siphon cut-out and cover</p> <table border="1"> <tr> <td>for Starck 3 # 030470</td> <td>650 x 465</td> <td>KT 6663</td> <td></td> </tr> <tr> <td>for Starck 3 # 030480</td> <td>800 x 465</td> <td>KT 6664</td> <td></td> </tr> <tr> <td>for Starck 3 # 030410</td> <td>1000 x 465</td> <td>KT 6665</td> <td></td> </tr> </table> <p>InfoBox: Space saving siphon # 005073 is recommended</p>	for Starck 3 # 030470	650 x 465	KT 6663		for Starck 3 # 030480	800 x 465	KT 6664		for Starck 3 # 030410	1000 x 465	KT 6665								
for Starck 3 # 030470	650 x 465	KT 6663																	
for Starck 3 # 030480	800 x 465	KT 6664																	
for Starck 3 # 030410	1000 x 465	KT 6665																	

Ketho Design by Christian Werner

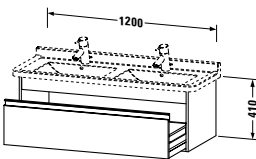
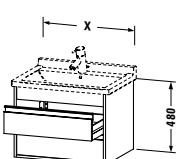
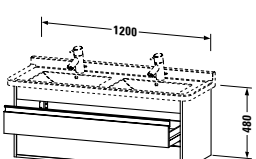
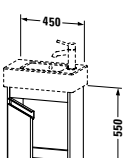
Description	mm	Model-No.	Euro
			
Vanity unit wall-mounted 1 box drawer with siphon cut-out and cover for Starck 3 # 033213	1200 x 465	KT 6666	
Infobox: Space saving siphon # 005073 is recommended			
			
Vanity unit wall-mounted 2 drawers, upper drawer including cut-out for siphon and siphon cover for Starck 3 # 030470 for Starck 3 # 030480 for Starck 3 # 030410	650 x 465 800 x 465 1000 x 465	KT 6643 KT 6644 KT 6645	
Infobox: Space saving siphon # 005073 is recommended			
			
Vanity unit wall-mounted 2 drawers, upper drawer including cut-out for siphon and siphon cover for Starck 3 # 033213	1200 x 465	KT 6646	
Infobox: Space saving siphon # 005073 is recommended			
			
Vanity unit wall-mounted 1 door for Vero # 070350 (not ground)	450 x 225	KT 6629 L/R	
Infobox: Required specification for ordering: - Hinges left (L) / right (R)			

Ketho Design by Christian Werner

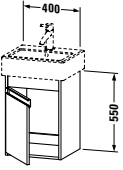
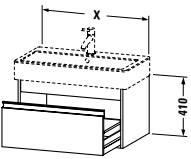
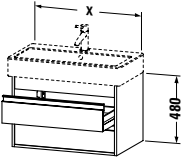
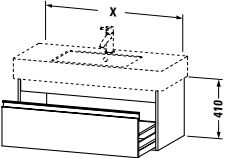
Description	mm	Model-No.	Euro
 <p>Vanity unit wall-mounted 1 door for Vero # 070445 (not ground)</p>	400 x 320	KT 6630 L/R	
<div style="border: 1px solid black; padding: 5px;"> Infobox: Required specification for ordering: - Hinges left (L) / right (R) </div>			
 <p>Vanity unit wall-mounted 1 pull-out compartment for Vero # 045450 (not ground) for Vero # 045460 (not ground) for Vero # 045470 (not ground) for Vero # 045480 (not ground) for Vero # 045410 (not ground) for Vero # 045412 (not ground)</p>	450 x 440 550 x 440 650 x 440 750 x 440 950 x 440 1150 x 440	KT 6685 KT 6686 KT 6684 KT 6687 KT 6688 KT 6689	
 <p>Vanity unit wall-mounted 2 drawers, (1 x including cut out for siphon and siphon cover) for Vero # 045450 (not ground) for Vero # 045460 (not ground) for Vero # 045470 (not ground) for Vero # 045480 (not ground) for Vero # 045410 (not ground) for Vero # 045412 (not ground)</p>	450 x 440 550 x 440 650 x 440 750 x 440 950 x 440 1150 x 440	KT 6635 KT 6636 KT 6624 KT 6637 KT 6638 KT 6639	
 <p>Vanity unit wall-mounted 1 pull-out compartment for Vero # 032985 (not ground) for Vero # 032910 (not ground) for Vero # 032912 (not ground)</p>	800 x 455 1000 x 455 1200 x 455	KT 6690 KT 6691 KT 6692	

Ketho Design by Christian Werner

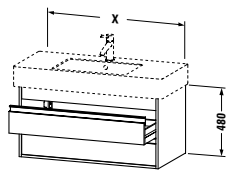
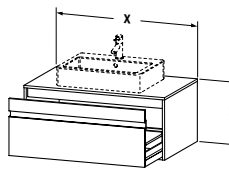
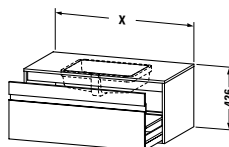
Description	mm	Model-No.	Euro
			
Vanity unit wall-mounted			
2 drawers,			
(1 x including cut out for siphon and siphon cover)			
for Vero # 032985 (not ground)	800 x 455	KT 6640	
for Vero # 032910 (not ground)	1000 x 455	KT 6641	
for Vero # 032912 (not ground)	1200 x 455	KT 6642	
			
Vanity unit wall-mounted			
1 pull-out compartment,			
countertop including one cut-out			
for 1 above counter basin central	800 x 550	KT 6694	
for 1 vanity basin central incl. siphon cover	800 x 550	KT 6794	
for 1 above counter basin central	1000 x 550	KT 6695	
for 1 vanity basin central incl. siphon cover	1000 x 550	KT 6795	
for 1 above counter basin central	1200 x 550	KT 6696	
for 1 vanity basin central incl. siphon cover	1200 x 550	KT 6796	
Infobox: Space saving siphon # 005073 is recommended / Required specification for ordering: - Model-no. ceramic, please see page 662/663			
			
Vanity unit wall-mounted for undercounter basin bonded			
1 pull-out compartment,			
countertop including one cut-out,			
for 1 undercounter basin bonded,			
central incl. siphon cover			
	800 x 550	KT 6894	
	1000 x 550	KT 6895	
	1200 x 550	KT 6896	
Infobox: Space saving siphon # 005073 is recommended / Required specification for ordering: - Model-no. ceramic, please see page 663 For undercounter basin bonded, price includes the assembly of the washbasin on the vanity unit			

Ketho Design by Christian Werner

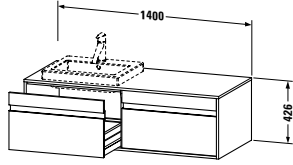
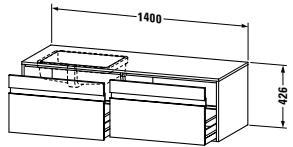
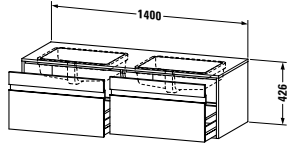
Description	mm	Model-No.	Euro
			
Vanity unit wall-mounted 2 pull-out compartments, 1 countertop with one cut-out or two cut-outs			
for 1 or 2 above counter basins	1400 x 550	KT 6697 L/R/B	
for 1 or 2 vanity basins each including siphon cover(s)	1400 x 550	KT 6797 L/R/B	
Infobox: Space saving siphon # 005073 is recommended / Required specification for ordering: - Model-no. ceramic, please see page 662/663 - L/R/B = washbasin left, right or on both sides possible			
			
Vanity unit wall-mounted for undercounter basin bonded 2 pull-out compartments, 1 console with one cut-out			
for 1 undercounter basin bonded, inclusive siphon cover	1400 x 550	KT 6897 L/R	
Infobox: Space saving siphon # 005073 is recommended / Required specification for ordering: - Model-no. ceramic, please see page 663 - L/R = Washbasin left or right possible For undercounter basin bonded, price includes the assembly of the washbasin on the vanity unit			
			
Vanity unit wall-mounted for undercounter basin bonded 2 pull-out compartments, 1 console with two cut-outs			
for 2 undercounter basins bonded, inclusive siphon cover,	1400 x 550	KT 6897 B	
Infobox: Space saving siphon # 005073 is recommended / Required specification for ordering: - Model-no. ceramic, please see page 663 - B = basin on both sides For undercounter basin bonded, price includes the assembly of the washbasin on the vanity unit			

Ketho Design by Christian Werner

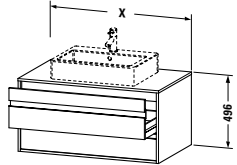
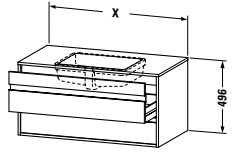
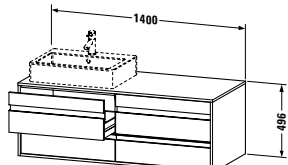
Description	mm	Model-No.	Euro
			
Vanity unit wall-mounted 2 drawers, upper drawer including cut-out for siphon and siphon cover, countertop including one cut-out			
for 1 above counter basin central	800 x 550	KT 6654	
for 1 vanity basin central	800 x 550	KT 6754	
for 1 above counter basin central	1000 x 550	KT 6655	
for 1 vanity basin central	1000 x 550	KT 6755	
for 1 above counter basin central	1200 x 550	KT 6656	
for 1 vanity basin central	1200 x 550	KT 6756	
Infobox: Space saving siphon # 005073 is recommended / Required specification for ordering: - Model-no. ceramic, please see page 662/663			
			
Vanity unit wall-mounted for undercounter basin bonded 2 drawers, upper drawer including cut-out for siphon and siphon cover, countertop including one cut-out, for 1 undercounter basin bonded, central			
	800 x 550	KT 6854	
	1000 x 550	KT 6855	
	1200 x 550	KT 6856	
Infobox: Space saving siphon # 005073 is recommended / Required specification for ordering: - Model-no. ceramic, please see page 663 For undercounter basin bonded, price includes the assembly of the washbasin on the vanity unit			
			
Vanity unit wall-mounted 4 drawers, 1 countertop with one cut-out or two cut-outs, drawer beneath basin including cut-out for siphon and siphon cover			
for 1 or 2 above counter basins	1400 x 550	KT 6657 L/R/B	
for 1 or 2 vanity basin(s)	1400 x 550	KT 6757 L/R/B	
Infobox: Space saving siphon # 005073 is recommended / Required specification for ordering: - Model-no. ceramic, please see page 662/663 - L/R/B = washbasin left, right or on both sides possible			

Ketho Design by Christian Werner

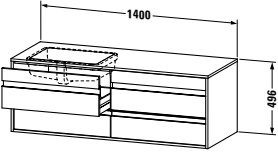
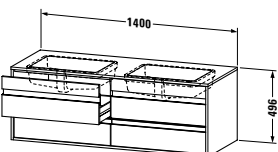
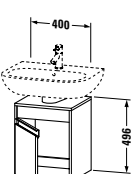
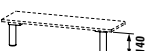
Description	mm	Model-No.	Euro		
					
Vanity unit wall-mounted for undercounter basin bonded 4 drawers, 1 console with one cut-out, drawer beneath basin including cut-out for siphon and siphon cover for 1 undercounter basin bonded	1400 x 550	KT 6857 L/R			
Infobox: Space saving siphon # 005073 is recommended / Required specification for ordering: - Model-no. ceramic, please see page 663 - L/R = Washbasin left or right possible For undercounter basin bonded, price includes the assembly of the washbasin on the vanity unit					
					
Vanity unit wall-mounted for undercounter basin bonded 4 drawers, 1 console with two cut-outs, drawer beneath basin including cut-out for siphon and siphon cover for 2 undercounter basins bonded	1400 x 550	KT 6857 B			
Infobox: Space saving siphon # 005073 is recommended / Required specification for ordering: - Model-no. ceramic, please see page 663 - B = basin on both sides For undercounter basin bonded, price includes the assembly of the washbasin on the vanity unit					
					
Vanity unit wall-mounted 1 door for D-Code # 231055, # 231060, # 231065	400 x 360	KT 6658 L/R			
Infobox: Space saving siphon # 005073 is recommended					
					
Feet 2 Feet adapted for vanity unit # KT 6658		KT 9911			

Ketho Design by Christian Werner

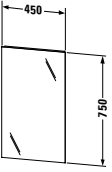
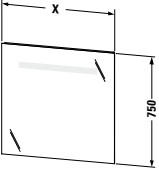
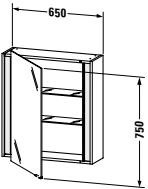
Description	mm	Model-No.	Euro
			
Mirror without lamp	450 x 41	KT 7229	
			
Mirror with lighting IP 44, 1 sensor switch bottom right LED module 3500 Kelvin light colour, 10 W	650 x 41	KT 7330	
LED module 3500 Kelvin light colour, 11 W	800 x 41	KT 7331	
LED module 3500 Kelvin light colour, 14 W	1000 x 41	KT 7332	
LED module 3500 Kelvin light colour, 16 W	1200 x 41	KT 7333	
Additional modules LED dimming function			
Infobox: Distance between sensor and reflecting surfaces = minimum 75 mm			
			
Mirror cabinet IP 44, 1 mirror door, 1 handle attached, 2 glass shelves, 1 socket inside right, 2 T5 lighting 3500 kelvin light colour, 14 W 1 sensor switch bottom right	650 x 180	KT 7530 L/R	
Infobox: Handels attached, including fixing for installation on mirror glass as needed / Distance between sensor and reflecting surfaces = minimum 75 mm / Required specification for ordering: - Hinges left (L) / right (R)			

Ketho Design by Christian Werner

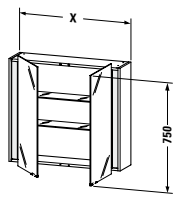
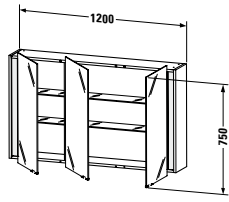
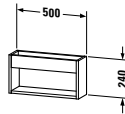
Description	mm	Model-No.	Euro		
					
Mirror cabinet					
IP 44, 1 double mirror door, 2 handles attached, 2 glass shelves, 1 socket inside right, 2 T5 lighting 3500 kelvin light colour, 14 W, 1 sensor switch bottom right					
	800 x 180	KT 7531			
	1000 x 180	KT 7532			
Infobox: Handels attached, including fixing for installation on mirror glass as needed / Distance between sensor and reflecting surfaces = minimum 75 mm					
					
Mirror cabinet					
IP 44, 1 double mirror door, 1 mirror door, 3 handles attached, 4 glass shelves, 1 socket inside right, 2 T5 lighting 3500 kelvin light colour, 14 W 1 sensor switch bottom right					
	1200 x 180	KT 7533			
Infobox: Handels attached, including fixing for installation on mirror glass as needed / Distance between sensor and reflecting surfaces = minimum 75 mm					
					
Wall shelf					
	500 x 135	KT 2537			

Ketho Design by Christian Werner

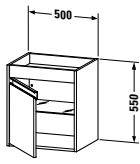
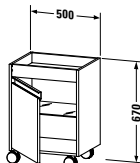
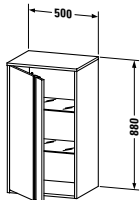
Description	mm	Model-No.	Euro
			
Low cabinet			
1 door,			
1 glass shelf			
1 tray above	500 x 360	KT 2528 L/R	
Infobox: Required specification for ordering: - Hinges left (L) / right (R)			
			
Mobile storage unit			
1 door,			
1 glass shelf			
1 tray above	500 x 360	KT 2530 L/R	
Infobox: Required specification for ordering: - Hinges left (L) / right (R)			
			
Semi-tall cabinet			
1 door			
2 glass shelves	500 x 360	KT 1266 L/R	
Infobox: Required specification for ordering: - Hinges left (L) / right (R)			

Ketho Design by Christian Werner

Description	mm	Model-No.	Euro
Tall cabinet			
1 door,			
2 glass shelves,			
1 wooden shelf			
	400 x 360	KT 1257 L/R	
	500 x 360	KT 1267 L/R	
Infobox: Required specification for ordering: - Hinges left (L) / right (R)			
Tall cabinet			
1 door,			
3 glass shelves,			
1 wooden shelf			
	400 x 360	KT 1255 L/R	
	500 x 360	KT 1265 L/R	
Infobox: Required specification for ordering: - Hinges left (L) / right (R)			

PuraVida Design by Phoenix Design

Product Information

Fronts Body Edges Mirror ground plate Body Mirror Cabinet	Lacquer	85 White High Gloss	PU-mouldings. Lacquered opaque in several coats. Surfaces resistant to moisture.
Body outside	Lacquer	85 White High Gloss	High-compressed MDF boards. Lacquered opaque in several coats. Surfaces resistant to moisture.
Body inside	Decor	37 Aluminium White	High-compressed MDF boards, directly coated with melamine resin decor on one side. Surfaces resistant to moisture.
Recessed grip Edge of body		40 Black High Gloss 59 Ebony 70 Aluminium 85 White High Gloss 88 Red High Gloss	ABS-Edge material
Console and cover plate each in combination with edge (console, semi-tall cabinet and mobile storage unit)	Surface laminate (Pricegroup 1)	70 Aluminium	Compact laminated panel, with laminate (HPL) pressed on one side, glued with three-ply chipboard at bottom side, with laminate (HPL) in (37) White Aluminium. Surfaces resistant to moisture.
	Edge	85 White High Gloss	ABS-Edge material
	Surface Real wood veneer (Pricegroup 2)	59 Ebony	Compact laminated panel, with real wood veneer pressed on one side, glued with three-ply chipboard at bottom side, with laminate (HPL) in (37) White Aluminium. Real wood veneer is a natural material, differences in colour and structure may occur. Surfaces resistant to moisture.
	Edge	85 White High Gloss	ABS-Edge material
	Surface Lacquer (Pricegroup 3)	85 White High Gloss	Compact laminated panel, pressed with several layers of covering lacquer on one side, glued with three-ply chipboard at bottom side, with laminate (HPL) in (37) White Aluminium. Surfaces resistant to moisture.
	Edge	85 White High Gloss	ABS-Edge material
	Surface Lacquer (Pricegroup 4)	40 Black High Gloss 88 Red High Gloss	Compact laminated panel. Lacquered opaque in several coats on one side, glued with three-ply chipboard at bottom side, with laminate (HPL) in (37) White Aluminium. Surfaces resistant to moisture.
Edge	85 White High Gloss	ABS-Edge material	
Hinge mirror cabinet		Aluminium	Silver anodised
Rail inside of doors		10 Chrome	Metal, chrome
glass dividers			Clear Glass

Ordering Sample

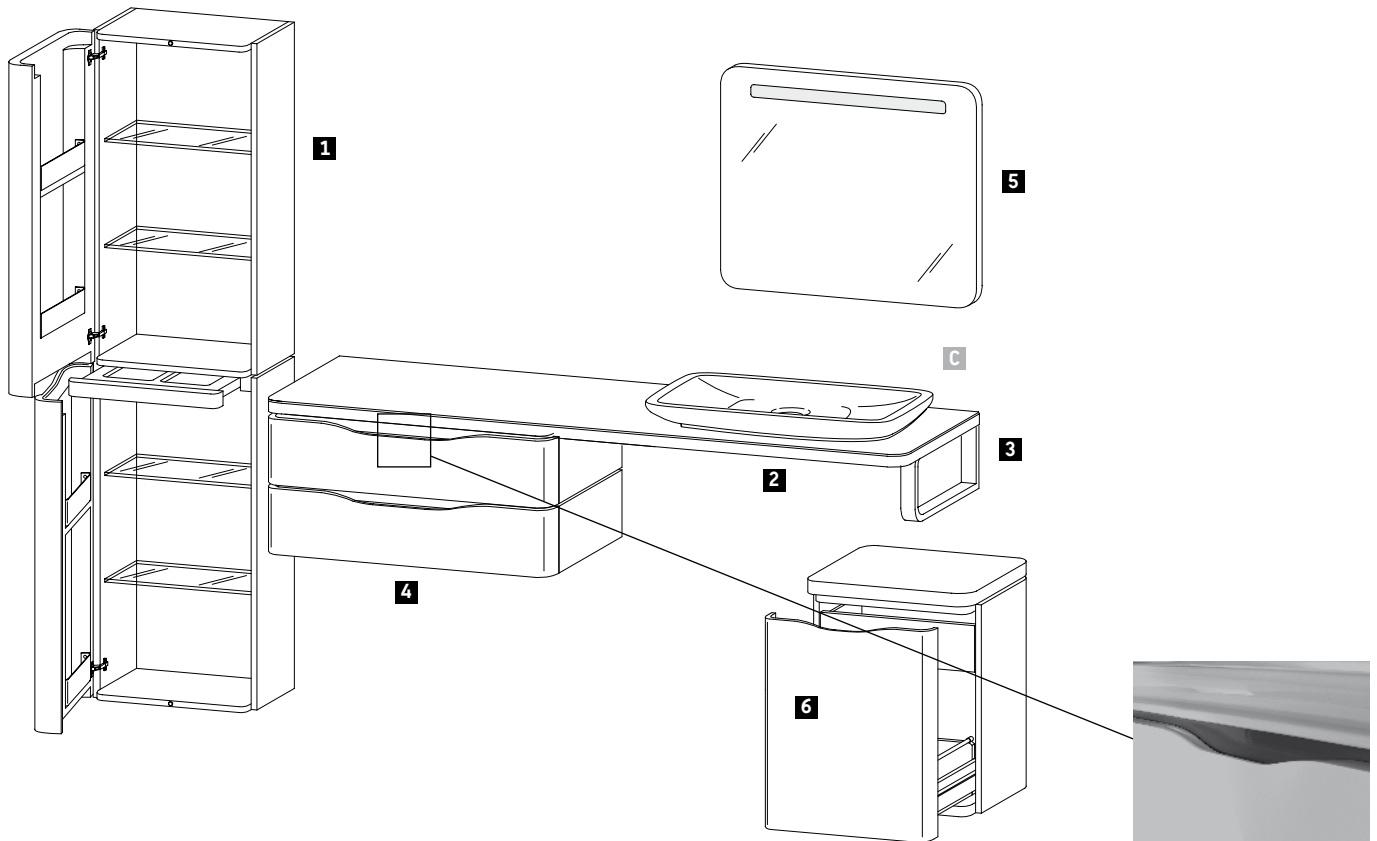

PuraVida

Console, cover plate, mobile storage unit
Edge
Interior colour of recessed handle



88 Red High Gloss
85 White High Gloss
88 Red High Gloss

Description	Remark	Quantity	Model-No.
1 Tall Cabinet	Width 460 mm	1	# PV 9206 L 85 88
2 Console	Width 1800 mm	1	# PV 071C 0 85 88
3 Console support (Towel rail)		1	# PV 9933 0 00 00
4 Low cabinet for console	Width 800 mm, installed lateral left side	1	# PV 9202 0 85 88
5 Mirror with lighting	Width 720 mm	1	# PV 9421 0 85 85
6 Mobile storage unit	Width 460 mm	1	# PV 9203 0 85 88
C PuraVida 700 mm		1	# 037070 00 00

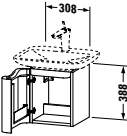
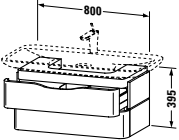
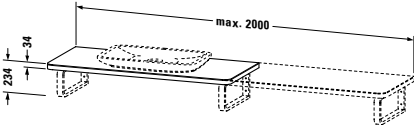
PuraVida Design by Phoenix Design

Description	mm	Model-No.	Euro			
			Pricegroup 1	Pricegroup 2	Pricegroup 3	Pricegroup 4
 <p>Vanity unit wall-mounted 1 door, including 1 integrated shelf and rail inside, width 428 mm (opened) for PuraVida # 072150</p>	308 x 358	PV 6765 L/R				
Infobox: Space saving siphon # 005073 is recommended / Required specification for ordering: - interior colour of recessed handle - Hinges left (L) / right (R)						
 <p>Vanity unit wall-mounted 2 drawers (1 x including cut out for siphon and siphon cover) for PuraVida # 037110</p>	800 x 450	PV 6767				
Infobox: Required specification for ordering: - interior colour of recessed handle						
 <p>Console countertop including one cut-out, Width min. see ordering information, Width max 2000 mm, edges: 85 White High Gloss, inlaying plate possible in all PuraVida colors</p>						
basic price till 800 mm, for back-to-wall	550	PV 071C				
basic price till 800 mm, for corner left / right	550	PV 073C L/R				
basic price till 800 mm, for niche	550	PV 075C				
price per section of 100 mm						
Infobox: Indication of measures and drawings, please refer to order sheet page 674 / Required specification for ordering: - overall width - surface inlaying plate - dimension between axes from left side - number and position of floor cabinets - number and position of console supports - Vanity units have to be flush left side respectively right side with the console - Vanity units are not mountable together - Model-no. ceramic, please see page 673						

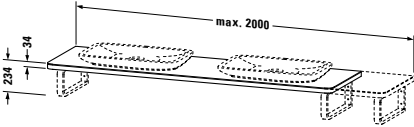
PuraVida Design by Phoenix Design

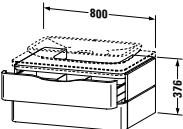
Description	mm	Model-No.	Euro			
			Pricegroup 1	Pricegroup 2	Pricegroup 3	Pricegroup 4
 <p>Console 1 console with two cut-outs, Width min. see ordering information, Width max 2000 mm, edges: 85 White High Gloss, inlaying plate possible in all PuraVida colors basic price till 800 mm, for back-to-wall 550 basic price till 800 mm, for corner left / right 550 basic price till 800 mm, for niche 550 price per section of 100 mm</p>						
<p>Infobox: Indication of measures and drawings, please refer to order sheet page 674 / Required specification for ordering:</p> <ul style="list-style-type: none"> - overall width - surface inlaying plate - dimension between axes from left side - number and position of floor cabinets - number and position of console supports - Vanity units have to be flush left side respectively right side with the console - Vanity units are not mountable together - Model-no. ceramic, please see page 673 						
 <p>Console Support 1 console support-bracket, mountable beneath console grey, powder-coated 40 x 425</p>						
 <p>Console Support 1 console support-towel rail, mountable beneath console chrome 40 x 480</p>						
 <p>Vanity unit wall-mounted 2 drawers, (1 x including cut out for siphon and siphon cover, for console for PuraVida # 037070, # 036970 800 x 550</p>						
<p>Infobox: Only in connection with consoles # PV 071C - # PV 076C / Siphon # 005026 is recommended / Position of vanity unit = central in relation to basin / Required specification for ordering:</p> <ul style="list-style-type: none"> - interior colour of recessed handle / Console not included in delivery, please order separately 						

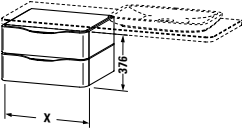
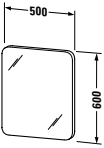
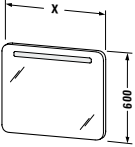
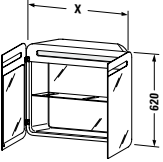

PuraVida Design by Phoenix Design

Description	mm	Model-No.	Euro			
			Pricegroup 1	Pricegroup 2	Pricegroup 3	Pricegroup 4
						
Low cabinet for console						
2 drawers						
	460 x 550	PV 9200				
	600 x 550	PV 9201				
	800 x 550	PV 9202				
Infobox: Required specification for ordering: - interior colour of recessed handle						
						
Mirror						
ground plate mirror: 85 White High Gloss Lacquer	500 x 41	PV 9420				
						
Mirror with lighting						
IP 44, switch (touch LED) central below is coevally LED night light including light sensor, ground plate mirror: 85 White High Gloss Lacquer						
T5 lighting 3500 kelvin light colour, 14 W 720 x 41		PV 9421				
T5 lighting 3500 kelvin light colour, 21 W 1000 x 41		PV 9422				
						
Mirror cabinet						
IP 44, switch (touch LED) central below is coevally LED night light including light sensor, back panel inside mirror glass, 1 socket with flap (colour: chrome) inte- grated in body above, body of mirror cabinet lacquered in 85 White High Gloss on all sides						
T5 lighting 3500 kelvin light colour, 14 W 720 x 188		PV 9424				
T5 lighting 3500 kelvin light colour, 21 W 1000 x 188		PV 9425				

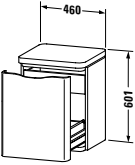
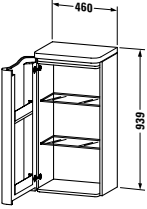
PuraVida Design by Phoenix Design

Description	mm	Model-No.	Euro			
			Pricegroup 1	Pricegroup 2	Pricegroup 3	Pricegroup 4
 <p>Mobile storage unit 1 drawer including integrated shelf and rail inside, 1 inside drawer, surface cover plate available in PuraVida colours edge cover plate: 85 White High Gloss 460 x 450 PV 9203</p>						
<p>Infobox: Required specification for ordering: - surface cover plate - interior colour of recessed handle</p>						
 <p>Semi-tall cabinet 1 door, including 2 integrated shelves and rail inside, 2 glass shelves, surface cover plate available in PuraVida colours, edge cover plate: 85 White High Gloss width 530 mm (opened) 460 x 360 PV 9205 L/R</p>						
<p>Infobox: Required specification for ordering: - surface cover plate - interior colour of recessed handle - Hinges left (L) / right (R)</p>						

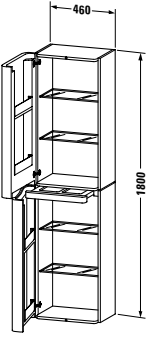
PuraVida Design by Phoenix Design

Description	mm	Model-No.	Euro			
			Pricegroup 1	Pricegroup 2	Pricegroup 3	Pricegroup 4
						
Tall cabinet 2 doors, each door including 2 integrated shelves and rails inside, 4 glass shelves, 1 central shelf including integrated tray drawer						
width 530 mm (opened)	460 x 360	PV 9206 L/R				
Infobox: Required specification for ordering: - interior colour of recessed handle - Hinges left (L) / right (R)						
						
Divider-box drawer for vanity unit and mobile storage unit to apply on anti-slip mat inside drawer	200 x 320	PV 9920				
						
Divider-box drawer for floor cabinets to apply on anti-slip mat inside drawer	200 x 420	PV 9921				

Starck Design by Philippe Starck

Product Information

Fronts Body Vanity Unit # S1 9523 and # S1 9520	Real wood veneer (pricegroup 1)	05 Oak 13 American Walnut 24 Macassar	Base: solid wood, multiplex curved pasted plywood. Outside real wood veneer, colourless lacquered. Interior finish: laminate (HPL) in (37) White Aluminium for # S1 9523 and laminate (HPL) in black for # S1 9520. Real wood veneer is a natural material, differences in colour and structur may occur. Surface resistant to moisture.
	Lacquer (pricegroup 2)	85 White High Gloss	Base: solid wood, multiplex curved pasted plywood. Outside lacquered opaque in several coats. Interior finish: laminate (HPL) in (37) White Aluminium for # S1 9523 and laminate (HPL) in black for # S1 9520. Surface resistant to moisture.
	Lacquer (pricegroup 3)	40 Black High Gloss	Description of material see Fronts, Body, Vanity Unit # S1 9523 and # S1 9520 (Lacquer)
Fronts Body # S1 9526, S1 9528, S1 9529, S1 9108	Real wood veneer (pricegroup 1)	05 Oak 13 American Walnut 24 Macassar	High-compressed three-ply chipboard . Outside real wood veneer, colourless lacquered. Interior finish: laminate (HPL) in (37) White Aluminium. Real wood veneer is a natural material, differences in colour and structur may occur. Surface resistant to moisture.
	Lacquer (pricegroup 2)	85 White High Gloss	High-compressed MDF boards. Lacquered opaque in several coats. Interior finish: laminate (HPL) in (37) White Aluminium. Surface resistant to moisture.
	Lacquer (pricegroup 3)	40 Black High Gloss	Description of material see Fronts, Body # S1 9526, S1 9528, S1 9529, S1 9108 (Lacquer)
Fronts # S1 9526, S1 9528, S1 9529, S1 9108	Real wood veneer (pricegroup 1)	05 Oak 13 American Walnut 24 Macassar	Lightweight building board, consisting of 2 three-ply chipboard with honeycomb core layer. Outside real wood veneer, colourless lacquered. Edges on top and above in real wood veneer, colourless lacquered. Vanity units with side edges of vanity units with coverprofile (anodised aluminium profile), tall cabinet with cover profile only on handle edge. Interior finish: laminate (HPL) in (37) White Aluminium. Real wood veneer is a natural material, differences in colour and structur may occur. Surface resistant to moisture.
	Lacquer (pricegroup 2)	85 White High Gloss	Lightweight building board, consisting of 2 three-ply chipboard with honeycomb core layer. Outside lacquered opaque in several coats. Edges on top and above lacquered opaque. Side edges of vanity units with coverprofile (anodised aluminium profile), tall cabinet with cover profile only on handle edge. Interior finish: laminate (HPL) in (37) White Aluminium. Surface resistant to moisture.
	Lacquer (pricegroup 3)	40 Black High Gloss	Description of material see Fronts # S1 9526, S1 9528, S1 9529, S1 9108 (Lacquer)
Edges Mirror ground plate Body Mirror Cabinet		Neutral	
Box drawer for mirror cabinets + vanity unit # S1 9523	Lacquer	37 White Aluminium	Solid wood, all sides lacquered (open porous) in white aluminium.
Handle # S1 9520		10 Chrome	Brass
Handle # S1 9523		Aluminium	Anodised, Silver
Cover profile vanity units and tall cabinet		Aluminium	Anodised, Silver

Furniture Surfaces see end of pricelist

Starck Design by Philippe Starck

Ordering Sample

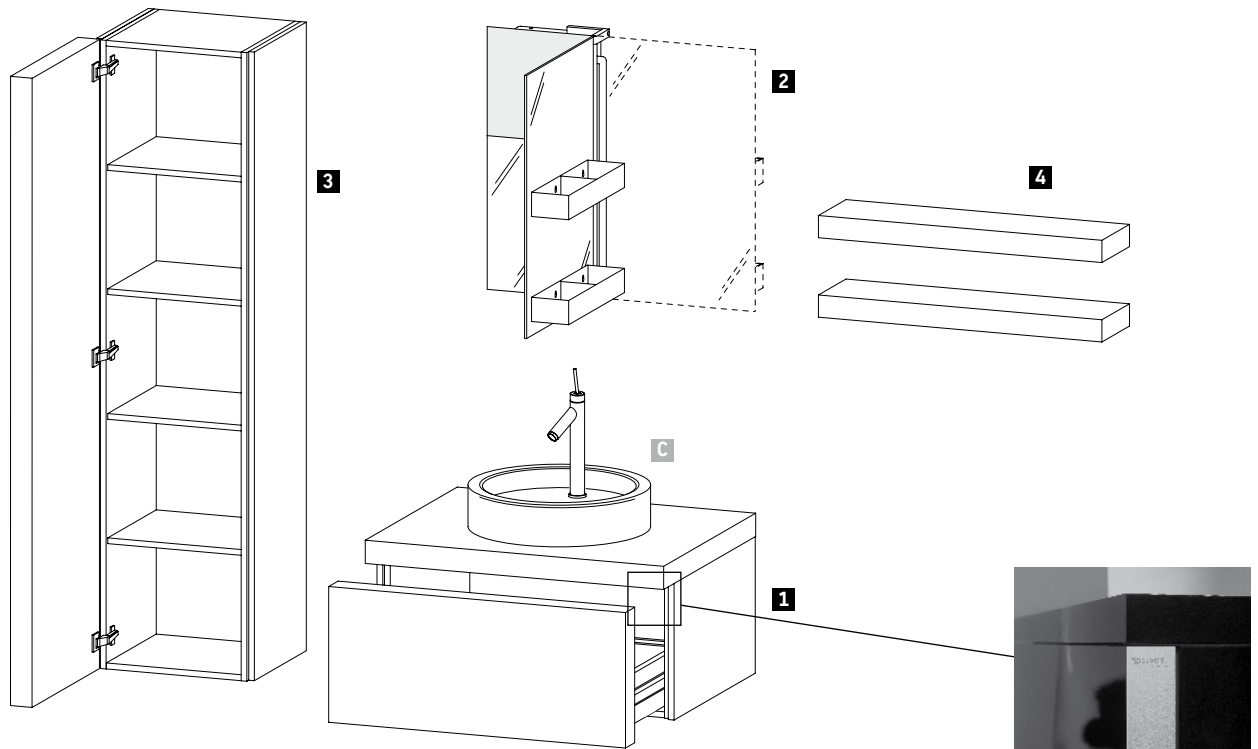

Starck
Vanity Unit, Tall cabinet
Wall board



85 White High Gloss
05 Oak

Description	Remark	Quantity	Model-No.
1 Vanity unit wall mounted	Width 835 mm	1	# S1 9526 0 85 85
2 Mirror cabinet	Width 750 mm	1	# S1 9721 R 00 00
3 Tall cabinet	Width 400 mm	1	# S1 9108 L 85 85
4 Wall board	Width 800 mm	2	# S1 9428 0 05 05
Divider-box drawer	Width 200 mm	1	# S1 9915 0 00 00
C Washbowl Starck 470 mm		1	# 038647 00 27

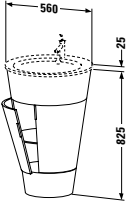
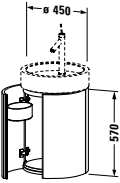
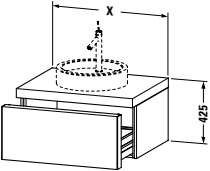
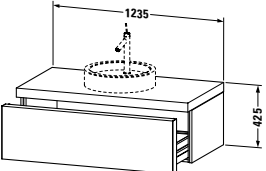
Starck Design by Philippe Starck

Description	mm	Model-No.	Euro		
			Pricegroup 1	Pricegroup 2	Pricegroup 3
 <p>Vanity unit floor-standing 1 glass shelf with rail for Starck 1 # 040658</p>	560 x 600	S1 9520			
Infobox: Siphon # 005026 is recommended					
 <p>Vanity unit wall-mounted circular, 2 doors, 2 wooden boxes, width 900 mm (opened) for Starck 1 # 038647</p>	450 x 500	S1 9523			
Infobox: Siphon # 005026 is recommended					
 <p>Vanity unit wall-mounted 1 pull-out compartment 1 countertop including one central cut-out</p>	835 x 565	S1 9526			
Infobox: Including handleless Tip-On technology / Space saving siphon # 005073 is recommended / Required specification for ordering: - Model-no. ceramic, please see page 664					
 <p>Vanity unit wall-mounted 1 pull-out compartment countertop including one cut-out</p>	1235 x 565	S1 9528 L/R/M			
Infobox: Including handleless Tip-On technology / Space saving siphon # 005073 is recommended / Required specification for ordering: - L/R/M = washbasin left, right or central possible - Model-no. ceramic, please see page 664					

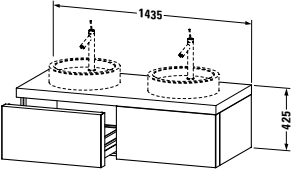
Starck Design by Philippe Starck

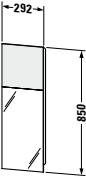
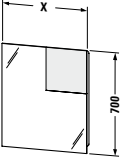
Description	mm	Model-No.	Euro		
			Pricegroup 1	Pricegroup 2	Pricegroup 3
 <p>Vanity unit wall-mounted 2 pull-out compartments 1 countertop with one cut-out or two cut-outs</p>	1435 x 565	S1 9529 L/R/B			
Infobox: Including handleless Tip-On technology / Space saving siphon # 005073 is recommended / Required specification for ordering: - L/R/B = washbasin left, right or on both sides possible - Model-no. ceramic, please see page 664					
 <p>Divider-box drawer to apply on anti-slip mat inside drawer</p>	200 x 375	S1 9915			
 <p>Mirror with lighting IP 44, 1 compact fluorescent tube Dulux F 24 W 840 CW 1 sensor switch</p>	292 x 100	S1 9716			
Infobox: Distance between sensor and reflecting surfaces = minimum 75 mm					
 <p>Mirror with lighting IP 44, 1 compact fluorescent tube Dulux F 24 W 840 CW, 1 sensor switch</p>	600 x 100 750 x 100	S1 9717 S1 9718			
Infobox: Distance between sensor and reflecting surfaces = minimum 75 mm					

Starck Design by Philippe Starck

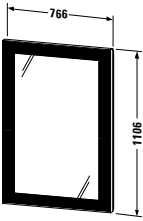
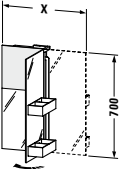
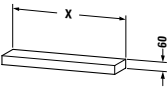
Description	mm	Model-No.	Euro		
			Pricegroup 1	Pricegroup 2	Pricegroup 3
 <p>Mirror with lighting 4 fluorescent tubes 2 x 24 W (horizontal), 2 x 39 W (vertical), FQ fluorescent tube (halogen bracket lamp, $\varnothing = 16$ mm, socket G5), mirror thickness = 6 mm, mirror surface with all-round striped edges (width = 80 mm) 1 sensor switch bottom right</p>	766 x 60	S1 9640			
Infobox: Distance between sensor and reflecting surfaces = minimum 75 mm					
 <p>Mirror cabinet IP 44, 1 compact fluorescent tube Dulux F 24 W 840 CW, 1 sensor switch, 2 wooden boxes, 1 mirror door, 1 socket</p>	600 x 135 750 x 135	S1 9720 L/R S1 9721 L/R			
Infobox: Distance between sensor and reflecting surfaces = minimum 75 mm / Hinges central / door can be opened 180° / The picture shows version „right“ / Required specification for ordering: - position of door left (L) / right (R)					
 <p>Wall board 1 shelf, fixation with locking pin</p>	600 x 200 800 x 200 1200 x 200	S1 9427 S1 9428 S1 9429			

Starck Design by Philippe Starck

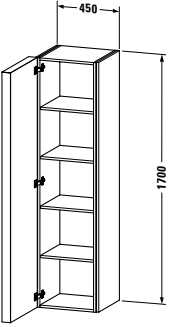
Description	mm	Model-No.	Euro		
			Pricegroup 1	Pricegroup 2	Pricegroup 3
 <p>Tall cabinet 1 door, 4 wooden shelves width 480 mm (opened)</p>	450 x 420	S1 9108 L/R			
Infobox: Required specification for ordering: - Hinges left (L) / right (R)					

X-Large Design by sieger design

Product Information

Fronts Body	Decor (Pricegroup 1)	18 White Matt 53 Chestnut Dark 79 Natural Walnut	High-compressend three-ply chipboard, directly coated with melamine resin decor on both sides, ABS-Edge material. Surface resistant to moisture.
	Decor (Pricegroup 2)	22 White High Gloss	High-compressed three-ply chipboard, with laminate (HPL) pressed on both sides, ABS-Edge material. Surface resistant to moisture
	Real wood veneer (Pricegroup 3)	12 Brushed Oak 62 Anthracite Oak	High-compressed three-ply chipboard, with real wood veneer pressed on one side and laminate (HPL) in (37) White Aluminium pressed on the other side. Trim in real wood veneer. Real wood veneer is a natural material, differences in colour and structure may occur. Surface resistant to moisture.
	Lacquer (Pricegroup 4)	85 White High Gloss 86 Cappuccino High Gloss	High-compressed MDF board. Lacquered opaque in several coats. Inside directly coated with melamine resin decor. Surface resistant to moisture.
Mirror / Mirror cabinet with lighting			LED light technology, 3500 Kelvin light colour. Sensor switch bottom right for on/off function.
Mirror	Decor (Pricegroup 1)	18 White Matt 53 Chestnut Dark 79 Natural Walnut	High-compressed MDF board, directly coated with melamine resin decor in (37) White Aluminium, ABS-Edge material. Surface resistant to moisture.
	Decor (Pricegroup 2)	22 White High Gloss	High-compressed MDF board, directly coated in melamine resin decor in (37) White Aluminium, ABS-Edge material. Surface resistant to moisture.
	Real wood veneer (Pricegroup 3)	12 Brushed Oak 62 Anthracite Oak	High-compressed MDF board, directly coated in melamine resin decor in (37) White Aluminium. Trim in real wood veneer. Surface resistant to moisture.
	Lacquer (Pricegroup 4)	85 White High Gloss 86 Cappuccino High Gloss	High-compressed MDF board, directly coated in melamin resin decor in (37) White Aluminium, ABS-Edge material lacquered. Surface resistant to moisture.
Mirror cabinet	Decor (Pricegroup 1)	18 White Matt 53 Chestnut Dark 79 Natural Walnut	High-compressed three-ply chipboard, with laminate (HPL) pressed on both sides, ABS-Edge material. Outside: depended on surface / Inside: laminate (HPL) in (37) White Aluminium. Surface resistant to moisture.
	Decor (Pricegroup 2)	22 White High Gloss	High-compressed three-ply chipboard, with laminate (HPL) pressed on both sides, ABS-Edge material. Outside: depended on surface / Inside: laminate (HPL) in (37) White Aluminium. Surface resistant to moisture.
	Real wood veneer (Pricegroup 3)	12 Brushed Oak 62 Anthracite Oak	High-compressed three-ply chipboard, with real wood veneer pressed on one side and laminate (HPL) in (37) White Aluminium pressed on the other side. Trim in real wood veneer. Real wood veneer is a natural material, differences in colour and structure may occur. Surface resistant to moisture.
	Lacquer (Pricegroup 4)	85 White High Gloss 86 Cappuccino High Gloss	High-compressed MDF board. Outside one-sided laquered opaque in several coats and highly polished. Inside directly coated with melamin resin decor. Surface resistant to moisture.

X-Large Design by sieger design

Product Information

Consoles	Decor (Pricegroup 1)	18 White Matt 53 Chestnut Dark 79 Natural Walnut	High-compressed three-ply chipboard, with laminate (HPL) pressed on both sides, ABS-Edge material. Surface resistant to moisture.
	Decor (Pricegroup 2)	22 White High Gloss	High-compressed three-ply chipboard, with laminate (HPL) pressed on both sides, ABS-Edge material. Surface resistant to moisture.
	Real wood veneer (Pricegroup 3)	12 Brushed Oak 62 Anthracite Oak	High-compressed three-ply chipboard, with real wood veneer pressed on one side and laminate (HPL) in (57) Black Diamond on the other side. Trim in real wood veneer. Real wood veneer is a natural material, differences in colour and structure may occur. Surface resistant to moisture.
	Lacquer (Pricegroup 4)	85 White High Gloss 86 Cappuccino High Gloss	High-compressed MDF board. One-sided laquered opaque in several coats including shadow gab. Console underside: directly coated with melamin resin decor. Surface resistant to moisture.
Wall board	Decor (Pricegroup 1)	18 White Matt 53 Chestnut Dark 79 Natural Walnut	High-compressed three-ply chipboard, directly coated with melamine resin decor on both sides, ABS-Edge material. Surface resistant to moisture.
	Decor (Pricegroup 2)	22 White High Gloss	High-compressed three-ply chipboard, with laminate (HPL) pressed on both sides, ABS-Edge material. Surface resistant to moisture.
	Real wood veneer (Pricegroup 3)	12 Brushed Oak 62 Anthracite Oak	High-compressed three-ply chipboard, with real wood veneer pressed on both sides. Trim in real wood veneer. Real wood veneer is a natural material, differences in colour and structure may occur. Surface resistant to moisture.
	Lacquer (Pricegroup 4)	85 White High Gloss 86 Cappuccino High Gloss	High-compressed MDF board. Lacquered opaque in several coats. Surface resistant to moisture.
Soundsystem	<p>The 2.1 system with 2 flat drive speakers, 1 active bass and 1 passive bass create a high-quality listening experience, especially matched to the bathroom situation.</p> <p>Output power: 2x5 Watt (tweeter/midrange), 1x25 Watt (active bass with one passive radiator-principle).</p> <p>The technical components of the soundsystem are invisibly integrated into the LED Mirror cabinet, with a loss of the useable volume of 55 mm in height. The control of the soundsystem is independent of the illumination. Music streaming and control is compatible with all Bluetooth enabled devices, that support the A2DP profile (stereo audio profiles). The standby power consumption is less than 0.5 Watt.</p>		
Interior System	Box in ash solid wood / bottom ash veneered		

X-Large Design by sieger design

Ordering Sample

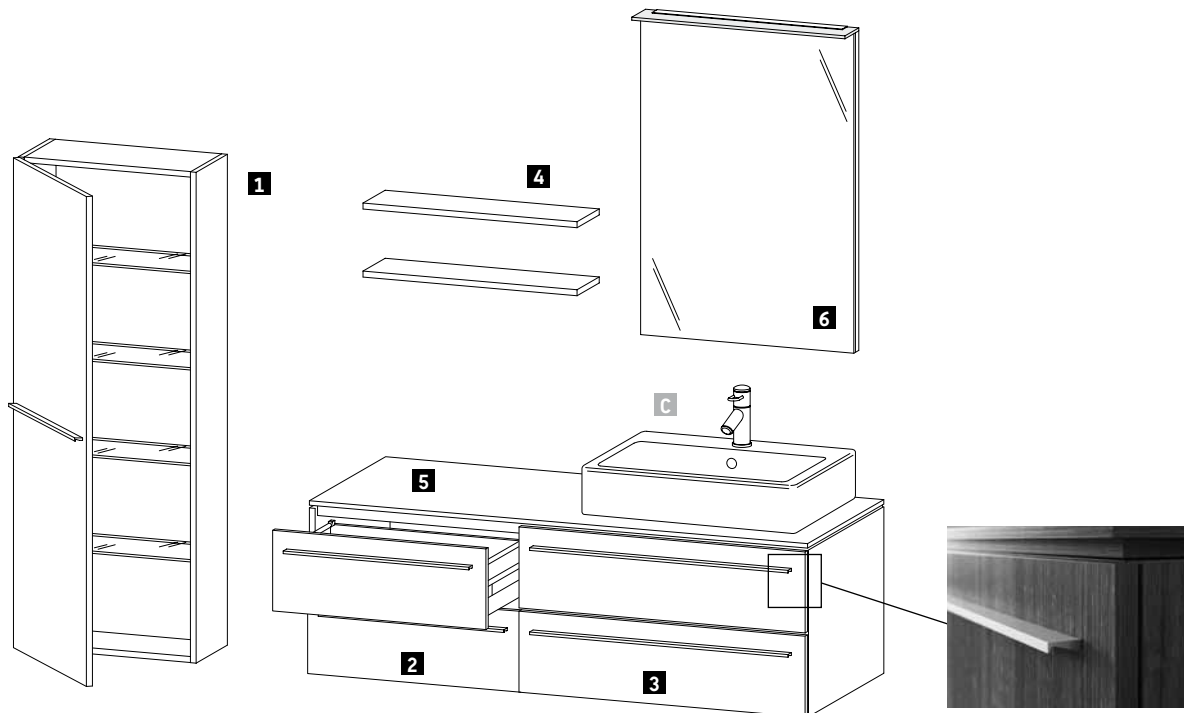

X-Large
Console, Vanity Unit,
Low Cabinet, Tall Cabinet,
Wall board, Mirror

22 White High Gloss

Description	Remark	Quantity	Model-No.
1 Tall cabinet	Width 500 mm	1	# XL 1154 L 22 22
2 Low cabinet for console	Width 600 mm	1	# XL 6724 0 22 22
3 Vanity unit for console	Width 800 mm	1	# XL 6714 0 22 22
4 Wall board	Width 600 mm	2	# XL 7912 0 22 22
5 Console for above counter basin	Width 1400 mm	1	# XL 025C 0 22 22
6 Mirror with lighting	Width 600 mm	1	# XL 7292 0 22 22
C Vero washbowl		1	# 045460 00 27

X-Large Design by sieger design

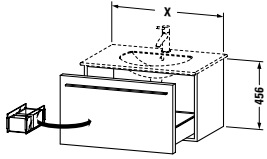
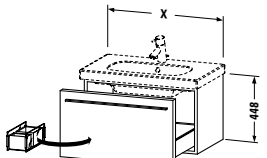
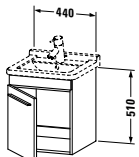
Description	mm	Model-No.	Euro			
			Pricegroup 1	Pricegroup 2	Pricegroup 3	Pricegroup 4
 <p>Vanity unit wall-mounted 1 pull-out compartment, including compartment consists of glass dividers and 2 boxes (small/large) for Darling New # 049953, without compartment</p>						
	500 x 407	XL 6060				
for Darling New # 049963	600 x 497	XL 6061				
for Darling New # 049983	800 x 522	XL 6062				
for Darling New # 049910	1000 x 522	XL 6063				
 <p>Vanity unit wall-mounted 1 pull-out compartment, including compartment consists of glass dividers and 2 boxes (small/large)</p>						
for D-Code # 034265	600 x 458	XL 6051				
for D-Code # 034285	800 x 458	XL 6048				
for D-Code # 034210	1000 x 458	XL 6049				
for D-Code # 034812	1150 x 458	XL 6050				
Infobox: Space saving siphon # 005073 is recommended						
 <p>Vanity unit wall-mounted 1 door</p>						
for Starck 3 # 030348	440 x 443	XL 6525 L/R				
Infobox: Required specification for ordering: - hinges left (L) / right (R) / Space saving siphon # 005073 is recommended						

X-Large Design by sieger design

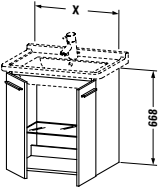
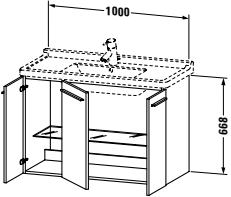
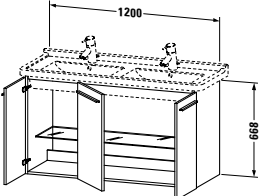
Description	mm	Model-No.	Euro			
			Pricegroup 1	Pricegroup 2	Pricegroup 3	Pricegroup 4
 <p>Vanity unit wall-mounted 2 doors, 1 glass shelf for Starck 3 # 030480, 030470 600 x 468 XL 6088 for Starck 3 # 030410, 030480 800 x 468 XL 6086</p>						
Infobox: Space saving siphon # 005073 is recommended						
 <p>Vanity unit wall-mounted 3 doors, 2 glass shelves for Starck 3 # 030410 1000 x 468 XL 6084</p>						
Infobox: Space saving siphon # 005073 is recommended						
 <p>Vanity unit wall-mounted 3 doors, 2 glass shelves for Starck 3 # 033213 1200 x 468 XL 6068</p>						
Infobox: Space saving siphon # 005073 is recommended						

X-Large Design by sieger design

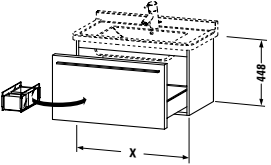
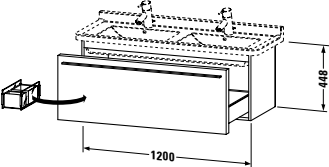
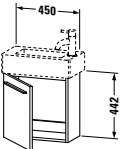
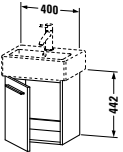
Description	mm	Model-No.	Euro			
			Pricegroup 1	Pricegroup 2	Pricegroup 3	Pricegroup 4
 <p>Vanity unit wall-mounted 1 pull-out compartment, including compartment consists of glass dividers and 2 boxes (small/large) for Starck 3 # 030480, 030470 600 x 468 XL 6056 for Starck 3 # 030410, 030480 800 x 468 XL 6057 for Starck 3 # 030410 1000 x 468 XL 6058</p> <p>Infobox: Space saving siphon # 005073 is recommended</p>						
 <p>Vanity unit wall-mounted 1 pull-out compartment, including compartment consists of glass dividers and 2 boxes (small/large) for Starck 3 # 033213 1200 x 468 XL 6059</p> <p>Infobox: Space saving siphon # 005073 is recommended</p>						
 <p>Vanity unit wall-mounted 1 door for Vero # 070350 (not ground) 450 x 228 XL 6208 L/R</p> <p>Infobox: Required specification for ordering: - Hinges left (L) / right (R) / Space saving siphon # 005073 is recommended</p>						
 <p>Vanity unit wall-mounted 1 door for Vero # 070445 (not ground) 400 x 328 XL 6209 L/R</p> <p>Infobox: Required specification for ordering: - Hinges left (L) / right (R) / Space saving siphon # 005073 is recommended</p>						

X-Large Design by sieger design

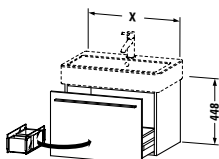
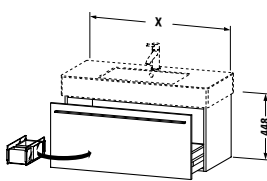
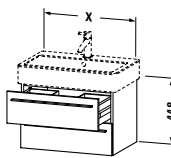
Description	mm	Model-No.	Euro			
			Pricegroup 1	Pricegroup 2	Pricegroup 3	Pricegroup 4
 <p>Vanity unit wall-mounted 1 pull-out compartment, including compartment consists of glass dividers and 2 boxes (small/large) for Vero # 045450 (not ground), without compartment 450 x 443 XL 6043 for Vero # 045360, # 045460 (not ground) 550 x 443 XL 6044 for Vero # 045470 (not ground) 650 x 443 XL 6042 for Vero # 045480 (not ground) 750 x 443 XL 6045 for Vero # 045410 (not ground) 950 x 443 XL 6046 for Vero # 045412 (not ground) 1150 x 443 XL 6047</p>						
Infobox: Space saving siphon # 005073 is recommended						
 <p>Vanity unit wall-mounted 1 pull-out compartment, including compartment consists of glass dividers and 2 boxes (small/large) for Vero # 032985 (not ground) 800 x 468 XL 6052 for Vero # 032910 (not ground) 1000 x 468 XL 6053 for Vero # 032912 (not ground) 1200 x 468 XL 6054</p>						
Infobox: Space saving siphon # 005073 is recommended						
 <p>Vanity unit wall-mounted 2 drawers, upper drawer including cut-out for siphon and siphon cover for Vero # 045450 (not ground) 450 x 443 XL 6343 for Vero # 045360, # 045460 (not ground) 550 x 443 XL 6344 for Vero # 045470 (not ground) 650 x 443 XL 6342 for Vero # 045480 (not ground) 750 x 443 XL 6345 for Vero # 045410 (not ground) 950 x 443 XL 6346 for Vero # 045412 (not ground) 1150 x 443 XL 6347</p>						
Infobox: Space saving siphon # 005073 is recommended						

X-Large Design by sieger design

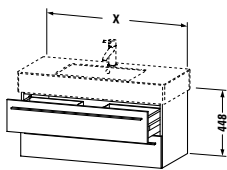
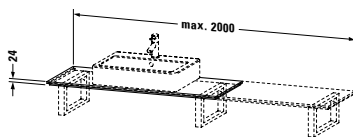
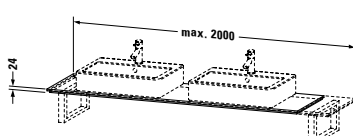
Description	mm	Model-No.	Euro			
			Pricegroup 1	Pricegroup 2	Pricegroup 3	Pricegroup 4
 <p>Vanity unit wall-mounted 2 drawers, upper drawer including cut-out for siphon and siphon cover for Vero # 032985 (not ground) 800 x 468 XL 6352 for Vero # 032910 (not ground) 1000 x 468 XL 6353 for Vero # 032912 (not ground) 1200 x 468 XL 6354</p>						
Infobox: Space saving siphon # 005073 is recommended						
 <p>Console for above counter basin 1 console with one cut-out, Width min. see ordering information, Width max 2000 mm basic price for 800 mm, for back-to-wall 480 XL 010C basic price for 800 mm, for corner left 480 XL 011C basic price for 800 mm, for corner right 480 XL 012C basic price for 800 mm, for niche 480 XL 013C price per section of 100 mm</p>						
Infobox: Required specification for ordering: - overall width - dimension between axes from left side - Model-no. ceramic and min. width, please see page 667 - exactly position of floor cabinets/console supports / Please indicate exact measures and drawing please refer to order sheet page 668 / Console tops delivered uncut possible						
 <p>Console for above counter basin 1 console with two cut-outs, Width min. see ordering information, Width max 2000 mm basic price for 800 mm, for back-to-wall 480 XL 015C basic price for 800 mm, for corner left 480 XL 016C basic price for 800 mm, for corner right 480 XL 017C basic price for 800 mm, for niche 480 XL 018C price per section of 100 mm</p>						
Infobox: Required specification for ordering: - overall width - dimension between axes from left side - Model-no. ceramic and min. width, please see page 667 - exactly position of floor cabinets/console supports / Please indicate exact measures and drawing please refer to order sheet page 668						

X-Large Design by sieger design

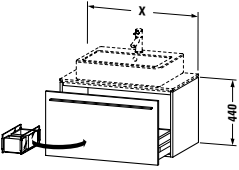
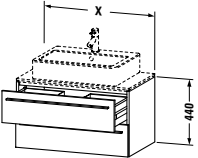
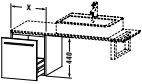
Description	mm	Model-No.	Euro			
			Pricegroup 1	Pricegroup 2	Pricegroup 3	Pricegroup 4
 <p>Vanity unit for console 1 pull-out compartment, including compartment consists of glass dividers and 2 boxes (small/large)</p>						
	600 x 478	XL 6500				
	800 x 478	XL 6501				
	1000 x 478	XL 6502				
Infobox: Console not included in delivery, please order separately						
 <p>Vanity unit for console 2 drawers, upper drawer including cut-out for siphon and siphon cover</p>						
	600 x 478	XL 6510				
	800 x 478	XL 6511				
	1000 x 478	XL 6512				
Infobox: Console not included in delivery, please order separately						
 <p>Low cabinet for console 1 pull-out compartment</p>						
	300 x 478	XL 6531				
	400 x 478	XL 6532				
	500 x 478	XL 6533				
	600 x 478	XL 6534				
Infobox: Console not included in delivery, please order separately						

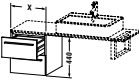
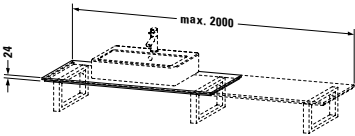
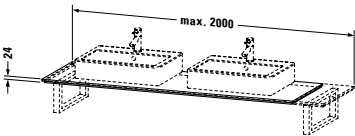

X-Large Design by sieger design

Description	mm	Model-No.	Euro			
			Pricegroup 1	Pricegroup 2	Pricegroup 3	Pricegroup 4
						
Low cabinet for console						
2 drawers						
	300 x 478	XL 6521				
	400 x 478	XL 6522				
	500 x 478	XL 6523				
	600 x 478	XL 6524				
Infobox: Console not included in delivery, please order separately						
						
Console for above counter basin and countertop basin						
1 console with one cut-out, Width min. see ordering information, Width max 2000 mm						
basic price for 800 mm, for back-to-wall	550	XL 025C				
basic price for 800 mm, for corner left	550	XL 026C				
basic price for 800 mm, for corner right	550	XL 027C				
basic price for 800 mm, for niche	550	XL 028C				
price per section of 100 mm						
Infobox: Required specification for ordering: - overall width - dimension between axes from left side - Model-no. ceramic and min. width, please see page 665/666 - exactly position of floor cabinets/console supports Please indicate exact measures and drawing please refer to order sheet page 668 / Console tops delivered uncut possible						
						
Console for above counter basin and countertop basin						
1 console with two cut-outs, Width min. see ordering information, Width max 2000 mm						
basic price for 800 mm, for back-to-wall	550	XL 045C				
basic price for 800 mm, for corner left	550	XL 046C				
basic price for 800 mm, for corner right	550	XL 047C				
basic price for 800 mm, for niche	550	XL 048C				
price per section of 100 mm						
Infobox: Required specification for ordering: - overall width - dimension between axes from left side - Model-no. ceramic and min. width, please see page 665/666 - exactly position of floor cabinets/console supports Please indicate exact measures and drawing please refer to order sheet page 668						

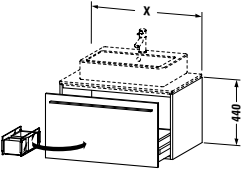
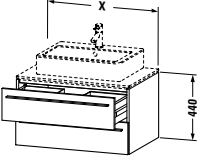
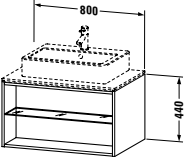
X-Large Design by sieger design

Description	mm	Model-No.	Euro			
			Pricegroup 1	Pricegroup 2	Pricegroup 3	Pricegroup 4
 <p>Vanity unit for console 1 pull-out compartment, including compartment consists of glass dividers and 2 boxes (small/large)</p>	<p>600 x 548</p> <p>800 x 548</p> <p>1000 x 548</p>	<p>XL 6719</p> <p>XL 6713</p> <p>XL 6715</p>				
<p>Infobox: Console not included in delivery, please order separately</p>						
 <p>Vanity unit for console 2 drawers, upper drawer including cut-out for siphon and siphon cover</p>	<p>600 x 548</p> <p>800 x 548</p> <p>1000 x 548</p>	<p>XL 6717</p> <p>XL 6714</p> <p>XL 6716</p>				
<p>Infobox: Vanity unit only possible together with siphon # 005026 / Highriser are not applicable / Console not included in delivery, please order separately</p>						
 <p>Vanity unit wall-mounted 1 opened compartment including glass shelf</p>	<p>800 x 548</p>	<p>XL 6718</p>				
<p>Infobox: Revisable: opened underfloor behind back panel / Console not included in delivery, please order separately / Vanity unit only possible together with siphon # 005026 / Required specification for ordering: - Model-no. ceramic, please see page 659</p>						

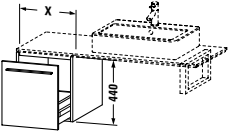
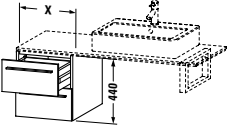
X-Large Design by sieger design

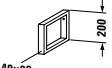
Description	mm	Model-No.	Euro			
			Pricegroup 1	Pricegroup 2	Pricegroup 3	Pricegroup 4
 <p>Low cabinet for console 1 pull-out compartment</p>	300 x 548	XL 6731				
	400 x 548	XL 6732				
	500 x 548	XL 6733				
	600 x 548	XL 6734				
Infobox: Console not included in delivery, please order separately						
 <p>Low cabinet for console 2 drawers</p>	300 x 548	XL 6721				
	400 x 548	XL 6722				
	500 x 548	XL 6723				
	600 x 548	XL 6724				
Infobox: Console not included in delivery, please order separately						
 <p>Console Support 1 console support-bracket, mountable beneath console 480 mm / 550 mm depths grey, powder-coated</p>	40 x 425	XL 9902				
 <p>Console support 100 mm installation in wall 1 console support (depth without pin), mountable beneath console 480 mm / 550 mm depths grey, powder-coated</p>	90 x 420	XL 9926				
Infobox: For using console support on a drywall, a suitable subconstruction is required						
 <p>Console Support 1 console support-towel rail, mountable beneath console 480 mm depths chrome</p>	40 x 455	XL 9917				

X-Large Design by sieger design

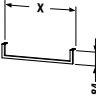
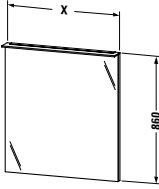
Description	mm	Model-No.	Euro			
			Pricegroup 1	Pricegroup 2	Pricegroup 3	Pricegroup 4
 <p>Console Support 1 console support-towel rail, mountable beneath console 550 mm depths chrome</p>	40 x 480	XL 9903				
 <p>Towel rail mountable beneath console 480 mm / 550 mm depths, square tube, chromed, 14 mm</p>	500 x 14 1000 x 14	XL 9985 XL 9986				
 <p>Mirror with lighting IP 44, 1 sensor switch bottom right LED module 3500 Kelvin light colour, 11 W LED module 3500 Kelvin light colour, 15 W LED module 3500 Kelvin light colour, 20 W LED module 3500 Kelvin light colour, 26 W LED module 3500 Kelvin light colour, 33 W</p>	450 x 36/105 600 x 36/105 800 x 36/105 1000 x 36/105 1200 x 36/105	XL 7290 XL 7292 XL 7294 XL 7295 XL 7296				
<p>Additional modules LED dimming function</p>						
<div style="border: 1px solid black; padding: 2px;"> Infobox: Distance between sensor and reflecting surfaces = minimum 75 mm </div>						

X-Large Design by sieger design

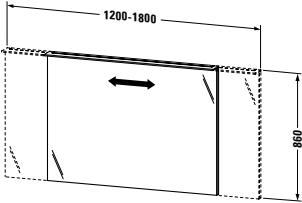
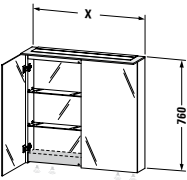
Description	mm	Model-No.	Euro			
			Pricegroup 1	Pricegroup 2	Pricegroup 3	Pricegroup 4
 <p>Mirror with lighting (width variable) IP 44, 1 sensor switch bottom right LED module 3500 Kelvin light colour, 33-51 W</p>	1200-1800 x 36/105	XL 7297				
Additional modules						
LED dimming function						
Infobox: Distance between sensor and reflecting surfaces = minimum 75 mm						
 <p>Mirror cabinet IP 44, 2 mirror doors, back panel inside mirror glass, 2 glass shelves (clear glass), 1 sensor switch bottom right, one socket unit with flap lid in top end</p>						
LED module 3500 Kelvin light colour, 13 W	600 x 138/208	XL 7592				
LED module 3500 Kelvin light colour, 20 W	800 x 138/208	XL 7594				
LED module 3500 Kelvin light colour, 26 W	1000 x 138/208	XL 7595				
LED module 3500 Kelvin light colour, 13 W, incl. Soundsystem	600 x 138/208	XL 7692				
LED module 3500 Kelvin light colour, 20 W, incl. Soundsystem	800 x 138/208	XL 7694				
LED module 3500 Kelvin light colour, 26 W, incl. Soundsystem	1000 x 138/208	XL 7695				
Additional modules						
LED dimming function						
Infobox: Distance between sensor and reflecting surfaces = minimum 75 mm / LED dimming function is already included in the mirror cabinet with Soundsystem						

X-Large Design by sieger design

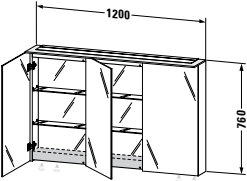
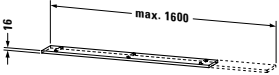
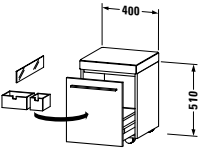
Description	mm	Model-No.	Euro			
			Pricegroup 1	Pricegroup 2	Pricegroup 3	Pricegroup 4
 <p>Mirror cabinet IP 44, 3 mirror doors, back panel inside mirror glass, 2 glass shelves (clear glass), 1 sensor switch bottom right, one socket unit with flap lid in top end LED module 3500 Kelvin light colour, 31 W</p>	1200 x 138/208	XL 7596				
LED module 3500 Kelvin light colour, 31 W, incl. Soundsystem	1200 x 138/208	XL 7696				
<p>Additional modules LED dimming function</p>						
<p>Infobox: Distance between sensor and reflecting surfaces = minimum 75 mm / LED dimming function is already included in the mirror cabinet with Soundsystem</p>						
 <p>Wall board 1 shelf, fixation with locking pin, Width min. 600 mm, Width max. 1600 mm basic price for 600 mm price per section of 100 mm</p>	600-1600 x 160	XL 7912				
<p>Infobox: Material thickness = 16 mm</p>						
 <p>Mobile storage unit 1 pillow, synthetic leather, white 1 drawer including compartment</p>	400 x 400	XL 2704				
<p>Infobox: Max. load: 120 kg</p>						

X-Large Design by sieger design

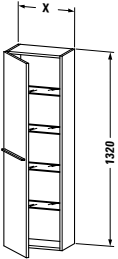
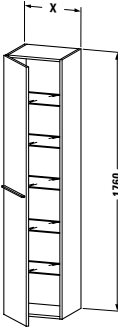
Description	mm	Model-No.	Euro			
			Pricegroup 1	Pricegroup 2	Pricegroup 3	Pricegroup 4
 <p>Tall cabinet 1 wooden door, 4 glass shelves</p>	300 x 238	XL 1150 L/R				
	400 x 238	XL 1152 L/R				
	500 x 238	XL 1154 L/R				
	Infobox: Please keep 20 mm space to the wall / In case of extension to furniture a space of 20 mm is necessary / Required specification for ordering: - Hinges left (L) / right (R)					
 <p>Tall cabinet 1 wooden door, 5 glass shelves</p>	300 x 358	XL 1135 L/R				
	400 x 358	XL 1136 L/R				
	500 x 358	XL 1137 L/R				
	Infobox: Please keep 20 mm space to the wall / In case of extension to furniture a space of 20 mm is necessary / Required specification for ordering: - Hinges left (L) / right (R)					

X-Large Design by sieger design

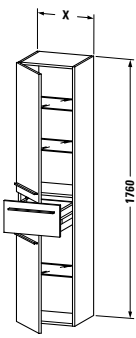
Description	mm	Model-No.	Euro			
			Pricegroup 1	Pricegroup 2	Pricegroup 3	Pricegroup 4
 <p>Tall cabinet 2 wooden doors, 1 drawer, 3 glass shelves</p>	300 x 358	XL 1128 L/R				
	400 x 358	XL 1131 L/R				
	Infobox: Please keep 20 mm space to the wall / In case of extension to furniture a space of 20 mm is necessary / Required specification for ordering: - Hinges left (L) / right (R)					

Light and mirrors

Product Information

Body (all series)	Decor	37 Aluminium White	High-compressed three-ply chipboard directly coated with melamine resin decor on both sides. ABS-Edge material. Surface resistant to moisture.
Ceiling panel (for pivotable mirror with lighting, 2nd floor)	Decor	85 White High Gloss	High-compressed MDF boards with thermofront surface. Ground frame consists of multiple glued plywood, ABS-Edge material in (37) Aluminium White. Surface resistant to moisture.

Light and mirrors

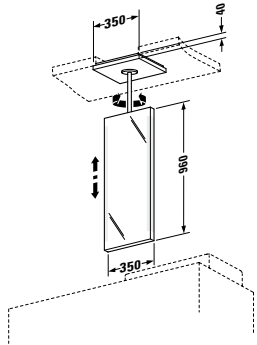
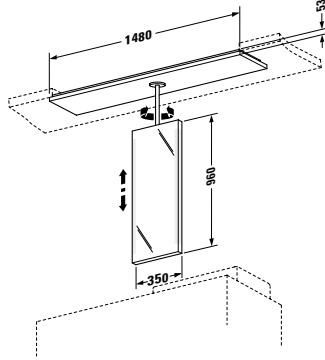
Description	mm	Model-No.	Euro
			
<p>Mirror element with lighting, 2nd floor series 1 mirror with lighting, installed central on ceiling panel, 45° pivotable on left and right side, chromed suspension continuous adjustable (ceiling height 2300 -3000 mm), 2 T5 lighting 3500 kelvin light colour, 21 W, switch (touch LED) central below is coevally LED night light including light sensor ceiling panel (D = 350 x W = 350 mm)</p>	350 x 36	LM 9642	
			
<p>Mirror element with lighting, 2nd floor series 1 mirror with lighting, installed central on ceiling panel, 45° pivotable on left and right side, chromed suspension continuous adjustable (ceiling height 2300 -3000 mm), 2 T5 lighting 3500 kelvin light colour, 21 W, switch (touch LED) central below is coevally LED night light including light sensor ceiling panel (D = 300 mm x W = 1480 mm)</p>	350 x 36	LM 9638	

Light and mirrors

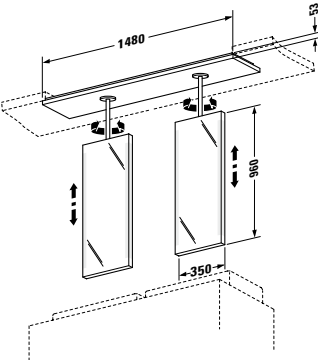
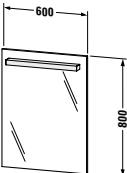
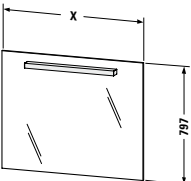
Description	mm	Model-No.	Euro
 <p>Mirror element with lighting, 2nd floor series 2 mirrors with lighting, position of mirror is behind washbasin, 45° pivotable, chromed suspension is continuously adjustable in height (ceiling height 2300 - 3000 mm), 4 T5 lighting 3500 kelvin light colour, 21 W, switch (touch LED) central below is coevally LED night light including light sensor ceiling panel (D = 300 mm x W = 1480 mm)</p>	350 x 36	LM 9639	
 <p>Mirror with lighting IP 44 1 lamp (T5 3500 kelvin light colour, 13 W)</p>	600 x 20/75	LM 9870	
 <p>Mirror with lighting, Fogo Series IP 44, 1 sensor switch, T5 lighting 3500 kelvin light colour</p>			
1 lamp 430 mm, 8 W	597 x 23 / 76	LM 9614	
1 lamp 630 mm, 13 W	797 x 23 / 76	LM 9615	
1 lamp 630 mm, 13 W	997 x 23/76	LM 9616	
1 lamp 960 mm, 21 W	1200 x 23/76	LM 9680	
1 lamp 1270 mm, 28 W	1500 x 23/76	LM 9681	
1 lamp 1270 mm, 28 W	1800 x 23/76	LM 9682	
Infobox: Distance between sensor and reflecting surfaces = minimum 75 mm			

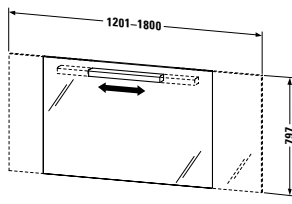
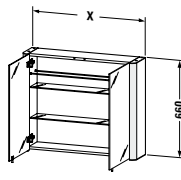
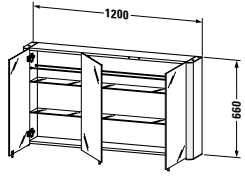

Light and mirrors

Description	mm	Model-No.	Euro
			
<p>Mirror with lighting, Fogo Series IP 44, 1 sensor switch, for width 1201 - 1500 mm fluorescent tube central and 960 mm long, T5 lighting 3500 kelvin light colour, 21 W, for width 1501 - 1800 mm fluorescent tube central and 1270 mm long</p>			
	1201-1800 x 23/76	LM 9620	
<p>Infobox: Distance between sensor and reflecting surfaces = minimum 75 mm</p>			
			
<p>Mirror cabinet, Multibox Series IP 44, 2 mirror doors, 2 glass shelves, 2 rails, switch (touch LED) right below is coevally LED night light including light sensor, 2 T5 lighting 3500 kelvin light colour, 14 W, 1 socket inside right</p>			
	600 x 186	LM 9770	
	800 x 186	LM 9771	
	1000 x 186	LM 9772	
			
<p>Mirror cabinet, Multibox Series IP 44, 3 mirror doors, 4 glass shelves, 2 rails, switch (touch LED) right below is coevally LED night light including light sensor, 2 T5 lighting 3500 kelvin light colour, 14 W 1 socket inside right</p>			
	1200 x 186	LM 9773	

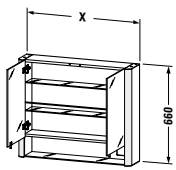
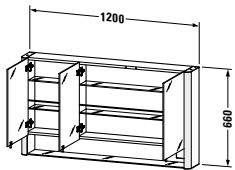
Light and mirrors

Description	mm	Model-No.	Euro
			
Mirror cabinet, Multibox Series			
IP 44, 2 mirror doors, 2 glass shelves, 1 rail, 2 T5 lighting 3500 kelvin light colour, 14 W, 1 socket inside right, 1 opened compartment glass shelf, switch (touch LED) central below is coevally LED night light including light sensor			
	600 x 186	LM 9700	
	800 x 186	LM 9701	
	1000 x 186	LM 9702	
Additional modules			
socket including flap (chromed plastic material) in the range of opened shelf (right side)			
			
Mirror cabinet, Multibox Series			
IP 44, 3 mirror doors, 4 glass shelves, 1 rail, 2 T5 lighting 3500 kelvin light colour, 14 W, 1 socket inside right, 1 opened compartment glass shelf, switch (touch LED) central below is coevally LED night light including light sensor			
	1200 x 186	LM 9703	
Additional modules			
socket including flap (chromed plastic material) in the range of opened shelf (right side)			

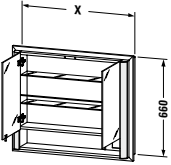
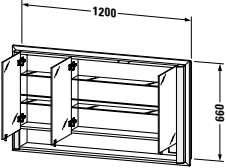
Light and mirrors

Description	mm	Model-No.	Euro
 <p>Mirror cabinet (built-in), Multibox Series IP 44, 2 mirror doors, 2 glass shelves, 1 rail, 2 T5 lighting 3500 kelvin light colour, 14 W, 1 socket inside right, 1 opened shelf incl. wooden floor, switch (touch LED) central below is coevally LED night light including light sensor, including 4-sided circular frame (aluminiumprofile)</p>			
	600 x 186	LM 9705	
	800 x 186	LM 9706	
	1000 x 186	LM 9707	
<p>Additional modules socket including flap (chromed plastic material) in the range of opened shelf (right side)</p>			
<p>Infobox: External dimensions incl. built-in frame: height = 715 mm, width: # 9705 = 655 mm, # 9706 = 855 mm, # 9707 = 1055 mm / built-in depth = 125 mm</p>			
 <p>Mirror cabinet (built-in), Multibox Series IP 44, 3 mirror doors, 4 glass shelves, 1 rail, 2 T5 lighting 3500 kelvin light colour, 14 W, 1 socket inside right, 1 opened shelf incl. wooden floor, switch (touch LED) central below is coevally LED night light including light sensor including 4-sided circular frame (aluminiumprofile)</p>			
	1200 x 186	LM 9708	
<p>Additional modules socket including flap (chromed plastic material) in the range of opened shelf (right side)</p>			
<p>Infobox: External dimensions incl. built-in frame: height = 715 mm, width = 1255 mm / Built-in depth = 125 mm</p>			
 <p>Box drawer 1 box drawer large height: 90 mm</p>			
	160 x 120	LM 9913	

Light and mirrors

Description	mm	Model-No.	Euro		
					
Box drawer					
1 box drawer small					
height: 90 mm	80 x 120	LM 9914			

Electrical requests in rooms with bathtub or shower

1. Explanation IP-Code (= Internal Protection)

IP XX

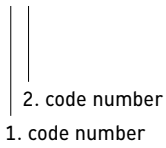

1. code number:

Protection of utilities against penetration of solid foreign bodies
 Protection of people against access to dangerous parts

2. code number:

Protection of utilities against penetration of water with harmful effects = relevant code number for rooms with bathtub and shower

1. code number			2. code number	
degree of protection	Protection of utilities against penetration of solid foreign bodies	Protection of people against access to dangerous parts	degree of protection	Protection of utilities against penetration of water with harmful effects
IP 0X	not protected	not protected	IP X0	not protected
IP 1X	≥ 50 mm Ø	back of the hand	IP X1	protection of dripping water (vertical)
IP 2X	≥ 12,5 mm Ø	finger	IP X2	protection of dripping water (inclination up to 15° degree)
IP 3X	≥ 2,5 mm Ø	tool	IP X3	protection of sprinkling water
IP 4X	≥ 1,0 mm Ø	wire	IP X4	protection of spurting water
IP 5X	dust-proof	wire	IP X5	protection of jet of water
IP 6X	dust-tight	wire	IP X6	strong protection of jet of water
X	not indicated	not indicated	IP X7	protection at temporary submerge into water
			IP X8	protection at constant submerge into water
			X	not indicated

Electrical requests in rooms with bathtub or shower - SensoWash®

Note: Following scheme complies with the standard EN 60598-1:2008 + A11:2009

The electrical installation has to be carried out in accordance with the country-specific standards for low voltage installations, the local electric power company as well as the country-specific standards.

2. IP area classification

Situation referring to rooms with bathtub

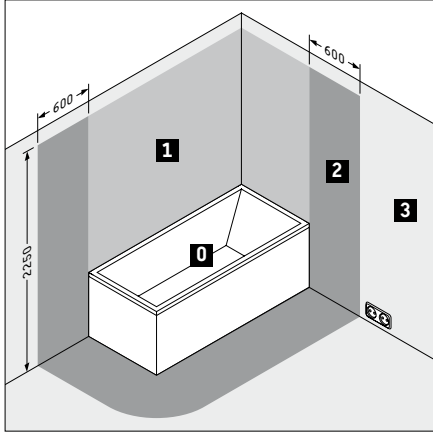

Situation referring to rooms with shower tray

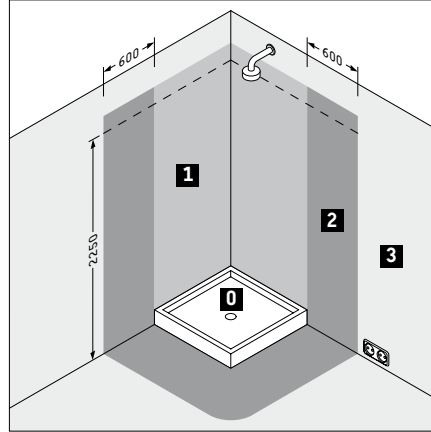

Situation referring to showers without tub or installation of flush fitting shower trays

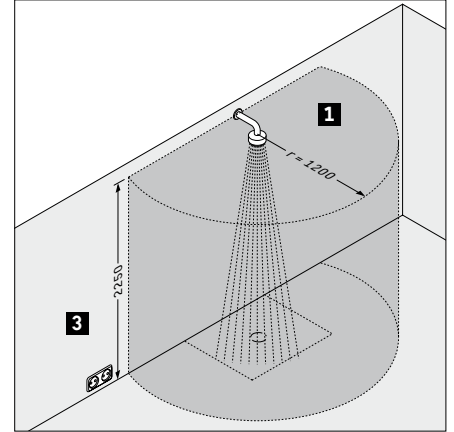

Area classification in rooms with bathtub or shower			protection class	Installation of SensoWash®
0	area 0	inside the bathtub or shower tray	IP X7	not allowed
1	area 1	- above bathtub or shower tray, height = 2250 mm above finished floor level* - Showers without shower tray: Distance of 1200 mm from the centre point of the fixed emersion point of water at the wall or the ceiling, height = 2250 mm above finished floor level*	IP X4	inadvisable
2	area 2	area 600 mm from the tub border, Height= 2250 mm above finished floor level*	IP X4	SensoWash® permissible due to its minimum protection class of IP X4. Earthed power socket not permitted.
3	area 3	remaining room	IP X0	SensoWash® permitted, earthed power socket permitted.

3. Protection class of Duravit products

Series	SensoWash®
D-Code	IP X4
DuraStyle	IP X4
Happy D.2	IP X4
Starck	IP X4

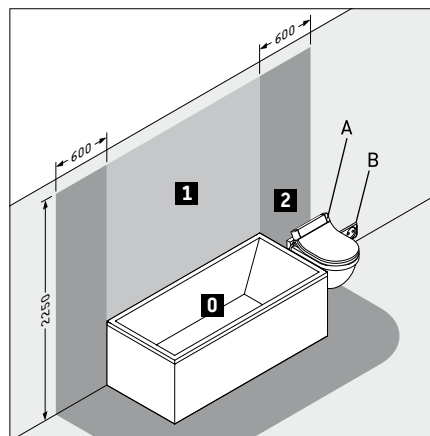

- A SensoWash (IP X4) may extend into area 2
B A socket must be installed outside the areas

* or height of highest fixed shower head/ water outlet, depending which is higher

Electrical requests in rooms with bathtub or shower - Furniture with electrification/lamps

Note: Following scheme complies with the standard EN 60598-1:2008 + A11:2009

The electrical installation has to be carried out in accordance with the country-specific standards for low voltage installations, the local electric power company as well as the country-specific standards.

2. IP area classification

Situation referring to rooms with bathtub

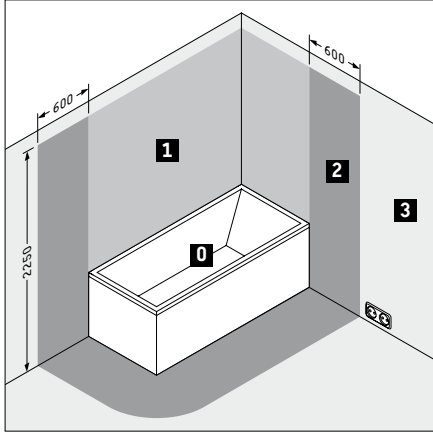

Situation referring to rooms with shower tray

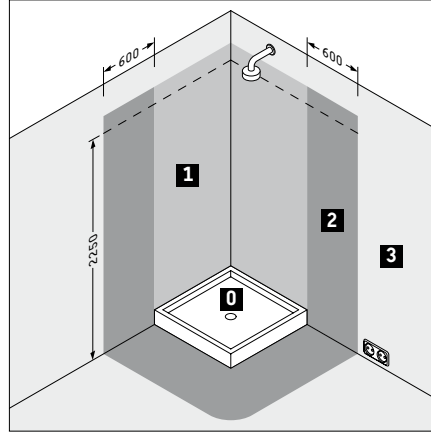

Situation referring to showers without tub or installation of flush fitting shower trays

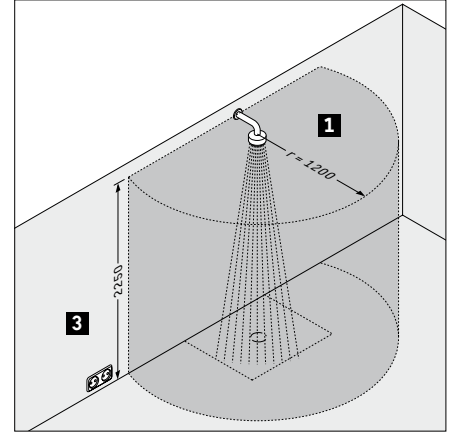

Area classification in rooms with bathtub or shower			protection class	Installation of mirrors with lighting and mirror cabinets
0	area 0	inside the bathtub or shower tray	IP X7	not allowed
1	area 1	- above bathtub or shower tray, height = 2250 mm above finished floor level* - Showers without shower tray: Distance of 1200 mm from the centre point of the fixed emersion point of water at the wall or the ceiling, height = 2250 mm above finished floor level*	IP X4	Mirror with lighting and mirror cabinets need IP X4, switches within the mirror are allowed, sockets are not allowed. A IP X4 mirror cabinet with integrated socket have to be installed in the kind that the socket does not extend into area 1 or area 2.
2	area 2	area 600 mm from the tub border, Height= 2250 mm above finished floor level*	IP X4	
3	area 3	remaining room	IP X0	Mirrors with lighting and mirror cabinets with IP X0 are allowed. Socket and switch inside the mirror cabinet are allowed.

3. Protection class of Duravit products

Serie	mirrors	mirror cabinets
2nd floor	IP 44	IP 44
Darling New	IP 44	IP 44
Delos	IP 44	IP 44
DuraStyle	IP 44	-
Esplanade	IP 44	-
Fogo	IP 44	IP 44
Happy D.2	IP 44	IP 44
Ketho	IP 44	IP 44
Light and mirrors	IP 44	IP 44
PuraVida	IP 44	IP 44
Starck	IP 44	IP 44
X-Large	IP 44	IP 44

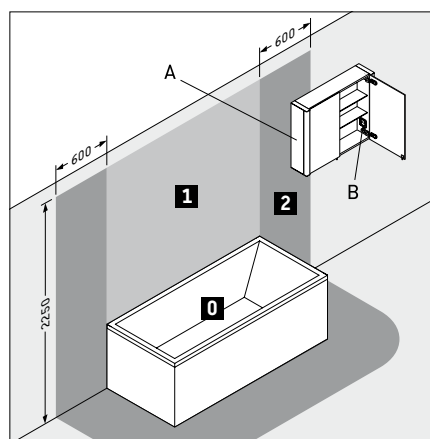

- A Mirror cabinet with IP 44 may extend into area 2
B A socket within the mirror cabinet must be installed outside the areas

* or height of highest fixed shower head/ water outlet, depending which is higher

Built-in recommendation for flush mounted sinks in countertops

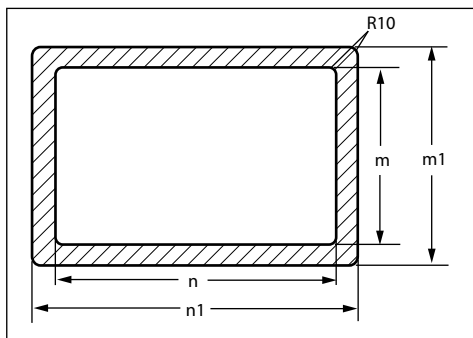
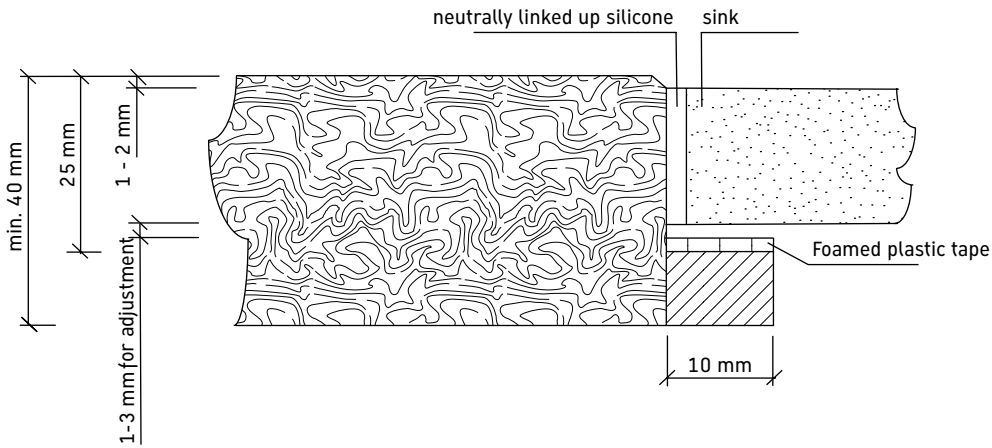

Cutout dimensions Kiora

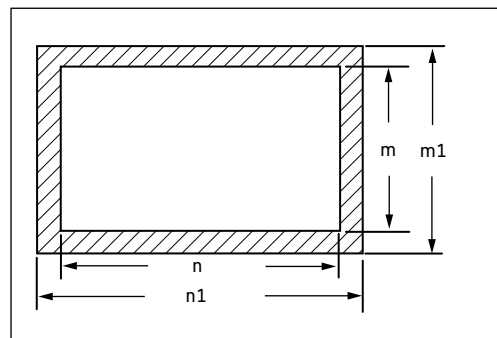

Cutout dimensions Starck K

Series	Ceramics	Dimension m (mm)	Dimension m1 (mm)	Dimension n (mm)	Dimension n1 (mm)
Kiora Z	# 752210	464	484	954	974
Kiora 60 XL L	# 752110	464	484	954	974
Kiora 60 XL R	# 752010	464	484	954	974
Kiora 60 L	# 751910	464	484	954	974
Kiora 60 R	# 751810	464	484	954	974
Kiora 50 L	# 751790	464	484	854	874
Kiora 50 R	# 751690	464	484	854	874
Starck K 90	# 751290	464	484	854	874
Starck K 60 L	# 751110	464	484	954	974
Starck K 60 R	# 751010	464	484	954	974
Starck K 50 L	# 751190	464	484	854	874
Starck K 50 R	# 751090	464	484	854	874

Order Sheet for Drilling Tap Holes

Customer	Customer order no.	Article no.
Order no.	Date	

To ensure correct customised drilling of the tap holes, we would ask you to carry out the following steps. Each step must be fully completed before proceeding with the next step. Please note that bathtubs with holes drilled in the rim cannot be returned. Taps are not possible for whirltubs.

1st step: Please indicate the required bathtub.

- | | | | | | | |
|------------------|-----------------------------------|-----------------------------------|--------------|-----------------------------------|-------------------|-----------------------------------|
| Esplanade | <input type="checkbox"/> # 700283 | <input type="checkbox"/> # 700281 | Nahho | <input type="checkbox"/> # 700280 | DuraStyle* | <input type="checkbox"/> # 700231 |
| | <input type="checkbox"/> # 700290 | <input type="checkbox"/> # 700288 | | | | <input type="checkbox"/> # 700233 |
| | | <input type="checkbox"/> # 700282 | | | | |
| | | <input type="checkbox"/> # 700289 | | | | |

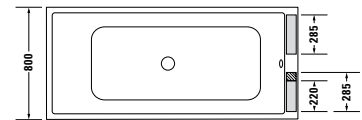
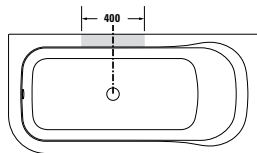
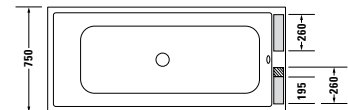
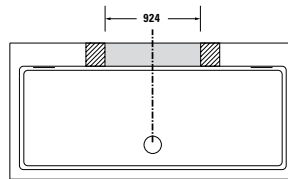
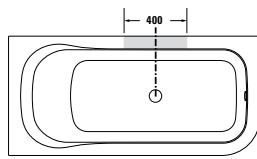
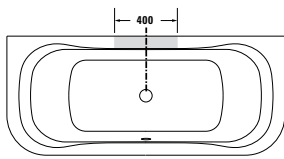

- Paiova**
- # 700270
- # 700271

- Vero**
- # 700135
- # 700136

- Vero**
- # 700131
- # 700133
- # 700132
- # 700134

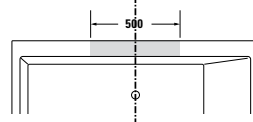
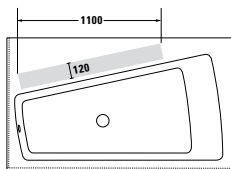
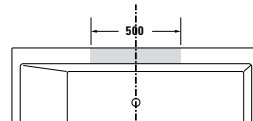
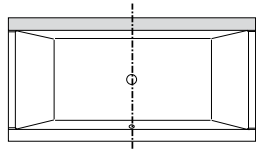
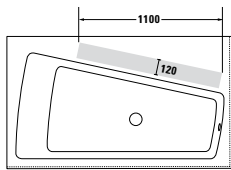

Tap holes can be drilled in the grey area.

Drilling of tap holes in shaded areas only possible:

Nahho: If OpenSpace shower screen isn't used.
DuraStyle: If waste and overflow without water inlet is used.

2nd step: Please indicate the required position of the holes to be drilled in the rim.

If the tap holes are to be drilled on the left / right, please specify the distance from the edge of the bathtub to the centre of the first drill hole:

a = _____ mm

centre

left

right

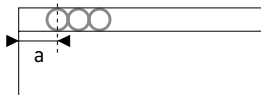
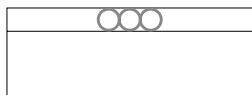

DuraStyle

left

right

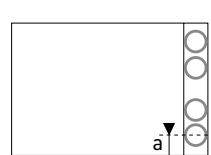
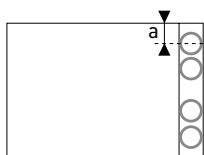

a = min. 80 mm

a = min. 80 mm

* Taps are not suitable for bathtubs with conical furniture panel or conical support

Order Sheet for Drilling Tap Holes

Paiova

centre

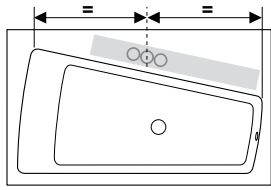

left

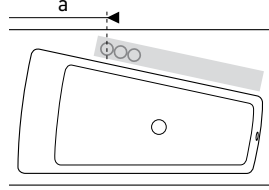

right

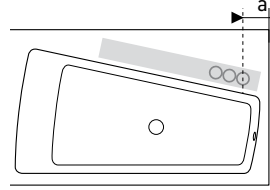

a = min. 500 mm

a = min. 125 mm

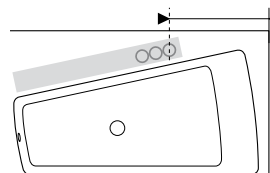
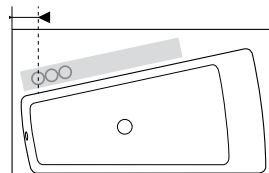
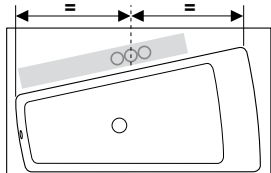

a = min. 125 mm

a = min. 500 mm

3rd step: If the drill holes are to be centred on the rim of the bathtub, please indicate the central axis of the bathtub in relation to the drill holes.

centred between the drill holes

through the centre of a drill hole

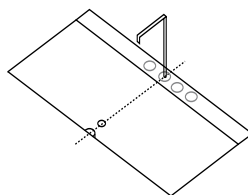
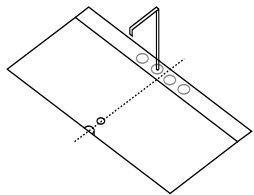

4th step: Specify the dimensions for drilling the holes. Please enter the distance between them and the diameter for each hole directly in the drawing.

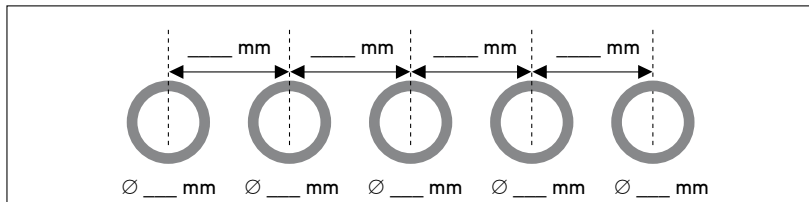

DuraStyle

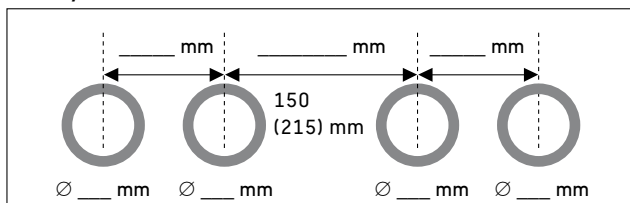

For DuraStyle please consider the minimum distance between the drillings in the centre. The minimum distance is 150 mm if a waste and overflow without water inlet is used and 215 mm if a waste and overflow with water inlet is used.

Paiova

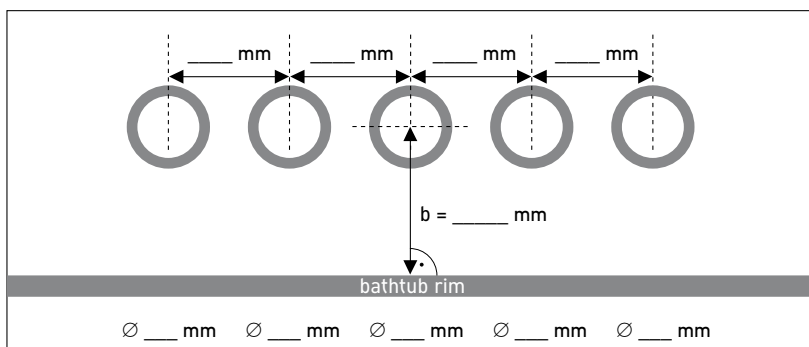

For Paiova please specify the distance from the inner bathtub rim to the centre of the drill hole.

b = min. 30 mm
b = max. 150 mm

Overview of recommended ceramic series

Duravit-Furniture ranges vanity units for above counter basins and furniture washbasins	Duravit-Ceramic ranges																										
	Furniture washbasins										Above counter basins						Vanity basins										
	2nd floor	D-Code	Darling New	DuraStyle	Esplanade	Happy D.2	PuraVida	Starck 1	Starck 2	Starck 3	Vero	2nd floor	Bacino	Bagnella	DuraStyle	Happy D.2	Starck 1	Starck 2	Vero	2nd floor	Architec	DuraStyle	Happy D.2	Santosa	Starck 3	Vero	
2nd floor	■										■																
Darling New			■																								
Delos		■	■							■		■	■	■	■	■	■	■	■								
DuraStyle		■		■					■			■	■	■		■	■	■	■		■	■	■	■	■	■	■
Esplanade					■																						
Fogo										■				■													
Happy D.2						■						■	■	■	■	■	■	■	■								
Ketho		■							■	■	■	■	■	■	■	■	■	■	■	■	■	■	■	■	■	■	■
PuraVida							■																				
Starck								■	■							■	■										
X-Large	■	■								■	■	■	■	■	■	■	■	■	■	■							

Duravit-Furniture ranges consoles for above counter basins, Vanity basins, Semi-recessed washbasins	Duravit-Ceramic ranges																										
	Above counter basins (ground)										Vanity basins						Semi-recessed washbasins										
	2nd floor	Architec	Bacino	Bagnella	Darling New	DuraStyle	Foster	Happy D.2	PuraVida	Starck 1	Vero	2nd floor	Architec	Happy D.2	Santosa	Starck 2	Starck 3	Vero	D-Code	Starck 3	Vero						
2nd floor	■	■	■	■	■	■	■	■	■	■	■	■	■	■	■	■	■	■									
Darling New	■	■	■	■	■	■	■	■	■	■							■										
Delos	■	■	■	■	■	■	■	■	■	■	■	■	■	■	■	■	■	■									
Fogo	■	■	■	■	■	■	■	■	■	■	■	■	■	■	■	■	■	■									
Fogo (depth 360 mm)			■			■			■										■	■	■						
Happy D.2	■	■	■	■	■	■	■	■	■	■	■	■	■	■	■	■	■	■									
Happy D.2 (depth 480 mm)	■	■	■	■	■		■			■																	
PuraVida								■																			
X-Large	■	■	■	■	■	■	■		■	■	■	■	■	■	■	■	■	■									
X-Large (depth 480 mm)	■	■	■	■	■		■			■																	

Ordering information for Delos consoles with drawers

Duravit-Ceramic ranges Above counter basin		Consoles incl. Delos suspended drawers (incl. cut-out)					
Series	Ceramics	# DL 6787 (M)	# DL 6788 (M)	# DL 6789 (M)	# DL 6790 (M)	# DL 6791 (L/R)	# DL 6792 (L/R)
2nd floor (built-in)	# 031758	■	■	■	■	■	■
2nd floor (countertop)	# 031758	■	■	■	■	■	■
Architec**	# 032040	■	■	■	■	■	■
Architec**	# 032042	■	■	■	■	■	■
Architec	# 032045	■	■	■	■	■	■
Bacino*	# 032542	■	■	■	■	■	■
Bacino*	# 033342	■	■	■	■	■	■
Bacino	# 033452	■	■	■	■	■	■
Bagnella	# 045140	■	■	■	■	■	■
Bagnella	# 045148	■	■	■	■	■	■
DuraStyle	# 034943	■	■	■	■	■	■
DuraStyle	# 034960	■	■	■	■	■	■
Foster	# 033550	■	■	■	■	■	■
Happy D.2	# 231440	■	■	■	■	■	■
Happy D.2	# 231460		■	■	■	■	■
PuraVida	# 037070		■	■	■	■	■
Starck 1	# 232246	■	■	■	■	■	■
Starck 1	# 040853	■	■	■	■	■	■
Starck 1	# 040833	■	■	■	■	■	■
Starck 1	# 044753	■	■	■	■	■	■
Starck 1	# 044648	■	■	■	■	■	■
Starck 1	# 044546	■	■	■	■	■	■
Starck 2	# 232144	■	■	■	■	■	■
Vero	# 045250	■	■	■	■	■	■
Vero	# 045260		■	■	■	■	■
Vero	# 045360		■	■	■	■	■
Vero	# 045410				■		
Vero	# 045450	■	■	■	■	■	■
Vero	# 045460		■	■	■	■	■
Vero	# 045470		■	■	■		■
Vero	# 045480			■	■		■
Vero	# 045550	■	■	■	■	■	■
Vero	# 045560		■	■	■	■	■
Vero	# 070445	■	■	■	■	■	■

InfoBox: * Only possible in conjunction with wall-mounted tap / ** Only possible in conjunction with push-open valve

Ordering information for Delos consoles with drawers

Duravit-Ceramic ranges Vanity basin		Consoles incl. Delos suspended drawers (incl. cut-out)					
Series	Ceramics	# DL 6891 (L/R)	# DL 6892 (L/R)				
2nd floor	# 031758	■	■				
2nd floor	# 034760	■	■				
D-Code	# 033754	■	■				
DuraStyle	# 037243	■	■				
Happy D.2	# 231560	■	■				
Starck 3	# 030256	■	■				
Vero	# 031555	■	■				

Duravit-Ceramic ranges Undercounter basin bonded		Consoles incl. Delos suspended drawers (incl. cut-out)					
Series	Ceramics	# DL 6991 (L/R)	# DL 6992 (L/R)				
Architec	# 046840 (22)	■	■				
DuraStyle	# 037337 (22)	■	■				
Santosa	# 046651 (22)	■	■				
Starck 3	# 030549 (22)	■	■				
Vero	# 033048 (22)	■	■				

Ordering information for Fogo consoles with drawers, X-Large Vanity unit

Duravit-Ceramic ranges		Consoles incl. Fogo suspended drawers (incl. cut-out), X-Large															
Series	Ceramics	# FO 8520 (M)	# FO 8521 (M)	# FO 8522 (M)	# FO 8523 (M)	# FO 8524 (L)	# FO 8525 (R)	# FO 8526 (B)	# FO 8527 (M)	# FO 8528 (L)	# FO 8529 (R)	# FO 8530 (B)	# FO 8531 (M)	# FO 8532 (L)	# FO 8533 (R)	# FO 8534 (B)	# XL 6718
2nd floor (built-in)	# 031758		■	■	■				■	■	■	■	■	■	■	■	
2nd floor (countertop)	# 031758		■	■	■				■	■	■	■	■	■	■	■	
Architec**	# 032040	■	■	■	■	■	■	■	■	■	■	■	■	■	■	■	
Architec**	# 032042	■	■	■	■	■	■	■	■	■	■	■	■	■	■	■	
Architec	# 032045	■	■	■	■	■	■	■	■	■	■	■	■	■	■	■	■
Bacino*	# 032542	■	■	■	■	■	■	■	■	■	■	■	■	■	■	■	
Bacino*	# 033342	■	■	■	■	■	■	■	■	■	■	■	■	■	■	■	■
Bacino	# 033452	■	■	■	■	■	■	■	■	■	■	■	■	■	■	■	
Bagnella	# 045140	■	■	■	■	■	■	■	■	■	■	■	■	■	■	■	■
Bagnella	# 045148	■	■	■	■	■	■	■	■	■	■	■	■	■	■	■	■
DuraStyle	# 034943	■	■	■	■	■	■	■	■	■	■	■	■	■	■	■	
DuraStyle	# 034960		■	■	■				■	■	■	■	■	■	■	■	■
DuraStyle	# 037243	■	■	■	■				■	■	■	■	■	■	■	■	
Foster	# 033550	■	■	■	■	■	■	■	■	■	■	■	■	■	■	■	
Happy D.2	# 231440	■	■	■	■	■	■	■	■	■	■	■	■	■	■	■	
Happy D.2	# 231460		■	■	■				■	■	■	■	■	■	■	■	
Starck 1	# 040853	■	■	■	■	■	■	■	■	■	■	■	■	■	■	■	■
Starck 1	# 040833	■	■	■	■	■	■	■	■	■	■	■	■	■	■	■	
Starck 1	# 044753	■	■	■	■	■	■	■	■	■	■	■	■	■	■	■	■
Starck 1	# 044648	■	■	■	■	■	■	■	■	■	■	■	■	■	■	■	■
Starck 1	# 044546	■	■	■	■	■	■	■	■	■	■	■	■	■	■	■	■
Vero	# 045250	■	■	■	■	■	■	■	■	■	■	■	■	■	■	■	■
Vero	# 045260		■	■	■				■	■	■	■	■	■	■	■	■
Vero	# 045360		■	■	■				■	■	■	■	■	■	■	■	
Vero	# 045412								■			■	■	■			
Vero	# 045450	■	■	■	■	■	■	■	■	■	■	■	■	■	■	■	■
Vero	# 045460		■	■	■				■	■	■	■	■	■	■	■	■
Vero	# 045470			■	■				■	■	■		■	■	■	■	■
Vero	# 045480			■	■				■	■	■		■	■	■	■	■
Vero	# 045550	■	■	■	■	■	■	■	■	■	■	■	■	■	■	■	■
Vero	# 045560		■	■	■				■	■	■	■	■	■	■	■	■
Vero	# 045410				■				■			■	■	■			
Vero	# 070445	■	■	■	■	■	■	■	■	■	■	■	■	■	■	■	

Infobox: * Only possible in conjunction with wall-mounted tap / ** Only possible in conjunction with push-open valve

Ordering information for Fogo consoles reduced depth with drawers

Duravit-Ceramic ranges		Consoles incl. Fogo suspended drawers (incl. cut-out)														
Series	Ceramics	# FO 8370 (L)	# FO 8371 (R)	# FO 8372 (L)	# FO 8373 (R)	# FO 8374 (L)	# FO 8375 (R)	# FO 8377 (L)	# FO 8378 (R)	# FO 8380 (L)	# FO 8381 (R)	# FO 8382 (M)	# FO 8383 (L)	# FO 8384 (R)	# FO 8385 (M)	# FO 8388 (M)
Bacino	# 032542	■	■	■	■	■	■	■	■	■	■	■	■	■	■	■
Bacino*	# 033342	■	■	■	■	■	■	■	■	■	■	■	■	■	■	■
Bacino*	# 033452	■	■	■	■	■	■	■	■	■	■	■	■	■	■	■
Bagnella	# 045140	■	■	■	■	■	■	■	■	■	■	■	■	■	■	■
Foster	# 033550	■	■	■	■	■	■	■	■	■	■	■	■	■	■	■
Starck 1	# 040833	■	■	■	■	■	■	■	■	■	■	■	■	■	■	■
Starck 3	# 031055							■	■	■	■	■	■	■	■	■
Vero	# 031455							■	■	■	■	■	■	■	■	■
Vero	# 070445	■	■	■	■	■	■	■	■	■	■	■	■	■	■	■

Infobox: * Only possible in conjunction with wall-mounted tap / version without tap hole always possible. Tap hole left side only possible for # FO 8371, FO 8373, FO 8375, FO 8378, FO 8381, FO 8382, FO 8384, FO 8385, FO 8388. Tap hole right side only possible for # FO 8370, FO 8372, FO 8374, FO 8377, FO 8380, FO 8382, FO 8383, FO 8385, FO 8388

**Ordering information for DuraStyle vanity units, wall-mounted
(Above counter basin / Undercounter basin bonded)**

Duravit-Ceramic ranges Above counter basin		Vanity unit, wall-mounted			
Series	Ceramics	# DS 6784 (L)	# DS 6784 (R)	# DS 6785 (L)	# DS 6785 (R)
Bacino	# 032542	■	■	■	■
Bacino	# 033342	■	■	■	■
Bacino	# 033452	■	■	■	■
Bagnella	# 045140	■	■	■	■
Bagnella	# 045148	■	■	■	■
DuraStyle	# 034943	■	■	■	■
DuraStyle	# 034960	■	■	■	■
DuraStyle	# 037243	■	■	■	■
Foster	# 033550	■	■	■	■
Starck 1	# 040853	■	■	■	■
Starck 1	# 044753	■	■	■	■
Starck 1	# 044648	■	■	■	■
Starck 1	# 040833	■	■	■	■

Duravit-Ceramic ranges Undercounter basin bonded		Vanity unit incl. DuraStyle suspended drawers (incl. cut-out)			
Series	Ceramics	# DS 6883	# DS 6884	# DS 6885 (L/R)	# DS 6885 (B)
Architec	# 046840 (22)	■	■	■	
DuraStyle	# 037337 (22)	■	■	■	■
Santosa	# 046651 (22)	■	■	■	
Starck 3	# 030549 (22)	■	■	■	
Vero	# 033048 (22)	■	■	■	

Ordering information for Ketho vanity units, wall-mounted (Above counter basin)

Duravit-Ceramic ranges Above counter basin		Vanity unit, wall-mounted											
Series	Ceramics	# KT 6654 (M)	# KT 6655 (M)	# KT 6656 (M)	# KT 6657 (L)	# KT 6657 (R)	# KT 6657 (B)	# KT 6694 (M)	# KT 6695 (M)	# KT 6696 (M)	# KT 6697 (L)	# KT 6697 (R)	# KT 6697 (B)
2nd floor	# 031758	■	■	■	■	■	■	■	■	■	■	■	■
Architec	# 032045	■	■	■	■	■	■	■	■	■	■	■	■
Architec	# 032042	■	■	■	■	■	■	■	■	■	■	■	■
Architec	# 032040	■	■	■	■	■	■	■	■	■	■	■	■
Bacino	# 032542	■	■	■	■	■	■	■	■	■	■	■	■
Bacino	# 033342	■	■	■	■	■	■	■	■	■	■	■	■
Bacino	# 033452	■	■	■	■	■	■	■	■	■	■	■	■
Bagnella	# 045140	■	■	■	■	■	■	■	■	■	■	■	■
Bagnella	# 045148	■	■	■	■	■	■	■	■	■	■	■	■
DuraStyle	# 034943	■	■	■	■	■	■	■	■	■	■	■	■
DuraStyle	# 034960	■	■	■	■	■	■	■	■	■	■	■	■
DuraStyle	# 037243	■	■	■	■	■	■	■	■	■	■	■	■
Foster	# 033550	■	■	■	■	■	■	■	■	■	■	■	■
Happy D.2	# 231440	■	■	■	■	■	■	■	■	■	■	■	■
Happy D.2	# 231460	■	■	■	■	■	■	■	■	■	■	■	■
PuraVida	# 037070	■	■	■				■	■	■			
Starck 1	# 232246	■	■	■	■	■	■	■	■	■	■	■	■
Starck 1	# 040853	■	■	■	■	■	■	■	■	■	■	■	■
Starck 1	# 044753	■	■	■	■	■	■	■	■	■	■	■	■
Starck 1	# 044648	■	■	■	■	■	■	■	■	■	■	■	■
Starck 1	# 044546	■	■	■	■	■	■	■	■	■	■	■	■
Starck 1	# 040833	■	■	■	■	■	■	■	■	■	■	■	■
Starck 2	# 232144	■	■	■	■	■	■	■	■	■	■	■	■
Vero	# 045360	■	■	■	■	■	■	■	■	■	■	■	■
Vero	# 045450	■	■	■	■	■	■	■	■	■	■	■	■
Vero	# 045460	■	■	■	■	■	■	■	■	■	■	■	■
Vero	# 045470		■	■				■	■				
Vero	# 045480		■	■				■	■				
Vero	# 045410			■					■				
Vero	# 045560	■	■	■	■	■	■	■	■	■	■	■	■
Vero	# 045550	■	■	■	■	■	■	■	■	■	■	■	■
Vero	# 070445	■	■	■	■	■	■	■	■	■	■	■	■
Vero	# 045250	■	■	■	■	■	■	■	■	■	■	■	■
Vero	# 045260	■	■	■	■	■	■	■	■	■	■	■	■

Ordering information for Ketho vanity units, wall-mounted (Vanity basin)

Duravit-Ceramic ranges Vanity basin		Vanity unit, wall-mounted											
Series	Ceramics	# KT 6754 (M)	# KT 6755 (M)	# KT 6756 (M)	# KT 6757 (L)	# KT 6757 (R)	# KT 6757 (B)	# KT 6794 (M)	# KT 6795 (M)	# KT 6796 (M)	# KT 6797 (L)	# KT 6797 (R)	# KT 6797 (B)
2nd floor	# 031758	■	■	■	■	■	■	■	■	■	■	■	■
2nd floor	# 034760	■	■	■	■	■	■	■	■	■	■	■	■
D-Code	# 033754	■	■	■	■	■	■	■	■	■	■	■	■
DuraStyle	# 037243	■	■	■	■	■	■	■	■	■	■	■	■
Happy D.2	# 231560	■	■	■	■	■	■	■	■	■	■	■	■
Starck 3	# 030256	■	■	■	■	■	■	■	■	■	■	■	■
Vero	# 031555	■	■	■	■	■	■	■	■	■	■	■	■

Duravit-Ceramic ranges undercounter basin		vanity unit with countertop											
Series	Ceramics	# KT 6854 (M)	# KT 6855 (M)	# KT 6856 (M)	# KT 6857 (L)	# KT 6857 (R)	# KT 6857 (B)	# KT 6894 (M)	# KT 6895 (M)	# KT 6896 (M)	# KT 6897 (L)	# KT 6897 (R)	# KT 6897 (B)
Architec	# 046840 (22)	■	■	■	■	■	■	■	■	■	■	■	■
DuraStyle	# 037337 (22)	■	■	■	■	■	■	■	■	■	■	■	■
Santosa	# 046651 (22)	■	■	■	■	■	■	■	■	■	■	■	■
Starck 3	# 030549 (22)	■	■	■	■	■	■	■	■	■	■	■	■
Vero	# 033048 (22)	■	■	■	■	■	■	■	■	■	■	■	■

Ordering information for Starck vanity units, wall-mounted (washbowl)

Duravit-Ceramic ranges Above counter basin		Vanity unit, wall-mounted						
Series	Ceramics	# S1 9526 (M)	# S1 9528 (L)	# S1 9528 (R)	# S1 9528 (M)	# S1 9529 (L)	# S1 9529 (R)	# S1 9529 (B)
Starck 1	# 038747 (27, 28)	■	■	■	■	■	■	■
Starck 1	# 038647 (27, 28)	■	■	■	■	■	■	■
Starck 1	# 040853	■	■	■	■	■	■	■
Starck 1	# 044546	■	■	■	■	■	■	■
Starck 1	# 044648	■	■	■	■	■	■	■
Starck 1	# 044753	■	■	■	■	■	■	■
Starck 1	# 232246	■	■	■	■	■	■	■
Starck 2	# 232360	■	■	■	■	■	■	■
Starck 2	# 232144	■	■	■	■	■	■	■

Order sheet for consoles (depth 550 mm) 2nd floor, Happy D.2, Delos, Fogo, X-Large (not bonded / bonded)

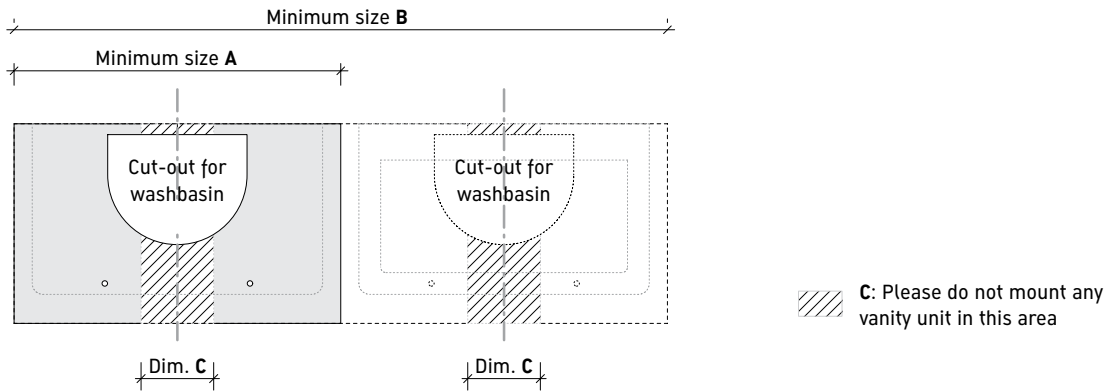

Series	Ceramic (not bonded)	Minimum size A (mm) Console with 1 cut-out	Minimum size B (mm) Console with 2 cut-outs	Dimension C (mm)	
2nd floor	# 031758 Built-in	800	1450	534	
2nd floor	# 031758 Countertop	700	1350	75	
2nd floor	# 049160	800	1500	560	
2nd floor	# 034760	800	1500	560	
2nd floor	# 049170	900	1700	660	
2nd floor	# 049180	1000	on request	760	
2nd floor	# 049112	1400	not available	1157	
Architec	# 032045	600	1150	400	
Architec	# 032042	600	1100	350	
Architec	# 032040	600	1100	350	
Bacino	# 032542	500	1000	160	
Bacino	# 033342	500	1000	160	
Bacino	# 033452	500	1300	160	
Bagnella	# 045140	500	1000	110	
Bagnella	# 045148	500	1100	110	
Darling New	# 049747	600	1150	160	
DuraStyle	# 034943	500	1100	180	
DuraStyle	# 034960	700	1400	180	
DuraStyle	# 037243	500	1100	180	
Foster	# 033550	500	1050	150	
Happy D.2	# 231440	500	1000	115	
Happy D.2	# 231460	700	1400	115	
Happy D.2	# 231560	800	1500	530	
Happy D.2	# 231865	800	1500	530	
Happy D.2	# 231880	900	1800	575	
Happy D.2	# 231810	1100	on request	575	
Happy D.2	# 231765	800	1500	500	
Starck 1	# 232246	500	1100	110	
Starck 1	# 040853	500	1100	160	
Starck 1	# 044753	500	1100	180	
Starck 1	# 044648	500	1100	180	
Starck 1	# 044546	500	1100	180	
Starck 2	# 232144	500	1100	110	
Vero	# 045250	600	1200	200	
Vero	# 031555 Built-in	800	1450	550	
Vero	# 045260	700	1400	200	

Order sheet for consoles (depth 550 mm) 2nd floor, Happy D.2, Delos, Fogo, X-Large (not bonded / bonded)

Series	Ceramic (not bonded)	Minimum size A (mm) Console with 1 cut-out	Minimum size B (mm) Console with 2 cut-outs	Dimension C (mm)	
Vero	# 045360	700	1400	200	
Vero	# 045450 (25,27,28)	600	1200	200	
Vero	# 045460 (25,27,28)	700	1400	200	
Vero	# 045470 (25,27,28)	800	1600	200	
Vero	# 045480 (25,27,28)	900	1800	200	
Vero	# 045410 (24,25,26,27,28)	1100	on request	560	
Vero	# 045412 (24,25,26,27,28)	1300	on request	560	
Vero	# 045550	600	1200	230	
Vero	# 045560	700	1400	230	

Series	Ceramic (bonded)	Minimum size A (mm) Console with 1 cut-out	Minimum size B (mm) Console with 2 cut-outs	Dimension C (mm)	
Architec	# 046840 (22)	700	1250	400	
DuraStyle	# 037337 (22)	700	1250	400	
Santosa	# 046651 (22)	800	1450	500	
Starck 3	# 030549 (22)	700	1350	500	
Vero	# 033048 (22)	700	1350	500	

Infobox: Important: If you would like to combine a non-Duravit washbasin with Duravit consoles, it is necessary to ask us in advance if this is possible. We shall need at least the design template of the washbasin model to determine this. Sometimes other details are also necessary. Please be aware of the time needed to coordinate both items as well as the extra cost for customisation within the scope of Duravit Individual.

Order sheet for consoles (depth 480 mm) Happy D.2, X-Large

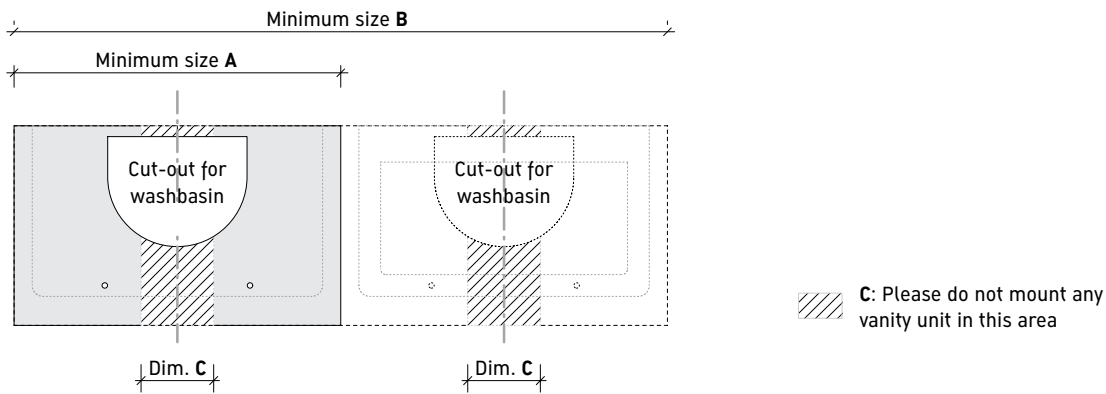

Series	Ceramic	Minimum size A (mm) Console with 1 cut-out	Minimum size B (mm) Console with 2 cut-outs	Dimension C (mm)	
2nd floor	# 031758 Countertop	700	1350	75	
Architec	# 032042	600	1100	350	
Architec	# 032040	600	1100	350	
Bacino	# 032542	500	1000	160	
Bacino	# 033342	500	1000	160	
Bacino	# 033452	500	1300	160	
Bagnella	# 045140	500	1000	110	
Darling New	# 049747	500	1100	160	
Foster	# 033550	500	1050	150	
Happy D.2	# 231440	500	1000	115	
Happy D.2	# 231460	700	1400	115	
Happy D.2	# 231765	800	1500	500	
Vero	# 031555 Built-in	800	1450	550	
Vero	# 045360	700	1400	200	
Vero	# 045450 (25,27,28)	600	1200	200	
Vero	# 045460 (25,27,28)	700	1400	200	
Vero	# 045470 (25,27,28)	800	1600	200	
Vero	# 045480 (25,27,28)	900	1800	200	

Order sheet for consoles (depth 480/550 mm) 2nd floor, Fogo, Happy D.2, X-Large

Client	Order-No.
Series	Date
Deadline	Colour
Washbasin #	

Infobox: Individual solutions with variable-width consoles and flexible arrangement of low cabinets, console supports on request (include sketch) / Maximum console width: 2000 mm. Widths up to 2700 mm on request / A stabilising console support is required for dual solutions or variable solutions over 1200 mm / We recommend a clearance of approx. 600 mm with console basins and undercounter washbasins with no base vanity unit / We can drill tap holes on request. Please specify the exact coordinates (axial dimension + diameter)! / If multiple vanity units are installed in a row, a 5 mm-wide spacer is preinstalled for structural reasons.

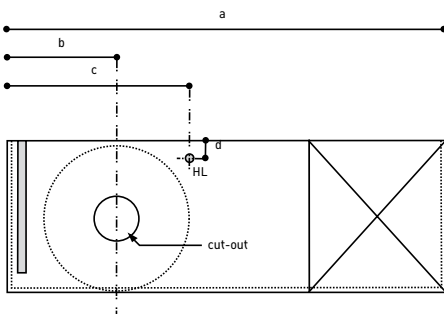

In order to ensure that the variable consoles we manufacture are a perfect fit, we need the following information/dimensions:

- a ↔ ____ mm overall console length
- b ↔ ____ mm axial dimension from left-hand outside edge of console to centre of washbasin cut-out.
- c ↔ ____ mm if a tap hole is to be drilled, please give the axial dimension from the left-hand outside edge of the console to the centre of the tap hole.
- d ↔ ____ mm for drilling please also give the axial dimension from the rear edge of the console to the centre of the tap hole.

Infobox: X-Large und Happy D.2 console free-standing:
3 console supports for consoles with a length of 1000 - 1399 mm,
4 console supports for consoles with a length of 1400 - 2000 mm.

socket for 2nd floor, Fogo		
unit/washba- sin base unit		2000
Console support - towel rail # 9903* / 9917		
Console support - bracket # 9902*		1500
Console support - T-shaped # 9926*		
HL = Tap hole drilling D = 35 mm (size specifi- cation optional)		1000

Please ensure that all of the required information is entered on the order form. The printed scale grid will make it easier to draw a plan of the console surface.

* please add respective identification code for series

Order sheet for consoles Delos

Client	Order-No.
Date	Deadline
Colour	Washbasin #

Infobox: Individual solutions with variable-width consoles and flexible arrangement of low cabinets, console supports on request (include sketch) / Maximum console width: 2000 mm. Widths up to 2700 mm on request / A stabilising console support is required for dual solutions or variable solutions over 1200 mm / We recommend a clearance of approx. 600 mm with console basins and undercounter washbasins with no base vanity unit / We can drill tap holes on request. Please specify the exact coordinates (axial dimension + diameter)!

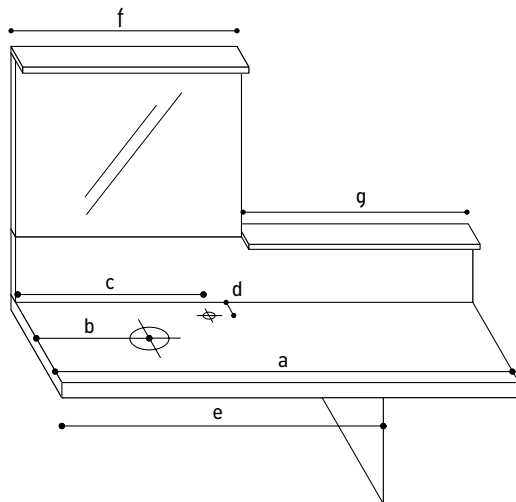

In order to ensure that the variable consoles we manufacture are a perfect fit, we need the following information/dimensions:

- a ↔ ____ mm overall console length
- b ↔ ____ mm axial dimension from left-hand outside edge of console incl. back-panel to centre of washbasin cut-out.
- c ↔ ____ mm if a tap hole is to be drilled, please give the axial dimension from the left-hand outside edge of the console to the centre of the tap hole.
- d ↔ ____ mm for drilling please also give the axial dimension from the rear edge of the console to the centre of the tap hole.
- e ↔ ____ mm position of low cabinet from left outside edge of console
- f ↔ ____ mm mirror size
- g ↔ ____ mm size of glass shelf

Infobox: Console with back panel always includes concealed console supports. Recommendation for positioning: 100 mm from outside edge. 2 console supports for a length up to 1200 mm, 4 console supports for a length up to 1400 mm, 5 console supports for a length up to 1800 mm

unit/washbasin base unit



2000

Console support – towel rail # DL 9903



Console support – bracket # DL 9902



1500

Console support – T-shaped # DL 9926



1000

HL = Tap hole drilling D = 35 mm (size specification optional)



Please ensure that all of the required information is entered on the order form. The printed scale grid will make it easier to draw a plan of the console surface.

500

200

100

0
Depth = 565

Order information for consoles DuraStyle

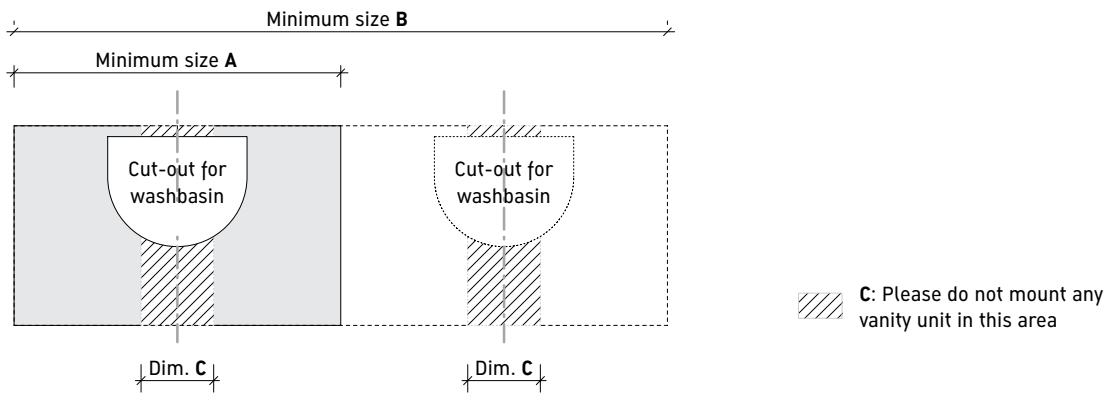

Series	Ceramics	Minimum size A (mm) Console with 1 cut-out	Minimum size B (mm) Console with 2 cut-outs	Dimension C (mm)	
DuraStyle	# 263152 (30)	800	1480	670	
DuraStyle	# 263052 (30)	800	1390	670	
DuraStyle	# 262943 (28)	800	1200	420	

Order information for consoles DuraStyle

Rule 1: The maximum edgewise overlap, respectively the maximum length of a DuraStyle furniture washbasin without additional console support is 440 mm, respectively 1400 mm. The DuraStyle washbasin carries the weight of the console. The minimum length of the console is 800 mm, the maximum length is 2000 mm. For this case you need to order additional console supports (# DS 9933).

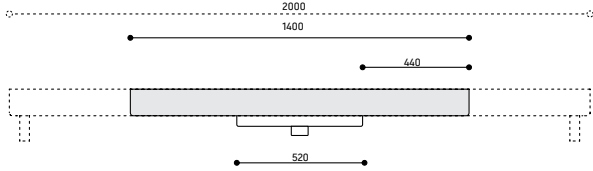

Rule 4: Minimum edgewise overlap (of one side) and minimum length of console if using a towel rail cutout on the splay, whereat the console is supported by a console support = 520/ 1480 mm. The towel rail cutout is always located next to a washbasin and is variable in its positioning (dimension between axes in order support sheet is necessary).

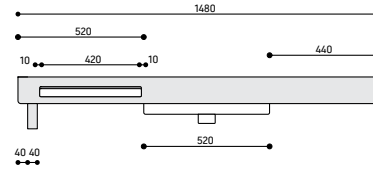

Rule 2: If using 2 DuraStyle furniture washbasins the maximum length of the console is 2000 mm, if using no additional console support.

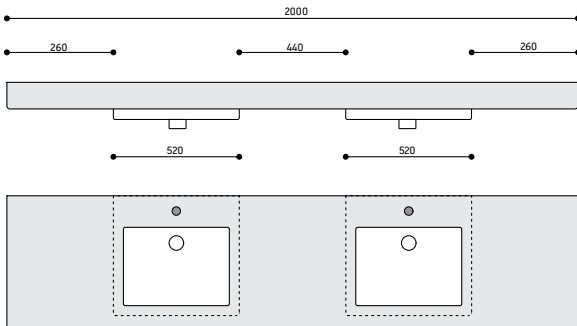

Rule 3: Towel rail cutout on top of the console surface is only possible if the console is not attached to the wall area. In connection with a console support a minimum gap of 40 mm is to maintain.

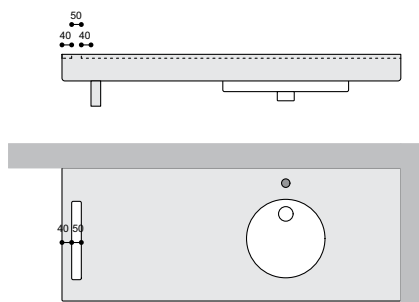

Order sheet for consoles DuraStyle

Client _____ Order-No. _____

Series _____ Date _____

Deadline _____ Surface _____

floor cabinet / shelf with drawer: # _____

Infobox: Individual solutions considering the ordering information/ rules for DuraStyle consoles with various width of the consoles and various positioning of the floor cabinets, console supports. Please attach drawing / maximum width of console 2000 mm / Custom tap hole drillings for highriser are available. Please specify exact coordinates and diameter.

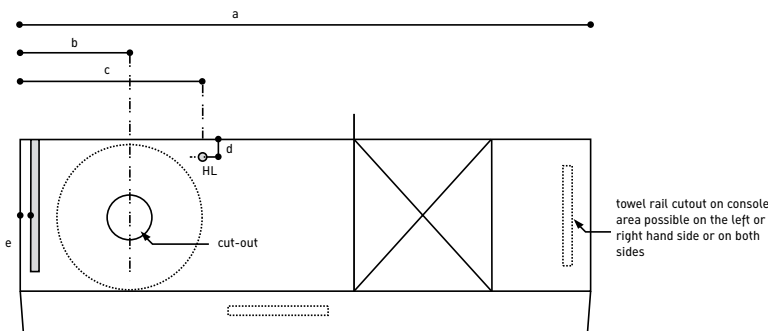

For being able to produce the variable consoles accurately fitting, we need to know following details:

- a ↔ _____ mm total length of the console
- b ↔ _____ mm dimension between axes from left outer edge of the console to the centre of the handrinse basin cut-out.
- c ↔ _____ mm For tap hole drilling: dimension between axes from left outer edge of the console to the centre of the drilling.
- d ↔ _____ mm The dimension between axes from the rear edge of the console to the centre of the drilling is needed for the tap hole drilling as well.
- e ↔ _____ mm Please specify desired gap between the console support and left outer edge and as well the type of console support (# DS 9926, DS 9902, DS 9933)

Infobox: DuraStyle console free-standing:
3 console supports for consoles with a length of 1000 - 1399 mm,
4 console supports for consoles with a length of 1400 - 2000 mm.

floor cabinet
vanity unit

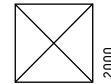

console support-
towel rail
DS 9933



console support-
bracket # DS 9902
(40 mm)



console support-T-
shaped # DS 9926



HL = Tap hole drilling,
D = 35 mm (size specifi-
cation optional)



Please ensure that all of the required information is entered on the order form. The pre-printed grid will make it easier to draw a plan of the console surface.

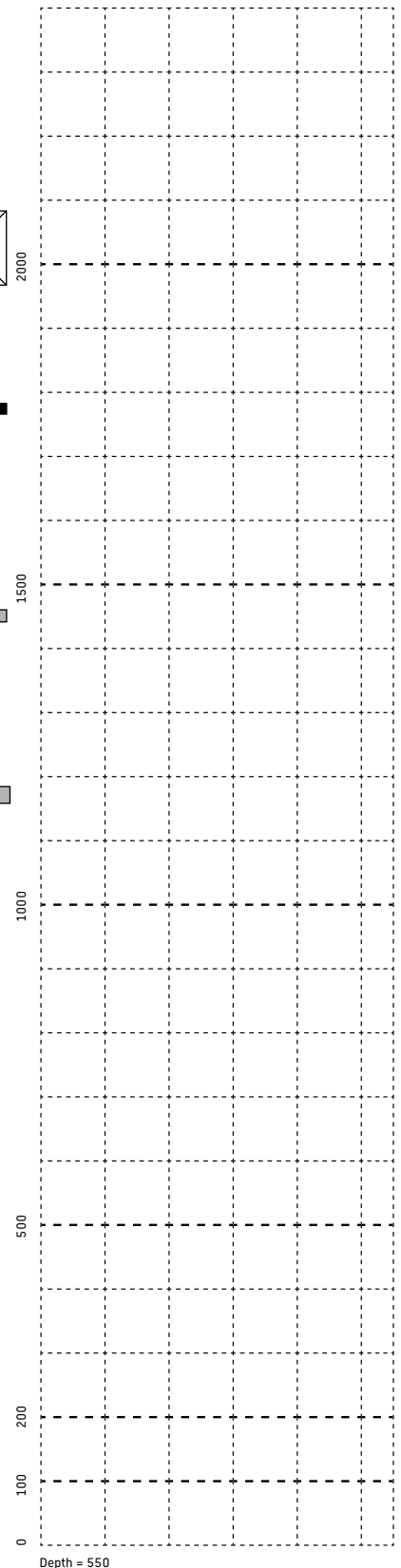

Order information for consoles PuraVida

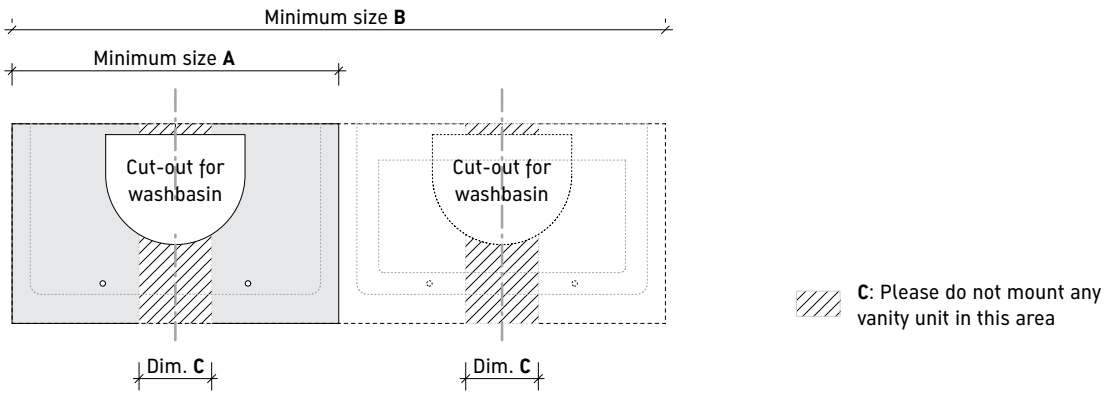

Series	Ceramics	Minimum size A (mm) Console with 1 cut-out	Minimum size B (mm) Console with 2 cut-outs	Dimension C (mm)	
PuraVida	# 037070	800	1600	200	
PuraVida	# 036970	800	1600	200	

Order sheet for consoles PuraVida

Order nr. _____

Client _____

Date _____

Deadline _____

Console colour _____

Interior colour of box (Low cabinet / Vanity unit) _____

Washbasin # _____

Length (a) _____ mm

Vanity unit length _____ mm

Position of vanity unit (L/R; L+R) _____ mm

Unit spacing (b) _____ mm

Tap types _____

Position of console support (c) _____ mm

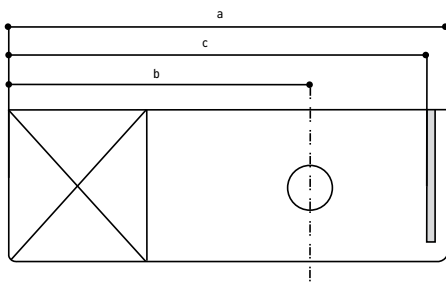

Infobox: Drilling of the tap hole (centred behind washbowl) is done serial. (Model without tap hole drilling is possible on request) / PuraVida console free-standing: 3 console supports for consoles with a length of 1000 - 1399 mm, 4 console supports for consoles with a length of 1400 - 2000 mm.

Please ensure that all of the required information is entered on the order form. The pre-printed grid will make it easier to draw a plan of the console surface.

console support-
bracket # PV 9902



Console support -
towel rail # PV 9933



Vanity unit

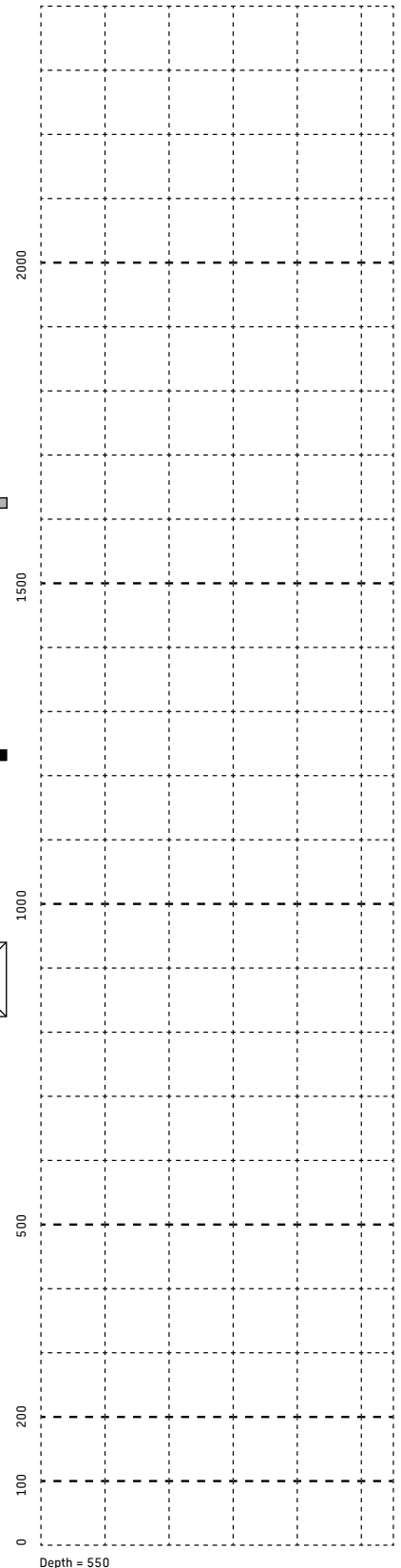

General Terms Of Sale

I. GENERAL

Unless written provisions to the contrary agreed by the Management, all our sales are exclusively carried out under the present General Terms of Sale which supersede any different clauses appearing in orders or letters from buyers. Unless by written agreement, our customer's general terms of purchase are ineffective and may in no case prevail over our own terms of sale.

II. OFFERS

The information appearing in our catalogues, leaflets, pricelists and offers as statements by our representatives, agents and employees are given for information only and may thus be subject to modifications.

We reserve the right to carry out any product modification deemed by us to be useful, or even to discontinue some of our products without prior notice.

Unless otherwise agreed, our offers shall only be available 30 days as from the date of dispatches our issue. Our supplies and services are limited to the elements specified in our offers.

III. ORDERS

Written or verbal orders received directly or through the medium of our representatives, agents and employees only become definite after express and written confirmation by our company.

On seller's request, any order may be subject to the return of an acknowledgement of receipt within a given time. For lack of complaint by the buyer within eight days as from the date of dispatch, our order confirmations equal firm and definite contract under the present terms of sale and the customer shall then be no longer entitled to complain about non-conformity with his order. Orders are subject to our approval and may be reduced or cancelled, namely in case of prior sale of products in stock.

As the size and style of execution of our products are subjects to technically inevitable variations, the products are allowed the accepted tolerances in order to take the special conditions of preparation into account.

The buyer is definitely bound from the moment he signs an order form or contract with one of our delegates, representatives, agents or employees. No order may be cancelled without our express written agreement.

We reserve the right to refuse any order cancellation or to subject it to prior payment of a compensation corresponding with the loss suffered.

IV. PRICES

Unless otherwise stated in our offers order confirmations, our prices are exclusive of taxes and for goods removed from our works, stores or warehouses, without packaging. Whatever the date of order, our prices are invoiced in accordance with the rates in force on the day of order confirmation.

Additional or special executions shall be subject to extra charges.

In case of increase in the price of raw materials or in the cost of labour for products ordered and in case such increase occurs between booking of the order and the date of delivery, our company shall be entitled to pass such increases either partly or fully on the rates in force on the day of order confirmation.

The agreed price may also be modified in presence of new fiscal clauses.

Unless express, written and special commitment to the contrary, discounts and rebates granted to our customers are temporary and specific for each individual case. Accordingly, our company reserves the right to modify or suppress such grants at any moment. Same applies for end-of-year discounts or rebates.

V. DELIVERIES - SHIPMENT

Our terms of delivery are in working days. They are given for information only and without engagement.

If a down-payment is demanded with the order, the time of delivery runs as from the day after receipt of this down-payment.

Delay in delivery shall neither entail cancellation of orders or purchases for account nor entitle to any penalty or indemnity.

In principle, our goods shall be removed from our works, stores or warehouses and the customer shall take delivery of the order on the agreed date; after this time, the goods shall be kept for account and risk of the customer.

Warehouse charges for goods which could not be delivered within the time of delivery for reasons beyond our control are chargeable to the buyer.

All our goods sold in sample or type shall be collected and accepted in our works or stores or in third parties in which they may have been deposited, even in case of sale carriage paid. The buyer shall accept the goods before shipment. Failing that, goods transfer outside the premises in which they were stored in view of shipment or col-

lection by the carrier shall equal specification and individualization of said goods and entail transfer of liability to the buyer with the only reserve of payment of these goods.

Deliveries possibly carried out by our company with its own vehicles are services to the customer and do not depart from the above mentioned provisions. In case of sale in which the carrier is appointed by our company, the latter only acts in the capacity of buyer's agent and transacts with the carrier on behalf and for account of the buyer.

Even when shipped carriage paid, our goods always travel at consignee's risk; upon receipt, the latter shall check their quantity, quality and condition before taking delivery, possibly have reserves and direct recourse against the carrier in case of delay, loss or damage.

The civil liability of our company shall in no case be involved in case of damage or average occurring for any reason (fire, water, etc.) or in case of partial or total loss of the said goods whatever the reason of the loss when the goods put at customer's disposal have been stored by us on customer's request in our premises or in premises belonging to third parties. Same applies in case of noncollection of the goods within the agreed and stipulated terms. Should the manufacture of frames, cases, loads or pallets be necessary for shipment, its cost shall be invoiced extra. Moreover, the said packing shall not be taken back.

VI. FORTUITOUS EVENT - FORCE MAJEURE

Accidents in works, lack of labour, strikes, war, political events irregular deliveries of raw materials etc. are cases of absolute necessity allowing us to suspend or annul our commitments and extend the agreed time limits without entitling the buyer to any indemnification.

The contract of sale may be expressly suspended on our own initiative by sending a registered letter with return receipt to the buyer in following cases: difficulties or refuse of exportation, difficulties to obtain administration's acceptance of the authority to transfer capital and each time unexpected difficulties inherent in export transactions arise without preventing the sale definitively.

VII. LIABILITY - GUARANTEE

Since the buyer has taken due note of the characteristics of the products of the range proposed by the seller, it is expressly agreed that the buyer shall have chosen the products mentioned in the order handed to the seller on his own responsibility and according to the requirements he determined.

Any complaint relating to possible apparent defects of the goods sold by our company shall only be accepted if made by registered letter with return receipt sent within three days following the day on which the buyer or his agent will have taken delivery of the goods in our works, stores or warehouses or, should the goods be forwarded by our company, within three days following the day on which the goods have arrived at destination (attestation by postmark).

In the same way, any complaint relating to possible hidden defects of goods shall only be accepted if made by registered letter with receipt sent within two days following the date on which the buyer will have been acquainted with the hidden defects.

In any case, complaints relating to hidden defects shall only accepted if made within one month following the date on which the customer will have taken delivery of the goods in our works, stores or warehouses or, in the case the goods are forwarded by our company, within one month following the date on which the goods will have arrived at destination.

To be admissible, complaints shall be detailed and precise, namely as to the defects noticed or non-conformity of the goods.

Our company reserve the right to have the goods forming the subject matter of complaints surveyed. In any case, complaints for hidden or apparent defects shall only be accepted if the goods have not been subjected to any transformation and if it has been acknowledged, after due hearing of the parties, that the defects are imputable to the company and if the buyer has taken all necessary steps to keep the goods in same state until acknowledgment after due hearing of the parties or possibly until shipment.

Our company's liability is limited, according to our preference, either to replacement within a reasonable time of the goods recognized to be faulty and without any other charge than carriage for the said goods, or to reimbursement of the invoice price.

Disputes relating to possible goods defects shall in no case entitle the buyer to suspend or refuse payment of our invoices or drafts.

We expressly accept no responsibility for any prejudice which could be inflicted to the buyer due to goods covered by the guarantee.

Items sold at special prices due to downgrading may in no case allow for any complaint regard-

ing the style of execution, surface evenness, size, etc.

Goods shall in no case be returned without our prior agreement; such agreement shall in no case be considered to be acknowledgment.

VIII. TERMS OF PAYMENT

Unless we agree otherwise by special, express and written agreement, invoices shall be payable cash at our registered office by cheque upon receipt.

A down-payment with the order may be requested for some orders available in stock; the remainder shall then be paid when the goods are put to buyer's disposal.

Prior express and written agreement by our company shall be required for payment by instalments. Unless otherwise agreed, such agreement shall be specific for each individual case. Our goods shall then be payable by drafts. Any refuse or default of acceptance of our drafts within the fixed time shall entail immediate payability of all our claims within good time and with exemption from summons or formalities as also annulment or cancellation of the sale.

In case of payment by instalments previously agreed by our company, and when buyer's credit deteriorates, we always reserve the right to demand guarantees deemed by us to be appropriate for fair fulfilment of commitments, even after partial shipment of an order. Refusal to it or insufficient guarantee shall give us the right to cancel or suspend all or part of the transaction.

The same applies namely in case of partial or full stoppage of buyer's business, whatever the cause.

The date of shipment shall be the starting point of the agreed times of payment. Cash payments shall be effected within a time of 10 days as from the date of shipment. Only payments effected within this time shall be considered to be cash payments.

The customer shall in no case be authorized to deduce the value of a reimbursement or of a credit to which he is entitled from the amount of the payment to be effected if he does not possess a credit advice showing the amount or reimbursement of the credit.

For lack of payment of an amount due at maturity, an interest rate of 2 points up to the discount rate of the State Central Bank of Baden-Württemberg will be charged. Additionally, all claims arising from the delay will be reserved.

All expenses resulting from the return of dishonoured drafts and all collecting charges of every kind incurred by our company to obtain payment of debts shall be chargeable to the buyer.

Default of payment at due date of any part of the price shall make payment of all non-matured invoices immediately due, without summons nor formalities unless derogation mutually agreed and confirmed in written form by the seller.

Notwithstanding all that has been mentioned above, the seller reserves the right to implement article IX of these Terms of Sale for lack of payment at maturity of any amount under the contract of sale.

It is expressly agreed and understood that any invoicing performed on the request of an installer or of any other agent to the customer / consumer direct or to any other third party shall not be considered to be an acknowledgment by our company and do not release the installer or agent from their obligations of payments to us.

IX. TRANSFER OF PROPERTY

According to the law of 12th May 1980 the provisions thereof are deemed to be perfectly familiar to the buyer who accepts them, all our sales are effected with retention of title.

Accordingly, transfer to the buyer of the property of goods shall be suspended until payment in full of the price. In case of remittance of a cheque or bill, payment shall only be considered to have been effected at the moment of actual collection.

The risks are transferred to the buyer upon delivery of the goods sold with retention of title.

The buyer shall provide or their preservation, maintenance and use at his own expenses and own risk. He shall be responsible for any damage caused by the goods as from delivery.

Until transfer of property to his favour, the buyer shall see to good conservation of the identifying codes affixed by the seller to the goods according to the mentions appearing on the sales documents.

The buyers shall oppose by any legal means claims that third parties could assert as to goods sold by seizure, confiscation of by any similar proceedings. As soon as advised, he shall inform the seller to enable him to protect his interests.

If he is not the proprietor of the premises in which he exercises his trade, he shall acquaint the lessor with the legal status of the goods sold and prove observance of this formality to the seller. Unless expressly authorized by the seller, the buyer is not entitled to remove the goods sold

from the usual storage premises.

Any operation which would result in an attack on seller's possibility to repossess the goods sold as they were or to modify the legal status of all or part of the goods sold (consumption by the buyer, transformation or incorporation with other goods, reselling, assignment of rights over these goods to third parties) may only be carried out, unless written prior agreement by the seller, after payment of the balance of the amount remaining due for the goods concerned.

For lack of payment at maturity of any amount due by virtue of the sale contract or for lack of fulfilment of any commitment by the buyer, we may terminate the contract of sale with good right and without being bound to comply with legal formalities within eight days after ordinary summons by a registered letter which has had no effect.

In the same way, contracts of supply or delivery passed with us shall be terminated with good right days after ordinary summons by a registered letter which has had no effect.

Seller's repossession of the claimed goods imposes on the buyer the obligation to make up for the prejudice resulting from the depreciation and especially from the unavailability of the good concerned.

Consequently and by way of penalty clause, the buyer shall owe an indemnity amounting to 10% of the agreed price per month of possession of the goods taken back.

If termination of the contract makes the seller become debtor for down-payment previously received from the buyer, he shall be entitled to make up for such debt, with the claim resulting from the above-mentioned penalty clause.

X. PLACE OF PERFORMANCE, JURISDICTION AND OTHER AGREEMENT

All our sales are deemed transacted at our registered office constituting the place of payment.

Payment by draft or other bill of exchange shall in no case constitute a departure from the provisions of these General Terms.

Generally, the place of performance is Hornberg, even if deliveries are effected from other places. Provided the ordering party is a fully qualified commercial agent, any disputes arising from the contractual relationship must be taken to the court with jurisdiction over the supplier's head office.

In case of international sale and unless expressly otherwise agreed, the applicable law shall be the German law.

Any business with our company implies clean acceptance of the present general terms.

Colour chart ceramics / metal

Colour		00 – White	08 – Black	27 – Matt Crema	33 – Matt White Silk	47 – Pergamon	68 – Anthracite matt
Colour code		00	08	27	33	47	68
Ceramics							
1930 series	—	●
2nd floor	—	●
Architec	—	●
Bacino	—	●
Bagnella	—	●
Caro	—	●
Darling New	—	●
D-Code	—	●
Duraplus	—	●	.	.	.	●	.
Esplanade	—	●
Bathroom_Foster	—	●
Happy D.2	—	●
PuraVida	—	●
Scola	—	●
Starck 1	—	●
Starck 2	—	●
Starck 3	—	●
Vero	—	●	●
<hr/>							
Kitchen sinks							
Kiora	—	●	●	●	●	●	●
Starck K	—	●	●	●	●	●	●
Vero	—	●	●	●	●	●	●
<hr/>							
Metal finishes							
00 White							
10 Chrome							

Colour chart furniture surfaces - Bathtub panels / Wellness products

	2nd floor	Blue Moon	Darling New	DuraStyle	Esplanade	Inipi	Inipi B	Nahho	Paiova	PuraVida	Starck	St.Trop	Sundeck	Vero
Real wood massive														
76 Europ. Oak solid wood	—
77 Amer. Walnut solid wood	—
Real wood veneer														
05 Oak	—	.	.	.	●	●	●	.	●
12 Brushed Oak	—	●	.	●	.	.	●
13 American Walnut	—	.	●	.	.	●	●	.	●	.	●	●	●	●
24 Macassar	—	.	●	.	.	●	.	.	●	.	●	●	●	●
26 Americ. Cherry Tree	—	●	.	●	●	.	●
59 Ebony	—	●	.	.	.	●	.	.	●	●*	.	●	.	.
62 Anthracite Oak	—	●	●	●	.	●	●	●	●
65 Bleached Oak	—	●	.	.	.	●	.	.	●	.	●	●	.	●
69 Brushed Walnut	—	●	.	●	.	.	●
72 Brushed Dark Oak	—
Decor														
01 Cherry Tree (Outdoor)	—	.	●	●	.
02 Wengé (Outdoor)	—	.	●	●	.
14 Terra	—	.	.	●	●	.	.
15 Spring	—
18 White Matt	—	●**
22 White High Gloss	—	●	●	●	.	.
29 Azur	—
31 Pine Silver	—	.	.	●	●	.	.
37 White Aluminium	—
43 Basalt Matt	—	.	.	.	●	●	●	.	●
49 Graphite Matt	—	●**	.	.	●	●	.	●
50 Garnet Red Matt	—	●	●	.	●
51 Pine Terra	—	.	.	●	●	.	.
52 European Oak	—	.	.	.	●	●	.	.
53 Chestnut Dark	—	.	●	.	●	●	.	.	●	.	●	●	●	●
67 Rosewood	—	●	●	.	.	●	.	.
70 Aluminium	—	●*
75 Linen	—
79 Natural Walnut	—	●	.	.	●
Lacquer														
40 Black High Gloss	—	●*	.	●	.	.
56 Silk	—	●	.	.
85 White High Gloss	—	●*	.	●	.	.
86 Cappuccino High Gloss	—	●	.	.
88 Red High Gloss	—	●*	.	●	.	.
Acryl														
82 Acrylic White	—	●	●	●	●	.	.	●	●	●	●	.	.	●

* only shadow gap
** only furniture cover

Colour chart furniture surfaces - Bathroom furniture

	2nd floor	Darling New	Delos	DuraStyle	Esplanade	Fogo	Happy D.2	Ketho	Light and mirrors	PuraVida	Starck	X-Large
Real wood massive												
76 Europ. Oak solid wood	.	.	.	●**
77 Amer. Walnut solid wood	.	.	.	●**
Real wood veneer												
05 Oak	—	.	.	.	●	●	.
12 Brushed Oak	—	.	●	●
13 American Walnut	—	●	●	.	.	.	●	.
24 Macassar	—	●	●	.
26 Americ. Cherry Tree	—	●	●
59 Ebony	—	●	●*	.	.
62 Anthracite Oak	—	●	●
65 Bleached Oak	—	●	.	.	.	●
69 Brushed Walnut	—	.	●
72 Brushed Dark Oak	—	●
Decor												
01 Cherry Tree (Outdoor)	—
02 Wengé (Outdoor)	—
14 Terra	—	●
15 Spring	—	●
18 White Matt	—	●	.	●	.	.	.	●	.	.	.	●
22 White High Gloss	—	●	●
29 Azur	—	●
31 Pine Silver	—	●
37 White Aluminium	—	●
43 Basalt Matt	—	.	.	●	.	.	.	●
49 Graphite Matt	—	●
50 Garnet Red Matt	—	●
51 Pine Terra	—	●
52 European Oak	—	.	.	●	.	.	●
53 Chestnut Dark	—	.	.	●	●
67 Rosewood	—	●
70 Aluminium	—	●*	.	.
75 Linen	—	●
79 Natural Walnut	—	●
Lacquer												
40 Black High Gloss	—	●*	●	.
56 Silk	—	.	.	.	●
85 White High Gloss	—	●	●	●	●	●	●	●
86 Cappuccino High Gloss	—	●
88 Red High Gloss	—	●*	.	.	.
Acryl												
82 Acrylic White	—

* only console
** only accessoires

Furniture Surfaces

01 Cherry Tree (Outdoor)	02 Wengé (Outdoor)	05 Oak	12 Brushed Oak	13 American Walnut
14 Terra	15 Spring	18 White Matt	22 White High Gloss	24 Macassar
26 Americ. Cherry Tree	29 Azur	31 Pine Silver	37 White Aluminium	40 Black High Gloss
43 Basalt Matt	49 Graphite Matt	50 Garnet Red Matt	51 Pine Terra	52 European Oak
53 Chestnut Dark	56 Silk	59 Ebony	62 Anthracite Oak	65 Bleached Oak
67 Rosewood	69 Brushed Walnut	70 Aluminium	72 Brushed Dark Oak	75 Linen
76 European Oak massive	77 Americ. Walnut massive	79 Natural Walnut	82 Acrylic White	85 White High Gloss
86 Cappuccino High Gloss	88 Red High Gloss			

Duravit AG
P.O. Box 240
78132 Hornberg
Germany
Phone +49 78 33 70 0
Fax +49 78 33 70 289
info@duravit.com
www.duravit.com

for the pro >

pro.duravit.com

