















Cables and Leaders

	Catalog No.	Model No.	Description	Weight	
				lb.	kg
5/8" - 16 mm	37628	C-25 HD	25' HD Cable (7.6m)	24	10.9
	37633	C-26 HD	50' HD Cable (15.2m)	43	19.5
	37638	C-27 HD	75' HD Cable (30.5m)	63	28.6
	37643	C-24 HD	100 HD Cable (30.5m)	84	38.1
	44122		5/8" (16 mm) Pigtail, 4 1/2' (1.4 m) Long	2 1/2	1.1
	58192	C-24HC	5/8" (16 mm) x 100' HC Cable (30.5 m)	70 1/2	32.1
	43647	C-24	5/8" (16 mm) x 100' IC Cable (30.5m)	84	38.1
	92460	C-25	5/8" (16 mm) x 25' IC Cable (7.6m)	24	10.9
	92465	C-26	5/8" (16 mm) x 50' IC Cable (15.2m)	43	19.5
	92470	C-27	5/8" (16 mm) x 75' IC Cable (22.9m)	63	28.6
	92555	T-458	5/8" (16 mm) x 2' (50 mm) Leader	2	0.8
	32737	C-27HC	5/8" (16 mm) x 75' HC Cable (23 m)	52 3/4	23.9

Tools and Replacement Blades – Fit 5/8" (16 mm) and 3/4" (20 mm) Cables

	Catalog No.	Model No.	Description	Replac. Blade(s)	Replac. Holder
	51762	T-409	H-D Bulb Auger, 1 3/4" (45 mm)	-	-
	92485	T-403	P-Trap Cutter, 3" (75 mm)	92835	92900
	92490	T-404	P-Trap Cutter, 3 1/2" (87 mm)	92840	92900
	92495	T-406	Spade Cutter, 1 3/4" (45 mm)	92850	92915
	92500	T-407	Retrieving Auger 2 9/16" (65 mm)	-	-
	92505	T-408	Sawtooth Cutter, 3" (75 mm)	92890	92915
	92510	T-411	Double Cutter, 2" (50 mm)	92815	92905
	92515	T-412	Double Cutter, 2 1/2" (65 mm)	92820	92905
	92520	T-413	Double Cutter, 3" (75 mm)	92825	92910
	92525	T-414	Double Cutter, 4" (110 mm)	92830	92910
	92530	T-416	Double Cutter, 6" (150 mm)	92855	92910
	92535	T-432	3-Blade Cutter 2" (50 mm)	92860	92895
	92545	T-434	3-Blade Cutter 4" (110 mm)	92870	92895
	92550	T-436	3-Blade Cutter 6" (150 mm)	92875	92895
	59230	A-13	3/8" Cable Pin Key	-	-

Accessories

Catalog No.	Description
92540	3-Blade Cutter 3" (75 mm)
49032	Front Guide Hose Assembly
59360	Tool Box
70032	RIDGID® PVC Drain Cleaning Gloves
91047	5/8" IW Cable Repair Coupling
95792	Swivel Loading Wheel Assembly
95797	Lifting Hook - K-6200
95802	K-6200 Drum Assy. w/5/8" Pigtail
95807	K-3800 Drum Assy. w/6200 Adapters
95812	AUTOFEED® Assembly
95822	K-3800 to K-6200 Adapter Kit Only



Inner Core (IC) Cables

	Catalog No.	Model No.	Description	Weight	
				lb.	kg
5/8" - 16 mm	92460	C-25	5/8" (16 mm) x 25' IC Cable (7.6m)	24	10.9
	92465	C-26	5/8" (16 mm) x 50' IC Cable (15.2m)	43	19.5
	92470	C-27	5/8" (16 mm) x 75' IC Cable (22.9m)	63	28.6
	43647	C-24	5/8" (16 mm) x 100' IC Cable (30.5m)	84	38.1
	37643	C-24HD	5/8" (16 mm) x 100' Heavy Duty Cable (30.5m)	85	38.6
3/4" - 20 mm	92475	C-28	3/4" (20 mm) x 25' IC Cable (7.6m)	30	13.9
	92480	C-29	3/4" (20 mm) x 50' IC Cable (15.2m)	60	27.2
	41212	C-75	3/4" (20 mm) x 75' IC Cable (22.9m)	93	42.5
	41697	C-100	3/4" (20 mm) x 100' IC Cable (30.5m)	122	55.3







Hollow Core Cables

	Catalog No.	Model No.	Description	Weight	
				lb.	kg
5/8" - 16 mm	32737	C-27HC	5/8" (16 mm) x 75' HC Cable (23 m)	52 3/4	23.9
	58192	C-24HC	5/8" (16 mm) x 100' HC Cable (30.5 m)	70 1/2	32.1
3/4" - 20 mm	47427	C-75HC	3/4" (20 mm) x 75' HC Cable (23 m)	75	34.0
	47432	z-100HC	3/4" (20 mm) x 100' HC Cable (30.5 m)	100	45.5



Leaders and Pig Tails

	Catalog No.	Model No.	Description	Weight	
				lb.	kg
	92555	T-458	5/8" (16 mm) x 2' (50 mm) Leader	2	0.9
	92560	T-468	3/4" (20 mm) x 2' (50 mm) Leader	2 3/4	1.3
	44122	-	5/8" (16 mm) Pigtail, 4 1/2' (1.4 m) Long	2 1/2	1.1
	44117	-	3/4" Pigtail Assembly	3 1/2	1.6















Accessories

	Catalog No.	Model No.	Description	Weight	
				lb.	kg
	41982	A-7534	Drum Assembly with 3/4" (20 mm) Pigtail	37 1/2	17.0
	43637	A-7558	Drum Assembly with 5/8" (16 mm) Pigtail	33	15.0
	43642	A-75	AUTOFEED Assembly	8	3.5
	41937	-	RIDGID® Leather Drain Cleaning Gloves	1/2	0.2
	41992	A-75PF	C-100IC Kit with Tools, 3/4" (20 mm) x 100' (30,5 m)	8	3.5
	49032		Front Guide Hose Assembly	3	1.3
	59360	A-3	Tool Box	5	2.3
	70032	-	RIDGID® PVC Drain Cleaning Gloves	1/2	0.2
	46015		Key, Hex 5/32	-	-

Repair Fittings

	Catalog No.	Model No.	Description	Weight	
				lb.	kg
	31487	A-7570	5/8" (16 mm) Repair Splicer	1 1/2	43.0
	31492	A-7571	3/4" (20 mm) Repair Splicer	2	57.0
	92805	A-6582	5/8" (16 mm) Male Coupling	1	28.0
	92810	A-6583	5/8" (16 mm) Female Coupling	2	57.0
	92880	B-6840	3/4" (20 mm) Male Coupling	1	28.0
	92885	B-6841	3/4" (20 mm) Female Coupling	2	57.0

Tools and Replacement Blades – Fit 5/8" (16 mm) and 3/4" (20 mm) Cables

	Catalog No.	Model No.	Description	Replac. Blade(s)	Replac. Holder
	92485	T-403	P-Trap Cutter, 3" (75 mm)	92835	92900
	92490	T-404	P-Trap Cutter, 3 1/2" (87 mm)	92840	92900
	92495	T-406	Spade Cutter, 1 3/4" (45 mm)	92850	92915
	92500	T-407	Retrieving Auger 2 3/16" (65 mm)	-	-
	92505	T-408	Sawtooth Cutter, 3" (75 mm)	92890	92915
	51762	T-409	H-D Bulb Auger, 1 3/4" (45 mm)	-	-
	92510	T-411	Double Cutter, 2" (50 mm)	92815	92905
	92515	T-412	Double Cutter, 2 1/2" (65 mm)	92820	92905
	92520	T-413	Double Cutter, 3" (75 mm)	92825	92910
	92525	T-414	Double Cutter, 4" (110 mm)	92830	92910
	92530	T-416	Double Cutter, 6" (150 mm)	92855	92910
	92535	T-432	3-Blade Cutter 2" (50 mm)	92860	92895
	92540	T-433	3-Blade Cutter 3" (75 mm)	92865	92985
	92545	T-434	3-Blade Cutter 4" (110 mm)	92870	92895
	92550	T-436	3-Blade Cutter 6" (150 mm)	92875	92895

*STANDARD 3/4" (20 MM) TOOL SET INCLUDES

- T-406 Spade Cutter - 92495
- T-407 Retrieving Auger - 92500
- T-411 2" (50 mm) Cutter - 92510
- T-413 3" (75 mm) Cutter - 92520
- T-414 4" (110 mm) Cutter - 92525
- Hex Key - 46015

*STANDARD 5/8" (16 MM) TOOL SET INCLUDES

- T-403 3" (75 mm) P-Trap Cutter - 92485
- T-407 Retrieving Auger - 92500
- T-406 Spade Cutter - 92495
- T-411 2" (50 mm) Cutter - 92510
- T-413 3" (75 mm) Cutter - 92520
- Hex Key - 46015

*Sold Separately

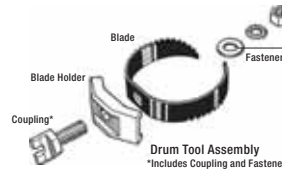

Cable Control & Performance – When Tool Engages Tough Obstructions

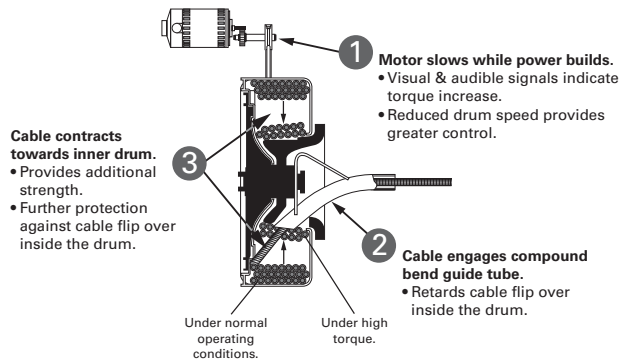

Accessories

	Catalog No.	Model No.	Description	Weight	
				lb.	kg
	41937	-	RIDGID® Leather Drain Cleaning Gloves	1/2	0.2
	41992	A-75PF	C-100IC Kit with Tools, 3/4" (20 mm) x 100' (30.5 m)	8	3.5
	49032		Front Guide Hose Assembly	3	1.3
	59360	A-3	Tool Box	5	2.3
	60032		AUTOFEED® Assembly		
	60037	A-75PF	AUTOFEED® Spacers (4)	10	4.5
	60042	A-7534D	Drum Assembly w/3/4" (20 mm) Pigtail	31	14.0
	60047	A-75DR	Drum Only	20	9.0
	61107	A-7558D	Drum Assembly w/5/8" (16 mm) Pigtail	30	13.6
	70032	-	RIDGID® PVC Drain Cleaning Gloves	1/2	0.2
	31487	A-7570	5/8" (16 mm) Repair Splicer	3/32	0.0
	31492	A-7571	3/4" (20 mm) Repair Splicer	1/8	0.1
	92805	A-6582	5/8" (16 mm) Male Coupling	1/16	0.0
	92810	A-6583	5/8" (16 mm) Female Coupling	1/8	0.1
	92880	B-6840	3/4" (20 mm) Male Coupling	1/16	0.0
	92885	B-6841	3/4" (20 mm) Female Coupling	1/8	0.1

Inner Core (IC) Cables

	Catalog No.	Model No.	Description	Weight	
				lb	kg
5/8" - 16 mm	92460	C-25	5/8" (16 mm) x 25' IC Cable (7.6m)	24	10.9
	92465	C-26	5/8" (16 mm) x 50' IC Cable (15.2m)	43	19.5
	92470	C-27	5/8" (16 mm) x 75' IC Cable (22.9m)	63	28.6
	43647	C-24	5/8" (16 mm) x 100' IC Cable (30.5m)	84	38.1
3/4" - 20 mm	92475	C-28	3/4" (20 mm) x 25' IC Cable (7.6m)	30	13.9
	92480	C-29	3/4" (20 mm) x 50' IC Cable (15.2m)	60	27.2
	41212	C-75	3/4" (20 mm) x 75' IC Cable (22.9m)	93	42.5
	41697	C-100	3/4" (20 mm) x 100' IC Cable (30.5m)	122	55.3

Hollow Core Cables

	Catalog No.	Model No.	Description	Weight	
				lb	kg
5/8" - 16 mm	32737	C-27HC	5/8" (16 mm) x 75' HC Cable (23 m)	52 3/4	23.9
	58192	C-24HC	5/8" (16 mm) x 100' HC Cable (30.5 m)	70 1/2	32.1
3/4" - 20 mm	47427	C-75HC	3/4" (20 mm) x 75' HC Cable (23 m)	75	34.0
	47432	C-100HC	3/4" (20 mm) x 100' HC Cable (30.5 m)	100	45.5

Leaders and Pig Tails

	Catalog No.	Model No.	Description	Weight	
				lb	kg
	92555	T-458	5/8" (16 mm) x 2' (50 mm) Leader	2	0.9
	92560	T-468	3/4" (20 mm) x 2' (50 mm) Leader	2 3/4	1.3
	44122		5/8" (16 mm) Pigtail, 4 1/2' (1.4 m) Long	2 1/2	1.1
	44117		3/4" Pigtail Assembly	3 1/2	1.6

Tools and Replacement Blades – Fit 5/8" (16 mm) and 3/4" (20 mm) Cables

	Catalog No.	Model No.	Description	Replac. Blade(s)	Replac. Holder
	51762	T-409	H-D Bulb Auger, 1 3/4" (45 mm)	-	-
	92485	T-403	P-Trap Cutter, 3" (75 mm)	92835	92900
	92490	T-404	P-Trap Cutter, 3 1/2" (87 mm)	92840	92900
	92495	T-406	Spade Cutter, 1 3/4" (45 mm)	92850	92915
	92500	T-407	Retrieving Auger 2 9/16" (65 mm)	-	-
	92505	T-408	Sawtooth Cutter, 3" (75 mm)	92890	92915
	92510	T-411	Double Cutter, 2" (50 mm)	92815	92905
	92515	T-412	Double Cutter, 2 1/2" (65 mm)	92820	92905
	92520	T-413	Double Cutter, 3" (75 mm)	92825	92910
	92525	T-414	Double Cutter, 4" (110 mm)	92830	92910
	92530	T-416	Double Cutter, 6" (150 mm)	92855	92910
	92535	T-432	3-Blade Cutter 2" (50 mm)	92860	92895
	92540	T-433	3-Blade Cutter 3" (75 mm)	92865	92895
	92545	T-434	3-Blade Cutter 4" (110 mm)	92870	92895
	92550	T-436	3-Blade Cutter 6" (150 mm)	92875	92895

C-24, C-25, C-26, C-27, C-28, C-29, C-75, C-100, C-27HC, C-24HC, C-75HC and C-100HC.















Inner Core (IC) Cables

	Catalog No.	Model No.	Description	Weight	
				lb	kg
5/8" - 16 mm	92460	C-25	5/8" (16 mm) x 25' IC Cable (7.6m)	24	10.9
	92465	C-26	5/8" (16 mm) x 50' IC Cable (15.2m)	43	19.5
	92470	C-27	5/8" (16 mm) x 75' IC Cable (22.9m)	63	28.6
	43647	C-24	5/8" (16 mm) x 100' IC Cable (30.5m)	84	38.1
3/4" - 20 mm	92475	C-28	3/4" (20 mm) x 25' IC Cable (7.6m)	30	13.9
	92480	C-29	3/4" (20 mm) x 50' IC Cable (15.2m)	60	27.2
	41212	C-75	3/4" (20 mm) x 75' IC Cable (22.9m)	93	42.5
	41697	C-100	3/4" (20 mm) x 100' IC Cable (30.5m)	122	55.3



Hollow Core Cables

	Catalog No.	Model No.	Description	Weight	
				lb	kg
5/8" - 16 mm	32737	C-27HC	5/8" (16 mm) x 75' HC Cable (23 m)	52 3/4	23.9
	58192	C-24HC	5/8" (16 mm) x 100' HC Cable (30.5 m)	70 1/2	32.1
3/4" - 20 mm	47427	C-75HC	3/4" (20 mm) x 75' HC Cable (23 m)	75	34.0
	47432	C-100HC	3/4" (20 mm) x 100' HC Cable (30.5 m)	100	45.5

Tools and Replacement Blades – Fit 5/8" (16 mm) and 3/4" (20 mm) Cables

	Catalog No.	Model No.	Description	Replac. Blade(s)	Replac. Holder
	51762	T-409	H-D Bulb Auger, 1 3/4" (45 mm)	-	-
	92485	T-403	P-Trap Cutter, 3" (75 mm)	92835	92900
	92490	T-404	P-Trap Cutter, 3 1/2" (87 mm)	92840	92900
	92495	T-406	Spade Cutter, 1 3/4" (45 mm)	92850	92915
	92500	T-407	Retrieving Auger 2 9/16" (65 mm)	-	-
	92505	T-408	Sawtooth Cutter, 3" (75 mm)	92890	92915
	92510	T-411	Double Cutter, 2" (50 mm)	92815	92905
	92515	T-412	Double Cutter, 2 1/2" (65 mm)	92820	92905
	92520	T-413	Double Cutter, 3" (75 mm)	92825	92910
	92525	T-414	Double Cutter, 4" (110 mm)	92830	92910
	92530	T-416	Double Cutter, 6" (150 mm)	92855	92910
	92535	T-432	3-Blade Cutter 2" (50 mm)	92860	92895
	92540	T-433	3-Blade Cutter 3" (75 mm)	92865	92895
	92545	T-434	3-Blade Cutter 4" (110 mm)	92870	92895
	92550	T-436	3-Blade Cutter 6" (150 mm)	92875	92895

Leaders and Pig Tails

	Catalog No.	Model No.	Description	Weight	
				lb	kg
	92555	T-458	5/8" (16 mm) x 2' (50 mm) Leader	2	0.9
	92560	T-468	3/4" (20 mm) x 2' (50 mm) Leader	2 3/4	1.3
	44122	-	5/8" (16 mm) Pigtail, 4 1/2' (1.4 m) Long	2 1/2	1.1
	44117	-	3/4" Pigtail Assembly	3 1/2	1.6

Accessories

Catalog No.	Model No.	Description	Weight	
			lb	kg
41982	A-7534	Drum Assembly with 3/4" (20 mm) Pigtail	37 1/2	17.0
43637	A-7558	Drum Assembly with 5/8" (16 mm) Pigtail	33	15.0
43642	A-75	AUTOFEED Assembly	8	3.5
41937	-	RIDGID® Leather Drain Cleaning Gloves	1/2	0.2
41992	A-75PF	C-100IC Kit with Tools, 3/4" (20 mm) x 100' (30.5 m)	8	3.5
49032	-	Front Guide Hose Assembly	3	1.3
59360	A-3	Tool Box	5	2.3
70032	-	RIDGID® PVC Drain Cleaning Gloves	1/2	0.2

Repair Fittings

	Catalog No.	Model No.	Description	Weight	
				lb	kg
	31487	A-7570	5/8" (16 mm) Repair Splicer	1 1/2	43.0
	31492	A-7571	3/4" (20 mm) Repair Splicer	2	57.0
	92805	A-6582	5/8" (16 mm) Male Coupling	1	28.0
	92810	A-6583	5/8" (16 mm) Female Coupling	2	57.0
	92880	B-6840	3/4" (20 mm) Male Coupling	1	28.0
	92885	B-6841	3/4" (20 mm) Female Coupling	2	57.0