

C153 Mechanical Joint Ductile Iron Fittings

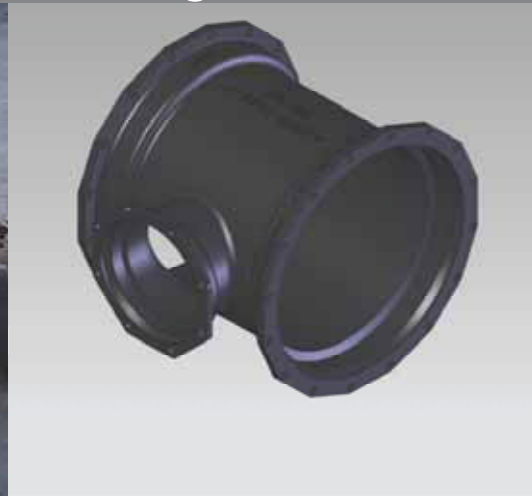
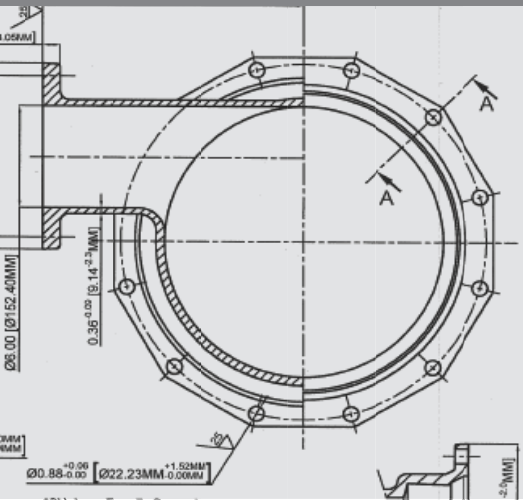

2-64in C153 Ductile Iron Mechanical Joint Class 350

MATERIAL:	Ductile Iron ASTM A536, Grade 65-45-12, 60-42-10 or 70-50-05.
PRESSURE:	350 PSI WATER WORKING PRESSURE (CLASS 350) 3" - 24", 250 PSI 30" - 48" & 150 PSI 50" - 64"
TESTING:	In accordance with ANSI / AWWA C153 / A21.53 & UL - FM requirements.
LAYING LENGTH:	Short body design - straight section of body deleted to provide a compact and lighter fitting without reducing strength or flow characteristics, in accordance with ANSI / AWWA C153 / A21.53.
DEFLECTION:	2" - 4"=8°, 6"=7°, 8"-12"=5°, 14"-16"=3 ½°, 18"-24"=3°, 30" - 64"=2°
CEMENT LINING:	In accordance with ANSI / AWWA C104 / A21.4.
COATING:	Interior of fitting is seal coated (asphaltic material) in accordance with ANSI / AWWA C104 / A21.4 and NSF61 approved.
COATING:	Exterior of fitting is seal coated (asphaltic material) in accordance with ANSI / AWWA C153/A21.53 and NSF approved.
GASKETS:	SBR in accordance with ANSI / AWWA C111 / A21.11. Also available in EDPM, NBR and CR.
T-BOLTS:	Low Alloy corrosion resistant high strength steel in accordance with ANSI / AWWA C111 / A21.11.
APPROVALS:	3"-16" Underwriters Laboratories listed and Factory Mutual Approved.
STANDARDS:	Certified to NSF61 Standard ANSI / AWWA C153 / A21.53 for Compact Ductile Iron Fittings 2"-64" for water and other liquids

Note: 2" - 24" also available in Fusion Bonded Epoxy



C153 Mechanical Joint Compact Fittings

INDEX

BENDS

90° Bends	4
45° Bends	4
22 1/2° Bends	4
11 1/4° Bends	5
90° Bends MJ X Flange	5
45° Bends MJ X Flange	5
22 1/2° Bends MJ X Flange	6
11 1/4° Bends MJ X Flange	6
Adapters: MJ X Flange	6

CROSSES	7-8
----------------------	-----

TEES	8-10
-------------------	------

Tapped Tees and Crosses	10
Tees: MJ x Swivel (Hydrant Tees)	14

CAPS and PLUGS	11
-----------------------------	----

WYES 45° LATERALS	11-12
--------------------------------	-------

REDUCERS: DMR, SPR, LPR, PPR	13-14
---	-------

SWIVEL

Swivel x Solid adapter	15
Swivel Gland	15
Swivel x Solid 90° Bend	15

OFFSETS	16
----------------------	----

SLEEVES	17
----------------------	----

Dual Cutting-In Sleeves	17
Dual Purpose Sleeves	15

MECHANICAL JOINT ACCESSORIES	18
---	----

MJ Glands
MJ Gaskets
Gasket/Bolt Packs
Standard Bolts
Anti-Rotation Bolts
MJ Gland Packs
MJ Retainer Glands
Retainer Packs

Weights in Pounds, Less Accessories / Dimensions in inches
 Ductile Iron Class 350 per ANSI/AWWA C153/A21.53

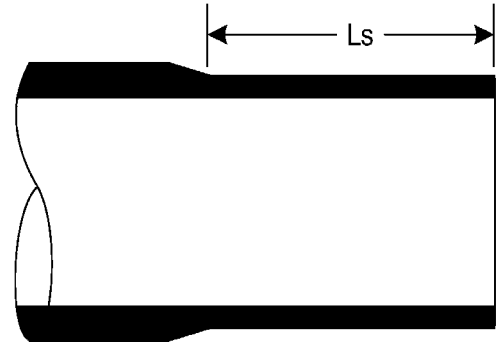
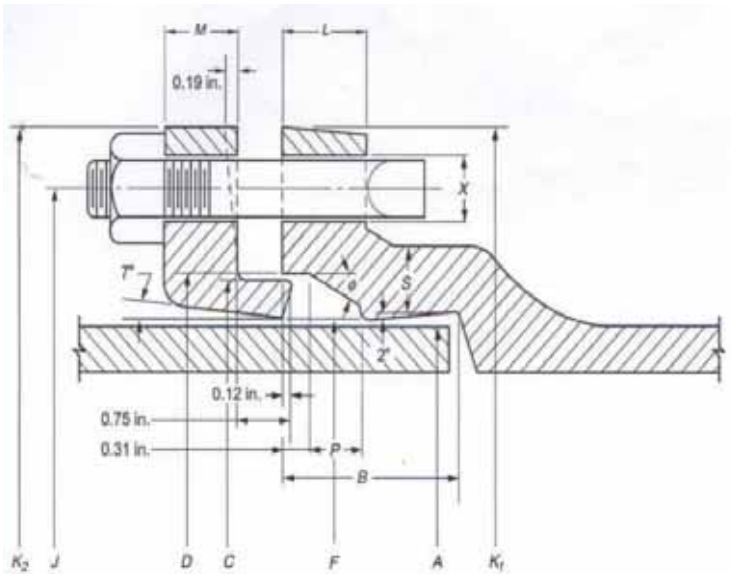

Mechanical Joint Details
Plain End Details

Size	A	B	C	D	F	J	K1	K2	L	M	P	S	X	Bolts			PE Ls
														No.	Size	Len	
3	3.96	2.50	4.84	4.94	4.06	6.19	7.62	7.69	0.58	0.62	0.63	0.39	3/4	4	5/8	3.0	5.5
4	4.80	2.50	5.92	6.02	4.90	7.50	9.06	9.12	0.60	0.75	0.75	0.39	7/8	4	3/4	3.5	5.5
6	6.90	2.50	8.02	8.12	7.00	9.50	11.06	11.12	0.63	0.88	0.75	0.43	7/8	6	3/4	3.5	5.5
8	9.05	2.50	10.17	10.27	9.15	11.75	13.31	13.37	0.66	1.00	0.75	0.45	7/8	6	3/4	3.5	5.5
10	11.10	2.50	12.22	12.34	11.20	14.00	15.62	15.62	0.70	1.00	0.75	0.47	7/8	8	3/4	3.5	5.5
12	13.20	2.50	14.32	14.44	13.30	16.25	17.88	17.88	0.73	1.00	0.75	0.49	7/8	8	3/4	3.5	5.5
14	15.30	3.50	16.40	16.54	15.44	18.75	20.25	20.25	0.79	1.25	0.75	0.55	7/8	10	3/4	4.0	8.0
16	17.40	3.50	18.50	18.64	17.54	21.00	22.50	22.50	0.85	1.31	0.75	0.58	7/8	12	3/4	4.0	8.0
18	19.50	3.50	20.60	20.74	19.64	23.25	24.83	24.75	1.00	1.38	0.75	0.68	7/8	12	3/4	4.0	8.0
20	21.60	3.50	22.70	22.84	21.74	25.50	27.08	27.00	1.02	1.44	0.75	0.69	7/8	14	3/4	4.0	8.0
24	25.80	3.50	26.90	27.04	25.94	30.00	31.58	31.50	1.02	1.56	0.75	0.75	7/8	16	3/4	4.5	8.0
30	32.00	4.00	33.29	33.46	32.17	36.88	39.12	39.12	1.31	2.00	1.00	0.82	1 1/8	20	1	5.5	8.0
36	38.30	4.00	39.59	39.76	38.47	43.75	46.00	46.00	1.45	2.00	1.00	1.00	1 1/8	24	1	5.5	8.0
42	44.50	4.00	45.79	45.96	44.67	50.62	53.12	53.12	1.45	2.00	1.00	1.25	1 3/8	28	1 1/4	6.0	8.0
48	50.80	4.00	52.09	52.26	50.97	57.50	60.00	60.00	1.45	2.00	1.00	1.35	1 3/8	32	1 1/4	6.0	8.0

54" - 64" fittings & dimensions available upon request

 Weights in Pounds, Less Accessories / Dimensions in inches
 Ductile Iron Class 350 per ANSI/AWWA C153/A21.53

C153 Mechanical Joint Compact Fittings

1/4 90° Bends

Size	MJ x MJ			MJ x PE				T
	Item No.	Wt.	A	Item No.	Wt.	A	B	
2	DMB290	17	3.00					0.30
3	DMB390	19	3.50	DME390	16	3.25	8.50	0.33
4	DMB490	25	4.00	DME490	22	4.00	9.50	0.34
6	DMB690	39	5.00	DME690	41	5.00	11.50	0.36
8	DMB890	57	6.50	DME890	58	6.50	12.50	0.38
10	DMB1090	89	7.50	DME1090	83	7.50	13.00	0.40
12	DMB1290	108	9.00	DME1290	114	9.00	14.50	0.42
14	DMB1490	210	11.50	DME1490	197	11.50	19.50	0.47
16	DMB1690	264	12.50	DME1690	248	12.50	20.50	0.50
18	DMB1890	335	14.00	DME1890	325	14.00	21.00	0.54
20	DMB2090	400	15.00	DME2090	390	15.00	22.50	0.57
24	DMB2490	565	16.75	DME2490	575	17.00	25.00	0.61
30	DMB3090	930	21.50	DME3090	865	21.50	30.50	0.66
36	DMB3690	1,450	24.50	DME3690	1,355	24.50	33.50	0.74
42	DMB4290	2,205	29.25	DME4290	2,055	29.25	38.25	0.82
48	DMB4890	2,990	33.25	DME4890	2,805	33.25	42.25	0.90

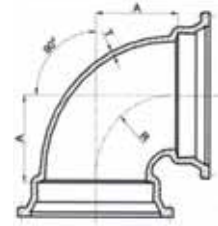

MJ x MJ Bend 90°

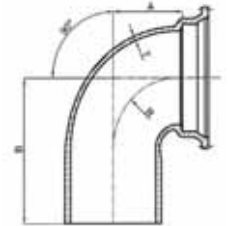

MJ x PE Bend 90°

1/8 45° Bends

Size	MJ x MJ			MJ x PE				T
	Item No.	Wt.	A	Item No.	Wt.	A	B	
2	DMB245	10	1.50					0.33
3	DMB345	16	1.50	DME345	13	1.50	7.00	0.33
4	DMB445	22	2.00	DME445	19	2.00	7.50	0.34
6	DMB645	32	3.00	DME645	34	3.00	8.50	0.36
8	DMB845	46	3.50	DME845	49	3.50	9.00	0.38
10	DMB1045	70	4.50	DME1045	69	4.50	10.00	0.40
12	DMB1245	86	5.50	DME1245	93	5.50	11.00	0.42
14	DMB1445	160	5.00	DME1445	146	5.00	13.00	0.47
16	DMB1645	202	5.50	DME1645	184	5.50	13.50	0.50
18	DMB1845	250	6.00	DME1845	235	6.00	13.00	0.54
20	DMB2045	305	7.00	DME2045	290	7.00	14.00	0.57
24	DMB2445	405	7.50	DME2445	390	7.50	14.50	0.61
30	DMB3045	780	10.50	DME3045	715	10.50	19.50	0.66
36	DMB3645	1135	11.50	DME3645	1,040	12.00	21.00	0.74
42	DMB4245	1610	14.00	DME4245	1,460	14.00	23.00	0.82
48	DMB4845	2090	15.00	DME4845	1,905	15.00	24.00	0.90

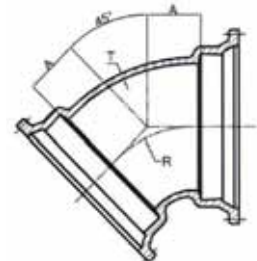

MJ x MJ Bend 45°

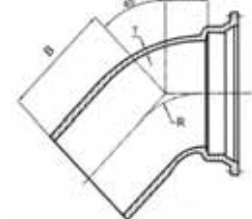

MJ x PE Bend 45°

1/16 22 1/2° Bends

Size	MJ x MJ			MJ x PE				T
	Item No.	Wt.	A	Item No.	Wt.	A	B	
2	DMB222		1.00					0.33
3	DMB322	15	1.00	DME322	12	1.00	6.50	0.33
4	DMB422	18	1.50	DME422	18	1.50	7.00	0.34
6	DMB622	31	2.00	DME622	29	2.00	7.50	0.36
8	DMB822	46	2.50	DME822	43	2.50	8.00	0.38
10	DMB1022	64	3.00	DME1022	61	3.00	8.50	0.40
12	DMB1222	80	3.50	DME1222	79	3.50	9.00	0.42
14	DMB1422	136	3.75	DME1422	133	3.75	11.25	0.47
16	DMB1622	172	3.75	DME1622	166	3.75	11.75	0.50
18	DMB1822	255	4.50	DME1822	235	6.00	13.00	0.54
20	DMB2022	310	4.50	DME2022	300	7.00	14.00	0.57
24	DMB2422	412	4.50	DME2422	395	7.50	14.50	0.61
30	DMB3022	665	6.75	DME3022	600	6.75	15.75	0.66
36	DMB3622	960	7.75	DME3622	865	7.75	16.75	0.74
42	DMB4222	1350	9.00	DME4222	1,200	9.00	18.00	0.82
48	DMB4822	1760	10.00	DME4822	1,575	10.00	19.00	0.90

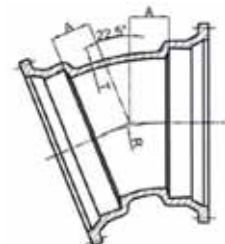

MJ x MJ Bend 22-1/2°

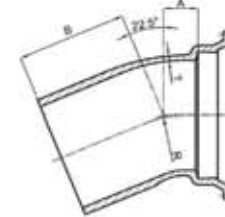

MJ x PE Bend 22-1/2°

Weights in Pounds, Less Accessories / Dimensions in inches
Ductile Iron Class 350 per ANSI/AWWA C153/A21.53



1/32 1-1/4° Bends

Size	MJ x MJ			MJ x PE				T
	Item No.	Wt.	A	Item No.	Wt.	A	B	
3	DMB311	14	1.00	DME311	12	1.00	6.50	0.33
4	DMB411	16	1.25	DME411	17	1.25	6.25	0.34
6	DMB611	30	1.50	DME611	27	1.50	7.00	0.36
8	DMB811	42	1.75	DME811	39	1.75	7.25	0.38
10	DMB1011	58	2.00	DME1011	52	2.00	7.50	0.40
12	DMB1211	67	2.25	DME1211	69	2.25	7.75	0.42
14	DMB1411	93	2.50	DME1411	118	2.50	10.50	0.47
16	DMB1611	148	2.50	DME1611	136	2.50	10.50	0.50
18	DMB1811	205	3.00	DME1811	235	6.00	13.00	0.54
20	DMB2011	245	3.00	DME2011	300	7.00	14.00	0.57
24	DMB2411	315	3.00	DME2411	400	7.50	14.50	0.61
30	DMB3011	600	4.75	DME3011	535	4.75	13.75	0.66
36	DMB3611	820	5.00	DME3611	725	5.00	14.00	0.74
42	DMB4211	1180	6.00	DME4112	1,030	6.00	15.00	0.82
48	DMB4811	1475	6.50	DME4811	1,290	6.50	15.50	0.90

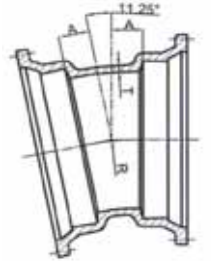

MJ x MJ 11-1/4° Bend

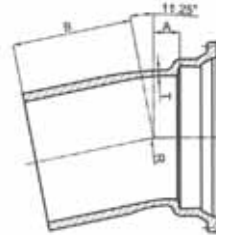

MJ x PE 11-1/4° Bend

90° Bends: MJ X Flange

Size	Item No.	A	S	T	Wt.
3	MFB390	3.50	5.50	0.33	21
4	MFB490	4.00	6.50	0.34	28
6	MFB690	5.00	8.00	0.36	46
8	MFB890	6.50	9.00	0.38	71
10	MFB1090	7.50	11.00	0.40	121
12	MFB1290	9.00	12.00	0.42	155
14	MFB1490	11.50	14.00	0.47	208
16	MFB1690	12.50	15.00	0.50	280
18	MFB1890	14.00	16.50	0.54	332
20	MFB2090	15.00	18.00	0.57	441
24	MFB2490	16.75	22.00	0.61	618
30	MFB3090	21.50	25.00	0.66	994
36	MFB3690	24.50	28.00	0.74	1462
42	MFB4290	29.25	31.00	0.82	2112
48	MFB4890	33.25	34.00	0.90	2816

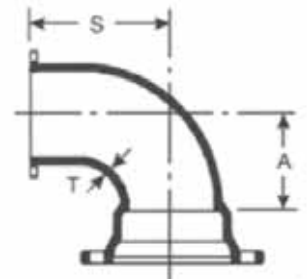

MJ x Flange 90° Bend

45° Bends: MJ x Flange

Size	Item No.	A	S	T	Wt.
3	MFB345	1.50	3.00	0.33	17
4	MFB445	2.00	4.00	0.34	34
6	MFB645	3.00	5.00	0.36	57
8	MFB845	3.50	5.50	0.38	83
10	MFB1045	4.50	6.50	0.40	122
12	MFB1245	5.50	7.50	0.42	159
14	MFB1445	5.00	7.50	0.47	162
16	MFB1645	5.50	8.00	0.50	290
18	MFB1845	6.00	8.50	0.54	252
20	MFB2045	7.00	9.50	0.57	338
24	MFB2445	7.50	11.00	0.61	442
30	MFB3045	10.50	15.00	0.66	765
36	MFB3645	11.50	18.00	0.74	1167
42	MFB4245	14.00	21.00	0.82	1720
48	MFB4845	15.00	24.00	0.90	2276

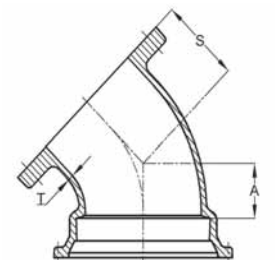

MJ x Flange 45° Bend

 Weights in Pounds, Less Accessories / Dimensions in inches
 Ductile Iron Class 350 per ANSI/AWWA C153/A21.53

C153 Mechanical Joint Compact Fittings

22 1/2° Bends: MJ X Flange

Size	Item No.	A	S	T	Wt.
3	MFB322	1.00	3.00	0.33	15
4	MFB422	1.50	4.00	0.34	23
6	MFB622	2.00	5.00	0.36	37
8	MFB822	2.50	5.50	0.38	56
10	MFB1022	3.00	6.50	0.40	81
12	MFB1222	3.50	7.50	0.42	114
14	MFB1422	3.75	7.50	0.47	158
16	MFB1622	3.75	8.00	0.50	198
18	MFB1822	4.50	8.50	0.54	244
20	MFB2022	4.50	9.50	0.57	317
24	MFB2422	4.50	11.00	0.61	417
30	MFB3022	6.75	15.00	0.66	723
36	MFB3622	7.75	18.00	0.74	1108
42	MFB4222	9.00	21.00	0.82	1583
48	MFB4822	10.00	24.00	0.90	2156

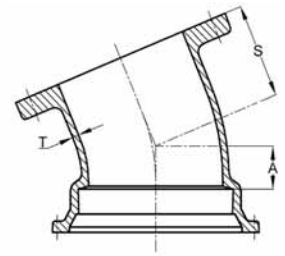

MJ x Flange 22 1/2° Bend

11 1/4° Bends: MJ X Flange

Size	Item No.	A	S	T	Wt.
3	MFB311	1.00	3.00	0.33	15
4	MFB411	1.25	4.00	0.34	23
6	MFB611	1.50	5.00	0.36	36
8	MFB811	1.75	5.50	0.38	54
10	MFB1011	2.00	6.50	0.40	78
12	MFB1211	2.25	7.50	0.42	110
14	MFB1411	2.50	7.50	0.47	148
16	MFB1611	2.50	8.00	0.50	187
18	MFB1811	3.00	8.50	0.54	229
20	MFB2011	3.00	9.50	0.57	284
24	MFB2411	3.00	11.00	0.61	395
30	MFB3011	4.75	15.00	0.66	683
36	MFB3611	5.00	18.00	0.74	1042
42	MFB4211	6.00	21.00	0.82	1528
48	MFB4811	6.50	24.00	0.90	2024

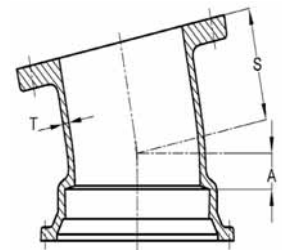

MJ x Flange 11 1/4° Bend

Adapters: MJ X Flange

Size	Item No.	L	T	Wt.
3	MFA3	3.50	0.33	18
4	MFA4	3.50	0.34	24
6	MFA6	3.50	0.36	36
8	MFA8	3.75	0.38	54
10	MFA10	3.75	0.40	70
12	MFA12	3.75	0.42	95
14	MFA14	5.00	0.47	141
16	MFA16	5.00	0.50	170
18	MFA18	5.00	0.54	225
20	MFA20	5.00	0.57	275
24	MFA24	5.00	0.61	324
30	MFA30	7.00	0.66	558
36	MFA36	7.00	0.74	796
42	MFA42	7.00	0.82	1190
48	MFA48	7.00	0.90	1653

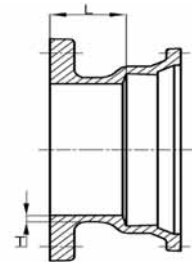

MJ x Flange Adapters

Weights in Pounds, Less Accessories / Dimensions in inches
Ductile Iron Class 350 per ANSI/AWWA C153/A21.53



Crosses

Size		Item No.	H	J	T	T1	Wt.
Run	Branch						
3	3	DMC33	3.00	3.00	0.33	0.33	35
4	3	DMC43	3.50	4.00	0.34	0.33	49
4	4	DMC44	4.00	4.00	0.34	0.34	40
6	3	DMC63	3.50	5.00	0.36	0.33	49
6	4	DMC64	4.00	5.00	0.36	0.34	68
6	6	DMC66	5.00	5.00	0.36	0.36	75
8	4	DMC84	4.00	6.50	0.38	0.34	99
8	6	DMC86	5.00	6.50	0.38	0.36	108
8	8	DMC88	6.00	6.00	0.38	0.38	105
10	3	DMC103	3.00	7.50	0.40	0.33	115
10	4	DMC104	4.00	7.50	0.40	0.34	112
10	6	DMC106	5.00	7.50	0.40	0.36	119
10	8	DMC108	6.50	7.50	0.40	0.38	138
10	10	DMC1010	7.00	7.00	0.40	0.40	145
12	4	DMC124	4.00	8.75	0.42	0.34	119
12	6	DMC126	5.00	8.75	0.42	0.36	140
12	8	DMC128	6.50	8.75	0.42	0.38	162
12	10	DMC1210	7.50	8.75	0.42	0.40	190
12	12	DMC1212	8.50	8.50	0.42	0.42	213
14	4	DMC144	5.50	10.50	0.47	0.34	162
14	6	DMC146	6.50	10.50	0.47	0.36	200
14	8	DMC148	7.50	10.50	0.47	0.38	259
14	10	DMC1410	8.50	10.50	0.47	0.40	223
14	12	DMC1412	9.50	10.50	0.47	0.42	244
14	14	DMC 1414	10.50	10.50	0.47	0.47	299
16	6	DMC166	6.50	11.50	0.50	0.36	250
16	8	DMC168	7.50	11.50	0.50	0.38	289
16	10	DMC 1610	8.50	11.50	0.50	0.40	345
16	12	DMC 1612	9.50	11.50	0.50	0.42	397
16	14	DMC1614	10.50	11.50	0.50	0.47	333
16	16	DMC 1616	11.50	11.50	0.50	0.50	385
18	6	DMC186	6.50	12.50	0.54	0.36	260
18	8	DMC188	7.50	12.50	0.54	0.38	282
18	10	DMC1810	8.50	12.50	0.54	0.40	308
18	12	DMC1812	9.50	12.50	0.54	0.42	348
18	14	DMC1814	10.50	12.50	0.54	0.47	384
18	16	DMC1816	11.50	12.50	0.54	0.50	
18	18	DMC1818	12.50	12.50	0.54	0.54	
20	6	DMC206	6.50	14.00	0.57	0.36	306
20	8	DMC208	8.00	14.00	0.57	0.38	379
20	10	DMC2010	9.00	14.00	0.57	0.40	370
20	12	DMC2012	10.00	14.00	0.57	0.42	413
20	14	DMC2014	11.00	14.00	0.57	0.47	451
20	16	DMC2016	12.00	14.00	0.57	0.50	634
20	18	DMC2018	13.00	14.00	0.57	0.54	547
20	20	DMC2020	14.00	14.00	0.57	0.57	605
24	6	DMC246	7.00	16.00	0.61	0.36	403
24	8	DMC248	8.00	16.00	0.61	0.38	481
24	10	DMC2410	9.00	16.00	0.61	0.40	465
24	12	DMC2412	10.00	16.00	0.61	0.42	529
24	14	DMC2414	11.00	16.00	0.61	0.47	553
24	16	DMC2416	12.00	16.00	0.61	0.50	714
24	18	DMC2418	13.00	16.00	0.61	0.54	
24	20	DMC2420	14.00	16.00	0.61	0.57	1589
24	24	DMC2424	16.00	16.00	0.61	0.61	
30	6	DMC306	8.50	20.00	0.66	0.36	
30	8	DMC308	8.50	20.00	0.66	0.38	
30	12	DMC3012	10.00	20.00	0.66	0.42	882
30	16	DMC3016	12.50	20.00	0.66	0.50	866

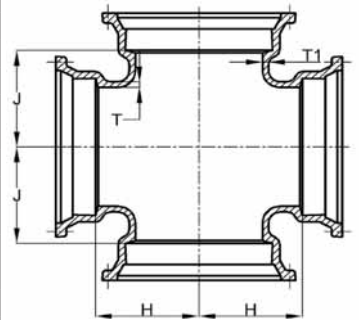

MJ Cross

 Weights in Pounds, Less Accessories / Dimensions in inches
 Ductile Iron Class 350 per ANSI/AWWA C153/A21.53

C153 Mechanical Joint Compact Fittings

Crosses (continued)

Size		Item No.	H	J	T	T1	Wt.
Run	Branch						
30	20	DMC3020	15.00	20.00	0.66	0.57	991
30	24	DMC3024	16.00	20.00	0.66	0.61	1246
30	30	DMC3030	22.00	22.00	0.66	0.66	1840
36	24	DMC3624	16.00	23.50	0.74	0.61	1785
36	30	DMC3630	20.00	23.50	0.74	0.66	
36	36	DMC3636	26.00	26.00	0.74	0.74	2655
42	12	DMC4212	12.50	27.50	0.82	0.42	
42	16	DMC4216	13.00	27.50	0.82	0.50	
42	24	DMC4224	20.00	27.50	0.82	0.61	2668
42	30	DMC4230	22.00	29.50	0.82	0.66	2950
42	36	DMC4236	30.00	30.00	0.82	0.74	3955
42	42	DMC4242	30.00	30.00	0.82	0.82	3725
48	12	DMC4812	12.50	32.00	0.90	0.42	1897
48	16	DMC4816	23.00	32.00	0.90	0.50	2617
48	24	DMC4824	23.00	32.00	0.90	0.61	2766
48	30	DMC4830	23.00	32.00	0.90	0.66	4500
48	36	DMC4836	33.50	32.25	0.90	0.74	3719
48	42	DMC4842	33.5	33.5	0.90	0.82	4590
48	48	DMC4848	33.5	33.5	0.90	0.90	4955

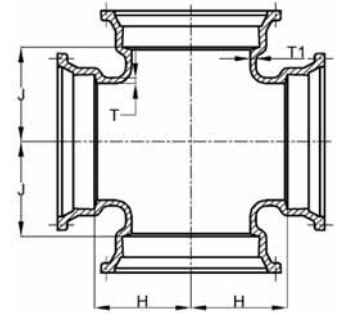

MJ Cross

Tees

SIZE		MJ x MJ						MJ x Flange			
Run	Branch	Item No.	Wt.	H	J	T	T1	Item No.	Wt.	H	L
2	2	DMT22	16	3.00	3.00	0.30	0.30				
3	3	DMT33	28	3.00	3.00	0.33	0.33	DMF33	28	3.00	5.50
4	2	DMT42	29	3.50	4.00	0.34	0.30				
4	3	DMT43	30	3.50	4.00	0.34	0.33	DMF43	30	3.50	6.50
4	4	DMT44	32	4.00	4.00	0.34	0.34	DMF44	38	4.00	6.50
6	3	DMT63	42	3.50	5.00	0.36	0.33	DMF63	51	3.50	8.00
6	4	DMT64	46	4.00	5.00	0.36	0.34	DMF64	54	4.00	8.00
6	6	DMT66	56	5.00	5.00	0.36	0.36	DMF66	56	5.00	8.00
8	3	DMT83	52	4.00	6.50	0.38	0.33	DMF83	70	4.00	9.00
8	4	DMT84	60	4.00	6.50	0.38	0.34	DMF84	72	4.00	9.00
8	6	DMT86	72	5.00	6.50	0.38	0.36	DMF86	83	5.00	9.00
8	8	DMT88	86	6.50	6.50	0.38	0.38	DMF88	94	6.50	9.00
10	3	DMT103	75	4.00	7.50	0.40	0.33				
10	4	DMT104	78	4.00	7.50	0.40	0.34	DMF104	89	4.00	11.00
10	6	DMT106	90	5.00	7.50	0.40	0.36	DMF106	107	5.00	11.00
10	8	DMT108	105	6.50	7.50	0.40	0.38	DMF108	115	6.50	11.00
10	10	DMT1010	120	7.50	7.50	0.40	0.40	DMF1010	130	7.50	11.00
12	3	DMT123	90	4.00	8.75	0.42	0.33				
12	4	DMT124	94	4.00	8.75	0.42	0.34	DMF124	115	4.00	12.00
12	6	DMT126	110	5.00	8.75	0.42	0.36	DMF126	120	5.00	12.00
12	8	DMT128	125	6.50	8.75	0.42	0.38	DMF128	146	6.50	12.00
12	10	DMT1210	140	7.50	8.75	0.42	0.40	DMF1210	174	7.50	12.00
12	12	DMT1212	160	8.75	8.75	0.42	0.42	DMF1212	198	8.75	12.00
14	3	DMT143		5.50	10.50	0.47	0.33				
14	4	DMT144	172	5.50	10.50	0.47	0.34	DMF144	161	5.50	14.00
14	6	DMT146	182	6.50	10.50	0.47	0.36	DMF146	177	6.50	14.00
14	8	DMT148	206	7.50	10.50	0.47	0.38	DMF148	199	7.50	14.00
14	10	DMT1410	228	8.50	10.50	0.47	0.40	DMF1410		8.50	14.00
14	12	DMT1412	234	9.50	10.50	0.47	0.42	DMF1412		9.50	14.00
14	14	DMT1414	280	10.50	10.50	0.47	0.47	DMF1414	277	10.50	14.00
16	3	DMT163		6.50	11.50	0.50	0.33				
16	4	DMT164	250	6.50	11.50	0.50	0.34				
16	6	DMT166	228	6.50	11.50	0.50	0.36	DMF166	213	6.50	15.00
16	8	DMT168	248	7.50	11.50	0.50	0.38	DMF168	260	7.50	15.00

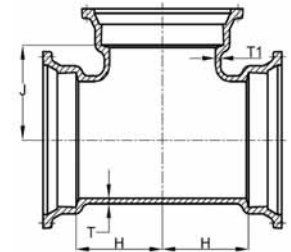

MJ x MJ

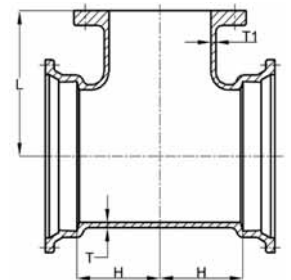

MJ x Flange

Weights in Pounds, Less Accessories / Dimensions in inches
Ductile Iron Class 350 per ANSI/AWWA C153/A21.53



Tees (continued)

SIZE		MJ x MJ						MJ x Flange			
Run	Branch	Item No.	Wt.	H	J	T	T1	Item No.	Wt.	H	L
16	10	DMT1610	264	8.50	11.50	0.50	0.40	DMF1610	287	8.50	15.00
16	12	DMT1612	280	9.50	11.50	0.50	0.42	DMF1612	312	9.50	15.00
16	14	DMT1614	316	10.50	11.50	0.50	0.47	DMF1614		10.50	15.00
16	16	DMT1616	322	11.50	11.50	0.50	0.50	DMF1616		11.50	15.00
18	6	DMT186	275	6.50	12.50	0.54	0.36	DMF186	261	6.50	15.50
18	8	DMT188	295	7.50	12.50	0.54	0.38	DMF188		7.50	15.50
18	10	DMT1810	315	8.50	12.50	0.54	0.40	DMF1810		8.50	15.50
18	12	DMT1812	335	9.50	12.50	0.54	0.42	DMF1812		9.50	15.50
18	14	DMT1814	380	10.50	12.50	0.54	0.47	DMF1814		10.50	16.50
18	16	DMT1816	405	11.50	12.50	0.54	0.50	DMF1816		11.50	16.50
18	18	DMT1818	435	12.50	12.50	0.54	0.54	DMF1818		12.50	16.50
20	6	DMT206	315	6.50	14.00	0.57	0.36	DMF206	345	6.50	17.00
20	8	DMT208	345	8.00	14.00	0.57	0.38	DMF208	384	8.00	17.00
20	10	DMT2010	370	9.00	14.00	0.57	0.40	DMF2010	367	9.00	17.00
20	12	DMT2012	395	10.00	14.00	0.57	0.42	DMF2012	402	10.00	17.00
20	14	DMT2014	440	11.00	14.00	0.57	0.47	DMF2014	435	11.00	17.00
20	16	DMT2016	465	12.00	14.00	0.57	0.50	DMF2016	477	12.00	18.00
20	18	DMT2018	505	13.00	14.00	0.57	0.54	DMF2018	507	13.00	18.00
20	20	DMT2020	535	14.00	14.00	0.57	0.57	DMF2020	554	14.00	18.00
24	6	DMT246	415	7.00	16.00	0.61	0.36	DMF246	460	7.00	19.00
24	8	DMT248	445	8.00	16.00	0.61	0.38	DMF248	418	8.00	19.00
24	10	DMT2410	470	9.00	16.00	0.61	0.40	DMF2410	462	9.00	19.00
24	12	DMT2412	500	10.00	16.00	0.61	0.42	DMF2412	502	10.00	19.00
24	14	DMT2414	550	11.00	16.00	0.61	0.47	DMF2414	539	11.00	19.00
24	16	DMT2416	580	12.00	16.00	0.61	0.50	DMF2416	579	12.00	19.00
24	18	DMT2418	625	13.00	16.00	0.61	0.54	DMF2418	634	13.00	22.00
24	20	DMT2420	660	14.00	16.00	0.61	0.57	DMF2420	686	14.00	22.00
24	24	DMT2424	720	16.00	16.00	0.61	0.61	DMF2424	789	16.00	22.00
30	6	DMT306	700	8.50	20.00	0.66	0.36	DMF306		8.50	23.00
30	8	DMT308	739	8.50	20.00	0.66	0.38	DMF308		8.50	23.00
30	10	DMT3010	785	10.00	20.00	0.66	0.40				
30	12	DMT3012	830	10.00	20.00	0.66	0.42	DMF3012		10.00	23.00
30	16	DMT3016	959	12.50	20.00	0.66	0.50	DMF3016		12.50	23.00
30	18	DMT3018	1085	13.00	20.00	0.66	0.54				
30	20	DMT3020	995	15.00	20.00	0.66	0.57	DMF3020		15.00	23.00
30	24	DMT3024	1060	16.00	20.00	0.66	0.61	DMF3024		16.00	25.00
30	30	DMT3030	1323	20.00	20.00	0.66	0.66	DMF3030	1267	20.00	25.00
36	6	DMT366	1045	8.00	23.50	0.74	0.36				
36	8	DMT368	1095	9.00	23.50	0.74	0.38				
36	10	DMT3610	1184	10.00	23.50	0.74	0.40				
36	12	DMT3612	1205	10.00	23.50	0.74	0.42	DMF3612	1034	10.00	26.00
36	14	DMT3614	1112	12.50	23.50	0.74	0.47				
36	16	DMT3616	1385	12.50	23.50	0.74	0.50				
36	18	DMT3618	1455	13.00	23.50	0.74	0.54	DMF3618	1307	16.00	26.00
36	20	DMT3620	1631	15.00	23.50	0.74	0.57				
36	24	DMT3624	1498	16.00	23.50	0.74	0.61	DMF3624		16.00	26.00
36	30	DMT3630	1555	20.00	23.50	0.74	0.66	DMF3630		20.00	28.00
36	36	DMT3636	1900	23.50	23.50	0.74	0.74	DMF3636	1924	23.50	28.00
42	6	DMT426	1534	10.00	27.50	0.82	0.36				
42	8	DMT428	1347	10.00	27.50	0.82	0.38				

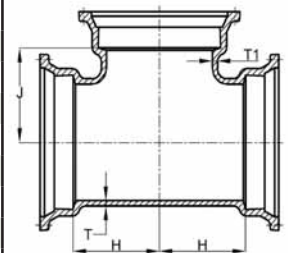

MJ x MJ

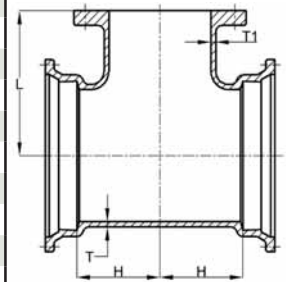

MJ x Flange



Weights in Pounds, Less Accessories / Dimensions in inches
Ductile Iron Class 350 per ANSI/AWWA C153/A21.53

C153 Mechanical Joint Compact Fittings

Tees (continued)

SIZE		MJ x MJ						MJ x Flange			
Run	Branch	Item No.	Wt.	H	J	T	T1	Item No.	Wt.	H	L
42	12	DMT4212	1885	10.00	27.50	0.82	0.42				
42	16	DMT4216	1929	12.50	27.50	0.82	0.50				
42	18	DMT4218	2072	16.00	27.50	0.82	0.54				
42	20	DMT4220	2433	20.00	27.50	0.82	0.57				
42	24	DMT4224	2270	20.00	27.50	0.82	0.61	DMF4224		20.00	30.00
42	30	DMT4230	2425	22.00	29.50	0.82	0.66	DMF4230		22.00	31.00
42	36	DMT4236	3000	30.00	30.00	0.82	0.74	DMF4236	2765	30.00	31.00
42	42	DMT4242	3175	30.00	30.00	0.82	0.82	DMF4242		30.00	31.00
48	6	DMT486	1949	10.00	32.00	0.90	0.36				
48	8	DMT488		10.00	32.00	0.90	0.38				
48	12	DMT4812	2535	15.00	32.00	0.90	0.42				
48	16	DMT4816	2657	20.00	32.00	0.90	0.50				
48	18	DMT4818		16.00	32.00	0.90	0.54				
48	20	DMT4820		20.00	32.00	0.90	0.57				
48	24	DMT4824	2870	23.00	32.00	0.90	0.61	DMF4824		23.00	34.00
48	30	DMT4830	3050	23.00	32.00	0.90	0.66	DMF4830	2762	23.00	34.00
48	36	DMT4836	3900	33.50	32.25	0.90	0.74	DMF4836	3594	33.50	34.00
48	42	DMT4842	4100	33.50	33.50	0.90	0.82	DMF4842	3739	33.50	34.00
48	48	DMT4848	4250	33.50	33.50	0.90	0.90	DMF4848	3878	33.50	34.00

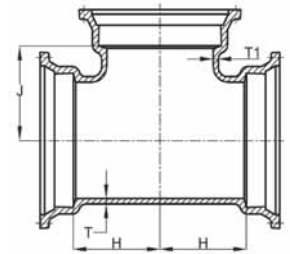

MJ x MJ

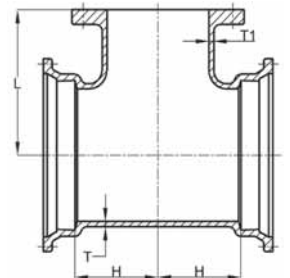

MJ x Flange

Tapped Tees and Crosses

Size	TEE		CROSS		T	L	Tap Size
	Item No.	Wt.	Item No.	Wt.			
3	DTT3	19	DTC3	19	0.33	6.00	2
4	DTT4	24	DTC4	23	0.34	6.00	2
6	DTT6	42	DTC6	37	0.36	6.00	2
8	DTT8	53	DTC8	53	0.38	6.00	2
10	DTT10	68	DTC10	68	0.40	6.00	2
12	DTT12	88	DTC12	88	0.42	6.00	2
14	DTT14	118	DTC14	119	0.47	8.00	2
16	DTT16	164	DTC16	202	0.50	8.00	2
18	DTT18	205	DTC18	206	0.54	8.00	2
20	DTT20	259	DTC20	259	0.57	8.00	2
24	DTT24	320	DTC24	320	0.61	8.00	2

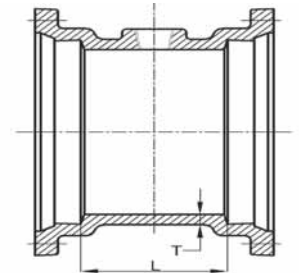

Tapped Tee

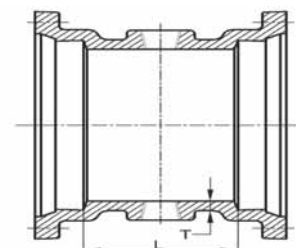

Tapped Cross

Weights in Pounds, Less Accessories / Dimensions in inches
Ductile Iron Class 350 per ANSI/AWWA C153/A21.53



Caps and Plugs

Size	CAP SOLID	CAP TAPPED	Wt.	PLUG SOLID	PLUG TAPPED	Wt.
	Item No.	Item No.		Item No.	Item No.	
2	DMK2					
3	DMK3	DTK3	8	DMP3	DTP3	8
4	DMK4	DTK4	9	DMP4	DTP4	10
6	DMK6	DTK6	15	DMP6	DTP6	16
8	DMK8	DTK8	22	DMP8	DTP8	26
10	DMK10	DTK10	32	DMP10	DTP10	36
12	DMK12	DTK12	42	DMP12	DTP12	46
14	DMK14	DTK14	66	DMP14	DTP14	75
16	DMK16	DTK16	92	DMP16	DTP16	95
18	DMK18	DTK18	114	DMP18	DTP18	121
20	DMK20	DTK20	125	DMP20	DTP20	135
24	DMK24	DTK24	166	DMP24	DTP24	175
30	DMK30	DTK30	345	DMP30	DTP30	355
36	DMK36	DTK36	628	DMP36	DTP36	688
42	DMK42	DTK42	665	DMP42	DTP42	815
48	DMK48	DTK48	901	DMP48	DTP48	1085

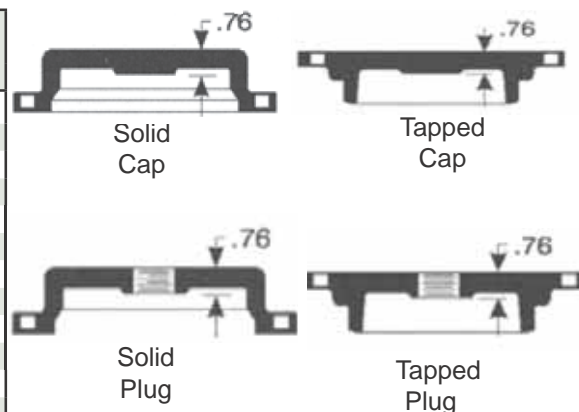

Wyes 45° laterals

Size		Item No.	X	Y	P	T	T1	Wt.
Run	Branch							
3	3	DMY33	2.00	8.50	8.50	0.33	0.33	36
4	2	DMY42	2.00	8.50	8.50	0.34	0.30	39
4	3	DMY43	2.50	9.50	9.50	0.34	0.33	
4	4	DMY44	2.50	9.50	9.50	0.34	0.34	45
6	4	DMY64	1.50	11.00	11.00	0.36	0.34	67
6	6	DMY66	3.00	13.00	13.00	0.36	0.36	93
8	3	DMY83	0.50	13.00	13.00	0.38	0.33	
8	4	DMY84	0.50	13.00	13.00	0.38	0.34	93
8	6	DMY86	2.00	14.50	14.50	0.38	0.36	113
8	8	DMY88	3.50	16.00	16.00	0.38	0.38	136
10	3	DMY103	0.00	15.00	15.00	0.40	0.33	
10	4	DMY104	0.00	15.00	15.00	0.40	0.34	118
10	6	DMY106	1.00	16.00	16.00	0.40	0.36	136
10	8	DMY108	2.50	17.00	17.00	0.40	0.38	170
10	10	DMY1010	3.50	19.00	19.00	0.40	0.40	199
12	3	DMY123	0.00	16.50	16.50	0.42	0.33	
12	4	DMY124	0.00	16.50	16.50	0.42	0.34	150
12	6	DMY126	1.50	18.50	18.50	0.42	0.36	186
12	8	DMY128	1.50	18.50	18.50	0.42	0.38	188
12	10	DMY1210	3.00	20.00	20.00	0.42	0.40	223
12	12	DMY1212	4.50	22.50	22.50	0.42	0.42	272
14	6	DMY146	0.00	19.00	21.50	0.47	0.36	
14	8	DMY148	1.50	20.00	22.50	0.47	0.38	230
14	10	DMY1410	4.00	25.00	25.00	0.47	0.40	
14	12	DMY1412	5.00	25.00	25.00	0.47	0.42	
14	14	DMY1414	6.00	25.00	25.00	0.47	0.47	
16	6	DMY166	0.00	21.50	24.00	0.50	0.36	
16	8	DMY168	1.50	23.00	25.00	0.50	0.38	
16	10	DMY1610	6.50	28.00	28.00	0.50	0.40	
16	12	DMY1612	6.50	28.00	28.00	0.50	0.42	
16	14	DMY1614	6.50	28.00	28.00	0.50	0.47	
16	16	DMY1616	6.50	28.00	28.00	0.50	0.50	
18	4	DMY184	0.00	23.00	25.50	0.54	0.34	
18	6	DMY186	0.00	23.00	25.50	0.54	0.36	348
18	8	DMY188	1.50	25.00	27.50	0.54	0.38	380
18	10	DMY1810	4.50	30.00	30.00	0.54	0.40	
18	12	DMY1812	4.50	30.00	30.00	0.54	0.42	479

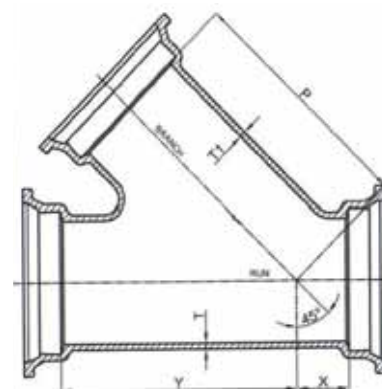

Wyes Lateral 45°



Weights in Pounds, Less Accessories / Dimensions in inches
Ductile Iron Class 350 per ANSI/AWWA C153/A21.53

C153 Mechanical Joint Compact Fittings

Wyes 45° laterals (continued)

Size		Item No.	X	Y	P	T	T1	Wt.
Run	Branch							
18	14	DMY1814	4.50	30.00	30.00	0.54	0.47	
18	16	DMY1816	4.50	30.00	30.00	0.54	0.50	
18	18	DMY1818	6.50	30.00	30.00	0.54	0.54	
20	6	DMY206	0.00	25.00	27.50	0.57	0.36	
20	8	DMY208	1.50	25.00	27.50	0.57	0.38	
20	10	DMY2010	3.00	28.00	30.00	0.57	0.40	
20	12	DMY2012	6.50	32.00	32.00	0.57	0.42	588
20	14	DMY2014	6.50	32.00	32.00	0.57	0.47	
20	16	DMY2016	6.50	32.00	32.00	0.57	0.50	
20	18	DMY2018	6.50	32.00	32.00	0.57	0.54	
20	20	DMY2020	8.00	33.00	33.00	0.57	0.57	747
24	6	DMY246	0.00	29.50	32.50	0.61	0.36	
24	8	DMY248	0.00	29.50	32.50	0.61	0.38	
24	10	DMY2410	1.50	32.00	34.50	0.61	0.40	
24	12	DMY2412	3.00	32.00	34.50	0.61	0.42	
24	14	DMY2414	4.50	33.00	34.50	0.61	0.47	
24	16	DMY2416	5.50	35.00	35.00	0.61	0.50	
24	18	DMY2418	7.00	36.00	36.00	0.61	0.54	
24	20	DMY2420	9.00	38.50	38.50	0.61	0.57	
24	24	DMY2424	9.00	38.50	38.50	0.61	0.61	1061
30	4	DMY304	2.00	30.00	35.00	0.66	0.34	
30	6	DMY306	4.00	45.00	50.00	0.66	0.36	
30	8	DMY308	4.00	40.00	40.00	0.66	0.38	
30	12	DMY3012	5.00	40.00	44.00	0.66	0.42	
30	14	DMY3014	7.00	42.00	44.00	0.66	0.47	
30	16	DMY3016	7.00	44.00	44.00	0.66	0.50	
30	18	DMY3018	8.00	46.00	46.00	0.66	0.54	
30	20	DMY3020	10.00	47.00	47.00	0.66	0.57	1531
30	24	DMY3024	10.00	47.00	47.00	0.66	0.61	
30	30	DMY3030	10.00	50.00	50.00	0.66	0.66	
36	10	DMY3610	5.00	42.50	46.00	0.74	0.40	1601
36	12	DMY3612	5.00	42.50	46.00	0.74	0.42	
36	14	DMY3614	5.00	42.50	46.00	0.74	0.47	
36	16	DMY3616	5.00	42.50	46.00	0.74	0.50	
36	18	DMY3618	8.00	45.00	48.00	0.74	0.54	
36	20	DMY3620	10.00	48.50	50.00	0.74	0.57	
36	24	DMY3624	12.50	52.00	52.00	0.74	0.61	
36	30	DMY3630	15.00	54.00	54.00	0.74	0.66	
36	36	DMY3636	15.00	57.50	57.50	0.74	0.74	
42	8	DMY428	0.00	48.00	56.00	0.82	0.38	
42	20	DMY4220	8.00	58.00	58.00	0.82	0.57	
42	24	DMY4224	10.00	58.00	58.00	0.82	0.61	
42	30	DMY4230	12.00	60.00	60.00	0.82	0.66	
42	36	DMY4236	12.00	64.00	64.00	0.82	0.74	
42	42	DMY4242	15.00	68.00	68.00	0.82	0.82	
48	6	DMY486	0.00	50.00	58.00	0.90	0.36	
48	8	DMY486	0.00	50.00	58.00	0.90	0.38	
48	16	DMY4816	0.00	52.00	58.00	0.90	0.50	
48	20	DMY4820	0.00	52.00	58.00	0.90	0.57	
48	24	DMY4824	5.00	56.00	62.00	0.90	0.61	
48	30	DMY4830	4.00	57.00	62.00	0.90	0.66	
48	36	DMY4836	5.00	62.00	66.00	0.90	0.74	
48	42	DMY4842	12.00	75.00	75.00	0.90	0.82	
48	48	DMY4848	16.00	75.00	75.00	0.90	0.90	

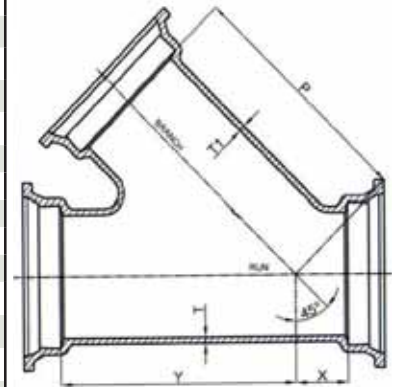

Wyes Lateral 45°

Weights in Pounds, Less Accessories / Dimensions in inches
Ductile Iron Class 350 per ANSI/AWWA C153/A21.53



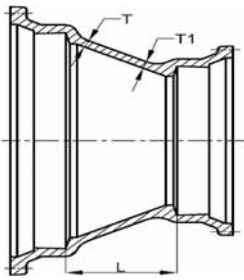

MJ x MJ

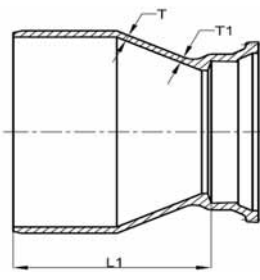

PE x MJ (small end MJ)

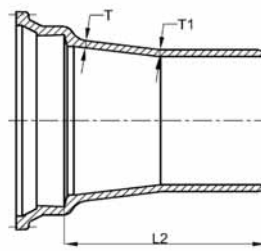

MJ x PE (large end MJ)

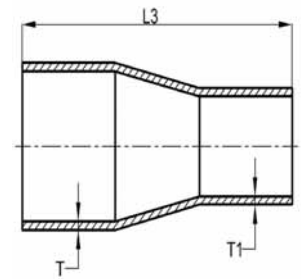

PE x PE

Reducers

Size	MJ x MJ			PE x MJ (Small End MJ)			MJ X PE (Large End MJ)			PE x PE				
	Item No.	Wt.	L	Item No.	Wt.	L1	Item No.	Wt.	L2	Item No.	Wt.	L3	T	T1
3 x 2	DMR32	14	2.50										0.33	0.30
4 x 2	DMR42	16	2.50	SPR42	14	8.00							0.34	0.30
4 x 3	DMR43	18	3.00	SPR43	17	8.50	LPR43	18	8.50	PPR43	14	14.00	0.34	0.33
6 x 3	DMR63	22	5.00	SPR63	24	10.50	LPR63	19	10.50	PPR63	19	16.00	0.36	0.33
6 x 4	DMR64	24	4.00	SPR64	25	9.50	LPR64	25	9.50	PPR64	22	15.00	0.36	0.34
8 x 3	DMR83		5.00										0.38	0.33
8 x 4	DMR84	32	5.00	SPR84	30	10.50	LPR84	34	10.50	PPR84	30	16.00	0.38	0.34
8 x 6	DMR86	36	4.00	SPR86	35	9.50	LPR86	32	9.50	PPR86	30	15.00	0.38	0.36
10 x 4	DMR104	46	7.00	SPR104	43	12.50	LPR104	43	12.50	PPR104	46	18.00	0.40	0.34
10 x 6	DMR106	47	5.00	SPR106	46	10.50	LPR106	42	10.50	PPR106	46	16.00	0.40	0.36
10 x 8	DMR108	50	4.00	SPR108	42	9.50	LPR108	50	9.50	PPR108	47	15.00	0.40	0.38
12 x 4	DMR124	58	9.00	SPR124	60	14.50	LPR124	60	14.50	PPR124	58	20.00	0.42	0.34
12 x 6	DMR126	58	7.00	SPR126	58	12.50	LPR126	58	12.50	PPR126	57	18.00	0.42	0.36
12 x 8	DMR128	57	5.00	SPR128	54	10.50	LPR128	55	10.50	PPR128	54	16.00	0.42	0.38
12 x 10	DMR1210	61	4.00	SPR1210	59	9.50	LPR1210	59	9.50	PPR1210	54	15.00	0.42	0.40
14 x 6	DMR146	100	9.00	SPR146	100	16.90	LPR146	104	14.50	PPR146	93	22.30	0.47	0.36
14 x 8	DMR148	100	7.00	SPR148	98	14.90	LPR148	98	12.40	PPR148	94	20.30	0.47	0.38
14 x 10	DMR1410	100	5.00	SPR1410	94	12.90	LPR1410	92	10.40	PPR1410	90	18.30	0.47	0.40
14 x 12	DMR1412	100	4.00	SPR1412	90	11.90	LPR1412	92	9.40	PPR1412	88	17.30	0.47	0.42
16 x 6	DMR166	124	11.00	SPR166	125	18.90	LPR166	136	16.50	PPR166	93	24.30	0.50	0.36
16 x 8	DMR168	124	9.00	SPR168	121	16.90	LPR168	128	14.40	PPR168	119	22.30	0.50	0.38
16 x 10	DMR1610	124	7.00	SPR1610	105	15.00	LPR1610	123	12.50	PPR1610	119	20.50	0.50	0.40
16 x 12	DMR1612	112	5.00	SPR1612	109	12.90	LPR1612	108	10.50	PPR1612	99	18.30	0.50	0.42
16 x 14	DMR1614	140	4.00	SPR1614	126	12.00	LPR1614	132	12.00	PPR1614	129	19.70	0.50	0.47
18 x 4	DMR184		11.00										0.54	0.34
18 x 6	DMR186	194	13.00										0.54	0.36
18 x 8	DMR188	190	13.00	SPR188	170	20.00	LPR188	195	19.50	PPR188	170	27.40	0.54	0.38
18 x 10	DMR1810	195	10.00	SPR1810	165	18.00	LPR1810	185	17.40	PPR1810	160	25.50	0.54	0.40
18 x 12	DMR1812	180	7.00	SPR1812	150	15.50	LPR1812	175	14.00	PPR1812	150	19.50	0.54	0.42
18 x 14	DMR1814	190	6.00	SPR1814	175	15.00	LPR1814	190	15.00	PPR1814	160	23.00	0.54	0.47
18 x 16	DMR1816	195	5.00	SPR1816	170	12.50	LPR1816	190	12.50	PPR1816	145	18.00	0.54	0.50
20 x 6	DMR206	232	16.00	SPR206	201	22.00	LPR206	231	19.00	PPR206	106	27.50	0.57	0.36
20 x 8	DMR208	227	16.00	SPR208	198	27.00	LPR208	227	19.00	PPR208	106	27.50	0.57	0.38
20 x 10	DMR2010	220	14.00	SPR2010	200	22.00	LPR2010	210	19.00	PPR2010	180	27.50	0.57	0.40
20 x 12	DMR2012	205	12.00	SPR2012	170	17.50	LPR2012	205	16.00	PPR2012	190	21.50	0.57	0.42
20 x 14	DMR2014	200	10.00	SPR2014	190	18.00	LPR2014	205	17.90	PPR2014	195	26.00	0.57	0.47
20 x 16	DMR2016	200	7.00	SPR2016	185	13.50	LPR2016	200	13.50	PPR2016	170	19.00	0.57	0.50
20 x 18	DMR2018	225	4.00	SPR2018	200	12.00	LPR2018	215	12.00	PPR2018	190	20.00	0.57	0.54
24 x 6	DMR246	322	18.00	SPR246	284	21.50	LPR246	320	21.00	PPR246	283	22.50	0.61	0.36
24 x 8	DMR248	318	16.00	SPR248	282	21.50	LPR248	316	21.00	PPR248	281	22.50	0.61	0.38
24 x 10	DMR2410	312	16.00	SPR2410	276	21.50	LPR2410	310	21.00	PPR2410	274	22.50	0.61	0.40
24 x 12	DMR2412	305	16.00	SPR2412	275	21.50	LPR2412	290	21.00	PPR2412	240	22.50	0.61	0.42
24 x 14	DMR2414	310	14.00	SPR2414	310	22.00	LPR2414	315	21.90	PPR2414	295	25.00	0.61	0.47
24 x 16	DMR2416	320	12.00	SPR2416	285	17.50	LPR2416	285	17.50	PPR2416	285	23.00	0.61	0.50
24 x 18	DMR2418	305	10.00	SPR2418	300	18.00	LPR2418	310	18.00	PPR2418	290	21.00	0.61	0.54
24 x 20	DMR2420	300	7.00	SPR2420	270	13.50	LPR2420	275	13.50	PPR2420	240	14.00	0.61	0.57
30 x 12	DMR3012	705	30.00										0.66	0.42

Weights in Pounds, Less Accessories / Dimensions in inches
Ductile Iron Class 350 per ANSI/AWWA C153/A21.53



C153 Mechanical Joint Compact Fittings

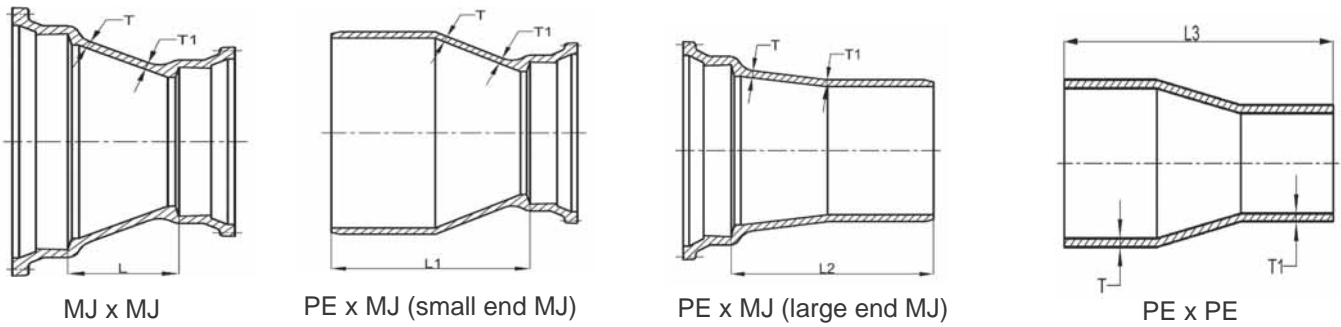

Reducers (continued)

Size	MJ x MJ			PE x MJ (Small End MJ)			MJ X PE (Large End MJ)			PE x PE				
	Item No.	Wt.	L	Item No.	Wt.	L1	Item No.	Wt.	L2	Item No.	Wt.	L3	T	T1
30 x 16	DMR3016	633	30.00	SPR3016	565	39.00	LPR3016	623	39.00	PPR3016	555	48.00	0.66	0.50
30 x 18	DMR3018	658	28.00	SPR3018	590	37.00	LPR3018	635	37.00	PPR3018	567	46.00	0.66	0.54
30 x 20	DMR3020	628	24.00	SPR3020	560	33.00	LPR3020	603	33.00	PPR3020	535	42.00	0.60	0.57
30 x 24	DMR3024	478	10.00	SPR3024	495	24.50	LPR3024	526	24.50	PPR3024	458	33.50	0.66	0.61
36 x 12	DMR3612	1058	30.00										0.74	0.42
36 x 16	DMR3616	1078	30.00										0.74	0.50
36 x 18	DMR3618	983	36.00										0.74	0.54
36 x 20	DMR3620	975	36.00	SPR3620	874	45.00	LPR3620	950	45.00	PPR3620	849	54.00	0.74	0.57
36 x 24	DMR3624	770	19.00	SPR3624	746	33.00	LPR3624	810	33.00	PPR3624	709	42.00	0.74	0.61
36 x 30	DMR3630	758	15.50	SPR3630	725	24.50	LPR3630	758	24.50	PPR3630	657	33.50	0.74	0.66
42 x 20	DMR4220		40.00										0.82	0.57
42 x 24	DMR4224	1356	40.00	SPR4224	1204	49.00	LPR4224	1319	49.00	PPR4224	1167	58.00	0.82	0.61
42 x 30	DMR4230	1083	20.00	SPR4230	931	29.00	LPR4230	1015	29.00	PPR4230	863	38.00	0.82	0.66
42 x 36	DMR4236	1114	15.50	SPR4236	962	24.50	LPR4236	1013	24.50	PPR4236	861	33.50	0.82	0.74
48 x 20	DMR4820	1462	40.00										0.90	0.57
48 x 24	DMR4824	1761	40.00										0.90	0.61
48 x 30	DMR4830	1779	40.00	SPR4830	1594	49.00	LPR4830	1711	49.00	PPR4830	1526	58.00	0.90	0.66
48 x 36	DMR4836	1641	28.00	SPR4836	1456	37.00	LPR4836	1540	37.00	PPR4836	1355	46.00	0.90	0.74
48 x 42	DMR4842	1426	15.50	SPR4842	1241	24.50	LPR4842	1274	24.50	PPR4842	1089	33.50	0.90	0.82

Tees: MJ x Swivel (Hydrant Tees)

Size	Item No.	H	S	T	T1	Wt.
6 x 4	DMH64	4.00	10.00	0.36	0.34	
6 x 6	DMH66	5.00	10.00	0.36	0.36	77
8 x 6	DMH86	5.00	11.00	0.38	0.36	89
8 x 8	DMH88	6.50	11.00	0.38	0.38	116
10 x 4	DMH104	4.00	12.50	0.40	0.34	
10 x 6	DMH106	5.00	12.50	0.40	0.36	113
10 x 8	DMH108	6.50	12.50	0.40	0.38	129
12 x 4	DMH124	4.00	13.50	0.42	0.34	
12 x 6	DMH126	5.00	13.50	0.42	0.36	128
12 x 8	DMH128	6.50	13.50	0.42	0.38	149
12 x 12	DMH1212	8.75	13.50	0.42	0.42	
14 x 6	DMH146	6.50	15.00	0.47	0.36	211
14 x 8	DMH148	7.50	15.00	0.47	0.38	182
16 x 6	DMH166	6.50	16.00	0.50	0.36	248
16 x 8	DMH168	7.50	16.00	0.50	0.38	298
18 x 6	DMH186	6.50	17.00	0.54	0.36	300
18 x 8	DMH188	7.50	17.00	0.54	0.38	272
20 x 6	DMH206	6.50	18.50	0.57	0.36	358
20 x 8	DMH208	8.00	18.50	0.57	0.38	382
24 x 6	DMH246	7.00	19.00	0.61	0.36	458
24 x 8	DMH248	8.00	19.00	0.61	0.38	477
30 x 6	DMH306	7.50	24.50	0.66	0.36	
36 x 6	DMH366	8.00	27.50	0.74	0.36	891
36 x 8	DMH368	9.00	27.50	0.74	0.38	936

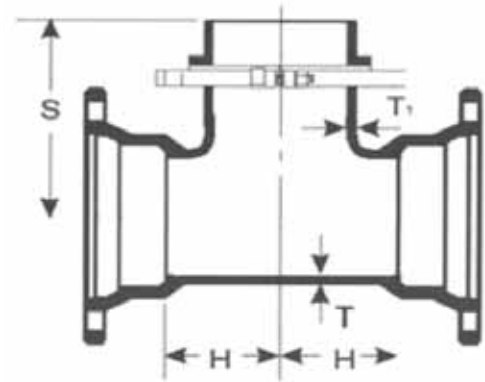

MJ x Swivel Tee

Weights in Pounds, Less Accessories / Dimensions in inches
Ductile Iron Class 350 per ANSI/AWWA C153/A21.53



Swivel x Solid Adapter

Size	Item No.	L	T	Wt.
4	SSA413	13.00	0.34	29
6	SSA613	13.00	0.36	47
6	SSA618	18.00	0.36	58
6	SSA624	24.00	0.36	69
6	SSA630	30.00	0.36	66
6	SSA636	36.00	0.36	75
6	SSA648	48.00	0.36	94
6	SSA660	60.00	0.36	112
6	SSA672	72.00	0.36	131
8	SSA813	13.00	0.38	52
10	SSA1013	13.00	0.40	69
12	SSA1213	13.00	0.42	87

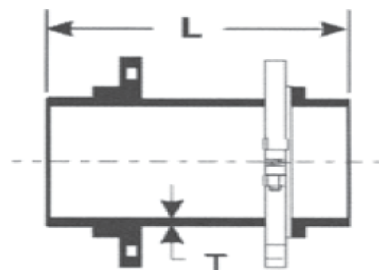

Swivel x Solid Adapter

Swivel Gland

Size	Item No.	Wt.
4	HR4	8
6	HR6	18
8	HR8	15
10	HR10	18
12	HR12	24

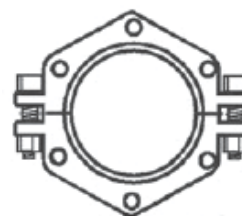

Swivel Gland

Dual Purpose Sleeves

Item No.	L1	T	Wt.
DDL4	32	12	0.52
DDL6	50	12	0.55
DDL8	65	12	0.60
DDL10	89	12	0.63
DDL12	104	12	0.68

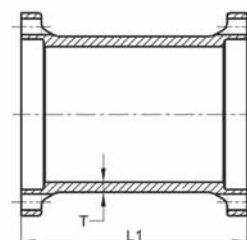

Dual Purpose Sleeves

Swivel x Solid 90° Bend

Size	Item No.	A	B	T	Wt.
3	SSB3	8.50	13.00	0.33	
4	SSB4	9.50	14.00	0.34	
6	SSB6	10.50	16.00	0.36	52
8	SSB8	12.50	18.00	0.38	74
10	SSB10	13.00	20.00	0.40	102
12	SSB12	14.50	22.00	0.42	
14	SSB14	19.50	24.00	0.47	
16	SSB16	20.50	26.00	0.50	
18	SSB18	21.00	28.00	0.54	
20	SSB20	22.50	30.00	0.57	
24	SSB24	25.00	34.00	0.61	
30	SSB30	30.50	40.00	0.66	
36	SSB36	33.50	46.00	0.74	
42	SSB42	38.25	52.00	0.82	
48	SSB48	42.25	58.00	0.90	

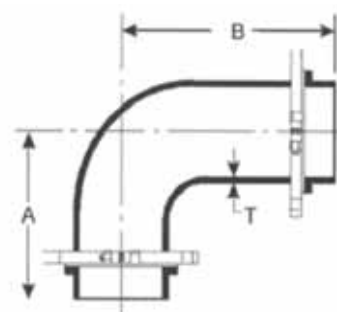

Swivel x Solid 90° Bend



C153 Mechanical Joint Compact Fittings

Offsets

MJ x MJ Size	Item No.	Wt.	D	L	L1	T	MJ x PE	Wt.
							Item No.	
3 x 6	DMO36	30	6.00	9.00	14.50	0.33	DMQ36	29
3 x 12	DMO312	40	12.00	15.00	20.50	0.33	DMQ312	39
3 x 18	DMO318	49	18.00	21.00	26.50	0.33	DMQ318	48
3 x 24	DMO324	55	24.00	27.00	33.50	0.33	DMQ324	53
4 x 6	DMO46	45	6.00	10.00	15.50	0.34	DMQ46	44
4 x 12	DMO412	55	12.00	16.00	21.50	0.34	DMQ412	54
4 x 18	DMO418	65	18.00	22.00	27.50	0.34	DMQ418	63
4 x 24	DMO424	79	24.00	28.00	33.50	0.34	DMQ424	72
6 x 6	DMO66	45	6.00	12.00	17.50	0.36	DMQ66	55
6 x 12	DMO612	68	12.00	18.00	23.50	0.36	DMQ612	66
6 x 18	DMO618	86	18.00	24.00	29.50	0.36	DMQ618	103
6 x 24	DMO624	110	24.00	30.00	35.50	0.36	DMQ624	122
8 x 6	DMO86	84	6.00	13.00	18.50	0.38	DMQ86	85
8 x 12	DMO812	94	12.00	19.00	24.50	0.38	DMQ812	97
8 x 18	DMO818	110	18.00	25.00	30.50	0.38	DMQ818	133
8 x 24	DMO824	147	24.00	24.00		0.38		
10 x 6	DMO106	105	6.00	15.00	20.50	0.40	DMQ106	127
10 x 12	DMO1012	144	12.00	21.00	26.50	0.40	DMQ1012	174
10 x 18	DMO1018	165	18.00	27.00	32.50	0.40	DMQ1018	202
12 x 6	DMO126	150	6.00	17.00	22.50	0.42	DMQ126	132
12 x 12	DMO1212	153	12.00	23.00	28.50	0.42	DMQ1212	197
12 x 18	DMO1218	226	18.00	29.00	34.50	0.42	DMQ1218	273
12 x 24	DMO1224	272	24.00	35.00	40.50	0.42	DMQ1224	347
12 x 30	DMO1230	213	30.00	41.00	46.50	0.42	DMQ1230	205
14 x 6			6.00		24.00	0.47	DMQ146	
14 x 12			12.00		30.00	0.47	DMQ1412	
14 x 18			18.00		36.00	0.47	DMQ1418	
14 x 24			24.00		42.00	0.47	DMQ1424	
16 x 6			6.00		25.00	0.50	DMQ166	
16 x 12			12.00		31.00	0.50	DMQ1612	
16 x 18			18.00		37.00	0.50	DMQ1618	
16 x 24			24.00		43.00	0.50	DMQ1624	
18 x 6			6.00		25.00	0.54	DMQ186	
18 x 12			12.00		31.00	0.54	DMQ1812	
18 x 18			18.00		37.00	0.54	DMQ1818	
18 x 24			24.00		43.00	0.54	DMQ1824	
20 x 6			6.00		27.00	0.57	DMQ206	
20 x 12			12.00		33.00	0.57	DMQ2012	
20 x 18			18.00		39.00	0.57	DMQ2018	
20 x 24			24.00		45.00	0.57	DMQ2024	
24 x 6			6.00		28.00	0.61	DMQ246	
24 x 12			12.00		34.00	0.61	DMQ2412	
24 x 18			18.00		40.00	0.61	DMQ2418	
24 x 24			24.00		46.00	0.61	DMQ2424	

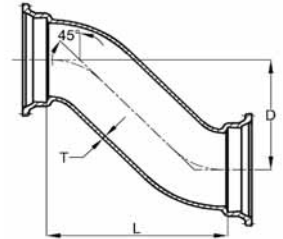

MJ x MJ

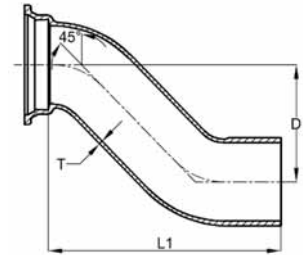

MJ x PE

Weights in Pounds, Less Accessories / Dimensions in inches
Ductile Iron Class 350 per ANSI/AWWA C153/A21.53



Sleeves

Size	SHORT SLEEVE Item No.	Wt.	L	LONG SLEEVE Item No.	Wt.	L1	T
3	DMS3	13	7.50	DML3	18	12.00	0.33
4	DMS4	17	7.50	DML4	20	12.00	0.34
6	DMS6	28	7.50	DML6	33	12.00	0.36
8	DMS8	38	7.50	DML8	46	12.00	0.38
10	DMS10	49	7.50	DML10	62	12.00	0.40
12	DMS12	56	7.50	DML12	76	12.00	0.42
14	DMS14	111	9.50	DML14	140	15.00	0.47
16	DMS16	123	9.50	DML16	170	15.00	0.50
18	DMS18	160	9.00	DML18	200	15.00	0.54
20	DMS20	195	9.00	DML20	255	15.00	0.57
24	DMS24	226	9.00	DML24	335	15.00	0.61
30	DMS30	472	15.00	DML30	640	24.00	0.66
36	DMS36	673	15.00	DML36	925	24.00	0.74
42	DMS42	887	15.00	DML42	1390	24.00	0.82
48	DMS48	1136	15.00	DML48	1740	24.00	0.90

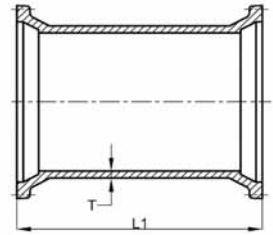

Short Sleeve

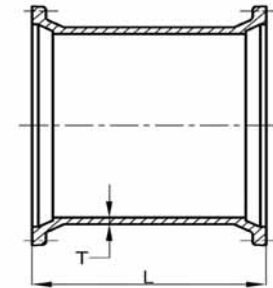

Long Sleeve

Dual Cutting-In Sleeves

Size	Item No.	Wt.	T	T1	A	L1
3	DCL3	34	0.33	0.35	3.96	20
4	DCL4	50	0.34	0.37	4.80	20
6	DCL6	62	0.36	0.39	6.90	20
8	DCL8	90	0.38	0.41	9.05	20
10	DCL10	105	0.40	0.43	11.10	20
12	DCL12	128	0.42	0.45	13.20	20

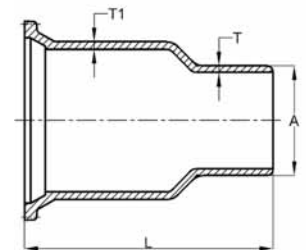

Dual Cutting- In Sleeves



C153 Mechanical Joint Compact Fittings

Mechanical Joint Accessories

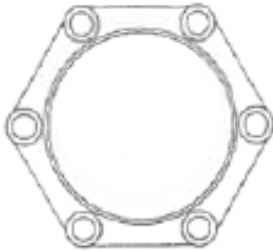

MJ Glands

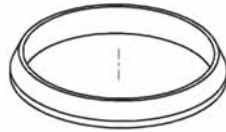

MJ Gaskets

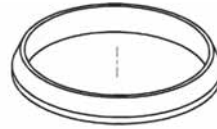

TG Gaskets

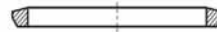
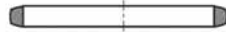

Gasket/Bolt Packs

Size (in.)	Item No.	Wt. (lb.)
3	MGP3	3
4	MGP4	4
6	MGP6	6
8	MGP8	7
10	MGP10	8
12	MGP12	9

Size	Item No.	Wt.
2	DG2	2
3	DG3	4
4	DG4	5
6	DG6	6
8	DG8	7
10	DG10	10
12	DG12	15
14	DG14	23
16	DG16	28
18	DG18	30
20	DG20	43
24	DG24	50
30	DG30	85
36	DG36	115
42	DG42	180
48	DG48	275

Size	Item No.	Wt.	Item No.	Wt.
2	MG2			
3	MG3	0.25	TG3	0.50
4	MG4	0.30	TG4	0.60
6	MG6	0.50	TG6	0.75
8	MG8	0.75	TG8	1.10
10	MG10	0.80	TG10	1.30
12	MG12	1.00	TG12	1.65
14	MG14	1.30		
16	MG16	1.45		
18	MG18	1.60		
20	MG20	1.90		
24	MG24	2.10		
30	MG30	2.30		
36	MG36	2.75		
42	MG42	3.20		
48	MG48	3.65		

MJ Gland Packs

Size (in.)	Item No.	Wt. (lb.)
2	DGP2	6
3	DGP3	7
4	DGP4	8
6	DGP6	12
8	DGP8	15
10	DGP10	20
12	DGP12	25
14	DGP14	37
16	DGP16	43
18	DGP18	47
20	DGP20	61
24	DGP24	72

Includes: Gland, MJ Gasket, and Standard Tee Bolts & Nuts

Low Alloy, Corrosion Resistant Steel T-Head Bolts

Standard Bolts

Size (in.)	Item No.	Wt. (lb.)
5/8 x 3	TB30	0.5
3/4 x 3 1/2	TB35	0.75
3/4 x 4	TB40	0.85
3/4 x 4 1/2	TB45	1
3/4 x 5	TB50	1.25
1 x 6	TB60	2.25
1 1/4 x 6	TB61	2.5



Anti-Rotation Bolts

Size (in.)	Item No.	Wt. (lb.)
3/4 x 3	ATB35	0.75
3/4 x 4	ATB40	1
3/4 x 4	ATB45	1.25
3/4 x 5	ATB50	1.5

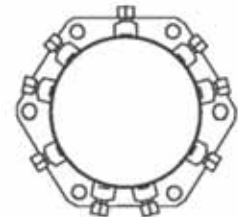

Retainer Packs

Size	Item No.	Wt.
3	RGP3	9
4	RGP4	10
6	RGP6	15
8	RGP8	19
10	RGP10	25
12	RGP12	32

MJ Retainer Glands

Pipe Size	Item No.	Wt.	IRON PIPE O.D	Rating (psi)	Set Screws		
					Qty	Size	Torque (ft-lbs)
3	RMG3	5	3.96	350	4	5/8 X 2	85
4	RMG4	7	4.80	350	4	5/8 X 2	85
6	RMG6	12	6.90	350	6	5/8 X 2	85
8	RMG8	16	9.05	250	9	5/8 X 2	85
10	RMG10	22	11.10	250	16	5/8 X 2	85
12	RMG12	28	13.20	250	16	5/8 X 2	85
14	RMG14	45	15.30	250	20	5/8 X 2	85
16	RMG16	52	17.40	250	24	5/8 X 2	85
18	RMG18	62	19.50	200	24	5/8 X 2	85
20	RMG20	75	21.60	200	28	3/4 X 2-1/2	110
24	RMG24	97	25.80	200	32	3/4 X 2-1/2	110
30	RMG30	196	32.00	100	40	3/4 X 2-1/2	110
36	RMG36	246	38.30	100	48	3/4 X 2-1/2	110
42	RMG42	302	44.50	100	56	3/4 X 2-1/2	110
48	RMG48	380	50.80	100	64	3/4 X 2-1/2	110

Transition Gland Pack - (includes Gland, Transition Gasket and Std. T-head bolts)

Size	Item No.	Wt.
3	DXP3	7
4	DXP4	8
6	DXP6	12
8	DXP8	15
10	DXP10	20
12	DXP12	25

Weights in Pounds, Less Accessories / Dimensions in inches
Ductile Iron Class 350 per ANSI/AWWA C153/A21.53



C153 MJ Non-Standard Items:

Item #	Description
•DCL16	C153 DI 16" X 16" MJ X MJ CUT-IN SLEEVE
•DMB1612	C153 DI 16" X 12" MJ X MJ REDUCING BEND
•DMB1830	C153 DI 18" X 30" MJ X MJ 30 BEND
•DMB211	C153 DI 2" MJ x MJ 11-1/4 DEGREE BEND
•DMB222	C153 DI 2" MJ x MJ 22-1/2 DEGREE BEND
•DMB2405	C153 DI 24" X 24" MJ X MJ 5-5/8 DEGREE BEND
•DMB3005	C153 DI 30" X 30" MJ X MJ 5-5/8 DEGREE BEND
•DMB3605	C153 DI 36" x 36" MJ X MJ 5-5/8 DEGREE BEND
•DMB4205	C153 DI 42" X 42" MJ X MJ 5-5/8 DEGREE BEND
•DMB4260	C153 DI MJ 42X60 BEND
•DMB4805	C153 DI 48" X 48" MJ X MJ 5-5/8 DEGREE BEND
•DMB4830	C153 DI 48" X 30" MJ X MJ 30 DEGREE BEND
•DMC186	C153 DI 18" X 6" MJ X MJ CROSS
•DMF103	C153 DI 10" X 3" MJ X FLG TEE
•DML2	C153 DI 2" X 2" MJ X MJ LONG SLEEVE
•DTK2	C153 DI 2" MJ CAP (TAPPED)
•PPR83	C153 DI 8" X 3" PE X PE CONCENTRIC REDUCER
•SPR62	C153 DI 6" X 2" PE X MJ SEB CONCENTRIC REDUCER
•SPR83	C153 DI 8" X 3" PE X MJ SEB CONCENTRIC REDUCER
•SSA824	C153 DI 8" X 24" SOLID X SWL ADAPTER
•SSA836	C153 DI 8" X 36" SOLID X SWL ADAPTER
•TG2	2" MJ TRANS RUBBER GSKT
•DML2	C153 DI 2" X 2" MJ X MJ LONG SLEEVE
•DMR4220	C153 DI 42" X 20" MJ X MJ CONCENTRIC REDUCER
•DMR4820	C153 DI 48" X 20" MJ X MJ CONCENTRIC REDUCER
•DMR83	C153 DI 8" X 3" MJ X MJ CONCENTRIC REDUCER
•DMT304	C153 DI 30" X 4" MJ X MJ TEE
•DMT62	C153 DI 6" X 2" MJ X MJ TEE

Note: Contact SIGMA for more information on non-standard fittings.



Weights in Pounds, Less Accessories / Dimensions in inches
Ductile Iron Class 350 per ANSI/AWWA C153/A21.53

LOCATIONS

Northeast Region

Cream Ridge, New Jersey (HQ)
Phone (800) 999-2550
Fax (609) 758-1158
crm-sales@sigmaco.com

Victoriaville, Quebec, Canada
Phone (888) 744-6262
Fax (819) 758-1153
jboucher@repc.co

Innisfil, Ontario, Canada
Phone (877) 436-3800
Fax (705) 436-6338
tanya@concordsupply.ca

Midwest Region

Sauk Village, Illinois
Phone (888) 999-0420
Fax (708) 758-6790
chi-sales@sigmaco.com

Southeast Region

Alexander City, Alabama
Phone (800) 824-4513
Fax (256) 234-4956
rps-sales@sigmaco.com

Southwest Region

Houston, Texas
Phone (800) 999-0109
Fax (281) 987-0200
htn-sales@sigmaco.com

Western Region

Ontario, California
Phone (800) 688-6230
Fax (909) 391-2033
ont-sales@sigmaco.com

Auburn, Washington
Phone (800) 688-6230

www.sigmaco.com

Terms and Conditions of Sales available at our website.

AWWA Ductile Iron Fittings



- 2-64" C153 Ductile Iron Mechanical Joint Class 350
- 2-48" C110 Full Body Mechanical Joint
- 2-64" C110 Cast Iron/Ductile Iron Flanged Fittings
- 3-24" C153 TRIM TYTON® Compact Push On Fittings
- 4-24" C110 Full Body Push On Fittings
- C116 Fusion Bonded Epoxy lining available
- PROTECTO 401® ceramic epoxy lining available

Mechanical Joint Accessories



- Prepackaged and loose mechanical joint accessories
- SIGMASEAL™ improved mechanical joint gasket
- Snap-on multi-purpose gasket for ductile iron or PVC pressure pipes
- Ductile iron set screw retainer glands
- OMNI-SLEEVE™ improved wall penetration sleeve
- Specialty bolts and nuts for mechanical joint assemblies

ONE-LOK™ Wedge Action Restraints



- 3-48" ONE-LOK SLDE restraint for ductile iron pipe (import or domestic)
- 3-36" ONE-LOK SLCE restraint for PVC pipe (import or domestic)
- 3-36" ONE-LOK SLDEH bell joint harness for ductile iron pipe
- 4-12" / 20" ONE-LOK SLDM restraint for oversized cast iron pipe
- 4-36" ONE-LOK SSLD split restraint for existing ductile iron pipe
- 4-36" ONE-LOK SSLDH split restraint harness for existing ductile iron pipe
- 3-12" ONE-LOK SLCEH bell joint harness for PVC pipe

PV-LOK™ Serration Lock Restraints



- 4-48" PV-LOK PWM Restraint for MJ Fitting to PVC pipe
- 4-48" PV-LOK PWP Restraint for PVC bell joint restraint
- 4-48" PV-LOK PWPF Restraint for PVC fitting to PVC pipe
- 4-12" PV-LOK PWH PVC bell joint harness
- 2-12" PV-LOK PVM Restraint for MJ Fitting to IPS PVC pipe
- 2-12" PV-LOK PVP Restraint for IPS PVC pipe bell joint
- 4-8" PV-LOK PVPF Restraints for IPS PVC pressure fitting

Flange Adapters



- 3-36" SIGMAFLANGE SFA flange adapter sleeve for PVC and DIP
- 2-48" ZIP FLANGE set screw style flange adapter

Municipal Construction Castings



- Manhole Rings and Covers
- Curb and Meter Boxes
- Frames and Grates
- Storm Inlets
- Valve Boxes, Risers, and Extensions

Products for the Ductile Iron Fabricator



- 3-64" High Hub Threaded Flanges
- 3-48" Tapped High Hub Threaded Flanges
- 3-36" Extra Heavy 250lb Drilled Threaded Flanges
- 3-48" Threaded MJ Bell Adapters
- 3-48" MJ x PE Bell adapter (2ft)
- 3-48" Anchor Flanges
- 3-16" Filler Flanges

Extended Range Products



- FLANGE-PAK™ prepackaged flange accessory sets
- Polyethylene encasement for ductile iron pipe
- Copper tubing products
- Tracer wire & detectable/non-detectable marking tape
- Pipe joint lubricant & hydraulic cement
- Socket clamps and tie rod accessories
- BOXLOK Valve Box Alignment Device
- Cast Iron Companion Flanges

TRIM-TYTON and TYTON are registered trademarks of the United States Pipe and Foundry Company • PROTECTO 401 is a registered trademark of Induron, Inc.