

PRODUCT SPECIFICATIONS  
**BUF500 Vent Free Firebox**



**MINIMUM HEARTH DIMENSIONS**

Front opening width: 41-1/2"  
 Front opening height: 21-1/2"  
 Rear wall width: 26-3/8"  
 Firebox depth: 17"

**TECHNICAL INFORMATION**

Clearance to Fireplace: Zero  
 CSA Design Certified

**FIELD INSTALLED ACCESSORIES**

200 CFM Blower Kit: FA2A  
 Outside air kit: AK4

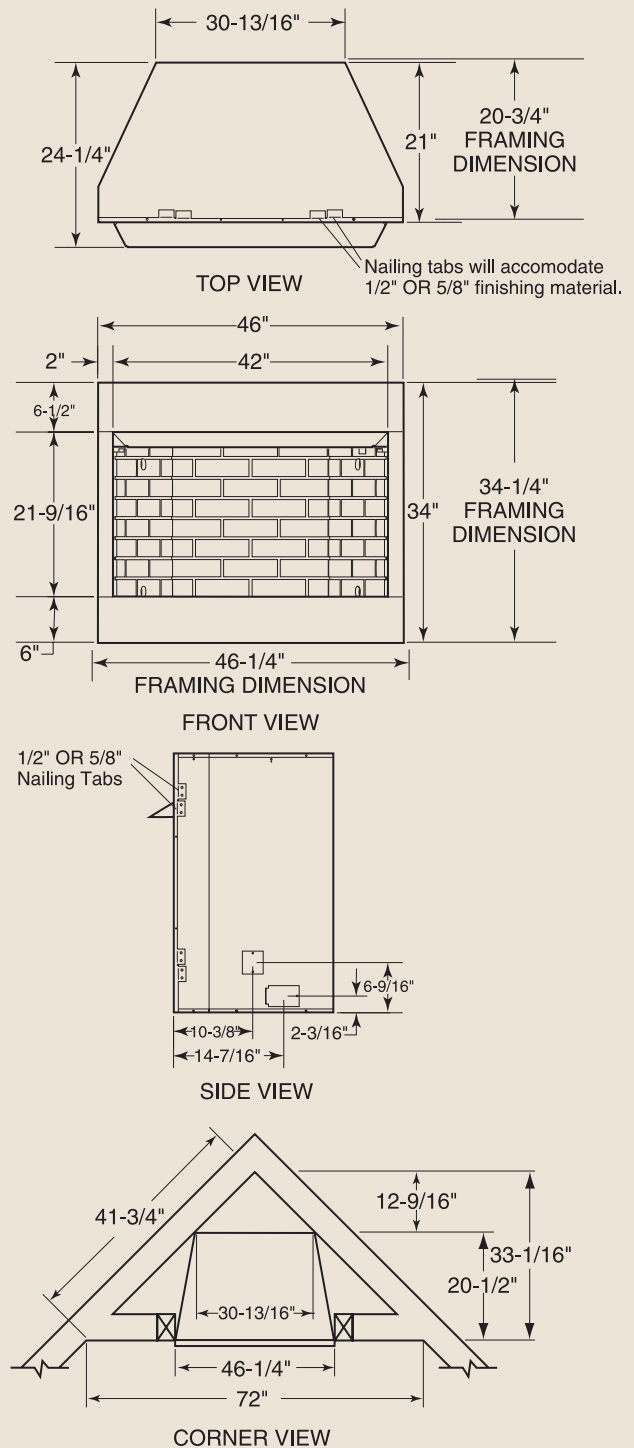

A Brand of Monessen Hearth Systems Co.  
 149 Cleveland Drive, Paris, Kentucky 40361

[www.monessenhearth.com](http://www.monessenhearth.com)



To avoid personal injury or property damage, the product described by this brochure must be installed, operated and maintained in strict compliance with the instructions packaged with the product and all applicable building or fire codes. Contact local building or fire officials about restrictions and installation inspection requirements. All photographs and drawings on this brochure are for illustrative purposes only and are not intended for, nor should they be used as a substitute for the instructions packaged with the unit. Appearance and specifications of the product are subject to change without notice. © 2009 Monessen Hearth Systems Co.