

Installation Instructions / Warranty

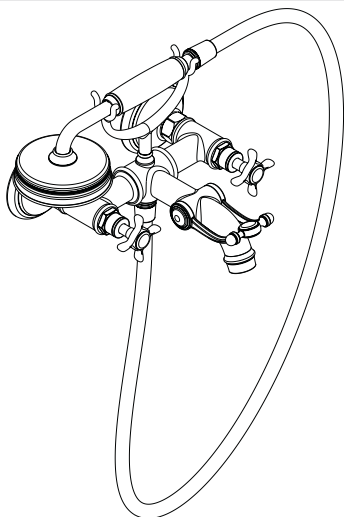

Montreux
16540XX1

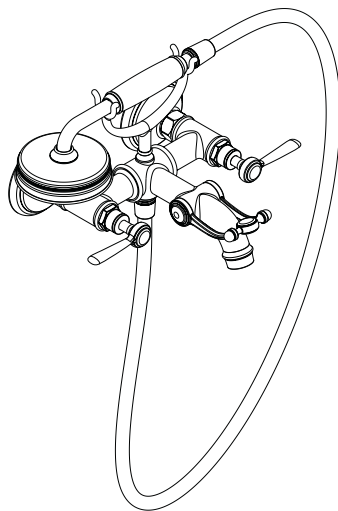

Montreux
16551XX1

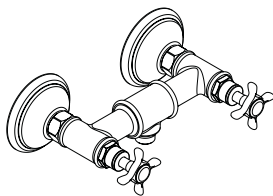

Montreux
16560XX1

AXOR[®]
hansgrohe

Axor Montreux

Wall-Mount Tub Filler 16540XX1, 16551XX1

Wall-Mount Shower Mixer 16560XX1

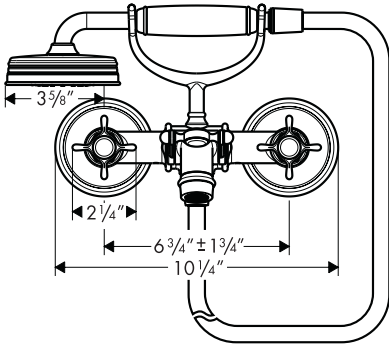

16540XX1

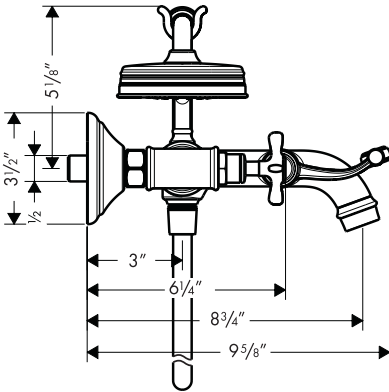

16560XX1

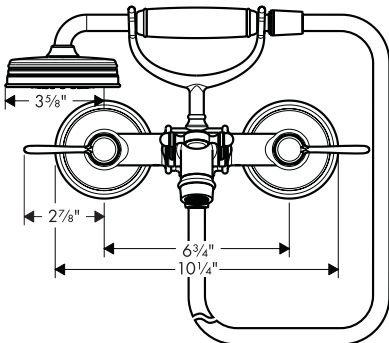

16551XX1

Technical Data

Operating pressure:	max. 145 psi
Recommended operating pressure:	14.5 - 72 psi
Hot water temperature:	max. 176° F*
Recommended hot water temperature:	120° F - 140° F*
Center distance:	6 3/4" ± 1 3/4"
Connections 1/2" female:	cold right hot left
Tub filler flow rate @ 45 psi	approx. 5.8 gpm
Flow rate for handshower	2.5 gpm
Backflow prevention provided by double check valve.	
This unit is not anti-scald. If required by local plumbing code, install with remote pressure balance valve 13418181.	

*Know and follow all applicable local plumbing codes when setting the temperature on the water heater.

Installation

During rough-in, install two $\frac{1}{2}$ " female threaded fittings, recessed $\frac{3}{16}$ " behind the surface of the finished wall. The fittings should be $6\frac{3}{4}$ " apart on center.

Flush the hot and cold supplies thoroughly.

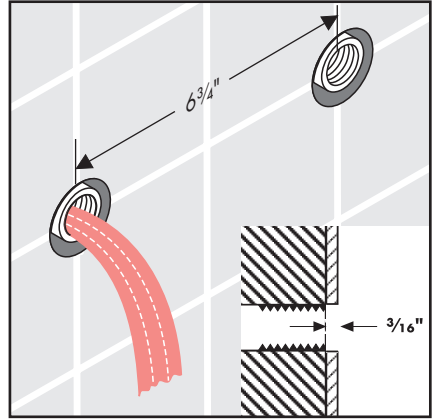

Wrap the threads on the offset adapters with Teflon tape.

Screw the adapters into the female fittings.

The adapters should extend $1\frac{7}{16}$ " - $1\frac{3}{4}$ " outside the surface of the finished wall.

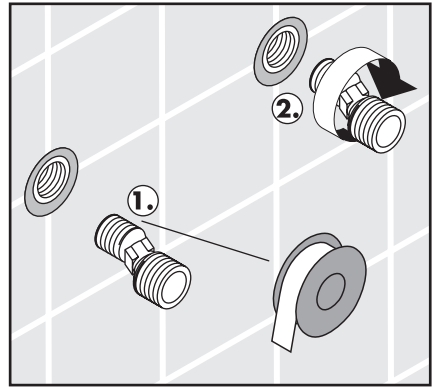
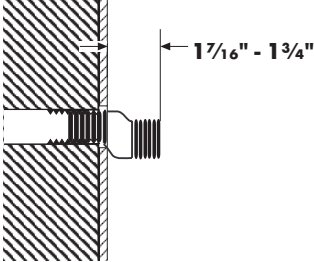

Adjust the offset adapters so that the distance between the centers is $6\frac{3}{4}$ ", and they are level.



Seal the wall around the adapters with waterproof sealant.



Failure to seal the wall can lead to possible water damage.

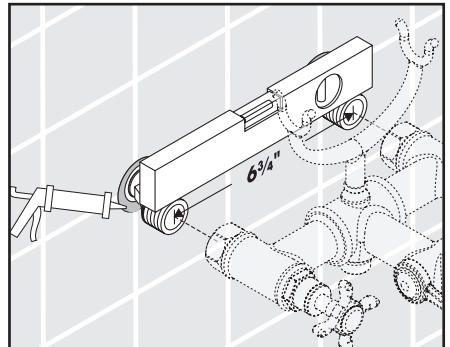

Install the escutcheons.

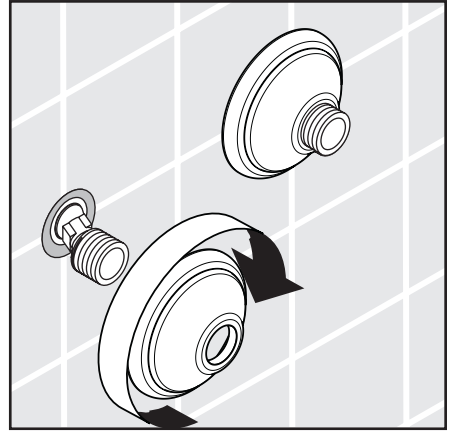

Install the washers and the mixer.

Tighten the nuts.

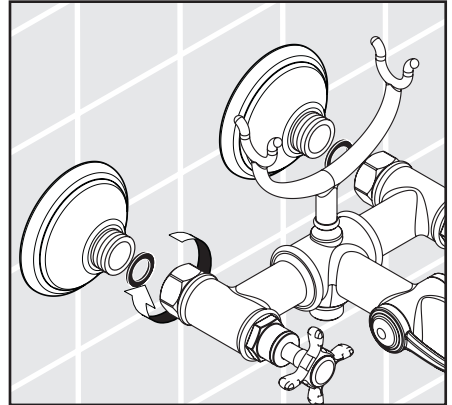

16551XX1 only:

Inspect the alignment of the lever handles.

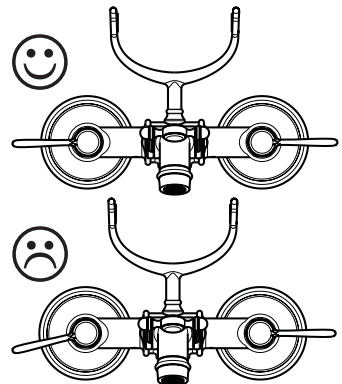

If it is not satisfactory, remove the screw cover.

Remove the handle screw using a 3 mm Allen wrench.

Remove the handle.

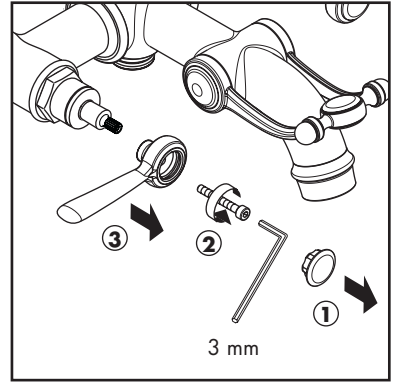

OR

Remove the handle and adapter.

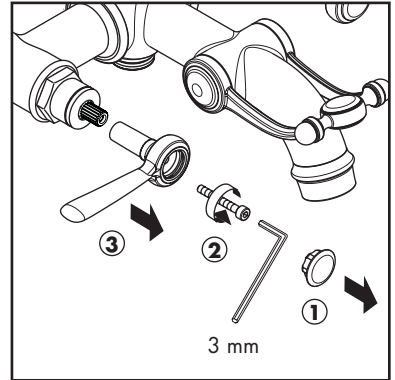

Reposition the handle.

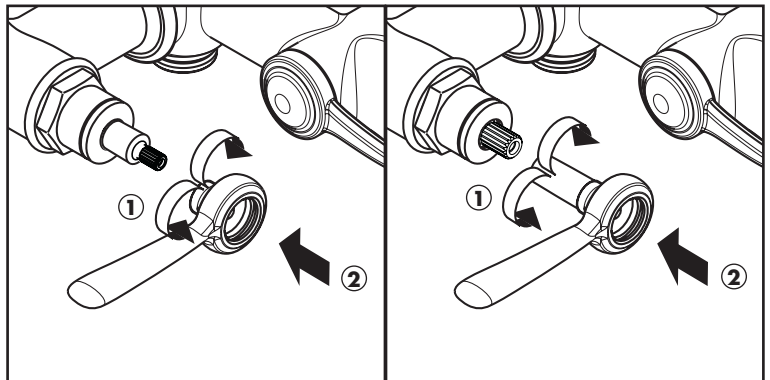

Install the handle screw.

Install the screw cover.

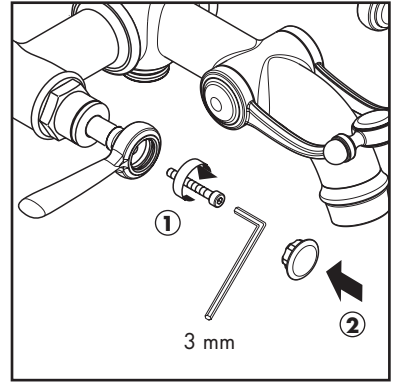

All models:

Assemble the double check valve.

The arrows on the check valves must point in the direction of the water flow.

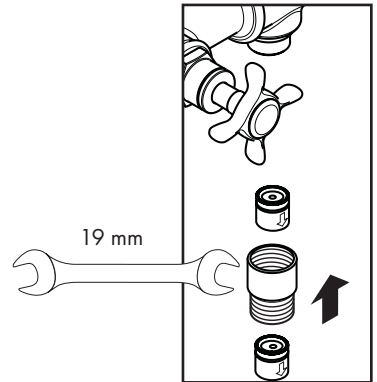

Place a hose washer in one end of the handshower hose. Screw it to the handshower outlet.

Place the other hose washer in the other end of the hose. Screw it to the handshower.

Rest the handshower in the holder.

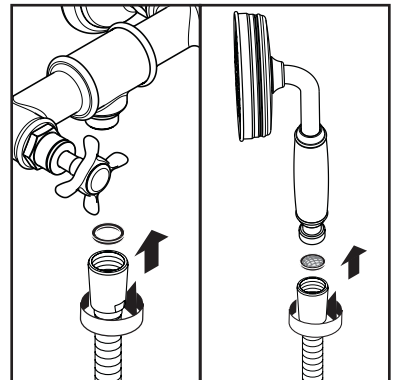

User Instructions

Turn the handles to turn the water on.

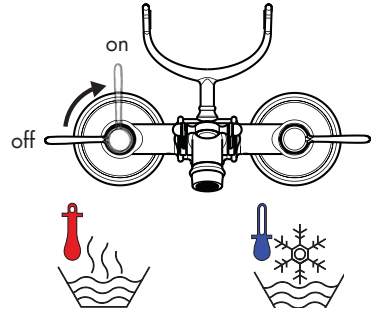

When the diverter is in the forward position, water will come from the spout.

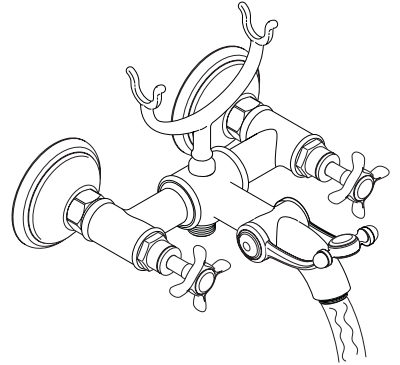

Push the diverter to the rear to obtain water from the handshower.

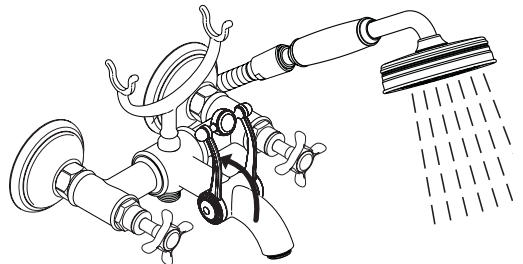

Remove and inspect the check valves yearly.

If a check valve is dirty or worn, replace it.

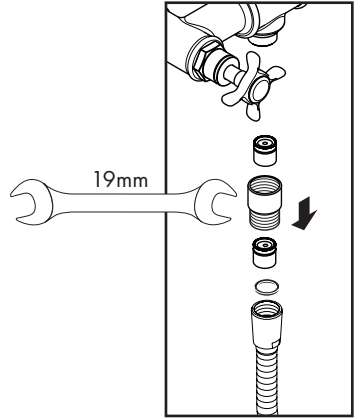

Replacement Parts

16540XX1, 16551XX1

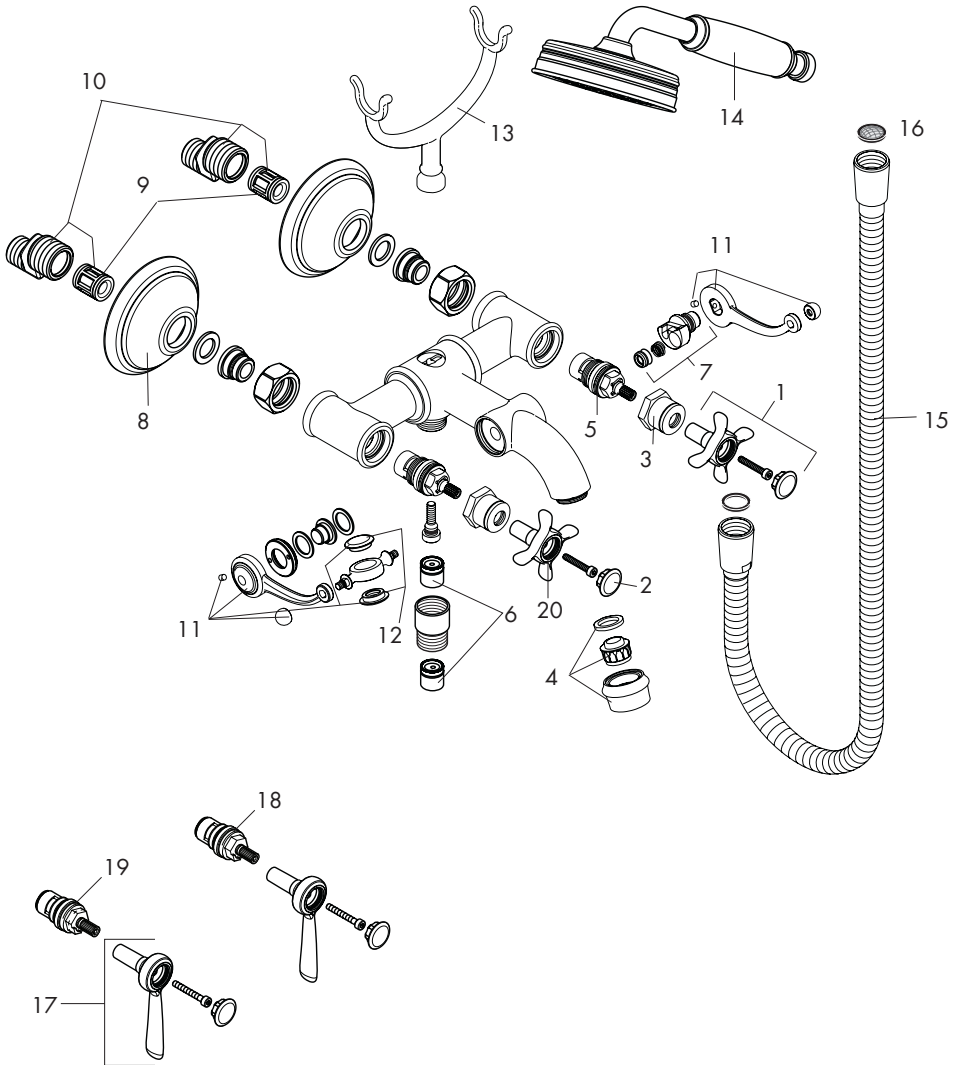

16560XX1

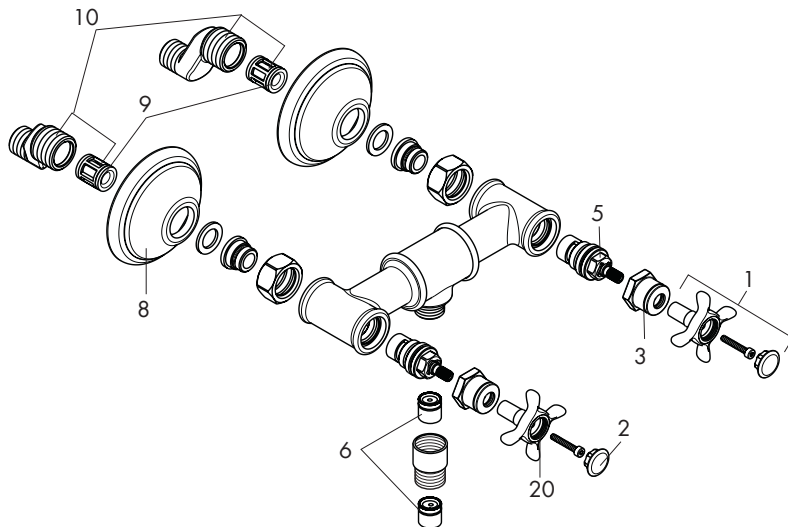

1	handle	16597XX0
2	screw cover cold / hot water	97987000
3	sleeve	97993XX0
4	aerator	98575XX0
5	valve cartridge	94149000
6	check valve	94074000
7	diverter assembly	98591000
8	escutcheon	98595XX0
9	noise reduction	96429000
10	offset adapters	98592001
11	sliding gear lever	98594XX0
12	cover caps	98593XX0
13	shower base	98590XX0
14	handshower	16320XX1
15	hose	28112000
16	screen washer	94246000
17	lever handle	16597XX0
18	cold cartridge*	96350001
19	hot cartridge*	96351001
20	o-ring 16x2	98133000

XX = Colors
 00 chrome
 82 brushed nickel
 83 polished nickel

*Included with 16551XX1 only.

Cleaning Recommendation for Hansgrohe Products

Modern lavatory faucets, kitchen faucets, and showers consist of very different materials to comply with the needs of the market with regard to design and functionality. To avoid damage and returns, it is necessary to consider certain criteria when cleaning.

Cleaning Materials for Faucets and Showers

Acids are a necessary ingredient of cleaning materials for removing lime, however please pay attention to the following points when cleaning faucets and showers:

- Only use cleaning materials which are explicitly intended for this type of application.
- Never use cleaning materials which contain hydrochloric, formic, phosphoric, or acetic acid, as they cause considerable damage.
- Never mix one cleaning material with another.
- Never use cleaning materials or appliances with an abrasive effect, such as unsuitable cleaning powders, sponge pads, or micro fiber cloths.

Cleaning Instructions for Faucets and Showers

Please follow the cleaning material manufacturer's instructions. In addition, pay attention to the following points:

- Clean the faucets and showers as and when required
- Use the amount of cleaning product and the amount of time recommended by the manufacturer. Do not leave the cleaner on the fixture longer than necessary.
- Regular cleaning can prevent calcification.
- When using spray cleaners, spray first onto a soft cloth or sponge. Never spray directly onto the faucet as droplets can enter openings and gaps and cause damage.
- After cleaning, rinse thoroughly with clean water to remove any cleaner residue.

Important

Residues of liquid soaps, shampoos, and shower foams can also cause damage, so rinse with clean water after using.

Please note: if the surface is already damaged, the effect of cleaning materials will cause further damage.

Components with damaged surfaces must be replaced or injury could result.

Damage caused by improper treatment is not covered under the warranty.

Limited Lifetime Consumer Warranty

This product has been manufactured and tested to the highest quality standards by Hansgrohe, Inc. ("Hansgrohe"). This warranty is limited to Hansgrohe products which are purchased by a consumer in the United States after March 1, 1996, and installed in either the United States or Canada.

WHO IS COVERED BY THE WARRANTY

This warranty extends to the original consumer purchaser only. This warranty is non-transferable.

WHAT IS COVERED BY THE WARRANTY

This warranty covers only your Hansgrohe manufactured product. Hansgrohe warrants this product against defects in material or workmanship as follows: Hansgrohe will repair at no charge for parts only or, at its option, replace any product or part of the product that proves defective because of improper workmanship and/or material, under normal installation, use, service and maintenance. If Hansgrohe is unable to provide a replacement and repair is not practical or cannot be timely made, Hansgrohe may elect to refund the purchase price in exchange for the return of the product.

LENGTH OF WARRANTY

Replacement or repaired parts of products will be covered for the term of this warranty as stated in the following two sentences. If you are a consumer who purchased the product for use primarily for personal, family, or household purposes, this warranty extends for as long as you own the product and the home in which the product is originally installed. If you purchased the product for use primarily for any other purpose, including, without limitation, a commercial purpose, this warranty extends only (i) for 1 year, with respect to Hansgrohe and Commercial products, and (ii) for 5 years, with respect to AXOR products.

THIS WARRANTY DOES NOT COVER, AND HANSGROHE WILL NOT PAY FOR:

- A. Conditions, malfunctions or damage not resulting from defects in material or workmanship.
- B. Conditions, malfunctions or damage resulting from (1) normal wear and tear, improper installation, improper maintenance, misuse, abuse, negligence, accident or alteration, or (2) the use of abrasive or caustic cleaning agents or "no-rinse" cleaning products, or the use of the product in any manner contrary to the product instructions. (3) Conditions in the home such as excessive water pressure or corrosion.
- C. Labor or other expenses for the disconnection, deinstallation, or return of the product for warranty service, or for installation or reinstallation of the product (including but not limited to proper packaging and shipping costs), or for installation or reinstallation of the product.
- D. Accessories, connected materials and products, or related products not manufactured by Hansgrohe.

TO OBTAIN WARRANTY PARTS OR INFORMATION

Contact your Hansgrohe retailer, or contact Technical Service at:

Hansgrohe Inc.
1492 Bluegrass Lakes Parkway
Alpharetta GA 30004
Toll-free (800) 334-0455.

In requesting warranty service, you will need to provide

- 1. The sales receipt or other evidence of the date and place of purchase.
- 2. A description of the problem.
- 3. Delivery of the product or the defective part, postage prepaid and carefully packed and insured, to Hansgrohe Inc. 1492 Bluegrass Lakes Parkway, Alpharetta, Georgia 30004, Attention: Technical Service, if required by Hansgrohe.

When warranty service is completed, any repaired or replacement product or part will be returned to you postage prepaid.

EXCLUSIONS AND LIMITATIONS

REPAIR OR REPLACEMENT (OR, IN LIMITED CIRCUMSTANCES, REFUND OF THE PURCHASE PRICE) AS PROVIDED UNDER THIS WARRANTY IS THE EXCLUSIVE REMEDY OF THE PURCHASER. HANSGROHE NEITHER ASSUMES NOR AUTHORIZES ANY PERSON TO CREATE FOR IT ANY OBLIGATION OR LIABILITY IN CONNECTION WITH THIS PRODUCT.

HANSGROHE SHALL NOT BE LIABLE TO PURCHASER OR ANY PERSON FOR ANY INCIDENTAL, SPECIAL, OR CONSEQUENTIAL DAMAGES, ARISING OUT OF BREACH OF THIS WARRANTY OR ANY IMPLIED WARRANTY (INCLUDING MERCHANTABILITY).

Some States do not allow the exclusion or limitation of incidental or consequential damages, so the above limitation or exclusion may not apply to you. This warranty gives you specific legal rights, and you may have other rights which vary from State to State. You may be required by law to give us a reasonable opportunity to correct or cure any failure to comply before you can bring any action in court against us under the Magnuson-Moss Warranty Act.

PRODUCT INSTRUCTIONS AND QUESTIONS

Upon purchase or prior to installation, please carefully inspect your Hansgrohe product for any damage or visible defect. Prior to installing, always carefully study the enclosed instructions on the proper installation and the care and maintenance of the product. If you have questions at any time about the use, installation, or performance of your Hansgrohe product, or this warranty, please call or write to us or call us toll-free at 800 334 0455.

hansgrohe

Hansgrohe, Inc. • 1490 Bluegrass Lakes Parkway • Alpharetta, GA 30004
Tel. 770-360-9880 • Fax 770-360-9887

www.hansgrohe-usa.com