

DIMENSIONAL SPECIFICATIONS

LEAD-FREE DOMESTIC BRASS FITTINGS* 125 LB.

90 DEGREE ELBOW

Part #	Size (IN.)	Approx. Net WT. (LB.)	A	B
NL101-02	1/8	0.06	0.54	0.54
NL101-04	1/4	0.08	0.71	0.71
NL101-06	3/8	0.16	0.82	0.82
NL101-08	1/2	0.24	1.01	1.01
NL101-12	3/4	0.35	1.18	1.18
NL101-16	1	0.60	1.43	1.43
NL101-20	1-1/4	0.95	1.69	1.69
NL101-24	1-1/2	1.03	1.84	1.84
NL101-32	2	1.95	2.12	2.12
NL101-40	2-1/2	3.45	2.70	2.70
NL101-48	3	5.40	3.08	3.08
NL101-64	4	9.25	3.79	3.79
NL101-96	6	24.22	5.13	5.13

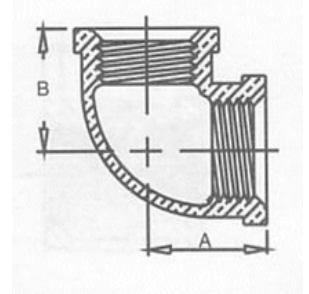

90 DEGREE STREET ELBOW

Part #	Size (IN.)	Approx. Net WT. (LB.)	A	B
NL103-02	1/8	0.06	0.55	0.92
NL103-04	1/4	0.11	0.72	1.11
NL103-06	3/8	0.17	0.83	1.24
NL103-08	1/2	0.23	1.03	1.51
NL103-12	3/4	0.35	1.19	1.66
NL103-16	1	0.50	1.43	1.98
NL103-20	1-1/4	0.85	1.71	2.26
NL103-24	1-1/2	1.15	1.87	2.46
NL103-32	2	1.98	2.14	2.98
NL103-40	2-1/2	3.15	2.74	3.92
NL103-48	3	5.26	3.10	4.45

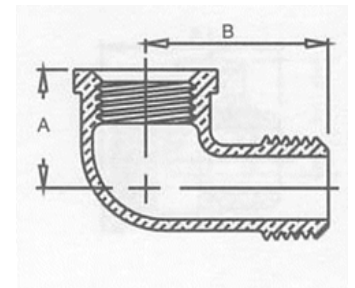

*Conforms with lead content requirements for lead-free plumbing as defined by the U.S. Safe Drinking Water Act. Certified <0.25 weighted average % lead.



MERIT BRASS

DIRECTING THE FLOW OF *Quality*

DIMENSIONAL SPECIFICATIONS

LEAD-FREE DOMESTIC BRASS FITTINGS* 125 LB.

90 DEGREE REDUCING ELBOW

Part #	Size (IN.)	Approx. Net WT. (LB.)	A	B
NL101-0402	1/4 X 1/8	0.09	0.65	0.60
NL101-0602	3/8 X 1/8	0.14	0.67	1.00
NL101-0604	3/8 X 1/4	0.13	0.75	0.75
NL101-0804	1/2 X 1/4	0.17	1.78	1.69
NL101-0806	1/2 X 3/8	0.18	0.93	0.90
NL101-1204	3/4 X 1/4	0.30	1.00	1.00
NL101-1206	3/4 X 3/8	0.25	0.97	0.97
NL101-1208	3/4 X 1/2	0.31	1.08	1.11
NL101-1608	1 X 1/2	0.45	1.20	1.24
NL101-1612	1 X 3/4	0.50	1.30	1.31
NL101-2008	1-1/4 X 1/2	0.70	1.25	1.38
NL101-2412	1-1/4 X 3/4	0.88	1.30	1.31
NL101-2016	1-1/4 X 1	0.82	1.52	1.60
NL101-2416	1-1/2 X 1	0.96	1.55	1.72
NL101-2420	1-1/2 X 1-1/4	1.00	1.72	1.81
NL101-3208	2 X 1/2	1.25	1.17	2.92
NL101-3216	2 X 1	1.60	1.56	1.94
NL101-3224	2 X 1-1/2	1.78	1.89	2.07
NL101-4024	2-1/2 X 1-1/2	3.28	2.19	2.50
NL101-4032	2-1/2 X 2	3.02	2.39	2.60

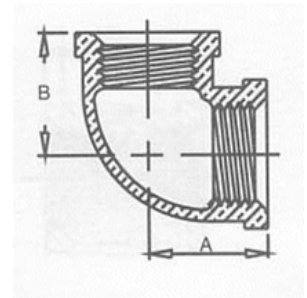

*Conforms with lead content requirements for lead-free plumbing as defined by the U.S. Safe Drinking Water Act. Certified <0.25 weighted average % lead.



MERIT BRASS

DIRECTING THE FLOW OF *Quality*

DIMENSIONAL SPECIFICATIONS

LEAD-FREE DOMESTIC BRASS FITTINGS* 125 LB.

45 DEGREE ELBOW

Part #	Size (IN.)	Approx. Net WT. (LB.)	A	B
NL102-02	1/8	0.05	0.43	0.43
NL102-04	1/4	0.09	0.55	0.55
NL102-06	3/8	1.14	0.63	0.63
NL102-08	1/2	0.19	0.79	0.79
NL102-12	3/4	0.30	0.91	0.91
NL102-16	1	0.50	1.07	1.07
NL102-20	1-1/4	0.75	1.23	1.23
NL102-24	1-1/2	0.95	1.31	1.31
NL102-32	2	1.70	1.47	1.47
NL102-40	2-1/2	2.79	1.89	1.89

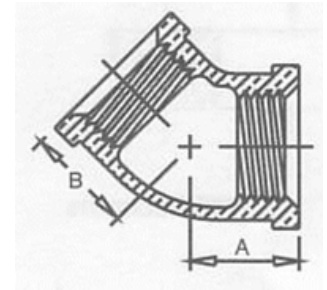

45 DEGREE STREET ELBOW

Part #	Size (IN.)	Approx. Net WT. (LB.)	A	B
NL103A-04	1/4	0.08	0.56	0.88
NL103A-06	3/8	0.12	0.63	0.92
NL103A-08	1/2	0.17	0.78	1.06
NL103A-12	3/4	0.29	0.89	1.23
NL103A-16	1	0.49	1.06	1.40
NL103A-20	1-1/4	0.70	1.22	1.64
NL103A-24	1-1/2	0.92	1.30	1.80
NL103A-32	2	1.37	1.45	2.14

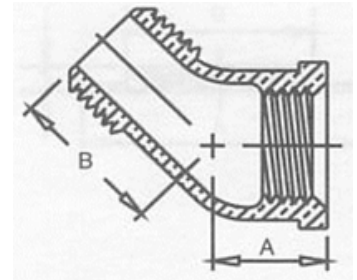

*Conforms with lead content requirements for lead-free plumbing as defined by the U.S. Safe Drinking Water Act. Certified <0.25 weighted average % lead.



MERIT BRASS

DIRECTING THE FLOW OF *Quality*

DIMENSIONAL SPECIFICATIONS

LEAD-FREE DOMESTIC BRASS FITTINGS* 125 LB.

45 DEGREE Y-BRANCH

Part #	Size (IN.)	Approx. Net WT. (LB.)	A	B
NL122-06	3/8	0.28	1.78	1.28
NL122-08	1/2	0.29	2.19	1.58
NL122-12	3/4	0.62	2.62	1.90
NL122-16	1	0.97	3.18	2.33
NL122-20	1-1/4	1.63	3.85	2.83
NL122-24	1-1/2	1.96	4.24	3.14
NL122-32	2	3.25	5.00	3.76
NL122-40	2-1/2	6.39	6.25	4.75
NL122-48	3	10.19	7.25	5.56

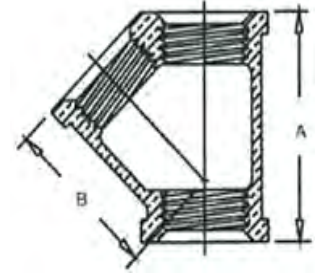

*Conforms with lead content requirements for lead-free plumbing as defined by the U.S. Safe Drinking Water Act. Certified <0.25 weighted average % lead.



MERIT BRASS

DIRECTING THE FLOW OF *Quality*

DIMENSIONAL SPECIFICATIONS

LEAD-FREE DOMESTIC BRASS FITTINGS* 125 LB.

TEE

Part #	Size (IN.)	Approx. Net WT. (LB.)	A	B	C
NL106-02	1/8	0.07	0.54	0.54	0.54
NL106-04	1/4	0.14	0.71	0.71	0.71
NL106-06	3/8	0.21	0.82	0.82	0.82
NL106-08	1/2	0.30	1.01	1.01	1.01
NL106-12	3/4	0.50	1.18	1.18	1.18
NL106-16	1	0.80	1.43	1.43	1.43
NL106-20	1-1/4	1.47	1.69	1.69	1.69
NL106-24	1-1/2	1.50	1.84	1.84	1.84
NL106-32	2	2.25	2.12	2.12	2.12
NL106-40	2-1/2	4.56	2.70	2.70	2.70
NL106-48	3	6.70	3.08	3.08	3.08
NL106-64	4	11.03	3.79	3.79	3.79

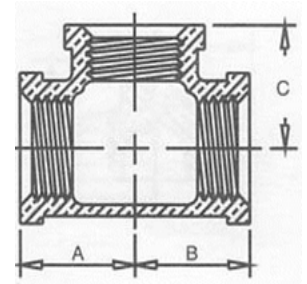

STREET TEE

Part #	Size (IN.)	Approx. Net WT. (LB.)	A	B
NL106A-08	1/2	0.27	2.19	1.59
NL106A-32	2	3.20	2.13	2.88

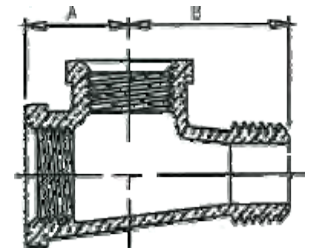

*Conforms with lead content requirements for lead-free plumbing as defined by the U.S. Safe Drinking Water Act. Certified <0.25 weighted average % lead.



MERIT BRASS

DIRECTING THE FLOW OF *Quality*

DIMENSIONAL SPECIFICATIONS

LEAD-FREE DOMESTIC BRASS FITTINGS* 125 LB.

REDUCING TEE

Part #	Size (IN.)	Approx. Net WT. (LB.)	A	B	C
NL106-060604	3/8 X 3/8 X 1/4	0.17	0.75	0.75	0.78
NL106-060608	3/8 X 3/8 X 1/2	0.24	0.90	0.90	0.93
NL106-080408	1/2 X 1/4 X 1/2	0.27	0.93	0.87	0.93
NL106-080606	1/2 X 3/8 X 3/8	0.25	0.93	0.82	0.90
NL106-080608	1/2 X 3/8 X 1/2	0.25	1.01	0.90	1.01
NL106-080806	1/2 X 1/2 X 3/8	0.25	0.93	0.93	0.90
NL106-080812	1/2 X 1/2 X 3/4	0.38	1.11	1.11	1.08
NL106-120808	3/4 X 1/2 X 1/2	0.42	1.08	1.01	1.11
NL106-120812	3/4 X 1/2 X 3/4	0.42	1.18	1.11	1.18
NL106-121204	3/4 X 3/4 X 1/4	0.35	1.00	1.00	1.00
NL106-121208	3/4 X 3/4 X 1/2	0.40	1.08	1.08	1.11
NL106-121216	3/4 X 3/4 X 1	0.60	1.31	1.31	1.30
NL106-160816	1 X 1/2 X 1	0.61	1.43	1.24	1.43
NL106-161208	1 X 3/4 X 1/2	0.46	1.20	1.08	1.24
NL106-161212	1 X 3/4 X 3/4	0.58	1.30	1.08	1.31
NL106-161216	1 X 3/4 X 1	0.71	1.43	1.31	1.43
NL106-161606	1 X 1 X 3/8	0.56	1.12	1.12	1.13
NL106-161608	1 X 1 X 1/2	0.63	1.20	1.20	1.24
NL106-161612	1 X 1 X 3/4	0.72	1.30	1.30	1.31
NL106-202008	1-1/4 X 1-1/4 X 1/2	0.92	1.29	1.29	1.41
NL106-202012	1-1/4 X 1-1/4 X 3/4	0.91	1.39	1.39	1.48
NL106-202016	1-1/4 X 1-1/4 X 1	1.10	1.52	1.52	1.60

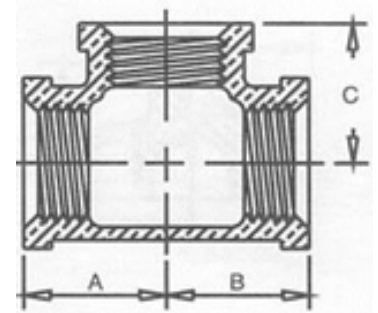

*Conforms with lead content requirements for lead-free plumbing as defined by the U.S. Safe Drinking Water Act. Certified <0.25 weighted average % lead.



MERIT BRASS

DIRECTING THE FLOW OF *Quality*

DIMENSIONAL SPECIFICATIONS

LEAD-FREE DOMESTIC BRASS FITTINGS* 125 LB.

REDUCING TEE CONTINUED

Part #	Size (IN.)	Approx. Net WT. (LB.)	A	B	C
NL106-202024	1-1/4 X 1-1/4 X 1-1/2	1.74	1.81	1.81	1.72
NL106-240824	1-1/2 X 1/2 X 1-1/2	1.51	1.81	1.56	1.81
NL106-241224	1-1/2 X 3/4 X 1-1/2	1.35	1.84	1.60	1.84
NL106-241616	1-1/2 X 1 X 1	1.10	1.63	1.50	1.81
NL106-241624	1-1/2 X 1 X 1-1/2	1.47	1.88	1.81	1.88
NL106-242408	1-1/2 X 1-1/2 X 1/2	1.17	1.32	1.32	1.53
NL106-242412	1-1/2 X 1-1/2 X 3/4	1.14	1.42	1.42	1.60
NL106-242416	1-1/2 X 1-1/2 X 1	1.35	1.55	1.55	1.72
NL106-242420	1-1/2 X 1-1/2 X 1-1/4	1.45	1.72	1.72	1.81
NL106-242432	1-1/2 X 1-1/2 X 2	2.15	2.07	2.07	1.89
NL106-321232	2 X 3/4 X 2	2.56	2.13	1.84	2.13
NL106-322420	2 X 1-1/2 X 1-1/4	1.79	1.78	1.72	2.03
NL106-323208	2 X 2 X 1/2	1.67	1.50	1.50	1.88
NL106-323212	2 X 2 X 3/4	1.70	1.47	1.47	1.84
NL106-323216	2 X 2 X 1	1.83	1.59	1.59	1.95
NL106-323220	2 X 2 X 1-1/4	2.07	1.77	1.77	2.04
NL106-323224	2 X 2 X 1-1/2	2.18	1.89	1.89	2.07
NL106-403240	2-1/2 X 2 X 2-1/2	4.18	2.69	2.63	2.69
NL106-404016	2-1/2 X 2-1/2 X 1	2.98	1.88	1.88	2.38
NL106-404032	2-1/2 X 2-1/2 X 2	3.91	2.39	2.39	2.60
NL106-484832	3 X 3 X 2	5.61	2.52	2.52	2.89

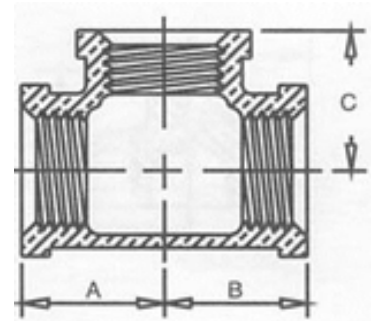

*Conforms with lead content requirements for lead-free plumbing as defined by the U.S. Safe Drinking Water Act. Certified <0.25 weighted average % lead.



MERIT BRASS

DIRECTING THE FLOW OF *Quality*

DIMENSIONAL SPECIFICATIONS

LEAD-FREE DOMESTIC BRASS FITTINGS* 125 LB.

CROSS

Part #	Size (IN.)	Approx. Net WT. (LB.)	A	B
NL110-04	1/4	0.16	0.71	0.71
NL110-06	3/8	0.23	0.82	0.82
NL110-08	1/2	0.34	1.01	1.01
NL110-12	3/4	0.55	1.18	1.18
NL110-16	1	0.95	1.43	1.43
NL110-20	1-1/4	1.94	1.69	1.69
NL110-24	1-1/2	2.95	1.84	1.84
NL110-32	2	7.84	2.12	2.12

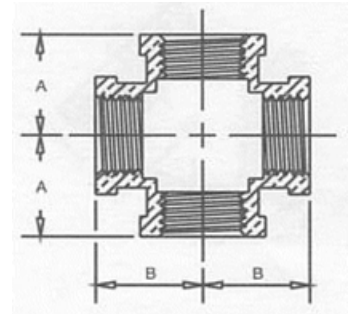

CAP

Part #	Size (IN.)	Approx. Net WT. (LB.)	A
NL116-02	1/8	0.04	0.49
NL116-04	1/4	0.07	0.59
NL116-06	3/8	0.10	0.66
NL116-08	1/2	0.12	0.78
NL116-12	3/4	0.21	0.84
NL116-16	1	0.30	1.00
NL116-20	1-1/4	0.45	1.13
NL116-24	1-1/2	0.65	1.16
NL116-32	2	1.10	1.34
NL116-40	2-1/2	1.79	1.72
NL116-48	3	1.78	1.81
NL116-64	4	5.59	2.09

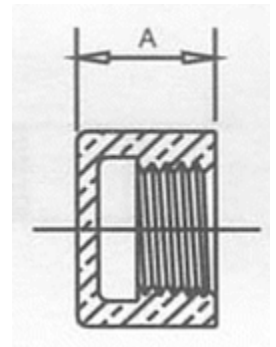

*Conforms with lead content requirements for lead-free plumbing as defined by the U.S. Safe Drinking Water Act. Certified <0.25 weighted average % lead.



MERIT BRASS

DIRECTING THE FLOW OF *Quality*

DIMENSIONAL SPECIFICATIONS

LEAD-FREE DOMESTIC BRASS FITTINGS* 125 LB.

COUPLING

Part #	Size (IN.)	Approx. Net WT. (LB.)	A
NL111-02	1/8	0.06	0.80
NL111-04	1/4	0.08	0.80
NL111-06	3/8	0.12	1.05
NL111-08	1/2	0.25	1.29
NL111-12	3/4	0.30	1.43
NL111-16	1	0.45	1.68
NL111-20	1-1/4	0.65	1.86
NL111-24	1-1/2	0.90	1.92
NL111-32	2	1.35	2.20
NL111-40	2-1/2	2.40	2.88
NL111-48	3	3.45	3.18
NL111-64	4	5.03	3.69

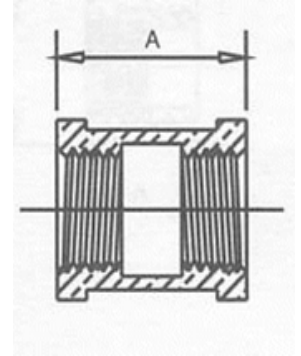

*Conforms with lead content requirements for lead-free plumbing as defined by the U.S. Safe Drinking Water Act. Certified <0.25 weighted average % lead.



MERIT BRASS

DIRECTING THE FLOW OF *Quality*

DIMENSIONAL SPECIFICATIONS

LEAD-FREE DOMESTIC BRASS FITTINGS* 125 LB.

REDUCING COUPLING

Part #	Size (IN.)	Approx. Net WT. (LB.)	A
NL112-0604	3/8 X 1/4	0.09	0.92
NL112-0806	1/2 X 3/8	0.16	1.17
NL112-1206	3/4 X 3/8	0.23	1.35
NL112-1208	3/4 X 1/2	0.25	1.35
NL112-1612	1 X 3/4	0.35	1.56
NL112-2012	1-1/4 X 3/4	0.62	1.77
NL112-2408	1-1/2 X 1/2	0.59	1.80
NL112-2412	1-1/2 X 3/4	0.65	1.80
NL112-2416	1-1/2 X 1	0.60	1.80
NL112-2420	1-1/2 X 1-1/4	0.75	1.80
NL112-3216	2 X 1	1.00	2.03
NL112-3220	2 X 1-1/4	1.05	2.03
NL112-4032	2-1/2 X 2	1.71	3.25
NL112-4832	3 X 2	2.70	3.69
NL112-4840	3 X 2-1/2	3.33	3.69
NL112-6432	4 X 2	4.29	4.38

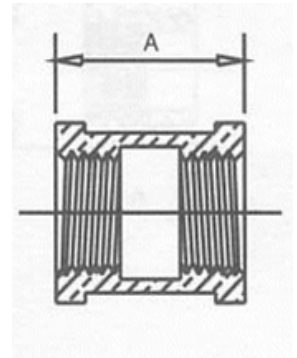

*Conforms with lead content requirements for lead-free plumbing as defined by the U.S. Safe Drinking Water Act. Certified <0.25 weighted average % lead.



MERIT BRASS

DIRECTING THE FLOW OF *Quality*

DIMENSIONAL SPECIFICATIONS

LEAD-FREE DOMESTIC BRASS FITTINGS* 125 LB.

HEX BUSHING

Part #	Size (IN.)	Approx. Net WT. (LB.)	A	B	C	D
NL114-0802	1/2 X 1/8	0.09	0.75	0.56	0.50	0.88
NL114-0804	1/2 X 1/4	0.10	0.75	0.56	0.43	0.88
NL114-0806	1/2 X 3/8	0.06	0.75	0.56	0.34	0.88
NL114-1202	3/4 X 1/8	0.14	0.88	0.63	0.25	1.16
NL114-1204	3/4 X 1/4	0.15	0.85	0.63	0.53	1.16
NL114-1206	3/4 X 3/8	0.14	0.85	0.63	0.49	1.16
NL114-1208	3/4 X 1/2	0.11	0.85	0.63	0.32	1.16
NL114-1602	1 X 1/8	0.22	1.06	0.75	0.75	1.44
NL114-1604	1 X 1/4	0.25	1.05	0.75	0.73	1.44
NL114-1606	1 X 3/8	0.20	1.05	0.75	0.69	1.13
NL114-1608	1 X 1/2	0.25	1.00	0.75	0.57	1.13
NL114-1612	1 X 3/4	0.19	1.00	0.75	0.50	1.13
NL114-2008	1-1/4 X 1/2	0.40	1.14	0.80	0.71	1.34
NL114-2012	1-1/4 X 3/4	0.43	1.1	0.80	0.64	1.76
NL114-2016	1-1/4 X 1	0.30	1.08	0.80	0.47	1.78
NL114-2412	1-1/2 X 3/4	0.50	1.20	0.83	0.70	1.63

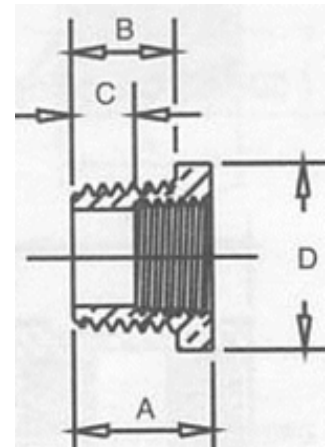

*Conforms with lead content requirements for lead-free plumbing as defined by the U.S. Safe Drinking Water Act. Certified <0.25 weighted average % lead.



MERIT BRASS

DIRECTING THE FLOW OF *Quality*

DIMENSIONAL SPECIFICATIONS

LEAD-FREE DOMESTIC BRASS FITTINGS* 125 LB.

HEX BUSHING CONTINUED

Part #	Size (IN.)	Approx. Net WT. (LB.)	A	B	C	D
NL114-2416	1-1/2 X 1	0.45	1.14	0.83	0.56	2.00
NL114-2420	1-1/2 X 1-1/4	0.35	1.14	0.83	0.43	2.00
NL114-3204	2 X 1/4	0.66	1.25	0.25	0.73	2.38
NL114-3208	2 X 1/2	1.00	1.31	0.88	0.88	1.34
NL114-3212	2 X 3/4	0.95	1.31	0.88	0.81	1.63
NL114-3220	2 X 1-1/4	0.75	1.22	0.88	0.55	2.50
NL114-3224	2 X 1-1/2	0.65	1.22	0.88	0.52	2.50
NL114-4016	2-1/2 X 1	1.03	1.53	1.09	0.94	1.97
NL114-4020	2-1/2 X 1-1/4	1.07	1.53	1.09	0.84	2.97
NL114-4032	2-1/2 X 2	1.15	1.44	1.07	0.69	2.41
NL114-4816	3 X 1	1.97	1.63	1.13	1.03	3.50
NL114-4820	3 X 1-1/4	1.75	1.63	1.13	0.94	3.50
NL114-4824	3 X 1-1/2	1.52	1.63	1.13	0.91	3.50
NL114-4832	3 X 2	1.65	1.61	1.13	0.86	3.50
NL114-4840	3 X 2-1/2	1.70	1.53	1.13	0.61	3.88

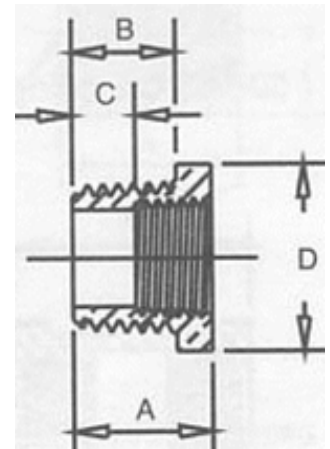

*Conforms with lead content requirements for lead-free plumbing as defined by the U.S. Safe Drinking Water Act. Certified <0.25 weighted average % lead.



MERIT BRASS

DIRECTING THE FLOW OF *Quality*

DIMENSIONAL SPECIFICATIONS

LEAD-FREE DOMESTIC BRASS FITTINGS* 125 LB.

SQUARE HEAD CORED PLUG

Part #	Size (IN.)	Approx. Net WT. (LB.)	A	B	C
NL117-08	1/2	0.11	0.54	0.38	0.56
NL117-12	3/4	0.15	0.55	0.44	0.63
NL117-16	1	0.26	0.69	0.50	0.81
NL117-20	1-1/4	0.35	0.71	0.56	0.94
NL117-24	1-1/2	0.45	0.73	0.62	1.13
NL117-32	2	0.60	0.76	0.68	1.31
NL117-40	2-1/2	1.13	1.07	0.74	1.50
NL117-48	3	1.90	1.13	0.80	1.69
NL117-64	4	3.22	1.22	0.92	2.25

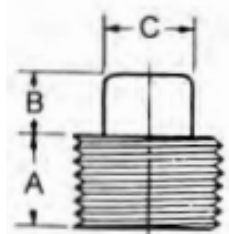

SQUARE HEAD SOLID PLUG

Part #	Size (IN.)	Approx. Net WT. (LB.)	A	B	C
NL117A-06	3/8	0.06	0.41	0.31	0.44
NL117A-08	1/2	0.12	0.54	0.38	0.56
NL117A-12	3/4	0.20	0.55	0.44	0.63
NL117A-16	1	0.25	0.69	0.50	0.81
NL117A-20	1-1/4	0.60	0.71	0.56	0.94
NL117A-24	1-1/2	0.76	0.73	0.62	1.13
NL117A-32	2	1.13	0.76	0.68	1.31
NL117A-40	2-1/2	2.26	1.07	0.74	1.50

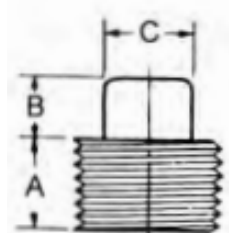

*Conforms with lead content requirements for lead-free plumbing as defined by the U.S. Safe Drinking Water Act. Certified <0.25 weighted average % lead.



MERIT BRASS

DIRECTING THE FLOW OF *Quality*

DIMENSIONAL SPECIFICATIONS

LEAD-FREE DOMESTIC BRASS FITTINGS* 125 LB.

SQUARE COUNTERSUNK PLUG

Part #	Size (IN.)	Approx. Net WT. (LB.)	A
NL118-08	1/2	0.06	0.54
NL118-12	3/4	0.09	0.55
NL118-16	1	0.23	0.69
NL118-20	1-1/4	0.34	0.71
NL118-24	1-1/2	0.48	0.73
NL118-32	2	0.80	0.76
NL118-48	3	2.55	1.13

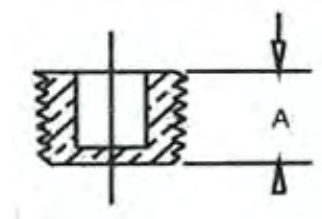

HEX LOCKNUT

Part #	Size (IN.)	Approx. Net WT. (LB.)	A	B
NL119-02	1/8	0.04	0.88	0.25
NL119-04	1/4	0.04	0.88	0.25
NL119-06	3/8	0.03	1.00	0.28
NL119-08	1/2	0.07	1.28	0.31
NL119-12	3/4	0.08	1.50	0.28
NL119-16	1	0.11	1.75	0.34
NL119-20	1-1/4	0.17	2.09	0.38
NL119-24	1-1/2	0.28	2.44	0.41
NL119-48	3	1.70	4.25	0.63

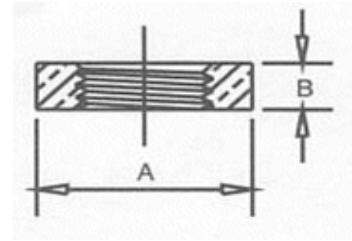

*Conforms with lead content requirements for lead-free plumbing as defined by the U.S. Safe Drinking Water Act. Certified <0.25 weighted average % lead.



MERIT BRASS

DIRECTING THE FLOW OF *Quality*

DIMENSIONAL SPECIFICATIONS

LEAD-FREE DOMESTIC BRASS FITTINGS* 125 LB.

UNION

Part #	Size (IN.)	Approx. Net WT. (LB.)	A
NL187-04	1/4	0.20	1.25
NL187-06	3/8	0.30	1.48
NL187-08	1/2	0.45	1.56
NL187-12	3/4	0.62	1.87
NL187-16	1	0.85	2.11
NL187-20	1-1/4	1.40	2.34
NL187-24	1-1/2	1.75	2.65
NL187-32	2	2.75	2.96

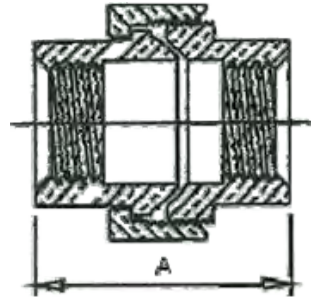

EXTENSION PIECE

Part #	Size (IN.)	Approx. Net WT. (LB.)	A
NL232-08	1/2	0.19	1.47
NL232-12	3/4	0.26	1.81
NL232-16	1	0.45	2.19

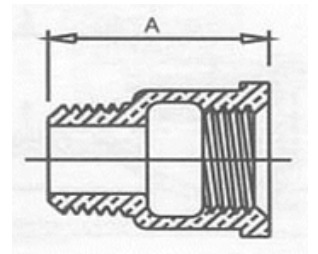

*Conforms with lead content requirements for lead-free plumbing as defined by the U.S. Safe Drinking Water Act. Certified <0.25 weighted average % lead.



MERIT BRASS

DIRECTING THE FLOW OF *Quality*