



MULTI FITTINGS
HIGHER STANDARDS™



Trench Tough Plus™

Blue Brute®

Cycle Tough®

Ultra-Rib®

Solvent Weld PVC DWV

Installation Guide

www.multifittings.com

Multi Fittings Corp. maintains a policy of ongoing product improvement. This may result in modification of features or specifications without notice.

This booklet is meant as a general installation guide for Trench Tough Plus™, Blue Brute®, Cycle Tough®, Ultra-Rib® and Solvent Weld & PVC DWV fittings. For specific needs or applications, please contact your local supplier or one of our customer service offices.

TABLE OF CONTENTS

INTRODUCTION	5
MULTI FITTINGS MEET THESE STANDARDS	6
Abbreviations	6
Pressure Fittings	6
Gasketed Sewer Fittings	6
PVC DWV Fittings - Solvent Weld	7
SDR35 Sewer Fittings - Solvent Weld	7
RECEIVING AND HANDLING FITTING SHIPMENTS	8
Before Accepting the Shipment	8
Storage at the Job Site	8
Extremely Cold Weather	9
Prolonged Outdoor Storage	9
UNDERGROUND BURIAL OF FITTINGS	10
Trench Preparation	10
Safety	10
Excavating and Preparing the Trench	10
Flotation	11
The Bottom of the Trench	11
Lowering the Fittings into the Trench	11
HAUNCHING & BACKFILLING	12
Initial Backfill	12
Final Backfill	12
Compacting the Backfill	13
Embedment Materials	14
Selection of Embedment Materials	15



GASKETED PVC PRESSURE FITTINGS**PREPARING FOR ASSEMBLY16**

Preparing the Spigot17

Assembling the Joint18

CURVATURE IN THE PIPELINE SYSTEM20

Using Blue Brute or Cycle Tough Fittings20

Deflecting the Fitting Joint21

OUTSIDE DIAMETER CONSIDERATIONS22

Blue Brute Fittings Cast Iron Outside Diameter (CIOD) .22

Blue Brute Dimensional Data23

Cycle Tough IPS Fittings Outside Diameter27

Cycle Tough Engineered Joint27

Cycle Tough Dimensional Data29

FABRICATED PVC PRESSURE FITTINGS36

Fabricated Fittings36

Butt Fusion Fabricated Fittings37

Butt Weld Fabricated Fittings37

RESISTING THRUST AT PRESSURE FITTINGS & VALVES38

Bearing Strength of Undisturbed Soils39

Resisting Thrust in Very Poor Soils40

Resisting Vertical Thrust41

Holding Pipe and Fittings to Steep Slopes42

Mechanical Thrust Restraints for Fittings42

FLANGED JOINTS43

Service Connections43

Tapped Couplings43

THE PIPELINE44

Leakage and Pressure Tests44

Repairs45

TRENCH TOUGH PLUS AND ULTRA-RIB GASKETED SEWER FITTINGS

STARTING THE JOB	47
Gaskets	47
Line and Grade	47
Assembly of Fittings	47
Lubricant	50
Curved Sewers	50
Field Cut Assembly	50
Manhole Connections	51
Service Connections	52
Sewer Laterals	54
Riser Problems Demand Special Attention	55
Backfilling and Tamping	56
Tamping Equipment	57
TESTING OF SEWERS	58
Joint Tightness Testing	58
Deflection Testing	60
Videos	63
Shallow Burial	63
Repairs	63

SOLVENT WELD SEWER AND DWV FITTINGS

SOLVENT CEMENTING	65
Basic Principles of Solvent Cementing	65
SOLVENT CEMENTING INSTRUCTIONS	67
Handling	67
Storage Conditions	67
Safety Precautions	67
Cold Weather	68
Preparation	68
Initial Set Time Schedule	72
Joint Cure Schedule	73



APPENDICES

APPENDIX I: Dimensions of Cycle Tough Pressure Pipes with IPS OD's	75
APPENDIX II: Dimensions of Blue Brute and Centurion Pressure Pipes with CIOD's	76
APPENDIX III: Percent % Deflection of Blue Brute Pipe and Blue Brute C907 Fittings	77
APPENDIX IV: Percent % Deflection for Centurion Pipe and Fabricated Blue Brute s C900 Fittings	78
APPENDIX V: Percent % Deflection for Cycle Tough Pipe and Fittings	79
APPENDIX VI: Percent % Deflection for Trench Tough Plus SDR35 and Trench Tough Plus SDR26 Heavy Wall Fittings ..	80
APPENDIX VII: Pipe Dimensions	82
APPENDIX VIII: Lubricant Usage	84

INTRODUCTION

This booklet will meet the needs of fitting installers looking for general recommendations on how to install Blue Brute®, Cycle Tough®, Trench Tough Plus™ gasketed sewer, Ultra-Rib®, Solvent Weld sewer and PVC DWV fittings. Out-of-the-ordinary conditions not covered here should be referred to the Engineer or his inspectors to provide on-site solutions. In such cases Multi's advice is always available. Our objective is to encourage the use of methods that lead to a professional installation that will ensure the maximum service life for our fittings.

The Engineer who designs the pipe and fitting system will determine how it should be installed. It is not our intention that the Guide should assume that responsibility unless the Engineer so directs the installer.

This booklet sets out the preferred methods of installation based on Multi's experience and on a number of published reports from other industry sources. Users will find additional helpful advice published by the Uni-Bell PVC Pipe Association and available from Multi on request.

Readers are invited to order a copy of the "Uni-Bell Handbook of PVC Pipe - Design and Construction". This comprehensive reference manual, with over 400 pages, covers all aspects of design and installation for PVC pipe and fittings. Call Uni-Bell at (972) 243-3902 to order.

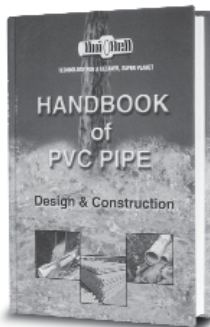

MULTI FITTINGS MEETS THESE STANDARDS

The list below identifies some industry standards in use today regarding manufacturing, quality control and proper installation of PVC sewer pipe and fittings.

ABBREVIATIONS

CSA	Canadian Standards Association
ASTM	American Society for Testing and Materials
UNI-B	Uni-Bell PVC Pipe Association
AASHTO	American Association of State Highway and Transportation Officials
AWWA	American Water Works Association
NSF	National Sanitation Foundation

PRESSURE FITTINGS

CSA B137.2	PVC Injection Molded Gasketed Fittings for Pressure Applications
CSA B137.3	Large Diameter Fabricated PVC Pressure Fittings
AWWA C900	Polyvinyl Chloride (PVC) Fabricated Fittings 10" through 12"
AWWA C907	Polyvinyl Chloride (PVC) Injection Molded Pressure Fittings for water - 4" through 12"
AWWA C905	Polyvinyl Chloride (PVC) Fabricated Fittings, 14" through 48"
AWWA C605	Underground Installation of Polyvinyl Chloride (PVC) Pressure Pipe
ASTM D2241	Polyvinyl Chloride (PVC) Pressure Rated Pipe (SDR Series)

GASKETED SEWER FITTINGS

CSA B182.1	Plastic Drain and Sewer Pipe and Fittings
CSA B182.2	PVC Sewer Pipe and Fittings
CSA B182.4	Profile (Ribbed) PVC Sewer Pipe and Fittings
CSA B182.11	Recommended Practice for the Installation of Thermoplastic Drain, Storm & Sewer Pipe and Fittings
ASTM D2321	Underground Installation of Flexible Thermoplastic Sewer Pipe

ASTM D3034	Type PSM Polyvinyl Chloride (PVC) Sewer Pipe and Fittings
ASTM D3212	Joints for Drain and Sewer Plastic Pipes Using Flexible Elastomeric Seals
ASTM F477	Elastomeric Seals for Joining Plastic Pipes
ASTM F679	Polyvinyl Chloride (PVC) Large Diameter Plastic Gravity Sewer
ASTM F794	Polyvinyl Chloride (PVC) Ribbed Gravity Sewer Pipe and Fittings
ASTM F913	Thermoplastic Elastomeric Seals (Gaskets) for Joining Plastic Pipe
ASTM F1336	Polyvinyl Chloride (PVC) Gasketed Sewer Fittings
UNI-B-6	Recommended Practice for Low-Pressure Air Testing of Installed Sewer Pipe
UNI-PUB-6	Installation Guide for PVC Sewer Pipe
UNI-TR-1	Deflection: The Pipe/Soil Mechanism
UNI-TR-6	PVC Force Main Design
AASHTO M278	Class PS46 Polyvinyl Chloride (PVC) Piping Systems for Subsurface Drainage of Transportation Facilities
AASHTO M304	Polyvinyl Chloride (PVC) Ribbed Drain Pipe and Fittings Based on Controlled Inside Diameter

PVC DWV FITTINGS - SOLVENT WELD

NSF 14	Plastic Piping Systems Components & Related Materials
ASTM F1866	PVC Plastic Schedule 40 Drainage and DWV Fabricated Fittings
ASTM D2665	Polyvinyl Chloride (PVC) Plastic Drain Waste and Vent Pipe and Fittings

SDR35 SEWER FITTINGS - SOLVENT WELD

CSA B182.1	Plastic Drain and Sewer Pipe and Fittings
CSA B182.2	PVC Sewer Pipe and Fittings
ASTM D3034	Type PSM Polyvinyl Chloride (PVC) Sewer Pipe and Fittings
ASTM D2729	Polyvinyl Chloride (PVC) Sewer Pipe and Fittings



RECEIVING AND HANDLING FITTING SHIPMENTS

BEFORE ACCEPTING THE SHIPMENT

Our fittings are manufactured to a number of standards, none of which are more demanding than Multi's own Standard Product Specifications. Quality Control inspection of the products before they leave our plants ensures that only the highest quality products are shipped. Damage to the fittings, or shortages, are possible and must be checked before the shipment is received and signed for by the contractor.

1. The contractor should inspect each fitting as it is unloaded.
2. Check the quantity shipped against the tally sheet. The contractor must note any shortages on the trucker's bill of lading.
3. Carefully note any sign of damage to the fittings in the form of cracks, chips or other damage.
4. **DO NOT THROW AWAY ANY DAMAGED MATERIAL.** Mark it carefully for further inspection by the carrier or their representative.
5. Re-order any fittings that are needed to make up for missing or damaged fittings.
6. Notify the carrier immediately and enter a claim for damaged or missing parts in accordance with their instructions.

STORAGE AT THE JOB SITE

The preferred method of storage at the job site is in boxes or crates as shipped.

EXTREMELY COLD WEATHER

Although PVC fittings have very good impact resistance, they offer slightly reduced impact resistance at very low temperatures (below freezing). Do not allow the fittings to fall or be thrown off the truck or into the trench.

PROLONGED OUTDOOR STORAGE

Prolonged exposure of PVC fittings to the direct rays of the sun will not damage the fittings. However, some mild discoloration may take place in the form of a milky film on the exposed surfaces. This change in color merely indicates that there has been a harmless chemical transformation at the surface of the fitting. Physical properties such as pipe stiffness and tensile strength are unaffected by surface discoloration. However, a small reduction in impact strength could occur at the discolored surfaces. These are of a very small order and will not affect a proper field installation. Multi Fittings products that are exposed to sunlight will still exceed all of the impact requirements of the standards.

Discoloration of the fittings can be avoided by shading them from the direct rays of the sun. This can be accomplished by covering the fittings with an opaque material such as canvas. If the fittings are covered, always allow for the circulation of air through the fittings to avoid heat buildup in hot summer weather. Do not store the fittings in plastic bags in warm climates for long periods of time. Make sure that the fittings are not stored close to sources of heat such as boilers, steam lines, engine exhaust outlets, etc. If the fitting will be installed in an exposed application, the fitting can be protected by painting with a water based “**latex paint**” only.



UNDERGROUND BURIAL OF FITTINGS

TRENCH PREPARATION

SAFETY

Trenches can be dangerous places. The contractor is responsible for ensuring that all applicable regulations have been observed and that the protection of the workers and the general public is provided.

EXCAVATING AND PREPARING THE TRENCH

The drawings and bid documents will specify the correct line and grade to be established by the trenching operation. Aside from these engineering considerations good bedding practices make sense for all types of pipe and fittings, including PVC.

The width of the top of the trench will be determined by local conditions. But at the "fitting zone" the trench width should be kept to a practical minimum.

The general rule is that the maximum width at the top of the fitting should not be more than the outside diameter of the fitting plus 24". If trench width cannot be controlled and will exceed the minimum then compacted backfill must be provided for a distance of 2-1/2 fitting diameters to either side of the fitting or to the trench wall. This is applicable for fitting sizes up to 10". For larger sizes the compacted haunching material should be placed one fitting diameter or 24" (whichever is greater), to either side of the fitting. The placement of the backfill under the fitting haunches is important. For this reason you need enough room at the sides of the fitting to slice the material under the haunch and compact it. The minimum distance required is 8" on either side of the fitting.

Keep the three basic operations close together: digging, pipe and fitting laying and backfilling. The shortest practical stretch of open trench reduces the possibility of problems associated with water, frozen ground, impact damage, flotation and traffic.

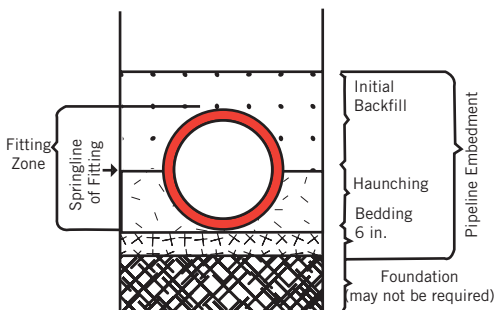

FLOTATION

Where the fitting is in a flooded condition and it is not possible to remove standing water from the trench, the fitting should be held at grade with a minimum backfill cover of twice the fitting diameter.

THE BOTTOM OF THE TRENCH

The objective of bedding is to provide a continuous support for the fitting at the required line and grade. Frozen material should not be used to support or bed the fitting. At least 4" of bedding material should be placed under the fitting if rocky conditions exist. The bedding may or may not be compacted, but in any event the projecting bells of the fitting should be properly relieved in the trench bottom so that the entire fitting is evenly supported by the bedding. Where the trench bottom is unstable (organic material, or "quick" sand or similar material), the trench bottom should be over-excavated and brought back to grade with an approved material.

LOWERING THE FITTINGS INTO THE TRENCH

Place the fittings into the trench by hand, using ropes and skids or slings on the backhoe bucket. Do not throw the fittings into the trench. At this point the fittings are in a good position for final inspection. Ensure there are no damaged materials before assembly begins.



HAUNCHING & BACKFILLING

The material placed to the sides of the fitting from the bedding to about the springline (center line) is intended to help the fitting support the vertical loads. It is frequently a material with sizes not larger than 1-1/2".

INITIAL BACKFILL

The material placed over the fitting itself to a height of 6" to 12" above the top of the fitting is the initial backfill. The maximum size of stone in the initial backfill, where not specified, should be 1-1/2". Where it is not otherwise specified, the initial backfill may consist of the native material in the trench provided it is free from large stones, not frozen, and free of debris or other organic materials. The purpose of the initial backfill is to protect the fitting and the pipeline from the final backfill.

FINAL BACKFILL

The material placed over the initial backfill to the top of the trench is the final backfill. If not otherwise specified, the final backfill material may contain boulders up to 6" in diameter and may consist of native material.

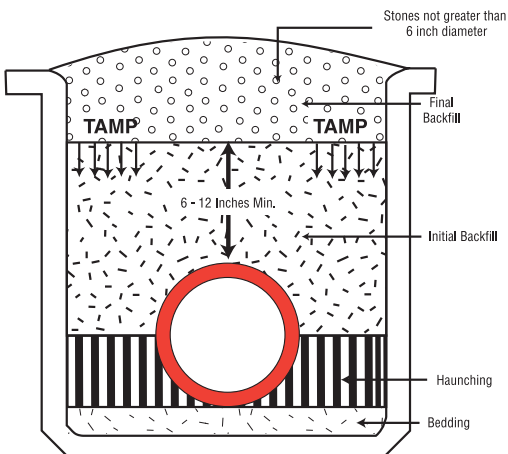

COMPACTING THE BACKFILL

Compact the haunching, initial backfill and final backfill in accordance with the job drawings. Observe the following precautions.

1. When a "self-compacting" material is used, such as crushed stone, ensure that the material does not arch or bridge beneath the haunch of the fitting. Remove such voids with the tip of a spade.
2. When compacting the material underneath and at either side of the fitting, do not allow the tool or the machine to strike the fitting.
3. When compaction in excess of 85% standard proctor density is required in the haunching area, ensure that the compacting effort does not dislodge the pipeline from the correct grade. If the compacting effort dislodges the fitting, re-lay the fitting to the correct grade.

PVC pressure fittings (DR14, DR18 and DR25) may be buried with as little as 12" of cover and be subjected to H-20 traffic loading. A minimum soil stiffness of $E' = 1,000$ psi is recommended in the fitting zone of the trench for these conditions and this type of fitting.

PVC gasketed sewer fittings, with a minimum pipe stiffness of 46 psi (DR35), may be buried with as little as 12" of cover and be subjected to H-20 traffic loading. A minimum soil stiffness of $E' = 1,000$ psi is recommended in the fitting zone of the trench for these conditions.

For pressure or gasketed sewer fittings with a minimum pipe stiffness less than 46 psi (DR41 and DR51) a minimum cover of 24" is required with a minimum soil stiffness of $E' = 1,000$ psi.

4. It is not necessary to compact the initial backfill directly over the top of the fitting for the sake of the fitting's structural strength. However, it may be necessary for the sake of roadway integrity.



5. A matrix of embedment materials can be successfully used with PVC fittings. Consult the table found in Appendices III, IV or V on pages 77 - 79 for the expected deflection given a particular embedment material, compacted to a certain density. As can be seen in this chart, at normal depths under 16' of cover, compaction effort is used strictly to prevent trench settlement.

EMBEDMENT MATERIALS

Some general rules about all soils to be used in a buried pipeline trench include that they must be free of sharp objects, sticks, large clumps, frozen material, organic materials and boulders.

Most of the soil commonly found can be classified into one of the following categories, which are referenced from ASTM D2487.

Class 1

Angular, 1/4" - 1-1/2" graded stone, including a number of fill materials such as coral, slag, cinders, crushed stone or crushed shells.

Class 2

Coarse sands and gravels with a maximum particle size of 1-1/2", including various graded sands and gravels containing small percentages of fines, generally granular and non-cohesive.

Class 3

Fine sand and clayey gravels, including fine sands, sand-clay mixtures and gravel-clay mixtures.

Class 4

Silt, silty clays and clays including inorganic clays and silts of medium to high plasticity and liquids limits.

Class 5

Includes organic soils such as frozen earth, debris and other foreign materials. These materials are not recommended for use in the bedding, haunch or initial backfill zones.

Note: The performance of a flexible conduit does not depend only on the class of embedment materials used, but more importantly on the density achieved in compaction of the haunching material.

SELECTION OF EMBEDMENT MATERIALS

Soil to be used in the pipe zone should be capable of maintaining the specified soil density. For example, if a coarse material such as Class 1 is used for bedding the pipe, it should also be used in the haunch zone to the springline of the pipe. Otherwise, side support may be lost due to migration of the Class 2, 3 or 4 materials into the bedding.

When selecting the embedment materials, ensure that native soil migration from the trench walls cannot occur. A well-graded compacted granular material will prevent this condition from occurring. In trenches subject to inundation, the granular material should be compacted to a minimum of 85% Standard Proctor Density.



GASKETED PVC PRESSURE FITTINGS

PREPARING FOR ASSEMBLY

All Multi PVC gasketed pressure fittings are prepared for assembly as follows:

Keep both the spigot of the pipe and the bell of the fitting clean. It is good practice to lay the pipeline with the bells forward so that the assembly operation will consist of pushing the spigot into the bell. This will minimize the



possibility of contaminating the surfaces with foreign material. All assemblies should be concentric.

Use an approved lubricant for all gasketed fittings. Apply an NSF approved lubricant with pressure fittings used with potable water. The use of substitute lubricants that are not NSF approved may damage the gaskets and should not be used.

Before inserting the spigot into the sealing gasket of the fitting, make sure that the gasket is clean and that the groove is free of any debris or dirt.

PREPARING THE SPIGOT

Pipe is generally shipped with a chamfer on the end of the spigot. If there is no chamfer, follow the example of a factory made spigot and machine a suitable chamfer for easy insertion into the gasketed fittings.



From the chamfer using a beveling tool, hand rasp or disk cutter.

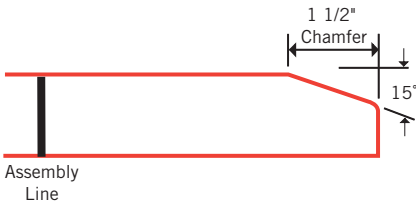

Apply a thin coating of lubricant (about 1/32" thick, equivalent to a brushed coating) using a glove, a rag, or a paint brush. The area to be covered is as follows:

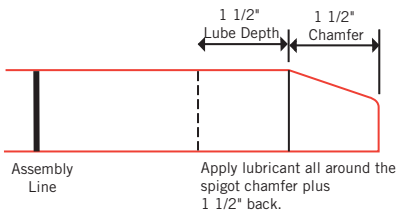
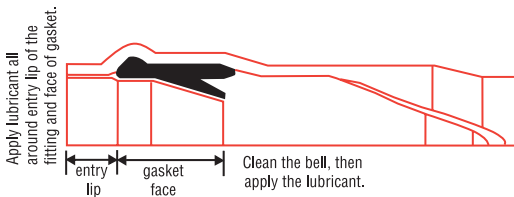

*For proper lubricant usage refer to page 84.



ASSEMBLING THE JOINT

Assemble the joint with a come-along and chain or use one of the methods illustrated below.

The correct insertion depth in fitting bells differs from the correct insertion depth for pipe bells. Factory-applied assembly lines on pipe spigots should be ignored when assembled to fittings. Special assembly lines may be marked on pipe ends by measuring the depth of the fitting bell.

Successful assemblies of fittings have been made by forming a scissors grip on the leading bell with two implanted crowbars. See Figure 1.

Assembly using two crowbars is made easier when a special collar is attached to the bell behind the gasket race. Two projections at either side of the collar allow a more substantial grip in the bell. See Figure 2.

When assembling in-line bell fittings such as couplings and tees, a crowbar and a 2 x 4 are all that's needed. See Figure 3.

For deflection fittings such as 45° elbows an assembly jig should be used to transfer the assembly effort to the bell being assembled rather than directly to the edge of the trailing bell. The jig illustrated is typical. See Figure 4.

The hinged “clamshell” of the assembly jig is opened and positioned behind the gasket race of the bell as shown in Figure 4. The two halves are pulled tightly together with the chain and fixed by looping a link of the chain through the slot in the hinged arm. The fitting can then be levered home. If the clamshell tends to ride over the gasket race,

Fig. 1

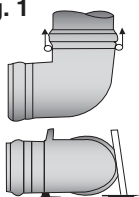

Fig. 2

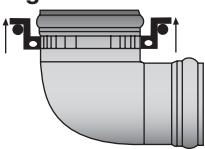

Fig. 3

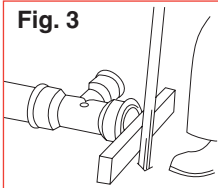

Fig. 4

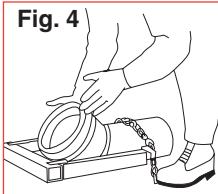
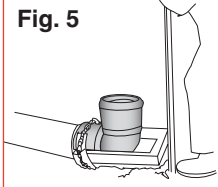

Fig. 5



stop the operation and retighten the chain. If the trailing bell faces the wrong direction after assembly, immediately rotate it by hand to the correct position. See Figure 5.

Adjoining lengths of pipe can be assembled in the usual way with suitable support for the fitting when it is not fixed in position by backfills.

See Figure 6.

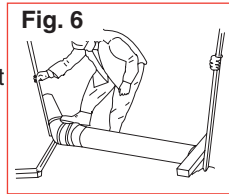

FOR SIZES OVER 12 INCHES

Keeping the pipe spigot out of the dirt, position it so that the chamfer is resting against the gasket in the bell of the fitting. Push the spigot into the bell so that the assembly line on the spigot is even with the edge of the bell. If there are two assembly lines the edge of the bell should line up between the two lines.

The assembly effort can be delivered by hand in small diameters with the aid of a twist as the spigot enters the bell of the fitting, or by using a bar and block. Other assembly methods include lever pullers, hydraulic jacks, and for large diameter pipe and fittings the IPEX Sure Joint Puller or a backhoe bucket.

Where mechanical means are used, the assembly effort should not be applied directly to the edge of the fitting. A two by four or a plank should be placed between the backhoe bucket and the edge of the fitting. The use of a backhoe bucket has the disadvantage that the backhoe operator is unable to see clearly when the assembly is complete. A helper should be located near the assembly to signal when the insertion is complete.

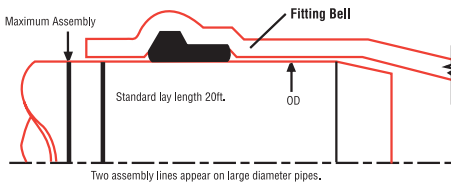

OVER-ASSEMBLY OF THE JOINT COULD DAMAGE THE FITTING. ALWAYS MAKE SURE THAT PREVIOUSLY ASSEMBLED JOINTS REMAIN UNDISTURBED.

If resistance is felt to the assembly it may mean that the sealing gasket has somehow become dislodged. If so, the joint should be disassembled, cleaned, and reconstructed in accordance with the methods given above.



CURVATURE IN THE PIPELINE SYSTEM

There are two common methods used to achieve changes in direction with Multi pressure fittings. They are 1) using Blue Brute or Cycle Tough fittings and 2) deflecting the joint.

A. USING BLUE BRUTE OR CYCLE TOUGH FITTINGS

Changes in direction in a pipeline can also be achieved by using PVC fittings. Multi offers standard 90°, 45°, 22½° and 11¼° bends. (Special radius bends are available upon request.) Multi also offers 5° CIOD sweeps in DR18 up to 16". The sweeps are bell x spigot as illustrated below.

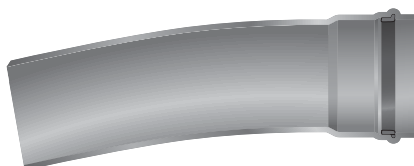

The cut lengths and radii are as follows:

Size (in)	Cut Length (in)	Radius (ft)
6	36	36
8	36	36
10	42	43
12	48	46
14	60	59
16	72	69

B. DEFLECTING THE FITTING JOINT

The close tolerances of Multi Fitting joints limit the amount of unstressed deflection that can be taken by offsetting a straight length of pipe. Injection Molded Blue Brute and Cycle Tough fittings offer a 1° change in direction at each bell. The procedure is as follows:

1. Make a concentric assembly, but push the spigot into the bell of the fitting only to a point about $1/2"$ short of the measured fitting bell depth. This incomplete assembly permits more movement of the end of the pipe at the bottom of the bell of the fitting.
2. Shift the loose bell end of the assembled length by not more than the following recommended maximum offsets. Use only manual effort.

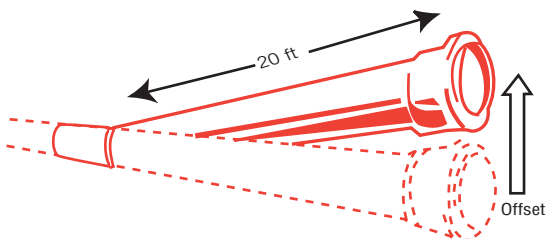

MAXIMUM RECOMMENDED OFFSETS, TO ACHIEVE MINIMUM CURVE RADIUS BY DEFLECTING A STRAIGHT LENGTH OF 20 FT. PIPE AT A FITTING JOINT (FOR ALL DIMENSION RATIOS)

PIPE SIZE inches	MAX OFFSET inches	ANGLE AT ONE BELL	RESULTING RADIUS OF CURVATURE USING 20 FOOT LENGTHS
Molded PVC Fittings (all sizes)	4	1° **	1146 ft**

** At each fitting bell. Bell by bell configurations such as Tee's and Couplings offer a total of 2° deflection per fitting.

Note: If shorter lengths of pipe are used, the above offset values must be multiplied by:

$$4" \times \frac{\text{length of pipe (in feet)}}{20}$$



OUTSIDE DIAMETER CONSIDERATIONS

Multi pressure fittings are available in two different outside diameter dimensions in most nominal sizes. These are Cast Iron (CIOD) and Iron Pipe Size (IPS) Outside Diameters. The dimensions for these two different outside diameters are shown in the Appendix on pages 75 and 76.

BLUE BRUTE® FITTINGS CAST IRON OUTSIDE DIAMETER (CIOD)

These are the fittings normally associated with the American Water Works Association Standards C900, C905 and C907. Multi offers sizes of 4", 6", 8", 10" and 12" with CIOD's in Class 100 (DR25), Class 150 (DR18) and Class 200 (DR14). Also available are fitting sizes 14" through 48" with CIOD's in PR 80 (DR51), PR100 (DR41), PR125 (DR32.5 to 42"), PR165 (DR25 to 36") and PR235 (DR18, to 24" only). All CIOD PVC Pressure Fittings by Multi are third party certified to CSA B137.3.

Multi Blue Brute PVC injection molded fittings are available for cast iron O.D. pipe in sizes 4" through 12". Direct assembly of CIOD pipes to these fittings should be made following the principles given in the previous sections. These fittings are supplied with the sealing gasket inserted in the bells. Special transition gaskets allow IPS O.D. pipe to also be used with Multi Blue Brute fittings. Injection molded Cycle Tough PVC fittings are also available for IPS O.D. pipes. Sealing gaskets supplied for these fittings are not interchangeable with the gaskets supplied for other pipes and fittings.

Note: Factory-made assembly lines on the pipe do not indicate correct assembly to fittings.

BLUE BRUTE DIMENSIONAL DATA

Below are the exterior dimensions for each of the molded Blue Brute fittings available from Multi.

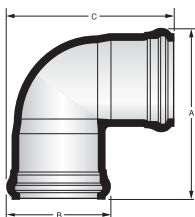

90° ELBOW				
Nominal Size (in)	A (in)	B (in)	C (in)	Wt./ (lbs)
4	10.14	6.25	10.14	4.7
6	13.90	8.88	13.90	15.1
8	16.90	11.36	16.90	28.0

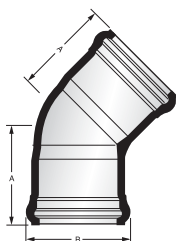

45° ELBOW			
Nominal Size (in)	A (in)	B (in)	Wt./ (lbs)
4	5.63	6.27	4.1
6	7.56	8.80	11.1
8	8.80	11.30	20.3

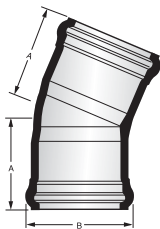

22½° ELBOW			
Nominal Size (in)	A (in)	B (in)	Wt./ (lbs)
6	6.82	8.84	10.3
8	7.90	11.30	19.2

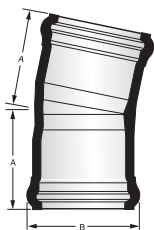

11½° ELBOW			
Nominal Size (in)	A (in)	B (in)	Wt./ (lbs)
6	6.45	8.84	10.0
8	7.48	11.30	18.0





REDUCING ADAPTER SPIGOT x BELL

Nominal Size (in)	A (in)	B (in)	Wt./ (lbs)
6 x 4	5.8	4.3	7.5
8 x 6	12.5	5.5	9.4
10 x 8	7.3	5.8	11.3
12 x 10	10.1	6.5	19.8

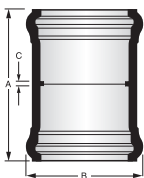

COUPLING

Nominal Size (in)	A (in)	B (in)	C (in)	Wt./ (lbs)
4	8.18	6.27	0.25	3.4
6	12.11	8.88	0.25	8.2
8	13.58	11.35	0.25	22.0
10	18.12	14.30	0.50	43.3
12	19.40	17.30	0.50	65.9

(available without center stop as a repair coupling)



PLUG

Nominal Size (in)	A (in)	Wt./ (lbs)
4	5.9	1.3
6	7.0	3.8
8	8.1	7.3
10	9.0	12.4
12	9.8	19.5

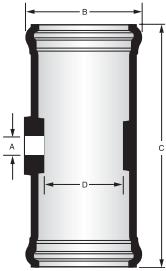

SINGLE TAPPED COUPLING

Nominal Size (in)	A (in)	B (in)	C (in)	D (in)	Wt./ (lbs)
4 x 4 x	3/4	6.27	10.20	4.43	4.0
4 x 4 x	1	6.27	10.20	4.43	4.0
6 x 6 x	3/4	8.74	14.38	6.06	10.6
6 x 6 x	1	8.74	14.38	6.06	10.6
6 x 6 x	1-1/2	8.74	14.38	6.06	10.6
6 x 6 x	2	8.74	14.38	6.06	10.6
8 x 8 x	3/4	11.30	15.00	7.91	17.3
8 x 8 x	1	11.30	15.00	7.91	17.3
8 x 8 x	1-1/2	11.30	15.00	7.91	17.3
8 x 8 x	2	11.30	15.00	7.91	17.3

Note: 3/4" Taps to 2", Taps: AWWA Thread

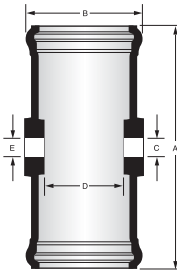

DOUBLE TAPPED COUPLING

Nominal Size (in)	A (in)	B (in)	C (in)	D (in)	E (in)	Wt./ (lbs)
6 x 6 x 3/4 x 3/4	14.38	8.74	3/4	6.06	3/4	10.5
6 x 6 x 1 x 3/4	14.38	8.74	1	6.06	3/4	10.5
6 x 6 x 1 x 1	14.38	8.74	1	6.06	1	10.5
6 x 6 x 1 1/4 x 3/4	14.38	8.74	1 1/4	6.06	3/4	10.5
6 x 6 x 1 1/4 x 1	14.38	8.74	1 1/4	6.06	1	10.5
6 x 6 x 1 1/2 x 3/4	14.38	8.74	1 1/2	6.06	3/4	10.5
6 x 6 x 1 1/2 x 1	14.38	8.74	1 1/2	6.06	1	10.5
6 x 6 x 2 x 3/4	14.38	8.74	2	6.06	3/4	10.5
6 x 6 x 2 x 1	14.38	8.74	2	6.06	1	10.5
8 x 8 x 3/4 x 3/4	15.00	11.30	3/4	7.91	3/4	17.0
8 x 8 x 1 x 3/4	15.00	11.30	1	7.91	3/4	17.0
8 x 8 x 1 x 1	15.00	11.30	1	7.91	1	17.0
8 x 8 x 1 1/4 x 3/4	15.00	11.30	1 1/4	7.91	3/4	17.0
8 x 8 x 1 1/4 x 1	15.00	11.30	1 1/4	7.91	1	17.0
8 x 8 x 1 1/2 x 3/4	15.00	11.30	1 1/2	7.91	3/4	17.0
8 x 8 x 1 1/2 x 1	15.00	11.30	1 1/2	7.91	1	17.0
8 x 8 x 2 x 3/4	15.00	11.30	2	7.91	3/4	17.0
8 x 8 x 2 x 1	15.00	11.30	2	7.91	1	17.0

Note: 3/4" Taps to 2", Taps: AWWA Thread



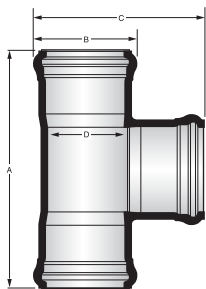

TEE

Nominal Size (in)	A (in)	B (in)	C (in)	D (in)	Wt./ (lbs)
4 x 4 x 4	14.04	6.27	10.15	4.88	6.6
6 x 6 x 4	16.99	8.88 6.27	12.43	6.93	18.7
6 x 6 x 6	18.92	8.88	13.90	6.93	26.3
8 x 8 x 4	18.55	11.37 6.27	14.68	9.13	35.6
8 x 8 x 6	20.48	11.37 8.88	16.14	9.13	26.6
8 x 8 x 8	22.46	11.37	16.91	9.13	31.4

CYCLE TOUGH® FITTINGS

OUTSIDE DIAMETER

Multi gasketed fittings with IPS O.D. (equivalent to steel pipe outside diameters) are available in sizes ranging from 1-1/2" through 24". 10" - 24" are certified to CSA B137.3 and 1-1/2" - 24" meet ASTM D2241. These pressure rated fittings are called Cycle Tough injection molded fittings and are manufactured with a resin having an HDB of 4000 psi - the same as the pipe. These fittings cannot be used directly on CIOD pipe but may be adapted to C900 Blue Brute pipe or C905 Centurion pipe by using transition adapters. These adapters are available with either spigot or bell ends and are approximately 24" long.

ENGINEERED JOINT

Cycle Tough fittings have a unique sealing system. The engineered joint is designed to withstand thousands of pressure cycles while providing a bottle tight joint. Some of the features of this unique pressure gasket system include:

1. Pressure pockets that transmit internal water pressure to the pipe spigot making a tight leakproof seal.
2. Second sealing lip creates a tight seal having ample sealing tolerance for pipes with nominal diameters.
3. High impact and high memory polypropylene lockrings prevent gasket movement from the raceway during assembly and normal pressure conditions.
4. The first smaller lip prevents foreign material from coming in contact with second sealing lip. It also centralizes the pipe spigot while at the same time preventing contact with the lockring.
5. Massive rubber area with a low compression set for outstanding compression seal.



6. An arched back pocket gives excellent tolerance to the gasket seat raceway. This transmits an even radial force from the locking to the gasket seat.
7. The gasket is completely injection molded (including color coded polypropylene locking) for better tolerance and dimension control.

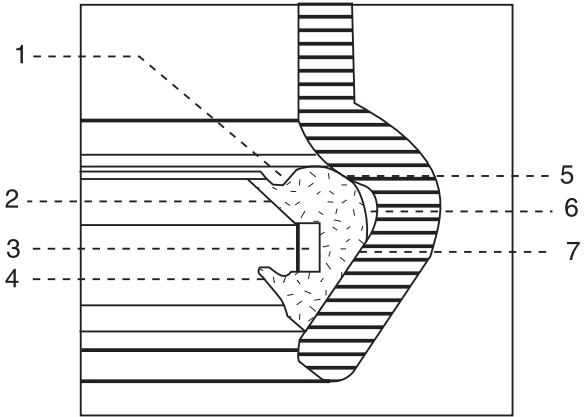

Joint Cutaway

CYCLE TOUGH® DIMENSIONAL DATA

Below are the exterior dimensions for each of the Cycle Tough molded fittings available from Multi.

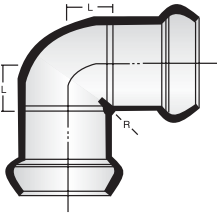

90° ELBOW G x G			
Nominal Size (in)	L (in)	R (in)	Wt./ (lbs)
2	1.18	0.75	0.8
2-1/2	1.80	1.00	1.1
3	2.00	1.00	1.7
4	2.20	1.00	3.3
6	2.80	1.25	10.5
8	4.87	1.50	19.9

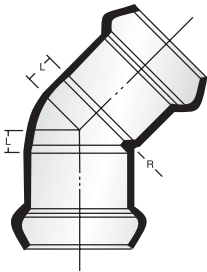

45° ELBOW G x G			
Nominal Size (in)	L (in)	R (in)	Wt./ (lbs)
2	0.60	0.75	0.7
2-1/2	1.80	1.00	1.0
3	1.12	1.00	1.8
4	1.10	1.00	3.2
6	1.60	1.25	8.5
8	2.40	1.50	17.3



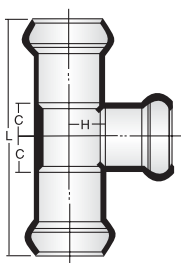

TEE G x G x G

Nominal Size (in)	C (in)	H (in)	L (in)	Wt./ (lbs)
2	1.30	1.10	7.60	1.2
2-1/2	1.67	1.63	9.50	1.7
3	1.99	1.99	10.80	2.8
4	2.57	2.65	12.50	4.7
6	3.76	3.76	14.90	14.4
8	4.91	4.91	21.65	26.0

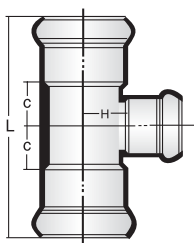

REDUCING TEE G x G x G

Nominal Size (in)	C (in)	H (in)	L (in)	Wt./ (lbs)
2 x 1½	1.30	1.10	7.60	1.0
2½ x 2	1.67	1.63	9.50	2.0
3 x 1½	1.85	1.60	10.80	2.3
3 x 2	1.85	1.60	10.80	2.5
3 x 2½	1.90	1.60	10.80	3.1
4 x 2	1.90	2.00	11.30	3.6
4 x 2½	1.90	2.00	11.30	3.7
4 x 3	1.90	2.00	11.30	4.1
6 x 2	2.40	2.80	14.90	9.6
6 x 2½	2.40	2.80	14.90	9.8
6 x 3	2.40	2.80	14.90	10.1
6 x 4	2.40	2.80	14.90	10.6
8 x 2	3.85	4.87	19.50	19.3
8 x 3	3.85	4.87	19.50	20.2
8 x 4	3.85	4.88	19.50	21.1
8 x 6	3.85	4.88	19.50	24.2

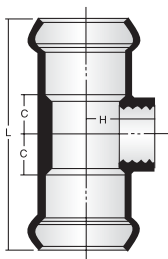

TAP SERVICE TEE NPT OUTLET

Nominal Size (in)	C (in)	H (in)	L (in)	Wt./ (lbs)
2 x 1/2	1.40	2.15	7.10	0.7
2 x 3/4	1.40	2.15	7.10	0.7
2 x 1	1.40	2.15	7.10	0.7
2 x 1 1/4	1.40	2.15	7.10	0.7
2 x 1 1/2	1.40	2.15	7.10	0.7
2 1/2 x 1/2	1.45	2.50	7.90	1.6
2 1/2 x 3/4	1.45	2.50	7.90	1.6
2 1/2 x 1	1.45	2.50	7.90	1.7
2 1/2 x 1 1/4	1.45	2.50	7.90	1.8
2 1/2 x 1 1/2	1.45	2.50	7.90	1.8
2 1/2 x 2	1.45	2.50	7.90	1.8
3 x 1/2	1.50	2.70	9.75	1.9
3 x 3/4	1.50	2.70	9.75	2.0
3 x 1	1.50	2.70	9.75	2.0
3 x 1 1/4	1.50	2.70	9.75	2.1
3 x 1 1/2	1.50	2.70	9.75	2.2
3 x 2	1.50	2.70	9.75	2.4
4 x 1/2	1.56	3.10	10.17	3.3
4 x 3/4	1.56	3.10	10.17	3.3
4 x 1	1.56	3.10	10.17	3.3
4 x 1 1/4	1.56	3.10	10.17	3.3
4 x 1 1/2	1.56	3.10	10.17	3.4
4 x 2	1.56	3.10	10.17	3.3
6 x 1/2	1.80	3.96	13.00	8.2
6 x 3/4	1.80	3.96	13.00	8.2
6 x 1	1.80	3.96	13.00	8.1
6 x 1 1/4	1.80	3.96	13.00	8.1
6 x 1 1/2	1.80	3.96	13.00	8.2
6 x 2	1.80	3.96	13.00	8.2



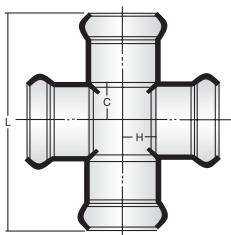

CROSS

G x G x G x G

Nominal Size (in)	C (in)	H (in)	L (in)	Wt./ (lbs)
4	4.00	4.00	12.50	6.3
6	4.50	4.50	16.00	19.5

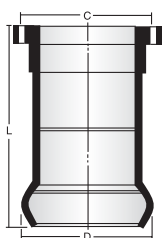

ADAPTER

FLANGE x GASKET BELL

Nominal Size (in)	C (in)	D (in)	L (in)	Wt./ (lbs)
1-1/2	3.85	5.00	4.25	0.9
2	4.75	6.00	4.75	1.6
2-1/2	5.50	7.00	5.75	2.2
3	6.00	7.50	6.50	3.1
4	7.48	9.02	10.52	4.8
6	9.55	10.97	13.48	10.5
8	11.75	13.50	12.00	19.1

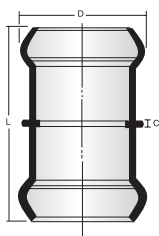

STOP COUPLING

G x G

Nominal Size (in)	L (in)	E (in)	Wt./ (lbs)
2	5.00	3.35	0.5
2-1/2	7.14	4.15	0.8
3	7.00	5.00	1.7
4	7.40	6.13	2.7
6	10.00	8.73	7.1
8	12.30	10.62	13.9

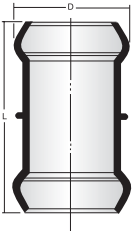

REPAIR COUPLING			
G x G			
Nominal Size (in)	L (in)	D (in)	Wt./ (lbs)
2	7.20	3.35	0.5
2-1/2	7.00	4.15	0.8
3	7.00	5.00	1.6
4	7.40	6.13	2.6
6	10.00	8.73	6.9
8	12.30	10.62	13.3



PERMANENT PLUG		
SPIGOT		
Nominal Size (in)	L (in)	Wt./ (lbs)
1-1/2	2.50	0.2
2	2.50	0.2
2-1/2	3.50	0.4
3	3.50	0.4
4	3.75	0.8
6	4.50	2.2

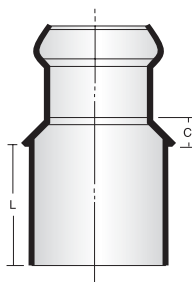

**INCREASER BUSHING****G x SP**

Nominal Size (in)	L (in)	C (in)	Wt./ (lbs)
1½ x 2	2.40	0.20	0.4
2 x 2½	2.40	0.20	0.6
2 x 3	3.40	0.55	0.7
2½ x 3	3.40	0.38	1.0
2 x 4	3.00	0.40	1.1
2½ x 4	3.00	0.40	1.3
3 x 4	3.00	0.40	1.6
2 x 6	4.30	0.50	3.0
2½ x 6	4.30	0.50	3.3
3 x 6	4.30	0.50	3.5
4 x 6	4.30	0.50	3.9
4 x 8	5.10	0.60	7.1
6 x 8	5.10	0.60	8.8

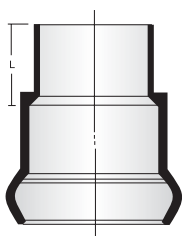
**SPIGOT ADAPTER****G x SP**

Nominal Size (in)	L (in)	Wt./ (lbs)
1½	1.50	0.4
2	1.80	0.5
2½	2.00	0.8
3	2.10	1.4
4	2.30	1.9
6	3.10	4.0

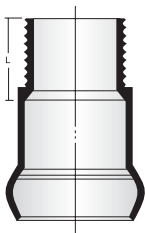

MALE ADAPTER G x MALE PIPE THREAD

Nominal Size (in)	L (in)	Wt./ (lbs)
1½	1.05	0.4
2	1.20	0.5
2½	1.55	0.8
3	2.10	1.3
4	2.25	1.8
6	2.50	3.9

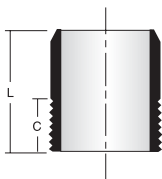

ADAPTER PE (PLAIN END) x MALE PIPE THREAD

Nominal Size (in)	L (in)	C (in)	Wt./ (lbs)
3	4.30	2.00	0.7
4	4.40	2.25	1.4
6	5.90	2.50	2.0

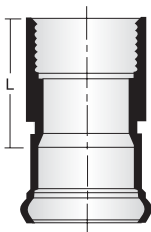

ADAPTER BELL x FEMALE IPT

Nominal Size (in)	L (in)	Wt./ (lbs)
1½	2.60	0.5
2	3.00	0.7
2½	3.80	1.3
3	4.10	2.0
4	4.40	3.0
6	5.40	6.1



FABRICATED PVC PRESSURE FITTINGS

There is a PVC fitting for every size of PVC pressure pipe with either CIOD or IPS outside diameters. Fittings are constructed from welded pipe segments and fiberglass reinforced polyester overwrap. Fabricated fittings from Multi have the same gasketed bell joint that is used with IPEX pipe. Custom configurations or standard designs such as tees and elbows are manufactured by these techniques.

Multi fabricated fittings are high integrity fittings designed and engineered to meet demanding transmission and forcemain requirements.

Blue Brute CIOD fittings are available in various configurations from 10" to 48" in diameter. Cycle Tough IPS OD fittings are fabricated in various configurations from 10" to 24" in diameter.

FABRICATED FITTINGS

All Multi fabricated fittings are made from segments of third party certified pipe that exceeds the requirements of AWWA C905 and CSA B137.3. The fittings consist of butt fused or welded pieces of pipe that are bonded together and overwrapped with fiberglass reinforced mesh. The fittings are always manufactured to the specific pressure rating of the piping system.

All welded joints in the fittings are subjected to a spark test (power source of 24,000 volts).

The welded joint may not permit the passage of any spark at any point along the weld or butt fusion.

Fiberglass reinforcing is then applied to the fitting in such a manner and thickness to meet the hydrostatic pressure requirements specified. Bonding is done with a Primer Resin to provide an adequate bond to the PVC pipe. All methods of reinforced fiberglass comply with the requirements of the Canadian General Standards Board (CGSB) 41.22-93.



BUTT FUSION FABRICATED FITTINGS

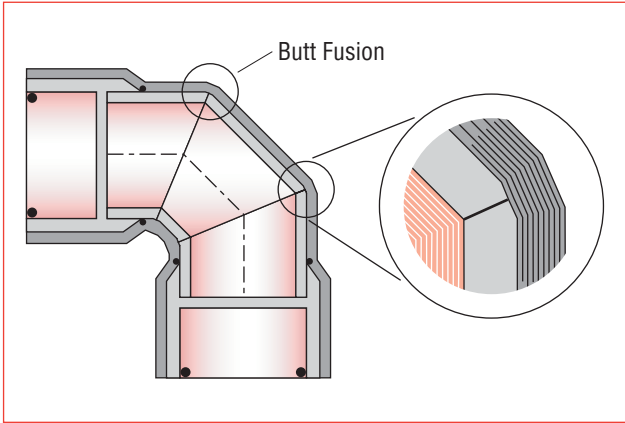

BUTT WELD FABRICATED FITTINGS

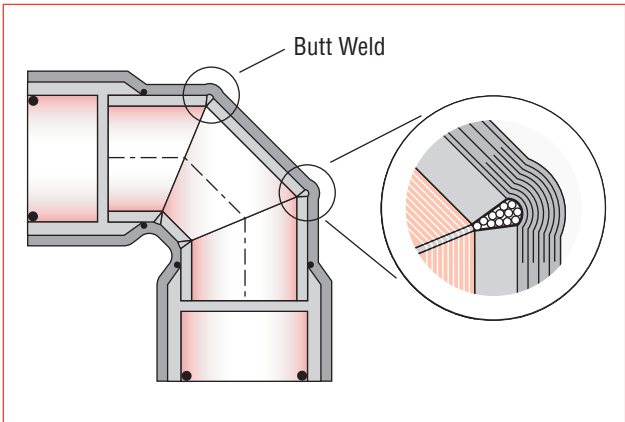

RESISTING THRUST AT PRESSURE FITTINGS AND VALVES

The thrust in a pipeline arises from the internal pressure and from the velocity of the fluids passing through the pipeline. It is also a function of the diameter of the pipe and the fitting system. Thrust blocking or thrust restraint is necessary under the following conditions.

- **AT FITTINGS CAUSING CHANGES IN DIRECTION (Vertical or Horizontal)**

Fittings such as elbows, tees, or dead ends, must be restrained if they affect the internal pressure, velocity, or, if they cause the column of water to change the direction of flow.

- **AT FITTINGS CAUSING REDUCTIONS IN SIZE**

The amount of thrust created by a reducer fitting is dependent upon the magnitude of the reduction. All reducer fittings must be restrained.

A poly sheet is sometimes loosely wrapped around the fitting to act as a separation layer before pouring the concrete.

- **AT VALVES**

Valves may be installed using a Multi flanged adapter. It is important that all valves be anchored. This would include valves installed in a chamber or in line with the pipe, whether it is operated frequently or only once a year.

Install anchor rods around the valve body or through the mounting lugs and embed the rods in a concrete pour beneath the valve. The light weight of PVC pipe and its smooth wall may permit the movement of valves in response to thrust forces developed when the valves are closed. Valves installed in chambers must also be anchored in this fashion.

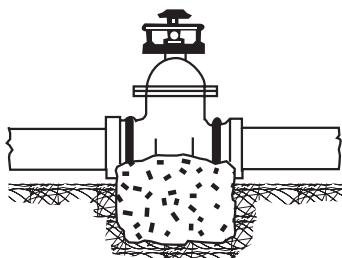

BEARING STRENGTH OF UNDISTURBED SOILS

Organic Material such as:

Peat, etc.	0 lb/ft ²
Soft Clay	500 lb/ft ²
Sand	1000 lb/ft ²
Sand and Gravel	1500 lb/ft ²
Sand & Gravel with Clay	2000 lb/ft ²
Sand & Gravel Cemented with Clay	4000 lb/ft ²
Hard Pan	5000 lb/ft ²

These soil bearing capacities are approximate and conservative. For greater design precision Multi recommends that soil bearing tests be carried out by a competent soils engineer.

The recommended bearing area to be established by the concrete pour may be given by the engineer. The area (ft.²) may also be calculated by determining the total thrust generated at the fitting. Simply divide the bearing strength of the soil into the thrust developed (lbs force), as found in the accompanying table. Please note that the thrust developed is for 100 psi. For higher pressures, simply multiply the thrust developed in the table by the ratio of the pressures. The result is the area of the soil required to resist the thrust (A). The area calculated will be for the area of concrete up against the trench wall (i.e. the back side of the block).

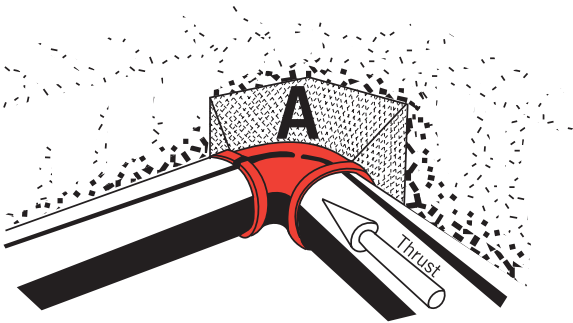

$$\text{area } A = \frac{\text{Thrust Force}}{\text{Bearing Strength of Soil}}$$



THRUST DEVELOPED PER 100 PSI PRESSURE (LBS. FORCE)

Pipe Diameter (in)	Valves & Dead Ends, Tees	90° Bends	45° Bends	22½° Bends	11¼° Bends
4	1810	2560	1390	635	320
6	3740	5290	2860	1370	690
8	6430	9100	4920	2320	1170
10	9680	13680	7410	3610	1820
12	13690	19350	10470	5080	2550
14	18380	25990	14100	6100	3080
16	23780	33630	18280	7960	4020
18	29860	42230	22970	10060	5080
20	36640	51820	28180	12440	6280
24	52280	73930	40200	17940	9060
30	80425	113737	61557	31500	15800
36	115200	162929	88181	45000	22600
42	155500	219950	119000	60700	30500
48	202700	286700	155200	79000	39800

Please note that precast thrust blocks should not be placed directly against PVC fittings.

RESISTING THRUST IN VERY POOR SOILS

Where the pipeline passes through soils having little or no bearing strength, thrust forces may be restrained by the encasement of the fitting in concrete. The pour should be extended to form a monolith having sufficient inertia to resist the thrusts. It may also be possible to loop tie rods around the fitting and anchor the tie rods into an upstream concrete pour across the trench in more stable soils. Mechanical thrust restraints may also be used in these cases.

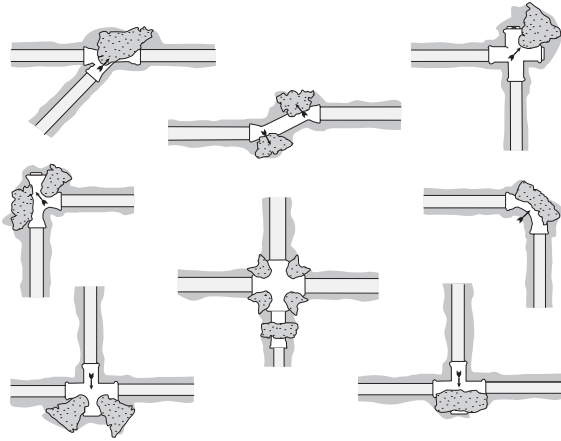

Typical thrust block locations. Trim the trench bearing area using hand tools to be sure of undisturbed soil.

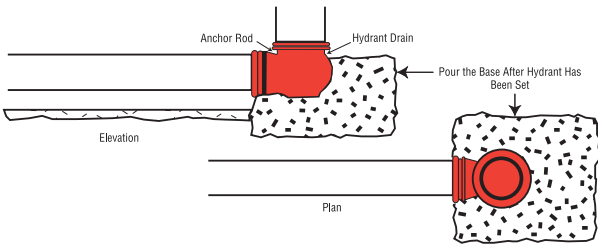

This type of hydrant foundation acts as a thrust-block, as an anchorage against frost heave and eliminates washouts from waste-water drain.

RESISTING VERTICAL THRUST

Where the pipeline will change direction downward to pass under a creek bed or roadway, etc., upward thrust will be developed at the fitting. Anchor the fitting as though it were a valve, and ensure that the concrete base is keyed into undisturbed soil.

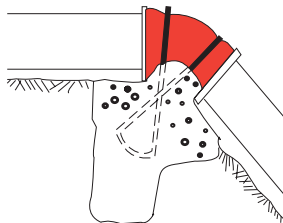

Straps should be 2" wide or greater.



HOLDING PIPE AND FITTINGS TO STEEP SLOPES

Normal bedding practices for pipelines installed up a hill will be sufficient to prevent backsliding and decoupling. When the height of cover is less than 6', and the soil conditions are marginal, and where the slope is greater than 20° (36% slope), a special anchoring method may be desirable. One recommended procedure is to lay the pipe and fittings with the bells facing uphill and pour a concrete block behind the bell that is keyed into the undisturbed trench sidewalls. Usually every third piece of pipe or fitting will need to be anchored in this fashion to achieve a stable condition. The use of solvent welded fittings for short sections of the pipeline may also be considered on steep slopes.

MECHANICAL THRUST RESTRAINTS FOR FITTINGS

Several mechanical thrust restraint devices are available which clamp to the wall of the pipe and tie back to a mating collar on the fitting or the fitting bell. The use of these devices may provide the entire thrust restraint necessary at the fitting, in sizes up to 48". The use of several thrust restraints to tie together two or three lengths of pipe on either side of the fitting may be desirable to enlist the clamping effect of the backfill around the pipe barrel. Multi recommends that the thrust restraint device conforms to the requirements of ASTM F1674-96 and the restraint device should be third-party certified by UL and/or FM.

When a thrust restraint

device is used, the maximum pressure in the pipeline (usually the test pressure) must not exceed the pressure rating of the device.

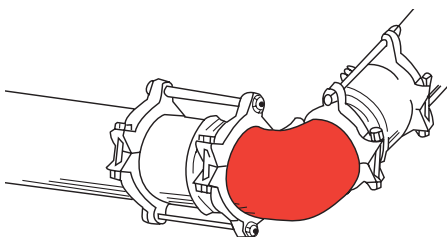

FLANGED JOINTS

A PVC system may be connected to flanged joints by using a PVC flange adapter. As is the case regardless of pipe material, flanged joints are not recommended for buried underground installations except inside a valve chamber. Multi manufactures a complete line of flanged fittings or flanged adapters for all above ground mechanical needs.

SERVICE CONNECTIONS

The PVC industry has promoted the use of conventional means to complete service connections in PVC pressure systems. However, recent advancements, have allowed Multi to offer single and double tapped couplings.

TAPPED COUPLINGS

Multi provides a simple solution for the elimination of water service saddles by offering tapped couplings. These couplings accept standard corporation stops with AWWA threads. For simultaneous service connections on both sides of the main, double tapped couplings are now available.

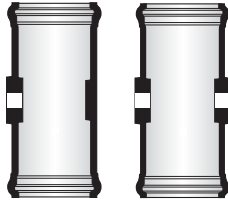

To install, follow these steps:

- Step 1: Inspect Tapped Couplings and ensure that interior of fittings and gaskets are free of dirt.
- Step 2: Wrap the Teflon tape (PTFE) clockwise around the tapered inlet threads of the corporation stop. Make two complete wraps around the threads.
- Step 3: Screw the corporation stop into the Tapped Coupling until one to two threads are showing. Do not insert beyond this point. The torque required will be between 45 ft. lbs. and 55 ft. lbs.
- Step 4: Make sure the protective coupling nut is screwed on the outlet threads, and the valve is closed. Install the Tapped Coupling in the trench with the corporation stop positioned to receive the service connection.



THE PIPELINE

LEAKAGE AND PRESSURE TESTS

Although they have different purposes it is now common practice to combine leakage tests and pressure tests into one single test to ensure that the Multi fittings and the pipe provide a leak tight system.

A pressure test will determine the soundness of the pipeline and its appurtenances. A successful pressure test will reassure the engineer and the owner that the line is capable of sustaining both the working pressure and those additional pressures that may be introduced from time to time as a result of normal operation.

The pressure used in the pressure test should not be higher than needed to accomplish that objective. Typically, the pressure test will be carried out at the maximum working pressure plus 50 psi. Remember that all parts of the line, including thrust blocks, will be subjected to the test pressure.

Multi pressure fittings may be pressure tested in an underground installation to levels indicated in the table below. These represent pressure levels 25% above the pressure rating of each DR of the fitting.

Dimension Ratio DR	Test Pressure psi
14	380
**** 18	295
*** 21	250
25	205
26	200
32.5	155
41	125
51	100

* Verify test pressure does not exceed appurtenance or restraint requirements.

** *It is possible to exceed the above test pressure for Multi Fittings under specific conditions. Contact Multi for details.*

*** Multi Injection Molded Cycle Tough Fittings

**** Multi Injection Molded C907 Blue Brute Fittings

The installer is cautioned that for most installations, the previously mentioned values may exceed the test rating of other pipeline appurtenances such as valves or hydrants. Excessively high pressure testing may also affect the size of thrust blocks or quantity of mechanical restrainers and thus possibly increase the overall project costs.

The presence of air in the pipeline during the pressure test may give the appearance of a failure. If the measured amount of makeup water to achieve pressure on successive tests is declining then the presence of air is positively indicated. The line must be vented before testing continues.

In the absence of other instructions a two hour combined pressure and leakage test is recommended. The leakage test may also be performed as a separate test and is usually conducted at the working pressure of the system.

REPAIRS

Should it be necessary to replace a section of pipe, Multi provides a repair coupling to simplify and speed up the repair operation. The replacement section can consist of a length of pipe with two spigot ends and two double bell repair couplings or a length of pipe with an integral bell and one spigot end and one double bell repair coupling.

When cutting out the section be sure that all the damage is included (ie.) no hairline fractures are left in the line and that there is enough room to carry out the repairs.

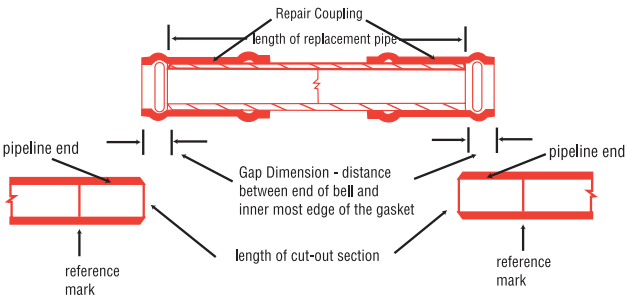

1. Determine the length of the replacement section as shown in below. Cut the pipe to the proper length.
2. Bevel the ends of the pipeline and the repair section. Measure the repair coupling lay length and divide it by 2. This measurement is the reference mark position on the pipe. Mark the spigots of the pipe.
3. Mount the couplings as shown in the diagram above or on the pipeline ends instead of the replacement section.
4. Insert the replacement section into the pipeline and slide the couplings into position as shown below. The couplings should be centered over the gap and positioned at the reference marks.

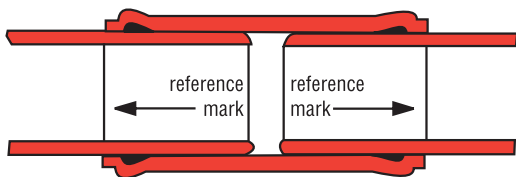

When using a section with an integral bell, more of the pipeline may have to be exposed to enable the pipeline to be deflected to allow the proper alignment of the replacement joint. When determining the length of the replacement section take care to allow for the gap dimension on one end only. Complete the integral bell joint first then slide the double bell coupling into place.

TRENCH TOUGH PLUS™ & ULTRA-RIB® GASKETED SEWER FITTINGS

STARTING THE JOB

GASKETS

Multi Trench Tough Plus gasketed sewer fittings provide factory installed locked-in rubber gaskets eliminating the need for field insertion. Multi Trench Tough Ultra-Rib fittings seal on the spigot gasket of a piece of Ultra-Rib pipe. For Multi gasketed sewer fittings, the gasket is locked inside the bell end to accommodate a smooth walled spigot of pipe during assembly. With the Ultra-Rib fitting, the gasket is positioned on the spigot exterior of the pipe for assembly into the smooth-surface interior of the bell of the Ultra-Rib fitting.

Gaskets standardly supplied with Multi sewer fittings are made from the commonly used elastomer, SBR or TPE. Other special gasket materials such as nitrile are available upon request.

LINE AND GRADE

Abrupt directional changes for main sewer lines are usually accomplished using manholes. Besides being an access chamber to the line, the manhole acts as a directional junction box for sewer pipe laid in straight lines. If a manhole is not used, Multi offers a complete line of 90°, 45° and 22½°, 11¼° bends.

ASSEMBLY OF FITTINGS

Both Multi Trench Tough Plus Gasketed Sewer and Ultra-Rib fittings are assembled in the form of a bell end and spigot gasketed joint. For Multi gasketed sewer fittings, the gasket is locked in the interior of the bell while the spigot should be factory-beveled for easy insertion. Ultra-Rib differs by having the gasket positioned on the spigot exterior of the pipe between the 2nd and 3rd ribs for insertion into a smooth-interior bell of the fitting. Assembly procedures are virtually identical.



Assembly Steps

1. Ensure that the bell interior of the fitting and spigot exterior of the pipe are clean and free from foreign material that could prevent an effective seal.

Note: All PVC pipe and spigot fittings are shipped with a chamfer on the end of the spigot. If there is no chamfer, follow the example of a factory-made spigot and machine a suitable chamfer using a beveling tool, hand rasp, disk cutter or router. (see page 17)

2. Apply Multi lubricant to the fitting as follows:

(a) Multi Trench Tough Plus Gasketed Sewer Fittings - Apply lube to the spigot end only. The coating of lube should extend back 2" to 3" from the spigot edge and should cover the entire circumference. The bell interior of the fitting should also be lubricated.

(b) Ultra-Rib Fittings - Lube should be applied to the entire circumference of the bell interior to half of the bell depth of the fitting. A thin layer of lube should also be applied to the gasket exterior on the spigot end of the pipe.

The lube may be applied using a brush, cloth, glove, sponge or pad.

3. Insert the spigot end into the bell of the fitting until the spigot comes in contact with the rubber ring, or for Ultra-Rib, until the spigot gasket contacts the bell end.
4. While keeping the spigot of length in proper alignment, brace the bell of the fitting and push the spigot into the bell. **The spigot should be inserted until the fitting measured reference mark is reached on the pipe.**

Note: If undue resistance is felt during assembly, the joint should be disassembled, cleaned and remade in accordance with the above methods. If excessive resistance still exists upon reassembly, **do not attempt to force the assembly.** Contact Multi immediately for assistance.

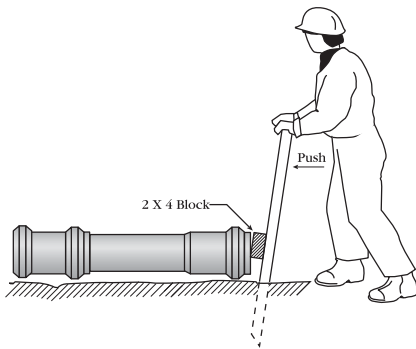

Multi gasketed sewer fittings can normally be assembled by hand or by bar and block for sizes up to 15". For larger sizes, it may be necessary to install the pipe using methods such as lever pullers, hydraulic jacks or the backhoe bucket.

When such mechanical means are used, the assembly effort should not be applied directly to the edge of the pipe. A two-by-four or a plank should be placed between the backhoe bucket and the pipe or fitting edge. The use of the excavator bucket has the disadvantage that the machine operator is unable to clearly see the pipe installation into the fitting. A helper should assist by observing and signalling the operator when the assembly is complete.

Note: *Insertion depths may vary amongst different pipe or fitting manufacturers. As a result, although pipe and fitting assembly can be made using Multi and all other brands of PVC pipe and fittings, the insertion line on the spigot should be disregarded. Simply measure the insertion depth of the Multi fitting with a tape measure and mark this depth on the spigot before assembly.*

Caution: Over-assembly of a PVC Sewer Fitting may cause one or both of the problems below:

- (a) Joint flexibility may be lost which may cause a leak in the case of uneven settlement.
- (b) The inside diameter of the pipe in the fitting joint may be reduced enough to appear as an over-deflection on a deflection mandrel test.

Always measure the insertion depth of the bell and mark it on the pipe.



LUBRICANT

To assemble Multi sewer fittings, the installer should only use an approved pipe and fitting lubricant. The correct amount of lubricant can be calculated using the chart on Page 84. If adverse conditions are encountered, such as extreme cold or high water table, extra lubricant may be required.

CURVED SEWERS

As a cost-saving alternative to manholes, gradual changes in direction in sewer lines may be achieved by using Multi PVC fittings.

Using PVC Fittings

Multi offers standard elbows short or long radius in $22\frac{1}{2}^\circ$, 45° or 90° . PVC elbows can also be fabricated to any angle configuration other than those listed above for all sizes of Sewer or Ultra-Rib pipe.

FIELD CUT ASSEMBLY

Before assembly of a fitting is being made using field-cut PVC sewer pipe, follow the instructions below:

- (a) **Sewer Pipe** - The spigot end must be chamfered to a thickness of about 50% of the pipe wall at a bevel angle of 15 degrees. Next, a reference line for insertion of the pipe into a fitting should be applied by measuring the fitting bell to minimize the possibility of over-insertion.
- (b) **Ultra-Rib Pipe** - A gasket must be field installed between the 2nd and 3rd ribs of the spigot end of the pipe. An insertion line can be marked by measuring the fitting bell.

MANHOLE CONNECTIONS

Very often, inserting PVC sewer pipe into concrete manholes and other rigid structures requires a watertight connection. Some options to obtain such a connection are described as follows:

Sewer Pipe

- Smooth Wall Adapters** - DR35 pipe spigots will easily fit into a manhole gasket or rubber boots found in concrete manhole structures. If a gasketed manhole is not available grout adapters must be used.
- Grout Adapters** - These fittings are simply a bell x spigot fitting that has been coated externally with a sand, epoxy, cement mortar mixture. A watertight connection can be made by placing the adapter into a manhole outlet followed by filling the annular space around the adapter with a non-shrink grout. The special coating is required because grout will not form a watertight bond with bare PVC pipe.

Ultra-Rib

- Smooth-Wall Adapter** - Multi offers a Bell x Spigot PVC adapter that transforms an Ultra-Rib bell into a smooth-wall DR35 outside diameter spigot. Connection to the manhole can then be achieved by inserting the DR35 spigot into a manhole gasket or rubber boot in the manhole. The adapter is chamfered at the factory for easy insertion.

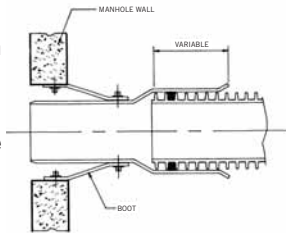

- Grout Adapter** - The concept here is identical to the grout adapter used for Sewer pipe, except that the bell end is made to accept an Ultra-Rib spigot. The procedure involves the application of a non-shrink grout to create a seal between the adapter and the concrete manhole wall.

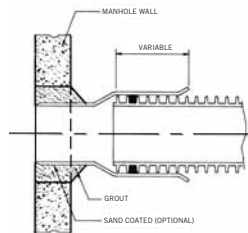

Manhole Installation Notes

- To minimize the effects of possible manhole settlement over time, shorter sections such as a manhole adapter should be used when entering and exiting the manhole.
- It is good practice to compact the foundation below the manhole to prevent excessive settlement.
- The area directly underneath the manhole adapter should be supported by compacted soil or sand to assist with the load bearing capacity.

SERVICE CONNECTIONS

Multi offers two methods of connecting to PVC sewer for service or tie-ins. Gasketed PVC tees or wyes are the preferred method for service connections off newly installed mainlines, while saddles are advantageous for tie-ins to existing sewer lines.

1. **PVC Fittings** - Multi manufactures gasketed molded PVC fittings up to 15", and fabricated PVC fittings up to 48". Tees and wyes are available in all sizes. Custom configurations can also be made to suit design needs.

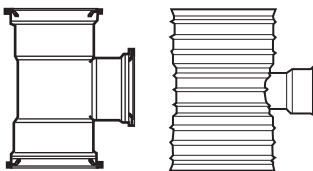

Always ensure that the fitting and service lateral are compacted in the same manner as the main line sewer. Sloppy installation of the sewer lateral will cause undue stresses on the PVC fitting and may cause premature failure.

2. **Strap-On Gasketed PVC Saddles** - These devices are available as either tees or wyes. Mainline connections can be made off of pipe as large as 48" with outlet sizes up to 6" standardly available. **This method is for use on smooth wall PVC pipe only.** The procedure below should be followed to ensure proper installation.

(a) Place the saddle in position on pipe. Use the saddle as a template and marker guide for the hole cut-in. Remove the saddle from the pipe.

(b) Using the hole guide mark, cut a hole through the pipe wall outside the mark by the thickness of the saddle stem by $1/4"$. Use a hand, keyhole or power jig saw to cut the hole. For wye saddles, cut or bevel the downstream side of the hole at a 45° angle to obtain a better fit for the saddle stem.



(c) Clean and dry both the underside of the saddle and the mating surface of the pipe.

(d) Position the saddle over the hole. Place the two (2) stainless steel straps around the pipe and through the slots at each end of the saddle skirt. Check to see that the saddle stem is recessed into the hole for stability and that the straps are at right angles to the pipe surface.

(e) Tighten the straps alternately with a large screwdriver until a maximum torque has been reached by hand.

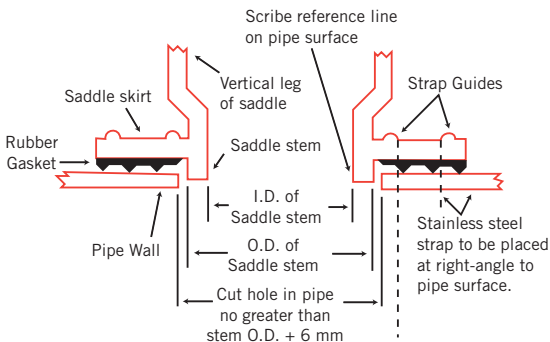
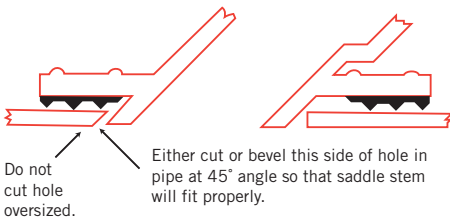

(f) Place and tamp the select backfill around the pipe and saddle to provide firm and continuous support for both.

Note: If saddles are not properly positioned, the rubber sealing gasket may not be touching the pipe wall which may result in a leak.

When performing either of the above service connection methods, every effort should be made to:

- (a) Ensure no foreign matter enters the main line through the connection outlet.
- (b) Keep the outlet plugged until the service lateral pipe is installed.
- (c) Keep the lateral service pipe capped at its terminating point until the house sewer line is installed.

SEWER LATERALS

In general, service laterals should be taken off at an angle of no greater than 45° from the horizontal. This will minimize the effects of side-soil friction imposing excessive downward loads on the service connection.

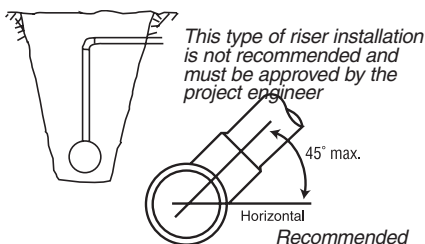

When connecting laterals to deep sewer mains, tall sewer risers are often used to minimize excavation for the lateral piping. The use of a long sweep PVC bend is suggested wherever possible to facilitate changes in slope more gradually. Good compaction is imperative beneath the long sweep bends as well as below the branch of the service connection fitting in order to maintain proper soil support. The PVC long sweep bends from Multi are made to a radius of curvature of six (6) times the nominal diameter of the bend.

RISER PROBLEMS DEMAND SPECIAL ATTENTION

When vertical risers cannot be avoided, consult the design engineer as more special precautions may be required.

Service lines from the property to the street sewer demand special design considerations when the collection sewer is deeper than 13' regardless of the piping material used. Service risers from main sewers

buried more than 13' should be taken off at an angle not less than 45° from the vertical. The service should then be moved to the vertical position by an appropriate elbow and vertical section of pipe. In sanitary sewer systems, drop laterals and drop manholes are the most common examples of areas requiring this special attention.

Drop laterals may create undue stresses on the buried pipe and fitting assembly. Horizontal portions of a lateral laid over disturbed uncompacted materials may experience a loss of bedding support if the foundation settles. This can lead to loss of grade and ultimately beam or shear failure in the pipe or fitting. As the soil adjacent to the pipe settles with the foundation, it attempts to drag the pipe with it, magnifying the load on the fittings.

Providing proper support beneath the mainline, service fitting, lateral, elevation fittings and their adjacent fill is critical. Since this is usually difficult, the best approach is to turn the lateral down immediately when entering the trench and keep it against the trench wall thus eliminating any unsupported portion.

Keeping the drop portion (and the upper elbow) immediately adjacent to the trench wall can reduce drag down effects and control beam bending during backfill. Even then, the

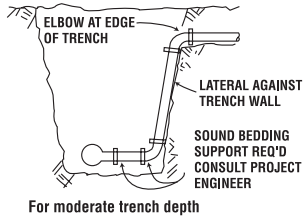

For moderate trench depth

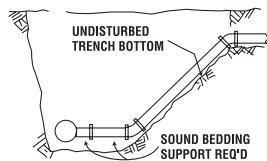

Sloping lateral trench - any depth
(slope at 1:1 or flatter)



elbow at the bottom must be both strong enough and bedded on a sound foundation to react to the loads. As depths increase, settlement loads can ultimately fail the system or buckle the riser.

Designs employing sleeves or concrete encasement of the drop portion of the lateral are effective if the designer provides an adequate means of supporting the loads at the bottom.

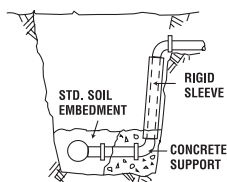

Rigid sleeve for any trench
(concrete must support sleeve)

Sleeving the lateral with a crushable material such as corrugated polyethylene drainage tubing can also solve the problem. As the fill adjacent to the lateral settles, the sleeve folds up and moves down with it.

This accordion-like effect displaces the load from the lateral. It should be noted that when this method is used, the annular space between the sleeve and the lateral should not be filled with backfill.

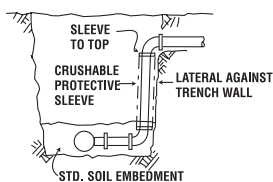

Crushable Sleeve - any depth
(sleeve of near zero column strength)

BACKFILLING AND TAMPING

Backfilling should follow pipe assembly as closely as possible. This protects pipe from falling rocks, eliminates possible lifting of the pipe off grade due to flooding, avoids shifting pipe out of line by cave-ins and in cold weather, lessens the possibility of backfill material freezing.

The two basic purposes for proper haunching and proper initial backfilling of PVC systems are:

- (a) to provide the side soil support, which is necessary to enable the pipe, fitting, and soil to work together to meet the designed load requirements within the allowable deflection limit.
- (b) to provide protection for the pipe and fitting from impact damage due to large rocks, etc., contained in the final backfill.

After initial backfilling has been completed, the balance of the backfill can be done by machine.

TAMPING EQUIPMENT

The following are some forms of tamping equipment commonly used.

Tamping Bars - If manual tamping is to be done directly beside or above PVC fittings, tamping bars are preferred. Two types of tamping bars should be available for a good tamping job. First, a bar with a narrow head should be used (see A or B below). These are used to tamp under the pipe. The second tamping bar should have a flat head. It is used to compact the soil along the sides of the pipe to the trench walls (see C below). The flat tamper will not do the work of the tamping bar and vice-versa.

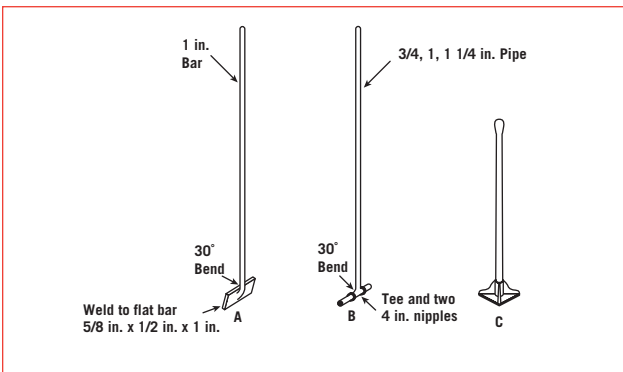

Tampers - These devices are well-suited for use in the Bedding, Haunch, Initial Backfill, or Final Backfill zones. A minimum cover of 12" is recommended for jumping jacks to avoid excessive impacts, while flat plate tampers may be used with as little as 6" of backfill over the pipe and fittings.

Mechanical Compactors - This category refers to such machines as hoe-pacs and vibratory rollers. They should only be used in the Final Backfill zone and must always have a minimum cover of 3.3' above the pipe and fittings.

Flood or water tamping may be used as a method of compaction only in trenches that are excavated in soils from which water drains quickly. Care should be taken not to float the pipe. The introduction of water under pressure (i.e. water-jetting) should never be used to compact embedment soils of PVC pipe and fittings.



TESTING OF SEWERS

JOINT TIGHTNESS TESTING

To ensure the integrity of the assembled gasketed joints of a PVC sewer pipeline, often the designer will require testing after installation is complete. This testing is frequently a requirement for sanitary sewer lines and is a growing trend for storm sewer systems as well.

There are two options that may be specified by the designer to test joint tightness - Air Testing or Water Testing. Air testing is preferable where possible because of its accuracy, simplicity and minimal time consumption. Water testing tends to be more expensive than with air, but is advantageous in some situations.

1. Air Testing

The installer must plug both ends of a section of sewer to be tested before subjecting that section of pipe and fittings to low pressure air. The air must be maintained at a minimum pressure of 3.5 psi for the time period indicated for each diameter shown in the following table. Duration times vary with changes in pipeline size and length of test sections. A maximum pressure drop of 0.5 psi is permitted within the specified time duration. If a maximum pressure drop of 1.0 psi is specified, the time values in the table should be doubled.

Should the pressure drop be greater than 0.5 psi within the specified time duration, the installer must locate and repair any deficiencies, at his own expense. Re-testing should then be performed until a successful test is achieved. Sources of leaks may be dirt in an assembled gasketed joint, incorrectly tightened service saddles or improper plugging or capping of sewer lateral piping. If there has been absolutely no leakage (zero psi pressure drop) after one hour of testing, the section shall be passed and presumed free of defects.

If there is groundwater present at a level higher than the fitting invert during the air-test, the test pressure should be increased to a value of 3.5 psi greater than the water head at the bottom of the fitting (to a maximum air test pressure of 5.0 psi).

Time Required for a 0.5 psi Pressure Drop for Given Sizes and Lengths of PVC Sewer Pipe

Pipe Size (in.)	Minimum Time (min/sec)	Length for Minimum Time (ft.)	Time for Longer Length (sec)
4	1:53	600	1.999 L
6	2:50	400	4.497 L
8	3:47	300	8.003 L
10	4:43	240	12.499 L
12	5:40	200	17.995 L
15	7:05	160	28.123 L
18	8:30	133	40.494 L
21	9:55	114	55.119 L
24	11:20	100	71.984 L
27	12:45	88	91.106 L
30	14:10	80	112.478 L
36	17:00	66	162.015 L
42	19:54	57	220.549 L
48	22:47	50	288.053 L

where L = length of test section in feet

example - If there is 1.65 feet of water above the invert of a buried PVC sewer line, what must the air-test pressure be? (To convert ft. of water to psi, simply multiply by 0.43)

solution - The static head of the groundwater at the fitting invert will be:

$$(1.65 \text{ ft. H}_2\text{O}) \times (.43 \text{ psi / ft. H}_2\text{O}) = .71 \text{ psi}$$

therefore, the total air-test pressure should be:

$$.71 \text{ psi} + 3.5 \text{ psi} = 4.21 \text{ psi}$$

Since this value is less than 5.0 psi, the installer may proceed with the air test using this start pressure.

Using this analysis, it is evident that the maximum head of groundwater permitted above the invert of a PVC sewer pipe and fitting system for an air test is approximately 3.5'.



2. Water Testing

Infiltration - This is an acceptable method of leakage testing only when the groundwater level is above the top of the pipe throughout the section of line being tested. It is especially useful when the water table is more than 3.5' above the top of the pipe. Usually the designer will give explicit instructions for conducting the test.

Exfiltration - This test is suitable for very dry areas, or where the water table is suitably low that test pressures can easily exceed the static head of the water table. Test pressures should be a minimum of 0.9 psi above the water table head. The test section of pipe shall be filled with water and the leakage rate measured.

For sizes 4" - 15", the allowable leakage rate shall be 25 USgal./inch/mile/day. For sizes 18" and larger, the allowable rate for testing shall be 10 USgal./inch/mile/day. Should the allowable leakage rate be exceeded for either an infiltration or exfiltration test, the installer must locate and repair any deficiencies at his own expense until a successful test is conducted. Tests are typically conducted between manholes.

The allowance for infiltration/exfiltration does not imply that Multi Gasketed Sewer fittings or Multi Ultra-Rib fittings leak. In fact, in most types of sewer installations, both types of sewer fittings have virtually zero leakage.

DEFLECTION TESTING

Deflection is the way a flexible pipeline reacts to vertical soil loads when buried in a trench. It illustrates how the pipe and fitting system and the surrounding soil work together to easily withstand common, and even extreme soil loads. Deflection is a sign of strength, not weakness.

Deflection can be easily and accurately predicted by the designer by knowing the pipe stiffness, soil stiffness and the height of cover. For the majority of underground PVC sewer applications, with proper compaction, the deflection will be well within the recommended maximum of 7.5%.

However, if there is reason to believe that excessive deflection may be present, the designer may call for a Deflection Test.

There are two commonly used methods of performing deflection tests on PVC sewer pipe:

1. Go-No-Go Device
2. Physical Measurement

1. Go-No-Go Device

The most popular method of the above is the rigid Go-No-Go mandrel. This gauge can accurately determine whether or not the deflection is within specified limits. The concept involves pulling a mandrel through a backfilled sewer line that will get stuck if the actual deflection is beyond the specified limit (normally 7.5%). The mandrel must have dimensions to exactly match the clearance inside the pipe and fittings at the deflection limit. For pipe and fitting sizes larger than 27", physical measurement is recommended.

Below is a detailed drawing of a suggested mandrel design for 7.5% deflection.

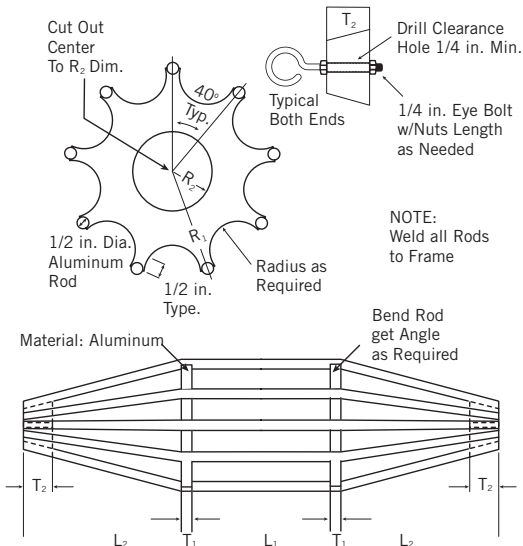

Fitting Size	Base I.D.	L1, L2	R2	R1
(in.)	(in.)	(in.)	(in.)	(in.)
Ring-Tite				
8	7.67	6	1.4	3.54
10	9.56	8	1.6	4.42
12	11.36	8	1.8	5.26
15	13.90	9	1.9	6.43
18	16.98	12	2.2	7.85
21	20.00	12	2.4	9.25
24	22.48	14	2.5	10.40
27	25.33	14	2.7	11.71
Ultra-Rib				
8	7.72	6	1.4	3.59
10	9.65	8	1.6	4.49
12	11.49	8	1.8	5.34
15	14.07	9	1.9	6.54
18	17.27	12	2.2	8.03
21	20.31	12	2.5	9.44
24	23.00	14	2.7	10.69

- Notes:
- T1 = 1/2" and T2 = 1" for all sizes of mandrels
 - for pipes larger than 27", physical measurement is recommended
 - 2 times R1 is the passing width of the mandrel

2. Physical Measurement

To begin a physical measurement on an installed sewer line, one must measure the vertical inside diameter at a particular point in the PVC sewer line before it is installed (D1). Next, the inside diameter at that same point must be measured after the pipe or fitting has been installed and completely backfilled (D2). Now, the deflection at that point can be computed as follows:

$$\text{Deflection} = \frac{D1 - D2}{D1} \times 100\%$$

A micrometer should be used for accurate results.

VIDEOS

The use of video cameras to record the interior condition of a newly installed sewer line is popular in many areas. The idea of videotaping the inside of sewer lines was first conceived to evaluate the decaying condition of older sewers made from traditional pipeline materials such as clay, brick or concrete. The only benefit of videos, with regard to newly installed PVC sewer lines, is in detecting glaring installation deficiencies such as leaking joints or excessive deflections. However, television inspection is unable to quantify these problems and address whether or not they are within acceptable limits.

SHALLOW BURIAL

When subjected to live traffic loading (H-20), the minimum cover for all Multi gasketed PVC sewer fittings with a minimum pipe stiffness of 46 psi or greater is **12"**. The installation must be done and compacted to a minimum soil stiffness E' of 1000 psi in the haunch zone around the fitting and around any service laterals.

If the pipe stiffness is less than 46 psi, the minimum cover for H-20 loading shall be **24"**. The same minimum E' of 1000 psi should be obtained at this depth.

REPAIRS

Should it be necessary to replace a section of pipe, Multi provides a gasketed sewer repair coupling to simplify and speed up the repair operation.

Repairs can be made for either Sewer or Ultra-Rib pipe in a similar fashion. One would simply insert a replacement section of pipe into the damaged area and join it to the existing pipe by means of two repair couplings. Repair couplings are available without pipe stops. If one of the ends of the existing pipe is a bell-end, only one repair coupling is required.

The replacement section can consist of a length of pipe with two spigot ends and two double bell repair couplings or a length of pipe with an integral bell and one spigot end and one double bell repair coupling.



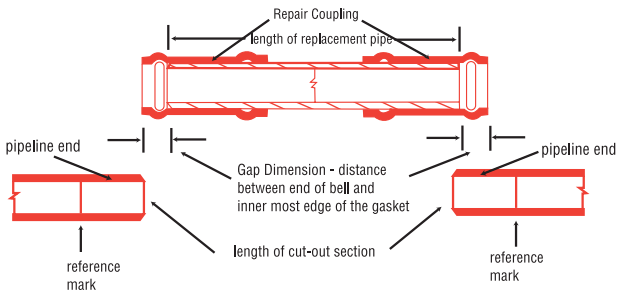

When cutting out the section be sure that all the damage is included (ie.) no hairline fractures are left in the line and that there is enough room to carry out the repairs.

1. Determine the length of the replacement section. Cut the pipe to the proper length.
2. Bevel the ends of the pipeline and the repair section. Measure the bell depth of the repair couplings and locate the reference marks on all spigot ends.
3. Mount the couplings as shown above or on the pipeline ends instead of the replacement section.
4. Insert the replacement section into the pipeline and slide the couplings into position as shown below. The couplings should be centered over the gap and positioned between the reference marks.

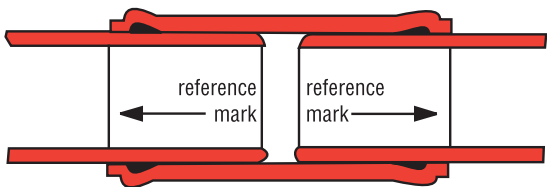

When using a section with an integral bell more of the pipeline may have to be exposed to enable the pipeline to be deflected to allow the proper alignment of the replacement joint. When determining the length of the replacement section take care to allow for the gap dimension on one end only. Complete the integral bell joint first then slide the double bell coupling into place.

SOLVENT WELD SEWER AND DWV FITTINGS

Many times pipe and fittings other than gasketed joint PVC are used for underground drainage or sewage systems. Multi also produces Gasketed Fittings with solvent weld branches. PVC DWV fittings and solvent weld sewer fittings are joined into the pipe system with a solvent cement.

Solvent Weld Sewer and DWV Fittings are installed in exactly the same manner as the gasketed sewer fitting installation procedures contained in this booklet. These trench zone recommendations should always be followed.

The joints of a solvent welded system provide the designer with a rigid system. The joints have no capability to offer flexibility or deviation once properly cemented. In underground burial, changes in direction will often accommodate for any thermal expansion and contraction that may occur. Properly cemented joints in underground applications have been used successfully for decades. The key to a successful installation is the solvent cementing process.

SOLVENT CEMENTING

Many solvent cementing techniques have been published, covering step-by-step procedures on how to make a solvent-cemented joint. What follows is a review of these basic principles, along with the techniques needed to suit particular applications, temperature conditions and variations in sizes of various pipe and fittings.

BASIC PRINCIPLES OF SOLVENT CEMENTING

To make consistently tight joints, the following points should be clearly understood:

1. The joining surfaces must be softened and made semi-fluid.
2. A quality solvent cement must be used that is suitable for the diameter and application of the pipe and fitting system.
3. Sufficient cement must be applied to fill the gap between pipe and fittings.



4. Assembly of pipe and fittings must be made while the surfaces are still wet and fluid.
5. Joint strength develops as the cement dries. In the tight part of the joint, surfaces tend to fuse together; in the loose part, the cement bonds to both surfaces.

Penetration and softening can be achieved by the cement itself, by a suitable primer, or by the use of both primer and cement. A suitable primer will usually penetrate and soften the surfaces more quickly than cement alone. In addition, the use of a primer provides a safety factor for the installer. For example, in cold weather, more time and additional applications of the solvent are required.

Apply generous amounts of cement to fill the loose part of the joint. In addition to filling the gap, adequate cement layers will penetrate the surfaces and remain wet until the joint is assembled. To prove this, apply two separate layers of cement on the top surface of a piece of pipe. First, apply a heavy layer of cement; then beside it, a thin, brushed-out layer. Test the layers every 15 seconds by gently tapping with your finger. You will note that the thin layer becomes tacky and then dries quickly (approximately 15 seconds). The heavy layer will remain wet much longer. Check for penetration a few minutes after applying these layers by scraping them with a knife. The thin layer will have little or no penetration, while the heavy layer will have more penetration.

If the cement coatings on the pipe and fittings are wet and fluid when assembly takes place, they tend to flow together, becoming one cement layer. Also, if the cement is set, the surfaces beneath the pipe and fittings will still be soft. These softened surfaces in the tight part of the joint will fuse together.

As the solvent dissipates, the cement layer and the softened surfaces will harden with a corresponding increase in joint strength. A good joint will withstand the required working pressure long before the joint is fully dry and final strength is obtained. In the tight (fused) part of the joint, strength will develop quicker than in the looser (bonded) part of the joint.

SOLVENT CEMENTING INSTRUCTIONS

HANDLING

Solvent cements should be used as received in original containers. Adding thinners to change viscosity is not recommended. If the cement is jelly-like and not free-flowing, it should not be used. Containers should be kept tightly covered when not in use to stop the evaporation of the solvent.

STORAGE CONDITIONS

Solvent cements should be stored at temperatures between 40°F and 110°F away from heat, open flame or direct sunlight. Cements generally have a two to three year shelf life depending on the manufacturer. A date of manufacture for the cement is usually stamped on the bottom of the container. Always check the date and the shelf life for the brand of cement to be used. If new cement is subjected to freezing temperatures, it may become extremely thick. If the cement is not jelly-like, it can be placed in a warm area where it will soon return to its original, usable condition. However, if hardening is present, due to actual solvent loss (when a container is left open too long during use or not sealed properly after use), the cement will not return to its original condition. Cement in this condition has lost its formulation and should be discarded in an environmentally safe manner.

SAFETY PRECAUTIONS

Solvent cements are extremely flammable and should not be used or stored near heat or open flame. In confined or partially enclosed areas, a ventilating device should be used to remove vapors and minimize inhalation. Containers should be kept tightly closed when not in use, and covered as much as possible when in use. Avoid frequent contact with the skin. In case of eye contact, flush repeatedly with water. Keep out of the reach of children.



COLD WEATHER

Although normal installation temperatures are between 40°F and 110°F, high strength joints have been made at temperatures as low as -15°F with good cements. To do this, the installer must ensure he has adequately softened the joining surfaces as outlined in the following steps of this manual. In addition, cement must be kept warm to prevent excessive thickening and gelation in cold weather.

PREPARATION

1. Use a handsaw and mitre box or mechanical saw to cut squarely. A diagonal cut reduces the bonding area in the most effective part of the joint.



2. Plastic tube cutters may also be used for cutting plastic pipe. However, some cutters produce a raised bead at the end of the pipe. This must be removed with a file or reamer, as it will wipe the cement away when pipe is inserted into the fitting.

3. Remove all burrs from both the inside and outside of the pipe with a knife, file or reamer. Burrs can scrape channels into presoftened surfaces or create hang-ups inside surface walls.



4. Remove dirt, grease and moisture; a thorough wipe with a clean dry cloth is usually sufficient. Moisture will retard cure and dirt or grease can prevent adhesion. Solvent cementing should not be attempted in the rain.



5. Check pipe and fittings for fit (dry) before cementing. For proper interference fit, the pipe must go easily into the fittings one-third to three-quarters of the way. Too tight a fit is not desirable. You must be able to fully bottom the

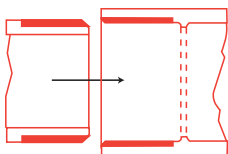

Interference Fit Areas

pipe in the socket during assembly with cement. If the pipe and fittings are not out of round, a satisfactory joint can be made if there is a "net" fit, i.e. the pipe bottoms in the fitting socket with no interference, but without excess movement.

6. Use the right applicator for the size of pipe or fittings being joined: for pipe sizes 3/8" through 1", use the 3/4" dauber; for sizes 3/4" through 2" a 1" brush; 3/4" through 3" a 1-1/2" dauber; 3" through 24", use a roller or paintbrush with a length about one-half the pipe diameter being cemented. It is important that the correct size applicator be used to ensure that sufficient layers of cement are applied.
7. The purpose of the primer is to penetrate and soften the pipe and fitting surfaces so that they can be fused. The use of the primer and the checking of its softening effect provide assurance that the surfaces are prepared for fusion in a wide variety of conditions. Also, always check the penetration or softening on a piece of scrap pipe before you start the installation and if the weather changes during the installation process. Use a knife or sharp scraper and draw the edge over the coated surface. Proper penetration has been made if you can scrape away a few thousandths of an inch of the primed surface. As weather conditions affect priming and cementing action, repeated applications to one or both surfaces may be necessary. In cold weather, more time is required for proper penetration.
8. Using the correct applicator (as outlined in step 6), apply primer freely to the fitting socket, keeping the surface and applicator wet until the surface has been softened. This will usually take 5 - 15 seconds. More time is needed for hard surfaces and cold weather conditions. Redip the applicator in primer as required. When the surface is primed, remove any puddles of primer from the socket of the fitting.



9. Apply the primer to the spigot end equal to the depth of the fitting socket. Use the same method of application used on the fitting socket.
10. A second application of the primer in the socket is recommended.
11. Immediately after reapplying the primer and while the surfaces are still wet, apply the appropriate cement. The correct cement for the job can be quickly determined by reading the container labels. Be sure that the cement is in a fluid condition. If it is thicker than normal or appears gel-like, it should not be used.
12. Stir the cement and apply it, using the correct applicator (outlined in step 6). Apply a thick, even layer of cement on the spigot, equal to the depth of the socket. Flow the cement on with the applicator. **DO NOT** brush it out to a thin layer which will dry in a few seconds.
13. Apply a medium layer of cement to the fitting socket; avoid puddling the cement in the socket. On bell-ended pipe, do not coat beyond the socket depth or allow cement to run down in the pipe beyond the bell.

14. Apply a second thick, even layer of cement on the spigot. There must be more than sufficient cement to fill any gap in the joint. Large-sized pipe and fittings may require two or more men to apply the primer and cement, and assemble the pipe and fitting.

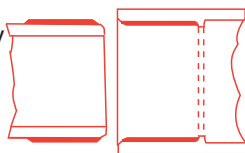

Cement Coatings of Sufficient Thickness

15. Attach the pipe to the fitting without delay. Cement must be wet. Use sufficient force to ensure that the spigot bottoms into the fitting socket. If possible, twist the spigot one-eighth to one-quarter turn as it is inserted.
16. Hold the pipe and fitting together for a short time (5 - 30 seconds) to eliminate pushout. Larger sizes with a tight fit may require more time. Since the fitting sockets are made with a taper, the pipe may move back out of the fittings just after assembly.

17. A joint will have a ring or bead of cement completely around the juncture of the pipe and fitting after assembly. If voids in this ring are present, insufficient cement was applied and the joint may be defective.

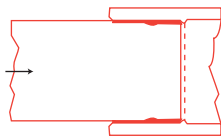

Assembly of Surfaces While They are Wet and Soft

18. Using a cloth, remove all excess cement from the pipe and fitting, including the ring or bead, as it will needlessly soften the pipe and the fitting, and does not add to joint strength.
19. Handle newly assembled joints carefully until the initial set has taken place. Recommended setting time allowed before handling or moving is related to temperature and is found on next page.
20. Joint strength development is very rapid within the first 48 hours. Short cure periods are satisfactory for high ambient temperatures with low humidity, small pipe sizes and interference-type fittings. Longer cure periods are necessary for low temperatures, large pipe sizes, loose fits and relatively high humidity.

Note: For solvent cementing 8" and larger pipe and fittings, the following is recommended:

- a. Two operators are needed, simultaneously applying primer and cement to the pipe and fittings.
- b. A heavy bodied medium setting cement or an extra-heavy, high strength cement are recommended. They provide thicker layers and have higher gap-filling properties. They also allow slightly more open time before assembly.
- c. A mechanical device may be needed to pull the joint together. This may be as simple as a 2 x 4 and a bar, or two "come-alongs" or lever pullers. When using the latter method, sufficient chain with a choker strap is laid out on either side of the joint. The "come-alongs" are then laid out on either side of the joint and adjusted to the correct length which is equivalent to the insertion depth. The primer and cement are then



applied; the “come-alongs” are immediately hooked up and the joint pulled together.

INITIAL SET TIME SCHEDULE

Initial Set Schedule for PVC Solvent Cements*					
Temp. Range	Pipe Size				
	1/2" - 1 1/4"	1 1/2" - 2"	2 1/2" - 8"	10" - 15"	15" +
60° - 100°F	2 min.	3 min.	30 min.	2 hrs.	4 hrs.
40° - 60°F	5 min.	8 min.	2 hrs.	8 hrs.	16 hrs.
0° - 40°F	10 min.	15 min.	12 hrs.	24 hrs.	48 hrs.

Note: Initial set schedule is the necessary time to allow before the joint can be carefully handled.

** These figures are estimates based on our laboratory tests. Due to the many variables in the field, these figures should be used as a general guide only.*

After the initial set time, the joints will withstand the stresses of a normal installation. (A misaligned installation will cause excessive stresses in the joint.) For long runs of pipe, care should be taken not to disturb joints for 1/2 to 1-1/2 hours before handling or burying.

JOINT CURE SCHEDULE

The following cure schedules may be used to determine the necessary time required after assembly before testing the system or before line pressure can be applied.

Relative Humidity	Joint Cure Schedule for PVC Solvent Cements**							
	½" - 1¼"		1¼" - 2"		2½" - 8"		10" - 15"	15" +
Temp. Range During Assembly & Cure Periods	up to 160-370		up to 160-315		up to 160-315		up to	up to
	160 psi	psi	160 psi	psi	160 psi	psi	100 psi	100 psi
60° - 100°F	15 min.	6 hrs.	25 min.	12 hrs.	1½ hrs.	24 hrs.	48 hrs.	72 hrs.
40° - 60°F	20 min.	12 hrs.	30 min.	24 hrs.	4 hrs.	48 hrs.	96 hrs.	6 days
0° - 40°F	30 min.	48 hrs.	45 min.	96 hrs.	72 hrs.	8 days	8 days	8 days

Note: Joint cure schedule is the necessary time to allow before pressurizing the system. In damp or humid weather, allow 50% more cure time.

***These figures are estimates based on our laboratory tests. Due to the many variables in the field, these figures should be used as a general guide only.*



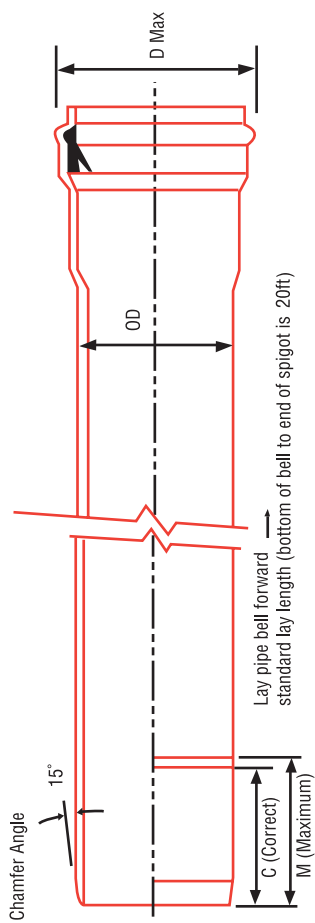

APPENDIX I - DIMENSIONS OF ASTM D2241 PRESSURE PIPES WITH IPS OD'S

NOM SIZE (in)	AVG OD (in)	MINIMUM INSERTION C (in)	MAXIMUM INSERTION M (in)	Dmax (inches)			
				SDR41	SDR32.5	SDR26	SDR21
1½	1.900	3.3	-	-	-	2.75	2.75
2	2.385	3.7	-	-	-	3.32	3.37
2½	2.875	4.2	-	-	-	3.82	3.87
3	3.500	4.8	-	-	-	4.54	4.6
4	4.500	4.8	-	5.5	5.5	5.6	5.7
6	6.625	4.8	-	7.8	7.9	8.0	8.1
8	8.625	5.4	-	10.1	10.2	10.3	10.5
10	10.750	6.3	-	12.6	12.7	12.9	13.1
12	12.750	6.5	-	14.7	14.8	15.0	15.3
14	14.000	7.0	8.0	16.2	16.4	16.6	16.9
16	16.000	8.9	9.9	18.5	18.7	19.0	19.2
18	18.000	9.9	10.9	20.7	20.9	21.2	21.6
20	20.000	10.7	11.7	23.1	23.3	23.6	24.0
24	24.000	11.7	12.7	27.5	27.8	28.2	28.6

APPENDIX II - DIMENSIONS OF AWWA C905 PRESSURE PIPES WITH CIOD'S

NOM SIZE (in)	AVG OD (in)	MINIMUM INSERTION C (in)	MAXIMUM INSERTION M (in)	Dmax (inches)					
				DR51	DR41	DR32.5	DR25	DR18	DR14
4	4.8	5.8	-	-	-	-	6.0	6.1	6.3
6	6.9	6.4	-	-	-	-	8.3	8.5	8.7
8	9.1	7.1	-	-	-	-	10.8	11.0	11.3
10	11.1	7.6	-	-	-	-	13.3	13.7	14.0
12	13.2	8.1	-	-	-	-	15.6	16.0	16.4
14	15.3	8.0	9.0	17.7	-	-	18.2	18.7	19.2
16	17.4	10.0	11.0	20.0	-	-	20.6	21.1	21.7
18	19.5	10.5	11.5	22.3	-	-	23.0	23.6	24.2
20	21.6	11.5	12.5	24.9	-	-	25.6	26.3	-
24	25.8	13.0	14.0	29.6	29.9	29.9	30.4	31.2	-
30	32.0	14.5	15.5	36.1	36.5	36.5	37.1	-	-
36	38.3	15.5	16.5	42.9	43.4	43.4	44.1	-	-
42	44.5	16.0	17.0	49.4	50.0	50.0	50.9	-	-
48	50.8	17.0	18.0	56.1	56.7	56.7	57.8	-	-

ASTM EMBEDMENT MATERIAL CLASSIFICATION		DENSITY AASHTO T-99	E ' (psi)	DR	HEIGHT OF COVER (feet)												
					1.0	2.0	3.3	6.6	9.8	13.1	16.4	19.7	26.3	29.5	32.8	49.2	
		% Deflection															
Manufactured Granular Angular	CLASS I	90%	3,000	25 18 14	0.7	0.5	0.3	0.3	0.4	0.5	0.7	0.8	0.9	1.1	1.2	1.4	2.0
					0.6	0.4	0.3	0.3	0.3	0.5	0.6	0.7	0.8	0.9	1.0	1.2	1.7
					0.5	0.3	0.2	0.2	0.3	0.4	0.4	0.5	0.6	0.7	0.8	0.9	1.3
Clean Sand & Gravel	CLASS II	90%	2,000	25 18 14	1.0	0.7	0.5	0.5	0.6	0.8	1.0	1.2	1.4	1.6	1.7	1.9	2.9
					1.0	0.7	0.4	0.4	0.5	0.6	0.8	0.9	1.1	1.2	1.4	1.6	2.3
					0.6	0.4	0.3	0.3	0.3	0.4	0.6	0.7	0.8	0.9	1.0	1.1	1.7
Sand & Gravel With Fines	CLASS III	80%	1,000	25 18 14	1.7	1.2	0.8	0.8	1.0	1.4	1.7	2.0	2.4	2.7	3.1	3.4	5.1
					1.2	0.8	0.6	0.6	0.7	0.9	1.2	1.4	1.7	1.9	2.1	2.4	3.6
					0.8	0.5	0.4	0.4	0.4	0.6	0.7	0.9	1.1	1.2	1.3	1.5	2.2
Sand & Gravel With Fines	CLASS III	90%	1,000	25 18 14	1.7	1.2	0.8	0.8	1.0	1.4	1.7	2.0	2.4	2.7	3.1	3.4	5.1
					1.2	0.8	0.6	0.6	0.7	0.9	1.2	1.4	1.7	1.9	2.1	2.4	3.6
					0.8	0.5	0.4	0.4	0.4	0.6	0.7	0.9	1.1	1.2	1.3	1.5	2.2
Silt & Clay	CLASS IV	85%	500	25 18 14	n/r	n/r	1.3	1.4	1.6	2.2	2.7	3.3	3.8	4.4	4.9	5.5	8.2
					n/r	n/r	0.8	0.8	1.0	1.3	1.6	1.9	2.3	2.6	2.9	3.2	4.8
					n/r	n/r	0.4	0.4	0.5	0.7	0.9	1.1	1.3	1.4	1.6	1.8	2.7
Silt & Clay	CLASS IV	85%	400	25 18 14	n/r	n/r	1.5	1.6	1.9	2.5	3.1	3.8	4.4	5.0	5.6	6.3	9.4
					n/r	n/r	0.8	0.9	1.0	1.4	1.7	2.1	2.4	2.8	3.1	3.5	5.2
					n/r	n/r	0.4	0.5	0.6	0.7	0.9	1.1	1.3	1.5	1.7	1.9	2.8

* For details on calculation parameters, see page 62

APPENDIX IV - Percent % Deflection for C900 / C905 Pipe and BLUE BRUTE Fittings

ASTM EMBEDMENT MATERIAL CLASSIFICATION	DENSITY AASHTO T-99	E' (psi)	DR	HEIGHT OF COVER (ft.) % Deflection												
				1.0	2.0	3.3	6.6	9.8	13.1	16.4	19.7	23	26.3	29.5	32.8	49.2
Manufactured Granular Angular	90%	3,000	51 41 32.5 25	0.7	0.5	0.4	0.4	0.4	0.6	0.7	0.9	1.0	1.2	1.3	1.1	2.2
				0.7	0.5	0.3	0.4	0.4	0.6	0.7	0.9	1.0	1.2	1.3	1.5	2.2
				0.7	0.5	0.3	0.3	0.4	0.5	0.7	0.8	1.0	1.1	1.2	1.4	2.0
Clean Sand & Gravel	90%	2,000	51 41 32.5 25	1.1	0.7	0.5	0.5	0.7	0.9	1.1	1.3	1.5	1.8	2.0	2.2	3.3
				1.1	0.7	0.5	0.5	0.6	0.9	1.1	1.3	1.5	1.7	1.9	2.2	3.2
				1.0	0.7	0.5	0.5	0.6	0.8	1.0	1.3	1.5	1.7	1.9	2.1	3.1
				1.0	0.7	0.5	0.5	0.6	0.8	1.0	1.2	1.4	1.6	1.7	1.9	2.9
Sand & Gravel With Fines	80%	1,000	51 41 32.5 25	2.2	1.5	1.0	1.1	1.3	1.7	2.2	2.6	3.0	3.5	3.9	4.3	6.5
				2.1	1.4	1.0	1.0	1.3	1.7	2.1	2.5	2.9	3.4	3.8	4.2	6.3
				2.0	1.3	0.9	1.0	1.2	1.6	2.0	2.4	2.8	3.2	3.5	3.9	5.9
				1.7	1.2	0.8	0.8	1.0	1.4	1.7	2.0	2.4	2.7	3.1	3.4	5.1
Silt & Clay	90%	1,000	51 41 32.5 25	2.2	1.5	1.0	1.1	1.3	1.7	2.2	2.6	3.0	3.5	3.9	4.3	6.5
				2.1	1.4	1.0	1.0	1.3	1.7	2.1	2.5	2.9	3.4	3.8	4.2	6.3
				2.0	1.3	0.9	1.0	1.2	1.6	2.0	2.4	2.8	3.2	3.5	3.9	5.9
				1.7	1.2	0.8	0.8	1.0	1.4	1.7	2.0	2.4	2.7	3.1	3.4	5.1
CLASS III	85%	500	51 41 32.5 25	n/r	n/r	2.0	2.1	2.5	3.3	4.2	5.0	5.9	6.7	7.5	8.4	12.6
				n/r	n/r	1.9	2.0	2.4	3.1	3.9	4.7	5.5	6.3	7.1	7.9	11.8
				n/r	n/r	1.7	1.7	2.1	2.8	3.5	4.2	4.9	5.6	6.3	7.0	10.5
				n/r	n/r	1.3	1.4	1.6	2.2	2.7	3.3	3.8	4.4	4.9	5.5	8.2
CLASS IV	85%	400	51 41 32.5 25	n/r	n/r	2.4	2.6	3.1	4.1	5.2	6.2	7.2	8.3	9.3	10.3	15.5
				n/r	n/r	2.3	2.4	2.9	3.8	4.8	5.7	6.7	7.7	8.6	9.6	14.4
				n/r	n/r	2.0	2.1	2.5	3.3	4.1	5.0	5.8	6.7	7.5	8.3	12.4
				n/r	n/r	1.5	1.6	1.9	2.5	3.1	3.8	4.4	5.0	5.6	6.3	9.4

* For details on calculation parameters, see page 62

APPENDIX V - Percent % Deflection for IPSOD Pipe and CYCLE TOUGH Fittings

ASTM EMBEDMENT MATERIAL CLASSIFICATION		DENSITY AASHTO T-99	E' (psi)	SDR	HEIGHT OF COVER (ft.)													
					1.0	2.0	3.3	6.6	9.8	13.1	16.4	19.7	23	26.3	29.5	32.8	49.2	
Manufactured Granular Angular	CLASS I	90%	3,000	41 32.5 26 21	0.7	0.5	0.3	0.4	0.4	0.6	0.7	0.9	1.0	1.2	1.3	1.5	2.2	3.2
					0.7	0.5	0.3	0.4	0.4	0.6	0.7	0.9	1.0	1.1	1.3	1.4	2.1	3.1
					0.7	0.5	0.3	0.3	0.4	0.5	0.7	0.8	1.0	1.1	1.2	1.4	2.0	2.9
Clean Sand & Gravel	CLASS II	90%	2,000	41 32.5 26 21	1.1	0.7	0.5	0.5	0.6	0.9	1.1	1.3	1.5	1.7	1.9	2.2	3.2	
					1.0	0.7	0.5	0.5	0.6	0.8	1.0	1.3	1.5	1.7	1.9	2.1	3.1	
					1.0	0.7	0.5	0.5	0.6	0.8	1.0	1.2	1.4	1.6	1.8	2.0	2.9	
Sand & Gravel With Fines	CLASS III	80%	1,000	41 32.5 26 21	0.9	0.6	0.4	0.4	0.5	0.7	0.9	1.1	1.2	1.4	1.6	1.8	2.6	
					2.1	1.4	1.0	1.0	1.3	1.7	2.1	2.5	2.9	3.4	3.8	4.2	6.3	
					2.0	1.3	0.9	1.0	1.2	1.6	2.0	2.4	2.8	3.2	3.5	3.9	5.9	
Silt & Clay	CLASS IV	85%	400	41 32.5 26 21	1.7	1.2	0.8	0.9	1.0	1.4	1.8	2.1	2.5	2.8	3.1	3.5	5.3	
					1.4	1.0	0.7	0.7	0.9	1.2	1.4	1.7	2.0	2.3	2.6	2.9	4.3	
					2.1	1.4	1.0	1.0	1.3	1.7	2.1	2.5	2.9	3.4	3.8	4.2	6.3	
Sand & Gravel With Fines	CLASS III	90%	1,000	41 32.5 26 21	2.1	1.4	1.0	1.0	1.3	1.7	2.1	2.5	2.9	3.4	3.8	4.2	6.3	
					2.0	1.3	0.9	1.0	1.2	1.6	2.0	2.4	2.8	3.2	3.5	3.9	5.9	
					1.7	1.2	0.8	0.9	1.0	1.4	1.8	2.1	2.5	2.8	3.1	3.5	5.3	
Sand & Gravel With Fines	CLASS III	85%	500	41 32.5 26 21	1.4	1.0	0.7	0.7	0.9	1.2	1.4	1.7	2.0	2.3	2.6	2.9	4.3	
					n/r	n/r	1.9	2.0	2.4	3.1	3.9	4.7	5.5	6.3	7.1	7.9	11.8	
					n/r	n/r	1.7	1.7	2.1	2.8	3.5	4.2	4.9	5.6	6.3	7.0	10.5	
Silt & Clay	CLASS IV	85%	400	41 32.5 26 21	n/r	n/r	1.4	1.4	1.7	2.3	2.9	3.5	4.0	4.6	5.2	5.7	8.6	
					n/r	n/r	1.0	1.1	1.3	1.7	2.1	2.6	3.0	3.4	3.9	4.3	6.4	
					n/r	n/r	2.3	2.4	2.9	3.8	4.8	5.7	6.7	7.7	8.6	9.6	14.4	
Silt & Clay	CLASS IV	85%	400	41 32.5 26 21	n/r	n/r	2.0	2.1	2.5	3.3	4.1	5.0	5.8	6.7	7.5	8.3	12.4	
					n/r	n/r	1.6	1.6	2.0	2.6	3.3	4.0	4.6	5.3	5.9	6.6	9.9	
					n/r	n/r	1.1	1.2	1.4	1.9	2.4	2.8	3.3	3.8	4.3	4.7	7.1	

* For details on calculation parameters, see page 62

APPENDIX VI - Percent % Deflection for TRENCH TOUGH PLUS SDR35 & TRENCH TOUGH PLUS SDR26 Heavy Wall Fittings

ASTM EMBEDMENT MATERIAL CLASSIFICATION	DENSITY (PROCTOR) AASHTO T-99	E' (PSI)	SDR	HEIGHT OF COVER (ft.)											
				1	2	5	10	15	20	25	30	35	40	45	50
Manufactured Granular Angular	90%	3,000	35	0.7	0.5	0.3	0.4	0.7	0.9	1.1	1.3	1.5	1.8	2.0	2.2
			26	0.7	0.5	0.3	0.4	0.6	0.8	1.0	1.3	1.5	1.7	1.9	2.1
Clean Sand & Gravel	90%	2,000	35	1.1	0.7	0.5	0.7	1.0	1.3	1.6	1.9	2.3	2.6	2.9	3.2
			26	1.0	0.7	0.4	0.6	0.9	1.2	1.5	1.8	2.1	2.4	2.7	3.0
	80%	1,000	35	2.0	1.4	0.9	1.2	1.8	2.5	3.0	3.7	4.3	4.9	5.5	6.0
			26	1.7	1.2	0.8	1.1	1.6	2.1	2.7	3.2	3.7	4.3	4.8	5.3
Sand & Gravel with Fines	90%	1,000	35	2.0	1.4	0.9	1.2	1.8	2.5	3.0	3.7	4.3	4.9	5.5	6.0
			26	1.7	1.2	0.8	1.1	1.6	2.1	2.7	3.2	3.7	4.3	4.8	5.3
	85%	500	35	n/r	2.5	1.6	2.2	3.4	4.5	5.6	6.7	7.8	8.9	10.0	11.2
			26	n/r	1.9	1.2	1.8	2.6	3.5	4.4	5.3	6.1	7.0	7.9	8.8
Silt & Clay	85%	400	35	n/r	3.0	1.9	2.7	4.0	5.3	6.6	8.0	9.3	10.7	12.0	13.3
			26	n/r	2.2	1.4	2.0	3.0	4.0	5.0	6.0	7.0	8.0	9.0	10.0

* For details on calculation parameters, see page 62

* Appendices 3, 4, 5 & 6 were calculated using the following parameters.

1. Deflection values shown include effect of H-20 live load and dead load.
2. External loading based upon a prism load of soil weight of 120 lbs. per cubic foot.
3. Bedding classifications correspond to ASTM D2321.
4. The deflection lag factor is 1.0 for a prism load.
5. Recommended maximum deflection of 7.5% provides a generous 4 to 1 factor of safety.
6. n/r = not recommended

APPENDIX VII

PIPE DIMENSIONS

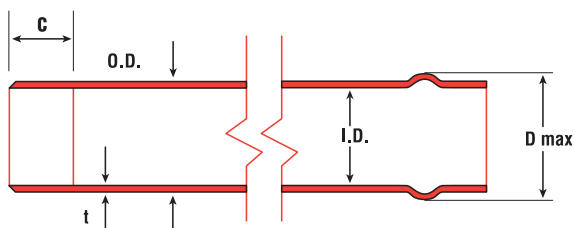

1. DR35 Gasketed Sewer Pipe - ASTM D3034

- where, O.D. = average outside diameter
 I.D. = average inside diameter
 t = minimum wall thickness
 Dmax = approximate outside diameter of the bell
 C = insertion depth

SDR35 - ASTM D3034				
Pipe Size (in.)	O.D. (in.)	I.D. (in.)	t (in.)	Dmax (in.)
4	4.22	3.91	0.15	5.31
6	6.28	5.89	0.22	7.52
8	8.40	7.89	0.24	9.65
10	10.50	9.86	0.30	12.20
12	12.50	11.74	0.35	14.33
15	15.30	14.37	0.44	17.40
18	18.70	17.56	0.54	21.65
21	22.05	20.71	0.63	25.20
24	24.80	23.30	0.71	27.56
27	27.95	26.26	0.80	31.50
30	32.00	30.07	0.91	36.46
36	38.30	36.00	1.09	43.62
42	44.50	41.81	1.27	49.80
48	50.80	47.73	1.45	56.50

Heavy Wall Sewer DR26

Pipe Size (in.)	O.D. (in.)	I.D. (in.)	t (in.)
4	4.22	3.90	0.162
6	6.28	5.80	0.241
8	8.40	7.75	0.323
10	10.50	9.69	0.404
12	12.50	11.54	0.481
15	15.30	14.12	0.588

2. Ultra-Rib

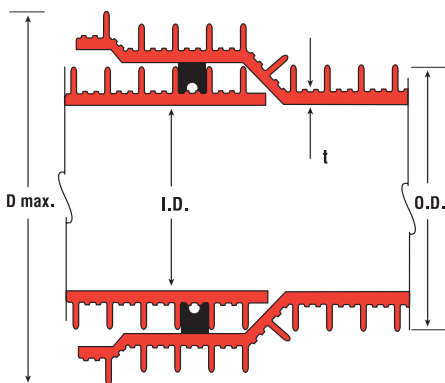

where, O.D. = average outside diameter of barrel
 I.D. = average inside diameter
 t = minimum waterway wall thickness
 Dmax = approximate outside diameter of the bell

Ultra Rib Pipe Size (in.)	O.D. (in.)	I.D. (in.)	t (in.)	Dmax (in.)
8	8.80	7.87	0.09	9.80
10	11.00	9.88	0.09	12.20
12	13.10	11.73	0.10	14.60
15	16.10	14.37	0.11	17.80
18	19.60	17.64	0.13	21.80
21	23.00	20.75	0.16	25.30
24	26.00	23.50	0.18	28.50



APPENDIX VIII

LUBRICANT USAGE
JOINTS PER CONTAINER

Pipe Size (in.)	Average Number of Joints per Container					
	(9 Oz)	(Pt)	(Qt)	(Gal)	(2½ Gal)	(5 Gal)
1½	42	85	160	640	1,840	3,680
2	35	70	140	560	1,610	3,220
2½	30	60	120	480	1,380	2,760
3	25	50	100	400	1,150	2,300
4	17	34	70	280	805	1,610
5	14	28	56	225	645	1,290
6	10	20	40	160	460	920
8	7	14	28	110	320	640
10	5	10	20	80	230	460
12	3	7	14	55	160	320
14	2	5	10	40	115	230
15	2	4	8	32	87	175
16	2	3	6	24	70	140
18	1	2	4	16	45	90
20	1	2	3	12	35	70
21	1	2	3	12	35	70
24	1	1	2	8	22	45
27		1	2	6	17	35
30			1	4	12	25
36				3	7	15
42				2	5	10
48				1	3	7

How to use the chart:

$$\frac{\text{\# of feet of pipe (per diameter)}}{\text{lay length of pipe (ft)}} = \text{\# of joints}$$

or

$$\text{\# of fittings} \times \text{\# of joints per fitting} = \text{\# of joints}$$

$$\frac{\text{\# of joints}}{\text{joints per container}} = \text{\# of containers}$$

For more information on
Multi Fittings



Fax this form to (905) 403-1124

or



E-mail to marketing@multifittings.com

PLEASE PRINT

Company

Name

Title

Address

City

State

Zip

Phone

ext.

Fax

E-mail

Website

Company Classification:

Distributor/Wholesaler

Engineering Firm

Contractor

Government

OEM - Products Manufactured: _____

Other: _____

SIC or industry

sector: _____

My primary markets are (check all that apply):

Commercial

Residential

Industrial

Utility

OEM

Institutional

Other: _____



MULTI FITTINGS

Multi Fittings Corp.
1055 Wilton Grove Road
London, Ontario N6A 4K3

Telephone: 519 681-2140

Toll Free: 800 265-1815

Fax: 519 681-2156



www.multifittings.com

WARRANTY: All of the company's Products are guaranteed against defects resulting from faulty workmanship or materials. The Company will replace, free of charge, including shipping charges for the replacement Products, any Products which are found to be defective in workmanship or material, provided that the following conditions are met:

- a) the Company is promptly notified in writing of such defect immediately upon discovery of same, and the defective Product is promptly returned to the Company;
- b) the defect is not due, without limitation, to faulty installation, misalignment of Products, vibration, ordinary wear and tear, corrosion, erosion, U.V. degradation, incompatible lubricants, pastes and thread sealants, unusual pressure surges or pulsation, water hammer, temperature shocking, or fouling; and
- c) the Products have not been altered or modified after leaving the Company's premises.

The warranty period can be specifically limited for certain Products as stated in writing in the Company's literature.

The Company will not allow claims for labor, materials and/or other expenses required to replace the defective Product, or to repair any damage resulting from the use thereof. The Company disclaims any responsibility for the Purchaser's calculations, product drawings or engineering design specifications. The Company's liability is limited to the purchase price applicable to the product.

It is agreed and understood that the Company's liability in respect to the sale is strictly limited to the replacement of Products as hereinbefore specified and that the Company shall not, in any event, be liable for any damages whether for the loss of use or business interruption or any other claim for incidental, consequential, special or punitive damages. There is no warranty, condition or representation of any nature whatsoever, expressed or implied, by statute or otherwise, except as herein contained, and the Company disclaims any implied warranties of merchantability and/or fitness of its Products for a special purpose.

This literature is published in good faith and is believed to be reliable. However IPEX does not represent and/or warrant in any manner the information and suggestions contained in this brochure. Data presented is the result of laboratory tests and field experience.

IPEX maintains a policy of ongoing product improvement. This may result in modifications of features and/or specifications without notice.



MULTI FITTINGS
HIGHER STANDARDS™