

**Rinnai Tankless Water Heater
Training Program
Level I
Product Knowledge**

Rinnai®

Rinnai Service and Support (800-621-9419)

- **CRC – Consumer Response Center – general calls, consumer questions, etc.**

Available from 8 a.m. to 8 p.m. EST, Monday – Friday.

- **Parts Department – parts orders.**

Available from 8 a.m. to 8 p.m. EST, Monday – Friday.

- **Warranty Department – warranty claim issues.**

Available from 8 a.m. to 5 p.m. EST, Monday- Friday.

- **Technical Support Department – technical issues related to the function and repair of all Rinnai products.**

Available in the office from 8 a.m. to 8 p.m. EST, Monday – Friday AND **24/7/365** on call support for technicians who are at the service location. **Technicians only, call 1-888-RINNAIS (888-746-6247)**

- **Engineering / Applications Department – calls related to product use and applications including sizing.**

Available from 8 a.m. to 5 p.m. EST, Monday - Friday.

Rinnai America also provides the following websites for support:

- www.rinnai.us –for installation manuals, product specifications and supporting documents. More technical information is available in the “For Professionals” section of the site under “Partner Portal”. Registration is required for access to this portion of the website.
- www.trainingevents.rinnai.us – for registration in Rinnai product training classes and videos (live and online classes). Service and installation manuals and other technical documents are available under the “Resources” section of the site.

The Evolution of Rinnai Tankless Water Heaters

Designation	Years produced	Generation	Other Notes
No specific designation	1999-2001	1 st Generation non-condensing models	2402 (indoor) and 2424 (outdoor) models.
“V” Series	2001-2006	2 nd Generation non-condensing models	Introduced “Continuum” (residential) and “Integrity” (commercial) models. In May 2005 the temperature controller and PCB were upgraded and the model designations changed. Example: R85i / R85e (residential) or C85i / C85e (commercial).
“VA” Series	2006-2010	3 rd Generation non-condensing models	Most VA models were called “LS”. Example: R94LSi / R94LSe. (except the V53e) No separate commercial models.
“VB” Series	2010	4 th Generation non-condensing models	Early VB models retained the “LSi” / “LSe” designation.
	2011		Introduced the “RL” model designation. Example: R94LSi became the RL94i. (V53e became the RV53e). This change indicated an isolation valve plumbing kit was included with the product. RV53i also introduced.
“VC” Series	2012	5th Generation non-condensing models	“RL” model designation retained. Value Series units introduced (V65i/e and V75i/e)
“KA” Series	2009-2010	1 st Generation condensing models	RC80HP and RC98HP models introduced. (High performance)
	2011		Isolation valve plumbing kit included with the product (same as VB series). The HP designation was dropped to indicate this change. Example: RC98HPi became the RC98i.
“KB” Series	2012	2nd Generation condensing models	Complete re-design of product and models are now called RU98i/e and RU80i/e

Current Water Heater Model Specifications

Detailed individual model spec sheets are available

Model Designation i=indoor models e=outdoor models	Full Model Number	Minimum Btu's	Maximum Btu's	Minimum Activation Rate (approx.)	Max Flow Rate 35° Temp Rise	Max Flow Rate 50° Temp Rise	Efficiency% or EF Rating
V53e	REU-VAM1620W	20.2 K – LP 19K - NG	120K	0.6 GPM	5.3 GPM	3.9 GPM	.82
V65i	REU-VC2025FFU	10.3K	152K	0.4 GPM	6.5 GPM	5.0 GPM	.82
V65e	REU-VC2025W						
V75i	REU-VC2528FFU	10.3K	180K	0.4 GPM	7.5 GPM	6.0 GPM	.82
V75e	REU-VC2528W						
RL75i	REU-VC2528FFUD	10.3K	180K	0.4 GPM	7.5 GPM	6.0 GPM	.82
RL75e	REU-VC2528WD						
RL94i	REU-VC2837FFUD	10.3K	199K	0.4 GPM	9.4 GPM	6.6 GPM	.82
RL94e	REU-VC2837WD						
RU80i	REU-KB2530FFUD	15.2K	157K	0.4 GPM	8.0 GPM	6.0 GPM	.96
RU80e	REU-KB2530WD		152K				
RU98i	REU-KB3237FFUD	15.2K	199K	0.4 GPM	9.8 GPM	7.6 GPM	.95
RU98e	REU-KB3237WD						

PRODUCT FEATURES

Rinnai[®]

Product Features:

- Rinnai tankless water heaters have an activation flow rate as low as 0.4 gallons per minute* and a minimum gas input rate as low as 10,000 Btu.*
 - This low Btu input rate allows for water heater operation at lower water flow rates.
 - Deactivation flow rate is approximately 0.26 gpm.*
- Non-condensing models have EF ratings of .82.
- Condensing models have EF ratings of .95 - .96.
- A temperature controller is included* to allow setting specific output water temperatures.
 - Maximum output temperature is limited to 120° F as it comes from the factory in order to meet certain building code requirements. This limit can be increased to 140° F if allowed or needed. The temperature can also be locked at a specific setting for all applications.
 - Temperature range for residential applications is 98° F to 140° F and 98° F to 185° F for commercial applications (temperatures above 140 degrees require the use of a commercial temperature controller).
 - Temperature settings can be displayed in Celsius.
- Ultra Low Nox (except RL94i and V53e).
- Isolation valve kit included (except Value series).
- Very low noise (approx. 49 decibels).
- Current production models are approved for mobile home installations.
- Modular home approved.
- All parts are replaceable.

Rinnai®

6 *Model Dependent – V53e is the exception.

Product Features / Safety Devices:

- Low voltage temperature controllers (12 VDC).
- Child / function lock capability on current models.
- Flame rod(s) validates presence of flame or indicates flame failure.
- Over heat bi-metal sensor(s).
- Integrated boiling protection.
- Heat exchanger thermal fuses.
- Leak detection with Luxury and Ultra Series internal units.
- Built-in freeze protection to -22° F for indoor units and -4° F for outdoor units (must have gas and electricity).
 - A drain down kit can be obtained to protect the unit from freezing in case of electrical failure or inadequate gas supply—non-condensing models only.
- Combustion fan senses blocked intake or exhaust flue.
- Direct electronic ignition (no standing pilot).
- PC Board is protected by a glass fuse (fuse size will vary by model).
- Main components are monitored by the circuit board and will post an error code if a failure is detected.

Rinnai®

Product Features: Rinnai Circ-Logic.

Rinnai Circ-Logic (RCL) programming offers a circulation option for applications that have a hot water circulation system with a dedicated return line*. The RCL programming built into the water heater's circuit board controls the on/off sequence and operational cycles of the circulation pump.

This feature is standard on Rinnai's current Ultra and Luxury Series units.

Circ-Logic has two modes of operation:

- Economy Mode: Cycles the pump less often** using less energy to maintain the circulation loop temperature. This mode can be used in applications where lower loop temperatures are acceptable or where the loop is well insulated and has minimal heat loss.
- Comfort Mode: Cycles the pump more frequently** ensuring the loop temperature remains higher (but also uses more energy). This mode can be used with loops that are not insulated and have a higher heat loss.

The RCL has been designed to provide the homeowner with the ability to customize their circulation systems based on variables such as home size, length of the circulation loop, piping insulation, and the homeowner's comfort and efficiency preferences.

*For pump size and loop length limitations see the installation manual.

**For pump cycle times see tables provided in the installation manual.

**TANKLESS
WATER HEATER
SIZING
AND SEQUENCE
OF OPERATION**

Rinnai®

What is Delta T (ΔT)?

Delta T (ΔT) is the difference between the incoming water temperature and the water heater's set point temperature. The maximum flow rate available from a tankless water heater will depend on the Delta T.

EXAMPLE: A home located in the St. Louis MO area....

The average ground water temperature is 57°

Rinnai Tankless Water Heater's temperature is set to 120°

Subtract the incoming water temperature from the water heater's set temperature to determine the ΔT : $120^{\circ} - 57^{\circ} = 63^{\circ}$

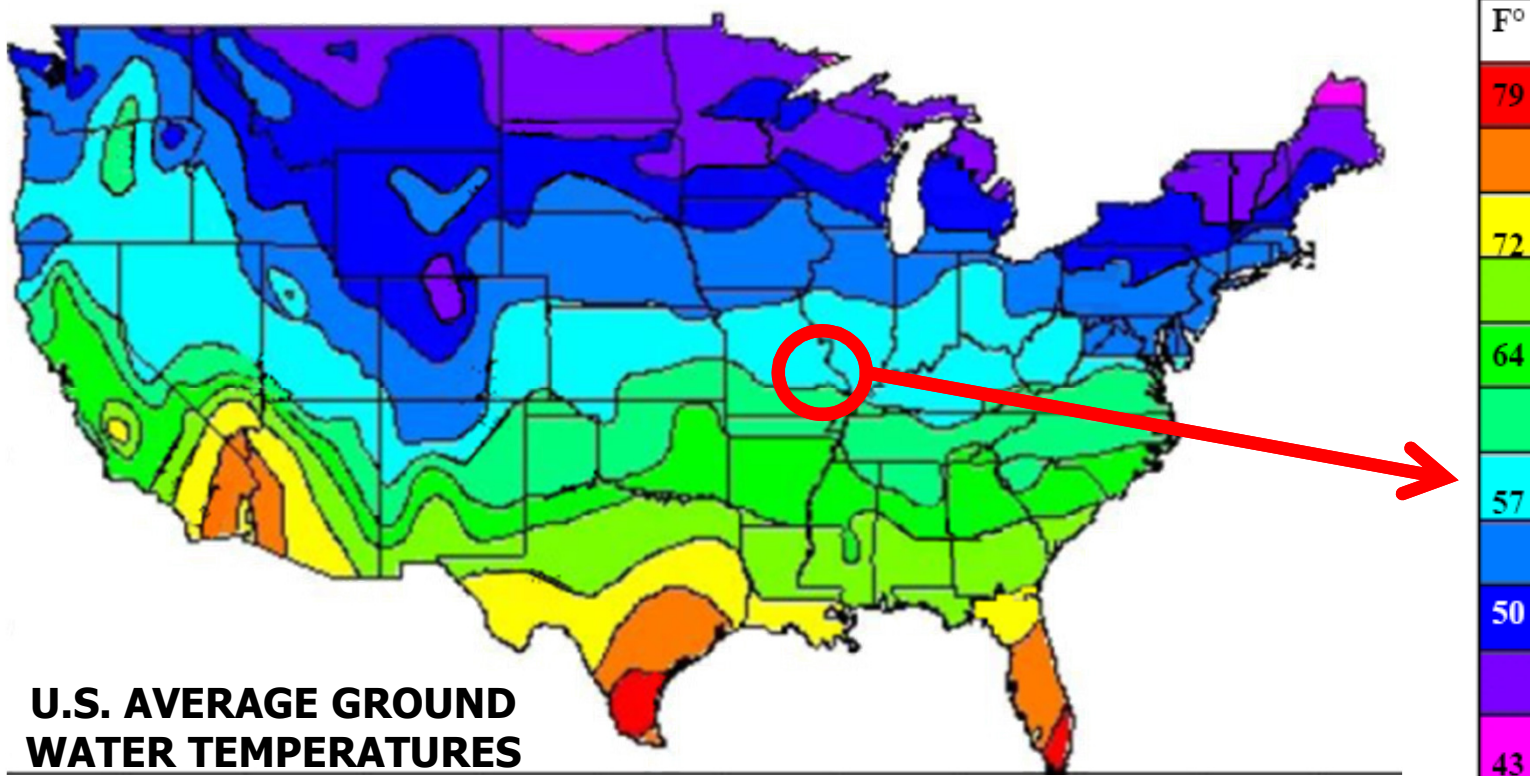

U.S. AVERAGE GROUND WATER TEMPERATURES

Rinnai

Maximum Flow Rate:

The tankless water heater's priority is to provide hot water at the set temperature. The water heater may need to regulate or limit flow in order to maintain the selected output temperature.

The maximum flow rate for any given Delta T for a particular Rinnai water heater can be determined using the flow chart for that model. The maximum flow rate can be found where the Delta T intersects the flow curve on the chart.

➤ Example from the previous page: Incoming water = 57°, Set-Point temperature = 120°, Delta T = 63°

Rinnai RL94 flow curve illustrated here.

Maximum flow rates can vary as water temperatures fluctuate throughout the year.

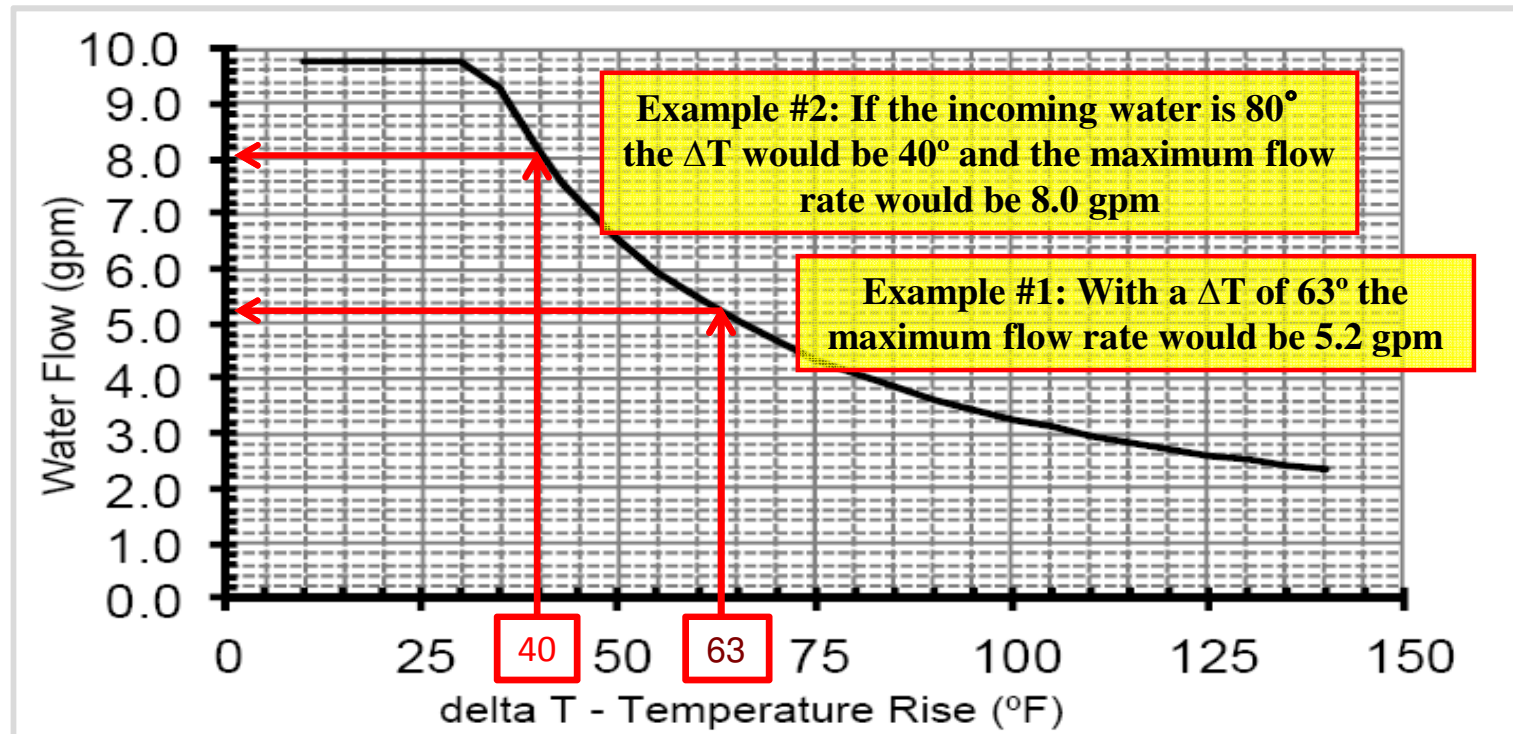





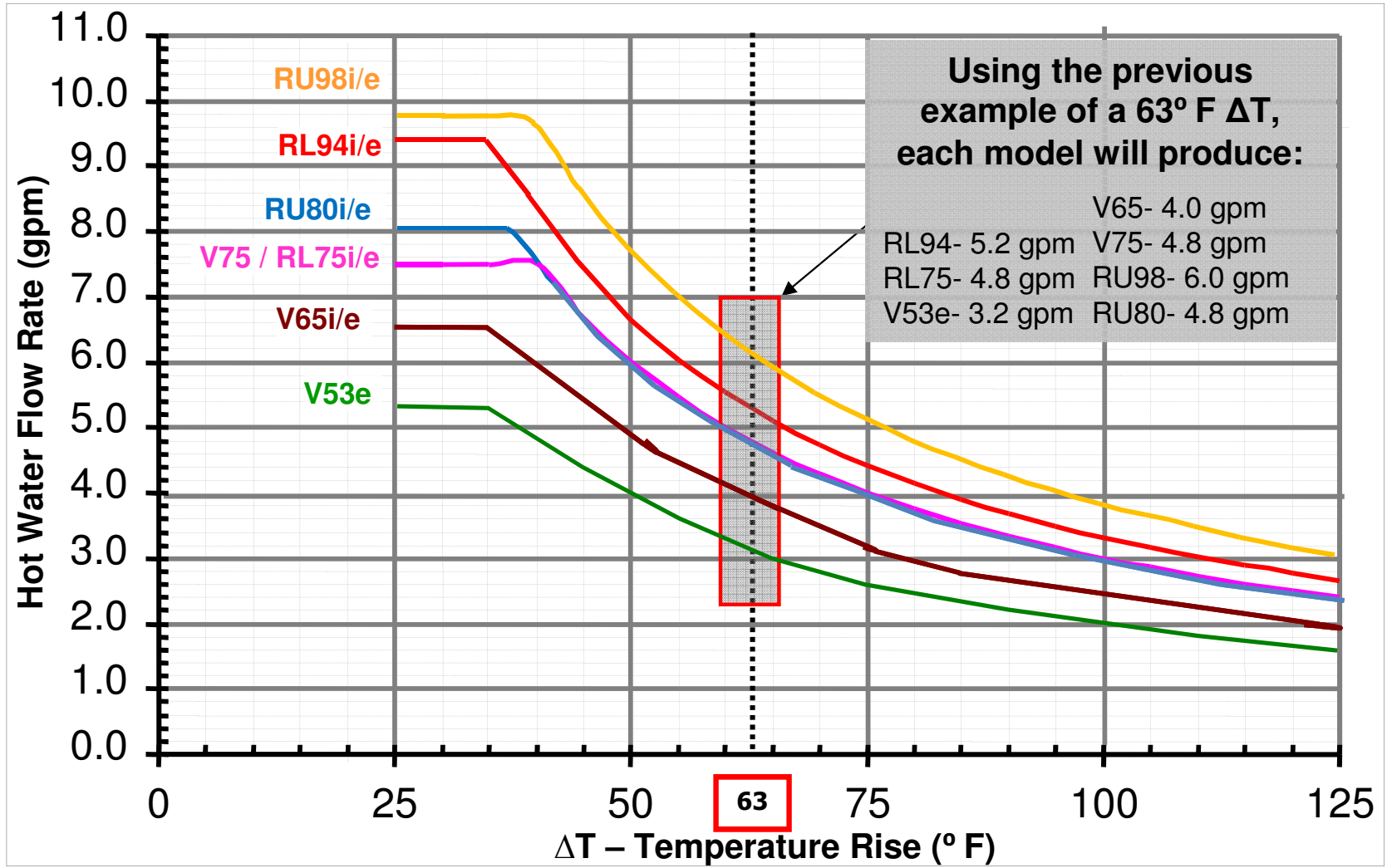









- In the first example, with a Delta T of 63° F, the maximum flow rate is 5.2 GPM.
- In the second example if the incoming water was as warm as 80°F the Delta T would be 40° F and the maximum flow rate would climb to 8.0 GPM.
- The installer will need to determine if these flow rates will be sufficient to meet the needs of the home or business. If not, a larger unit or multiple units may be required.

Maximum Flow Rate by Model:



Note the flow curves for the models listed above. For most models there is a distinct separation of the flow curves throughout the Delta T range. The exception is flow curves for the RU80 and RL75 / V75 models. The curves are identical for a Delta T of 40 degrees or higher. In this case the decision to choose one of these models over the other would be based on comparing the up front costs (product + venting + installation) to the long term costs taking into consideration the efficiency differences plus any rebates or tax credits that may be available for the more efficient condensing model.

Whole-House Sizing Chart:

Ground Water Temperature		
Model	Summer Season: 70° F	Winter Season: 50° F
V53e		
V65i/e		
V75i/e		
RL75i/e		
RL94i/e		
RU80i/e		
RU98i/e		

- Customer has the option of using the following appliances instead of a shower: residential grade clothes washing machines or dishwashers.
- Shower heads assumed to be 2.5 gpm mixed flow rate or less. If custom shower fixtures i.e. body sprays, large rain heads, or tubs over 60 gallons in capacity are used, please contact Rinnai.
- Bathroom sink faucets assumed to be 2 gpm mixed flow rate or less.
- Assumed mixed temperature on shower heads and bathroom sink faucets to be 104° F.
- Assumed Rinnai set point to be 120°F.
- Assumed 50 psi - 80 psi inlet water pressure for maximum flow.

Rinnai®

Sequence of Operation (VC): (indoor RL Non-condensing model)

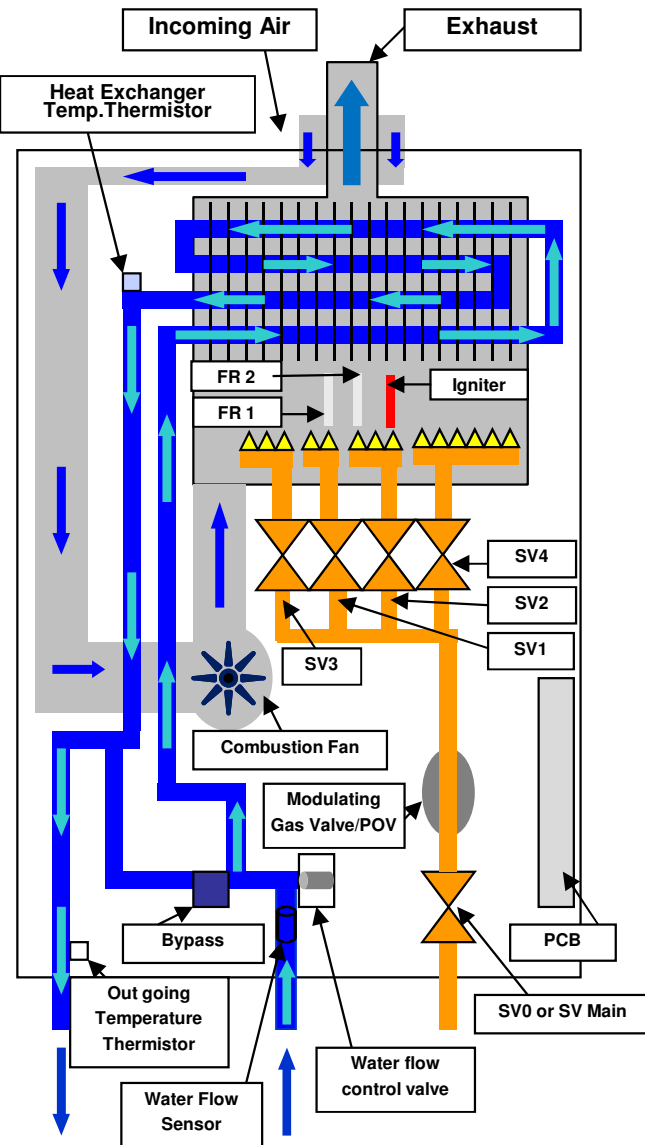

1. Water flow begins:

- Water flow sensor sends pulses to the PCB.
- When flow exceeds approximately *0.4 gpm the ignition sequence begins.

2. Ignition Sequence:

- Combustion fan starts, drawing air in from the venting and through the unit.
- Spark igniter begins sparking.
- Gas control assembly opens to the low fire rate.
- When the flame rods have proven flame the spark igniter stops sparking.

3. Normal Operation:

- PCB monitors flame rods, fan motor frequency, outlet water temperature, temperature set point, and water flow rate.
- Gas valve assembly & fan speed modulate gas and air input to meet user demand.
- If water flow demand is very small, only SV1 or SV2 will allow gas to burner, The appropriate flame rod (FR1 or FR2) will monitor this minimum fire state.
- If water flow demand is large, flame can develop across the entire burner.
- Water is heated as it passes through the heat exchanger multiple times.
- Heat exchanger can strategically overheat the water while the bypass tempers the water down to the set point temperature. This can allow for higher flow rates.
- The water flow control valve will adjust, as needed to help maintain output temperature.

4. Shut-down Sequence:

- PCB senses flow rate less than *0.26 gpm.
- Gas control valve closes & water flow control valve resets to a standby position.
- Combustion fan will then run for a period of time to purge the combustion chamber.

5. Standby Mode

- PCB monitors all components.

Rinnai[®]

*Model dependent

TANKLESS WATER HEATER INSTALLATION

Rinnai[®]

Modular / Manufactured Home Installation:

- **Modular Homes**

- A modular, panelized, or precut home is built in sections in a factory setting then transported to the site and assembled on a permanent foundation. This type of construction falls under the regulation of the building codes enforced in the jurisdiction where the home is to be located.
 - All Rinnai water heaters are approved for installation in modular, panelized, or precut homes.

- **Manufactured Homes (or Mobile Homes)**

- The ANSI standard defines a manufactured home as a structure, transportable in one or more sections, which in the traveling mode, is eight body feet or more in width or forty body feet or more in length, or when erected on site, is 320 or more square feet.
 - **All current production VC series (non-condensing) water heaters and KB series (condensing) water heaters are approved for installation in manufactured or mobile homes.**
 - Most Rinnai VB series (non-condensing) water heaters were also approved for manufactured or mobile home installation. Contact Rinnai if necessary to verify if a model is mobile home approved.
- The ANSI standard requires that all products for installation in manufactured homes be CSA certified with required labeling and instructions as well the ability to field convert gas type as necessary.
 - VC, KB and most VB models meet these requirements.
 - Most models prior to the VB series were also gas type convertible, however only VC, KB and Most VB models are approved to this standard for installation in manufactured homes.
- VC, KB and the approved VB models can also be retrofitted into existing manufactured homes (Local and State codes will apply).

Product Installation, Key Points:

(All current Rinnai models)

- Rinnai tankless water heaters can be used in both residential and commercial applications.
 - **except the Value Series, They are not to be used in commercial applications.**
- Rinnai tankless water heaters are manufactured for either natural gas or propane.
- Indoor models must be installed within the confines of a structure. This includes carports and crawlspaces.
- Outdoor models must be installed outside.
- Residential installations are potable water applications in single family dwellings with a maximum water temperature setting of 140°F.
- Commercial installations are potable water applications for restaurants, schools, hotels, car washes, coin laundries, assisted living facilities, etc. Hydronic applications are also defined as commercial installations.
 - For commercial applications requiring water temperatures over 140° F, the optional MCC-91 temperature controller allows a maximum water temperature setting of 160° F (on the V53, V65, V75 and RL75 models) or a maximum setting of 185° F (on the RU80, RU98 and RL94 models).

DO NOT use Rinnai water heaters in any application involving chemically treated water, (i.e. chlorinated pool water, hot tubs, etc.)

Rinnai®

Installation Requirements:

(All current models)

It is important to ensure the following incoming sources fall within specifications:

- **Electricity –**

- A properly polarized and grounded 120 VAC, 60 Hz power supply is required (temperature controllers operate on 12 VDC. This voltage is supplied by the water heater main circuit board).

- **Water –**

- Pipe sizing and incoming water pressure must meet each model's requirements as stated in the installation manual and, water quality must meet the EPA's National Secondary Drinking Standards.

- **Gas –**

- Adequate gas pressure and volume (gas line sizing) must be verified for proper operation.

- **Venting (air) –**

- Only the vent components that are certified and listed with the water heater model must be installed. The venting must be installed to specifications and proper clearances must be maintained.

➤ All national, state, and local codes must be followed.

Rinnai[®]

High Altitude Adjustments:

(All current models)

High Altitude Dip Switch Settings

- Proper gas volume and pressure must be supplied to the water heater at all times
- All of Rinnai's current non-condensing and condensing models do not require any manual gas valve adjustment to compensate for high altitude. Simply set DIP switches (**SW1 bank-tan colored**) on the PCB per the specific altitude to create the appropriate burn ratio for proper operation.

(Output is affected by altitude DIP switch adjustments)

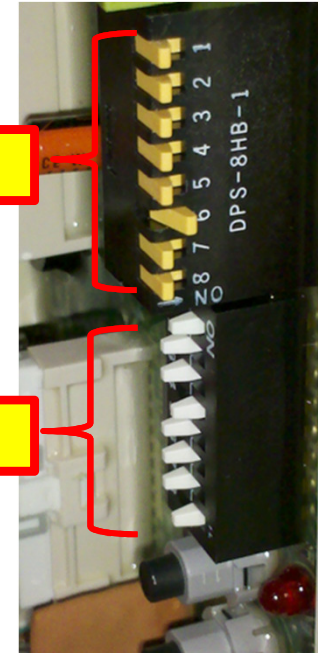

	0-2000 ft (0-610 m)	2001-5200 ft (610-1585 m)	5201-7700 ft (1585-2347 m)	7701-10200 ft (2347-3109 m)
Switch No. 2	OFF	OFF	ON	ON
Switch No. 3	OFF	ON	OFF	ON

Rinnai

Tankless Valve Kit:

- Rinnai recommends the use of an isolation valve kit when connecting the water lines to the water heater.
- All RL94, RL75, RU98, and RU80 models now include Webstone Isolation Valve kits!
 - This kit includes hot and cold water shut-off valves, hot and cold water drain valves, and an ANSI approved pressure relief valve.
 - This kit meets all individual states' lead-free standards.
- Use of this kit will allow flushing of the heat exchanger as well as aid in servicing and troubleshooting.
- **This kit is not included with the Value Series models.**

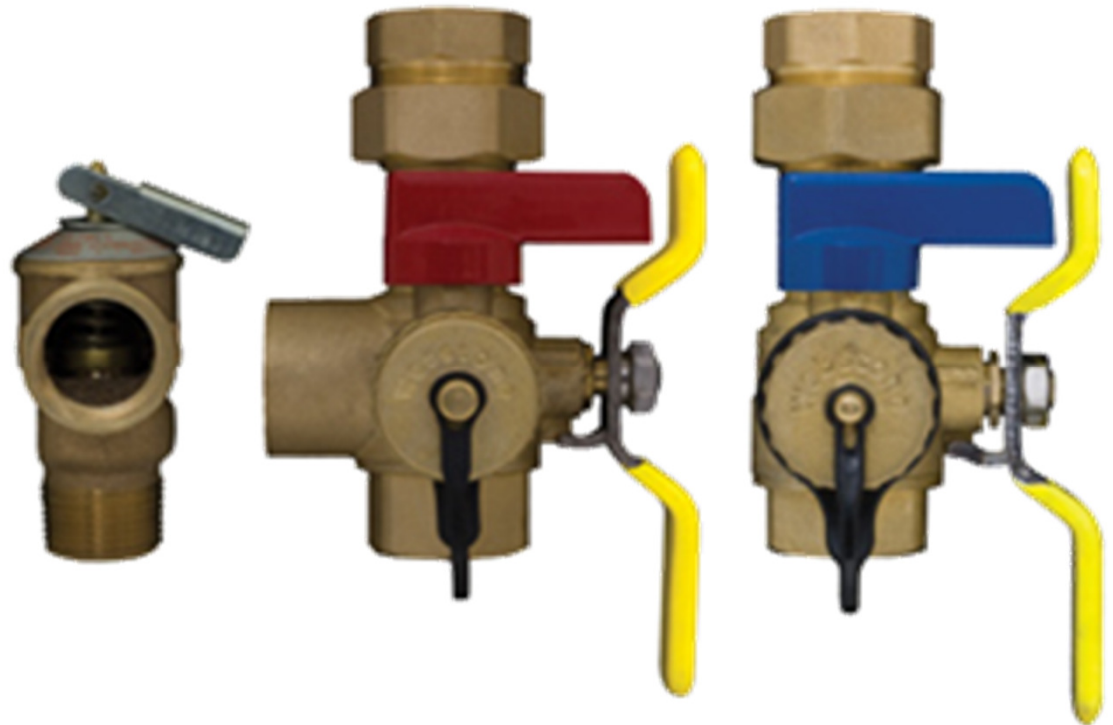

Rinnai®

VENTING REQUIREMENTS

- It is imperative to ensure proper vent guidelines are followed.
 - Ensure non-condensing and condensing guidelines are understood.
- Do not mix venting components between non-condensing and condensing models as dangerous conditions could occur!

! WARNING

Improper installation of vent system and components, or failure to follow all installation instructions, can result in property damage or serious injury

Rinnai®

Intake / Exhaust Guidelines:

For V53, V65, V75, RL75, and RL94 indoor models only

- Rinnai tankless water heaters are direct vent appliances and therefore are certified and listed with the vent system. Only vent components that are certified and listed with the water heater model should be used. Refer to the following table:

Listed and Tested Vent Products for the V65i, V75i, RL75i, and RL94i indoor models.	
Manufacturer	Product
Rinnai/Ubbink	Rolux Vent System (available from Rinnai)
Heat-Fab	Saf-T Vent SC system
Metal-Fab	Corr/Guard Vent/Air Intake System

- The above listed models use a concentric venting system which allows zero clearance from combustibles.
 - These models are equipped with a female vent connection at the top of the water heater. Therefore, an appliance adaptor is NOT needed.
 - These models also come equipped with an integrated condensation collector in the vent connector assembly.

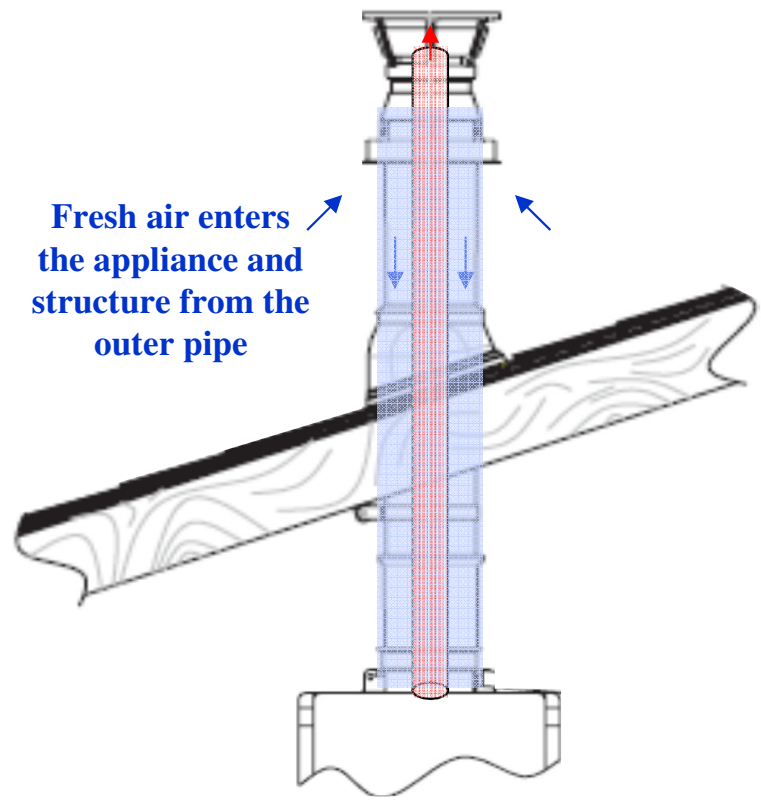

Fresh air enters the appliance and structure from the outer pipe

The exhaust exits the appliance and the structure from the center pipe

This is a balanced flue system. The incoming air keeps the outer pipe cool, allowing zero clearance for the venting system.



Vent Length Calculator – Indoor models:

- The maximum vent length for Non-condensing models is 41 equivalent feet.
- When calculating the equivalent vent length, each 90° elbow is equal to 6 feet and each 45° is equal to 3 feet.

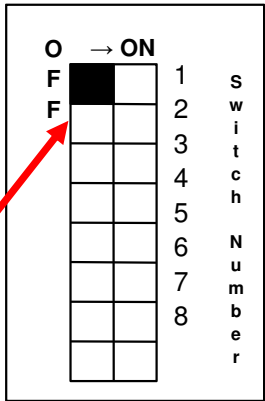
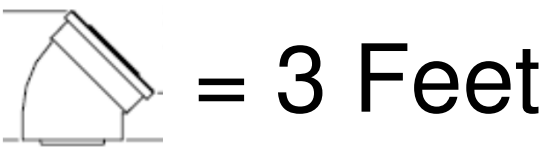
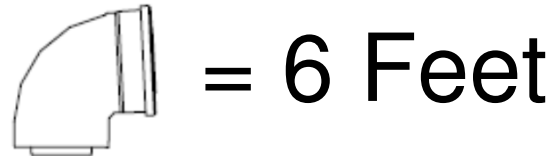

- If the equivalency is greater than 21 feet, move DIP switch #1 on the PCB (bank of eight tan colored) to the OFF position. (this switch is shipped in the ON position)

- Comply with all vent guidelines – refer to vent manufacturer and installation instructions.
- The water heater's maximum water flow capacity will be reduced slightly when DIP switch no. 1 is OFF.

Vent Length Example

Add the total length of all vent pipe and the equivalency of all bends:

- 3' (termination)
- +3' (bend)
- +2' (extension)
- +3' (bend)
- +2' (extension)

13 foot equivalency

In this example, DIP switch #1 would remain in the ON position

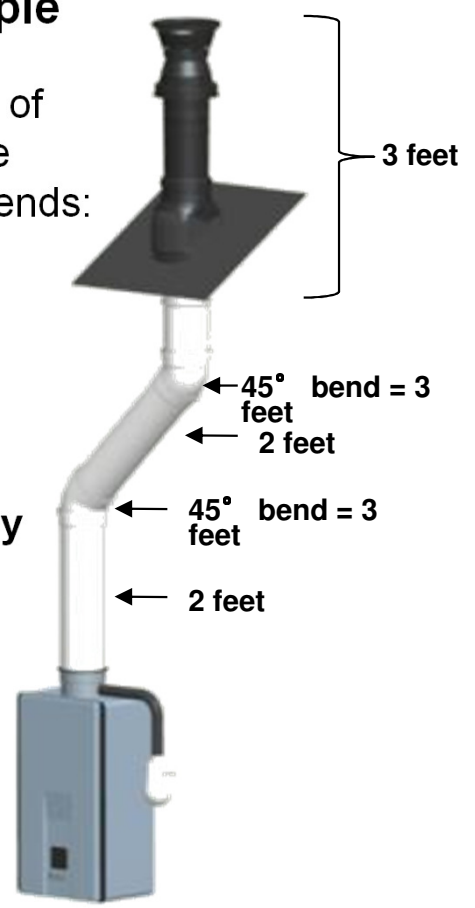

Temperature Controllers

Temperature Controllers:

Temperature controller guidelines are identical for non-condensing and condensing models



**MC-91-2
MCC-91-2***

*for commercial / hydronic use only



MC-195T

All current Rinnai models will accept up to four temperature controllers wired in parallel.

NOTE: Only one MC-195T per unit.

Rinnai®

MC-91-2/MCC-91-2 Temperature Controls:

TEMPERATURE INDICATION

Indicates the selected water temperature. Diagnostic Codes flash if operator intervention is required.

THERMOSTAT

Increases or decreases the desired water temperature

MODEL NUMBER



IN USE INDICATOR

Indicates that the unit is in operation

PRIORITY BUTTON & INDICATOR

When multiple controllers are installed, the priority button allows each to individually set temperature output of the water heater. The priority indicator reports which controller has control.

ON/OFF BUTTON

MC-91-2 and MCC-91-2 Controller Functions:

- Current production water heaters use the MC-91-2 and MCC-91-2 controllers (They replaced the MC-91-1 and MCC-91-1 controllers).
 - MC-91-2/MCC-91-2 controllers are backwards compatible. (Any model that came with a MC-91-1/MCC-91-1 controller can use the MC-91-2/MCC-91-2 controller).
 - The -2 controllers retain all functions found on the -1 controllers plus additional functions.
- An alternate table of temperature settings are available for commercial applications only (see “alternate temperature settings” in the install manual).
 - These alternate temperature settings are intended to provide additional temperature increments between 140°F and 185°F. These can only be accessed with the new “-2” controllers.
- Expanded Diagnostic functions (found previously only on the MC-100 controller) are now standard on the MC-91-2 and MCC-91-2 controllers.
- Controller now has a locking function.



Rinnai®

Standard and Alternate Temperature Settings:

Standard Temperature Setting Range																
Fahrenheit F°	98	100	102	104	106	108	110	115	120	125	130	135	140	150	160	185
										*	*	*	*	**	**	**
Celsius C°	37	38	39	40	41	42	43	46	49	52	54	57	60	66	71	85

* Default maximum temperature is 120°F. Temperature settings of 125°F to 140°F are available by setting switch #6 to the ON position on SW1 (upper set of switches).

** Temperatures above 140°F will require the use of a MCC-91 controller. When a MCC-91 controller is connected, the higher temperatures will be available on all controllers in the same system. Maximum temperature on some models will be limited to 160°F.

Alternate Temperature Setting Range																
Fahrenheit F°	110	115	120	125	130	135	140	145	150	155	160	165	170	175	180	185
								*	*	*	*	*	*	*	*	*
Celsius C°	43	46	49	52	54	57	60	63	66	68	71	74	77	79	82	85

*Alternate temperature settings are available with MCC-91-2 controllers only. Alternate temperature settings are for commercial applications only.

To select the alternate temperature settings, set dip switches #2 and #3 to the on position on SW2 (second or lower set of switches).

Alternate Settings

NOTE: When alternate temperature settings are used, the minimum temperature setting will be 110°F.

Built-in MC-91-2 Temperature Controller:

- The MC-91-2 controllers that are factory installed on indoor models (condensing and non-condensing) are specific to indoor models and cannot be removed and relocated or used on an outdoor model.
- These controllers are identical in function to other MC-91-2 controllers but are connected to the main circuit board by a 15 wire connector. Any additional controllers, or controllers for outdoor models, are connected to the circuit board by only two wires. The extra wire needed for remote mounted controllers is to be field supplied.
- The factory installed controllers retain all functions specific to the MC-91-2 series controllers.

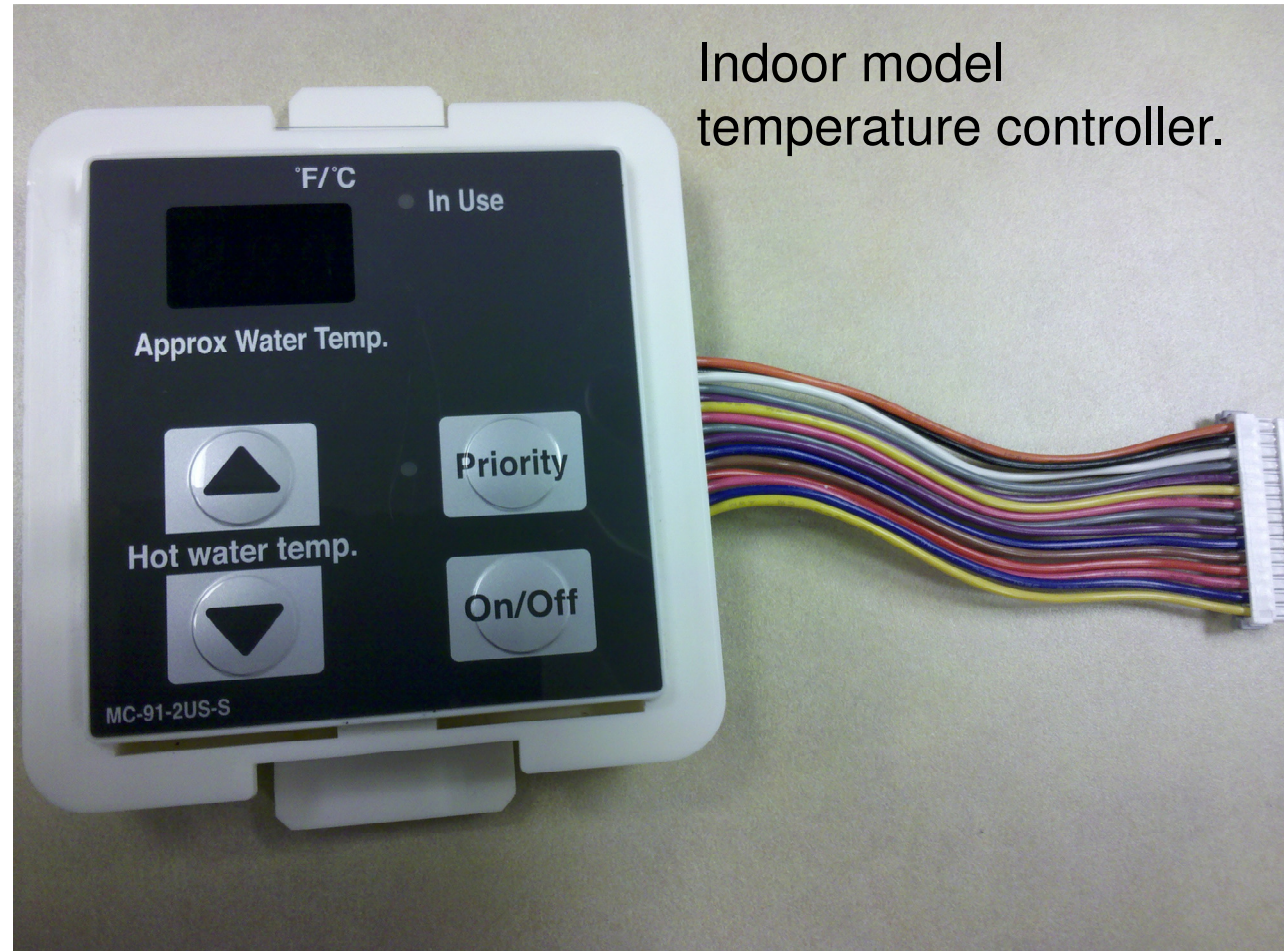

MC-195T Circulation Timer / Controller:

- This Timer / Temperature controller is for use with the Rinnai Luxury and Ultra series tankless water heaters equipped with Circ-Logic™ programming.
- The MC-195T timer controls when the Circ-Logic™ function is ON or OFF.
- The Circ-Logic™ programming on the main circuit board controls actual pump operation.



MC-195T-US

- Dual Timer Programs.
- Override Function to allow interruption of the timers without changing timer settings.
- Function Lock.
- Power Saving feature.
- Clock.
- Combustion and Circulation indicators.



Temperature Controllers (continued):



MC-100 *



BC-100 **

*The MC-100 has an extended diagnostic menu to aid in servicing (MC-91-2 and MCC-91-2 controllers have this same feature). **Only one MC-100 can be used per water heater and it cannot be used in conjunction with a MC-195T Timer / Controller.**

The BC-100 has a bath fill feature that allows limiting hot water flow to a specific number of gallons (between 10 and 120 gallons). **The BC-100 can monitor hot water flow only and only through one water heater. Do not use this controller for applications with two or more water heaters. Do not use with single handled fixtures and use only hot water when using the BC-100 controller. Only one BC-100 can be used per water heater. Do not use in conjunction with Circ-Logic.

Rinnai®

Temperature Controller Range: (for all current Rinnai Water Heaters)

- **All water heaters* manufactured in July, 2008 or later have the following temperature adjustment feature:**

➤ **Maximum default temperature setting of 120°F (49° C).**

- Meets the requirements of various local codes.
- Enhances the safety of users, especially children.
- Temperature settings between 125°F and 140°F (52° - 60°C) are available by setting DIP switch 6 to the ON position in the SW1 bank of 8 (upper set) DIP switches.

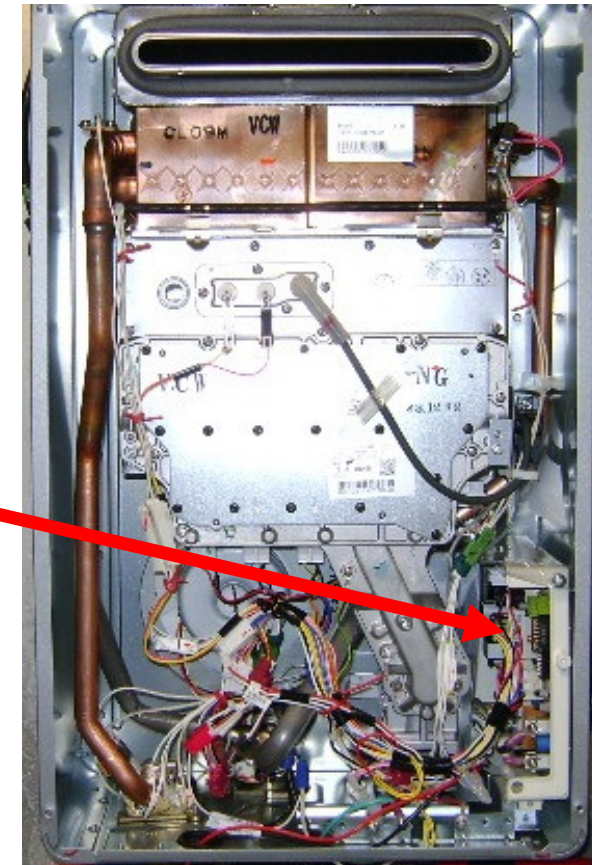
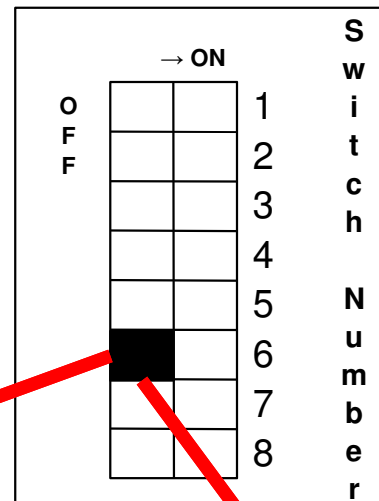
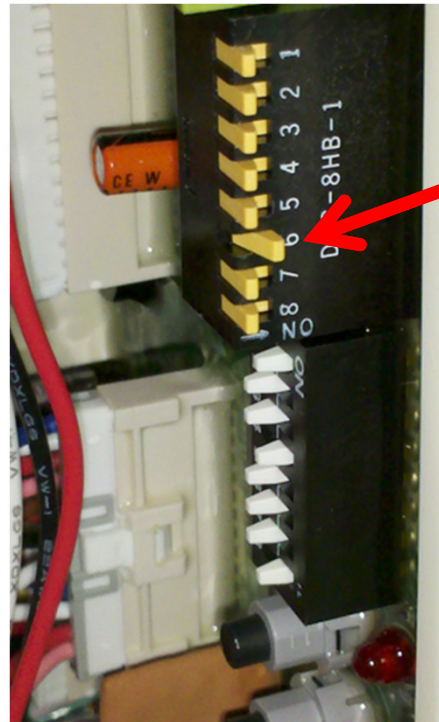

*The V53e does come with a temperature controller. This model can be set at 120° or 140° by a dip switch setting. If a MC-91 controller is connected it will not default at a max of 120°. These models will max at 140°. DIP switch 6 is allocated for another use.

Warranty

Rinnai[®]

Warranty: (see owner's manual for complete warranty guidelines)*

Item	Period of coverage (from date of purchase)		
	Residential Applications	Both residential water heating and space heating applications	Commercial Applications
Heat Exchanger	12 years (10 years Value Series) [1] [2]	10 years [1] [2]	5 years [1]
Other parts and components	5 years [1]	5 years [1]	5 years [1]
Reasonable Labor	1 year [3]	1 year [3]	1 year [3]

[1] Period of coverage is reduced to 3 years from date of purchase when used as a circulating water heater within a hot water circulation loop where the water heater is in series with a circulation system and where all circulating water flows through the water heater and where an on-demand circulation system is not incorporated.

- Note: The warranty for a condensing model heat exchanger used in a circulation system which is controlled through an aquastat / thermostat, or timer, or an on-demand system is 12 years for residential applications.
- Heat exchanger warranty for the Value series is 10 years but will increase to 12 years if a isolation valve kit is installed.
- If a Rinnai water heater is used in a commercial application, the commercial warranty will apply. Exception: V53, V65, and V75 models are not approved for commercial applications.

[2] Period of coverage is reduced to 5 years from date of purchase if the Rinnai water heater temperature setting exceeds 160°F (71°C).

[3] Labor coverage is extended to 5 years in residential applications and 2 years in commercial applications if the product is registered within 30 days (registration not required in California and Quebec) and/or if the other conditions above in the Residential and Commercial applications are satisfied.

- Warranty covers any defects in materials or workmanship when the product is installed and operated according to Rinnai written installation instructions
- Warranty applies only to products that are installed per local and/or state codes. Improper installation may void the warranty.
- Warranty doesn't cover failure due to accident, abuse, misuse, alteration, misapplication, force majeure, improper installation, maintenance, or service, inadequate water quality, scale buildup, or freeze damage
- There is no warranty coverage on product installed in a closed loop application commonly associated with space heating only applications.
- This warranty does not cover any product used in an application that uses chemically treated water such as a pool or spa heater.
- 34 ➤ The integrated controller on indoor models has a 1 year warranty on parts.

Rinnai Condensing Water Heater Differences

The following slides highlight some of the operation and installation differences plus some of the similarities between condensing water heaters as compared to non-condensing models.

Please read the installation manual that comes with each product for more specific information.

Rinnai[®]

Condensing Model Product Features:

Similarities and differences compared to Rinnai's non-condensing products

DIFFERENCES:

- Energy Factor rating as high as .96 (model dependent).
- Higher EF ratings could qualify for rebates and/or tax incentives.
- Integrated condensation trap—no need to address condensation in the vent system.
 - Draining direct to a drain system is permitted but a neutralizer may be required (check with local codes).
- Listed vent systems are different than Rinnai's non-condensing water heaters.
- Stainless steel secondary heat exchanger (primary heat exchanger is copper).

SIMILARITIES:

- Energy Star Qualified—Eligible for various utility and tax incentives.
- Activation flow rate of 0.4 GPM.
- Deactivation flow rate of 0.26 GPM.
- Current Rinnai temperature controllers are used with the condensing series.
 - Diagnostic codes are displayed on the controller.
- Venting clearances and equivalencies are similar to Rinnai's non-condensing water heaters.
- Rinnai condensing water heaters are approved for installations up to 10,200 feet.
 - The same altitude setting procedures exist for condensing models.

Rinnai[®]

Condensing Technology:

Non-condensing Water Heater

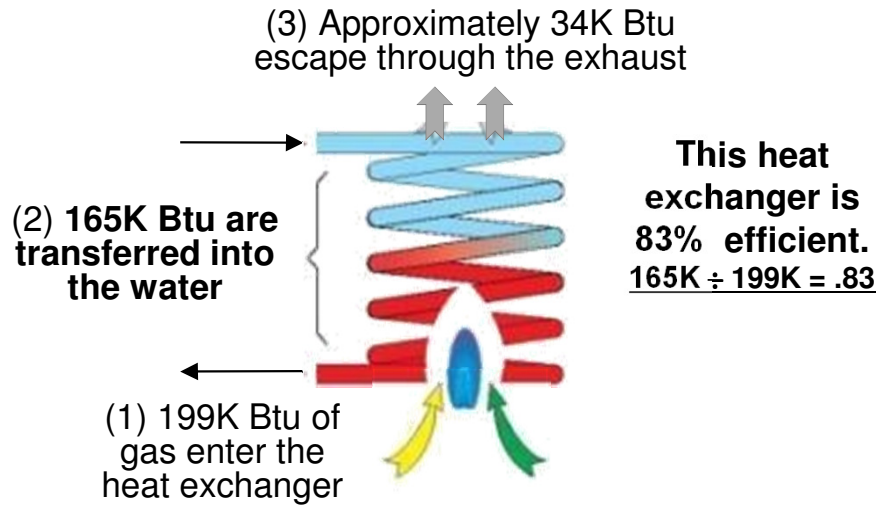

- When combustion occurs, there will always be some level of heat loss in the form of hot exhaust exiting the appliance through the vent system.
- The efficiency of a gas-fired appliance is measured by how much heat is actually transferred to the heating medium (water, air, etc) and how much is lost through the vent system.

- Condensing appliances capture extra heat (or latent heat) before it escapes into the vent system and transfers it, in the case of a water heater, into the water being heated.
- Capturing this extra heat cools the exhaust gasses below the dew point. Below the dew point any water vapor in the exhaust turns to liquid (condenses). This condensate combines with other combustion by-products to form an acid solution. Condensing appliances are designed to properly drain this condensation.

Condensing Water Heater

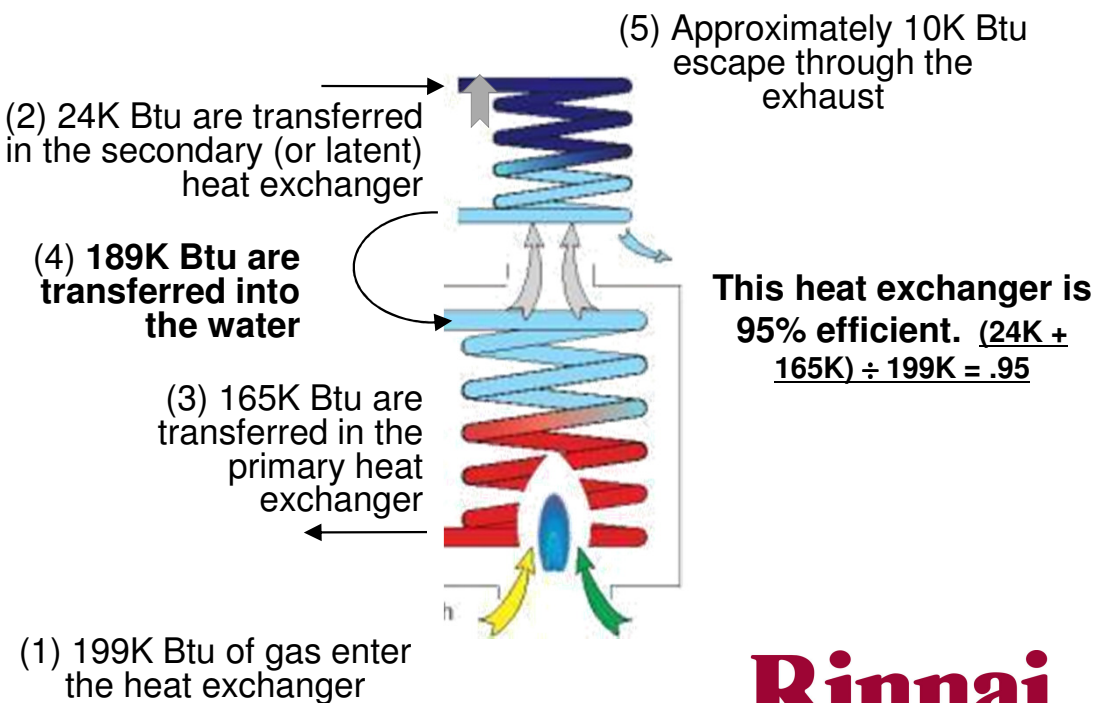

Condensing Technology:

KB Condensing Units

The RU98 and RU80 /KB series Condensing Units now have a down-fired ceramic burner (with a downward-burning flame)

This allows condensation to drain from the bottom of the heat exchanger assembly.

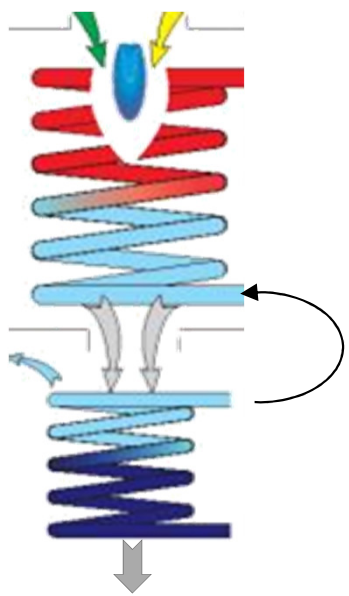

- Burner
- Primary Heat Exchanger
- Secondary Heat Exchanger
- Condensate Drain

Condensate will drain from secondary heat exchanger, protecting primary heat exchanger and burner.

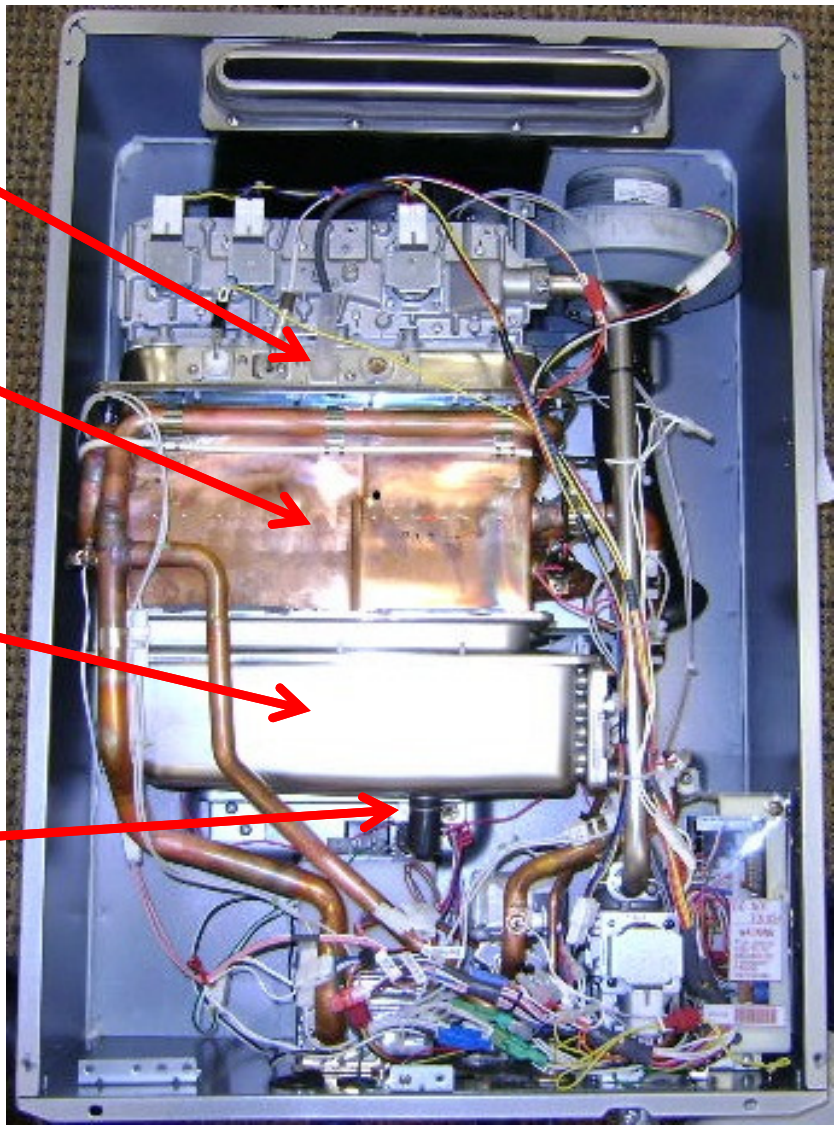

Approved venting systems:

(For condensing models only)

- Refer to the vent pipe manufacturers' instruction manual for assembly instructions.
- Rinnai indoor condensing water heaters are direct vent water heaters and therefore are certified with the listed vent system. Only vent components that are certified and listed with the water heater model should be used.

Listed and Tested Vent Products for the RU80i and RU98i

Manufacturer	Product	Description
Ubbink	Rolux Condensing Vent System	Polypropylene (PP-s)
Selkirk / Heat-Fab	Saf-T Vent SC system	AL29-4C Stainless Steel
Metal-Fab	Corr/Guard Vent/Air Intake System	
Centrotherm	InnoFlue Vent System	Single wall 3" (PP-s) PVC can be used ONLY for the intake side of the venting when using the Centrotherm system.
Ubbink *	Concentric to Twin Pipe adapter *	Polypropylene (PP-s) *
Various *	PVC schedule 40, PVC-DWV, CPVC, schedule 40 *	The Ubbink Twin Pipe adapter MUST be used with twin pipe PVC/CPVC venting. *

*** Twin Pipe PVC/CPVC venting is applicable on the KB series Condensing models ONLY**

- Ubbink aluminum concentric non-condensing venting is NOT approved for use with Rinnai condensing water heaters. (Ubbink non-condensing venting has an aluminum inner exhaust pipe).
- Ensure non-condensing and condensing guidelines are understood
- **DO NOT mix vent parts or the individual installation requirements between different vent manufacturers or types.**

Condensing Concentric Venting Parts: (For Condensing models only)

When purchasing or using Rinnai/Ubbink venting, ensure the proper vent material is used.

- The shipping box for the Rinnai/Ubbink polypropylene (PP-s) venting will have an asterisk on the part number label and the label description will read “Condensing”.
- Each Rinnai/Ubbink PP-s condensing vent component will have an orange/green warning Label on the outer/intake pipe and an orange/black label on the inner/exhaust pipe (inside label may be difficult to see).

Labeling on shipping box.

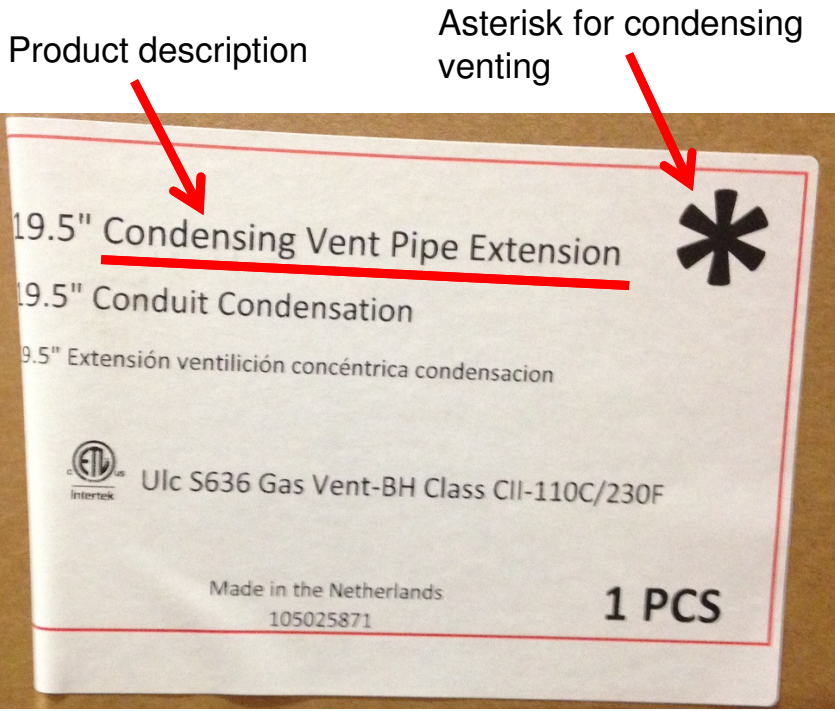

Warning label on each individual vent piece.

Inside pipe

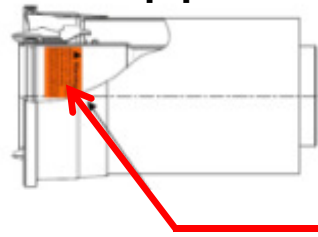

Outside pipe



Additional Rinnai Water Heating Options

Rinnai[®]

RH180 Hybrid Tank-Tankless

- Combination of a storage tank and a tankless water heater into one appliance.
- Provides increased hot water capacity over most standard tanks with the ease of a tank installation.
- 180 gallon First Hour Rating (equivalent to two standard 50 gallon water heaters).
- 80% thermal efficiency.
- Tank recovery approximately 15 minutes (starting from a cold tank).
- 5 different temperature settings.
- Multiple safeties and diagnostic functions.
- Circulation compatible.

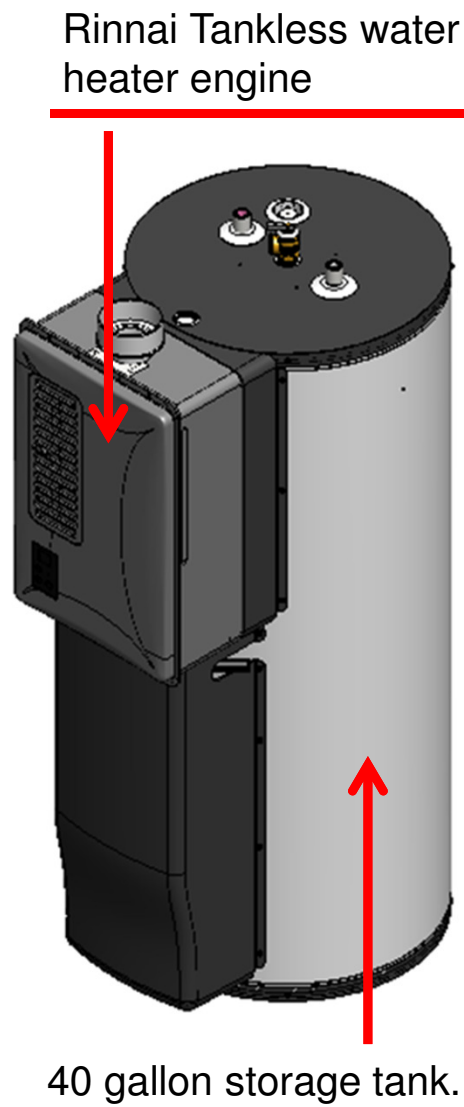

- Quick and Easy Installation (especially for emergency replacements).
- Piping configuration is the same as tank water heaters.
- Standard water lines and tank connections.
- Uses 4" B-Vent and can be common vented with a furnace.
- Can use 1/2" gas lines (in most cases).
- Heat loss from tank is minimized due to 2" of insulation and no burner or exhaust flue.

Rinnai®

Rinnai Condensing Boilers

- Three product lines, 10 models.
- Ultra-High efficiency (95%+ AFUE).
- Ultra-Low NOx emissions – SCAQMD approved.
- Six models have domestic hot water capability built in (Combi and Q-Premier models). Domestic hot water is also available on the Solo series models with optional 3-way diverter valve kit.
- Models from 50K Btu up to 205K Btu.
- Models available in Natural Gas or Propane but can be converted.
- Domestic hot water priority.
- Plumbing kit (Low Loss Header) included (except E50C).
- Ultra-Low Noise levels.



Rinnai®

MANUFACTURER ACCESSORIES

Rinnai[®]

Condensation Neutralizer Kit:

Features and Benefits

- Raises pH before discharging condensate into drain
- Clear Capsule – Easy to identify need for new media
- **For Condensing Boilers and Condensing Water Heaters**
- Can mount vertically and horizontally
- Fast and simple installation
- Refillable – Easy and inexpensive
- Capacity 1.6 Gallons/Hour (6.06 liters/hour)



P/N 80400074



P/N 809000114

Rinnai[®]

Domestic Priority Switch (DPS) / Maintenance Indication Switch:

This switch is intended to be installed in a Rinnai tankless water heater when connected to one of the following products or systems.....

- The switch can be used when a Rinnai tankless water heater is used in conjunction with a Rinnai or other branded hydronic air handler. The switch provides for domestic hot water priority and will turn the air handler off during high domestic hot water demands and allow it to come back on when the demand is reduced.
- The switch can also be used to connect a Rinnai water heater to a simple building management system. The switch will signal the building management system if an error code causes the water heater to shut down (it indicates only that a water heater is not operating, not what the actual fault code is).

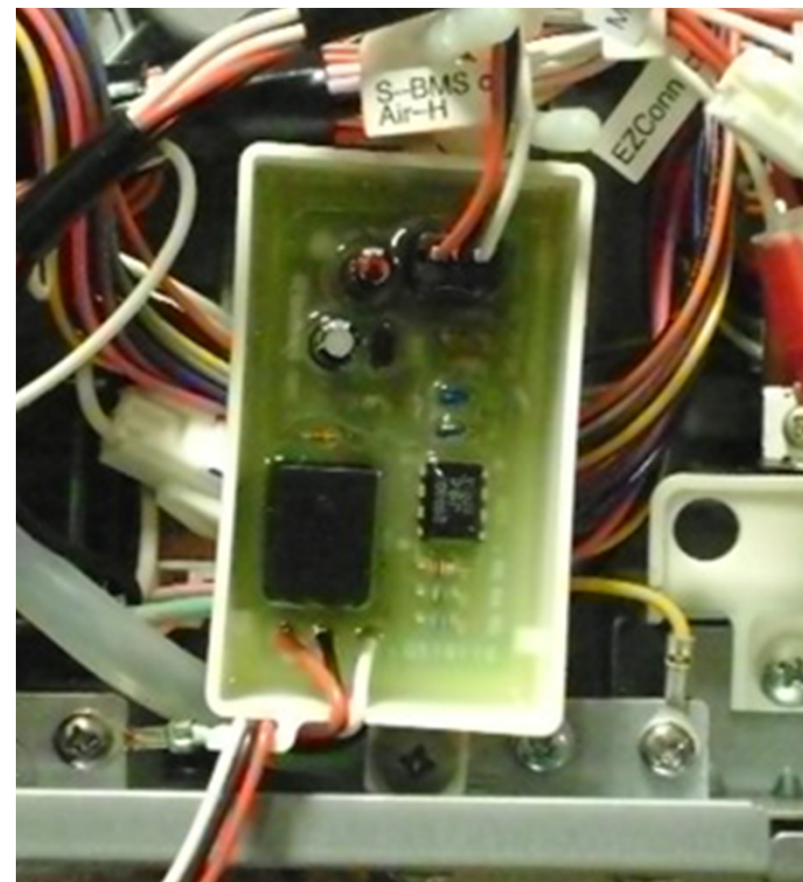

P/N 103000037

The switch is a volt-free Normally Open (NO) / Normally Closed (NC) switch.

Rinnai®

Accessories:

PIPE COVER BOXES

- Pipe Cover boxes mount underneath indoor or outdoor units to cover visible pipes and valves, increasing security and allowing for possible insulation of pipes.
- Pipe cover boxes connect to the bottom of indoor or outdoor water heaters, providing an aesthetically pleasing cover for incoming piping and electrical connections
- Pipe cover boxes also provide additional security and allow insulation of incoming plumbing inside the box
- Ensure the correct model box is ordered for each model water heater (color and design should be considered)



Rinnai®

Accessories:

RECESS BOXES

- Recess boxes allow outdoor units to be installed recessed into an exterior wall.
- A universal recess box for each model size is offered.
- A moisture seal-aluminum recess box is offered for some models. This is a flanged recess box designed for new builds to allow a water tight seal within the enclosure.
- Due to its width, condensing product recess boxes must be installed below a load bearing header. See installation instructions for details.
- A retrofit kits are available to allow the installation of a newer water heater in an older recess box.



Rinnai®

Recess / Pipe Cover Compatibility Parts List

The below chart shows applicable part numbers for each model:

PIPE COVER / RECESS BOX COMPATIBILITY		
Model	Pipe Cover Boxes	Recess Boxes
V53e	PC-20-W	RGB-20U
V65e and V75e	PCD03-EWV	RGB-25U-C
R75LSe / RL75e	PCD03-SM2	RGB-25U or RGB-25U-MSAL MSAL=Moisture Seal Aluminum
R94LSe / RL94e		
R98LSe or R98LSe ASME	PC-32-S	RGB-32-W
RC80e	PCD07-SM	RGB-CWTH
RC98e	Bottom plate sold separately-PCD07-SM-BP	
RL75e and RL94e (VA,VB, VC)	PCD03-SM2	RGB-25U-C
RU80e or RU98e (KB series)	PCD07-SM	RGB-CTWH-2
V65i and V75i	PCD03-EWV	Not Applicable
R75LSi / RL75i	PCD03-SM2	
R94LSi / RL94i	(use PCD03-SM for 2009 models or earlier)	
R98LSi or R98LSi ASME	PC-32-S	
RC80i / RU80i	PCD07-SM	
RC98i / RU98i	Bottom plate sold separately-PCD07-SM-BP	

Multiple unit installations

Rinnai[®]

Rinnai's MSB technology:

Why is multi-unit control technology needed?

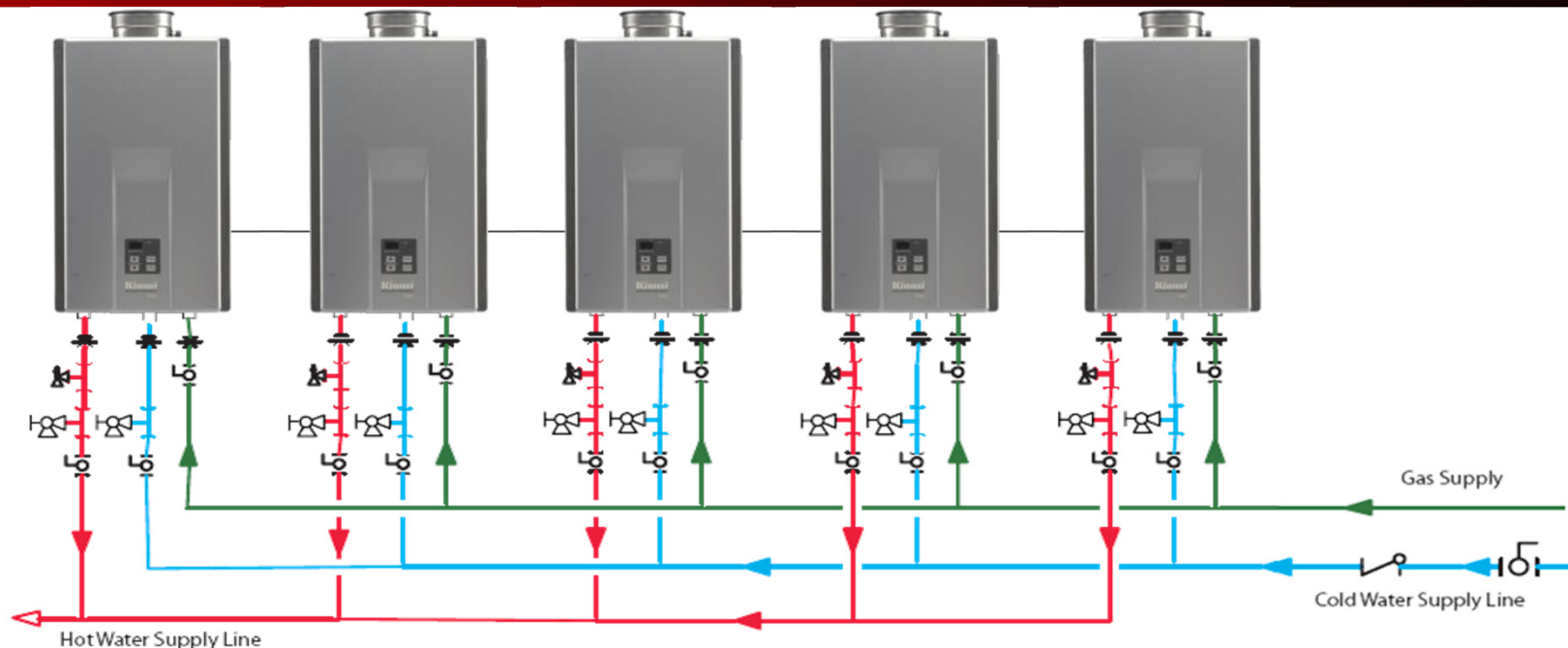

In the example installation shown above, if a multi-unit control system was not utilized, it could take in excess of 2.0 gpm total flow through the system to fire any single unit (5 units multiplied by a 0.4 gpm activation rate).

For Example: If there was a total flow of only 1.5 gpm, this flow rate would be divided evenly among all five water heaters (assuming the plumbing was equal for each unit). Since each water heater would have its water flow servo valve open, the flow through each unit would be 0.3 gpm. This is below the minimum activation flow rate so the water heaters would not fire ($1.5 \text{ gpm} \div 5 \text{ units} = 0.3 \text{ gpm}$).

The solution to this issue is to use Rinnai's MSB or EZ-Connect technology.

This technology allows multiple water heaters to communicate with each other operating only the number of water heaters necessary to satisfy the water flow demands.

Rinnai's MSB technology:

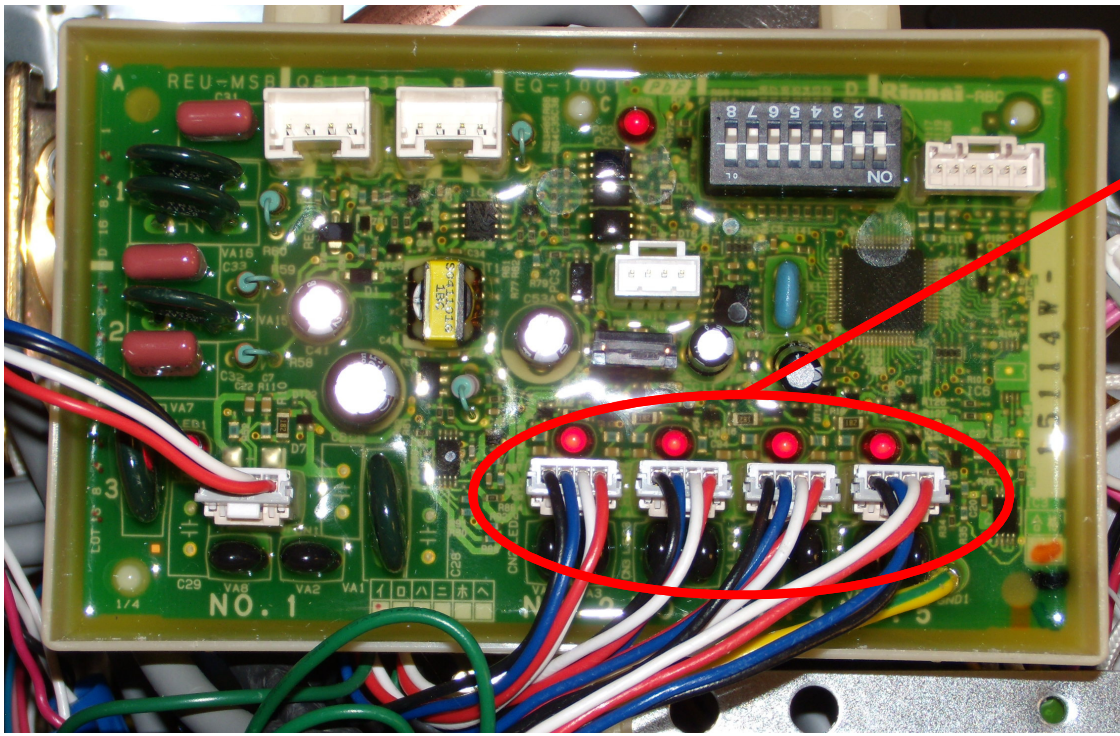

Cables linking the MSB to other water heaters.



This picture illustrates how a MSB board will be installed in a VC series indoor water heater.

The main component of Rinnai's MSB technology is the MSB circuit board. This board can be used to link up to 5 water heaters. The board is mounted inside one water heater and is connected to other units by a wire harness. The basic MSB-M kit contains all parts needed to link two water heaters. Additional wire harnesses will be needed for additional water heaters.



Rinnai's MSB technology:

Each MSB board will connect up to 5 water heaters. Additionally up to 5 MSB boards can be connected together—allowing as many as 25 water heaters to operate as a single system.

Also, dip switches on the MSB board will allow the installer to select how many units are in standby (with their water control valves open and ready to fire) allowing further system customization to meet particular system demands.

Depending on which model water heater is used, an MSB system could have an operating range from as low as 10,000 Btu to as great as 5.9 million Btu. Or, in terms of flow rate: from 0.4 gpm to 245 gpm.

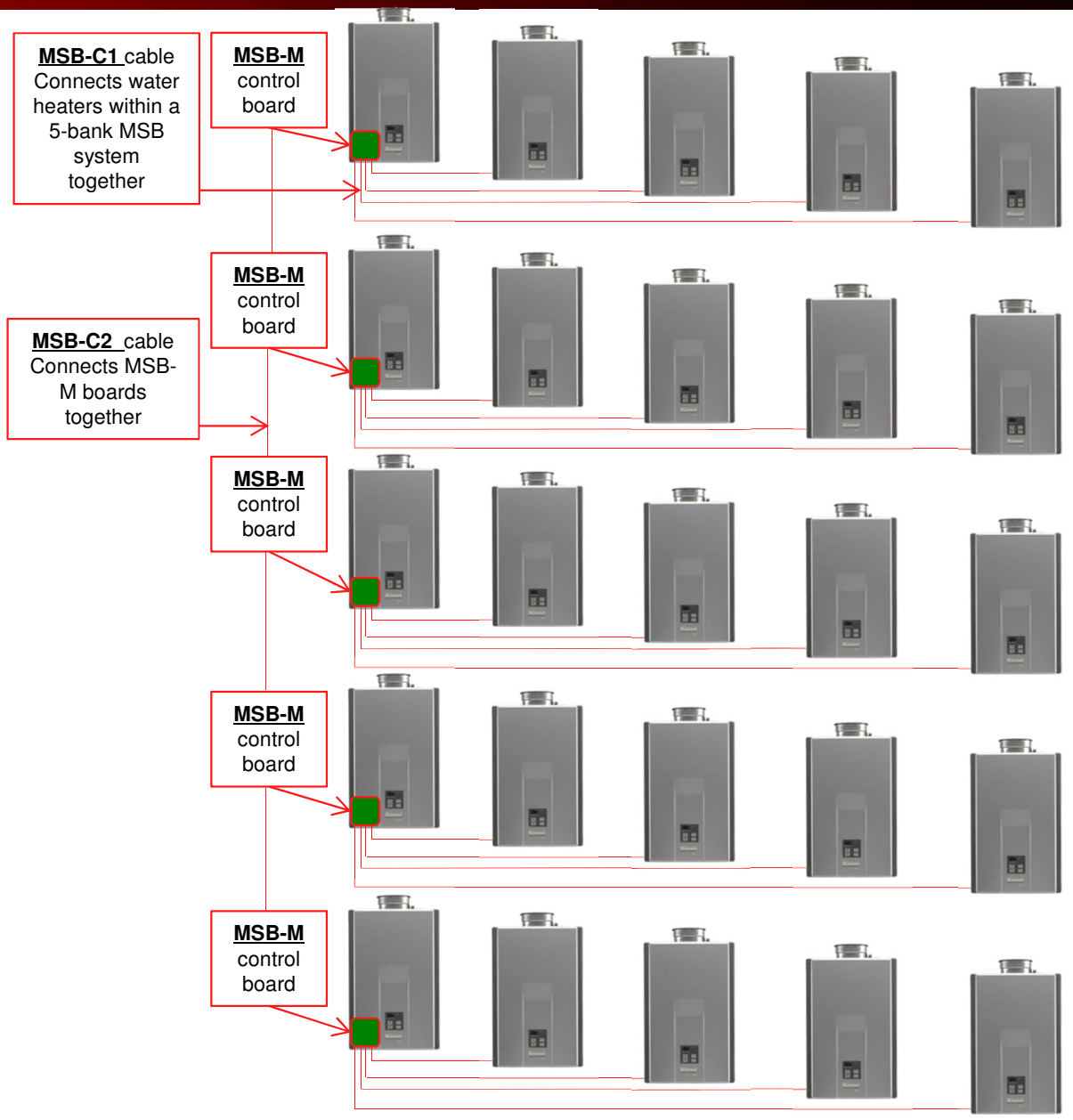

EZConnect® – Connecting (only) two water heaters:

When connecting only two water heaters, an MSB board is not necessary. An EZConnect cable can be used. It connects to a special harness on the primary water heater and to the PCB on the secondary unit (see pictures). Three or more water heaters will require the use of an MSB system.

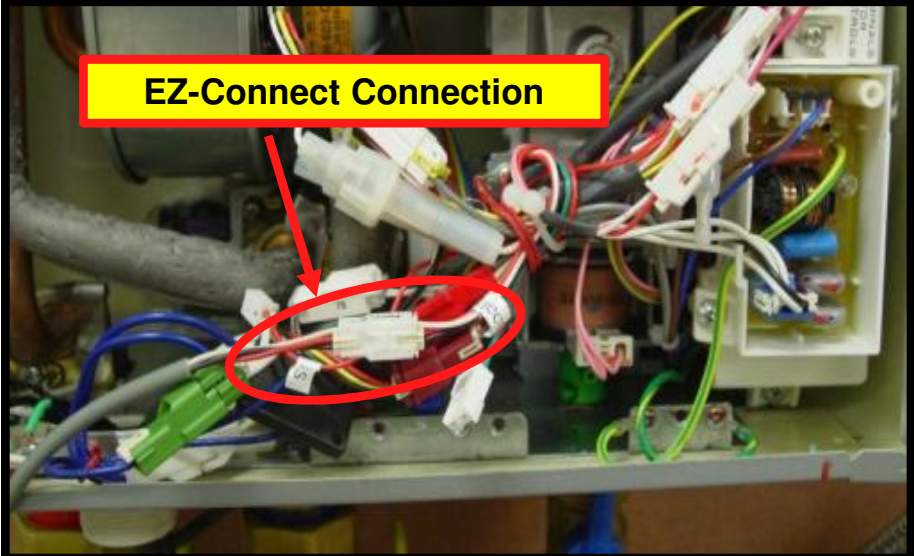

For VB, VC, KA or KB series units: Dip Switch 5 in the SW2 bank of 6 (white switches) will control whether one or both units are ready to fire when in standby:

Dip Sw 5 ON	1 unit in standby (allow for quicker activation for flow rates within the capacity of a single unit)
Dip Sw 5 OFF (default)	Both units in standby (allows for quicker delivery temperature for higher flow rates requiring both units)

NOTE: This Dip Switch will not affect systems operating with an MSA / MSB board

EZConnect standby setting

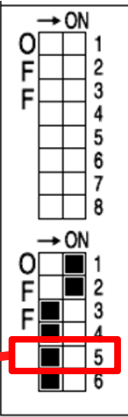

**This concludes the Rinnai
Tankless Water Heater Training Program
Level I - Product Knowledge**

Rinnai[®]