



HOMESTEAD[®]

V A L V E

Lubricated Plug Valves

Price List #10610 • Effective: 06/01/11

Prices for Lubricated Plug Valves, Parts and Accessories.
Weights, Terms and Conditions, Ordering Instructions

160 Walnut Street, Allentown, PA 18102

PHONE: 610-770-1100 FAX: 610-770-1108

e-mail: sales@homesteadvalve.com

www.homesteadvalve.com

© 2011 Olson Technologies, Inc.

110 YEARS of
Dependability

Homestead Lubricated Plug Valves — designed for durability, dependability and economical service.

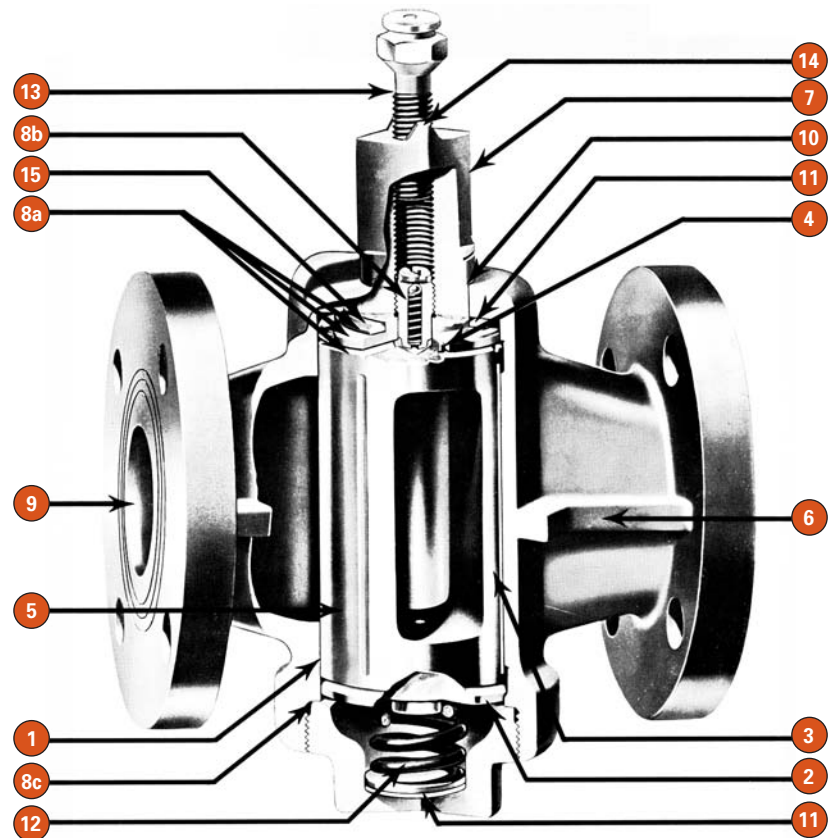

1. **Their design assures extra long valve life.** Clearance between plug and body is so close, and so uniform that the chemical seal easily give the valve many times longer leakless service than any other valves. Even with over 300 pound of lubricant pressure, there is practically no seepage of lubricant into line to contaminate fluids, clog seepage or meters, or ruin rubber diaphragms.
2. **They are positively prevented from sticking** by Homestead's exclusive controlled pressurized lubricant system which moves the plug downward, piston-like, during each lubrication. Spring and line pressure instantly return the plug to stem-sealed position.
3. **Thorough penetration of lubricant to vital surfaces is guaranteed** by the high pressure lubricant system. Chemical seal is forced through lubricant grooves, over all sealing surfaces, and into complete sealing rings around ports. During lubrication, lubricant pressure increases in proportion to the increase of line pressure to insure effective lubrication.
4. **Metering grooves prevent pressure build-up** on top of plug before all lubricant grooves are filled. The high pressure developed within this exclusive orifice-controlled lubricant system guarantees complete coverage of all sealing surfaces — assures added valve life.
5. **Sealing surfaces are protected** in both open and closed positions from the corrosive, abrasive, or erosive effect of line fluids.
6. **They are simple, dependable, and minimize human error.** They require no mechanical adjustments of packing glands, nuts, etc.
7. **They operate quickly.** A quarter-turn of the plug fully opens or closes the valve.
8. **Leakage is prevented to outside of valve by:**
 - (a) a reinforced Teflon® stem seal and two rings of lubricant;
 - (b) a spring loaded ball and lubricant sealed check valve with thread seal; and
 - (c) a positive metal to metal seal at a bonnet. Reinforced Teflon® stem seal resists cold flow.
9. **They give full flow with minimus pressure drop.** Port areas are equal to 100% of the area of standard pipe. Where restricted flow is permissible venturi types are available, and at worthwhile savings in first cost.
10. **They prevent waste of lubricant** by extruding a ring of lubricant around the stem when system is full. This telltale ring of lubricant serves as a stop signal to the man lubricating the valve.
11. **They are comparatively easy to turn,** because the cylindrical plug offers minimum resistance to turning; and it is floated between a low friction reinforced Teflon® ring at top, and a Teflon® disc at bottom.
12. **Less maintenance is assured.** Spring rotates with plug on Teflon® and steel discs. Elimination of torsional stress, and round cross section spring construction which more evenly distributes strain, prevents spring breakage. Spring is subjected only to compression, for which it is designed.
13. **Dirt is prevented from being forced into lubricant system** by practically full threaded combination screw and button head fitting. Clean lubricant is just as important in a valve as in any other machine.
14. **Indicator on top of stem shows position of ports in plug.**
15. **A positive sealing pressure of as much as 500 pounds** (spring pressure plus line pressure) is applied to stem seal.

Teflon® is a registered trademark of Dupont Co.



Listed for figure 601, 602, 611 & 612 valves. Consult factory for sizes listed.



If CSA or UL tag is required, add \$21.00 LIST.

RETURN GOODS

No material may be returned without prior authorization. Materials will not be accepted for return after 12 months from date of shipment. Non-catalog and non-stock catalog items are not returnable.

When properly authorized, credit will be issued on basis of purchase price, less 30% handling and restocking charge, plus any additional reworking charges, minimum return charge is \$75.00. Freight must be prepaid. Authorized returns will be limited to 10% of a given order.

EXPORT BOXING

Is available at 5% of total net order value or \$300.00, whichever is greater. Consult factory for pricing.

Prices shown in this list supercede all previously published prices and are subject to change without notice.

24-Hour shipment of stock items available at additional \$50.00 handling charge.

Dimensions shown in this price list are approximate and for estimating only. Certified engineering drawings are available on request.

Unit List Prices for Lubricated Plug Valves

100% Full Port Valves	5-7
Standard Port Valves	5-7
3-Way & 4-Way	5-7
Round Port & Diamond Port.....	6-7

Accessories List Prices⁽²⁾

C.S.A. tag or U.L. tag ⁽¹⁾	3
Steam Jacket Bonnets.....	7
Valve Stem Adapters.....	8
Adjusting Memory Stops	8
Dial Indicators	8
Parts Features	11

Lubrication Accessories List Prices

Lubrication Features & Specifications	8-9
Lubricating Gun.....	8-9
Lubricant Sticks	9
Bulk Lubricant	9
Lubricant Fittings	9

Wrenches & Locking Devices List Prices⁽²⁾

Wrenches.....	10-11
Wrenches & Locking Device Features	10-11
Wrench Locking Devices	10
Locking & Sealing Devices	10
T-Handle Socket Wrenches.....	11
Double ended Wrenches.....	11
Tapping for By-pass Connections ⁽¹⁾	11

Extensions & Floor Stand List Prices⁽²⁾

Extensions & Floor Stand Features	12
High Head & Low Head Extensions.....	12
Floor Stands.....	12

**Lubricated Plug Valve Part Positions
With Ordering Information.....** 13

How to Specify Lubricated Plug Valves 14

**Lubricated Plug Valve
Specifications & Definitions.....** 14

Terms & Conditions..... Inside Back Cover

Lubricated Plug Valve Features Inside Front Cover

(1) Must Be Ordered at Time of Unit Purchase
(2) Add to Unit List Price



LUBRICATED PLUG VALVES

These are but a few of the many advantages of Homestead's controlled pressurized lubrication that guarantee lowest cost valve service.

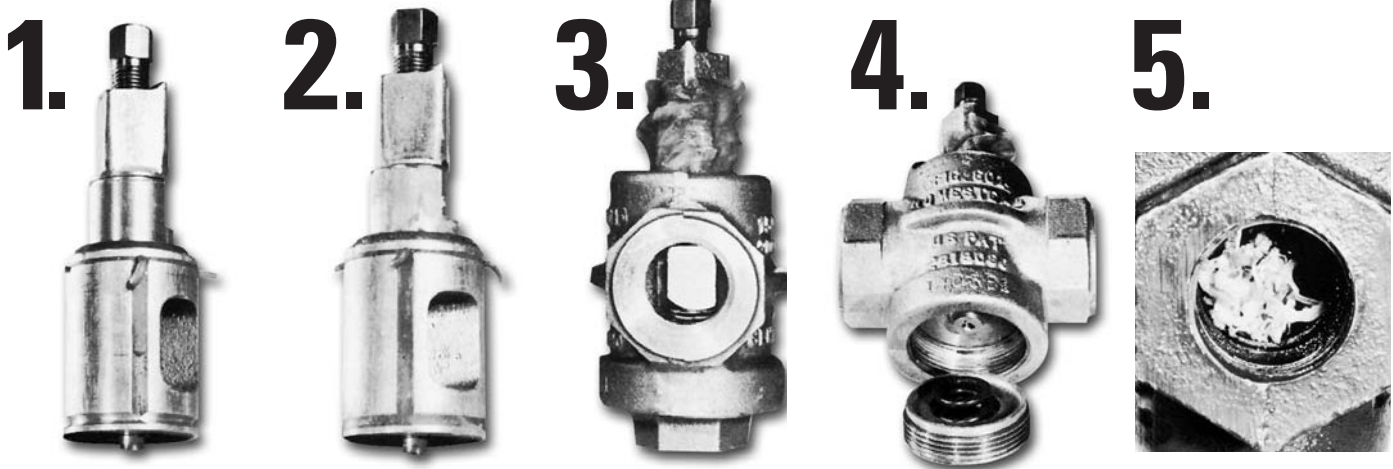

1. This plug was removed from a Homestead Valve just after starting lubrication, and before all sealing areas were filled with lubricant. Note that pressurized lubricant continues to extrude through feeder holes. Momentary downward movement of plug at start of each lubrication, gives assurance that plug is always free to turn.

2. The plug was again withdrawn from the valve body just after a ring of lubricant around the stem indicated that the system was full. Note that all lubricant grooves are filled. The entire plug surface is coated with lubricant. Lubricant is well packed into the stem sealing area above the plug.

3. Now valve has been purposely over-lubricated as indicated by excess lubricant around stem. Note that with controlled pressurized lubrication there is no extrusion or seepage of lubricant into valve port opening. This means no waste, no contamination of line fluids, no clogging of low pressure lines with lubricant, or fouling of meters, orifices, etc.

4. Also, in the Homestead Valve with controlled lubrication, you will note that even though the valve has been over-lubricated, lubricant comes only to the bottom edge of the plug, and is not wasted by discharging in quantity into the bottom chamber.

5. See for yourself the risk involved when a valve which does not have Homestead's controlled pressurized lubrication is over-lubricated.

NOTE: Lubricant has been forced into the port opening. It can contaminate line fluids, foul meters or orifices, or even block low pressure lines!

* Unretouched Photos. In some instances pictures shown do not represent the lubrication fitting currently being sold.

FIGURE NO.	Size (inches)	Valve List Price (In U.S. \$)	Valve Wt. (lbs.)	Wrench	Wrench List Price (In U.S. \$)	Wrench Wt. (lbs.)	Sealant Stick Size
601 200lb. WOG 100% Pipe Area Cast Iron Screwed Wrench Operated If CSA or UL is required, see page 3	1/2	120	4 1/4	F	18	6 1/4oz.	B
	3/4	120	4 1/4	F	18	6 1/4oz.	B
	1	153	5 1/2	G	24	7 3/4oz.	B
	1 1/4	182	9	G	24	7 3/4oz.	B
	1 1/2	196	9 3/4	G	24	7 3/4oz.	B
601-SJ 200lb. WOG 100% Pipe Area Cast Iron Steam Jacketed Bonnet Wrench Operated	2	233	17	E	35	13 1/4oz.	C
	2 1/2	358	23 1/2	E	35	13 1/4oz.	C
	3	440	40	L	48	1lb. 3oz.	C
	4	656	73	N*	85	1lb. 8oz.	C
	1/2	373	5	F	18	6 1/4oz.	B
601-FMA FM Approved Gas Supervisory Cock 50PSI Max. 100% Pipe Area Cast Iron Screwed Wrench Included	3/4	373	5	F	18	6 1/4oz.	B
	1	454	6 1/2	G	24	7 3/4oz.	B
	1 1/4	483	10 1/2	G	24	7 3/4oz.	B
	1 1/2	500	10 1/2	G	24	7 3/4oz.	B
	2	613	19 1/2	E	35	13 1/4oz.	C
602 200lb. WOG 100% Pipe Area Cast Iron Flanged Wrench Operated If CSA or UL is required, see page 3	2 1/2	846	27 1/4	E	35	13 1/4oz.	C
	3	915	44	L	48	1lb. 3oz.	C
	4	1,206	80	N*	85	1lb. 8oz.	C
	1/2	311	4 1/2	-	-	-	B
	3/4	323	4 1/2	-	-	-	B
602-A 200lb. WOG 100% Pipe Area Cast Iron Flanged Wrench Operated	1	339	6	-	-	-	B
	1 1/4	511	9 1/2	-	-	-	B
	1 1/2	557	10 1/4	-	-	-	B
	2	654	18	-	-	-	C
	2 1/2	872	41	-	-	-	C
602-G 200lb. WOG 100% Pipe Area Gear Operated Flanged	3	1,065	74	-	-	-	C
	1	191	8 1/2	G	24	7 3/4oz.	B
	1 1/4	226	14	G	24	7 3/4oz.	B
	1 1/2	246	14 1/2	G	24	7 3/4oz.	B
	2	289	23	E	35	13 1/4oz.	C
602-SJ 200lb. WOG 100% Pipe Area Cast Iron Flanged Wrench Operated	2 1/2	415	34	E	35	13 3/4oz.	C
	3	502	47	L	48	1lb. 3oz.	C
	4	628	80	N*	85	1lb. 8oz.	C
	5	1,668	118	N*	85	1lb. 8oz.	C
	6	2,097	145	N*	85	1lb. 8oz.	C
603 200lb. WOG 3-Way Screwed 100% Pipe Area Cast Iron 2 Port Plug Wrench Operated	4	1,440	-	N*	85	1lb. 8oz.	C
	5	2,179	155	N*	85	1lb. 8oz.	C
	6	2,654	183	N*	85	1lb. 8oz.	C
	8	3,688	305	P*	134	7 1/2lb.	D
	10†	8,572	525	P*	134	7 1/2lb.	D
603-SJ 200lb. WOG 100% Pipe Area Cast Iron Steam Jacketed Wrench Operated	12†	9,141	600	P*	134	7 1/2lb.	D
	4	1,693	123	-	-	-	C
	5	2,998	218	-	-	-	C
	6	3,309	245	-	-	-	C
	8	4,802	349	-	-	-	D
603-SJ 200lb. WOG 100% Pipe Area Cast Iron Jacketed Wrench Operated	10†	9,759	644	-	-	-	D
	12†	12,191	708	-	-	-	D
	1	519	9	G	24	7 3/4oz.	B
	1 1/4	547	14 1/2	G	24	7 3/4oz.	B
	1 1/2	558	15	G	24	7 3/4oz.	B
603-SJ 200lb. WOG 100% Pipe Area Cast Iron Jacketed Wrench Operated	2	647	24	E	35	13 1/4oz.	C
	2 1/2	842	35	E	35	13 1/4oz.	C
	3	976	51	L	48	1lb. 3oz.	C
	4	1,177	83	N*	85	1lb. 8oz.	C
	5	2,425	130	N*	85	1lb. 8oz.	C
603-SJ 200lb. WOG 100% Pipe Area Cast Iron Jacketed Wrench Operated	6	2,999	154	N*	85	1lb. 8oz.	C
	8	4,355	315	P	134	7 1/2lb.	D
	1/2	265	4	F	18	6 1/4oz.	B
	3/4	270	8	G	24	7 3/4oz.	B
	1	344	8	G	24	7 3/4oz.	B
603-SJ 200lb. WOG 100% Pipe Area Cast Iron 2 Port Plug Wrench Operated	1 1/4	437	15	G	24	7 3/4oz.	B
	1 1/2	472	15	G	24	7 3/4oz.	B
	2	587	24 1/4	E	35	13 1/4oz.	C
	2 1/2	822	38	E	35	13 1/4oz.	C
	3	1,533	68	N*	85	1lb. 8oz.	C
603-SJ 200lb. WOG 100% Pipe Area Cast Iron 2 Port Plug Wrench Operated	4	2,481	112	N*	85	1lb. 8oz.	C

FIGURE NO.	Size (inches)	Valve List Price (In U.S. \$)	Valve Wt. (lbs.)	Wrench	Wrench List Price (In U.S. \$)	Wrench Wt. (lbs.)	Sealant Stick Size
603-SJ 200lb. WOG 3-Way Screwed 100% Pipe Area Cast Iron 2 Port Plug Steam Jacketed Bonnet Wrench Operated	1/2	498	4 1/2	F	18	6 1/4oz.	B
	3/4	522	9	G	24	7 3/4oz.	B
	1	645	9	G	24	7 3/4oz.	B
	1 1/4	752	15 1/4	G	24	7 3/4oz.	B
	1 1/2	781	15 3/4	G	24	7 3/4oz.	B
604 200lb. WOG 3-Way Flanged 100% Pipe Area Cast Iron 2 Port Plug Wrench Operated	2	945	27	E	35	13 1/4oz.	C
	2 1/2	1,286	39 3/4	E	35	13 1/4oz.	C
	3	2,070	73	N*	85	1lb. 8oz.	C
	4	3,212	119	N*	85	1lb. 8oz.	C
	1 1/2	613	23	G	24	7 3/4oz.	B
604-G 200lb. WOG 3-Way Flanged 100% Pipe Area Cast Iron 2 Port Plug Gear Operated	2	769	36	E	35	13 1/4oz.	C
	2 1/2	1,016	52	E	35	13 1/4oz.	C
	3	1,722	79	N*	85	1lb. 8oz.	C
	4	2,630	148	N*	85	1lb. 8oz.	C
	5	3,979	248	N*	85	1lb. 8oz.	C
604-SJ 200lb. WOG 3-Way Flanged 100% Pipe Area Cast Iron 2 Port Plug Steam Jacketed Wrench Operated	6	5,137	356	P*	134	7 1/2lb.	C
	8	8,974	515	P*	134	7 1/2lb.	D
	4	3,796	275	-	-	-	C
	6	6,918	470	-	-	-	C
	8	14,536	665	-	-	-	D
605 200lb. WOG 3-Way Screwed 100% Pipe Area Cast Iron 3 Port Plug Wrench Operated	1 1/2	951	23 3/4	G	24	7-3/4 oz.	B
	2	1,144	37	E	35	13 1/4oz.	C
	2 1/2	1,474	53	E	35	13 1/4oz.	C
	3	2,270	83	N*	85	1lb. 8oz.	C
	4	3,352	151	N*	85	1lb. 8oz.	C
605-SJ 200lb. WOG 3-Way Screwed 100% Pipe Area Cast Iron 3 Port Plug Wrench Operated	5	4,188	253	N*	85	1lb. 8oz.	C
	6	5,407	430	P*	134	7 1/2lb.	C
	8	9,801	590	P*	134	7 1/2lb.	D
	1/2	265	4	F	18	6 1/4oz.	B
	3/4	270	8	G	24	7 3/4oz.	B
605-SJ 200lb. WOG 3-Way Screwed 100% Pipe Area Cast Iron 3 Port Plug Wrench Operated	1	344	8	G	24	7 3/4oz.	B
	1 1/4	437	15	G	24	7 3/4oz.	B
	1 1/2	472	15	G	24	7 3/4oz.	B
	2	587	24 1/2	E	35	13 1/4oz.	C
	2 1/2	822	38	E	35	13 1/4oz.	C
605-SJ 200lb. WOG 3-Way Screwed 100% Pipe Area Cast Iron 3 Port Plug Wrench Operated	3	1,533	68	N*	85	1lb. 8oz.	C
	4	2,481	112	N*	85	1lb. 8oz.	C
	1/2	498	4 1/2	F	18	6 1/4oz.	B
	3/4	522	9	G	24	7 3/4oz.	B
	1	645	9	G	24	7 3/4oz.	B
606 200lb. WOG 3-Way Flanged 100% Pipe Area Cast Iron 3 Port Plug Wrench Operated	1 1/4	752	15 1/4	G	24	7 3/4oz.	B
	1 1/2	781	15 3/4	G	24	7 3/4oz.	B
	2	945	27	E	35	13 1/4oz.	C
	2 1/2	1,286	39 3/4	E	35	13 1/4oz.	C
	3	2,070	73	N*	85	1lb. 8oz.	C
606-G 200lb. WOG 3-Way Flanged 100% Pipe Area Cast Iron 3 Port Plug Gear Operated	4	3,212	119	N*	85	1lb. 8oz.	C
	1 1/2	613	23	G	24	7 3/4oz.	B
	2	769	36	E	35	13 1/4oz.	C
	2 1/2	1,016	52	E	35	13 1/4oz.	C
	3	1,722	79	N*	85	1lb. 8oz.	C
606-G 200lb. WOG 3-Way Flanged 100% Pipe Area Cast Iron 3 Port Plug Gear Operated	4	2,630	148	N*	85	1lb. 8oz.	C
	5	3,979	248	N*	85	1lb. 8oz.	C
	6	5,137	356	P*	134	7 1/2lb.	C
	8	8,974	515	P*	134	7 1/2lb.	D
	4	3,796	275	-	-	-	D
606-G 200lb. WOG 3-Way Flanged 100% Pipe Area Cast Iron 3 Port Plug Gear Operated	5	5,330	362	-	-	-	D
	6	6,918	470	-	-	-	D
	8	14,536	665	-	-	-	D

* Wrench head only; handle extra at \$11.00 LIST per foot, or fraction. † Standard opening. 3-WAY & 4-WAY SEE PAGE 13 FOR PORT POSITIONS

FIGURE NO.	Size (inches)	Valve List Price (In U.S. \$)	Valve Wt. (lbs.)	Wrench	Wrench List Price (In U.S. \$)	Wrench Wt. (lbs.)	Sealant Stick Size	
606-SJ	1 1/2	951	23 3/4	G	24	7 1/4oz.	B	
200lb. WOG 3-Way Flanged 100% Pipe Area Cast Iron 3 Port Plug Steam Jacketed Wrench Operated	2	1,144	37	E	35	13 1/4oz.	C	
	2 1/2	1,474	53	E	35	13 1/4oz.	C	
	3	2,270	83	N*	85	1lb. 8oz.	C	
	4	3,352	151	N*	85	1lb. 8oz.	C	
	5	4,188	253	N*	85	1lb. 8oz.	C	
	6	5,407	430	P*	134	7 1/2lb.	C	
	8	9,801	590	P*	134	7 1/2lb.	D	
607	1/2	290	4	F	18	6 1/4oz.	B	
200lb. WOG Cast Iron Standard Opening 4-Way Screwed Wrench Operated	3/4	304	8	G	24	7 3/4oz.	B	
	1	386	8 1/4	G	24	7 3/4oz.	B	
	1 1/4	495	16	G	24	7 3/4oz.	B	
	1 1/2	526	16 1/2	G	24	7 3/4oz.	B	
	2	675	26	E	35	13 1/4oz.	C	
	2 1/2	968	40	E	35	13 1/4oz.	C	
	3	1,834	68	N*	85	1lb. 8oz.	C	
	4	2,868	122	N*	85	1lb. 8oz.	C	
	607-SJ	1/2	570	4 1/4	F	18	6 1/4oz.	B
	200lb. WOG Cast Iron Standard Opening 4-Way Steam Jacketed Screwed Wrench Operated	3/4	592	8 1/4	G	24	7 3/4oz.	B
1		733	9 1/4	G	24	7 3/4oz.	B	
1 1/4		846	16 1/4	G	24	7 3/4oz.	B	
1 1/2		891	16 3/4	G	24	7 3/4oz.	B	
2		1,139	28 1/2	E	35	13 1/4oz.	C	
2 1/2		1,471	41 3/4	E	35	13 1/4oz.	C	
3		2,408	68	N*	85	1lb. 8oz.	C	
4		3,785	129	N*	85	1lb. 8oz.	C	
608	1 1/2	705	36	G	24	7 3/4oz.	B	
200lb. WOG Cast Iron Standard Opening 4-Way Flanged Wrench Operated	2	859	42	E	35	13 1/4oz.	C	
	2 1/2	1,170	62	E	35	13 1/4oz.	C	
	3	2,044	89	N*	85	1lb. 8oz.	C	
	4	3,114	160	N*	85	1lb. 8oz.	C	
	6	5,887	410	P*	134	7 1/2lb.	C	
	8	10,756	RTF	P*	134	7 1/2lb.	C	
608-SJ	1 1/2	1,080	37	G	24	7 3/4oz.	B	
200lb. WOG Cast Iron Standard Opening 4-Way Steam Jacketed Flanged Wrench Operated	2	1,311	43	E	35	13 1/4oz.	C	
	2 1/2	1,717	65	E	35	13 1/4oz.	C	
	3	2,683	93	N*	85	1lb. 8oz.	C	
	4	4,023	163	N*	85	1lb. 8oz.	C	
	6	6,029	413	P*	134	7 1/2lb.	C	
	8	11,920	RTF	P*	134	7 1/2lb.	C	
	611	1	116	4 1/2	F	18	6 1/4oz.	B
	200lb. WOG Cast Iron Standard Opening Screwed Wrench Operated	1 1/4	127	7 1/4	G	24	7 3/4oz.	B
1 1/2		127	7 1/4	G	24	7 3/4oz.	B	
2		122	13 1/4	G	24	7 3/4oz.	B	
2 1/2		194	19 1/2	E	35	13 1/4oz.	C	
3		218	33 3/4	E	35	13 1/4oz.	C	
4		294	58 1/2	L	48	1lb. 3oz.	C	
611SJ		1	418	5 1/2	F	18	6 1/4oz.	B
200lb. WOG Cast Iron Standard Opening Screwed Steam Jacketed Wrench Operated	1 1/4	429	7 1/2	G	24	7 3/4oz.	B	
	1 1/2	429	8	G	24	7 3/4oz.	B	
	2	429	15 3/4	G	24	7 3/4oz.	B	
	2 1/2	507	21 1/4	E	35	13 1/4oz.	C	
	3	661	33 3/4	E	35	13 1/4oz.	C	
	4	779	65 1/2	L	48	1lb. 3oz.	C	
	612	1	150	7 1/2	F	18	6 1/4oz.	B
200lb. WOG Cast Iron Standard Opening Flanged Wrench Operated	1 1/4	164	10 1/2	G	24	7 3/4oz.	B	
	1 1/2	171	10 1/2	G	24	7 3/4oz.	B	
	2	182	19	G	24	7 3/4oz.	B	
	2 1/2	239	29 1/2	E	35	13 1/4oz.	C	
	3	299	39	E	35	13 1/4oz.	C	
	4	407	61 1/2	L	48	1lb. 3oz.	C	
	5	832	88	N*	85	1lb. 8oz.	C	
	6	1,037	100	N*	85	1lb. 8oz.	C	
8	1,872	172	N*	85	1lb. 8oz.	C		

* Wrench head only; handle extra at \$11.00 LIST per foot, or fraction.
 † Standard opening. 3-WAY & 4-WAY SEE PAGE 13 FOR PORT POSITIONS

FIGURE NO.	Size (inches)	Valve List Price (In U.S. \$)	Valve Wt. (lbs.)	Wrench	Wrench List Price (In U.S. \$)	Wrench Wt. (lbs.)	Sealant Stick Size	
612-A	6	2,026	125	N*	85	1lb. 8oz.	C	
200lb. WOG Cast Iron Standard Opening Flanged Wrench Operated	8	2,105	195	N*	85	1lb. 8oz.	C	
	10	3,256	305	N*	85	1lb. 8oz.	C	
	12	6,261	475	P*	134	7 1/2lb.	D	
	14	10,627	RTF	P*	134	7 1/2lb.	D	
	612-G	6	2,415	143	-	-	-	C
200lb. WOG Cast Iron Standard Opening Flanged Gear Operated	8	3,224	280	-	-	-	D	
	10	4,901	370	-	-	-	D	
	12	7,109	550	-	-	-	D	
	14	10,626	1090	-	-	-	D	
	16	17,585	1321	-	-	-	D	
	18	21,699	1610	-	-	-	D	
	20	27,787	2165	-	-	-	D	
	24	37,166	2810	-	-	-	D	
	612-SJ	1	452	8	F	18	6 1/4oz.	B
	200lb. WOG Cast Iron Standard Opening Flanged Steam Jacketed Wrench Operated	1 1/4	471	11	G	24	7 3/4oz.	B
1 1/2		479	11 1/4	G	24	7 3/4oz.	B	
2		485	20	G	24	7 3/4oz.	B	
2 1/2		553	30 1/2	E	35	13 1/4oz.	C	
3		746	43	E	35	13 1/4oz.	C	
4		879	64 1/2	L	48	1lb. 3oz.	C	
5		1,372	92	N*	85	1lb. 8oz.	C	
6		1,561	109	N*	85	1lb. 8oz.	C	
8		2,602	180	N*	85	1lb. 8oz.	C	
622		2	374	23	E	35	13 1/4oz.	C
200lb. WOG 100% Pipe Area Cast Iron Flanged Wrench Operated	2 1/2	462	34	E	35	13 1/4oz.	C	
	3	612	47	L	48	1lb. 3oz.	C	
	4	1,104	80	N*	85	1lb. 8oz.	C	
	5	2,253	135	N*	85	1lb. 8oz.	C	
	6	2,381	164	N*	85	1lb. 8oz.	C	
	622-A	6	2,508	205	N*	85	1lb. 8oz.	C
200lb. WOG 100% Pipe Area Cast Iron Flanged Wrench Operated	8	4,017	405	P*	134	7 1/2lb.	D	
	10	7,864	655	P*	134	7 1/2lb.	D	
	622-G	6	3,777	260	-	-	-	C
200lb. WOG 100% Pipe Area Cast Iron Flanged Gear Operated	8	5,059	490	-	-	-	D	
	10	10,615	871	-	-	-	D	
	12†	15,282	1076	-	-	-	D	
	641	1/2	159	4 1/2	F	18	6 1/4oz.	B
200lb. WOG Cast Iron Diamond Port Screwed Wrench Operated	3/4	159	4 1/2	F	18	6 1/4oz.	B	
	1	186	6	G	24	7 3/4oz.	B	
	1 1/4	223	10	G	24	7 3/4oz.	B	
	1 1/2	238	10	G	24	7 3/4oz.	B	
	2	284	18 1/2	E	35	13 1/4oz.	C	
	2 1/2	440	26 3/4	E	35	13 1/4oz.	C	
	3	536	43	L	48	1lb. 3oz.	C	
	4	761	75	N*	85	1lb. 8oz.	C	
	642	1	223	8	G	24	7 3/4oz.	B
	200lb. WOG Cast Iron Diamond Port Flanged Wrench Operated	1 1/4	270	11	G	24	7 3/4oz.	B
1 1/2		284	14 1/2	G	24	7 3/4oz.	B	
2		328	23 1/2	E	35	13 1/4oz.	C	
2 1/2		491	36 3/4	E	35	13 1/4oz.	C	
3		598	50	L	48	1lb. 3oz.	C	
4		781	85	N*	85	1lb. 8oz.	C	
5		1,728	132	N*	85	1lb. 8oz.	C	
6	2,604	168	N*	85	1lb. 8oz.	C		

LUBRICATED PLUG VALVE – LIST PRICES

VALVES & ACCESSORIES

FIGURE NO.	Size (inches)	Valve List Price (In U.S \$)	Valve Wt. (lbs.)	Wrench	Wrench List Price (In U.S \$)	Wrench Wt. (lbs.)	Sealant Stick Size
642-A 200lb. WOG Cast Iron Diamond Port Flanged Wrench Operated	6	3,399	195	P*	134	1lb. 8oz.	C
	8	4,026	275	P*	134	7 ¹ / ₂ lb.	D
	10	8,171	410	P*	134	7 ¹ / ₂ lb.	D
642-G 200lb. WOG Cast Iron Diamond Port Flanged Gear Operated	6	4,628	320	–	–	–	C
	8	5,871	405	–	–	–	D
	10	9,505	590	–	–	–	D
651 200lb. WOG Round Port 100% Pipe Area Cast Iron Screwed Wrench Operated	1/2	177	5	F	18	6 ¹ / ₄ oz.	B
	3/4	177	8	G	24	7 ³ / ₄ oz.	B
	1	198	8	G	24	7 ³ / ₄ oz.	B
	1 1/4	270	10	G	24	7 ³ / ₄ oz.	B
	1 1/2	285	15	G	24	7 ³ / ₄ oz.	B
	2	347	27	L	48	1 lb. 3oz.	C
	2 1/2	460	42	L	48	1 lb. 8oz.	C
651-SJ 200lb. WOG Round Port Steam Jacketed 100% Pipe Area Cast Iron Screwed Wrench Operated	1/2	392	5 1/4	F	18	6 1/4oz.	B
	3/4	392	8 1/4	G	24	7 3/4oz.	B
	1	482	9	G	24	7 3/4oz.	B
	1 1/4	686	10 3/4	G	24	7 3/4oz.	B
	1 1/2	699	15 3/4	G	24	7 3/4oz.	B
	2	760	29 1/2	L	48	1 lb. 3oz.	C
	2 1/2	894	43 3/4	L	48	1 lb. 3oz.	C
652 200lb. WOG Round Port 100% Pipe Area Cast Iron Flanged Wrench Operated	3	946	170	P*	134	7 1/2lb.	D
	1	275	10 1/4	G	24	7 3/4oz.	B
	1 1/4	301	14 1/2	G	24	7 3/4oz.	B
	1 1/2	331	20	G	24	7 3/4oz.	B
	2	390	33	L	48	1 lb. 3oz.	C
652-A 200lb. WOG Round Port 100% Pipe Area Cast Iron Flanged Wrench Operated	2 1/2	534	51	L	48	1 lb. 3oz.	C
	3	630	70	N*	85	1 lb. 8oz.	C
	4	1,324	152	P*	134	7 1/2lb.	D
	4	2,271	182	P*	134	7 1/2lb.	D
652-G 200lb. WOG Round Port 100% Pipe Area Cast Iron Flanged Wrench Operated	6	5,024	372	P*	134	7 1/2lb.	D
	8	9,277	815	P*	134	7 1/2lb.	D
	10	16,638	1146	P*	134	7 1/2lb.	D
	4	2,972	241	–	–	–	D
652-G 200lb. WOG Round Port 100% Pipe Area Cast Iron Flanged Gear Operated	6	7,230	459	–	–	–	D
	8	11,430	969	–	–	–	D
	10	17,125	1321	–	–	–	D
	12	23,328	1620	–	–	–	D
	652-SJ 200lb. WOG Round Port Steam Jacketed 100% Pipe Area Cast Iron Flanged Wrench Operated	1	545	10 3/4	G	24	7 3/4oz.
1 1/4		674	15	G	24	7 3/4oz.	B
1 1/2		704	20 3/4	G	24	7 3/4oz.	B
2		800	34	L	48	1 lb. 3oz.	C
2 1/2		971	52	L	48	1 lb. 3oz.	C
3	1,066	74	N*	85	1 lb. 8oz.	C	

FIGURE NO.	Size (inches)	Valve List Price (In U.S \$)	Valve Wt. (lbs.)	Wrench	Wrench List Price (In U.S \$)	Wrench Wt. (lbs.)	Sealant Stick Size
686 200lb. WOG 3-Way Flanged Standard Opening Cast Iron 2 Port Plug Wrench Operated	6	5,259	RTF	P*	134	7 1/2lb.	C
	8	7,811	RTF	P*	134	7 1/2lb.	C
688 200lb. WOG 3-Way Flanged Standard Opening Cast Iron 3 Port Plug Wrench Operated	6	5,259	RTF	P*	134	7 1/2lb.	C
	8	7,811	RTF	P*	134	7 1/2lb.	C
711 500lb. WOG Cast Iron Standard Opening Screwed Wrench Operated	1	199	RTF	F	18	6 1/4oz.	B
	1 1/4	258	RTF	G	24	7 3/4oz.	B
	1 1/2	283	RTF	G	24	7 3/4oz.	B
	2	330	RTF	G	24	7 3/4oz.	B
	2 1/2	504	RTF	E	35	13 1/4oz.	C
702 500lb. WOG Cast Iron 100% Pipe Area Flanged Wrench Operated	3	571	RTF	E	35	13 1/4oz.	C
	4	767	RTF	L	48	1lb. 3oz.	C
	2 1/2	632	57	E	35	13 1/4oz.	C
	3	829	77	L	48	1lb. 3oz.	C
	4	1,118	120	N*	85	1lb. 8oz.	C
712 500lb. WOG Standard Opening Cast Iron Flanged Wrench Operated	5	1,880	175	N*	85	1lb. 8oz.	C
	6	2,042	185	N*	85	1lb. 8oz.	C
712-G 500lb. WOG Standard Opening Cast Iron Flanged Gear Operated	8	2,877	255	N*	85	1lb. 8oz.	C
	6	4,306	225	–	–	–	C
712-G 500lb. WOG Standard Opening Cast Iron Flanged Gear Operated	8	4,851	295	–	–	–	D
	10	10,522	405	–	–	–	D
	12	13,298	675	–	–	–	D
	14	22,833	1600	–	–	–	D
	16	24,724	RTF	–	–	–	D
	18	32,077	RTF	–	–	–	D

STEAM JACKET BONNETS

Size (inches)	List Price
1/2, 3/4	312
1	432
1 1/4	515
1 1/2	545
2	609
2 1/2	635
3	668
4	926
5, 6, 8	1170

*Wrench head only; handle extra at \$11.00 LIST per foot, or fraction.

† Standard opening. 3-WAY & 4-WAY SEE PAGE 13 FOR PORT POSITIONS

VALVE STEM ADAPTERS to convert stem to 2" square

Part #	100% Pipe Area	Standard Opening	Round Port	Diameter Port	3-Way	List Price
1500-F	1/2", 3/4"	1"	1/2"	1/2", 3/4"	1/2"	29
1500-E	1" to 1 1/2"	1 1/4" to 2"	3/4" to 1 1/2"	1" to 1 1/2"	3/4", 1 1/2"	29
1500-C	2", 2 1/2"	2 1/2", 3"	–	2", 2 1/2"	2", 2 1/2"	43
1500-B	3"	4"	2", 2 1/2"	3"	–	43
Adapter to reduce stem to 2"						176

Adjustable Memory Stops

Dial Indicators

Valve Size	List Price	List Price
1/2", 3/4"	83	39
1" – 1 1/4"	86	50
1 1/2"	102	50
2" – 2 1/2"	107	73
3" – 4"	150	76
5"	187	102
6"	191	107
8"	246	235
10"	550	325

LUBRICATION ACCESSORIES

Type "A" Hypressure Lubricant Gun

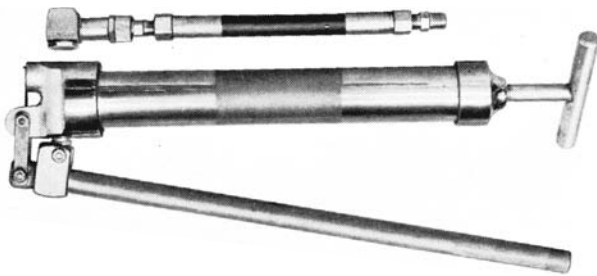

For use with either stick or bulk lubricant. It is fed by turning threaded plunger. Weight 11lb., 4oz. Use size "J" (1-3/8 x 8-3/4") stick sealant.

Type "B" Hypressure Lubricant Gun

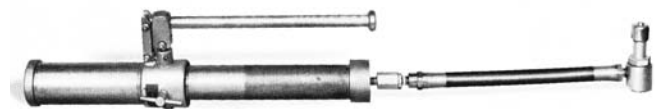

For use with either stick or bulk lubricant. Pressure is built up hydraulically. Built-in safety features protect the gun and the valve being lubricated from possible excess pressure. Loads quickly and cleanly without the use of wrenches and tools. To load, by-pass valve is opened to relieve pressure; charging cap is removed; piston is returned to bottom of cylinder, and by-pass valve is closed. Lubricant is then inserted in cylinder, and charging cap replaced. Weight 15 lb., 8oz. Use size "J" (1-3/8 x 8-3/4") stick sealant.

Optional Straight Head for Type "A" Hypressure Lubricant Gun



HOMESTEAD LUBRICANT FEATURES

Sealant Number		*Temperature Range °F		Color	Principal Uses	Solvent
Stick	Bulk	From	To			
6	6-S	+32°	+275°	Gray	Hot water services	Naptha
400		+20°	+130°	Red	Acids and alkalies	Naptha
	400-S	0°	+110°			
400-A		+20°	+130°	Amber	Aqueous solutions of acids, alkalies and amines	Naptha
	400-AS	0°	+110°			
450		+20°	+130°	White	Food products	Naptha
	450-S					
600	600-S	0°	+120°	Cream	Hydrocarbon services	Perchlorethylene
650**		0°	+180°	Blue	Hydrocarbons, LPG and natural gas	Chlorethane
	650-S	-20°	+150°			
711	711-S	-10°	+150°	Amber	Internal combustion fuels	Chlorethane
750		+20°	+400°	Black	Asphalt and hot oil services	Naptha
800			+250°	White	Hydrocarbons and aromatics	Perchlorethylene
	800-S	-10°	+200°			
900		+10°	+240°	Black	Hydrocarbons, aromatics and asphalt	Perchlorethylene

*Temperature based upon 200 PSI working pressure. Temperature will vary with working pressure.

**Standard Lubricant - unless otherwise specified.

LUBRICATING GUN
(with coupler & hose assembly)

Type	List Price
A uses J Stick	866
AS uses Cartridge	1,016
B uses J Stick	1,385
Optional Straight Head Hose	259
Pressure Gauge	230

LUBRICANT TO FIT TYPE A, AS & B GUNS

Lubricant	List Price
J 16 Sticks 1 ³ / ₈ " x 8 ³ / ₄ "	596 (carton of 16)
Cartridge 14 ¹ / ₂ oz.	52 each 618 (carton of 12)

SMALL STICK LUBRICANTS
(24 sticks per box)

Lubricant	Size	Price per box
6, 400, 400-A, 450,	B — 3/8" x 1 1/2" long	44
600, 650, 711, 750,	C — 1/2" x 2 1/2" long	59
800, 900	D — 5/8" x 3 1/2" long	90

BULK LUBRICANTS

Lubricant	Cartridge	Quart	Gallon Pail	40lb. drum
6, 400, 400-A, 450, 600, 650, 711, 750, 800, 900	52	157	312	2945

LUBRICATION FITTINGS
(when ordered separately)

Size	Type	Part Number	Drawing Number	Valves	List Price
1/4"*	Combination giant buttonhead	1546130102	1546-M	1/2" – 2"	31
1/4"	Standard buttonhead	8210250000	K-10821	1/2" – 2"	18
1/4"	Giant buttonhead	8220250000	K-10822	1/2" – 2"	28
3/8"*	Combination giant buttonhead	1546120102	1546-L	2 1/2" – 8"	35
3/8"	Standard buttonhead	8210370000	K-10821	2 1/2" – 8"	18
3/8"	Giant buttonhead	8220370000	K-10821	2 1/2" – 8"	28
1/2"*	Combination giant buttonhead	1546140102	1546-N	Above 8"	41
1/2"	Standard buttonhead	8210500000	K-10821	Above 8"	23
1/2"	Giant buttonhead	8220500000	K-10821	Above 8"	31
Coupling for lube gun		45990	—	All	161

*Furnished with valves-unless otherwise specified

Homestead Lubricated Plug Valves are all furnished with combination buttonhead fitting and lubricant screw unless otherwise specified. If desired, valves will be furnished with choice of standard or giant buttonhead fitting at no extra cost.



***Combination Buttonhead Fitting and Lubricant Screw (Standard Equipment)**



Standard Buttonhead Fitting



Giant Buttonhead Fitting

WRENCH SIZE AND DIMENSIONS

SIZE	Square	Length	Approx. Wt. - Lbs.	Full Port and Diamond Port	Round Port	Reduced Port 602	Standard Opening 612	Full Port 603-606
F	13/16"	8 1/8"	1 1/4"	1/2" — 3/4"	1/2"	—	1"	1/2"
G	15/16"	9 9/16"	1 1/2"	1" — 1 1/2"	3/4" — 1/2"	—	1 1/4" — 2"	3/4" — 1 1/2"
E	1 1/4"	10 1/2"	2 3/4"	2" — 2 1/2"	—	—	2 1/2" — 3"	2" — 2 1/2"
L1	1 17/32"	17 27/32"	3 1/2"	3"	2" — 2 1/2"	—	4	—
N	2 1/32"	*	*	4–5–6"	3"	—	5–6–8–10"	3–4"
P	2 15/32"	*	*	8–10"	4–6–8"	10–12"	12–14"	6–8"

*Size optional—order in inches

WRENCH SIZES E, F, G & L



WRENCH SIZES N & P



DOUBLE END WRENCH SIZE AND DIMENSIONS

SIZE	FF	EE	LL	NN	PP	GG
Square	13/16"	1 1/4"	1 17/32"	2 1/32"	2 15/32"	15/16"
Length	16 1/4"	19 3/4"	—	—	—	RTF
Approx. Wt.-Lb.	1 5/8	4 5/8	8 1/2	15	35	RTF

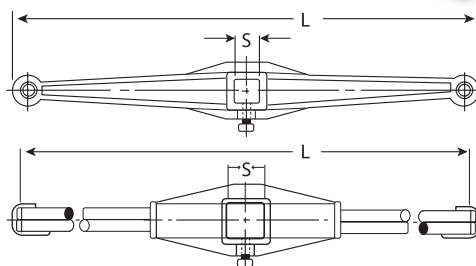

LOCKING & SEALING AND WRENCH LOCKING DEVICES

VALVE SIZE	FIG. NO.	LOCKING & SEALING DEV.	TYPE OF VALVE		WRENCH LOCKING DEV.	TYPE OF VALVE	
			Full Port List Price	Std. Opening List Price		Full Port List Price	Std. Opening List Price
1/2"	601, 641, 651	LSD #1	32	32	N/A	N/A	N/A
3/4"	601, 641	"	32	32	"	"	"
1"	611, 612	"	32	32	"	"	"
1 1/4"	651, 652	LSD #2	32	32	N/A	N/A	N/A
1 1/2"	651, 652	"	32	32	"	"	"
3/4"	651	LSD #3	32	32	N/A	N/A	N/A
1"	601, 602, 641, 651, 652	"	32	32	"	"	"
1 1/4"	601, 602, 611, 612, 641	"	32	32	"	"	"
1 1/2"	601, 602, 611, 612, 641, 642	"	32	32	"	"	"
2"	611, 612	"	32	32	"	"	"
2"	601, 602, 641, 642	E-LS	44	44	E-WL	68	68
2 1/2"	601, 602, 611, 612, 641, 642	"	44	44	"	68	68
3"	611, 612	"	44	44	"	68	68
2, 2 1/2"	651, 652	L-LS	83	83	L-WL	97	97
3"	601, 602, 641, 642	"	83	83	"	97	97
4"	611, 612	"	83	83	"	97	97
3"	651, 652	N-LS	120	120	N-WL	134	134
4"	601, 602, 641, 642	"	120	120	"	134	134
5"	602, 602A, 612, 642	"	120	120	"	134	134
6"	602, 602A, 612, 612A, 642, 622A	"	120	120	"	134	134
8"	612, 612A	"	120	120	"	134	134
10"	612A	"	120	120	"	134	134
4"	651A, 652	P-LS	168	168	P-WL	184	184
6"	652A	"	168	168	"	184	184
8"	602A, 622A, 642A, 652A	"	168	168	"	184	184
10"	602A, 622A, 642A	"	168	168	"	184	184
12"	602A, 622A, 612A	"	168	168	"	184	184

Locking devices may be added without valve modification. For straightway valves, locking device sizes are the same as the corresponding wrench size. Specify by letter.

Homestead Locking and Sealing Device (Patented)

Specify "LS" after wrench letter



Homestead Wrench Locking Device (Patented)

Specify "WL" after wrench letter

Sizes requiring "N" or "P" wrench have pin and lock arrangement.

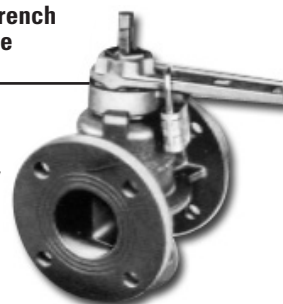

In some instances pictures shown do not represent the lubrication fitting currently being sold.

TAPPING FOR BY-PASS CONNECTIONS *

Valve Size	Valve Type	Price Per Hole
1/2" to 4"	100% Pipe area and Standard Opening	32
5", 6", 8"	100% Pipe area and Standard Opening	44
10" and above	100% Pipe area and Standard Opening	75

*1/8" NPT size standard.

DOUBLE END WRENCHES

Size	List Price	Size	List Price
FF	48	NN**	173
EE	84	PP**	261
LL**	132	GG	59

#2/0 Double loop chain for double-end wrenches @ \$11.00 LIST per foot or fraction.

** Wrench head only; handle extra @ \$11.00 LIST per foot or fraction.

T-HANDLE SOCKET WRENCHES

Standard wrenches are four feet long from center line of handle to bottom of socket. Prices are for standard four foot length or less. Additional length \$21 per foot LIST or fraction thereof.

Valve Size and Type	List Price
4" and 6" straightway, 100% pipe area	381
6" and 8" straightway, standard opening	
3" and 4" 3-way	
Valves with an adapter	List Price
8" and 10" straightway, 100% pipe area	760
10" and 12" straightway, standard opening	
6" 3-way	

PARTS FEATURES

ADAPTERS



Adapters may be had for all sizes and types of wrench operated valves with stem square dimensions less than 2". All adapters have 2" square head so that they may be operated with a size "N" wrench or socket wrench.

STOP RINGS FOR 3 AND 4 WAY VALVES



90° TURN



180° TURN



270° TURN



STEAM JACKET BONNET



FLANGED BODY



SCREWED BODY



ROUND PORT PLUG



DIAMOND PORT PLUG



RECTANGULAR PLUG (Standard)



BONNET



LUBRICANT SCREW



CHECK VALVE AND THREAD SEAL



SPRING



REINFORCED TEFLON® STEM SEAL



STEEL DISC



TEFLON® THRUST DISC

HIGH HEAD EXTENSIONS

For Sizes and Types of Valves	List Price
Full Port Valves— $\frac{1}{2}$ " to 6" Standard Opening Valves— 1" to 10" 3-Way Valves and Round Port— $\frac{3}{8}$ " to 4" All Sizes Worm and Gear Operated	462
Full Port Valves—8", 10" Standard Opening Valves— 12" 3-Way Valves and Round Port—6"	590

NOTE: Extensions are completely assembled (3' center line of pipe to top of extension.) For added length of high head extension, add \$13.00 list for each 6" or fraction thereof.

Prices do not include Socket "T" wrench.

LOW HEAD EXTENSIONS

For Sizes and Types of Valves	List Price
Full Port Valves— $\frac{1}{2}$ " to 6" Standard Opening Valves— 1" to 10" 3-Way Valves and Round Port— $\frac{3}{8}$ " to 4"	366
Full Port Valves—8", 10" Standard Opening Valves— 12" 3-Way Valves and Round Port—8"	410

NOTE: Extensions are completely assembled (3' center line of pipe to top of extension.) For added length of low head extension, add \$13.00 list for each 6" or fraction thereof.

Prices do not include Socket "T" wrench.

FLOOR STANDS

Type	Valve	Drawing	List Price
Wrench operated	$\frac{1}{2}$ " — 6" wrench operated	RTF	RTF
Wrench operated	8" and larger wrench operated	RTF	RTF
Handwheel operated	spur gear operated	RTF	RTF
Handwheel operated	worm gear operated	RTF	RTF

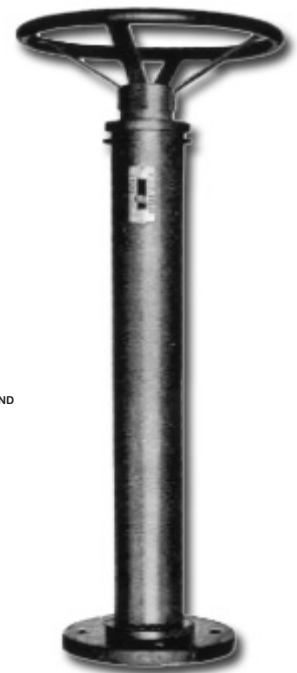
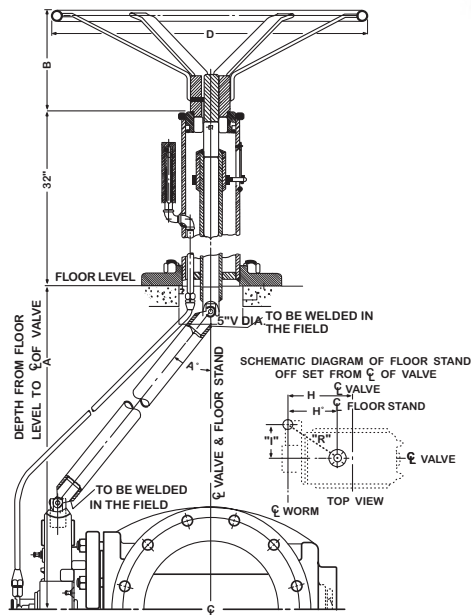
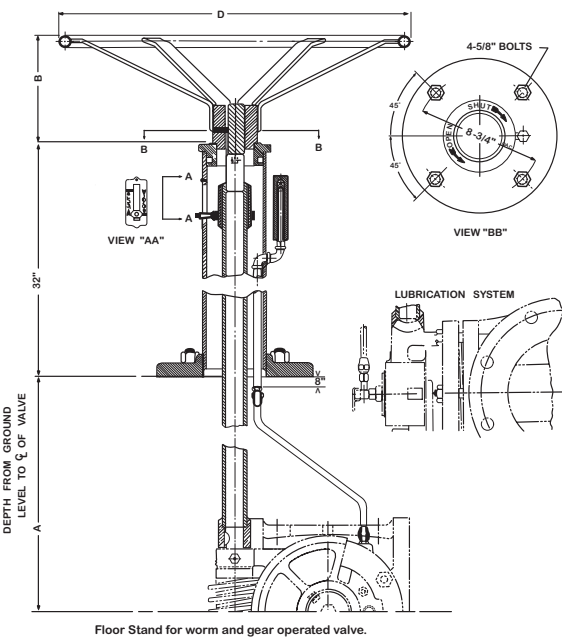

THREE AND FOUR WAY VALVE PORT POSITIONS

(VIEW IS FROM TOP OF VALVE)

4 WAY / 90° TURN

STYLE B 4 Way / 4 Port / 90° Turn

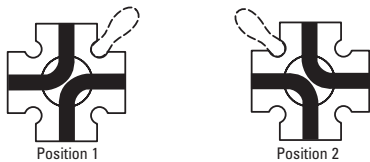

3 WAY / 2 PORT

STYLE A 3 Way / 2 Port / 90° Turn

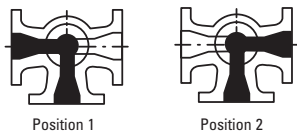

Also available in 3-way, 2 port, for 180° turn, right or left hand operation.

STYLE P 3 Way / 2 Port / 180° Turn



STYLE R 3 Way / 2 Port / 180° Turn



3 WAY / 3 PORT / 90° TURN

STYLE C 3 Way / 3 Port / 90° Turn

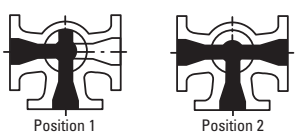

STYLE D 3 Way / 3 Port / 90° Turn

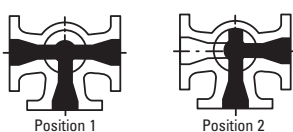

STYLE E 3 Way / 3 Port / 90° Turn

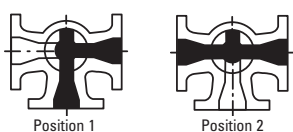

STYLE F 3 Way / 3 Port / 90° Turn

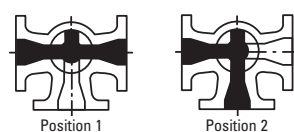

3 WAY / 3 PORT / 180° TURN

STYLE G 3 Way / 3 Port / 180° Turn



STYLE H 3 Way / 3 Port / 180° Turn



STYLE I 3 Way / 3 Port / 180° Turn



STYLE J 3 Way / 3 Port / 180° Turn



3 WAY / 3 PORT / 270° TURN

STYLE K 3 Way / 3 Port / 270° Turn

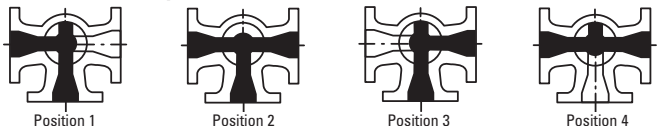

STYLE L 3 Way / 3 Port / 270° Turn

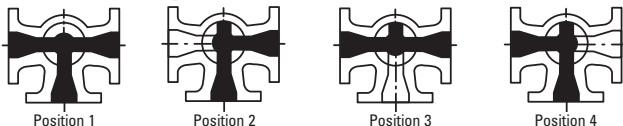

STYLE M 3 Way / 3 Port / 270° Turn

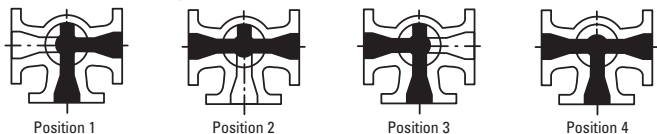

STYLE N 3 Way / 3 Port / 270° Turn

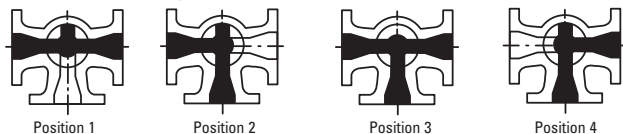

How to order: When ordering three-way valves, specify the size and figure number of the valve, plus the style letter of the port position desired. Example: 3" – figure 606, Style C. Three-way and four-way valves can be furnished without stop-rings to allow a full 360° turn. Three types of stop-rings are shown on page 11.

DEFINITIONS

Rectangular Port — Homestead Lubricated Plug Valves have rectangular shaped ports through the plug and body. The area of the port is either equal to 100% of the area of standard pipe, or restricted (standard opening), but in either case it is clearly marked for the various figure numbers.

100 % Area (Full Port) — means the area through the valve is equal to or greater than the area of standard pipe.

Standard Opening — means that the area through the valve is less than the area of standard pipe, and therefore these valves should be used only where restriction of flow is unimportant.

Round Port — means that the valve has a full round opening through the plug and body, of the same size and area type.

Diamond Port — means the opening through the plug is diamond shaped. All diamond port valves are restricted flow type, used primarily for throttling service.

WOG — Water, Oil, Gas (cold working pressures)

SWP — Steam Working Pressure

ANSI — American National Standards Institute

CWP — Cold Working Pressure

RTF — Refer To Factory

SPECIFICATIONS

All Homestead Lubricated Plug Valves Equal or Exceed the Requirements of the Following Specifications:

Cast Iron - 125#

1. **ANSI B1.20.1** - National Pipe Thread Taper
2. **Faced and drilled in accordance with ANSI B16.1** - 125# Cast Iron Pipe Flanges and Flanged Fittings.
3. **ANSI B16.10** - Face to Face Dimensions of Ferrous Flanged End Valves; Class 125. Multiple port and round port valves are not covered by this specification.
4. **ASTM-A-126 Grade B** - Body and Plug Material.

METALS, TYPES AND SIZES

Homestead Lubricated Plug Valves are cast in semi-steel.

Inquiries for quantities of valves in metals other than semi-steel, and port arrangements other than those shown in this catalog, are welcome.

HOW TO SPECIFY

Sample specification for the convenience of Engineers, Architects, and Contractors in writing specific valve specifications.

"Valves are to be of the lubricated plug type, without taper, and with close tolerance between plug and body sealing surfaces. Valves are to have a stem seal of reinforced Teflon. Valves must have a leakproof, spring loaded ball and lubricant sealed check valve, and combination lubricant screw and button head fitting to prevent foreign matter from being forced into lubricant system. Valve plugs are to be floated on low-friction Teflon surfaces for extra ease of turning—the lower the surface to also act as a means of minimizing torsional stress in the spring—and are to have port area equal to 100% of the area of standard pipe (or standard opening if desired). Valves are to be so constructed that lubricant system has sufficient pressure to force lubricant over all seating surfaces. Extruded lubricant around stem is to be positive indication that lubricant system is full, and that there has been a minimum contamination of line fluids. Valves are for use on lines handling _____ (fluid) at _____ °F temperatures, and _____ # pressure; and are to be as manufactured by Olson Technologies Valve Company.

Note: please be sure to include with the specifications, quantity, size, and figure number of each type of valve; the number and type of wrenches desired; and a sufficient supply of lubricant for the various sized valves, and for different fluids or service conditions.

INFORMATION NEEDED ON ORDER

Your local Homestead Distributor is willing and well-equipped to help solve your valve problems. He carries a stock or popular sizes and types of Homestead Lubricated Plug Valves to meet your immediate needs. Order by figure number, and please be sure to give all necessary facts, such as: pipe size, fluid, pressure, temperature, number of wrenches, extra lubricant, etc., on order.

OLSON TECHNOLOGIES INC. – TERMS & CONDITIONS OF SALE

ACCEPTANCE

The terms and conditions contained herein and attached hereto shall apply to all sales by Seller and no understanding, agreement, term, condition or trade custom at variance herewith shall be binding on the Seller. Any prior terms in Buyer's documents are specifically objected to and rejected. Any proposal for additions or different items or any attempt to Buyer to vary, in any degree, any of these terms in Buyer's Acceptance by Purchase Order or otherwise is objected to and shall not operate as a rejection of this offer to sell unless such variance is in the terms of description, quantity or price of the goods, but shall be deemed accepted by Buyer without said additional or different terms. If this document is to be deemed an acceptance of a prior offer by Buyer, such acceptance is expressly conditioned on Buyer's assent to any additional or differing terms contained herein.

The Seller shall not be bound by any contract until approved in writing by an officer of the Seller at the Seller's principal place of business. The contract when so approved shall supercede all previous communications, either oral or written. No modification shall be binding upon the parties unless such modification shall be in writing duly executed by the Buyer and approved by an executive officer of the Seller.

RISK OF LOSS

Unless specifically agreed in writing, all freight damages shall be paid by the Buyer and risk of loss or damage to the goods passes to Buyer upon delivery of the goods by Seller to the carrier regardless of FOB designations. Seller reserves the right to select the means of transportation routing and to ship loads of any quantity without charge to Seller. Seller retains a security interest in the goods or any replacements thereof regardless of the mode or attachment to realty or other property until final payment in cash has been made therefore. Any damage or loss of goods during shipment must be reported to the carrier and to Seller before the unloading of such goods. Any claims for such damage or loss must be presented to Seller within 90 days of delivery.

DELIVERY

Any delivery dates or schedules quoted by Seller shall be interpreted as estimates only and in no event shall such dates be construed as failing within the meaning of "time is of the essence."

NO SET OFF

Neither Buyer or any affiliated company, surety, or assignee, shall have the right to set off against any amounts which may become payable to Seller under this contract or otherwise, for amounts which the Seller may allegedly or infant owe the Buyer or any affiliated company, surety, or assignee, whether arising under this contract or otherwise.

PATENTS

Seller shall defend any suit or proceeding brought against the Buyer and shall pay any adverse judgement therein so far as such suit or proceedings based upon a claim that the use of the goods or any part thereof manufactured by the Seller and furnished under this contract constitute infringement of any U.S. patent, providing the Seller is promptly notified in writing and govern authority, information and assistance for defense of same; and the Seller shall at its option, procure for the Buyer the right to continue to use said goods, or to modify it so that becomes non-infringing, or to replace the same with non-infringing equipment, or to remove said equipment and to refund the purchase price. The foregoing shall not be construed to include any agreement by the Seller to accept any liability whatsoever in respect to patents or inventions including more than the goods furnished hereunder, or in respect of patents for methods and processes to be carried out with the aid of said goods, except those which are inherent in the goods as furnished. The foregoing states the entire liability if Seller with regard to patent.

If any goods shall be sold by the Seller to meet Buyer's specifications or requirements, Buyer agrees to defend, protect, indemnify and save harmless the Seller from any loss, damage, or injury arising out of the claim, suit or action at law or in equity for actual or alleged infringement of any patent of the U.S. or any foreign country because of such specifications or requirements in the sale of such goods and to defend such suit or actions which may be brought against the Seller.

CONFIDENTIAL INFORMATION

All drawings, designs, specifications, and technic information prepared or submitted by Seller are confidential documents which are the sole property of Seller and shall not be used or turned over, directly or indirectly, in whole or in part to any person or persons not authorized by Seller in writing to inspect, poses, or use same.

LIMITATION OF LIABILITY

IN NO EVENT SHALL THE TOTAL LIABILITY IF THE SELLER ARISING OUT OF THE PERFORMANCE OF BREACH OF THIS CONTRACT, WHETHER BASED ON CONTRACT, WARRANTY, NEGLIGENCE, INDEMNITY, STRICT LIABILITY OR OTHERWISE, EXCEED THE PURCHASE PRICE OF THE EQUIPMENT UPON WHICH SUCH LIABILITY IS BASED.

THE SELLER SHALL IN NO EVENT BE LIABLE FOR ANY CONSEQUENTIAL, INCIDENTAL, INDIRECT, SPECIAL OR PUNITIVE DAMAGES ARISING OUT OF THIS CONTRACT OR ANY BREACH THEREOF, OR ANY DELAY IN DELIVERY OR DEFECT IN THE GOODS. PURCHASED HEREUNDER, WHETHER BASED UPON LOST PROFITS OR REVENUE, WORK STOPPAGE, IMPAIRMENT OF OTHER GOODS LOSS BY REASON OF SHUT-DOWN OR NON OPERATION OR INCREASED EXPENSES OF OPERATION, WHETHER OR NOT SUCH LOSS OR DAMAGE IS BASED ON CONTRACT, WARRANTY, NEGLIGENCE INDEMNITY, STRICT LIABILITY OR OTHERWISE.

Seller shall not be responsible for any loss or damage resulting from any delay in delivery of failure to perform, due to war, civil riots, civil insurrection or acts of the common enemy, fire, floods, strike or other labor difficulties, acts of civil or military authority, including governmental laws, orders priorities, regulations, acts of the purchaser, embargo, any shortage, wreckage or delay in transportation, inability to obtain necessary labor, materials or manufacturing facilities, faulty foregoing or casting or other causes beyond the reasonable control of the Seller. In the event of delay in performance due to any such cause, the estimated date of delivery or time for completion will be adjusted to reflect such delay. The Buyer's acceptance of the goods shall constitute a waiver of all claims for delay.

Clerical and stenographical errors are subject to correction.

TAXES

The price does not include any federal, state or local property, license, privilege, sales, use, value added, excise, gross receipts, or other like taxes which may be now or hereafter applicable to, measured by, or imposed upon with respect to this transaction, the goods, their sale, value or use, or any service performed in connection therewith. Any such taxes shall be added to the price quoted herein, unless exemption or resale certificate acceptable to the taxing authority, is furnished to Seller. If an exempt on certificate previously was accepted by Seller is not recognized by the taxing involved, Buyer will immediately upon notice of same pay to Seller the amount of the tax together with all penalties and interest thereon. Buyer shall also be liable to Seller for any expenses, including legal expenses, by reason of any delay or failure to pay as provided above.

WARRANTY

Seller warrants that the goods manufactured by it and delivered or the services provided shall be free from significant defects in material and workmanship for a period of one year from the date of shipment of goods or a period of 60 days from the completion date of any services provided the goods or equipment are used within the service or pressure range for which they were manufactured. Seller shall, at its option, repair or replace any nonconformity by suitable repair or replacement FOB Seller's Plant, or by refunding the purchase price, this warranty shall apply only if the goods were installed in their "as shipped" condition and were installed, maintained, and operated in accordance with any specific recommendation of Seller. This warranty does not cover deterioration by corrosion or aging parts, including stress corrosion. Repairs or alterations not authorized in writing by Seller shall void this warranty. Any material, equipment, or part furnished by Seller but manufactured by others, shall only carry whatever warranty the manufacturer thereof has conveyed to Seller and which can be passed on to Buyer.

Compliance with the foregoing shall constitute fulfillment of all liabilities of Seller for any defect or nonconformity whether arising in contract warranty, negligence, indemnity, strict liability, or otherwise.

THE FOREGOING IS IN LIEU OF ALL OTHER WARRANTIES EXPRESSED OR IMPLIED, SELLER DISCLAIMS, THE IMPLIED OR MERCHANTABILITY AND FITNESS FOR PURPOSE.

DESIGN

Due to our policy of continuous product improvement, we reserve the right to change or modify any design without incurring any obligation to furnish or install such changes on products previously or subsequently sold. Seller reserves the right to furnish substitutes for materials which cannot be reasonably obtained because of any restrictions, voluntary or compulsory, established by or in connection with any governmental authority.

ENGINEERING SERVICE

Upon request, Olson Technologies may provide engineering and/or technical information about its products and their uses; and if feasible may provide personnel to assist purchaser in effecting field installation and/or field service. Such information, service, or assistance so provided, whether with or without charge, shall be advisory only, and purchaser agrees to hold Olson Technologies harmless from claims for loss from any cause resulting from such advisory or service activity.

QUOTATIONS & PRICES

Quotations are for acceptance within 30 days or for the period of time specifically stated in the quotation. Prices are subject to change without notice. Prices are FOB factory subject to Seller's usual freight allowances, if any. Orders requiring export packaging shall be subject to additional charges determined by the Seller. \$25.00 minimum.

TERMS

Terms of payment are Net 30 days. Unpaid balance beyond 30 days shall bear interest at the rate of 2% per month or the lawful maximum whichever is less.

MINIMUM BILLING

"Minimum billing of \$200 (\$50 for parts) net will be charged per order or any partial shipment requested by customer. Change orders and and/or "add on" supplements are subject to additional billings commensurate with the cost and will receive individual consideration insofar as minimum billing, freight allowance and discount are concerned.

RETURNS, CANCELLATIONS, AND CLAIMS

No material may be returned for credit or adjustment without permission and return tagging instructions—in writing—from our General Office.

On all material approved for return for credit, handling/restocking costs, if any, and costs to recondition for resale as new will be charged. Orders for items of special design, size, or material will not be accepted for credit nor will cancellation of such orders be accepted except upon written agreement to allow for payment for expenses incurred by Olson Technologies covering special work which has been performed or material that has been ordered. Claims, for errors, corrections shortages or deductions for erroneous charges must be made in writing within ten days after the receipt of products and must refer to date and number of invoice. In making claims for shortages of products or any overcharges, the original paid freight must accompany each claim which in case of shortage should bear notification to the effect Seller shall be obligated to substantially perform hereunder only and shall not be liable for any non-material or insubstantial breach or violation hereof and shall not be responsible or liable to Buyer for any claimed breach or violation of this Agreement unless notified in writing by the Buyer thereof within ten days after such breach of violation is known or could have been known to Buyer by reasonable inspection, but in no event shall Seller, except as specifically provided herein, be liable therefore, whether such breach is patent or latent for any notice of claim received more than one year after the date of shipment. Approval by Buyer's inspector of work in progress shall be conclusive and binding on Buyer with respect to such work.

ASSIGNMENT

Buyer shall not assign or transfer this contract without prior written consent of the Seller.

GOVERNING LAW

This contract shall be interpreted and enforced in accordance with the laws of the Commonwealth of Pennsylvania



HOMESTEAD[®]

V A L V E

160 Walnut Street, Allentown, PA 18102

PHONE: 610-770-1100 FAX: 610-770-1108

e-mail: sales@homesteadvalve.com

www.homesteadvalve.com

© 2011 Olson Technologies, Inc.

