

Installation & Adjusting Instructions

Sensor Mounting

1. Mount sensor in 18.5 to 20mm diameter clearance hole using fastener(s) and lock washer provided. One fastener and lockwasher may be used when mounting against housing flange. Max torque for lock nut is 45 Nm (1 Nm=0.74 ft. lbs.)
2. Locate sensor so target will move within nominal sensing range and avoid contact with sensor face (mild steel less than 4mm, stainless steel less than 3 mm).
3. Red and Green LED sensors may be mounted next to one another with no signal interference. Sensors of the same color LED should not be used together if sensors are closer than 45 mm (1.75").

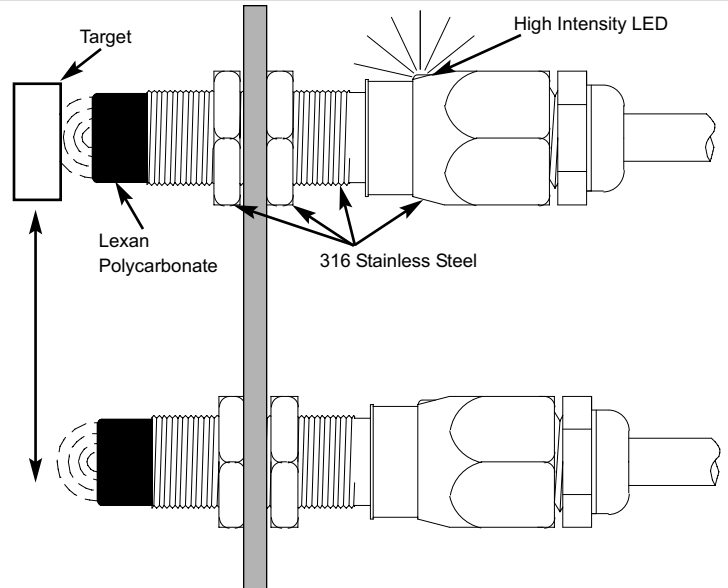

Hawkeye™ Sensor Model Number Descriptions

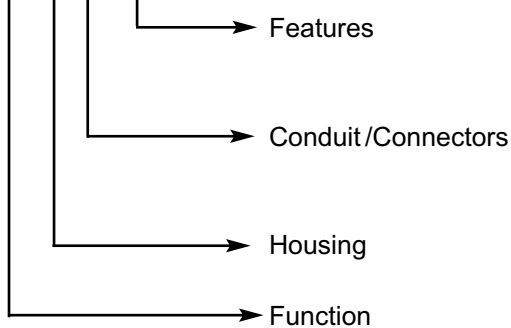
HK 30 7 7 SR

SR - Red LED

SG - Green LED

7 - (1) 1/2"-14 NPT

 8 - 3-Pin Mini-Connector in Stainless Steel
 (Only available for Function 30&31)

7 - 316 Stainless Steel Housing

30 - (1) 2-wire Solid State Sensor (Normally Open)

31 - (1) 2-wire Solid state Sensor (Normally Closed)

40 - (1) 2-wire NAMUR Solid State Sensor (I.S.)

50 - (1) 3-wire PNP (Sourcing) Sensor (Normally Open)

51 - (1) 3-wire PNP (Sourcing) Sensor (Normally Closed)

60 - (1) 3-wire NPN (Sinking) Sensor (Normally Open)

61 - (1) 3-wire NPN (Sinking) Sensor (Normally Closed)

Hawkeye™ Dimensional Data

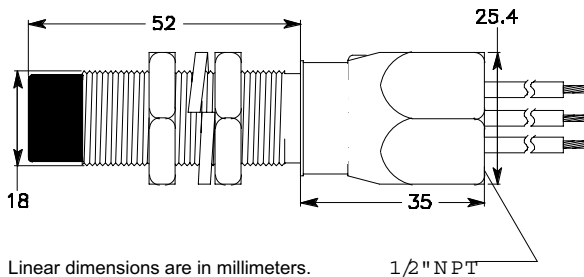

Linear dimensions are in millimeters.

1/2" NPT

Stonel
**One Stonel Dr
 26271 US Hwy 59
 Fergus Falls, MN 56537
 USA**

Telephone: 218.739.5774

Toll Free: 800.843.7866

Fax: 218.739.5776

E-mail: sales@stonel.com

Website: www.stonel.com

© 2009 Stonel

Specifications:		Nominal Sensing Distance:	4 mm (Mild Steel Target) 3 mm (Stainless Steel Target)
Supply Voltage:	8 to 125 VDC, 24 to 125 VAC	Temp Range:	- 40° F to 180° F (- 40° C to 82° C)
Max Continuous Current:	0.3 Amp @ Rated Voltage	Housing Material & Fasteners:	316 Stainless Steel
Max Inrush Current:	2.0 Amps	Conduit Connection:	1/2"NPT
Min Switching Current:	2.5 milliamps	Wiring:	36" length 18 gauge multi-strand
Max Leakage Current:	0.15 mA with DC voltage 0.25mA with AC voltage	Enclosure Protection:	NEMA 4, 4X & 6 / IP. 67
Maximum Voltage Drop:	6.5V @ 10 mA 7.5V @ 100 mA	Warranty:	5 Years

To Bench Test a Hawkeye 2-Wire Sensor: Use Stonel Light Read Tester. Or use a 24 VDC or 120 VAC power supply with series load resistor (2K - 6K Ω).

Sensor Wiring

1. Connect sensors per wiring diagram below.
2. Sensors may be wired for Division 2 Hazardous locations using standard code practice for explosion proof systems. For Division 1 Hazardous areas intrinsically safe wiring and circuit protection must be followed. See Page Four for Intrinsic Safety wiring instructions

WARNING:

FAILURE TO USE A SERIES LOAD RESISTOR WHEN BENCH TESTING SENSORS WITH A POWER SUPPLY WILL RESULT IN PERMANENT DAMAGE TO THE UNIT.

HK3077 ___ or HK3177 ___

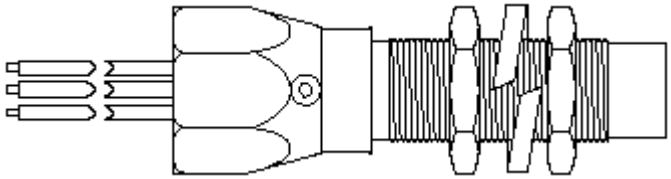

Wire Color	Signal
White/Green Stripe	Common*
White/Green Stripe	Normally Open*
Green	Case Ground**

Wire Color	Signal
White/Red Stripe	Common*
White/Red Stripe	Normally Open*
Green	Case Ground**

Wire Color	Signal
Green/White Stripe	Common*
Green/White Stripe	Normally Closed*
Green	Case Ground**

Wire Color	Signal
Red/White Stripe	Common*
Red/White Stripe	Normally Closed*
Green	Case Ground**

* Sensors are not polarity sensitive
** Case Ground not required for circuit operation

HK3078 ___ or HK3178 ___

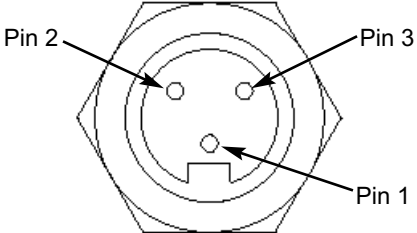

Pin Number	Signal
Pin 1	Case Ground**
Pin 2	NO/NC*
Pin 3	Common*

* Sensors are not polarity sensitive
** Case Ground not required for circuit operation

Specifications for Sourcing (PNP) Sensors:
(HK5077__, HK5177__)

Supply Voltage:	6 to 28 VDC
Max Continuous Current:	200 mA
Quiescent Current:	160 μ A
Min Switching Current:	2.0 mA
Max Leakage Current:	0.6 μ A
Maximum Voltage Drop:	0.65 VDC
Nominal Sensing Distance:	4 mm (Mild Steel Target) 3 mm (Stainless Steel Target)
Temp Range:	- 40° F to 180° F (- 40° C to 82° C)
Housing Material & Fasteners:	316 Stainless Steel
Conduit Connection:	1/2"NPT
Wiring:	36" length 18 gauge multi-strand
Enclosure Protection:	NEMA 4, 4X & 6 / IP. 67
Warranty:	5 Years

Specifications for Sinking (NPN) Sensors:
(HK6077__, HK6177__)

Supply Voltage:	6 to 28 VDC
Max Continuous Current:	200 mA
Quiescent Current:	160 μ A
Min Switching Current:	2.0 mA
Max Leakage Current:	0.6 μ A
Maximum Voltage Drop:	0.65 VDC
Nominal Sensing Distance:	4 mm (Mild Steel Target) 3 mm (Stainless Steel Target)
Temp Range:	- 40° F to 180° F (- 40° C to 82° C)
Housing Material & Fasteners:	316 Stainless Steel
Conduit Connection:	1/2"NPT
Wiring:	36" length 18 gauge multi-strand
Enclosure Protection:	NEMA 4, 4X & 6 / IP. 67
Warranty:	5 Years

To Bench Test a Hawkeye 3-Wire Sensor: Use Stonel Light Read Tester. Or use a 24 VDC power supply with series load resistor (2K - 6K Ω).

Sensor Wiring - Connect sensors per wiring diagram below.

WARNING:

FAILURE TO USE A SERIES LOAD RESISTOR WHEN BENCH TESTING SENSORS WITH A POWER SUPPLY WILL RESULT IN PERMANENT DAMAGE TO THE UNIT.

HK5077__ or HK5177__

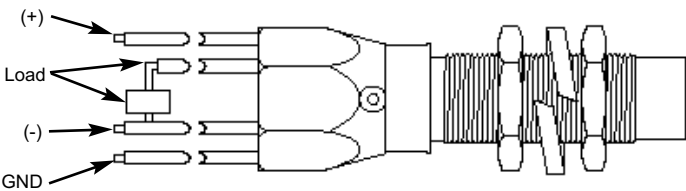

HK5077SG

Wire Color	Signal
Brown	(+)
White/ Green Stripe	Load
Blue	(-)
Green	Case Ground*

HK5077SR

Wire Color	Signal
Brown	(+)
White/ Red Stripe	Load
Blue	(-)
Green	Case Ground*

HK5177SG

Wire Color	Signal
Brown	(+)
Green/ White Stripe	Load
Blue	(-)
Green	Case Ground*

HK5177SR

Wire Color	Signal
Brown	(+)
Red/ White Stripe	Load
Blue	(-)
Green	Case Ground*

* Case Ground not required for circuit operation

HK6077__ or HK6177__

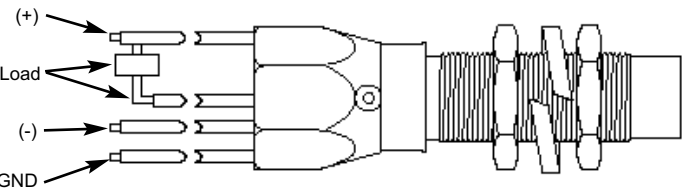

HK6077SG

Wire Color	Signal
Brown	(+)
White/ Green Stripe	Load
Blue	(-)
Green	Case Ground*

HK6077SR

Wire Color	Signal
Brown	(+)
White/ Red Stripe	Load
Blue	(-)
Green	Case Ground*

HK6177SG

Wire Color	Signal
Brown	(+)
Green/ White Stripe	Load
Blue	(-)
Green	Case Ground*

HK6177SR

Wire Color	Signal
Brown	(+)
Red/ White Stripe	Load
Blue	(-)
Green	Case Ground*

* Case Ground not required for circuit operation

Specifications for NAMUR Sensors:

(Namur Sensors conform to EN 60947-5-6 Standard)

Indications: Target On Sensor = LED Off
 Target Off Sensor = LED On

Operating Voltage: 5-25 VDC

Current Ratings: Target On (LED Off) <1.0mA
 Target Off (LED On) >2.1mA

Entity Parameters: $U_i = 22 \text{ Vdc}$
 $I_i = 120 \text{ mA}$
 $C_i = 98 \text{ nF}$
 $L_i = 1.56 \text{ mH}$
 $P_i = 2.0 \text{ W}$

Must use intrinsically safe repeater barrier.

Nominal Sensing Distance: 4 mm (Mild Steel Target)
 3 mm (Stainless Steel Target)

Temp Range: - 40° F to 180° F (- 40° C to 82° C)

Housing Material & Fasteners: 316 Stainless Steel

Conduit Connection: 1/2"NPT

Wiring: 36" length 18 gauge multi-strand

Enclosure Protection: NEMA 4, 4X & 6 / IP. 67

Warranty: 5 Years

To Bench Test a Hawkeye NAMUR Sensor: Use StoneL Light Read Tester or a 24 VDC power supply. Sensors are polarity sensitive

Sensor Wiring - Connect sensors per wiring diagram below.

HK4077SR or HK4077SG

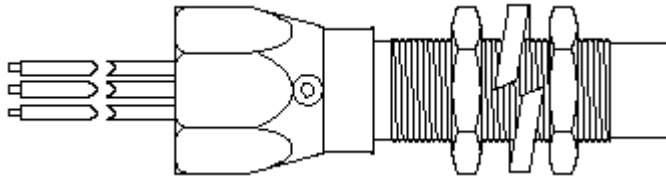

HK4077SG

Wire Color	Signal
Brown	(+)
Blue	(-)
Green	Case Ground**

HK4077SR

Wire Color	Signal
Brown	(+)
Blue	(-)
Green	Case Ground**

* Sensors are polarity sensitive

** Case Ground not required for circuit operation

HK4078SR or HK4078SG

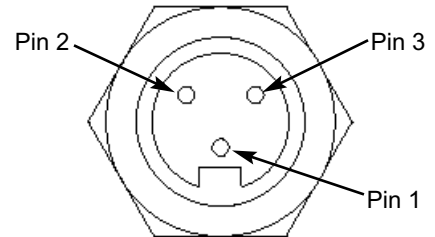

Pin Number	Signal
Pin 1	Case Ground**
Pin 2	(-)*
Pin 3	(+)*

* Sensors are polarity sensitive

** Case Ground not required for circuit operation

Hawkeyes models approved for Intrinsically Safe Installations:

(Class I, II, III; Division 1; Gas Groups A, B, C, D, E, F, G)

HK3077SR; HK3077SG; HK3177SR; HK3177SG

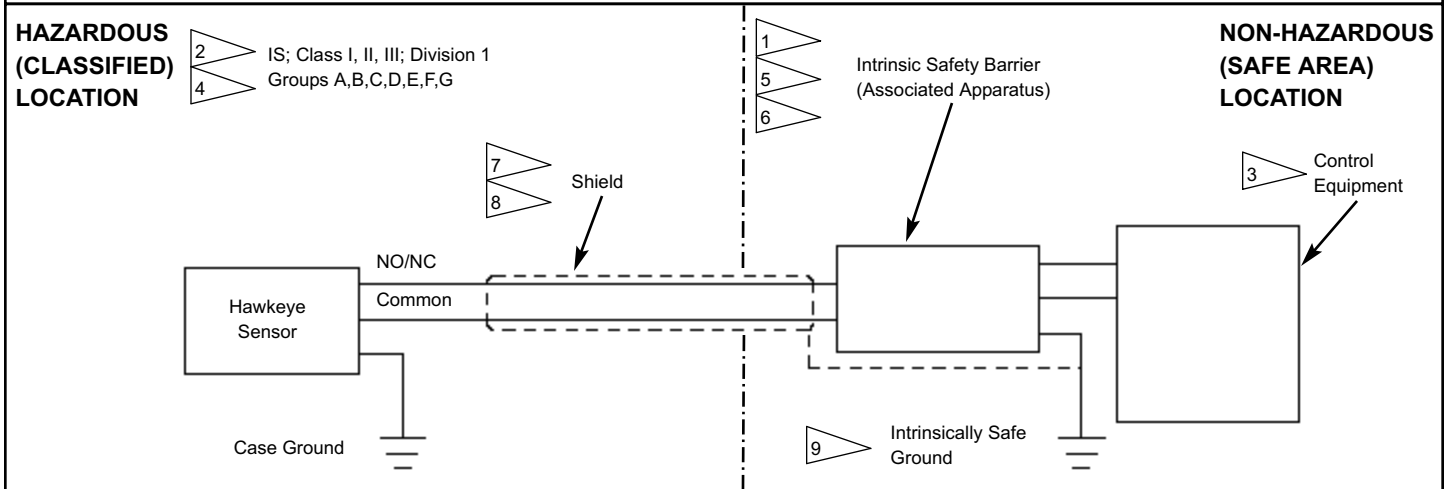

FM (US) INSTALLATION NOTES:

Hawkeye Entity Parameters: $V_{max} = 30 \text{ Vdc}$ $I_{max} = 120 \text{ mA}$ $C_i = 0.066 \mu\text{F}$ $L_i = 0.794 \text{ mH}$

1. V_{oc} or $V_t \leq V_{max}$, I_{sc} or $I_t \leq I_{max}$, $C_a \geq C_i + C_{cable}$, $L_a \geq L_i + L_{cable}$.
2. For Class II and III, Division 1 installations, where conduit is not used, use Listed dust-tight cable-gland fittings.
3. Control equipment connected to intrinsic safety barrier must not use or generate more than 250 Vrms or Vdc.
4. Installation should be in accordance with ANSI/ISA RPA12.6 "Installation of Intrinsically Safe Systems for Hazardous (Classified) Locations" and the National Electrical Code (ANSI/NFPA 70).
5. The configuration of the intrinsic safety barrier for each Hawkeye sensor must be FMRC Approved.
6. Intrinsic safety barrier manufacturer's installation drawing must be followed when installing this equipment.
7. To maintain intrinsic safety, wiring associated with each Hawkeye sensor must be run in separate cables or separate shields connected to intrinsically safe (associated apparatus) ground.
8. Conduit Grounding - Upon installation verify electrical continuity between conduit and ground terminal.
9. Resistance between Intrinsic Safe Ground and earth ground must be less than one ohm.

CANADIAN INSTALLATION NOTES:

1. Barrier must be a Canadian Certified, Single Channel grounded Shunt Diode Zener Barrier or a Single Channel Isolating Barrier, or; One dual-channel or two single-channel barriers may be used where both channels have been Certified for use together with combined entity parameters.
2. For Class II and III, Division 1 installations, where conduit is not used, use Canadian Certified dust-tight cable gland fittings.
3. Control equipment connected to Intrinsic Safety barriers must not use or generate more than 250 VRMS or VDC.
4. Install in accordance with the Canadian Electrical Code.
5. The configuration of intrinsic safety barriers for each Hawkeye sensor must be Canadian Certified.
6. Intrinsic safety barrier manufacturer's installation drawing must be followed when installing this equipment.
7. To maintain intrinsic safety, wiring associated with each Hawkeye sensor must be run in separate cables or separate shields connected to intrinsically safe (associated apparatus) ground.
8. Conduit Grounding - Upon installation verify electrical continuity between conduit and ground terminal.
9. Resistance between Intrinsic Safe Ground and earth ground must be less than one ohm.

Hawkeyes models approved for Intrinsically Safe Installations: (Ex ia IIC T5)

HK4077SR; HK4077SG; HK4078SR; HK4078SG

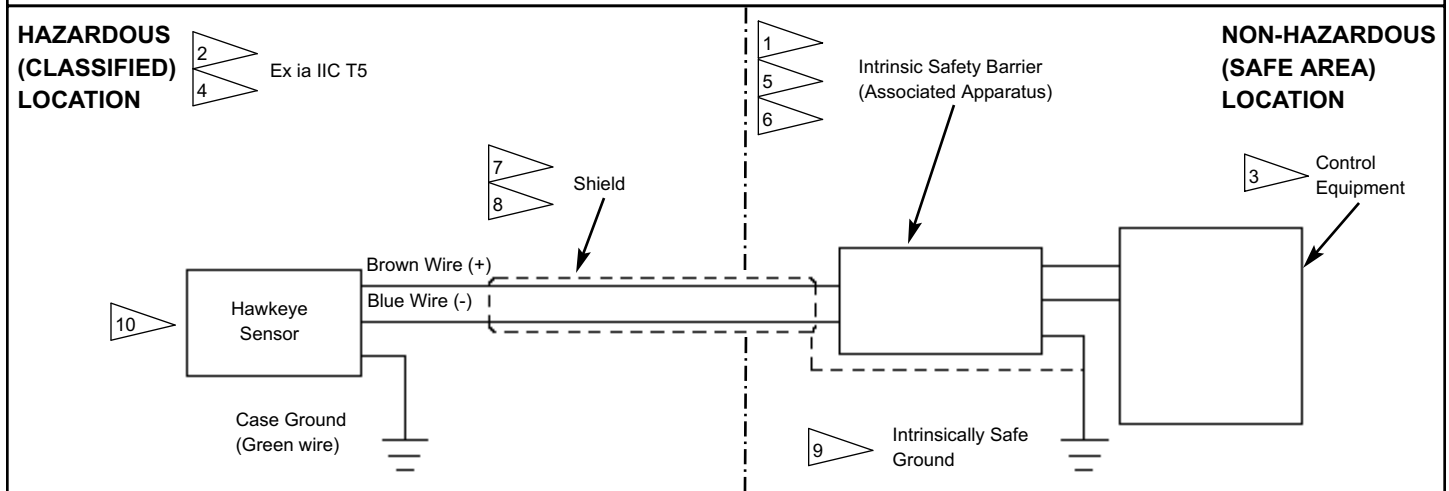

INSTALLATION NOTES (Ex ia IIC T5):

Hawkeye Entity Parameters: $U_i = 22 \text{ Vdc}$; $I_i = 120 \text{ mA}$; $C_i = 98 \text{ nF}$; $L_i = 1.56 \text{ mH}$; $P_i = 2.0 \text{ W}$

1. V_{oc} or $V_t \leq U_i$, I_{sc} or $I_t \leq I_i$, $C_a \geq C_i + C_{cable}$, $L_a \geq L_i + L_{cable}$.
2. Dust-tight conduit seal must be used when installed in Zone 20, Zone 21, and Zone 22 environments or where Ingress Protection of IP67 is required.
3. Control equipment connected to barrier must not use or generate more than 250 Vrms or Vdc.
4. Installation should be in accordance with appropriate local code or practice.
5. The configuration of associated apparatus for each sensor wiring pair or solenoid wiring pair must be approved.
6. Associated apparatus manufacturer's installation drawing must be followed when installing this equipment.
7. To maintain intrinsic safety, wiring associated with each sensor or solenoid coil wiring must be run in separate cables or separate shields connected to intrinsically safe (associated apparatus) ground.
8. Conduit Grounding - Upon installation verify electrical continuity between conduit and ground terminal.
9. Resistance between Intrinsic Safe Ground and earth ground must be less than one ohm.
10. Parts of the enclosure are non-conducting and may generate an ignition-capable level of electrostatic charge under certain extreme conditions. The user should ensure that the equipment is not installed in location where it may be subjected to external conditions (such as high-pressure steam) which might cause a build-up of electrostatic charge on non-conducting surfaces. Additionally, cleaning of the equipment should only be done with a damp cloth.
11. Substitution of components may impair hazardous location safety.