

THINKSIMPLE. THINKSMART.

THINKQUALITY.

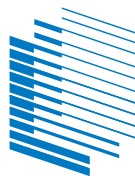
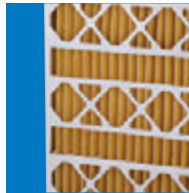
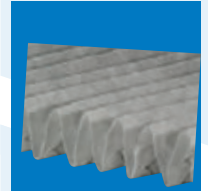
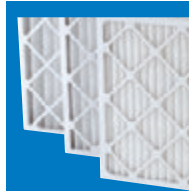

QUALITYFILTERS, INC.

THINKSIMPLE. THINKSMART. THINKQUALITY.

2018 PRODUCTCATALOG



QUALITYFILTERS, INC.

THINK**SIMPLE**. THINK**SMART**. THINK**QUALITY**.

23351 GRISSOM DRIVE
ROBERTSDALE, AL 36567

PHONE: 251.947.2400
FACSIMILE: 251.947.2499



HAVE A QUESTION? CALL OR VISIT US ONLINE.

800.635.6820 | QUALITYFILTERS.COM

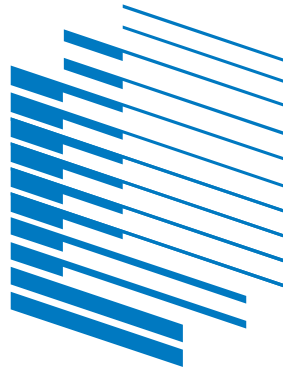

QUALITYFILTERS, INC.
THINK**SIMPLE.** THINK**SMART.** THINK**QUALITY.**

5

GENERAL INFORMATION WELCOME TO QUALITY FILTERS, INC.
 AN ENDURING COMMITMENT
 VISION STATEMENT
 A PLEDGE OF QUALITY

6-7

QUALITYPLEATS
PLEATED PANEL FILTERS

Quality Pleats pleated media greatly extends the filtering surface area to reduce pressure drop, extend service life, and increase efficiency, thus reducing energy costs and HVAC system maintenance. Quality Pleats are offered in MERV 8 and 10 EQP and DQP, MERV 11 MQP, MERV 13 GQP, and Odor Ban carbon synthetic media which will not support microbial growth.

8-9

MERV 8
EQP and DQP

10

MERV 11
MQP

11-13

MERV 13
GQP

14-16

MERV 8
Odor Ban



17-24

ENVAERO™
RESIDENTIAL PLEATED FILTERS

Envaero™ 3" to 6" deep pleated filters are specifically designed to retrofit existing residential ducted air filter housings. We have an extensive list of the most common name-brand filter replacements. Envaero™ filters are pre-assembled for easy installation and offer the same MERV 8, MERV 11, MERV 13, and Odor Ban carbon synthetic media as Quality Pleats.



MERV 8
Odor Ban

MERV 11

MERV 13

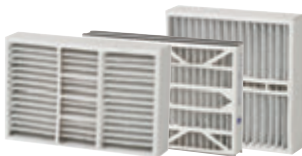

25-26

QUALITYINSERTS
PLEATED MEDIA INSERTS AND BULK ROLLS

Quality Inserts are an economical way to obtain the high efficiency and lower pressure drop benefits of Quality Pleats with less cost. Quality Inserts are typically used as a replaceable media in permanent holding frames. The Type 40 inserts are made with the same media used in our EQP and DQP Pleated Panel Filters.

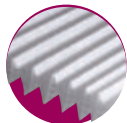

MERV 8
Inserts and
Bulk Rolls



QUALITYFLOW

HIGH EFFICIENCY RIGID CELL FILTERS

The 4" deep QualityFlow can't be beat when you combine price, energy savings, as well as shipping and storage savings. The Ultra compact 4" deep QualityFlow is the all-in-one "Super Tool" of air filters. A 4" deep QualityFlow replaces virtually every type of 12" or 6" deep rigid filter at a lower price and with better performance. Save space, reduce inventory, and make filter changes two-thirds easier with the 4" QualityFlow. Available in MERV 11 and 13 efficiencies.



4" QualityFlow available with and without header

27-29

QUALITYFLOW EXTREME

HIGH EFFICIENCY RIGID CELL FILTERS

QualityFlow EXTREME filters last twice as long as typical 12" rigid filters and have 45% lower pressure drop. The benefit is tremendous energy savings and lower product cost over time. Landfill and labor savings are also a benefit. QualityFlow EXTREME filters are similar in construction to our 12" and 6" deep Quality Cell filters, yet they have the extreme performance QualityFlow media that makes the difference. QualityFlow EXTREME filters are perfect for LEED "Green" applications or to replace any 12" or 6" deep rigid filter or "V" bank filter. Available in MERV 13 and 14 efficiencies.

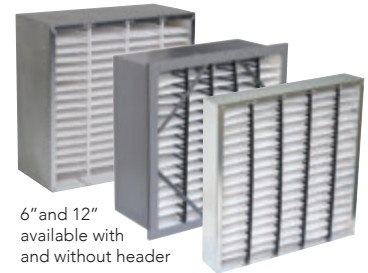

6" and 12" available with and without header

30-32

QUALITYCELL

SYNTHETIC RIGID CELL FILTERS

The Quality Cell is specifically designed for Variable Air Velocity systems and turbulent air. Plastic finger pleat separators are locked into the frame to ensure media pack stabilization throughout the service life of the filter. Quality Cells are available in MERV 12 through 15. Quality Cell filters are available in galvanized metal frames from 5" up to 12" depths. Molded plastic frames in 12" depth are available for standard sizes. For a high performance alternative, check out the QualityFlow rigid filters.

SYNTHETIC RIGID CELL FILTERS

The Quality Cell Fiberglass filters are available in MERV 11, 14 and 15 and are manufactured to the same Quality standards using Fiberglass media instead of Synthetic.

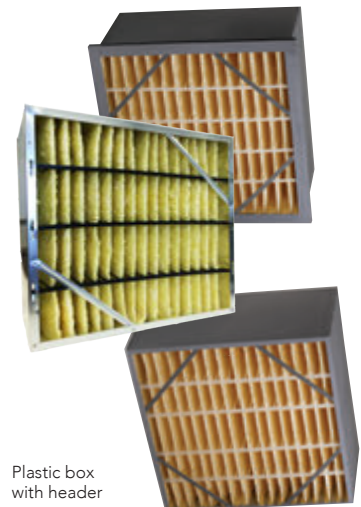

Plastic box with header

Plastic box without header

33-36

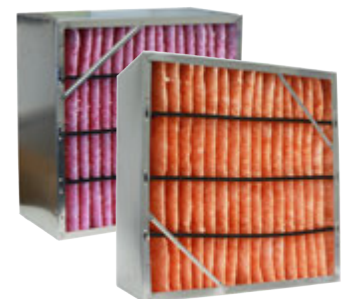

The Quality Max is a versatile air filter. Quality Max is a loaded media filter that provides high efficiency performance in turbulent environments as well as, more stable operating conditions. With tight pleat consistency, Quality Max offers lower air flow resistance and longer filter life than the average commercial filter. This easy to handle filter performs with low energy usage, while reducing energy costs.



- Available in 4" Single header plastic polypropylene style frame.
- 2" and 4" non-header configuration available in beverage board, plastic or 26 gauge galvanized metal frame.
-
- **MERV 14 and MERV 11** rated per ASHRAE test standard 52.2.
- Bead separators are moisture resistant adding versatility to the filters applications.
- Using Quality Max filters may also help you qualify for LEED® credit under the LEED-EB program.

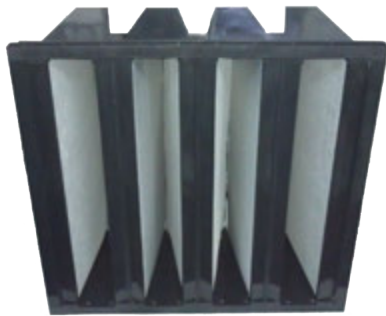

- Available in 4V plastic construction.
- Available in header only.
- MERV 14 per ASHRAE test standard 52.2.
- Bead separators are moisture resistant adding versatility to the filters applications.
- Designed to retrofit existing residential ducted air filter housings.
- Using Quality Max filters may also help you qualify for LEED® credit under the LEED-E8 program .

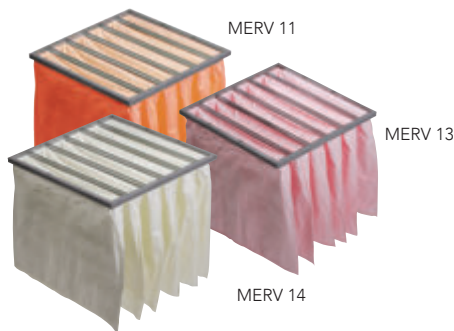

**QUALITYPAK
SYNTHETIC BAG FILTERS**

Quality Pak multi-pocket bag filters offer an economical solution for high efficiency filtration requirements. The synthetic media is glued inside the frame to prevent bypass and blowout. Quality Pak filters are available in MERV 11, 13, and 14.

WELCOME TO QUALITY FILTERS, INC. →

AN ENDURING COMMITMENT

Since 1984, the father-son team of Horace & George Spottswood began the journey of transforming Quality Filters, Inc. from a small filter fabricator with local distribution to a full line manufacturer of HVAC air filters with international distribution. George continues to lead QFI toward our goal of being the manufacturer of choice in the HVAC filtration industry through a sustained focus on world class innovation of products and services.

Our greatest assets are our people who are creative problem-solvers who understand the current and future needs of our industry and create products to meet those challenges.



VISION™

Value individuals, sustain improvement. outperform needs.

QUALITY POLICY

Quality Filters, Inc. will service customers through 'VISIONary' LEAN manufacturing practices and quality assurances. Our management team is committed to complying with the requirements and continually improving the effectiveness of the quality management system.

BETTER PEOPLE, SUPERIOR PRODUCTS

Through providing continual growth opportunities for our QFI associates, we will encourage an atmosphere of excellence. This extends not only to the creation of superior products, but also to our ability to better respond to our customers.

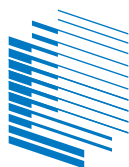

QUALITY FILTERS, INC.

THINKSIMPLE. THINKSMART. THINKQUALITY.

23351 Grissom Drive
Robertsdale, Alabama 36567
800-635-6820

THINKSIMPLE. THINKSMART. THINKQUALITY.

THINKQUALITY.

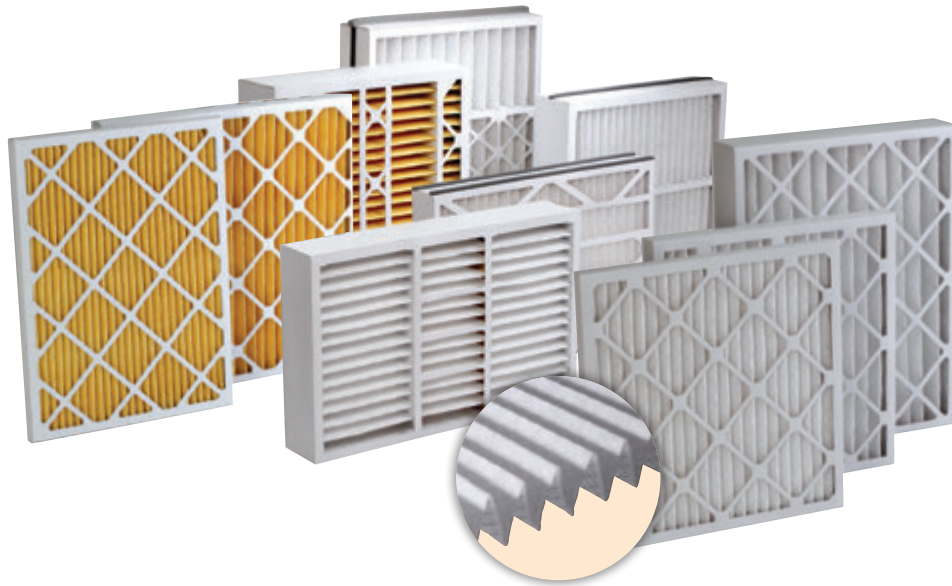

QUALITYFILTERS, INC.
THINKSIMPLE. THINKSMART. THINKQUALITY.

23351 GRISSOM DRIVE
ROBERTSDALE, AL 36567

PHONE: 251.947.2400
FACSIMILE: 251.947.2499
TOLL FREE: 800.635.6820
QUALITYFILTERS.COM



QUALITYPLEATS

LONGER LIFE, LOWER COSTS

LONGER LIFE, LOWER COSTS

Higher Filtration Efficiency

THINK QUALITY.

QUALITY PLEATED FILTERS

Quality Pleats extended surface pleated filters from Quality Filters outperform ordinary furnace filters with medium efficiency and are designed for lower pressure drop, and long service life which reduces HVAC equipment maintenance and energy costs.

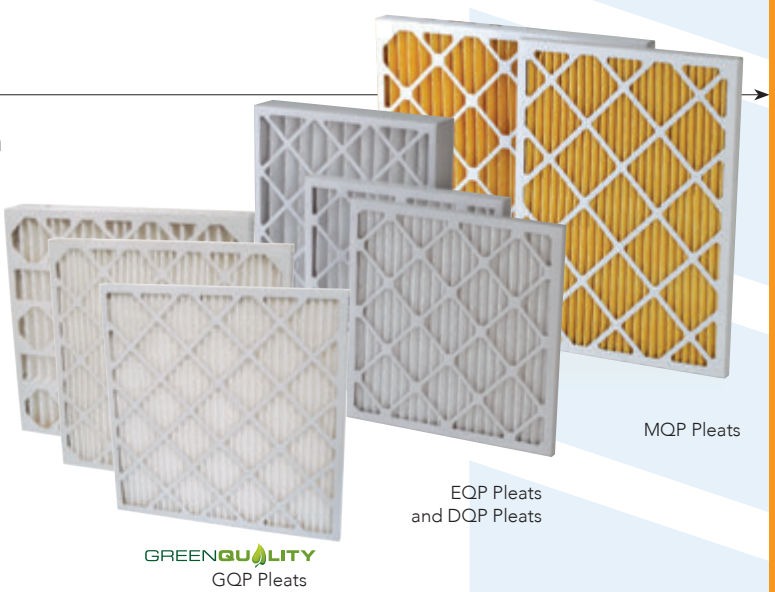

FEATURES

- Standard and high capacity pleated filters.
- Consists of 100% polyester media and 100% synthetic thermally bonded fibers with no chemical binders.
- Captures more dust than standard pads or panel type filters creating a healthier environment.
- Protects HVAC equipment from the effects of dirty air and reduces costly building maintenance.
- Can last up to four times the life of standard pads or panel type filters and extends life of more expensive secondary filters.
- **MERV 8, MERV 11, and MERV 13** rated per ASHRAE test standard 52.2.

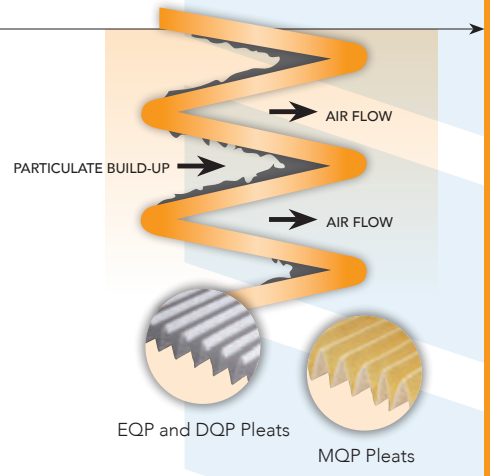

ENVAERO® Ducted Air Filters

- Residential air cleaner filter designed to fit existing ducted air filter housings.
- Pre-assembled for easy installation.
- 5" depth and closed pleats minimize pressure drop and extend filter life six months to one year.

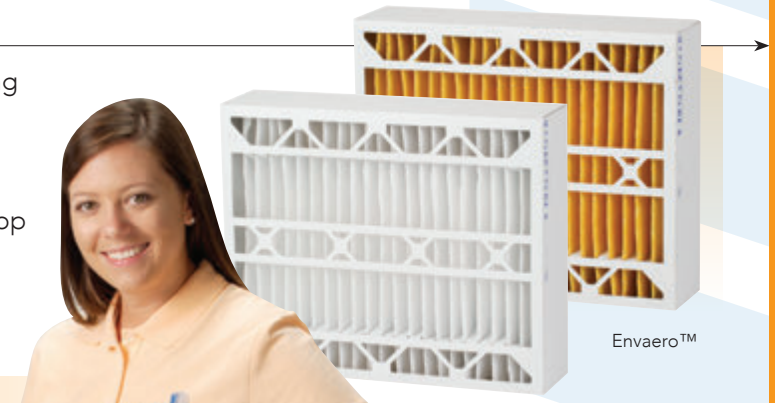

HAVE A QUESTION? CALL US.

800.635.6820

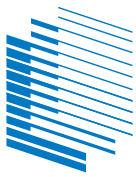

QUALITY FILTERS, INC.

THINKSIMPLE. THINKSMART. THINKQUALITY.

23351 Grissom Drive
 Robertsdale, AL 36567
 www.QualityFilters.com

Phone: (251) 947-2400
 Order Fax: (251) 947-2499
 Sales Fax: (251) 947-7948

Quality EQP40 Pleated Filters			
Date 04 Feb 16	1"	Dwg No. Q-110011	Rev K
Date 20 Jan 16	2"		
Date 30 May 17	4"		

Part Number Guide

Product Code	Nominal Size w x h x d	Actual Size w x h x d	Flow Rate cfm	Media Sq.Feet
EQP4010101	10x10x1	9.5x9.5x.75	205	1.3
EQP4010161	10x16x1	9.875x15.875x.75	328	2.1
EQP4010201	10x20x1	9.5x19.5x.75	410	2.5
EQP4010241	10x24x1	9.5x23.5x.75	492	3.2
EQP4010251	10x25x1	9.5x24.5x.75	512	3.3
EQP4010301	10x30x1	9.5x29.5x.75	615	4
EQP4012121	12x12x1	11.75x11.75x.75	295	1.8
EQP4012151	12x15x1	11.5x14.5x.75	369	2.4
EQP4012161	12x16x1	11.5x15.5x.75	393	2.6
EQP4012181	12x18x1	11.5x17.5x.75	443	2.9
EQP4012201	12x20x1	11.8125x19.8125x.75	492	3.1
EQP4012221	12x22x1	11.5x21.5x.75	541	3.5
EQP4012241	12x24x1	11.5x23.5x.75	590	3.7
EQP4012251	12x25x1	11.5x24.5x.75	615	4
EQP4012301	12x30x1	11.5x29.5x.75	738	4.8
EQP4012361	12x36x1	11.875x35.875x.75	885	5.8
EQP4014141	14x14x1	13.5x13.5x.75	402	2.6
EQP4014181	14x18x1	13.5x17.5x.75	516	3.4
EQP4014201	14x20x1	13.5x19.5x.75	575	3.6
EQP4014241	14x24x1	13.875x23.875x.75	688	4.4
EQP4014251	14x25x1	13.5x24.5x.75	718	4.5
EQP4014301	14x30x1	13.9375x29.9375x.75	860	5.6
EQP4015201	15x20x1	14.5625x19.5625x.75	615	3.9
EQP4015251	15x25x1	14.5x24.5x.75	768	5
EQP4015301	15x30x1	14.5x29.5x.75	922	6
EQP4016161	16x16x1	15.75x15.75x.75	524	3.4
EQP4016181	16x18x1	15.5x17.5x.75	590	3.9
EQP4016201	16x20x1	15.5625x19.5625x.75	654	4.1
EQP4016241	16x24x1	15.5x23.5x.75	787	5.1
EQP4016251	16x25x1	15.5625x24.5625x.75	836	5.2
EQP4016301	16x30x1	15.5x29.5x.75	983	6.4
EQP4016321	16x32x1	15.8125x31.8125x.75	1048	6.8
EQP4018181	18x18x1	17.75x17.75x.75	664	4.3
EQP4018201	18x20x1	17.5x19.5x.75	738	4.8
EQP4018221	18x22x1	17.5x21.5x.75	811	5.3
EQP4018241	18x24x1	17.5x23.5x.75	885	5.6
EQP4018251	18x25x1	17.5x24.5x.75	934	5.8
EQP4018301	18x30x1	17.5x29.5x.75	1106	7.2
EQP4020201	20x20x1	19.5625x19.5625x.75	836	5.2
EQP4020221	20x22x1	19.5625x21.5x.75	901	5.9
EQP4020241	20x24x1	19.5x23.5x.75	983	6.2
EQP4020251	20x25x1	19.5625x24.5625x.75	1032	6.5
EQP4020301	20x30x1	19.625x29.625x.75	1229	7.9
EQP4022221	22x22x1	21.9375x21.9375x.75	992	6.5
EQP4024241	24x24x1	23.75x23.75x.75	1180	7.5
EQP4024301	24x30x1	23.5x29.5x.75	1475	9.6
EQP4025251	25x25x1	24.5x24.5x.75	1278	8.1
EQP4010202	10x20x2	9.5x19.5x1.75	688	4
EQP4012122	12x12x2	11.875x11.875x1.6875	492	3
EQP4012202	12x20x2	11.5x19.5x1.75	836	5
EQP4012242	12x24x2	11.375x23.375x1.75	983	6
EQP4012252	12x25x2	11.5x24.5x1.75	1032	6.3
EQP4014202	14x20x2	13.5625x19.5625x1.75	959	6
EQP4014252	14x25x2	13.5x24.5x1.75	1195	7.5
EQP4015202	15x20x2	14.5625x19.5625x1.75	1023	6.5
EQP4016162	16x16x2	15.5x15.5x1.75	875	5.4
EQP4016202	16x20x2	15.625x19.625x1.75	1082	6.5
EQP4016242	16x24x2	15.375x23.375x1.75	1311	8.6
EQP4016252	16x25x2	15.625x24.625x1.75	1377	8.1
EQP4018182	18x18x2	17.75x17.75x1.75	1106	7.3
EQP4018202	18x20x2	17.5x19.5x1.75	1229	7.6
EQP4018242	18x24x2	17.375x23.375x1.75	1475	9
EQP4018252	18x25x2	17.5x24.5x1.75	1524	9.4
EQP4020202	20x20x2	19.5625x19.5625x1.6875	1377	8.5
EQP4020242	20x24x2	19.375x23.375x1.75	1637	10.2
EQP4020252	20x25x2	19.5625x24.5625x1.6875	1721	10.6
EQP4020302	20x30x2	19.5x29.5x1.75	2048	13.5
EQP4022222	22x22x2	21.9375x21.9375x1.75	1654	10.2
EQP4024242	24x24x2	23.375x23.375x1.6875	1967	12
EQP4024302	24x30x2	23.5x29.5x1.75	2458	14.5
EQP4025252	25x25x2	24.5x24.5x1.75	2124	13.1
EQP4025282	25x28x2	24.5x27.5x1.75	2360	14.4
EQP4012244	12x24x4	11.4375x23.4375x3.625	983	9.5
EQP4016204	16x20x4	15.5x19.5x3.625	1082	10.5
EQP4016254	16x25x4	15.625x24.625x3.625	1377	13.6
EQP4018244	18x24x4	17.5x23.5x3.625	1475	14.2
EQP4020204	20x20x4	19.5x19.5x3.625	1377	12.8
EQP4020244	20x24x4	19.4375x23.4375x3.625	1622	15.4
EQP4020254	20x25x4	19.5x24.5x3.625	1721	16
EQP4024244	24x24x4	23.375x23.375x3.625	1967	18.9
EQP4025294	25x29x4	24.5x28.5x3.625	2458	24.3

Pleats per linear foot 1" depth = 14, 2" depth = 10, 4" depth = 8.

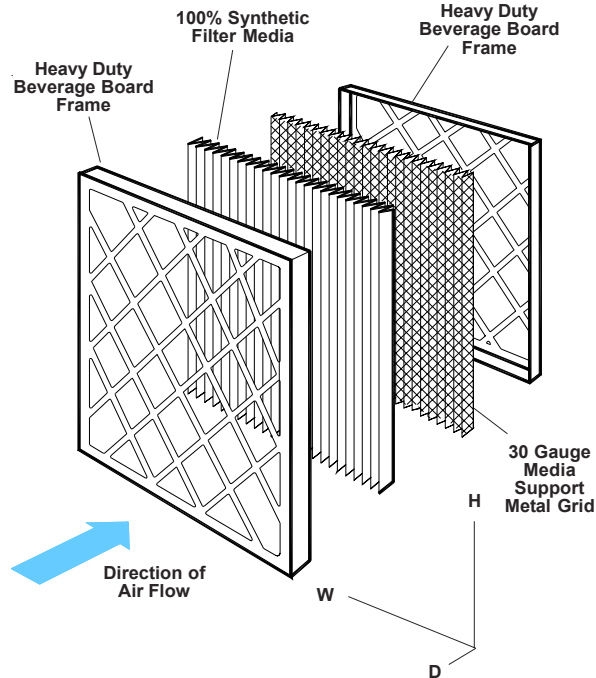

Notes:

EQP40 Pleated Filters are available in 1", 2" and 4" depth. The 100% synthetic graduated density media is continuously bonded to a 30 gauge galvanized, corrosion resistant, expanded metal support grid with an effective open area of 96%. The media is resistant to a wide range of chemicals, does not absorb moisture and will not support microbial growth.

The controlled pleat spacing maximizes surface area and dust holding capacity and is bonded to the enclosure frame to prevent dust bypass.

The enclosure frame is constructed of high wet strength moisture resistant beverage board. The diagonal support members of the frame are bonded to the entering and exiting apices of each pleat to prevent pleat collapse and filter bowing.

Performance Data 24x24

@ rated flow see chart

Product Code	ASHRAE 52.2			Initial Resistance	Final Resistance	
	MERV Value	E1 %	E2 %			E3 %
EQP40 - 1"	8	1.9	29.9	70.6	0.122	1.0
EQP40 - 2"	10	6.9	52.7	82	0.28	1.5
EQP40 - 4"	10	20.7	62.6	81.5	0.203	1.5

Characteristics

EQP40 Pleated Filters

Filter Media	100% synthetic gradient media
Filter Support Grid	30 gauge galvanized expanded metal grid
Frame	Moisture resistant double wall beverage board
Assembly Technique	Media pack totally bonded to frame
Max. Temperature	180°F (82°C) continuous service, Peaks 225°F (107°C)
Max. Humidity	Resistant to 100% R.H.
Flammability	U.L. 900

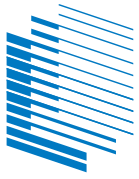

QUALITY FILTERS, INC.

THINKSIMPLE. THINKSMART. THINKQUALITY.

23351 Grissom Drive
 Robertsdale, AL 36567
 www.QualityFilters.com

Phone: (251) 947-2400
 Order Fax: (251) 947-2499
 Sales Fax: (251) 947-7948

Quality DQP40 Pleated Filters			
Date	2/14/18	1"	Dwg No. Q-110013
Date	2/13/18	2"	
Date	10/24/16	4"	

Part Number Guide

Product Code	Nominal Size w x h x d	Actual Size w x h x d	Flow Rate cfm	Media Sq. Feet
DQP4010101	10x10x1	9.5x9.5x.75	205	1.4
DQP4010161	10x16x1	9.875x15.875x.75	328	2.4
DQP4010201	10x20x1	9.5x19.5x.75	410	3
DQP4010241	10x24x1	9.5x23.5x.75	492	3.7
DQP4010251	10x25x1	9.5x24.5x.75	512	3.8
DQP4010301	10x30x1	9.5x29.5x.75	615	4.6
DQP4012121	12x12x1	11.75x11.75x.75	295	2
DQP4012151	12x15x1	11.5x14.5x.75	369	2.8
DQP4012161	12x16x1	11.5x15.5x.75	393	2.9
DQP4012181	12x18x1	11.5x17.5x.75	443	3.3
DQP4012201	12x20x1	11.8125x19.8125x.75	492	3.6
DQP4012221	12x22x1	11.5x21.5x.75	541	4
DQP4012241	12x24x1	11.5x23.5x.75	590	4.3
DQP4012251	12x25x1	11.5x24.5x.75	615	4.6
DQP4012301	12x30x1	11.5x29.5x.75	738	5.5
DQP4012361	12x36x1	11.875x35.875x.75	885	6.6
DQP4014141	14x14x1	13.5x13.5x.75	402	3
DQP4014181	14x18x1	13.5x17.5x.75	516	3.9
DQP4014201	14x20x1	13.5x19.5x.75	575	4.1
DQP4014241	14x24x1	13.875x23.875x.75	688	5.1
DQP4014251	14x25x1	13.5x24.5x.75	718	5.2
DQP4014301	14x30x1	13.9375x29.9375x.75	860	6.4
DQP4015201	15x20x1	14.5625x19.5625x.75	615	4.4
DQP4015251	15x25x1	14.5x24.5x.75	768	5.7
DQP4015301	15x30x1	14.5x29.5x.75	922	6.9
DQP4016161	16x16x1	15.75x15.75x.75	524	3.9
DQP4016181	16x18x1	15.5x17.5x.75	590	4.4
DQP4016201	16x20x1	15.5625x19.5625x.75	654	4.7
DQP4016241	16x24x1	15.5x23.5x.75	787	5.8
DQP4016251	16x25x1	15.5625x24.5625x.75	836	5.9
DQP4016301	16x30x1	15.5x29.5x.75	983	7.3
DQP4016321	16x32x1	15.8125x31.8125x.75	1048	7.6
DQP4018181	18x18x1	17.75x17.75x.75	664	5
DQP4018201	18x20x1	17.5x19.5x.75	738	5.5
DQP4018221	18x22x1	17.5x21.5x.75	811	6.1
DQP4018241	18x24x1	17.5x23.5x.75	885	6.4
DQP4018251	18x25x1	17.5x24.5x.75	934	6.7
DQP4018301	18x30x1	17.5x29.5x.75	1106	8.3
DQP4020201	20x20x1	19.5625x19.5625x.75	836	5.9
DQP4020221	20x22x1	19.5x21.5x.75	901	6.7
DQP4020241	20x24x1	19.5x23.5x.75	983	7.1
DQP4020251	20x25x1	19.5625x24.5625x.75	1032	7.4
DQP4020301	20x30x1	19.625x29.625x.75	1229	9
DQP4022221	22x22x1	21.9375x21.9375x.75	992	7.4
DQP4024241	24x24x1	23.75x23.75x.75	1180	8.5
DQP4024301	24x30x1	23.5x29.5x.75	1475	11
DQP4025251	25x25x1	24.5x24.5x.75	1278	9.2
DQP4010202	10x20x2	9.5x19.5x1.75	688	5.9
DQP4012122	12x12x2	11.875x11.875x1.6875	492	4.6
DQP4012202	12x20x2	11.5x19.5x1.75	836	7.4
DQP4012242	12x24x2	11.375x23.375x1.75	983	8.9
DQP4012252	12x25x2	11.5x24.5x1.75	1032	9.3
DQP4014202	14x20x2	3.5625x19.5625x1.75	959	8.9
DQP4014252	14x25x2	13.5x24.5x1.75	1195	11.1
DQP4015202	15x20x2	14.5625x19.5625x1.75	1023	9.6
DQP4016162	16x16x2	15.5x15.5x1.75	875	8.1
DQP4016202	16x20x2	15.625x19.625x1.75	1082	9.7
DQP4016242	16x24x2	15.375x23.375x1.75	1311	12.7
DQP4016252	16x25x2	15.625x24.625x1.75	1377	12
DQP4018182	18x18x2	17.75x17.75x1.75	1106	10.6
DQP4018202	18x20x2	17.5x19.5x1.75	1229	11.4
DQP4018242	18x24x2	17.375x23.375x1.75	1475	13.7
DQP4018252	18x25x2	17.5x24.5x1.75	1524	13.9
DQP4020202	20x20x2	19.5625x19.5625x1.6875	1377	12.6
DQP4020242	20x24x2	19.375x23.375x1.75	1637	15.1
DQP4020252	20x25x2	19.5625x24.5625x1.6875	1721	15.7
DQP4020302	20x30x2	19.5x29.5x1.75	2048	20
DQP4022222	22x22x2	21.9375x21.9375x1.75	1654	15.3
DQP4024242	24x24x2	23.375x23.375x1.6875	1967	17.8
DQP4024302	24x30x2	23.5x29.5x1.75	2458	21.6
DQP4025252	25x25x2	24.5x24.5x1.75	2124	19.4
DQP4025282	25x28x2	24.5x27.5x1.75	2360	21
DQP4012244	12x24x4	11.4375x23.4375x3.625	983	14.2
DQP4016204	16x20x4	15.5x19.5x3.625	1082	15.7
DQP4016254	16x25x4	15.625x24.625x3.625	1377	19.7
DQP4018244	18x24x4	17.5x23.5x3.625	1475	21.3
DQP4020204	20x20x4	19.5x19.5x3.625	1377	19.7
DQP4020244	20x24x4	19.4375x23.4375x3.625	1622	23.7
DQP4020254	20x25x4	19.5x24.5x3.625	1721	24.7
DQP4024244	24x24x4	23.375x23.375x3.625	1967	28.4
DQP4025294	25x29x4	24.5x28.5x3.625	2458	35.7

Pleats per linear foot 1" depth = 16, 2" depth = 15, 4" depth = 11.

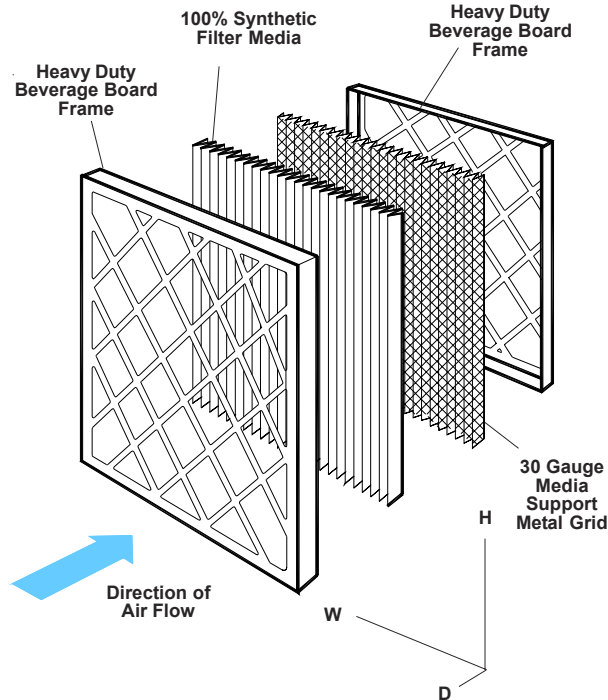

Notes:

DQP40 Pleated Filters are available in 1", 2" and 4" depth. The 100% synthetic graduated density media is continuously bonded to a 30 gauge galvanized, corrosion resistant, expanded metal support grid with an effective open area of 96%. The media is resistant to a wide range of chemicals, does not absorb moisture and will not support microbial growth.

The controlled pleat spacing maximizes surface area and dust holding capacity and is bonded to the enclosure frame to prevent dust bypass.

The enclosure frame is constructed of high wet strength moisture resistant beverage board. The diagonal support members of the frame are bonded to the entering and exiting apexes of each pleat to prevent pleat collapse and filter bowing.

Performance Data 24x24

Product Code	ASHRAE 52.2				Initial Resistance	Final Resistance
	MERV Value	E1 %	E2 %	E3 %	@ rated flow see chart	@ rated flow see chart
DQP40 - 1"	9	20.5	59.2	75.1	0.159	1.00
DQP40 - 2"	10	23.5	65.1	80.1	0.246	1.50
DQP40 - 4"	10	24.6	61.6	83.0	0.190	1.50

Characteristics DQP40 Pleated Filters

Filter Media	100% synthetic gradient media
Filter Support Grid	30 gauge galvanized expanded metal grid
Frame	Moisture resistant double wall beverage board
Assembly Technique	Media pack totally bonded to frame
Max. Temperature	180°F (82°C) continuous service, Peaks 225°F (107°C)
Max. Humidity	Resistant to 100% R.H.
Flammability	U.L. 900

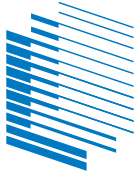

QUALITY FILTERS, INC.

THINKSIMPLE. THINKSMART. THINKQUALITY.

23351 Grissom Drive
 Robertsdale, AL 36657
 www.QualityFilters.com

Phone: (251) 947-2400
 Order Fax: (251) 947-2499
 Sales Fax: (251) 947-7948

Quality MQP Pleated Filters

Date 31 May 17	1"	Dwg No. Q-110012	Rev K
Date 24 Oct 16	2"		
Date 30 May 17	4"		

Part Number Guide

Product Code	Nominal Size w x h x d	Actual Size w x h x d	Flow Rate cfm	Media Sq. Feet
MQP10101	10x10x1	9.5x9.5x.75	205	1.7
MQP10161	10x16x1	9.875x15.875x.75	328	2.8
MQP10201	10x20x1	9.5x19.5x.75	410	3.4
MQP10241	10x24x1	9.5x23.5x.75	492	4.1
MQP10251	10x25x1	9.5x24.5x.75	512	4.3
MQP10301	10x30x1	9.5x29.5x.75	615	5.2
MQP12121	12x12x1	11.75x11.75x.75	295	2.5
MQP12151	12x15x1	11.5x14.5x.75	369	3.1
MQP12161	12x16x1	11.5x15.5x.75	393	3.3
MQP12181	12x18x1	11.5x17.5x.75	443	3.7
MQP12201	12x20x1	11.875x19.875x.75	492	4.1
MQP12221	12x22x1	11.5x21.5x.75	541	4.5
MQP12241	12x24x1	11.5x23.5x.75	590	4.8
MQP12251	12x25x1	11.5x24.5x.75	615	5.1
MQP12301	12x30x1	11.5x29.5x.75	738	6.2
MQP14141	14x14x1	13.5x13.5x.75	402	3.4
MQP14181	14x18x1	13.5x17.5x.75	516	4.2
MQP14201	14x20x1	13.5x19.5x.75	575	4.6
MQP14241	14x24x1	13.875x23.875x.75	688	5.8
MQP14251	14x25x1	13.5x24.5x.75	718	5.9
MQP14301	14x30x1	13.9375x29.9375x.75	860	7.2
MQP15201	15x20x1	14.5625x19.5625x.75	615	5
MQP15251	15x25x1	14.5x24.5x.75	768	6.4
MQP15301	15x30x1	14.5x29.5x.75	922	7.7
MQP16161	16x16x1	15.75x15.75x.75	524	4.4
MQP16181	16x18x1	15.5x17.5x.75	590	5
MQP16201	16x20x1	15.5625x19.5625x.75	654	5.3
MQP16241	16x24x1	15.5x23.5x.75	787	6.5
MQP16251	16x25x1	15.5625x24.5625x.75	836	6.6
MQP16301	16x30x1	15.5x29.5x.75	983	8.3
MQP16321	16x32x1	15.8125x31.8125x.75	1048	8.8
MQP18181	18x18x1	17.5x17.5x.75	664	5.6
MQP18201	18x20x1	17.5x19.5x.75	738	6.2
MQP18221	18x22x1	17.5x21.5x.75	811	6.8
MQP18241	18x24x1	17.5x23.5x.75	885	7.2
MQP18251	18x25x1	17.5x24.5x.75	934	7.5
MQP18301	18x30x1	17.5x29.5x.75	1106	9.3
MQP20201	20x20x1	19.5625x19.5625x.75	836	6.6
MQP20221	20x22x1	19.5x21.5x.75	901	7.6
MQP20241	20x24x1	19.5x23.5x.75	983	8
MQP20251	20x25x1	19.5625x24.5625x.75	1032	8.3
MQP20301	20x30x1	19.625x29.625x.75	1229	10.1
MQP24241	24x24x1	23.75x23.75x.75	1180	9.6
MQP24301	24x30x1	23.5x29.5x.75	1475	9.9
MQP25251	25x25x1	24.5x24.5x.75	1278	10.4
MQP10202	10x20x2	9.5x19.5x1.75	688	5.9
MQP12122	12x12x2	11.875x11.875x1.6875	492	4.6
MQP12202	12x20x2	11.5x19.5x1.75	836	7.4
MQP12242	12x24x2	11.375x23.375x1.75	983	8.9
MQP12252	12x25x2	11.5x24.5x1.75	1032	9.3
MQP14202	14x20x2	13.5625x19.5625x1.75	959	8.9
MQP14252	14x25x2	13.5x24.5x1.75	1195	11.1
MQP15202	15x20x2	14.5625x19.5625x1.75	1023	9.6
MQP16162	16x16x2	15.5x15.5x1.75	875	8.1
MQP16202	16x20x2	15.625x19.625x1.75	1082	9.7
MQP16242	16x24x2	15.375x23.375x1.75	1311	12.7
MQP16252	16x25x2	15.625x24.625x1.75	1377	12
MQP18182	18x18x2	17.75x17.75x1.75	1106	10.6
MQP18202	18x20x2	17.5x19.5x1.75	1229	11.4
MQP18242	18x24x2	17.375x23.375x1.75	1475	13.7
MQP18252	18x25x2	17.5x24.5x1.75	1524	13.9
MQP20202	20x20x2	19.5625x19.5625x1.6875	1377	12.6
MQP20242	20x24x2	19.375x23.375x1.75	1637	15.1
MQP20252	20x25x2	19.5625x24.5625x1.6875	1721	15.7
MQP20302	20x30x2	19.5x29.5x1.75	2048	20
MQP24242	24x24x2	23.375x23.375x1.6875	1967	17.8
MQP24302	24x30x2	23.5x29.5x1.75	2458	21.6
MQP25252	25x25x2	24.5x24.5x1.75	2124	19.4
MQP25282	25x28x2	24.5x27.5x1.75	2360	21
MQP12244	12x24x4	11.4375x23.4375x3.625	983	14.2
MQP16204	16x20x4	15.5x19.5x3.625	1082	15.7
MQP16254	16x25x4	15.625x24.625x3.625	1377	19.7
MQP18244	18x24x4	17.5x23.5x3.625	1475	21.3
MQP20204	20x20x4	19.5x19.5x3.625	1377	19.7
MQP20244	20x24x4	19.4375x23.4375x3.625	1622	23.7
MQP20254	20x25x4	19.5x24.5x3.625	1721	24.7
MQP24244	24x24x4	23.375x23.375x3.625	1967	28.4
MQP25294	25x29x4	24.5x28.5x3.625	2458	35.7

Pleats per linear foot 1" depth = 18, 2" depth = 15, 4" depth = 11.

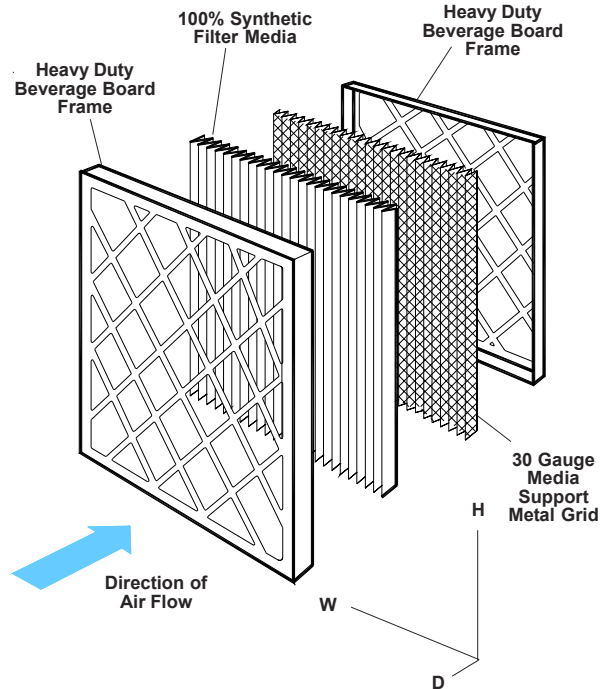

Notes:

MQP Pleated Filters are available in 1", 2" and 4" depth. The 100% synthetic graduated density media is continuously bonded to a 30 gauge galvanized, corrosion resistant, expanded metal support grid with an effective open area of 96%. The media is resistant to a wide range of chemicals, does not absorb moisture and will not support microbial growth.

The controlled pleat spacing maximizes surface area and dust holding capacity and is bonded to the enclosure frame to prevent dust bypass.

The enclosure frame is constructed of high wet strength moisture resistant beverage board. The diagonal support members of the frame are bonded to the entering and exiting apices of each pleat to prevent pleat collapse and filter bowing.

Performance Data 24x24

Product Code	ASHRAE 52.2			Initial Resistance	Final Resistance	
	MERV Value	E1 %	E2 %	@ rated flow see chart	@ rated flow see chart	
MQP- 1"	11	24.6	65.6	87.9	0.181	1.00
MQP- 2"	11	25.4	65.9	86.1	0.236	1.00
MQP- 4"	11	26.3	65.2	87.3	0.213	1.50

Characteristics

MQP Pleated Filters

Filter Media	100% synthetic gradient media
Filter Support Grid	30 gauge galvanized expanded metal grid
Frame	Moisture resistant double wall beverage board
Assembly Technique	Media pack totally bonded to frame
Max. Temperature	180°F (82°C) continuous service, Peaks 225°F (107°C)
Max. Humidity	Resistant to 100% R.H.
Flammability	U.L. 900

THINKSIMPLE. THINKSMART

THINKQUALITY.

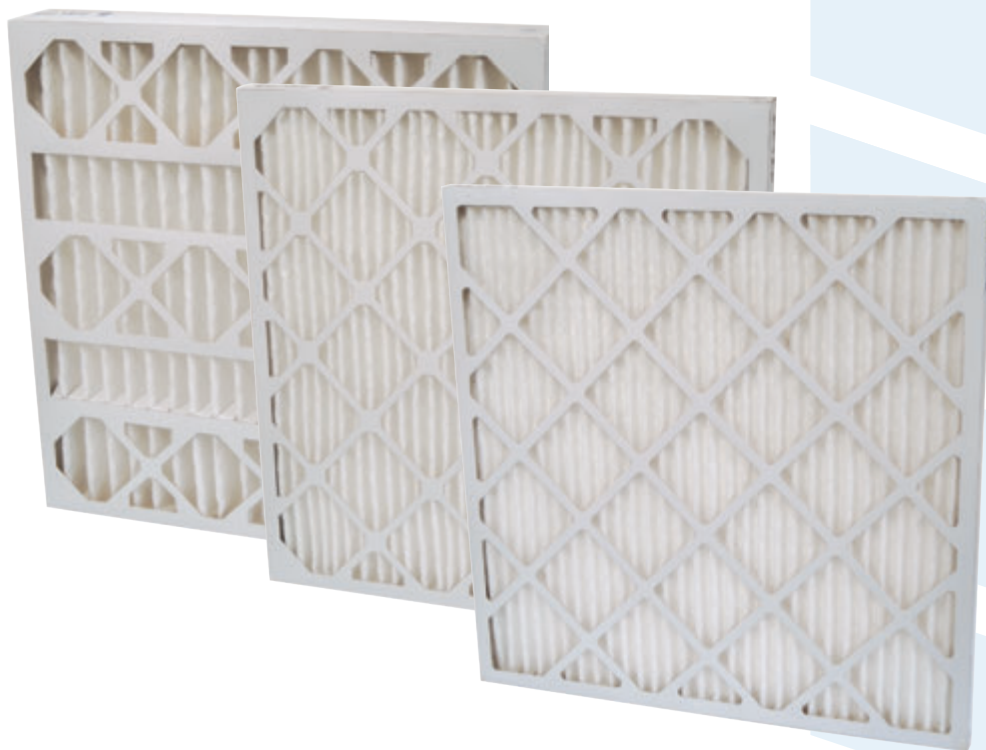

QUALITYFILTERS, INC.
THINKSIMPLE. THINKSMART. THINKQUALITY.

23351 GRISSOM DRIVE
ROBERTSDALE, AL 36567

PHONE: 251.947.2400
FACSIMILE: 251.947.2499
TOLL FREE: 800.635.6820
QUALITYFILTERS.COM



GQP-PLEAT
MERV 13 PLEATED PANEL FILTER

GREENQUALITY
Find out more about our "GREEN"
products when you visit qualityfilters.com

MERV 13 PLEATED PANEL FILTER

OPTIMIZED FOR LEED COMPLIANCE

THINKQUALITY.

GQP-PLEAT

Achieve **MERV 13** rating with our "Green Quality Pleat" (GQP). Our GQP is a cost effective means of upgrading your air quality, while maintaining low pressure drop and long service life.

ADVANTAGES:

- Meets "LEED" standards for new and existing buildings.
- All the benefits of the pre-filter and final filter in one compact design.
- Simple easy upgrade for existing equipment.
- Cost effective design helps maintain user budgets.
- Available in all 1", 2", 4" depths and 5" whole house filters – non-standard sizes available.
- High capacity design increases service life – minimizes maintenance and disposal cost
- Synthetic media does not support microbial growth.

1" MERV 13

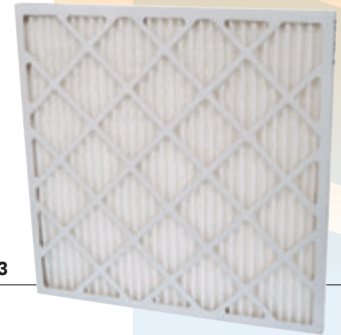

2" MERV 13



GREENQUALITY FEATURES:

- Durable lightweight construction offers easy disposal.
- Minimal impact on energy resulting from low pressure drop.
- Longer service life – reduces waste stream impact.

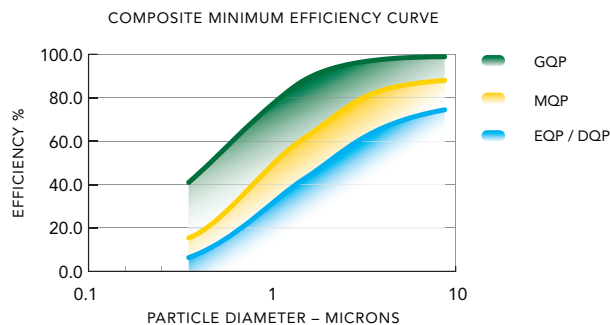

4" MERV 13



HAVE A QUESTION? CALL US.

800.635.6820



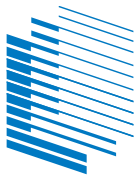

QUALITYFILTERS, INC.

THINKSIMPLE. THINKSMART. THINKQUALITY.

23351 Grissom Drive
 Robertsdale, AL 36567
 www.QualityFilters.com

Phone: (251) 947-2400
 Order Fax: (251) 947-2499
 Sales Fax: (251) 947-7948

Quality GQP Pleated Filters			
Date 26 May 17	1"	Dwg No.	Rev
Date 17 Feb 16	2"	Q-110039	G
Date 30 May 17	4"		

Part Number Guide

Product Code	Nominal Size w x h x d	Actual Size w x h x d	Flow Rate cfm	Media Sq. Feet
GQP10101	10x10x1	9.5x9.5x.75	205	1.7
GQP10161	10x16x1	9.875x15.875x.75	328	2.8
GQP10201	10x20x1	9.5x19.5x.75	410	3.4
GQP10241	10x24x1	9.5x23.5x.75	492	4.1
GQP10251	10x25x1	9.5x24.5x.75	512	4.3
GQP10301	10x30x1	9.5x29.5x.75	615	5.2
GQP12121	12x12x1	11.75x11.75x.75	295	2.5
GQP12151	12x15x1	11.5x14.5x.75	369	3.1
GQP12161	12x16x1	11.5x15.5x.75	393	3.3
GQP12181	12x18x1	11.5x17.5x.75	443	3.7
GQP12201	12x20x1	11.8125x19.8125x.75	492	4.1
GQP12221	12x22x1	11.5x21.5x.75	541	4.5
GQP12241	12x24x1	11.5x23.5x.75	590	4.8
GQP12251	12x25x1	11.5x24.5x.75	615	5.1
GQP12301	12x30x1	11.75x29.5x.75	738	6.2
GQP14141	14x14x1	13.5x13.5x.75	402	3.4
GQP14181	14x18x1	13.5x17.5x.75	516	4.2
GQP14201	14x20x1	13.5x19.5x.75	575	4.6
GQP14241	14x24x1	13.875x23.875x.75	688	5.8
GQP14251	14x25x1	13.5x24.5x.75	718	5.9
GQP14301	14x30x1	13.9375x29.9375x.75	860	7.2
GQP15201	15x20x1	14.5625x19.5625x.75	615	5
GQP15251	15x25x1	14.5x24.5x.75	768	6.4
GQP15301	15x30x1	14.5x29.5x.75	922	7.7
GQP16161	16x16x1	15.75x15.75x.75	524	4.4
GQP16181	16x18x1	15.5x17.5x.75	590	5
GQP16201	16x20x1	15.5x19.5x.75	654	5.3
GQP16241	16x24x1	15.5x23.5x.75	787	6.5
GQP16251	16x25x1	15.5625x24.5625x.75	836	6.6
GQP16301	16x30x1	15.5x29.5x.75	983	8.3
GQP16321	16x32x1	15.8125x31.8125x.75	1048	8.8
GQP18181	18x18x1	17.75x17.75x.75	664	5.6
GQP18201	18x20x1	17.5x19.5x.75	738	6.2
GQP18221	18x22x1	17.5x21.5x.75	811	6.8
GQP18241	18x24x1	17.5x23.5x.75	885	7.2
GQP18251	18x25x1	17.5x24.5x.75	934	7.5
GQP18301	18x30x1	17.5x29.5x.75	1106	9.3
GQP20201	20x20x1	19.5625x19.5625x.75	836	6.6
GQP20221	20x22x1	19.5x21.5x.75	901	7.6
GQP20241	20x24x1	19.5x23.5x.75	983	8
GQP20251	20x25x1	19.5625x24.5625x.75	1032	8.3
GQP20301	20x30x1	19.625x29.625x.75	1229	10.1
GQP24241	24x24x1	23.75x23.75x.75	1180	9.6
GQP24301	24x30x1	23.5x29.5x.75	1475	9.9
GQP25251	25x25x1	24.5x24.5x.75	1278	10.4
GQP10202	10x20x2	9.5x19.5x1.75	688	5.9
GQP12122	12x12x2	11.875x11.875x1.6875	492	4.6
GQP12202	12x20x2	11.5x19.5x1.75	836	7.4
GQP12242	12x24x2	11.375x23.375x1.75	983	8.9
GQP12252	12x25x2	11.5x24.5x1.75	1032	9.3
GQP14202	14x20x2	13.5625x19.5625x1.75	959	8.9
GQP14252	14x25x2	13.5x24.5x1.75	1195	11.1
GQP15202	15x20x2	14.5625x19.5625x1.75	1023	9.6
GQP16162	16x16x2	15.5x15.5x1.75	875	8.1
GQP16202	16x20x2	15.5x19.5x1.75	1082	9.7
GQP16242	16x24x2	15.375x23.375x1.75	1311	12.7
GQP16252	16x25x2	15.625x24.625x1.75	1377	12
GQP18182	18x18x2	17.75x17.75x1.75	1106	10.6
GQP18202	18x20x2	17.5x19.5x1.75	1229	11.4
GQP18242	18x24x2	17.375x23.375x1.75	1475	13.7
GQP18252	18x25x2	17.5x24.5x1.75	1524	13.9
GQP20202	20x20x2	19.5625x19.5625x1.6875	1377	12.6
GQP20242	20x24x2	19.375x23.375x1.75	1637	15.1
GQP20252	20x25x2	19.5625x24.5625x1.6875	1721	15.7
GQP20302	20x30x2	19.5x29.5x1.75	2048	20
GQP24242	24x24x2	23.375x23.375x1.6875	1967	17.8
GQP24302	24x30x2	23.5x29.5x1.75	2458	21.6
GQP25252	25x25x2	24.5x24.5x1.75	2124	19.4
GQP25282	25x28x2	24.5x27.5x1.75	2360	21
GQP12244	12x24x4	11.4375x23.4375x3.625	983	14.2
GQP16204	16x20x4	15.5x19.5x3.625	1082	15.7
GQP16254	16x25x4	15.625x24.625x3.625	1377	19.7
GQP18244	18x24x4	17.5x23.5x3.625	1475	21.3
GQP20204	20x20x4	19.5x19.5x3.625	1377	19.7
GQP20244	20x24x4	19.4375x23.4375x3.625	1622	23.7
GQP20254	20x25x4	19.5x24.5x3.625	1721	24.7
GQP24244	24x24x4	23.375x23.375x3.625	1967	28.4
GQP25294	25x29x4	24.5x28.5x3.625	2458	35.7

Pleats per linear foot 1" depth = 18, 2" depth = 15, 4" depth = 11.

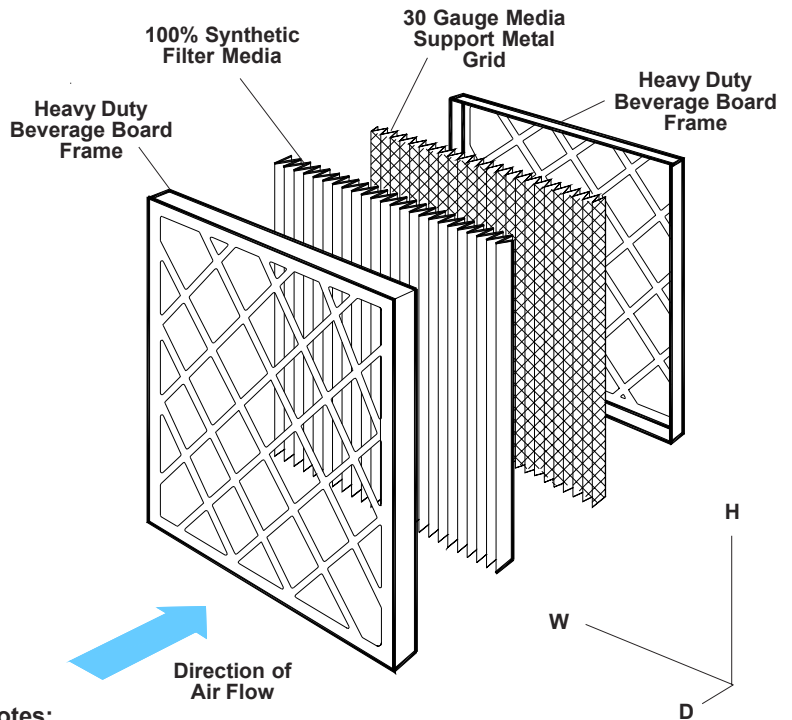

Notes:

GQP "Green" Quality Pleats are ideally suited for the Green Building Council's latest LEED MERV 13 Indoor Air Quality requirements for occupant health. GQP's have the added benefit of low initial cost and don't require any retrofitting to the HVAC system. The GQP Pleated Filters are available in 1", 2" and 4" depth. The 100% synthetic graduated density media is continuously bonded to a 30 gauge galvanized, corrosion resistant, expanded metal support grid with an effective open area of 96%. The media is resistant to a wide range of chemicals, does not absorb moisture and will not support microbial growth. The ultra low pressure drop ensures lower ongoing costs through energy savings.

The controlled pleat spacing maximizes surface area and dust holding capacity and is bonded to the enclosure frame to prevent dust bypass. The high dustloading prolongs filter life, thus reducing labor and landfill costs.

The enclosure frame is constructed of high wet strength moisture resistant beverage board. The diagonal support members of the frame are bonded to the entering and exiting apices of each pleat to prevent pleat collapse and filter bowing.

Performance Data - 24" x 24"

Product Code	ASHRAE 52.2 - 1999				Initial Resistance "w.g. @ Rated Flow See Chart	Final Resistance "w.g.
	MERV Value	E1 %	E2 %	E3 %		
GQP - 1"	13	50.2	85.5	97.2	0.264	1.0
GQP - 2"	13	50.3	85.5	97.3	0.335	1.5
GQP - 4"	13	53.2	86.6	97.8	0.299	1.5

Characteristics

GQP Pleated Filters

Filter Media	100% synthetic gradient media
Filter Support Grid	30 gauge galvanized expanded metal grid
Frame	Moisture resistant double wall beverage board
Assembly Technique	Media pack totally bonded to frame
Max. Temperature	180°F (82°C) continuous service, Peaks 225°F (107°C)
Max. Humidity	Resistant to 100% R.H.
Flammability	U.L. 900

THINKSIMPLE. THINKSMART.

THINKQUALITY.

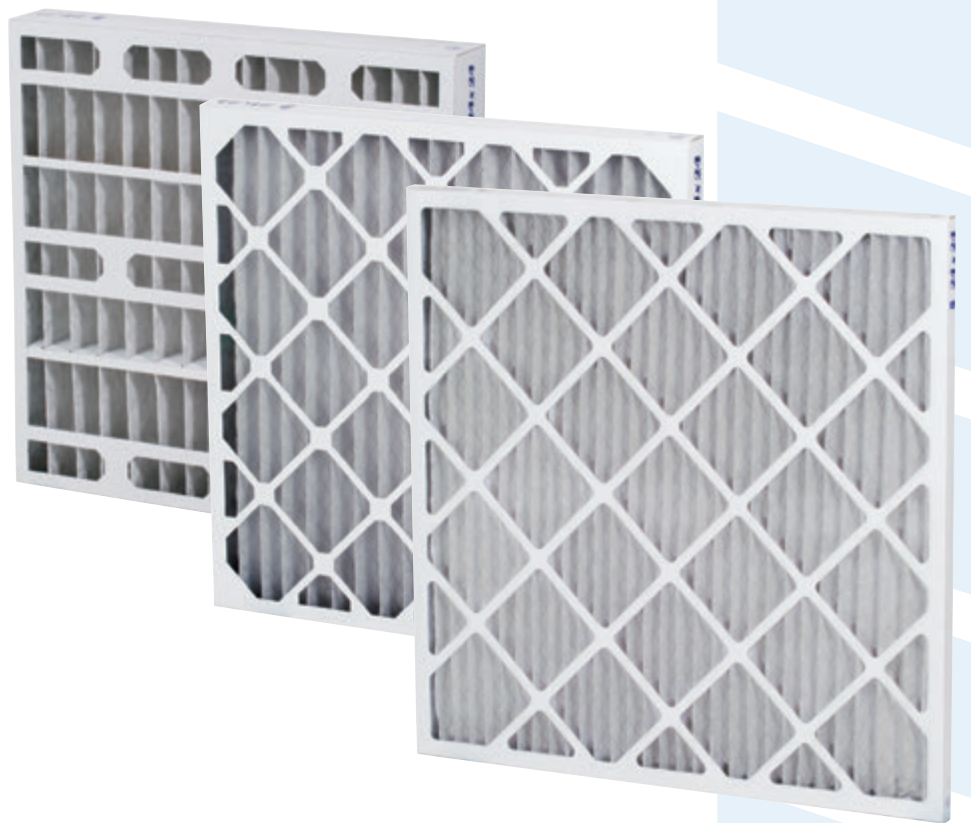

QUALITYFILTERS, INC.
THINKSIMPLE. THINKSMART. THINKQUALITY.

23351 GRISSOM DRIVE
ROBERTSDALE, AL 36567

PHONE: 251.947.2400
FACSIMILE: 251.947.2499
TOLL FREE: 800.635.6820
QUALITYFILTERS.COM



ODORBAN

EFFECTIVE ODOR REMOVAL

1", 2", and 4" Pleated Air Filters with excellent pleatability for sharp, crisp pleats

THINKQUALITY.

ODOR BAN FILTER

So, what makes the new Odor Ban superior to other carbon filters? It's all about Outer Surface Area. Typical indoor gaseous irritants adhere to the outer one millionth of a meter of carbon's surface. Odor Ban pleated filters now incorporate Gray Matter® intelligent carbon media. Gray Matter media maximizes Outer Surface Area by reducing the average carbon granule size. It's like comparing the outer surface area of a basketball to that of thousands of BB's of the same size and weight. A 1-millimeter granule of carbon becomes one trillion gray matter granules! This increases the outer surface area of that granule from 6 square millimeters to 60,000 square millimeters.

These particles adhere to the media fibers through an ultra strong molecular bond and don't require pore-clogging adhesives. The carbon granules or slurry in traditional carbon filters have most of their "surface area" deep within the pores of the carbon – inner surface area. In many cases, those pores are clogged by the glue that holds the carbon onto the filter media.

Now you can have all the benefits you've trusted for over twenty-five years in our Odor Ban pleated filter at a price that rivals a standard pleated filter!

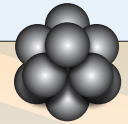

Gray Matter®

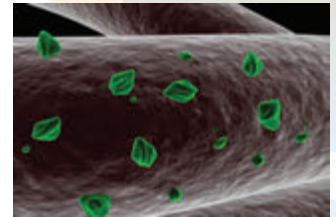

FEATURES

- Two stage system combines thermally bonded 100% synthetic fibers with activated carbon.
- Activated carbon absorbs odors and irritants while maintaining a low resistance to air flow.
- Lightweight and durable.
- Makes excellent pre-filters for multistage system.
- Available for 1", 2", and 4" pleated air filters.
- **MERV 8** rated per ASHRAE test standard 52.2.
- Odor Ban now utilizes high capacity pleat count.

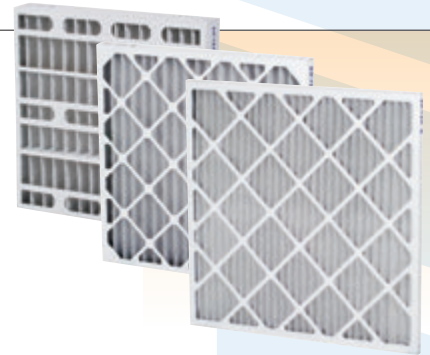

HAVE A QUESTION? CALL US.

800.635.6820



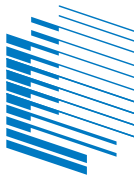

QUALITY FILTERS, INC.

THINKSIMPLE. THINKSMART. THINKQUALITY.

23351 Grissom Drive
 Robertsdale, AL 36567
 www.QualityFilters.com

Phone: (251) 947-2400
 Order Fax: (251) 947-2499
 Sales Fax: (251) 947-7948



Gray Matter™

Product Code	Nominal Size w x h x d	Actual Size w x h x d	Flow Rate cfm	Media Sq.Feet
OB10101	10x10x1	9.5x9.5x.75	205	1.4
OB10201	10x20x1	9.5x19.5x.75	410	3
OB12121	12x12x1	11.75x11.75x.75	295	2
OB12201	12x20x1	11.8125x19.8125x.75	492	3.6
OB12241	12x24x1	11.5x23.5x.75	590	4.3
OB14201	14x20x1	13.5x19.5x.75	575	4.1
OB14241	14x24x1	13.875x23.875x.75	688	5.1
OB14251	14x25x1	13.5x24.5x.75	718	5.2
OB15201	15x20x1	14.5625x19.5625x.75	615	4.4
OB16201	16x20x1	15.5625x19.5625x.75	654	4.7
OB16241	16x24x1	15.5x23.5x.75	787	5.8
OB16251	16x25x1	15.5625x24.5625x.75	836	5.9
OB18241	18x24x1	17.5x23.5x.75	885	6.4
OB18251	18x25x1	17.5x24.5x.75	934	6.7
OB20201	20x20x1	19.5625x19.5625x.75	836	5.9
OB20241	20x24x1	19.5x23.5x.75	983	7.1
OB20251	20x25x1	19.5625x24.5625x.75	1032	7.4
OB20301	20x30x1	19.625x29.625x.75	1229	9
OB24241	24x24x1	23.75x23.75x.75	1180	8.5
OB24301	24x30x1	23.5x29.5x.75	1475	11
OB25251	25x25x1	24.5x24.5x.75	1278	9.2
OB10202	10x20x2	9.5x19.5x1.75	688	5.9
OB12202	12x20x2	11.5x19.5x1.75	836	7.4
OB12242	12x24x2	11.375x23.375x1.75	983	8.9
OB12252	12x25x2	11.5x24.5x1.75	1032	9.3
OB14202	14x20x2	13.5625x19.5625x1.75	959	8.9
OB14252	14x25x2	13.5x24.5x1.75	1195	11.1
OB15202	15x20x2	14.5625x19.5625x1.75	1023	9.6
OB16202	16x20x2	15.625x19.625x1.75	1082	9.7
OB16242	16x24x2	15.375x23.375x1.75	1311	12.7
OB16252	16x25x2	15.625x24.625x1.75	1377	12
OB18182	18x18x2	17.75x17.75x1.75	1106	10.6
OB18242	18x24x2	17.375x23.375x1.75	1475	13.7
OB18252	18x25x2	17.5x24.5x1.75	1524	13.9
OB20202	20x20x2	19.5625x19.5625x1.6875	1377	12.6
OB20242	20x24x2	19.375x23.375x1.75	1637	15.1
OB20252	20x25x2	19.5625x24.5625x1.6875	1721	15.7
OB20302	20x30x2	19.5x29.5x1.75	2048	20
OB22222	22x22x2	21.9375x21.9375x1.75	1654	15.3
OB24242	24x24x2	23.375x23.375x1.6875	1967	17.8
OB24302	24x30x2	23.5x29.5x1.75	2458	21.6
OB25252	25x25x2	24.5x24.5x1.75	2124	19.4
OB25282	25x28x2	24.5x27.875x1.75	2360	21
OB12244	12x24x4	11.4375x23.4375x3.625	983	14.2
OB16204	16x20x4	15.5x19.5x3.625	1082	15.7
OB16254	16x25x4	15.625x24.625x3.625	1377	19.7
OB18244	18x24x4	17.5x23.5x3.625	1475	21.3
OB20204	20x20x4	19.5x19.5x3.625	1377	19.7
OB20244	20x24x4	19.4375x23.4375x3.625	1622	23.7
OB20254	20x25x4	19.5x24.5x3.625	1721	24.7
OB24244	24x24x4	23.375x23.375x3.625	1967	28.4
OB25294	25x29x4	24.5x28.5x3.625	2458	35.7

*Pleats per linear foot 1" depth = 16, 2" depth = 15, 4" depth = 11.

Quality OdorBan Pleated Carbon Panel Filters			
Date 09 Sep 10	1"	Dwg No. Q-110040	Rev H
Date 24 Oct 16	2"		
Date 03 Sep 10	4"		

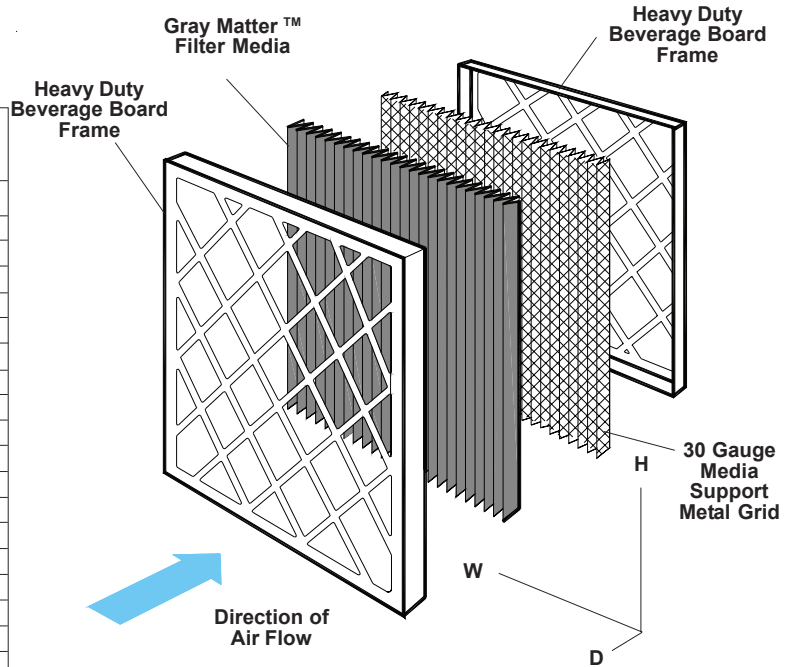

Notes:

OdorBan Pleated Filters are available in 1", 2" and 4" depth. The Gray Matter™ media is continuously bonded to a 30 gauge galvanized, corrosion resistant, expanded metal support grid with an effective open area of 96%. The media is resistant to a wide range of chemicals, does not absorb moisture and will not support microbial growth. The controlled pleat spacing maximizes surface area, dust holding capacity and is bonded to the frame to prevent dust bypass. Odor Ban panel filters fit into existing filter housings so that fume and odor control is available without costly retro-fitting or expensive housings and fans.

Performance Data 24x24

Product Code	ASHRAE 52.2				Initial Resistance	Final Resistance
	MERV Value	E1 %	E2 %	E3 %	@ rated flow see chart	@ rated flow see chart
OB - 1"	8	35	74	77	0.19	1.00
OB - 2"	10	24.9	61.9	80.3	0.228	1.00
OB - 4"	11	38	76	85	0.19	1.50

Characteristics OdorBan Pleated Filters

Filter Media	Fine carbon powder bonded to synthetic media
Filter Support Grid	30 gauge galvanized expanded metal grid
Frame	Moisture resistant double wall beverage board
Assembly Technique	Media pack fully bonded to frame
Max. Temperature	180°F (82°C) Continuous service 225°F (107°C) Intermittent peak service
Max. Humidity	Resistant to 100% R.H.
Flammability	U.L. 900, Class 2

THINKSIMPLE. THINKSMART.

THINKQUALITY.

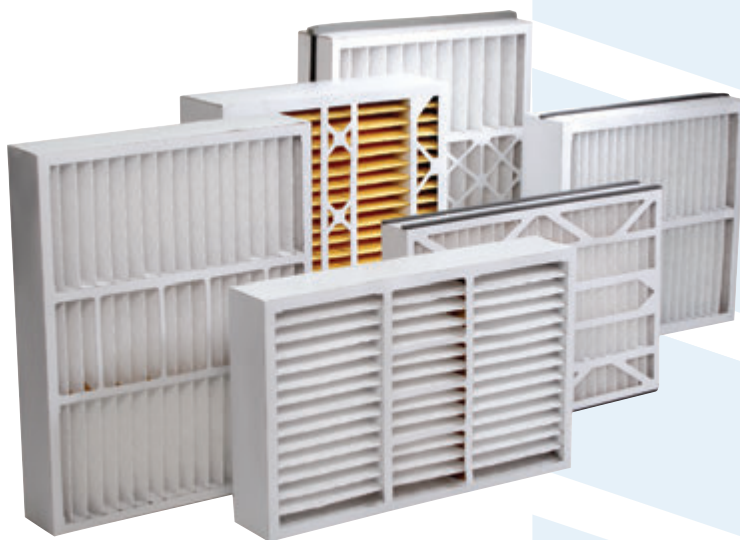

QUALITYFILTERS, INC.
THINKSIMPLE. THINKSMART. THINKQUALITY.

23351 GRISSOM DRIVE
ROBERTSDALE, AL 36567

PHONE: 251.947.2400
FACSIMILE: 251.947.2499
TOLL FREE: 800.635.6820
QUALITYFILTERS.COM



ENVAERO

DUCTED REPLACEMENT FILTERS



DUCTED REPLACEMENT FILTERS

Longer Life, Lower Costs

→ THINK QUALITY.

QUALITY PLEATED FILTERS

Quality Filters' Envaero™ residential air filters offer a smart, pleated design that combines an increased filtration surface area with an allowance for maximum air flow that reduces energy costs.

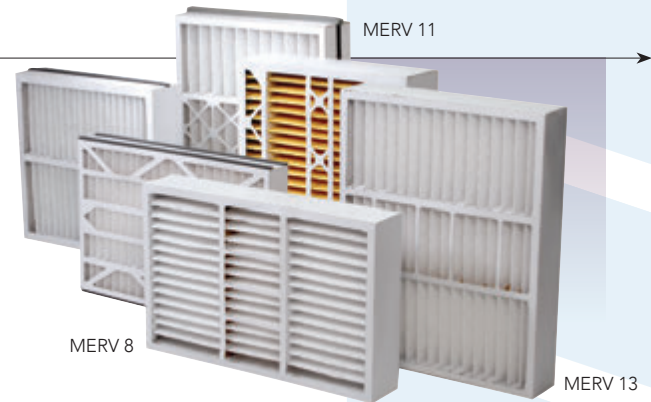

ADVANTAGES:

- Extends the life of the HVAC unit by decreasing pressure drop.
- Pleated design increases system's energy efficiency and reduces overall expense.
- Provides the same MERV 8, MERV 11, MERV 13, and Odor Ban carbon synthetic media as other products in the Quality Pleats family.
- Can last up to three to six times longer than standard one inch pleated filters.
- Designed to retrofit existing residential ducted air filter housings.
- Comes pre-assembled for easy installation.



ENVAERO Product Features:

- Available in 3" to 6" in depth.
- Multi-layered construction consists of 100% synthetic media, 30 gauge metal support grid, and 28 point beverage board frame.
- Replacements available for Trion Air Bear*, Honeywell*, White Rodgers*, General Filter*, and Trane Perfect Fit.*

*Trade names and company names are used for identification purposes only.

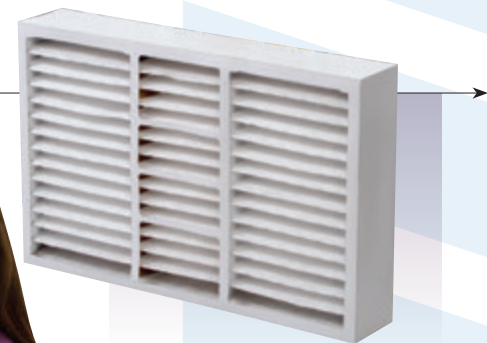

HAVE A QUESTION? CALL US.

800.635.6820



ENVAERO

MERV 8, 11, 13 & ODORBAN

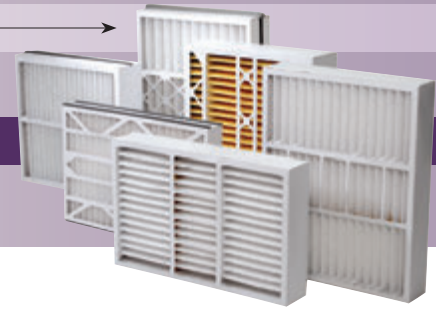

Envaero™ Residential Air Cleaner replacement filters are designed to fit existing ducted air filter housings. Envaero™ filters are pre-assembled for easy installation; 5" depth and close pleats minimize pressure drop and extend filter life. Offered in MERV 8, 11, 13, and fume control ratings, Envaero™ filters can last 6 months to a year in most home installations.

REPLACEMENT FOR OEM STYLE:	OEM FILTER	OEM MERV	NOMINAL SIZE W x H x D	ACTUAL SIZE W x H x D
Amana	FS1620, M0-1056, MU1620, 9183940	11	16 x 20 x 5	15-3/8 x 21-7/8 x 5-1/4
Amana	MFAH-S	11	16 x 22 x 5	15-1/2 x 22 x 5-1/4
Amana	FS1625, M1-1056, MU1625, 9183950	11	16 x 25 x 5	15-3/8 x 25-1/2 x 5-1/4
Amana	FS2020, M2-1056, MU2020, 9183960	11	20 x 20 x 5	20-1/4 x 20-3/4 x 5-1/4
Amana	MFAH-M	11	20 x 22 x 5	19-1/2 x 22 x 5-1/4
Amana	FS2025, M8-1056, MU2025, 9183970	11	20 x 25 x 5	20-1/4 x 25-1/2 x 5-1/4
Amana	MFAH-L	11	22 x 24 x 5	22-1/8 x 24 x 5-1/4
Aprilaire/Space-Gard	401	10	16 x 27 x 6	15-7/16 x 26-15/16 x 6
Aprilaire/Space-Gard	201	10	20 x 25 x 6	19-3/4 x 24-1/4 x 6
Coleman	FS1620, M0-1056, MU1620, 9183940	11	16 x 20 x 5	15-3/8 x 21-7/8 x 5-1/4
Coleman	FS1625, M1-1056, MU1625, 9183950	11	16 x 25 x 5	15-3/8 x 25-1/2 x 5-1/4
Coleman	FS2020, M2-1056, MU2020, 9183960	11	20 x 20 x 5	20-1/4 x 20-3/4 x 5-1/4
Coleman	FS2025, M8-1056, MU2025, 9183970	11	20 x 25 x 5	20-1/4 x 25-3/8 x 5-1/4
Comfort Clean	FS1620, M0-1056, MU1620, 9183940	11	16 x 20 x 5	15-3/8 x 21-7/8 x 5-1/4
Comfort Clean	FS1625, M1-1056, MU1625, 9183950	11	16 x 25 x 5	15-3/8 x 25-1/2 x 5-1/4
Comfort Clean	FS2020, M2-1056, MU2020, 9183960	11	20 x 20 x 5	20-1/4 x 20-3/4 x 5-1/4
Comfort Clean	FS2025, M8-1056, MU2025, 9183970	11	20 x 25 x 5	20-1/4 x 25-3/8 x 5-1/4
Electro-Air	FS1620, M0-1056, MU1620, 9183940	11	16 x 20 x 5	15-3/8 x 21-7/8 x 5-1/4
Electro-Air	F825-0431/F8110385	10	16 x 21 x 5	16-1/4 x 21 x 5
Electro-Air	FS1625, M1-1056, MU1625, 9183950	11	16 x 25 x 5	15-3/8 x 25-1/2 x 5-1/4
Electro-Air	F825-0432/F8110397	10	16 x 25 x 5	15-7/8 x 24-3/4 x 4-3/8
Electro-Air	FS2020, M2-1056, MU2020, 9183960	11	20 x 20 x 5	20-1/4 x 20-3/4 x 5-1/4
Electro-Air	F825-0337/F8110321	10	20 x 21 x 5	20-3/4 x 20-5/8 x 5
Electro-Air	FS2025, M8-1056, MU2025, 9183970	11	20 x 25 x 5	20-1/4 x 25-3/8 x 5-1/4
Electro-air	F825-0338/F8110319	10	20 x 26 x 5	20 x 25-7/8 x 4-7/8
Emerson	F825-0431/F8110385	10	16 x 21 x 5	16-1/4 x 21 x 5
Emerson	F825-0432/F8110397	10	16 x 25 x 5	15-7/8 x 24-3/4 x 4-3/8
Emerson	F825-0337/F8110321	10	20 x 21 x 5	20-3/4 x 20-5/8 x 5
Emerson	F825-0338/F8110319	10	20 x 26 x 5	20 x 25-7/8 x 4-7/8
Fast	FS1620, M0-1056, MU1620, 9183940	11	16 x 20 x 5	15-3/8 x 21-7/8 x 5-1/4
Fast	FS1625, M1-1056, MU1625, 9183950	11	16 x 25 x 5	15-3/8 x 25-1/2 x 5-1/4
Fast	FS2020, M2-1056, MU2020, 9183960	11	20 x 20 x 5	20-1/4 x 20-3/4 x 5-1/4
Fast	FS2025, M8-1056, MU2025, 9183970	11	20 x 25 x 5	20-1/4 x 25-3/8 x 5-1/4
Five Seasons	FS1620, M0-1056, MU1620, 9183940	11	16 x 20 x 5	15-3/8 x 21-7/8 x 5-1/4
Five Seasons	FS1625, M1-1056, MU1625, 9183950	11	16 x 25 x 5	15-3/8 x 25-1/2 x 5-1/4
Five Seasons	FS2020, M2-1056, MU2020, 9183960	11	20 x 20 x 5	20-1/4 x 20-3/4 x 5-1/4
Five Seasons	FS2025, M8-1056, MU2025, 9183970	11	20 x 25 x 5	20-1/4 x 25-3/8 x 5-1/4
General Aire	4350	10	16 x 20 x 5	15-1/2 x 19-5/8 x 4-1/4
General Aire	GA100A03	10	16 x 20 x 5	15-1/2 x 19-5/8 x 4-1/4
General Aire	14164	10	16 x 25 x 3	15-13/16 x 24-5/16 x 3
General Aire	3FM1625	10	16 x 25 x 3	15-13/16 x 24-5/16 x 3
General Aire	4521	10	16 x 25 x 3	15-13/16 x 24-5/16 x 3
General Aire	4352	10	16 x 25 x 5	15-7/8 x 24-3/4 x 4-3/8
General Aire	GA100A29	10	16 x 25 x 5	15-7/8 x 24-3/4 x 4-3/8
General Aire	14161	10	16 x 25 x 5	15-13/16 x 24-5/16 x 4-3/4

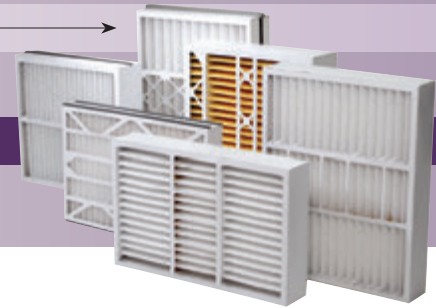

REPLACEMENT FOR OEM STYLE:	OEM FILTER	OEM MERV	NOMINAL SIZE W x H x D	ACTUAL SIZE W x H x D
General Aire	4511	10	16 x 25 x 5	15-13/16 x 24-5/16 x 4-3/4
General Aire	5FM1625	10	16 x 25 x 5	15-13/16 x 24-5/16 x 4-3/4
General Aire	4354	10	20 x 20 x 5	19-9/16 x 20-1/16 x 4-3/8
General Aire	GA100A11	10	20 x 20 x 5	19-9/16 x 20-1/16 x 4-3/8
General Aire	4001	10	20 x 24 x 5	19-9/16 x 24-1/16 x 4-3/4
General Aire	4356	10	20 x 25 x 5	19-7/8 x 24-11/16 x 4-1/4
General Aire	GA100A37	10	20 x 25 x 5	19-7/8 x 24-11/16 x 4-1/4
General Aire	14201	10	20 x 25 x 5	19-1/2 x 24 x 4-3/4
General Aire	4501	10	20 x 25 x 5	19-1/2 x 24 x 4-3/4
General Aire	5FM2025	10	20 x 25 x 5	19-1/2 x 24 x 4-3/4
Goodman	FS1620, M0-1056, MU1620, 9183940	11	16 x 20 x 5	15-3/8 x 21-7/8 x 5-1/4
Goodman	MFAH-S	11	16 x 22 x 5	15-1/2 x 22 x 5-1/4
Goodman	FS1625, M1-1056, MU1625, 9183950	11	16 x 25 x 5	15-3/8 x 25-1/2 x 5-1/4
Goodman	FS2020, M2-1056, MU2020, 9183960	11	20 x 20 x 5	20-1/4 x 20-3/4 x 5-1/4
Goodman	MFAH-M	11	20 x 22 x 5	19-9/16 x 22 x 5-1/4
Goodman	FS2025, M8-1056, MU2025, 9183970	11	20 x 25 x 5	20-1/4 x 25-3/8 x 5-1/4
Goodman	MFAH-L	11	22 x 24 x 5	22-1/8 x 24 x 5-1/4
Honeywell	FC100A1052	11	12.5 x 20 x 5	12-1/2 x 20 x 4-3/8
Honeywell	TRN1427T1	10	14.5 x 27 x 5	14 x 26-1/4 x 4-15/16
Honeywell	209894	11	16 x 20 x 5	15-1/2 x 19-5/8 x 4-1/4
Honeywell	CF200A1620	12	16 x 20 x 5	15-1/2 x 19-5/8 x 4-1/4
Honeywell	FC100A1003	11	16 x 20 x 5	15-1/2 x 19-5/8 x 4-1/4
Honeywell	FC200E1003	13	16 x 20 x 5	15-1/2 x 19-5/8 x 4-1/4
Honeywell	FC35A1035	11	16 x 20 x 5	15-1/2 x 19-5/8 x 4-1/4
Honeywell	203719	11	16 x 25 x 5	15-7/8 x 24-3/4 x 4-3/8
Honeywell	CF100A1009	11	16 x 25 x 5	15-7/8 x 24-3/4 x 4-3/8
Honeywell	CF200A1008	10	16 x 25 x 5	15-7/8 x 24-3/4 x 4-3/8
Honeywell	FC100A1029	11	16 x 25 x 5	15-7/8 x 24-3/4 x 4-3/8
Honeywell	FC200E1029	13	16 x 25 x 5	15-7/8 x 24-3/4 x 4-3/8
Honeywell	FC35A1001	10	16 x 25 x 5	15-7/8 x 24-3/4 x 4-3/8
Honeywell	TRN1727T1	10	17.5 x 27 x 5	17-1/16 x 26-1/4 x 4-15/16
Honeywell	203721	11	20 x 20 x 5	19-9/16 x 20-1/16 x 4-3/8
Honeywell	CF200A1024	12	20 x 20 x 5	19-9/16 x 20-1/16 x 4-3/8
Honeywell	FC100A1011	11	20 x 20 x 5	19-9/16 x 20-1/16 x 4-3/8
Honeywell	FC200E1011	13	20 x 20 x 5	19-9/16 x 20-1/16 x 4-3/8
Honeywell	FC35A1019	10	20 x 20 x 5	19-9/16 x 20-1/16 x 4-3/8
Honeywell	203720	11	20 x 25 x 5	19-7/8 x 24-11/16 x 4-1/4
Honeywell	CF100A1025	8	20 x 25 x 5	19-7/8 x 24-11/16 x 4-1/4
Honeywell	CF200A1016	12	20 x 25 x 5	19-7/8 x 24-11/16 x 4-1/4
Honeywell	FC100A1037	11	20 x 25 x 5	19-7/8 x 24-11/16 x 4-1/4
Honeywell	FC200E1037	13	20 x 25 x 5	19-7/8 x 24-11/16 x 4-1/4
Honeywell	FC35A1027	10	20 x 25 x 5	19-7/8 x 24-11/16 x 4-1/4
Honeywell	TRN2127T1	10	21 x 27 x 5	20-5/8 x 26-1/4 x 4-15/16
Honeywell	207583	11	21.5 x 27.5 x 5	21-1/2 x 27-1/2 x 4-3/8
Honeywell	FC100A1045	11	21.5 x 27.5 x 5	21-1/2 x 27-1/2 x 4-3/8
Honeywell	TRN2121T1	10	21-1/2 x 21 x 5	21-1/16 x 19-1/2 x 4-15/16
Honeywell	TRN2321T1	10	23 x 21 x 5	23-1/16 x 21 x 4-15/16
Honeywell	TRN2427T1	10	24 x 27 x 5	24-1/16 x 26-1/4 x 4-15/16
Honeywell	TRN2621T1	10	26 x 21 x 5	25-5/16 x 19-15/16 x 4-15/16
Janitrol	FS1620, M0-1056, MU1620, 9183940	11	16 x 20 x 5	15-3/8 x 21-7/8 x 5-1/4
Janitrol	MFAH-S	11	16 x 22 x 5	15-1/2 x 22 x 5-1/4
Janitrol	MFAH-M	11	20 x 22 x 5	19-9/16 x 22 x 5-1/4



ENVAERO

MERV 8, 11, 13 & ODORBAN

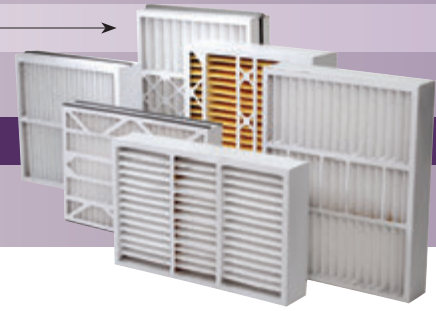

REPLACEMENT FOR OEM STYLE:	OEM FILTER	OEM MERV	NOMINAL SIZE W x H x D	ACTUAL SIZE W x H x D
Janitrol	MFAH-L	11	22 x 24 x 5	22-1/8 x 24 x 5-1/4
Lennox	X0582	10	16 x 20 x 5	15-1/2 x 19-5/8 x 4-1/4
Lennox	X0581	10	16 x 25 x 3	15-3/4 x 24-1/4 x 3
Lennox	X5427	10	16 x 25 x 3	15-3/4 x 24-1/4 x 3
Lennox	HCF16-10	10	16 x 25 x 5	15-7/8 x 24-3/4 x 4-3/8
Lennox	HCXF16-10*	10	16 x 25 x 5	15-7/8 x 24-3/4 x 4-3/8
Lennox	X0583,6660,6670,6672,7750,8303	10	16 x 25 x 5	15-7/8 x 24-3/4 x 4-3/8
Lennox	X0584	10	16 x 26 x 5	16-3/8 x 26 x 5-5/32
Lennox	X6664	10	17 x 26 x 4	16-5/8 x 26-3/4 x 4
Lennox	HCF 14-10	10	20 x 20 x 5	19-9/16 x 20-1/16 x 4-3/8
Lennox	X0585	10	20 x 20 x 5	19-9/16 x 20-1/16 x 4-3/8
Lennox	X1152	10	20 x 25 x 5	19-1/2 x 24-1/2 x 4-3/4
Lennox	X1152	10	20 x 25 x 5	19-1/2 x 24-1/2 x 4-3/4
Lennox	X5430	10	20 x 25 x 5	19-1/2 x 24-1/2 x 4-3/4
Lennox	X6673	10	20 x 25 x 5	19-7/8 x 24-11/16 x 4-1/4
Lennox	HCF20-10	10	20 x 26 x 5	20-7/16 x 26 x 4-7/8
Lennox	X0586	10	20 x 26 x 5	20-7/16 x 26 x 4-7/8
Lennox	X0587	10	20 x 26 x 5	20-7/16 x 26 x 4-7/8
Lennox	X6667,X6669	10	21 x 26 x 4	20-3/4 x 25-3/4 x 3-3/4
Lennox	X6667,X6669	10	21 x 26 x 4	20-3/4 x 25-3/4 x 3-3/4
Liebert	195551P1	8	29 x 30 x 2	28.5 x 29.5 x 1.75
Liebert	195551P2	8	29 x 30 x 4	28.5 x 29.5 x 3.75
Nordyne	918394	11	16 x 20 x 5	15-3/8 x 21-7/8 x 5-1/4
Nordyne	FS1620, M0-1056, MU1620, 9183940	11	16 x 20 x 5	15-3/8 x 21-7/8 x 5-1/4
Nordyne	918395	11	16 x 25 x 5	15-3/8 x 25-1/2 x 5-1/4
Nordyne	FS1625, M1-1056, MU1625, 9183950	11	16 x 25 x 5	15-3/8 x 25-1/2 x 5-1/4
Nordyne	918396	11	20 x 20 x 5	20-1/4 x 20-3/4 x 5-1/4
Nordyne	FS2020, M2-1056, MU2020, 9183960	11	20 x 20 x 5	20-1/4 x 20-3/4 x 5-1/4
Nordyne	918737	10	20 x 22 x 5	19-9/16 x 22 x 5-1/4
Nordyne	918397	11	20 x 25 x 5	20-1/4 x 25-3/8 x 5-1/4
Nordyne	FS2025, M8-1056, MU2025, 9183970	11	20 x 25 x 5	20-1/4 x 25-3/8 x 5-1/4
Rheem/Ruud	Protech 54-25051-02	8	16 x 25 x 3	15-3/4 x 24-1/4 x 3
Rheem/Ruud	Protech 54-25051-04	8	16 x 25 x 5	15-13/16 x 24-5/16 x 4-3/4
Rheem/Ruud	PD540010	10	17 x 21 x 5	17-1/4 x 20-3/4 x 4-3/8
Rheem/Ruud	PD540016	13	17 x 21 x 5	17-1/4 x 20-3/4 x 4-3/8
Rheem/Ruud	Protech 540010	10	17 x 21 x 5	17-1/4 x 20-3/4 x 4-3/8
Rheem/Ruud	Protech 540016	13	17 x 21 x 5	17-1/4 x 20-3/4 x 4-3/8
Rheem/Ruud	PD540011	10	17 x 28 x 5	17-1/4 x 27-3/4 x 4-3/8
Rheem/Ruud	Protech 54-25051-01	8	20 x 25 x 5	19-1/2 x 24 x 4-3/4
Rheem/Ruud	PD540018	13	21 x 21 x 4.5	20-3/4 x 20-3/4 x 4-3/8
Rheem/Ruud	Protech 540012	10	21 x 21 x 4.5	20-3/4 x 20-3/4 x 4-3/8
Rheem/Ruud	Protech 540018	13	21 x 21 x 4.5	20-3/4 x 20-3/4 x 4-3/8
Rheem/Ruud	PD540012	10	21 x 21 x 4.5	20-3/4 x 20-3/4 x 4-3/8
Rheem/Ruud	PD540014	10	21 x 24.5 x 4.5	20-3/4 x 24-1/4 x 4-3/8
Rheem/Ruud	PD540020	13	21 x 24.5 x 4.5	20-3/4 x 24-1/4 x 4-3/8
Rheem/Ruud	Protech 540014	10	21 x 24.5 x 4.5	20-3/4 x 24-1/4 x 4-3/8
Rheem/Ruud	Protech 540020	13	21 x 24.5 x 4.5	20-3/4 x 24-1/4 x 4-3/8
Rheem/Ruud	PD540013	10	21 x 28 x 5	20-3/4 x 27-3/4 x 4-3/8
Rheem/Ruud	PD540015	10	25 x 28 x 5	24-5/32 x 27-3/4 x 4-3/8
Skuttle	000-0448-001	8	16 x 25 x 5	15-13/16 x 24-5/16 x 4-3/4
Skuttle	000-0448-003	8	20 x 20 x 5	19-11/16 x 20-11/16 x 4-7/8
Skuttle	000-0448-002	8	20 x 25 x 5	19-1/2 x 24 x 4-3/4

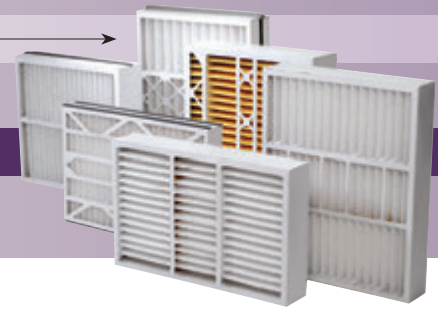

REPLACEMENT FOR OEM STYLE:	OEM FILTER	OEM MERV	NOMINAL SIZE W x H x D	ACTUAL SIZE W x H x D
Honeywell	FC200E1037	13	20 x 25 x 5	19-7/8 x 24-11/16 x 4-1/4
Honeywell	FC35A1027	10	20 x 25 x 5	19-7/8 x 24-11/16 x 4-1/4
Honeywell	TRN2127T1	10	21 x 27 x 5	20-5/8 x 26-1/4 x 4-15/16
Honeywell	207583	11	21.5 x 27.5 x 5	21-1/2 x 27-1/2 x 4-3/8
Honeywell	FC100A1045	11	21.5 x 27.5 x 5	21-1/2 x 27-1/2 x 4-3/8
Honeywell	TRN2121T1	10	21-1/2 x 21 x 5	21-1/16 x 19-1/2 x 4-15/16
Honeywell	TRN2321T1	10	23 x 21 x 5	23-1/16 x 21 x 4-15/16
Honeywell	TRN2427T1	10	24 x 27 x 5	24-1/16 x 26-1/4 x 4-15/16
Honeywell	TRN2621T1	10	26 x 21 x 5	25-5/16 x 19-15/16 x 4-15/16
Janitrol	FS1620, M0-1056, MU1620, 9183940	11	16 x 20 x 5	15-3/8 x 21-7/8 x 5-1/4
Janitrol	MFAH-S	11	16 x 22 x 5	15-1/2 x 22 x 5-1/4
Janitrol	MFAH-M	11	20 x 22 x 5	19-9/16 x 22 x 5-1/4
Janitrol	MFAH-L	11	22 x 24 x 5	22-1/8 x 24 x 5-1/4
Lennox	X0582	10	16 x 20 x 5	15-1/2 x 19-5/8 x 4-1/4
Lennox	X0581	10	16 x 25 x 3	15-13/16 x 24-5/16 x 3
Lennox	X5427	10	16 x 25 x 3	15-13/16 x 24-5/16 x 3
Lennox	HCF16-10	10	16 x 25 x 5	15-7/8 x 24-3/4 x 4-3/8
Lennox	HCXF16-10*	10	16 x 25 x 5	15-7/8 x 24-3/4 x 4-3/8
Lennox	X0583,6660,6670,6672,7750,8303	10	16 x 25 x 5	15-7/8 x 24-3/4 x 4-3/8
Lennox	X0584	10	16 x 26 x 5	16-3/8 x 26 x 5-5/32
Lennox	X6664	10	17 x 26 x 4	16-5/8 x 26-3/4 x 4
Lennox	HCF 14-10	10	20 x 20 x 5	19-9/16 x 20-1/16 x 4-3/8
Lennox	X0585	10	20 x 20 x 5	19-9/16 x 20-1/16 x 4-3/8
Lennox	X1152	10	20 x 25 x 5	19-1/2 x 24-1/2 x 4-3/4
Lennox	X1152	10	20 x 25 x 5	19-1/2 x 24-1/2 x 4-3/4
Lennox	X5430	10	20 x 25 x 5	19-1/2 x 24-1/2 x 4-3/4
Lennox	X6673	10	20 x 25 x 5	19-7/8 x 24-11/16 x 4-1/4
Lennox	HCF20-10	10	20 x 26 x 5	20-7/16 x 26 x 4-7/8
Lennox	X0586	10	20 x 26 x 5	20-7/16 x 26 x 4-7/8
Lennox	X0587	10	20 x 26 x 5	20-7/16 x 26 x 4-7/8
Lennox	X6667,X6669	10	21 x 26 x 4	20-3/4 x 25-3/4 x 3-3/4
Lennox	X6667,X6669	10	21 x 26 x 4	20-3/4 x 25-3/4 x 3-3/4
Nordyne	918394	11	16 x 20 x 5	15-3/8 x 21-7/8 x 5-1/4
Nordyne	FS1620, M0-1056, MU1620, 9183940	11	16 x 20 x 5	15-3/8 x 21-7/8 x 5-1/4
Nordyne	918395	11	16 x 25 x 5	15-3/8 x 25-1/2 x 5-1/4
Nordyne	FS1625, M1-1056, MU1625, 9183950	11	16 x 25 x 5	15-3/8 x 25-1/2 x 5-1/4
Nordyne	918396	11	20 x 20 x 5	20-1/4 x 20-3/4 x 5-1/4
Nordyne	FS2020, M2-1056, MU2020, 9183960	11	20 x 20 x 5	20-1/4 x 20-3/4 x 5-1/4
Nordyne	918737	10	20 x 22 x 5	19-9/16 x 22 x 5-1/4
Nordyne	918397	11	20 x 25 x 5	20-1/4 x 25-3/8 x 5-1/4
Nordyne	FS2025, M8-1056, MU2025, 9183970	11	20 x 25 x 5	20-1/4 x 25-3/8 x 5-1/4
Rheem/Ruud	Protech 54-25051-02	8	16 x 25 x 3	15-3/4 x 24-1/4 x 3
Rheem/Ruud	Protech 54-25051-04	8	16 x 25 x 5	15-13/16 x 24-5/16 x 4-3/4
Rheem/Ruud	PD540010	10	17 x 21 x 5	17-1/4 x 20-3/4 x 4-3/8
Rheem/Ruud	PD540016	13	17 x 21 x 5	17-1/4 x 20-3/4 x 4-3/8
Rheem/Ruud	Protech 540010	10	17 x 21 x 5	17-1/4 x 20-3/4 x 4-3/8
Rheem/Ruud	Protech 540016	13	17 x 21 x 5	17-1/4 x 20-3/4 x 4-3/8
Rheem/Ruud	PD540011	10	17 x 28 x 5	17-1/4 x 27-3/4 x 4-3/8
Rheem/Ruud	Protech 54-25051-01	8	20 x 25 x 5	19-1/2 x 24 x 4-3/4
Rheem/Ruud	PD540018	13	21 x 21 x 4.5	20-3/4 x 20-3/4 x 4-3/8
Rheem/Ruud	Protech 540012	10	21 x 21 x 4.5	20-3/4 x 20-3/4 x 4-3/8
Rheem/Ruud	Protech 540018	13	21 x 21 x 4.5	20-3/4 x 20-3/4 x 4-3/8



ENVAERO

MERV 8, 11, 13 & ODORBAN

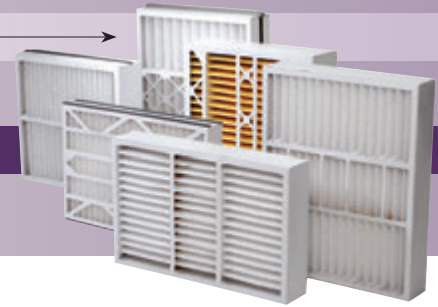

REPLACEMENT FOR OEM STYLE:	OEM FILTER	OEM MERV	NOMINAL SIZE W x H x D	ACTUAL SIZE W x H x D
Rheem/Ruud	PD540012	10	21 x 21 x 4.5	20-3/4 x 20-3/4 x 4-3/8
Rheem/Ruud	PD540014	10	21 x 24.5 x 4.5	20-3/4 x 24-1/4 x 4-3/8
Rheem/Ruud	PD540020	13	21 x 24.5 x 4.5	20-3/4 x 24-1/4 x 4-3/8
Rheem/Ruud	Protech 540014	10	21 x 24.5 x 4.5	20-3/4 x 24-1/4 x 4-3/8
Rheem/Ruud	Protech 540020	13	21 x 24.5 x 4.5	20-3/4 x 24-1/4 x 4-3/8
Rheem/Ruud	PD540013	10	21 x 28 x 5	20-3/4 x 27-3/4 x 4-3/8
Rheem/Ruud	PD540015	10	25 x 28 x 5	24-5/32 x 27-3/4 x 4-3/8
Skuttle	000-0448-001	8	16 x 25 x 5	15-13/16 x 24-5/16 x 4-3/4
Skuttle	000-0448-003	8	20 x 20 x 5	19-11/16 x 20-11/16 x 4-7/8
Skuttle	000-0448-002	8	20 x 25 x 5	19-1/2 x 24 x 4-3/4
Totaline	P102-1620	11	16 x 20 x 5	15-3/8 x 21-7/8 x 5-1/4
Totaline	P102-1625	11	16 x 25 x 5	15-3/8 x 25-1/2 x 5-1/4
Totaline	P102-2020	11	20 x 20 x 5	20-1/4 x 20-3/4 x 5-1/4
Totaline	P102-2025	11	20 x 25 x 5	20-1/4 x 25-3/8 x 5-1/4
Trane/American Standard	BAYFTFR14M	8	14 x 26 x 5	14 x 26-1/4 x 4-15/16
Trane/American Standard	BAYFTFR14M2	8	14 x 26 x 5	14 x 26-1/4 x 4-15/16
Trane/American Standard	BAYFTFR17M	8	17-1/2 x 27 x 5	17-1/16 x 26-1/4 x 4-15/16
Trane/American Standard	BAYFTFR17M2	8	17-1/2 x 27 x 5	17-1/16 x 26-1/4 x 4-15/16
Trane/American Standard	FLR06069	8	17-1/2 x 27 x 5	17-1/16 x 26-1/4 x 4-15/16
Trane/American Standard	BAYFTFR21M	8	21 x 27 x 5	20-5/8 x 26-1/4 x 4-15/16
Trane/American Standard	BAYFTFR21M2	8	21 x 27 x 5	20-5/8 x 26-1/4 x 4-15/16
Trane/American Standard	FLR06070	8	21 x 27 x 5	20-5/8 x 26-1/4 x 4-15/16
Trane/American Standard	BAYFTA21M	8	21-1/2 x 21 x 5	21-1/16 x 19-1/2 x 4-15/16
Trane/American Standard	BAYFTA21M2	8	21-1/2 x 21 x 5	21-1/16 x 19-1/2 x 4-15/16
Trane/American Standard	FLR06072	8	21-1/2 x 21 x 5	21-1/16 x 19-1/2 x 4-15/16
Trane/American Standard	BAYFTA23M	8	23 x 21 x 5	23-1/16 x 21 x 4-15/16
Trane/American Standard	BAYFTA23M2	8	23 x 21 x 5	23-1/16 x 21 x 4-15/16
Trane/American Standard	FLR06073	8	23 x 21 x 5	23-1/16 x 21 x 4-15/16
Trane/American Standard	BAYFTFR24M	8	24 x 26 x 5	24-1/16 x 26-1/4 x 4-15/16
Trane/American Standard	BAYFTFR24M2	8	24 x 26 x 5	24-1/16 x 26-1/4 x 4-15/16
Trane/American Standard	FLR06071	8	24 x 26 x 5	24-1/16 x 26-1/4 x 4-15/16
Trane/American Standard	BAYFTA26M	8	26 x 21 x 5	25-5/16 x 19-15/16 x 4-15/16
Trane/American Standard	BAYFTA26M2	8	26 x 21 x 5	25-5/16 x 19-15/16 x 4-15/16
Trane/American Standard	FLR06074	8	26 x 21 x 5	25-5/16 x 19-15/16 x 4-15/16
Trion AirBear	229990-001	8	16 x 25 x 3	15-13/16 x 24-5/16 x 3
Trion AirBear	229990-101	8	16 x 25 x 3	15-13/16 x 24-5/16 x 3
Trion AirBear	248713-101	8	16 x 25 x 3	15-13/16 x 24-5/16 x 3
Trion AirBear	255649-001	8	16 x 25 x 3	15-13/16 x 24-5/16 x 3
Trion AirBear	255649-101	8	16 x 25 x 3	15-13/16 x 24-5/16 x 3
Trion AirBear	259112-001	11	16 x 25 x 3	15-13/16 x 24-5/16 x 3
Trion AirBear	259112-101	11	16 x 25 x 3	15-13/16 x 24-5/16 x 3
Trion AirBear	229990-005	8	16 x 25 x 5	15-13/16 x 24-5/16 x 4-3/4
Trion AirBear	229990-105	8	16 x 25 x 5	15-13/16 x 24-5/16 x 4-3/4
Trion AirBear	255649-005	8	16 x 25 x 5	15-13/16 x 24-5/16 x 4-3/4
Trion AirBear	255649-105	8	16 x 25 x 5	15-13/16 x 24-5/16 x 4-3/4
Trion AirBear	259112-005	11	16 x 25 x 5	15-13/16 x 24-5/16 x 4-3/4
Trion AirBear	259112-105	11	16 x 25 x 5	15-13/16 x 24-5/16 x 4-3/4
Trion AirBear	229990-003	8	20 x 20 x 5	19-11/16 x 20-11/16 x 4-7/8
Trion AirBear	229990-103	8	20 x 20 x 5	19-11/16 x 20-11/16 x 4-7/8
Trion AirBear	255649-003	8	20 x 20 x 5	19-11/16 x 20-11/16 x 4-7/8
Trion AirBear	255649-103	8	20 x 20 x 5	19-11/16 x 20-11/16 x 4-7/8
Trion AirBear	259112-003	11	20 x 20 x 5	19-11/16 x 20-11/16 x 4-7/8

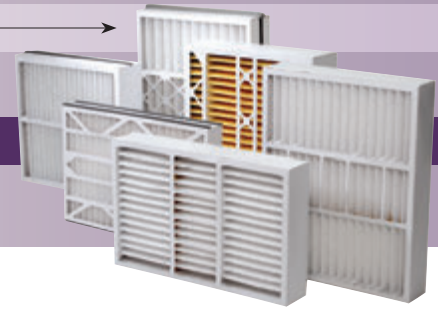

REPLACEMENT FOR OEM STYLE:	OEM FILTER	OEM MERV	NOMINAL SIZE W x H x D	ACTUAL SIZE W x H x D
Trion AirBear	259112-103	11	20 x 20 x 5	19-11/16 x 20-11/16 x 4-7/8
Trion AirBear	229990-002	8	20 x 25 x 5	19-1/2 x 24 x 4-3/4
Trion AirBear	229990-102	8	20 x 25 x 5	19-1/2 x 24 x 4-3/4
Trion AirBear	248713-102	8	20 x 25 x 5	19-1/2 x 24 x 4-3/4
Trion AirBear	255649-002	8	20 x 25 x 5	19-1/2 x 24 x 4-3/4
Trion AirBear	255649-102	8	20 x 25 x 5	19-1/2 x 24 x 4-3/4
Trion AirBear	259112-002	11	20 x 25 x 5	19-1/2 x 24 x 4-3/4
Trion AirBear	259112-102	11	20 x 25 x 5	19-1/2 x 24 x 4-3/4
Ultravation	91-007	11	16 x 25 x 3	15-13/16 x 24-5/16 x 3
Ultravation	91-002	8	16 x 25 x 5	15-13/16 x 24-5/16 x 4-3/4
Ultravation	91-005	11	16 x 25 x 5	15-13/16 x 24-5/16 x 4-3/4
Ultravation	91-025	13	16 x 25 x 5	15-13/16 x 24-5/16 x 4-3/4
Ultravation	91-013	11	20 x 20 x 5	19-11/16 x 20-11/16 x 4-7/8
Ultravation	91-028	13	20 x 20 x 5	19-11/16 x 20-11/16 x 4-7/8
Ultravation	91-003	8	20 x 25 x 5	19-1/2 x 24 x 4-3/4
Ultravation	91-006	11	20 x 25 x 5	19-1/2 x 24 x 4-3/4
Ultravation	91-026	13	20 x 25 x 5	19-1/2 x 24 x 4-3/4
WhiteRogers	FR1000M-108	8	16 x 20 x 4	15-1/2 x 19-1/2 x 3-3/4
WhiteRogers	FR1000M-111	11	16 x 20 x 4	15-1/2 x 19-1/2 x 3-3/4
WhiteRogers	F825-0431/F8110385	10	16 x 21 x 5	16-1/4 x 21 x 5
WhiteRogers	FR1000-100	8	16 x 21 x 5	16-1/4 x 21 x 5
WhiteRogers	229990-101, 255649-101	8	16 x 25 x 3	15-13/16 x 24-5/16 x 3
WhiteRogers	FR1400M-108	8	16 x 25 x 4	15-1/2 x 24-1/2 x 3-3/4
WhiteRogers	FR1400M-111	11	16 x 25 x 4	15-1/2 x 24-1/2 x 3-3/4
WhiteRogers	FIL8250606	11	16 x 25 x 5	15-7/8 x 24-3/4 x 4-3/8
WhiteRogers	F825-0548	8	16 x 25 x 5	15-1/2 x 24 x 4-1/4
WhiteRogers	F825-0548	10	16 x 25 x 5	15-1/2 x 24 x 4-1/4
WhiteRogers	F825-548	8	16 x 26 x 5	16-1/8 x 25-3/4 x 4-7/8
WhiteRogers	FR1400-100	8	16 x 26 x 5	16-1/8 x 25-3/4 x 4-7/8
WhiteRogers	FR1400-401	10	16 x 27 x 6	15-7/16 x 26-15/16 x 6
WhiteRogers	FR1600-100	8	20 x 20 x 4	19-1/2 x 19-1/2 x 3-3/4
WhiteRogers	FR1600M-108	8	20 x 20 x 4	19-1/2 x 19-1/2 x 3-3/4
WhiteRogers	FR1600M-111	11	20 x 20 x 4	19-1/2 x 19-1/2 x 3-3/4
WhiteRogers	F825-0337/F8110321	10	20 x 21 x 5	20-3/4 x 20-5/8 x 5
WhiteRogers	F825-0586	8	20 x 21 x 5	20-3/4 x 20-5/8 x 5
WhiteRogers	FR1600-100	8	20 x 21 x 5	20-3/4 x 20-5/8 x 5
WhiteRogers	FR2000M-108	8	20 x 25 x 4	19-1/2 x 24-1/2 x 3-3/4
WhiteRogers	FR2000M-111	8	20 x 25 x 4	19-1/2 x 24-1/2 x 3-3/4
WhiteRogers	FR2000U-110	10	20 x 25 x 5	19-7/8 x 24-11/16 x 4-1/4
WhiteRogers	FR2000U-10	10	20 x 25 x 5	19-7/8 x 24-1/2 x 4-1/4
WhiteRogers	FR2000U-108	8	20 x 25 x 5	19-7/8 x 24-1/2 x 4-1/4
WhiteRogers	FR2000-401	10	20 x 25 x 6	19-3/4 x 24-1/4 x 6
WhiteRogers	F825-0338/F8110319	10	20 x 26 x 5	20 x 25-7/8 x 4-7/8
WhiteRogers	F825-0549	8	20 x 26 x 5	20 x 25-7/8 x 4-7/8
WhiteRogers	FR2000-100	8	20 x 26 x 5	20 x 25-7/8 x 4-7/8
York	FS1620, M0-1056, MU1620, 9183940	11	16 x 20 x 5	15-3/8 x 21-7/8 x 5-1/4
York	FS1625, M1-1056, MU1625, 9183950	11	16 x 25 x 5	15-3/8 x 25-1/2 x 5-1/4
York	FS2020, M2-1056, MU2020, 9183960	11	20 x 20 x 5	20-1/4 x 20-3/4 x 5-1/4
York	FS2025, M8-1056, MU2025, 9183970	11	20 x 25 x 5	20-1/4 x 25-3/8 x 5-1/4

* Trade names and company names are used for identification purposes only.

THINKSIMPLE. THINKSMART.

THINKQUALITY.



QUALITYFILTERS, INC.

THINKSIMPLE. THINKSMART. THINKQUALITY.

23351 GRISSOM DRIVE
ROBERTSDALE, AL 36567

PHONE: 251.947.2400
FACSIMILE: 251.947.2499
TOLL FREE: 800.635.6820
QUALITYFILTERS.COM

QUALITYINSERTS

QUALITY INSERTS

TYPE 40 PLEATED

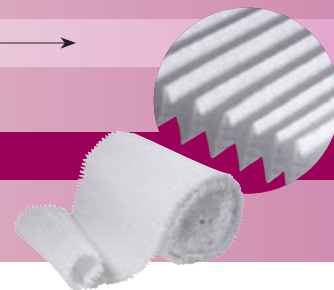

Type 40 Inserts are made with the same media used in our EQP and DQP Pleated Panel Filters. These medias are laminated to a hot dipped galvanized expanded metal and then pleated for increased surface area. Quality Inserts fit into metal holding frames which stay in the filter housing; only the pleated insert is replaced saving cost and disposal space. Quality Inserts can be ordered cut to a specific filter size or in a continuous pleated roll.

1" - 14 PLEATS PER LINEAR FOOT					
NOMINAL SIZE W x H x D	PART NUMBER		CASE LBS	CASE CUBIC FT.	CASE QTY.
12x24x1	QI401412241		11	5.56	50
16x20x1	QI401416201		12	4.44	50
16x25x1	QI401416251		15	4.44	50
18x24x1	QI401418241		16	5.56	50
20x20x1	QI401420201		15	6.94	50
20x25x1	QI401420251		18	6.94	50
24x24x1	QI401424241		21	6.94	50
25x25x1	QI401425251		23	6.94	50

2" - 10 PLEATS PER LINEAR FOOT					
NOMINAL SIZE W x H x D	PART NUMBER		CASE LBS	CASE CUBIC FT.	CASE QTY.
12x24x2	QI401012242		16	6.33	50
16x20x2	QI401016202		18	3.81	50
16x25x2	QI401016252		23	3.81	50
18x24x2	QI401018242		24	6.33	50
20x20x2	QI401020202		23	3.81	50
20x25x2	QI401020252		28	3.81	50
24x24x2	QI401024242		32	6.33	50
25x25x2	QI401025252		35	6.33	50

2" - 12 PLEATS PER LINEAR FOOT					
NOMINAL SIZE W x H x D	PART NUMBER		CASE LBS	CASE CUBIC FT.	CASE QTY.
12x24x2	QI401212242		19	6.33	50
16x20x2	QI401216202		22	3.81	50
16x25x2	QI401216252		27	3.81	50
18x24x2	QI401218242		29	6.33	50
20x20x2	QI401220202		27	3.81	50
20x25x2	QI401220252		33	3.81	50
24x24x2	QI401224242		38	6.33	50
25x25x2	QI401225252		41	6.33	50

4" - 8 PLEATS PER LINEAR FOOT					
NOMINAL SIZE W x H x D	PART NUMBER		CASE LBS	CASE CUBIC FT.	CASE QTY.
12x24x4	QI40812244		26	6.33	50
16x20x4	QI40816204		19	3.81	32
16x25x4	QI40816254		24	3.81	32
18x24x4	QI40818244		26	6.33	32
20x20x4	QI40820204		23	3.81	32
20x25x4	QI40820254		30	3.81	32
24x24x4	QI40824244		34	6.33	32

1" - PLEATED BULK ROLLS					
NOMINAL SIZE W x P x D	PART NUMBER		CASE LBS	CASE CUBIC FT.	CASE QTY.
16x525x1	QIBR40165251		25	9.65	5
18x525x1	QIBR40185251		22	9.65	4
20x525x1	QIBR40205251		25	9.65	4
24x525x1	QIBR40245251		30	9.65	4
25x525x1	QIBR40255251		31	9.65	4

2" - PLEATED BULK ROLLS					
NOMINAL SIZE W x P x D	PART NUMBER		CASE LBS	CASE CUBIC FT.	CASE QTY.
16x420x2	QIBR40164202		9	1.56	1
18x420x2	QIBR40184202		10	3.89	1
20x420x2	QIBR40204202		11	1.56	1
24x420x2	QIBR40244202		13	1.93	1
25x420x2	QIBR40254202		14	1.93	1

4" - PLEATED BULK ROLLS					
NOMINAL SIZE W x P x D	PART NUMBER		CASE LBS	CASE CUBIC FT.	CASE QTY.
16x100x4	QIBR40161004		17	3.81	4
18x100x4	QIBR40181004		19	3.81	4
20x100x4	QIBR40201004		21	3.81	4
24x100x4	QIBR40241004		25	6.33	4
25x100x4	QIBR40251004		26	6.33	4

QUALITY PLEATED INSERTS

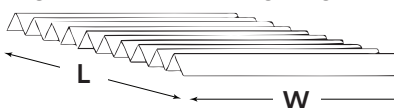

* Non-Standard Widths are not available.

* If your NS insert is longer than a standard length, use the smallest multiple of a standard size insert to equal at least the total length of your NS insert. Ex: QI401220452 = 2 x's the price of QI401220252

THINKSIMPLE. THINKSMART.

THINKQUALITY.

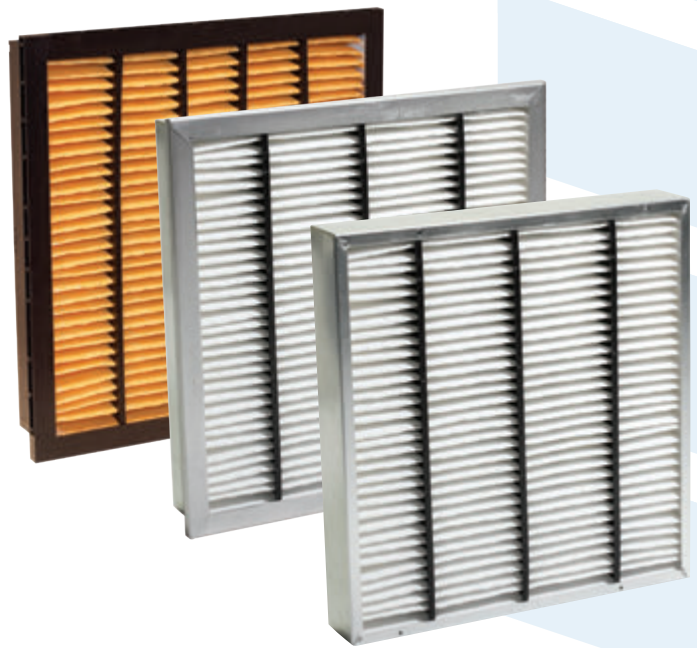

QUALITYFILTERS, INC.
THINKSIMPLE. THINKSMART. THINKQUALITY.

23351 GRISSOM DRIVE
ROBERTSDALE, AL 36567

PHONE: 251.947.2400
FACSIMILE: 251.947.2499
TOLL FREE: 800.635.6820
QUALITYFILTERS.COM

QUALITYFLOW

MAXIMUM ENERGY EFFICIENCY

MAXIMUM ENERGY EFFICIENCY

4" High Efficiency Rigid Cell Filters

THINKQUALITY.

QUALITYFLOW FILTER

The QualityFlow from Quality Filters uses a proprietary media to create a dynamically different filter. This durable filter is cost-effective, has the lowest pressure drop on the market, and lasts longer than standard filters while meeting LEED standards.

FEATURES

- Lower pressure drop than competitors means lower energy costs.
- Available in **MERV 11** and **13** rated per ASHRAE test standard 52.2 and exceeds the LEED standard.
- 4" filter outperforms a standard 12" filter, costs less and stores easily.
- Super durable frame and media resists tearing or damage, resists moisture, and does not support microbial growth.
- Available in 4" with and without header, and cross-bracing.
- Sustainable Component for LEED/ Green Building Initiative.

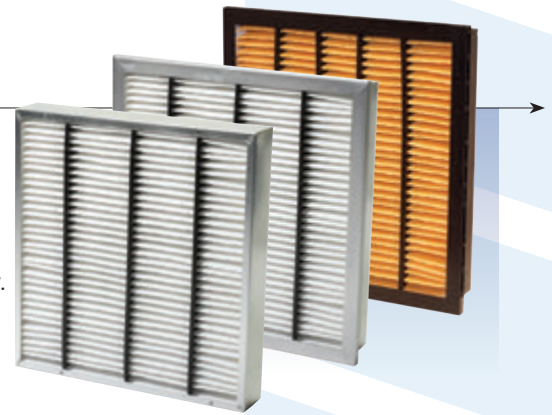

4" QualityFlow, with and without Header

QUALITYFLOW and QUALITYFLOW EXTREME Filters are ideal for:

- Hospitals
- Schools
- Government Buildings
- Office Complexes
- Public Arenas
- General Industrial

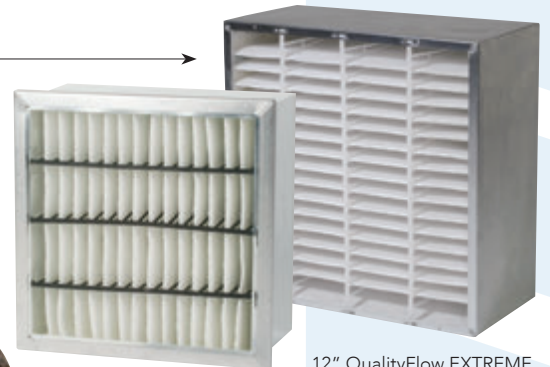

12" QualityFlow EXTREME, without Header (Available with Header)



HAVE A QUESTION? CALL US.

800.635.6820

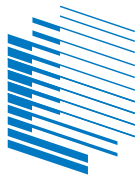

QUALITYFILTERS, INC.

THINKSIMPLE. THINKSMART. THINKQUALITY.

23351 Grissom Drive
 Robertsdale, AL 36567
 www.QualityFilters.com

Phone: (251) 947-2400
 Order Fax: (251) 947-2499
 Sales Fax: (251) 947-7948

QualityFlow Pleated Filter MERV 11 & 13			
Date 27 Jun 11	QF11	Dwg No.	Rev
Date 7 Jul 17	QF13	Q-110034	E

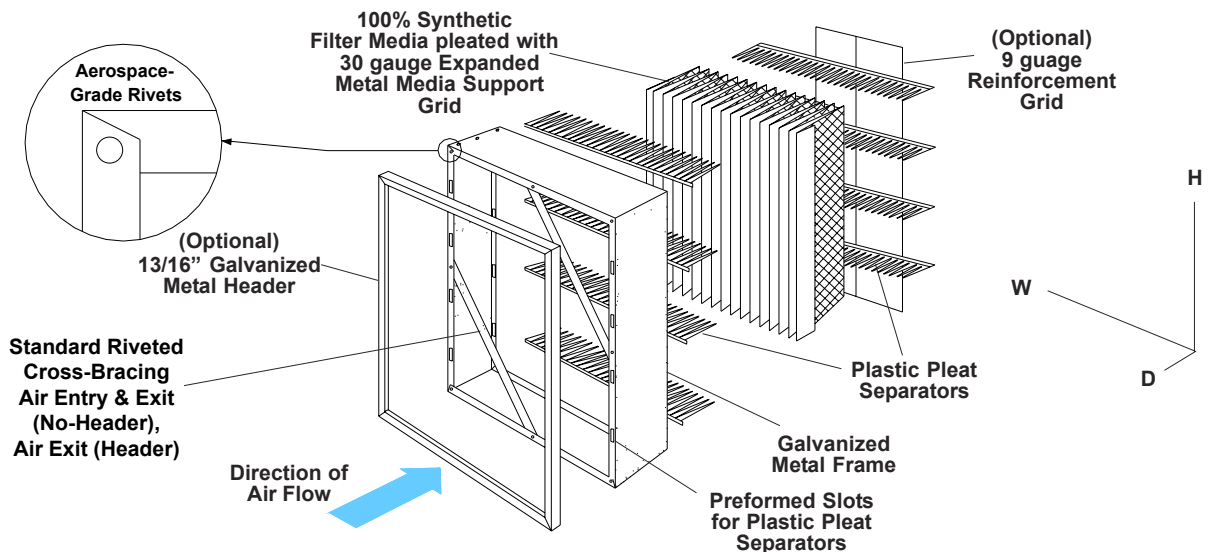

Part Number Guide

Product Code**	Description	Nominal Dimensions w x h x d	Actual Dimensions w x h x d	Sq Feet Media
QF1112244	MERV11	12" x 24" x 4"	11.375" x 23.375" x 3.75"	16
QF1116204	MERV11	16" x 20" x 4"	15.375" x 19.375" x 3.75"	18
QF1116244	MERV11	16" x 24" x 4"	15.375" x 23.375" x 3.75"	22
QF1116254	MERV11	16" x 25" x 4"	15.375" x 24.375" x 3.75"	23
QF1118244	MERV11	18" x 24" x 4"	17.375" x 23.375" x 3.75"	24
QF1120204	MERV11	20" x 20" x 4"	19.375" x 19.375" x 3.75"	23
QF1120244	MERV11	20" x 24" x 4"	19.375" x 23.375" x 3.75"	27
QF1120254	MERV11	20" x 25" x 4"	19.375" x 24.375" x 3.75"	28
QF1124244	MERV11	24" x 24" x 4"	23.375" x 23.375" x 3.75"	33
QFH1112244	MERV11w/hdr	12" x 24" x 4"	11.375" x 23.375" x 3.75"	14
QFH1116204	MERV11w/hdr	16" x 20" x 4"	15.375" x 19.375" x 3.75"	17
QFH1116244	MERV11w/hdr	16" x 24" x 4"	15.375" x 23.375" x 3.75"	20
QFH1116254	MERV11w/hdr	16" x 25" x 4"	15.375" x 24.375" x 3.75"	21
QFH1118244	MERV11w/hdr	18" x 24" x 4"	17.375" x 23.375" x 3.75"	22
QFH1120204	MERV11w/hdr	20" x 20" x 4"	19.375" x 19.375" x 3.75"	21
QFH1120244	MERV11w/hdr	20" x 24" x 4"	19.375" x 23.375" x 3.75"	25
QFH1120254	MERV11w/hdr	20" x 25" x 4"	19.375" x 24.375" x 3.75"	26
QFH1124244	MERV11w/hdr	24" x 24" x 4"	23.375" x 23.375" x 3.75"	31
QF1312244	MERV13	12" x 24" x 4"	11.375" x 23.375" x 3.75"	16
QF1316204	MERV13	16" x 20" x 4"	15.375" x 19.375" x 3.75"	18
QF1316244	MERV13	16" x 24" x 4"	15.375" x 23.375" x 3.75"	22
QF1316254	MERV13	16" x 25" x 4"	15.375" x 24.375" x 3.75"	23
QF1318244	MERV13	18" x 24" x 4"	17.375" x 23.375" x 3.75"	24
QF1320204	MERV13	20" x 20" x 4"	19.375" x 19.375" x 3.75"	23
QF1320244	MERV13	20" x 24" x 4"	19.375" x 23.375" x 3.75"	27
QF1320254	MERV13	20" x 25" x 4"	19.375" x 24.375" x 3.75"	28
QF1324244	MERV13	24" x 24" x 4"	23.375" x 23.375" x 3.75"	33
QFH1312244	MERV13w/hdr	12" x 24" x 4"	11.375" x 23.375" x 3.75"	14
QFH1316204	MERV13w/hdr	16" x 20" x 4"	15.375" x 19.375" x 3.75"	17
QFH1316244	MERV13w/hdr	16" x 24" x 4"	15.375" x 23.375" x 3.75"	20
QFH1316254	MERV13w/hdr	16" x 25" x 4"	15.375" x 24.375" x 3.75"	21
QFH1318244	MERV13w/hdr	18" x 24" x 4"	17.375" x 23.375" x 3.75"	22
QFH1320204	MERV13w/hdr	20" x 20" x 4"	19.375" x 19.375" x 3.75"	21
QFH1320244	MERV13w/hdr	20" x 24" x 4"	19.375" x 23.375" x 3.75"	25
QFH1320254	MERV13w/hdr	20" x 25" x 4"	19.375" x 24.375" x 3.75"	26
QFH1324244	MERV13w/hdr	24" x 24" x 4"	23.375" x 23.375" x 3.75"	31

Notes:

QualityFlow 4" pleated filters are designed to handle high airflow and provide low pressure drop. QualityFlow 4" filters utilize a durable frame and media that stand up to turbulence and abrasion that typical medias cannot withstand. QualityFlow media also provides lower pressure drop than standard mini pleat filters to relieve strain on motors, which reduces energy costs, while providing high dust holding and long filter life. QualityFlow 4" pleated filters are available in MERV 11 and 13 ratings per ASHRAE 52.2.

Performance Data - 24x24x4

Product Code	ASHRAE 52.2 - 1999			Initial Resistance "w.g.		
	MERV Value	E1 %	E2 %	E3 %	@ 492 fpm	@ 492 fpm
QF1124244	11	33	74	90	0.19	1.50
QF1324244	13	60	89	99	0.27	1.50

Characteristics	QualityFlow Pleated Filters
Filter Media - Particulate	100% synthetic gradient media
Media Support Grid	30 gauge expanded metal media support grid
Pleat Separators	Plastic pleat separators
Frame	26 gauge galvanized metal frame
Assembly Technique	Media pack totally bonded to frame - Plastic media separators bonded to preformed slots
Max. Temperature	150°F (65°C) continuous service, Peaks 200°F (93°C)
Max. Humidity	Resistant to 100% R.H.

THINKSIMPLE. THINKSMART.

THINKQUALITY.

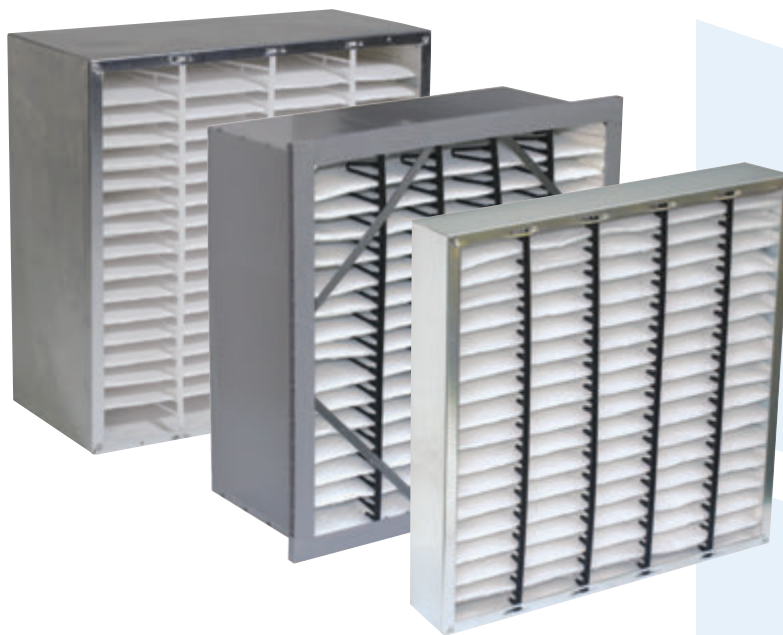

QUALITYFILTERS, INC.

THINKSIMPLE. THINKSMART. THINKQUALITY.

23351 GRISSOM DRIVE
ROBERTSDALE, AL 36567

PHONE: 251.947.2400
FACSIMILE: 251.947.2499
TOLL FREE: 800.635.6820
QUALITYFILTERS.COM



QUALITYFLOW EXTREME

MAXIMUM ENERGY EFFICIENCY

MAXIMUM ENERGY EFFICIENCY

6" & 12" High Efficiency Rigid Cell Filters

→ THINK**QUALITY**

QUALITYFLOW EXTREME FILTER

The QualityFlow Extreme from Quality Filters uses a proprietary media to create a dynamically different filter. This durable filter is cost-effective and has the lowest pressure drop on the market. QualityFlow Extreme offers half the pressure drop and twice the service life of traditional rigid cell filters.

FEATURES

- Lower pressure drop than competitors means lower energy costs.
- Available in **MERV 13 / 14** rated per ASHRAE test standard 52.2 and exceeds the LEED standard.
- Super durable frame and media resists tearing or damage, resists moisture, and does not support microbial growth.
- Available in 6" and 12" with and without header, and cross-bracing.
- Available in plastic or galvanized frame.*
- Outperforms ASHRAE boxes, traditional rigid cell filters, and Vcells.

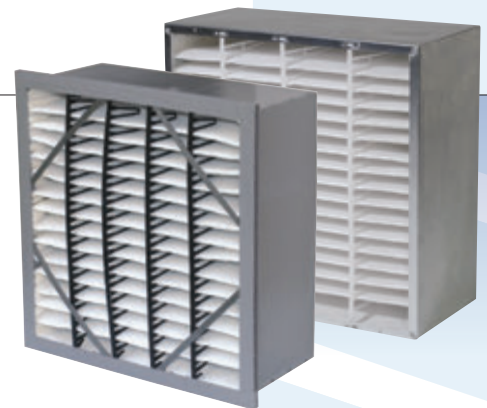

12" QualityFlow Extreme with and without header

QUALITYFLOW EXTREME Filters are ideal for:

Hospitals
Schools

Government Buildings
Office Complexes

Public Arenas
General Industrial



6" QualityFlow EXTREME, also available with header

* Plastic is only available in size 12x24x12 and 24x24x12.

QUALITYFLOW EXTREME Initial Resistance Comparison*

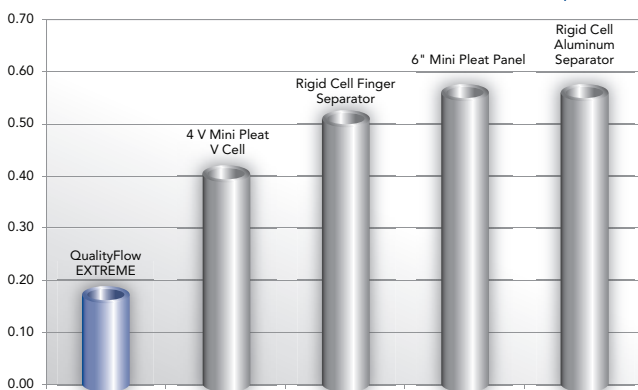

* Airflow for MERV 13 efficiency at 492 FPM.

QualityFlow EXTREME Initial Resistance
 Initial Resistance



HAVE A QUESTION? CALL US.

800.635.6820

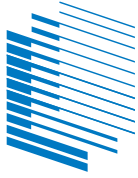

QUALITYFILTERS, INC.

THINKSIMPLE. THINKSMART. THINKQUALITY.

23351 Grissom Drive
 Robertsdale, AL 36567
 www.QualityFilters.com

Phone: (251) 947-2400
 Order Fax: (251) 947-2499
 Sales Fax: (251) 947-7948

Quality Filters		
QualityFlow Extreme MERV 13 & 14		
Date 8 Sep 06	QCNQF13	Rev
Date 24 Jan 17	QCNQF14	F

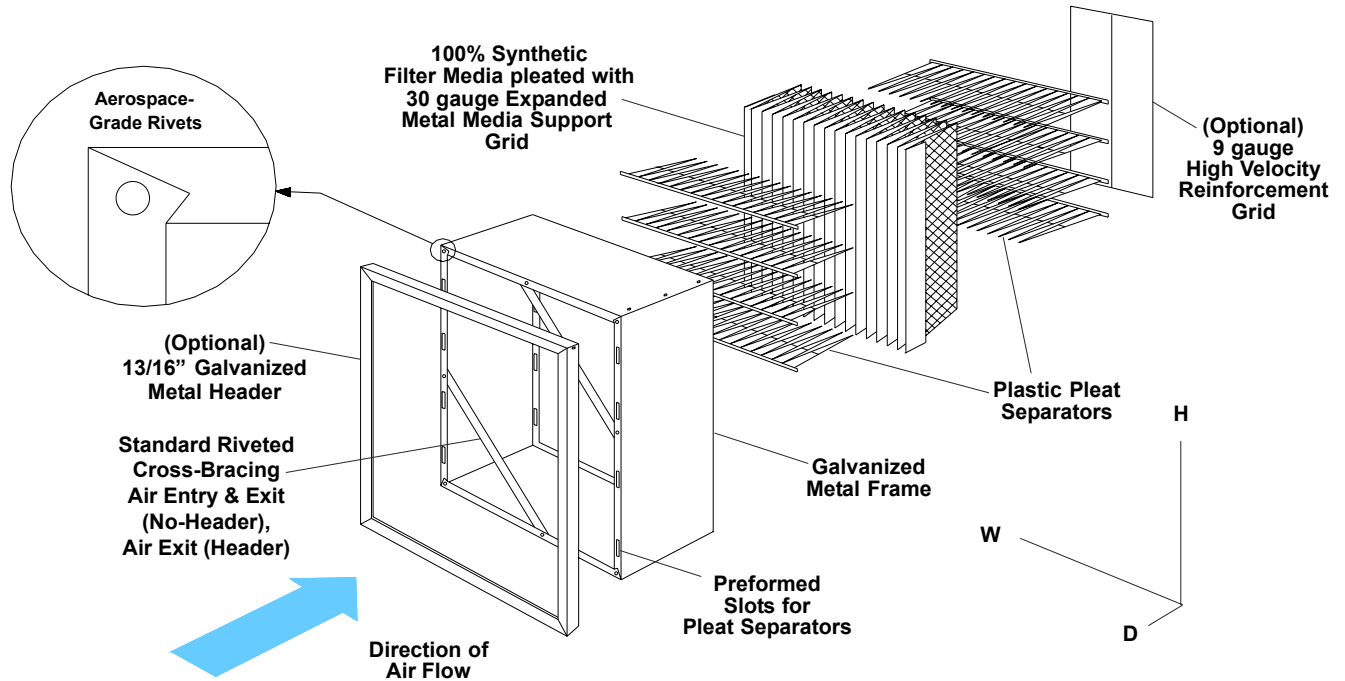

Notes:

QualityFlow Extreme rigid filters are designed to handle high airflow and provide low pressure drop. The QualityFlow media stands up to turbulence and abrasion that typical medias cannot withstand. QualityFlow media also provides 50% lower pressure drop than standard rigid box filters to relieve strain on motors and reduce energy costs, while providing twice the dust holding of standard rigid box filters. QualityFlow Extreme rigid filters are available in MERV 13 and 14 ratings per ASHRAE 52.2.

Performance Data - 24x24x12

Product Code	ASHRAE 52.2 - 1999					
	MERV Value	E1 %	E2 %	E3 %	Initial Resistance "w.g." @ 492 fpm	Final Resistance "w.g." @ 492 fpm
QCNQF13242412	13	62.7	90.3	99.3	0.172	1.400
QCNQF14242412	14	75.7	93.0	98.4	0.23	1.500

* No header, for headered version, add 10%.

Part Number Guide

Product Code**	Description	Nominal Dimensions w x h x d	Actual Dimensions w x h x d	Sq Feet Media
QCNQF13122412	MERV 13	12" x 24" x 12"	11.375" x 23.375" x 11.5"	29
QCNQF13202412	MERV 13	20" x 24" x 12"	19.375" x 23.375" x 11.5"	48
QCNQF13242412	MERV 13	24" x 24" x 12"	23.375" x 23.375" x 11.5"	58
QCHQF13122412	MERV 13 w/Hdr	12" x 24" x 12"	11.375" x 23.375" x 11.5"	25
QCHQF13202412	MERV 13 w/Hdr	20" x 24" x 12"	19.375" x 23.375" x 11.5"	44
QCHQF13242412	MERV 13 w/Hdr	24" x 24" x 12"	23.375" x 23.375" x 11.5"	52
QCNQF14122412	MERV 14	12" x 24" x 12"	11.375" x 23.375" x 11.5"	29
QCNQF14202412	MERV 14	20" x 24" x 12"	19.375" x 23.375" x 11.5"	48
QCNQF14242412	MERV 14	24" x 24" x 12"	23.375" x 23.375" x 11.5"	58
QCHQF14122412	MERV 14 w/Hdr	12" x 24" x 12"	11.375" x 23.375" x 11.5"	25
QCHQF14202412	MERV 14 w/Hdr	20" x 24" x 12"	19.375" x 23.375" x 11.5"	44
QCHQF14242412	MERV 14 w/Hdr	24" x 24" x 12"	23.375" x 23.375" x 11.5"	52

Characteristics	QualityFlow Extreme Rigid Filters
Filter Media - Particulate	100% synthetic gradient media
Media Support Grid	30 gauge expanded metal media support grid
Pleat Separators	Plastic pleat separators
Frame	26 gauge galvanized metal frame
Assembly Technique	Media pack totally bonded to frame - Plastic media separators bonded to preformed slots
Max. Temperature	150°F (65°C) continuous service, Peaks 200°F (93°C)
Max. Humidity	Resistant to 100% R.H.

THINKSIMPLE. THINKSMART.

THINKQUALITY.

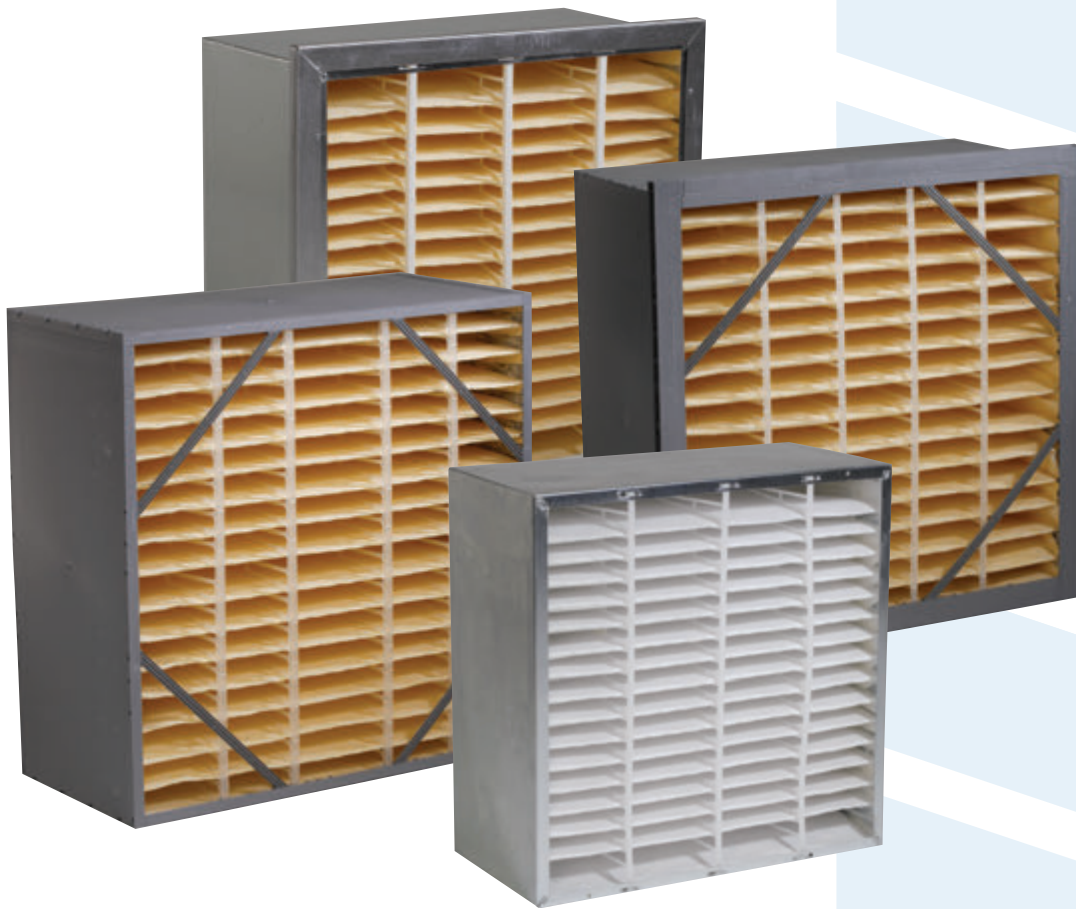

QUALITYFILTERS, INC.
THINKSIMPLE. THINKSMART. THINKQUALITY.

23351 GRISSOM DRIVE
ROBERTSDALE, AL 36567

PHONE: 251.947.2400
FACSIMILE: 251.947.2499
TOLL FREE: 800.635.6820
QUALITYFILTERS.COM



QUALITYCELL
RIGID CELL FILTER

RIGID CELL FILTER

Indoor Air Quality

THINKQUALITY.

QUALITYCELL FILTER

The Quality Cell from Quality Filters is specifically designed for variable air volume systems and turbulent air. These rigid cell filters provide high efficiency filtration in difficult operating conditions where indoor air quality is critical.

FEATURES

- Deep “V” pleats maximize media exposure to air for high dust holding capacity.
- Tapered pleat configuration channels air evenly allowing minimal air-flow restriction.
- Our engineered construction and plastic separators create a durable high efficiency product.
- Plastic finger separators adhere throughout the pleat pack to stabilize the media and prevent dust unloading during turbulence and start up.
- Quality Flow 100% synthetic media and plastic separators are non-carcinogenic, resistant to abrasion, moisture, and microbial growth in MERV 12 through 15.

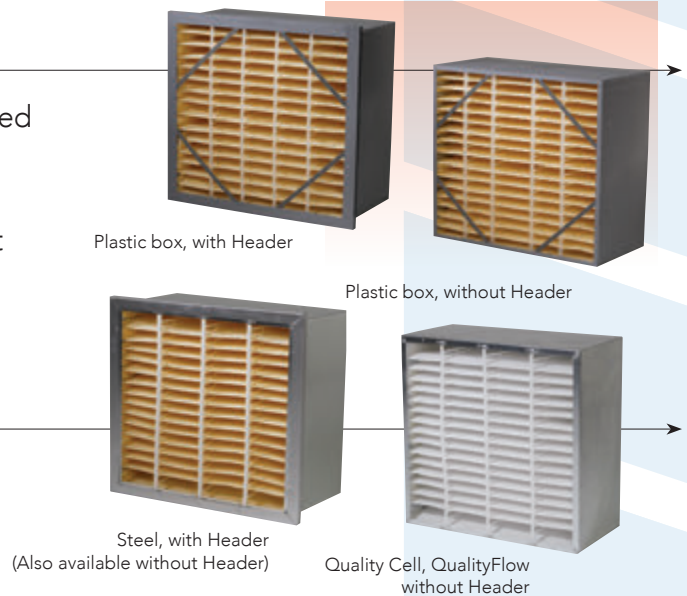

QUALITYCELL Filters are ideal for:

- Hospitals
- Schools
- Office complexes
- Food and Pharmaceutical processes
- General Commercial and Industrial applications

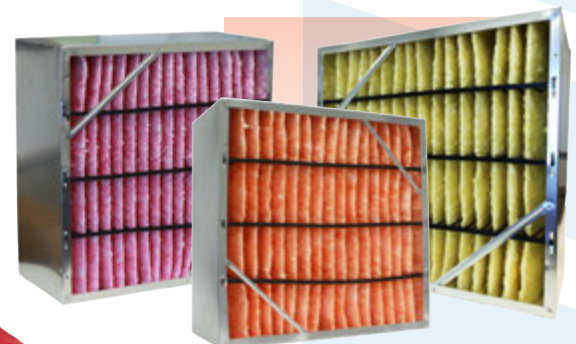
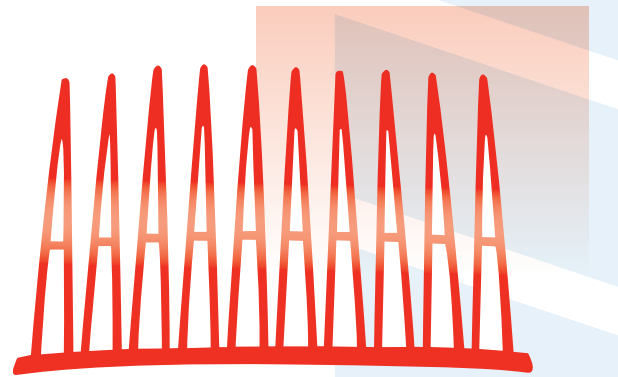

Quality Cell Fiberglass filters available in MERV 11, 14 and 15

HAVE A QUESTION? CALL US.





QUALITY FILTERS, INC.

THINKSIMPLE. THINKSMART. THINKQUALITY.

23351 Grissom Drive
 Robertsdale, AL 36567
 www.QualityFilters.com

Phone: (251) 947-2400
 Order Fax: (251) 947-2499
 Sales Fax: (251) 947-7948

Quality Filters Quality Cell Synthetic		
Date: 14 July 16	Dwg No.	Rev
Date: 14 July 16	Q-110038	E
Date: 13 July 16		
Date: 11 Nov 16		

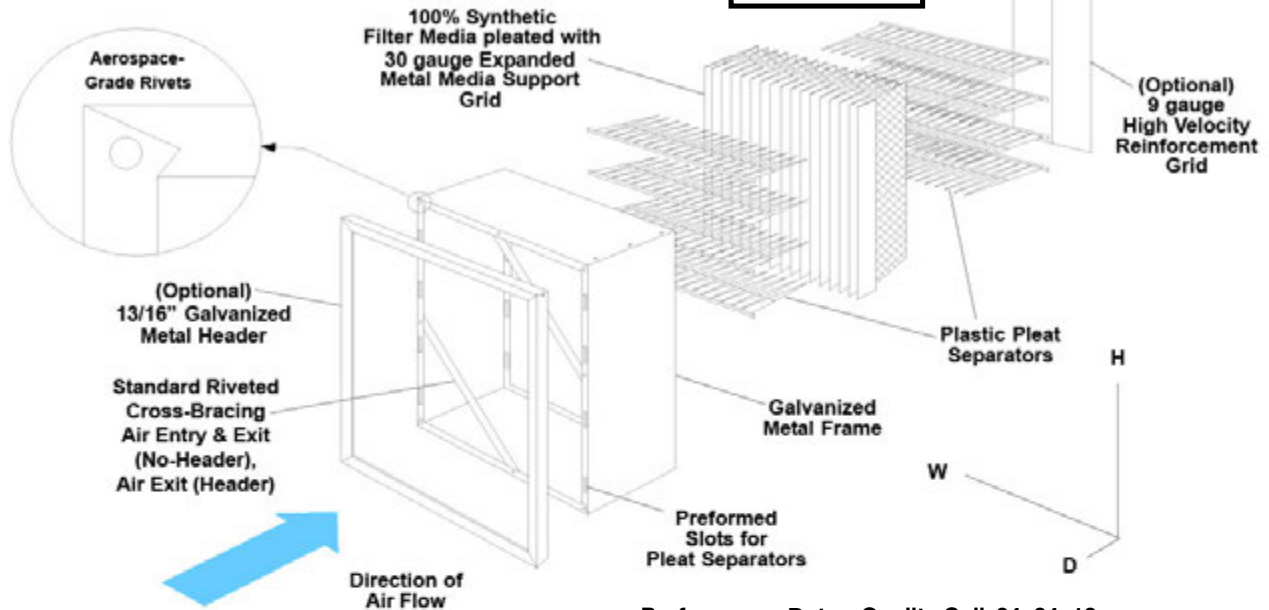

Notes:

Quality Cell rigid filters are designed to provide consistent high efficiency filtration in variable air volume systems and turbulent air. Deep pleats are held firmly in place with plastic separators and expanded metal backing. Every edge of the media pack is glued inside the periphery of the frame to prevent air and dust bypass. The media and separators are 100% polypropylene to resist moisture damage, microbial growth, and puncture damage. Heavy gauge galvanized enclosure frame resists corrosion and maintains its structural integrity for extended months of service. Quality Cells are excellent replacement filters for ASHRAE style metal separator filters and for mini-pleat V cells. Quality Cells are available in MERV 11, 12 13, 14 & OB ratings per ASHRAE 52.2.

Performance Data - Quality Cell 24x24x12

Product Code	ASHRAE 52.2 - 1999					
	MERV Value	E1 %	E2 %	E3 %	@ 492 fpm	
					Initial Resistance "w.g.	Final Resistance "w.g.
QCN6	12	46.3	81.4	96.5	0.287	1.50
QCN8	13	46.3	81.4	96.5	0.325	1.50
QCN9	14	78.7	95.6	99.2	0.654	1.50
QCN15	15	87.4	97.7	99.6	0.393	1.50

* No header, for headered version, add 10%.

Media Area - Quality Cell

Nominal Size w x h x d	Media Area No Header (sq. ft.)	Media Area Header (sq. ft.)	Flow Rate (cfm)	Actual Dimensions w x h x d
12 x 24 x 6	15	13	500	11.375" x 23.375" x 5.5"
16 x 20 x 6	14	17	1111	15.375" x 19.375" x 5.5"
16 x 25 x 6	16	22	1388	15.375" x 24.375" x 5.5"
20 x 20 x 6	20	18	694	19.375" x 19.375" x 5.5"
20 x 25 x 6	23	27	1736	19.375" x 24.375" x 5.5"
24 x 24 x 6	29	27	1000	23.375" x 23.375" x 5.5"
12 x 24 x 12	29	25	1000	11.375" x 23.375" x 11.5"
16 x 20 x 12	32	35	1111	15.375" x 19.375" x 11.5"
16 x 24 x 12	35	43	1333	15.375" x 23.375" x 11.5"
16 x 25 x 12	36	44	1388	15.375" x 24.375" x 11.5"
20 x 20 x 12	40	38	1389	19.375" x 19.375" x 11.5"
20 x 24 x 12	48	44	1667	19.375" x 23.375" x 11.5"
20 x 25 x 12	47	57	1736	19.375" x 24.375" x 11.5"
24 x 24 x 12	58	52	2000	23.375" x 23.375" x 11.5"

Part Number Guide - Quality Cell

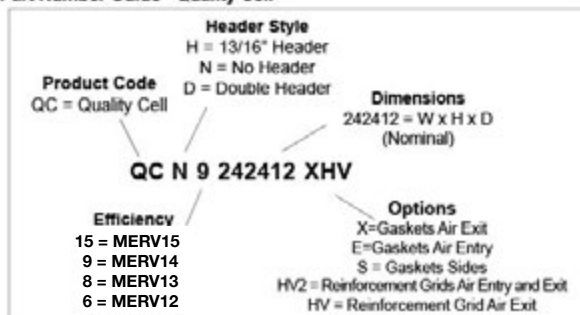

Characteristics	Quality Cell Rigid Filters
Filter Media - Particulate	100% synthetic gradient media
Filter Media - Odor Ban	Fine carbon powder bonded to synthetic media
Media Support Grid	30 gauge expanded metal media support grid
Pleat Separators	Plastic pleat separators
Frame	26 gauge galvanized metal frame
Assembly Technique	Media pack totally bonded to frame - Plastic media separators bonded to preformed slots
Max. Temperature	150°F (65°C) continuous service, Peaks 200°F (93°C)
Max. Humidity	Resistant to 100% R.H.

*Trade names and company names are used for identification purposes only.

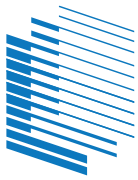

QUALITY FILTERS, INC.

THINKSIMPLE. THINKSMART. THINKQUALITY.

23351 Grissom Drive
 Robertsdale, AL 36567
 www.QualityFilters.com

Phone: (251) 947-2400
 Order Fax: (251) 947-2499
 Sales Fax: (251) 947-7948

Quality Cell - Fiberglass		
Date 05 Aug 15	QC NFG6	Rev B
Date 05 Aug 15	QC NFG8	
Date 03 Aug 15	QC NFG9	
Dwg No. Q-110051		

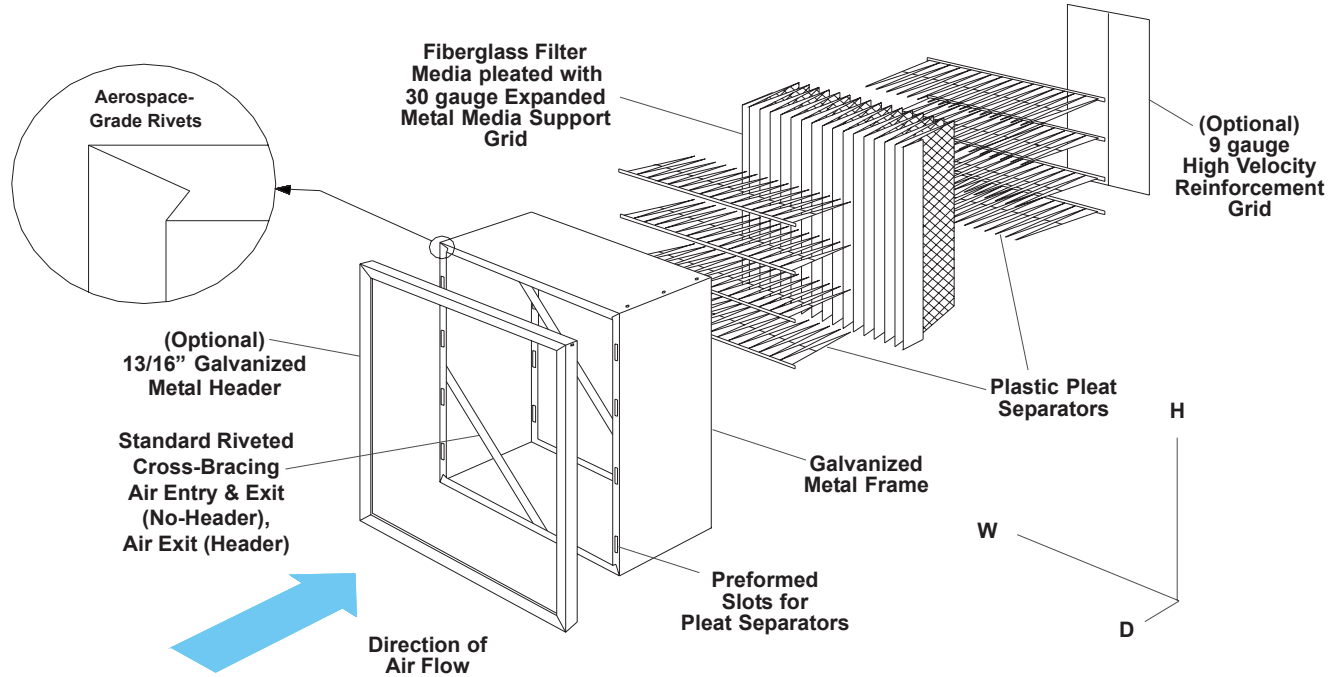

Notes:

Quality Fiberglass rigid cell filters are designed to provide consistent high efficiency filtration in variable air volume systems and turbulent air. Deep pleats are held firmly in place with plastic separators and expanded metal backing. Every edge of the media pack is glued inside the periphery of the frame to prevent air and dust bypass. The separators are 100% polypropylene to resist moisture damage, microbial growth, and puncture damage. Heavy gauge galvanized enclosure frame resists corrosion and maintains its structural integrity for extended months of services. Quality Fiberglass rigid cells are excellent replacement filters for ASHRAE style metal separator filters and for mini pleat v cells. Quality Cells are available in MERV 11, 14 & 15 per ASHRAE 52.2.

Performance Data 24x24x12

Product Code	ASHRAE 52.2			Initial Resistance	Final Resistance	
	MERV Value	E1 %	E2 %	@ 492 fpm	@ 492 fpm	
QC NFG6	11	32.0	66.0	90.7	0.167	1.50
QC NFG8	14	75.2	97.4	99.8	0.574	1.50
QC NFG9	15	86.1	98.8	99.9	0.740	1.50

* No header, for headered version, add 10%.

Media Area - Quality Cell

Nominal Size w x h x d	Media Area No Header (sq. ft.)	Media Area Header (sq. ft.)	Flow Rate (cfm)	Actual Dimensions w x h x d
12 x 24 x 6	15	13	500	11.375" x 23.375" x 5.5"
16 x 20 x 6	14	17	1111	15.375" x 19.375" x 5.5"
16 x 25 x 6	16	22	1388	15.375" x 24.375" x 5.5"
20 x 20 x 6	20	18	694	19.375" x 19.375" x 5.5"
20 x 25 x 6	23	27	1736	19.375" x 24.375" x 5.5"
24 x 24 x 6	29	27	1000	23.375" x 23.375" x 5.5"
12 x 24 x 12	29	25	1000	11.375" x 23.375" x 11.5"
16 x 20 x 12	32	35	1111	15.375" x 19.375" x 11.5"
16 x 24 x 12	35	43	1333	15.375" x 23.375" x 11.5"
16 x 25 x 12	36	44	1388	15.375" x 24.375" x 11.5"
20 x 20 x 12	40	38	1389	19.375" x 19.375" x 11.5"
20 x 24 x 12	48	44	1667	19.375" x 23.375" x 11.5"
20 x 25 x 12	47	57	1736	19.375" x 24.375" x 11.5"
24 x 24 x 12	58	52	2000	23.375" x 23.375" x 11.5"

Part Number Guide - Quality Cell

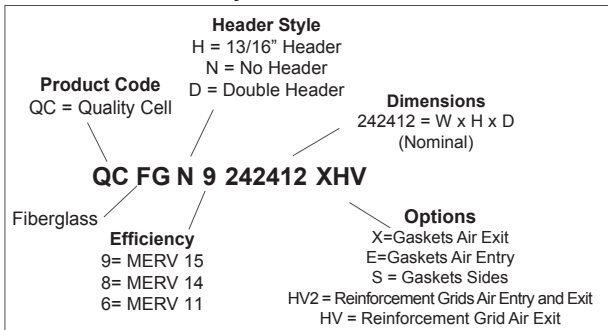

Characteristics	Quality Fiberglass Rigid Cell Filters
Filter Media - Particulate	Fiberglass media
Media Support Grid	30 gauge expanded metal media support grid
Pleat Separators	Plastic pleat separators
Frame	26 gauge galvanized metal frame
Assembly Technique	Media pack totally bonded to frame - Plastic media separators bonded to preformed slots
Max. Temperature	150°F (65°C) continuous service, Peaks 200°F (93°C)
Max. Humidity	Resistant to 100% R.H.

*Trade names and company names are used for identification purposes only.

THINKSIMPLE. THINKSMART. THINKQUALITY.

THINKQUALITY.

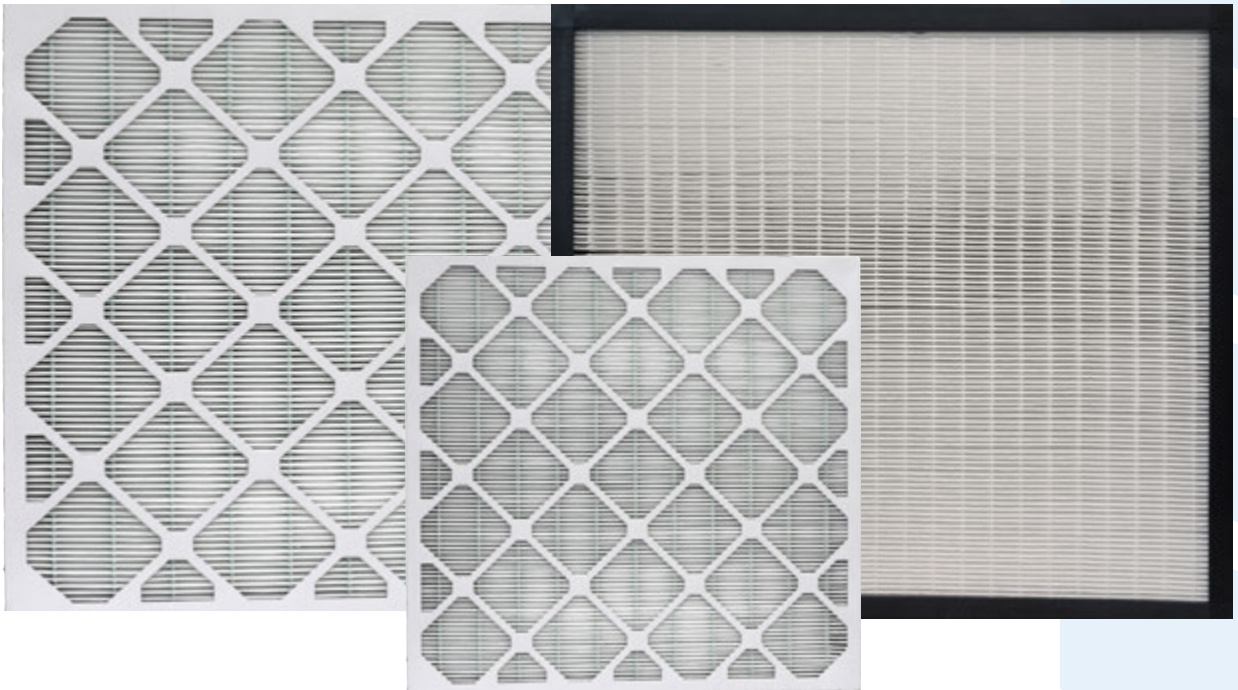

QUALITYFILTERS, INC.
THINKSIMPLE. THINKSMART. THINKQUALITY.

23351 GRISSOM DRIVE
ROBERTSDALE, AL 36567

PHONE: 251.947.2400
FACSIMILE: 251.947.2499
TOLL FREE: 800.635.6820
QUALITYFILTERS.COM



**QUALITYMAX
MINI PLEAT**

HIGH EFFICIENCY PLEATED FILTER

HIGH EFFICIENCY MINI PLEAT FILTER

2", and 4" Pleated Air Filters with durable construction and crisp pleats

THINKQUALITY.

QUALITY MAX FILTER

The Quality Max is a versatile air filter. Quality Max is a loaded media filter that provides high efficiency performance in turbulent environments as well as, more stable operating conditions. With tight pleat consistency, Quality Max offers lower air flow resistance and longer filter life than the average commercial filter. This easy to handle filter performs with low energy usage, while reducing energy costs.

FEATURES

- Available in 4" Single header plastic polypropylene style frame.
- 2" and 4" non-header configuration available in beverage board, plastic or 26 gauge galvanized metal frame.
- Narrow size allows for easy installation and ideal for shipping and handling.
- **MERV 14 and MERV 11** rated per ASHRAE test standard 52.2.
- Bead separators are moisture resistant adding versatility to the filters applications.
- Using Quality Max filters may also help you qualify for LEED® credit under the LEED-EB program.

QUALITY MAX Filters are ideal for:

- Hospitals
- Schools
- Government Buildings
- Office Complexes
- Public Arenas
- General Industrial



HAVE A QUESTION? CALL US.

800.635.6820



QUALITYFILTERS, INC.

THINKSIMPLE. THINKSMART. THINKQUALITY.

23351 Grissom Dr ve
 Robertsdale, AL 36567
 www.QualityFilters.com

Phone: (251) 947-2400
 Order Fax: (251) 947-2499
 Sales Fax: (251) 947-7948

QualityMax Mini Pleat			
Date 07 Oct 16	QMP14	Dwg No.	Rev
Date 02 Aug 16	QMP11	Q-110034	F

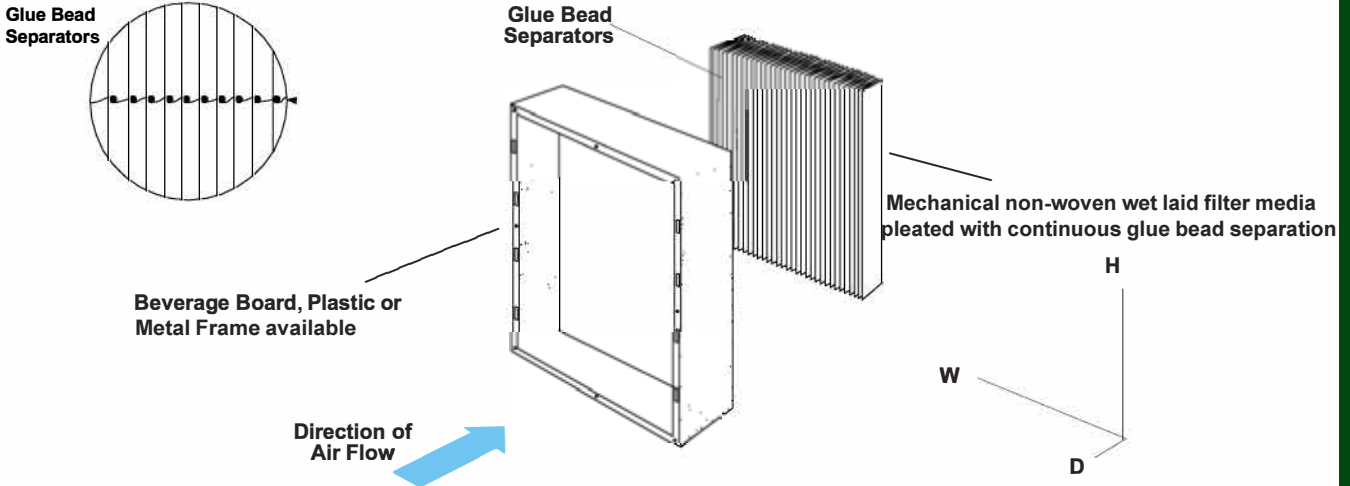

	Nominal Dimensions w x h x d	Actual Dimensions w x h x d	Sq Feet Media
Beverage 2"	12" x 24" x 2"	11.375" x 23.375" x 1.75"	32
	16" x 20" x 2"	15.625" x 19.625" x 1.75"	36
	16" x 24" x 2"	15.5" x 23.5" x 1.75"	43
	16" x 25" x 2"	15.625" x 24.625" x 1.75"	45
	18" x 24" x 2"	17.5" x 23.5" x 1.75"	49
	18" x 25" x 2"	17.5" x 24.5" x 1.75"	51
	20" x 20" x 2"	19.625" x 23.625" x 1.75"	45
	20" x 24" x 2"	19.375" x 23.375" x 1.75"	54
	20" x 25" x 2"	19.625" x 24.625" x 1.75"	56
	24" x 24" x 2"	23.375" x 23.375" x 1.75"	65
Beverage 4"	12" x 24" x 4"	11.5" x 23.5" x 3.625"	63
	16" x 20" x 4"	15.5" x 19.5" x 3.625"	70
	16" x 24" x 4"	15.5" x 23.5" x 3.625"	84
	16" x 25" x 4"	15.5" x 24.5" x 3.625"	88
	18" x 24" x 4"	17.5" x 23.5" x 3.625"	95
	18" x 25" x 4"	17.5" x 24.5" x 3.625"	98
	20" x 20" x 4"	19.5" x 19.5" x 3.625"	88
	20" x 24" x 4"	11.5" x 23.5" x 3.625"	105
Plastic Header	12" x 24" x 4"	11.375" x 23.375" x 3.75"	63
	16" x 20" x 4"	15.375" x 19.375" x 3.75"	70
	16" x 24" x 4"	15.375" x 23.375" x 3.75"	84
	16" x 25" x 4"	15.375" x 24.375" x 3.75"	88
	18" x 24" x 4"	17.375" x 23.375" x 3.75"	95
	18" x 25" x 4"	17.375" x 24.375" x 3.75"	98
	20" x 20" x 4"	19.375" x 19.375" x 3.75"	88
	20" x 24" x 4"	19.375" x 23.375" x 3.75"	105
Plastic or Metal Non-Header	12" x 24" x 4"	11.375" x 23.375" x 3.75"	63
	16" x 20" x 4"	15.375" x 19.375" x 3.75"	70
	16" x 24" x 4"	15.375" x 23.375" x 3.75"	84
	16" x 25" x 4"	15.375" x 24.375" x 3.75"	88
	18" x 24" x 4"	17.375" x 23.375" x 3.75"	95
	18" x 25" x 4"	17.375" x 24.375" x 3.75"	98
	20" x 20" x 4"	19.375" x 19.375" x 3.75"	88
	20" x 24" x 4"	19.375" x 23.375" x 3.75"	105

Notes:

QualityMax 2" and 4" Mini Pleat filters are designed with superior strength and stiffness to provide excellent high efficiency filtration. QualityMax Mini Pleats utilize a frame and Mechanical media combination that stands up to turbulence and abrasion. By design, full media engagement is accomplished. The QualityMax Mini Pleat can help reduce energy costs, provide high dust holding capability and extended filter life. Both 2" and 4" are available in MERV 14 and MERV 11 rating per ASHRAE 52.2. Single header style is available in 4" plastic frame while 2" and 4" no header style are available in beverage board, plastic or a metal frame.

Characteristics	QualityMax Mini Pleat Filter
Filter Media - Particulate	Mechanical non-woven wet laid micro-glass
Pleat Separators	Glue bead separator
Frame	Beverage board, Polypropylene plastic or 26 gauge Galvanized
Assembly Technique	Fully bonded media pack to frame - Glue bead separators to stabilize pleats
Max. Temperature	150°F (65°C) Continuous service 200°F (93°C) Intermittent peak service
Max. Humidity	Resistant to 100% R.H.

Performance Data - Quality Max (24x24x4)

Product Code	ASHRAE 52.2				Initial Resistance "w.g.	Final Resistance "w.g.
	MERV Value	E1 %	E2 %	E3 %		
QMP14	14	77.3	96.1	99.2	0.606	1.50
QMP11	11	26.8	67.4	90.1	0.437	1.50

THINKSIMPLE. THINKSMART. THINKQUALITY.

THINKQUALITY.

QUALITY V-CELL



QUALITYFILTERS, INC.

THINKSIMPLE. THINKSMART. THINKQUALITY.

23351 GRISSOM DRIVE
ROBERTSDALE, AL 36567

PHONE: 251.947.2400
FACSIMILE: 251.947.2499
TOLL FREE: 800.635.6820
QUALITYFILTERS.COM



QUALITYMAX V-CELL

V-CELL HIGH EFFICIENCY PLEATED FILTER

4V-Cell pleated air filters with durable construction and crisp pleats

THINKQUALITY.

QUALITY MAX FILTER

The Quality Max is a versatile air filter. Quality Max is a loaded media filter that provides high efficiency performance in turbulent environments as well as, more stable operating conditions. With tight pleat consistency, Quality Max offers lower air flow resistance and longer filter life than the average commercial filter. This easy to handle filter performs with low energy usage, while reducing energy costs.

FEATURES:

- Available in 4V plastic construction.
- Available in header only.
- MERV 14 per ASHRAE test standard 52.2.
- Bead separators are moisture resistant adding versatility to the filters applications.
- Designed to retrofit existing ducted air filter housings.
- Using Quality Max filters may also help you qualify for LEED® credit under the LEED-E8 program .



QUALITY MAX Filters are ideal for:

- Hospitals
- Schools
- Government Buildings
- Office Complexes
- Public Arenas
- General Industrial



HAVE A QUESTION? CALL US.

800.635.6820

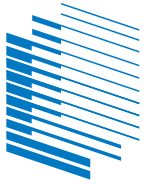

QUALITYFILTERS, INC.

THINKSIMPLE. THINKSMART. THINKQUALITY.

23351 Grissom Drive
 Robertsdale, AL 36567
 www.QualityFilters.com

Phone: (251) 947-2400
 Order Fax: (251) 947-2499
 Sales Fax: (251) 947-7948

QualityMax V-Cell		
Date 3 Mar 16	Dwg No. Q-10001	Rev G

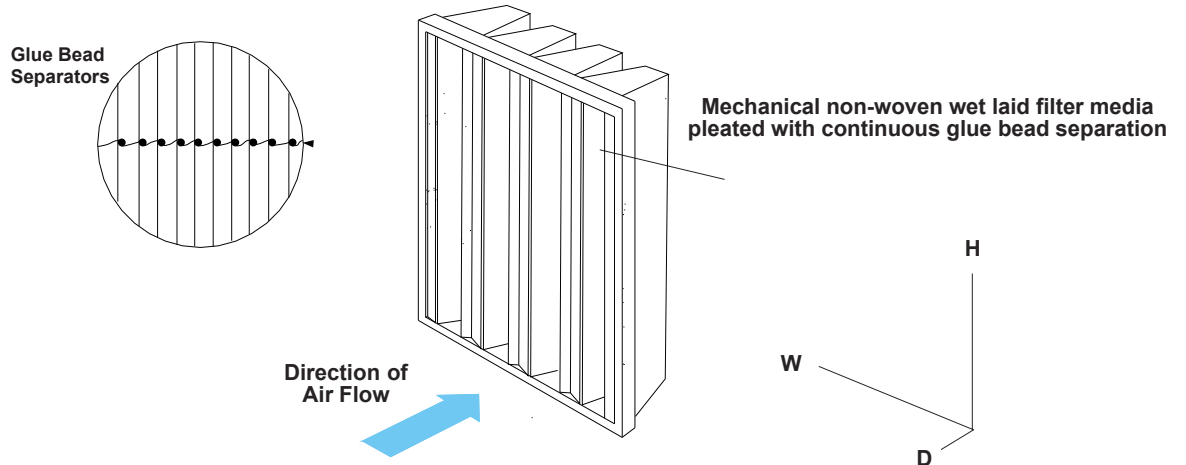

Nominal Dimensions w x h x d	Actual Dimensions w x h x d	Sq Feet Media
12" x 24" x 12"	11.375" x 23.375" x 11.5"	106
20" x 24" x 12"	19.375" x 23.375" x 11.5"	179
24" x 24" x 12"	23.375" x 23.375" x 11.5"	212

Notes:

QualityMax is designed with superior strength and stiffness to provide excellent high efficiency filtration. QualityMax V-Cell filters utilize a Durable frame and Mechanical media combination that stands up to turbulence and abrasion. By design, full media engagement is accomplished. QualityMax V-Cell filters are good alternatives for ASHRAE Cells and Rigid Box filters. The QualityMax V-Cell can help reduce energy costs, provide high dust holding capacity and extended filter life.

QualityMax V-Cells are available in MERV 14 ratings per ASHRAE 52.2.

Characteristics	QualityMax V-Cell Mini Pleat Filter
Filter Media - Particulate	Mechanical non-woven wet laid micro-glass
Pleat Separators	Glue Bead Separator
Frame	Polypropylene plastic
Assembly Technique	Fully bonded media pack to frame - Glue bead separators to stabilize pleats
Max. Temperature	150°F (65°C) Continuous service 200°F (93°C) Intermittent peak service
Max. Humidity	Resistant to 100% R.H.

Performance Data - 24x24x12

Product Code	ASHRAE 52.2			Initial Resistance "w.g. @ 492 fpm	Final Resistance "w.g. @ 492 fpm	
	MERV Value	E1 %	E2 %			E3 %
QVC14	14	77.5	97.0	99.7	0.448	1.50

THINKSIMPLE. THINKSMART.

THINKQUALITY.

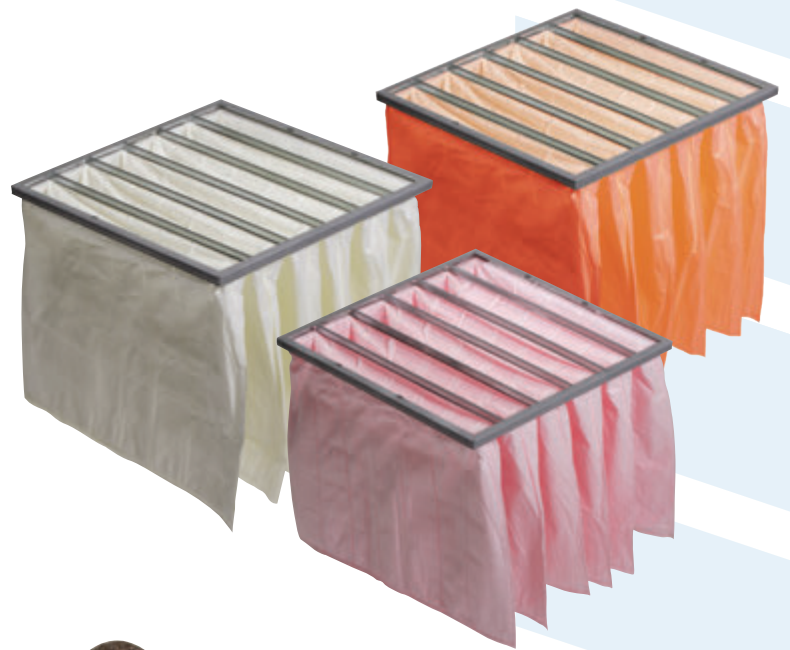

QUALITYFILTERS, INC.
THINKSIMPLE. THINKSMART. THINKQUALITY.

23351 GRISSOM DRIVE
ROBERTSDALE, AL 36567

PHONE: 251.947.2400
FACSIMILE: 251.947.2499
TOLL FREE: 800.635.6820
QUALITYFILTERS.COM

QUALITYPAK
ECONOMICAL SOLUTION

ECONOMICAL SOLUTION

High efficiency multi-pocket bag filters

THINKQUALITY.

QUALITYPAK FILTER

The Quality Pak from Quality Filters is the most economical solution for high efficiency air filtration. We offer **MERV** ratings of 11, 13, and 14 in four standard face dimensions and six standard pocket lengths up to 36".

FEATURES

- High dust holding and efficiency results from lofted microfiber polypropylene.
- Galvanized steel frame provides strength and resists corrosion.
- Non-carcinogenic synthetic media resists microbial growth.
- Scrim media layers prevent tearing and puncturing.
- Metal cover strips eliminate the possibility of dust bypass between pockets and provide added structural integrity.
- Adhesive is applied inside the header and along the opening of each pocket to ensure pockets will not blow out or pull away from the frame.

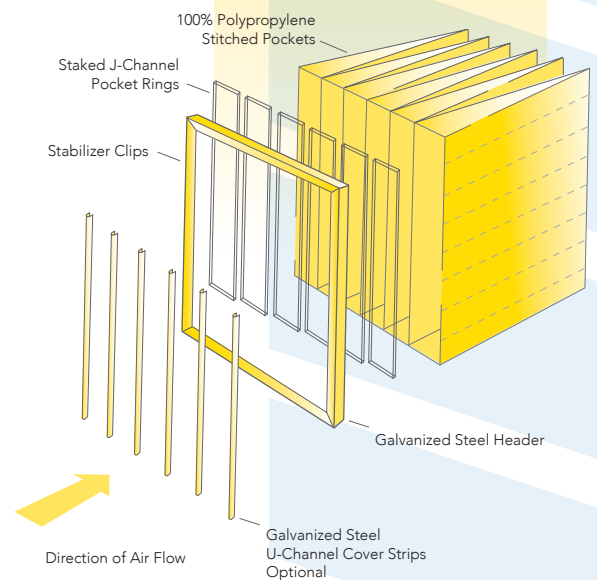
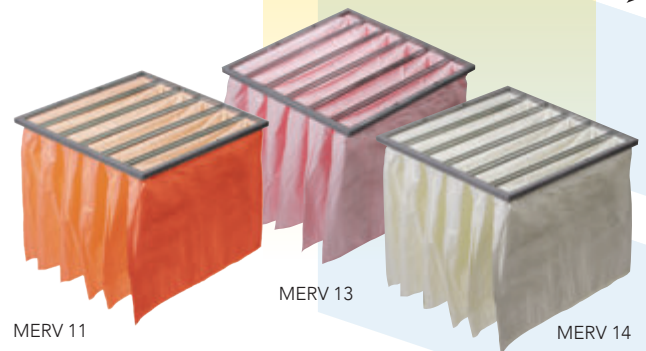

QUALITYPAK Filters are ideal for:

- Hospitals
- Schools
- Office Complexes
- Food and Pharmaceutical processing
- Airports
- Paint Booths
- Refineries
- Computer Rooms
- General Commercial and Industrial applications



HAVE A QUESTION? CALL US.

800.635.6820

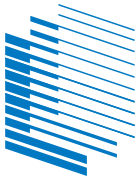

QUALITYFILTERS, INC.

THINKSIMPLE. THINKSMART. THINKQUALITY.

23351 Grissom Drive
 Robertsdale, AL 36567
 www.QualityFilters.com

Phone: (251) 947-2400
 Order Fax: (251) 947-2499
 Sales Fax: (251) 947-7948

QUALITY PAK Synthetic Multi-Pocket Bag Filters			
Date 20 Nov 14	QP6	Dwg No. Q-110002	Rev F
Date 12 Jan 15	QP8		
Date 12 Jan 15	QP9		

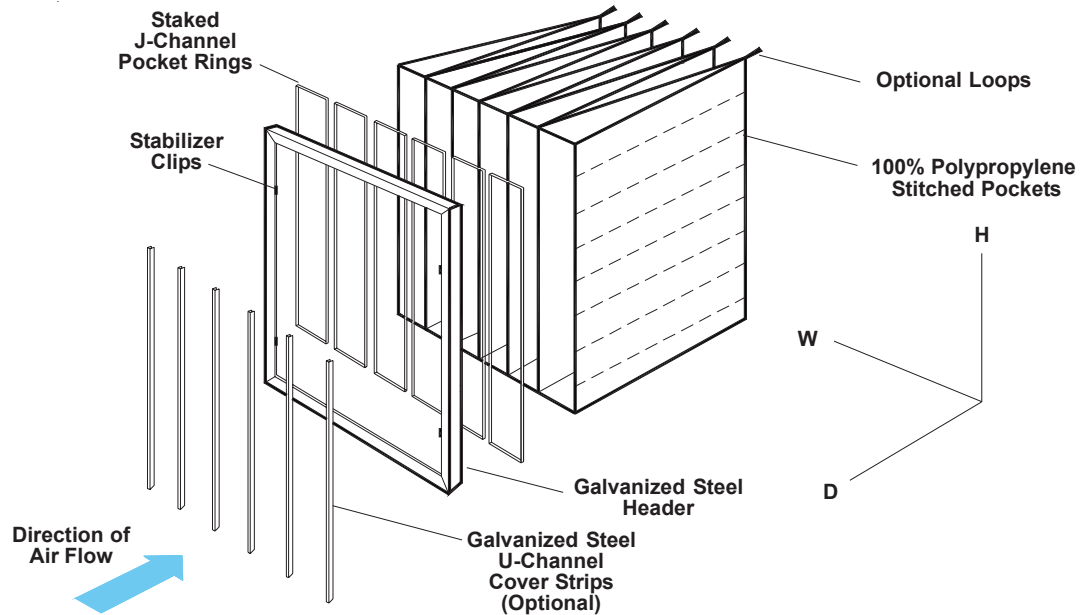

Notes:

Quality Pak filters are available in four standard face dimensions and six standard pocket lengths up to 36" allowing maximum flexibility per system. The Quality Paks are available in non-standard sizes.

Metal cover strips (optional) are affixed with non-flammable adhesive over each adjoining pocket, eliminating the possibility of dust bypass between pockets where staples or clinches are traditionally used. The cover strips also provide added structural integrity to prevent filter blowout.

The U-channel header allows the pocket support channels to extend into the full 13/16" depth of the header to sandwich the media between the pocket support channels and the header. An adhesive is applied inside the header where the metals compress and hold the media. This ensures that pockets will stay firmly in place during installation and service.

**Performance Data -
 Quality Pak (24x24x22 - 8 Pocket Filter)**

Product Code	ASHRAE 52.2				Initial Resistance "w.g."	Final Resistance "w.g."
	MERV Value	E1 %	E2 %	E3 %	@ 492 fpm	@ 492 fpm
QP6	11	39	71	95	0.31	1.50
QP8	13	73	94	100	0.39	1.50
QP9	14	83	97	100	0.45	1.50

Media Area (sq. ft.) by Pocket Length								
		12"	15"	18"	22"	30"	36"	Number of Pockets
Face Dimensions w x h	12x24	13.0	16.3	19.5	23.8	32.5	39.0	
		17.3	21.7	26.0	31.8	43.3	52.0	4
		21.7	27.1	32.5	39.7	54.2	65.0	5
	20x24	21.7	27.1	32.5	39.7	54.2	65.0	5
		26.0	32.5	39.0	47.7	65.0	78.0	6
	20x20	22.0	27.5	33.0	40.3	55.0	66.0	6
	24x24	26.0	32.5	39.0	47.7	65.0	78.0	6
	20x24	34.7	43.3	52.0	63.6	86.7	104.0	8
	24x24	34.7	43.3	52.0	63.6	86.7	104.0	8
		43.3	54.2	65.0	79.4	108.3	130.0	10
		52.0	65.0	78.0	95.3	130.0	156.0	12

Characteristics	Quality Pak Synthetic Bag Filter
Filter Media - Particulate	100% polypropylene lofted microfiber
Assembly Adhesive	Non-flammable adhesive applied to entire header & pocket channels
Support Header & Pocket Support Channels	Galvanized steel support elements staked, riveted and glued into one composite framework for leakproof pocket attachment.
Max. Temperature	150°F (65°C) Continuous service 200°F (93°C) Intermittent peak service
Max. Humidity	Resistant to 100% R.H.

Part Number Guide

Product Code	Efficiency	Pocket Count	Dimensions	Gasketing	Loops
QP	6,8,9	3,4,5,6 8,10,12	WxHxD	X=Air Exit E=Air Entry	T=Top B=Bottom D=Top & Bottom
Example: QP910242422X = Quality Pak, 95% Efficient, 10 Pkt, 24x24x22, gasket on air exit side of header, no loops.					

*Trade names and company names are used for identification purposes only.

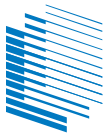

QUALITYFILTERS, INC.

THINKSIMPLE. THINKSMART. THINKQUALITY.

23351 GRISSOM DRIVE
ROBERTSDALE, AL 36567

PHONE: 251.947.2400
FACSIMILE: 251.947.2499

HAVE A QUESTION? CALL OR VISIT US ONLINE.

800.635.6820 | QUALITYFILTERS.COM

