

## Features

- KOHLER® cast iron.
- Drop-in.
- Oval basin.
- With overflow.
- 4-inch centers.
- 19-1/4" (489 mm) x 16-1/4" (413 mm)

## Recommended Accessories

K- 8998 P-Trap



**ADA** **CSA B651** **OBC**

## Codes/Standards











ASME A112.19.1/CSA B45.2  
ADA  
ICC/ANSI A117.1  
CSA B651  
OBC

## KOHLER® Lifetime Limited Warranty for Cast Iron Components

See website for detailed warranty information.

## Available Color/Finishes

*Color tiles intended for reference only.*

Color	Code	Description
	0	White
	96	Biscuit
	47	Almond
	NY	Dune
	95	Ice™ Grey
	G9	Sandbar
	33	Mexican Sand™
	K4	Cashmere
	58	Thunder™ Grey
	7	Black Black™

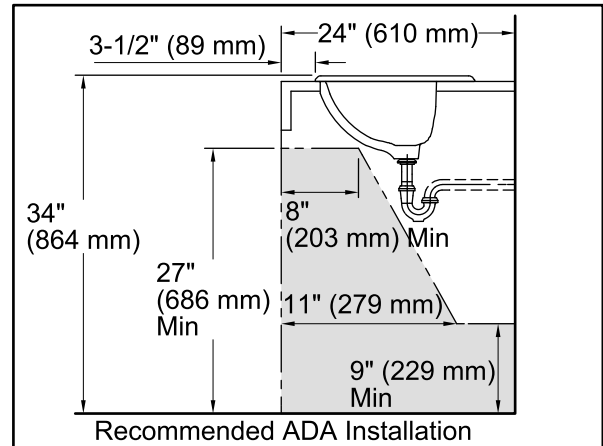
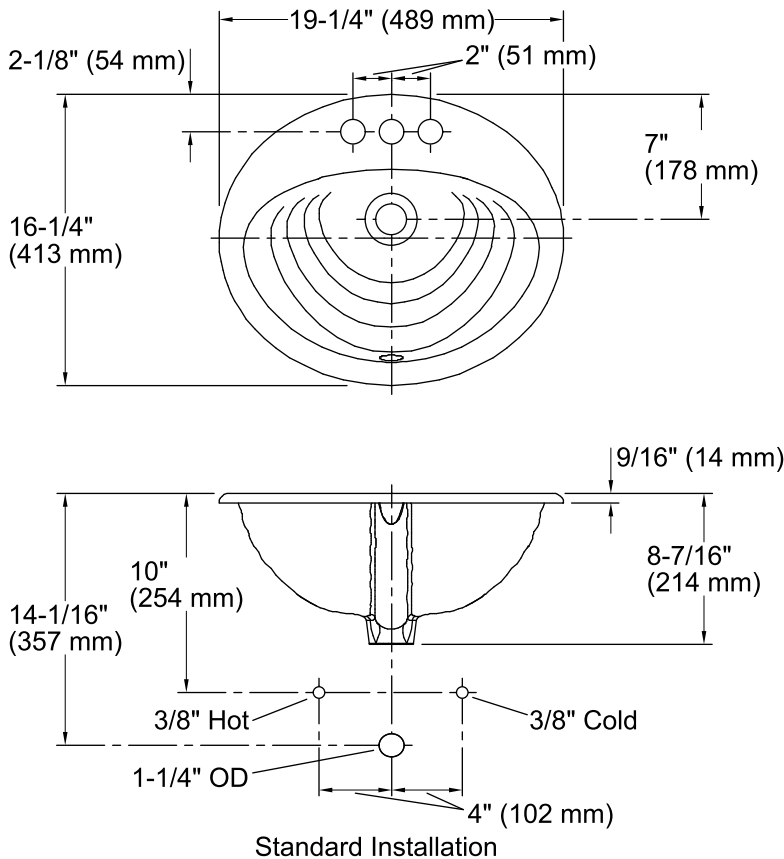

## Technical Information

All product dimensions are nominal.

Bowl configuration:	Single
Installation:	Drop-In
Bowl area	Length: 16" (406 mm) Width: 11" (279 mm) Water depth: 4-7/8" (124 mm)
Number of deck holes:	3
Faucet hole(s):	1-1/4" (32 mm)
Drain hole:	1-3/4" (44 mm)
Template:	Drop-in, 1002972-7, required, included

## Notes

Install this product according to the installation guide.

ADA, OBC, CSA B651 compliant when installed to the specific requirements of these regulations.