



Golf Irrigation

Specification Catalog 2019





Our purpose is to help our customers enrich the beauty, productivity and sustainability of the land. This is our legacy, our purpose, our commitment to both the customers we serve and the generations to come.

You measure rainfall to the one hundredth-of-an-inch. Why wouldn't you manage runtimes to the second?

ANOTHER TORO *EXCLUSIVE*



The INFINITY® Series Sprinkler

NO SHOVEL REQUIRED

The fastest, most comprehensive system health check available.

ANOTHER TORO *EXCLUSIVE*

**Mobile access to the information you need
and the tasks you need to perform.**

LYNX[®] APPS

Only one company is
still committed to
delivering the newest,
most advanced golf
satellite control system.

TORO[®]

**Identify potential issues before
they become irrigation problems.**

ANOTHER TORO EXCLUSIVE



Runtimes set in inches or seconds?
Why not both?

ANOTHER TORO EXCLUSIVE





TABLE OF CONTENTS



Lynx [®] , Field Controllers & Sprinklers Overview.....	6-11
Toro [®] Support.....	12

CONTROL SYSTEMS & FIELD CONTROLLERS

Field Controller Comparison Chart.....	13
Lynx [®] Central Control System.....	14-15
Turf Guard [®] Wireless Soil Monitoring System.....	16-17
Network Radio-Link & FIU with Radio.....	18
National Support Network (NSN [®]).....	19
Lynx [®] Smart Satellite.....	20-21
Lynx Smart Module 2-Wire Control System.....	22-23

CONTROL SYSTEM UPGRADES

OSMAC [®] G3.....	24-25
Network LTC [™] Plus to Network VP [®]	26
Network LTC Plus to LTC Pro.....	26
Radio Interface Unit (RIU).....	27
Sensor Input Kits for Satellite Controllers.....	28-31
Lynx [®] GAC.....	32-33

SPRINKLERS & SUBSURFACE DRIP

Sprinkler Comparison Charts.....	34-35
INFINITY [®] Series Rotors.....	36-51
FLEX800 [™] Series Rotors.....	52-63
FLEX800 [™] B Series Rotors.....	64-67
Main Nozzle Adaptor Performance Charts.....	68-69
FLEX800 [™] R Series Conversion Upgrades.....	70-73
T7 Series Rotors.....	74-75
690 Series Rotors.....	76-77
590GF Sprays.....	78-79
Precision [™] Series Rotating Nozzles.....	80-81
Precision [™] Series Spray Nozzles.....	82-87
Subsurface Drip.....	88-89
Swing Joints.....	90-91
Golf Sprinkler Tools.....	92

VALVES

Valve Comparison Chart.....	93
220G Brass Series Valves.....	94-95
P220G & P220GS Series Valves.....	96-97
Valve Boxes.....	98-99
Dry Boxes.....	100
470 Quick Coupler Valves.....	101

GOLF LIGHTING

Twilight [™] Golf Cup & Perimeter Lighting.....	102-103
----------------------------------------------------------	---------

RESOURCES

Wire Sizing and Technical Data.....	104
Warranty.....	105
Golf Irrigation Distributors.....	106-107



More information & demo video on www.toro.com/lynx

BETTER INFORMATION FOR BETTER CONTROL

The Toro® Lync Central Control System was developed from customer input to provide a system that would not only help with today's jobs, but be ready for what is coming tomorrow. With Lync, you can now have all of your essential irrigation information readily available in one place, conveniently combined into a single, intuitive interface.

WHAT CUSTOMERS ARE SAYING ABOUT LYNX

"I always look forward to the new Lync release to see how many of my ideas got added in."



Easy to Set Up

"It's very easy to learn and we receive lots of support if needed."

"Easy to use and train others to use successfully easier to dial in programs."

"We went from a system where gaining information was like getting blood from a stone to Lync where information and monitoring is as good as I have seen."



Easy to Use

"Best and simplest system available."

"The software is easy to use and the irrigation heads are the best available."

"Lync makes my job easier on a daily basis."

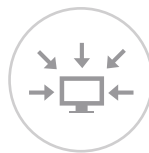

Easy to Access

"Lync is very easy to use from mobile apps without the use of a handheld radio."

"Everything is where it is supposed to be and easily accessible."

"It is easy, reliable, great support and easy to access remotely."



Superior Support

"NSN makes life easy when you have problems."

"From our distributor to NSN and Riverside. People are what make it work."

"The support is unlike any other company."

"The product support is leading the industry."

Lynx Central Control enables the integration of other critical systems to manage your irrigation system with un-paralleled performance, un-matched efficiency and the most comprehensive data access in the industry.

TURF GUARD® WIRELESS MOISTURE SENSOR

- Get current conditions and historic trends
- Understand where you are now, how you got there, and where you are going
- Make databased irrigation decisions

PUMP STATIONS

- Get current status, alarm monitoring and notification
- Maximize wire to water efficiency
- Reduce energy costs
- Works with: Flowtronex, Watertronics, Motor Controls or Grundfos

WEATHER STATIONS

- Use the weather data for irrigation scheduling
- Monitor and respond to rain fall by adjusting runtimes or suspending irrigation all together
- Works with either Campbell Scientific or Spectrum Technologies

FLOW SENSORS

- Monitor flow amounts against what Lynx has scheduled to ensure pipe breaks do not go undetected
- Dial in the sprinkler performance data to manage water utilization
- Works with Toro, Bermad or Data Industrial



Lynx® Mobile Apps Provide Remote Control

Lynx Mobile Apps enable you to control your irrigation system from your smart phone or tablet. Available for both iPhone®** and Android™* devices, Lynx Mobile Apps offer map and numeric based interfaces for manual irrigation, as well as an easy way to enter or edit LSM addresses.

* iPhone and the Apple logo are registered trademarks of Apple, Inc. in the U.S. and other countries.

** Android and the Android logo are trademarks or registered trademarks of Google Inc.



Lynx Map



Lynx Handheld



Lynx Barcode



Lynx Dash



NSN Connect V2



TORO FIELD CONTROLS

Innovative, Flexible and Best-in-Class Field Control Options



Custom pedestal color options help satellites blend into their natural surroundings

LYNX Smart Satellite Control

Provides distributed control and added security via intelligent field controllers with an intuitive user interface

- ✓ Station Based Flow Management helps reduce water window and optimize pump operation
- ✓ Current Sensing provides protection by monitoring each station output for proper amperage draw
- ✓ Stores and runs a fully flow-managed irrigation schedule in the event the central computer is offline
- ✓ Stand-alone capabilities enable you to conduct manual irrigation directly from the satellite faceplate
- ✓ Station runtimes are executed to the second to provide precise irrigation
- ✓ 2-way wired or wireless communication options enable flexible system design and installation

LYNX Smart Module

Provides direct control via intelligent modules installed inside or near each sprinkler

- ✓ All system components are below ground, which helps maintain course aesthetics
- ✓ Lowest cost system option due to reduced amount of wire
- ✓ Continuous 2-way communication and automated diagnostics ensure system integrity
- ✓ Best-in-class broadband lightning protection
- ✓ System can be expanded easily by adding modules to the wire path
- ✓ Lynx Smart Hub provides additional features and benefits



Toro INFINITY® and FLEX800™ Series sprinklers can be ordered with integrated LSM modules

LYNX Smart Hub

Lynx Smart Hub is a new type of field controller that adds security, programmability and sensing to the benefits and simplicity of a 2-wire system.

- ✓ Irrigation system can be segmented into manageable areas for simplified maintenance
- ✓ Provides for in-field manual operation or troubleshooting
- ✓ Stores and runs a fully flow-managed irrigation schedule in the event the central computer is offline
- ✓ Creates a convenient point of connection for soil, flow and status sensors





More information on

www.toro.com/golf

The Lynx[®] Central Control System integrates seamlessly with Toro's Field Control options, enabling you to have the complete information needed to support your irrigation decisions.



Lynx[®]
Central Control



More information & demo video on
www.toroinfinity.com

INFINITY® SERIES GOLF SPRINKLERS

Engineered for Today's Challenges.
 Designed for Tomorrow's Technologies.

The INFINITY® Series improves your course quality with less workload and most important, it keeps golfers playing. Calculate the money you'll save by cutting sprinkler maintenance from hours to minutes.



Smart Access®

Provides top accessibility to all critical components.

- ✓ No digging or unsightly turf repair scars
- ✓ Pilot valve removable with water "ON"
- ✓ Lynx® Smart Module (LSM)
- ✓ Customizable marker
- ✓ No buried wire splices or ground faults
- ✓ Replaceable cover if damaged
- ✓ Increased labor efficiency
- ✓ Lower long term cost of ownership



Future Proof

The SMART ACCESS® compartment provides room to grow. Whatever the future holds, this sprinkler is ready.



Protective Enclosure

The protective enclosure isolates wire splices from the soil and potential shorts to ground. Provides access for system troubleshooting and repairs without digging!



FLEX800™ SERIES GOLF SPRINKLERS

Golf sprinklers with all the efficiency and proven performance features and benefits of the 800S and DT Series

FEATURES AVAILABLE IN INFINITY AND FLEX800 SERIES

TRAJECTORY ADJUSTMENT



24-position TruJectory™ or Dual trajectory to help fight the wind, avoid obstacles or reduce the radius.

NOZZLE BASE CLUTCHING

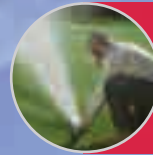

Hot spot watering has never been easier, simply turn, hold and shoot to put down as much water as needed.

LARGE NOZZLE SELECTION



From 20' to 100' we've got you covered! Toro provides the flexibility to optimize your system for maximum uniformity.

PART AND FULL CIRCLE MODELS



Align part circle sprinklers quickly and easily or adjust watering locations to suit seasonal needs.





Toro Technical Support

Our technical support team is highly skilled at what they do. From helping superintendents program controllers, to troubleshooting complex system issues with consultants, the support team provides years of irrigation experience that you can count on. For exceptional technical support, call **1-877-345-TORO (8676)**.



Toro Controller Repair

Did you know that with Toro's Board Exchange Program you can get the replacement controller boards you need immediately? Through your distributor, Controller Repair provides controller boards ready for immediate board exchange to assure that controller downtime is minimal and your golf course and reputation stays protected. For immediate assistance call: **1-877-345-TORO (8676)**.

Visit Controller Repair website at www.toro.com/controller-repair



Toro Distributor Support

Our distributors have been our partners for an average of 40 years (10 to 88 years) and we consider them an extension of us. See page 98 for a list of Toro Golf Irrigation Distributors.



Toro Field Service

With some of the most knowledgeable and helpful field service staff in the industry, and our extensive training and support programs; Toro field service personnel are always there to assist—before, during, and well after a sale.



Toro Genuine Parts

From the smallest sprinkler part to complete control systems, Toro Service Parts Support can deliver most replacement parts to our distributors within hours. In fact, Toro offers its customers the highest parts order completion rate in the industry: 98%!



Toro Financing

By offering a variety of customized, competitive financing plans, Toro gives you "one-stop shopping" eliminating the need for third-party funding. You can improve your course without draining your budget.



Toro National Support Network (NSN®)

A team of A+ certified technicians and licensed irrigators dedicated to the daily operations and maintenance of computerized central control systems for customers worldwide. (See page 19 for more information.)

CONTROL SYSTEM AND FIELD CONTROLLERS



*Lynx® Central Control System
Pages 14-15*

Field Controller Comparison Charts

Feature/Capability	Lynx Smart Satellite	Lynx Smart Hub
Catalog Pages	20-21	22-23
Maximum Stations Per Controller	64	1000
Maximum Simultaneously Operating Stations Per Controller	32	200
Stand-alone Programs	64	8
Wireline Field Communication	Yes	Yes
Wireless Field Communication	Yes	Yes
Upload Field Changes	Yes	No
Field Controller Alerts	Yes	Yes
Downloaded Programs	Yes	Yes
Station Based Flow Management	Yes	Yes
Station Current Sensing	Yes	Yes
Station Runtimes In Seconds	Yes	Yes



The Toro® LYNX® Control System was developed specifically to help you address the unique challenges and changing priorities you face every day. With the LYNX System, you can now have all of your essential irrigation information readily available in one place, conveniently combined into a single, intuitive interface.

WHAT'S NEW IN LYNX 7.0

Lynx Smart Module Hardware Platform Added Including:

- Runtime Resolution** to the minute and second
- Standard Diagnostics** include Communication, Volts and Amps
- Map Selection** of stations for Standard Diagnostics
- Express Diagnostic** includes Communication, Amps and Volts
- Simultaneous Diagnostics** when multiple Smart vs used
- Station Mapping** in the Express method
- Synchronization** with mapping error detection and automatic remapping
- Diagnostic Results** color coded and displayed on the map with values
- Station Status Report** showing volts, amps and line balance
- LSM Firmware Update** from Lynx computer
- Lynx apps** support Lynx Smart Module platform
- Active Days** on Watering Plan includes Interval days control.
- Automatic Verification Polling** control
- Manual Verification Polling** control
- Threshold Setting** for map station labels



SPECIFICATIONS – Lynx® Levels Comparison

SYSTEM CAPACITY	Lynx CE	Lynx PE	Lynx SE
Satellites	500	500	500
Satellite Stations	32,000	1344	512
LSM Stations	6400	1000	500
Weather Stations	10	10	10
Pump Stations	10	3	2
Courses	3	2	1
Holes	48	48	48
Hydraulic Branches	1024	300	100
HARDWARE SUPPORTED			
Lynx® SMART HUB	Yes	Yes	Yes
OSMAC® G3	Yes	Yes	Yes
LSM	Yes	Yes	Yes
Lynx® Smart Satellite	Yes	No	No
PROGRAMMING			
Current Sensing	Yes	No	No
Station Adjust Upload	Yes	No	No
Site Code Categories	7	3	No
Precip. Mgmt. Groups (PMG)	Yes	Yes	No
Max. Stations/Hole Control	Yes	Yes	No
Instant Program Creation	Yes	Yes	Yes
Program Priority	Yes	Yes	No
Pump Profiling	Yes	Yes	No
Station Group Multi-Manual	Yes	No	No
Master Group Multi-Manual	Yes	No	No
Pump Integration	Yes	Yes	Optional
Weather Station Alarms	Yes	Yes	Optional
ET Auto Calc. RT Method	Yes	Yes	Optional

ADDITIONAL FEATURES SMART SET UP

Runtimes:

- Runtimes are executed to the second rather than rounding to the whole minute, resulting in more precise irrigation and water savings
- Control your irrigation by setting runtime or application inches and let the system calculate. See exactly how much water you will apply and how long you will irrigate each area
- Integrated runtime display shows past and planned irrigation activity so you can easily determine what action to take

Quick Start:

- With Quick Start, you create station, hardware and area associations, and control the definition of greens, tees, fairways and sprinklers based on their locations
- A basic hydraulic tree is auto-generated for you during Quick Start

Communication:

- Current-sensing capabilities notify you of wire cuts and sprinklers unintentionally turned off
- Constant communication with Lynx Smart Hub satellites lets you take action if a power outage threatens irrigation
- Toro LSM communication and solenoid diagnostics help identify shorts, low voltage and other issues
- Weather station integration and Handheld Remote Interface support are included as standard features

Ease of Access:

- Lynx Dash – Turf Guard, pump storm local weather, Lynx status
- Lynx Map – GPS location, manual operation, favorites
- Lynx Handheld – All in one command set, command log, last dialed
- Lynx Bar Code – Add or replace, field test of new units



NSN® Connect V2

Remote access so that you can control irrigation anytime, anywhere from any web enabled device.

Specifying Information—Lynx Central

LX-0X-X-XX				
Model	Computer Hardware	Service	Levels	Field Hardware
LX	0X	X	X	X
LX-LYNX Central Control	1—Standard Computer 4—Premium Computer	1—1-year NSN 5—5-years NSN	0—CE 1—SE 2—PE	1—For OSMAC 7—For Lynx Smart Satellite 8—For 2-wire
Example: When ordering a LYNX Central standard computer with one year of NSN and CE Level with Lynx Smart Satellite field hardware, you would order: LX-01-1-07				

Specifying Information—Lynx CE Central Upgrade for SitePro®

Model	Description
LYNX-NSN-STAN	Lynx Upgrade - NSN – Standard Toro Computer
LYNX-NSN-PREM	Lynx Upgrade - NSN – Premium Toro Computer
LYNX-NONNSN-STAN	Lynx Upgrade-NSN-Standard Computer and 1-year NSN Support
LYNX-NONNSN-PREM	Lynx Upgrade-NSN-Premium Computer and 1-year NSN Support
LX-SW	Software, Lynx, Client/Server



Get the essential soil information you need, when you need it. Stay up to date on your current soil conditions no matter where you are. Get the information you need to make important decisions in real time. Turf Guard sensors instantly track soil moisture, salinity, and temperature, saving you time. Repeaters mount easily inside all Toro Lynx® Smart Satellite, Lynx Smart Hub (LSH) Network LTC™ Plus and E-OSMAC® satellite pedestals.

FEATURES & BENEFITS

Reduce Water Usage and Improve Playability

Monitor moisture levels and adjust irrigation without risking turf quality. Promote root growth by avoiding over watering. Detect dry areas before they impact the turf's health.

100% Wireless Network

No wires between the repeaters and the sensors, or the sensor and the probes means that sensors can be installed anywhere on the course without disrupting play. Install sensors without having to trench or pull wires.

Take the Guesswork out of Managing Salinity

Track salt build-up and schedule flushing as needed. Get positive confirmation that you're flushing reduced soil salts. Know when and how much water to flush with.



Web-based or Stand-alone Interface

Graphical course overview displays sensor data at-a-glance. Plus with Toro Lynx® Control System integration you can check course moisture, salinity and temperature readings right from your irrigation control software.



HOW IT WORKS...



- ✓ One to three sensors buried in each green at critical root zone levels
- ✓ Additional sensors buried in fairways, tee boxes and planters
- ✓ Above-ground radio repeaters installed on or in existing irrigation pedestals
- ✓ Wireless MESH networking links all sensors to central control system
- ✓ Moisture, Temperature and Salinity readings displayed in your office



ADDITIONAL FEATURES

Operational

- Two distinct depths in the soil profile – critical root zone level and a second 5" lower. Independent measurements from each depth.
- MESH routing technology offers complete coverage even in remote canyon courses.
- Repeater mounts in most Toro irrigation satellite pedestals. An external repeater is available for other models including non-Toro pedestals.
- Supports up to 500 sensors per course
- Expected sensor battery life of 3 years, field replaceable.
- Sensor reading sent every 5 minutes.
- Automatic network configuration and failure recovery.
- Plots trends and compares historical and current readings.
- Lynx® Control System integration

Electrical

Input Power:

- Repeater: <0.02A @ 6 VDC
- Base Station: <1A @ 120 VAC, 50/60 Hz
- UL and CE approved

Dimensions:

- Body: 2" x 3" x 5"
- Spikes: 2.5" x 3/16"
- Installation Hole Diameter: 4.25"

Temperature:

- Operating: 32° F to 140° F
- Storage: -22° F to 180° F

Sensing:

- 0.1°F temperature resolution
- 0.1 % volumetric soil moisture content resolution
- 0.1 dS/m soil conductivity resolution (salinity)

Communication:

- Repeater Range: 2,000' line-of-sight
- Buried Sensor Range: 500' line-of-sight
- 900 MHz ISM Band FHSS communication
- Additional licensing not required

Specifying Information—Turf Guard®

Model	Description
TG-S2-R	Turf Guard Sensor With Replaceable Battery
TG-R-INT	Repeater-Internal Mount
TG-R-EXT	Repeater-External Mount
TG-B	Base Station
TG-S2-BAT	Sensor Replacement Battery



Network Radio-Link offers you the flexibility to design your irrigation system unconfined by the limitations of distance or terrain. Oversized acreage and natural barriers are not a problem for Network Radio-Link. Communicating where wires can't run, it's the bridge between non-contiguous wire line systems and much more.

FEATURES & BENEFITS

- ✓ Wireless communication to Network satellites
- ✓ Network Radio-Link kits for upgrades
- ✓ True 2-way communication
- ✓ Multi-port field interface allows one radio to be shared among many satellites
- ✓ Easy satellite installation
- ✓ Compatible with Network LTC™, LTC Plus, LTC Pro, Network 8000, Network VP®, Lynx® Smart Satellite and Lynx Smart Hub

Specifying Information—Field Interface Unit (FIU)

Model	Description
FIU-2011	Field Interface Unit with 1 Wire Line & 1 Radio Line, Radio Not Included
FIU-2011R	Field Interface Unit with 1 Wire Line & 1 Radio Line, Radio Included
FIU-2011DR	Field Interface Unit with 1 Wire Line & 1 Digital Radio Line, Radio Included
FIU-2021	Field Interface Unit with 2 Wire Lines & 1 Radio Line, Radio Not Included
FIU-2021R	Field Interface Unit with 2 Wire Lines & 1 Radio Line, Radio Included
FIU-2021DR	Field Interface Unit with 2 Wire Lines & 1 Digital Radio Line, Radio Included

Note: FCC license required.





TORO NSN

Where We are Dedicated to Service!

What is the National Support Network (NSN®)?

- ✓ The NSN is based in Abilene, Texas, with a team of dedicated technical support specialists, including 20 licensed irrigators, with an average tenure of 10 years and combined over 340 years of Toro NSN experience.
- ✓ Toro NSN was founded over 25 years ago, the first dedicated customer support network in the irrigation industry.
- ✓ We are here to provide you with confidence and peace of mind, complete central control system operational assurance.
- ✓ Simply, we are here to support you and keep you irrigating 24 hours a day, 7 days a week.

What Services Does NSN Provide?

- ✓ **1-800-ASK-TORO** – we are here to support you 24 hours a day, 7 days a week, 365 days of the year.
- ✓ Extended warranty, with next shipping day hardware replacement of central control system, fulfilled by qualified Toro technicians.
- ✓ Remote access to your central control system, allowing you to control your irrigation when you are outside of the office.
- ✓ NSN Portal – a web-based customer portal providing a knowledge-sharing database, on-line chat, and training.
- ✓ Training events – regular web-based training seminars are offered for all new Lynx customers. In addition, regional training events are hosted throughout the US and Canada.



Toro NSN – Because Your Business Deserves the Best Customer Care!



The all-new Lynx Smart Satellite sports a familiar look but is designed to improve performance and reliability. Picking up where the accomplished Network VP® left off, the Lynx Smart Satellite adds enhanced communications with the Lynx Central Control System and integration with field sensors to further complement your decision making. Lynx Smart Satellite is also fully compatible with Network VP and Network 8000 systems as an addition or replacement.

FEATURES & BENEFITS

Smart Design

Designed for Performance

Faster microprocessor and increased memory for high performance today and the capacity for future enhancements tomorrow.

Designed for Reliability

Fewer cables and connectors, corrosion-resistant metals, vented circuit board covers, and simplified power distribution contribute to greater reliability.

Smart Features

Updated User Interface

Familiar arrow buttons and selector knob navigate the menu options in a larger backlit six-line display. Manual and diagnostic operations are easy, productive, and intuitive.

Enhanced Wireless Communications

New digital radio with an integrated modem provides improved communication signal integrity, new diagnostic information, and control options.

Optional Sensor Input Kit

Designed to integrate with the new Sensor Input Kit, allowing either local or Lynx Central response to information from anywhere on the course.

Plus all the Great Features of the Network VP

Station-Based Flow Management, current sensing and alarm response, runtimes to the second, Group Multi-Manual operation, Basic/Advanced/Grow-In programs.



Lynx® Smart Satellite

Lynx Smart Satellite – Inside View

- ✓ Clear Vented Covers on Circuit Boards: protection from pests and corrosion
- ✓ Stainless Steel and Plated Metal Parts: additional corrosion resistance
- ✓ LED Indicators: confirmation of normal function and diagnostic information to assist with troubleshooting
- ✓ Shielded Connectors: secure and reliable connections between components



Optional Sensor Input Kit

- ✓ Pressure, Flow Rate, Rain, Status, and Temperature
- ✓ Includes 8 station outputs and 7 sensor inputs



Updated User Interface

- ✓ High-Contrast Backlit Display
- ✓ Intuitive Navigation
- ✓ Processor and Memory for High Performance and Future Enhancements



SPECIFICATIONS

Operational

- Functions as a stand-alone controller or under the management of a central computer operating Lynx or SitePro Central Control System
 - Supports wireline or radio communications
 - Supports hybrid communication (wireline and radio)
- 64 irrigation programs
- Basic, Advanced and Grow-In programs
- Station Autocycle
- Percent Adjustment from 1% to 900%
- Each output can be defined as an irrigation station or general application switch
- Nonvolatile memory retains program information and satellite settings during power-off conditions; battery backup retains the date and time
- 16-64 stations in 16 station increments; individual station control and the ability to run up to 32 stations simultaneously
- Backward compatible with Toro Network VP and Network 8000 satellite systems

Electrical

- UL Listed
- Input Power
 - 108 V ac to 132 V ac, 60 Hz
 - 0.20 amps (no load) 115 V ac
 - 1.2 amps (max. load) 115 V ac
 - 216 V ac to 264 V ac, 50 Hz
 - 0.10 amps (no load) 230 V ac
 - 0.60 amps (max. load) 230 V ac
- Output Power
 - 24 V ac: 3.0 amps (max. total load)

Dimensions

- Plastic Cabinet: 17"W x 40"H x 16"D

Temperature/Humidity

- Operating Temperature: 15°F to 140°F
- Storage Temperature: -22°F to 149°F
- Humidity: 0% to 95% RH (noncondensing)

Options

- Surge Protection
- Sensor Input Kit

Choice of Three Pedestal Colors

Custom pedestal color options help satellites blend into their natural surroundings. (Green, Tree Bark, and Desert Sand)



Specifying Information—Lynx® Smart Satellite

300-0XXY6ZSA

Description	Configuration	Cabinet	Output	Comm.	Options
300	XX	Y	6	Z	S
300—Lynx Smart Satellite	16—16 Stations 32—32 Stations 48—48 Stations 64—64 Stations	P—Plastic, Green T—Desert Sand B—Tree Bark	6—24 VAC Electric	A—Stand-alone M—2-Way Wire Modem R—UHF Radio H—Radio & Wire Modem	3—Large-capacity Terminal Block & Switches 4—Large-capacity Terminal Block w/Add'l Surge & Switches

Example: When ordering a 48-station, radio-equipped, Lynx Smart Satellite with large-capacity terminal block, additional surge and switches, specify: **300-048P6R4A**

Sensor Input Kit for Lynx Smart Satellite: **SMRT-SEN-BRD-KIT**



The Toro Lynx Smart Module 2-Wire Control System uses innovative technology to provide an irrigation solution that is reliable and efficient. Using a 2-wire path to communicate to buried control units, the system reduces the costs associated with traditional valve wire bundles and provides a solution that is vandal resistant, easy to install and easy to expand.

FEATURES & BENEFITS



Speed

Provides information faster than other two-wire brand, reducing test times from minutes to seconds and providing greater visibility into the overall health of the irrigation system.



Precision

Apply water with one-second resolution. The exact amount of water is placed exactly where it's needed.



Upgradeable

Upgrade remotely with just a click. Innovative new features and benefits are just a click away



Durable

Best in class surge protection to help weather the storm. It works with the Lynx Smart Hub, which protects the flow managed irrigation schedule, even in the event of a central failure if the central is down. Best in class broadband lightning protection.



Diagnostics
Built-in diagnostics automatically let you know if there are any problems. The wire path check quickly confirms that the whole system is operational.



Integrated Sprinkler
Toro INFINITY® and FLEX800™ Series sprinkler models have an integrated 2-wire module option.

INTERFACE OPTIONS



Lynx Smart Hub

Lynx Smart Hub is a new type of field controller that adds security, programmability and sensing to the benefits and simplicity of a two-wire system.

- ✓ The system can be segmented into manageable areas for simplified maintenance
- ✓ Provides for in-field manual operation or troubleshooting
- ✓ Stores and runs a fully flow-managed irrigation schedule in the event the central computer is offline
- ✓ Creates a convenient point of connection for soil, flow and status sensors

Specifying Information—2-Wire Modules

LSM-1	
Type	Configuration
LSM	X
Lynx Smart Module	1—1-station

Example: A 1-station Lynx Smart Module would be specified as: **LSM-1**

**Refer to sprinkler pages for specifying information on Sprinkler 2-wire Modules*

SPECIFICATIONS

Operational

Lynx® Central:

- Mapping capabilities
- Remote hand-held operation
- Weather station integration
- Pump station integration
- Enhanced diagnostics:
 - Communication
 - Electrical shorts/opens
 - Solenoid check
- No holding power required to operate stations
- Decoder identification is a unique 6-character address

Installation

- Maximum number of wire paths: 4 per gateway
- Maximum number of Lynx Smart Hubs: 20 per system
- Maximum number of modules per wire path: 250
- Maximum stations per Lynx Smart Hub: 1000
- Maximum stations per system: 10,000
- Simultaneous stations per output board: 100
- Maximum distance from central to module (using 14 gauge wire): 2.8 miles
- Maximum distance from module to sprinkler (using 14 gauge wire): 400 ft.
- Solenoids per output: 2 DCLS-P
- Stations per module: 1

Electrical

- Input power: 88-264 V ac, 50/60 Hz
- Output Power:
 - Output voltage: 40 V ac max
 - Output power: 75 VA max
 - Class 2, SELV
- ISP 2-wire modules are rated at 20 KV surge protection
- 2-Wire modules wiring: 14 awg

Lynx Smart Hub

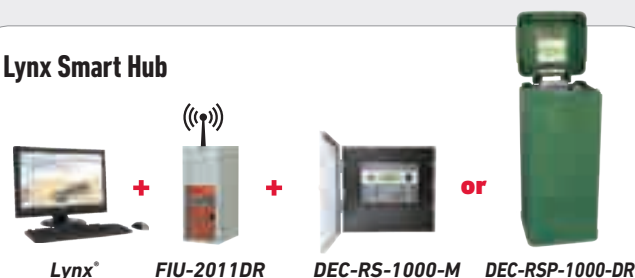

Specifying Information—Gateway or Lynx Smart Hub

DEC-XXX-XXXX-XX				
Type	Configuration	Cabinet	Station Count	Communication Type
DEC	XXX	X	XXXX	XX
DEC	RS—Lynx Smart Hub	WM Metal P—Green Plastic Pedestal B—Brown Plastic Pedestal T—Tan Plastic Pedestal	1000—1000 Stations, Lynx Smart Hub*	M—Wireline DR—Radio

Example: A 1000 station Lynx Smart Hub with green plastic pedestal and radio communication would be specified as: **DEC-RSP-1000-DR**

Note: A blank after RS indicates the wall mount cabinet. P, B, and T indicate green, brown, and tan plastic pedestals.

OSMAC® G3 Satellite

Updated for 2019, the OSMAC G3 satellite combines value and reliability in one controller. Wireless communications, easy installation and setup, and compatibility with existing OSMAC systems make the OSMAC G3 an ideal choice for a control system upgrade or retrofit. As part of a Lynx® Central Control system, the OSMAC G3 will run flow-managed programs using station run times executed to the second for precise water application. An upgrade kit is available for E-OSMAC satellites, adding new functionality, including program storage for stand-alone function and a user interface for performing manual irrigation or diagnostic activity.

FEATURES & BENEFITS

Reliable Design

Designed for reliability, featuring a limited number of cables and connectors, corrosion-resistant metals, vented circuit board covers, and simple parallel power and signal distribution.

Enhanced Wireless Communication

Equipped with a high-performance receiver with integrated modem, providing industry-leading communication signal integrity, reliability, and signal strength indication. Wireless communication also allows easy system expansion.

OSMAC Compatible

Compatible with any narrowband OSMAC system equipped with an OSMAC Base Station or Radio Interface Unit (RIU). Able to retrofit with OSMAC RDR and E-OSMAC satellites.

Productive and Precise

Operates up to 32 stations simultaneously with run times executed to the second for productive and precise water application.





Information and Control:

- ✓ Received messages are logged with signal strength indication
 - A useful reference of recent activity and valuable diagnostic detail
- ✓ Stand-alone capabilities enable running scheduled irrigation programs
 - A convenient backup option and useful during course construction
- ✓ Manual operation capabilities include program start, station multi-manual, and syringe cycles
 - A trusted point of control on the course
- ✓ Diagnostic information is available in the display menus and through LED lights
 - Confirmation of normal function and information to guide troubleshooting
- ✓ Capable of remote operation with hand-held radio and Lynx Apps
 - Flexible control options, on and off the course

SPECIFICATIONS

Operational

Functions under the management of a central computer operating Lynx, or SitePro, Central Control System, or as a stand-alone controller.

Stations: 16 to 64 in 16 station increments

- Up to 32 stations may operate simultaneously
- Station run times received from Lynx® Central are executed to the second, from 1 second to 8 hours and 59 minutes
- Station run times programmed in Local mode are executed to the minute, from 1 minute to 59 minutes
- Any station can be configured as a switch. Switch operation will ignore rain hold and does not activate the pump/master valve circuit

Local Mode Operations

- 12 independent local programs
- 14 day calendar or 1 to 30 day interval scheduling
- Up to 24 start times per program
- Simultaneous station operation defined independently per program
- Program percent adjust from 10 to 250%
- Nonvolatile memory saves program data for up to 10 years without power

Manual Operations

- Multi-Manual station start up to 32 stations
- Program start
- Program syringe

Electrical

- Input power: 120/240 V ac, 50/60 Hz

OSMAC G3:

- 0.20 amps, 110-120 V ac, 60 Hz (no load)
- 0.96 amps, 110-120 V ac, 60 Hz (max load)
- 0.10 amps, 220-240 V ac, 50/60 Hz (no load)
- 0.47 amps, 220-240 V ac, 50/60 Hz (max load)

Dimensions

- Plastic Cabinet: 17" W x 40" H x 16" D

Options

- Surge protection

Specifying Information—OSMAC G3 Satellites

G4-XXX6RX					
Description	Configuration	Cabinet	Output	Communication	Options
G4	XX	X	6	R	X
G4 – OSMAC G3 2019+	16 – 16 Stations 32 – 32 Stations 48 – 48 Stations 64 – 64 Stations	P – Plastic Green B – Plastic Tree Bark T – Plastic Desert Sand	6A – 24VAC	R – Narrowband Radio	3 – Large Terminal Blocks, Switches 4 – Large Terminal Blocks, Switches, Premium Surge
Example: When specifying a 48-station, satellite in a green plastic cabinet with large terminal block, switches and premium surge you would specify: G4-48P6R4					

OSMAC G3 Upgrade Kit:

- ✓ Upgrade E-OSMAC satellites with the OSMAC G3 Upgrade Kit
 - Add a point of operation at the satellite controller for performing manual irrigation or referencing diagnostic information, including communications details through Page History.
 - Add backup program storage for stand-alone operations when in Local mode.
 - Upgrade receiver hardware to a high-performance receiver radio for improved reliability and for signal strength indication.



Specifying Information – OSMAC G3 Upgrade Kit

118-2987
Kit Contains
OSMAC G3 Timing Module, Interface Cable and Hardware

Network LTC™ Plus to Network VP®

Available as an upgrade kit for existing LTC Plus satellites. Upgrade kit includes Network VP Faceplate, Network LTC Plus To Network VP Power Distribution Board, Cable and Hardware.



FEATURES & BENEFITS

- ✓ Station based flow management shortens watering window
- ✓ Intuitive user interface simplifies manual irrigation
- ✓ Station runtimes executed to the second helps save water
- ✓ Upgrade to Lynx for enhanced central capabilities (requires all satellites to be upgraded)

Specifying Information—Network LTC Plus Upgrade Kit

118-0038
<i>Kit Contains</i>
Network VP Faceplate, Network LTC Plus To Network VP Power Distribution Board, Cable and Hardware

Network LTC Plus to LTC Pro

Available as complete satellites or upgrade kit for existing LTC Plus satellites. Upgrade kit includes LTC Pro Faceplate, Power Distribution Board, Cable and Hardware.



FEATURES & BENEFITS

- ✓ Intuitive user interface simplifies faceplate functions
- ✓ Enhanced manual operations
 - Runtimes to the second
 - Stackable multi-manuals
 - Start/Pause/Stop
- ✓ Backwards compatible with SitePro®
- ✓ Can upgrade 1 satellite at a time (full system must be upgraded prior to a Lynx upgrade)

Specifying Information—LTC Pro Satellites

LTCRXXX6XX					
Description	Configuration	Cabinet	Output	Comm.	Options
LTCR	XX	X	6	X	X
LTCR - LTC Pro	16 – 16 Stations 40 – 40 Stations	P – Plastic Green	6 – 24VAC	M – Wire R – Radio	4 – Large Terminal Block, Switches, Premium Surge
Example: When specifying a 40-station, wire communication satellite, you would specify: LTCR40P6M4					

Specifying Information—LTC Pro Upgrade Kit

118-4838
<i>Kit Contains</i>
LTC Pro Faceplate, Power Distribution Board, Cable and Hardware



Radio Interface Unit (RIU)

The Toro® Radio Interface Unit combines the functions of the OSMAC® Base Station and Hand-held Remote Interface (HHRI) in a single unit. Available in a dual radio configuration that performs both Base Station and HHRI functions, a single radio configuration that’s programmable for either function, and a radio-less configuration that’s programmable for either function and utilizes a user-supplied external radio for added flexibility.

FEATURES & BENEFITS

- ✓ Provides control of your system while you're on-the-go
- ✓ Provides both hand-held control and central-to-satellite communication
- ✓ Designed to operate continuously, 24/7
- ✓ Interfaces with your Lynx® or SitePro® central without the burden of recurring network costs
- ✓ Tailored to fit your application with programmable selections for: OSMAC Base Station and hand-held remote interface modes, independent transmit/receive UHF frequencies, independent transmit/receive private line settings (CTCSS) and transmit power.



Radio Interface Unit (RIU) Graphical User Interface.

Specifying Information—Radio Interface Unit (RIU)

Model	Description
RIU-00	Radio Interface Unit – External Radio
RIU-01	Radio Interface Unit – Single Radio
RIU-02	Radio Interface Unit – Dual Radio

Note: FCC license required.

Sensor Input Kits for Satellite Controllers

The Sensor Input Kits for Lynx Smart Satellite and Network VP deliver important field data to the superintendent's office. Relevant data is the foundation of informed decision making, whether the decision is made by a human or a computer. A satellite controller equipped with either of the two Sensor Input Kits can receive data from up to seven sensors. The satellite collects, stores, and delivers the data to Lynx, where it can be accessed by the superintendent on the Sensor Dashboard. Lynx also can respond automatically to changes to the irrigation system and changes in weather conditions. A Sensor Input Kit can help save the valuable resources of time and water, and help keep course conditions at their best.

SENSOR INPUT KIT FOR NETWORK VP*



VP-SEN-BUNDLE
118-5487SK

VP Timing Module – Sensor Compatible

SENSOR INPUT KIT FOR LYNX* SMART SATELLITE



SMRT-SEN-BRD-KIT

VP-SEN-BRD-KIT
*Sensor Board
& Terminal Board*

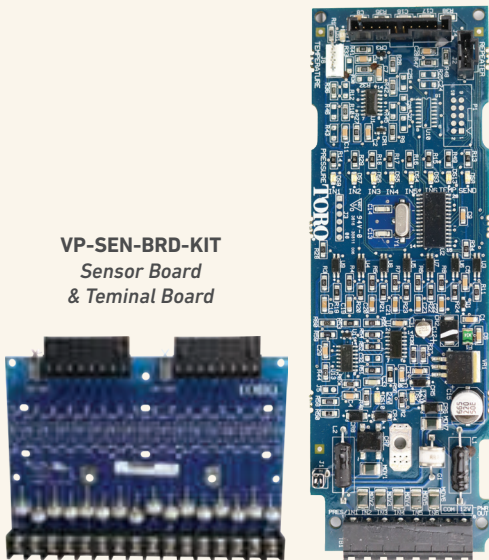



FEATURES & BENEFITS

Lynx Sensor Dashboard Presents the Real-time Status of Sensors on the Course

At-a-glance understanding of the condition of the course irrigation system and weather inputs enhance decision-making.



Lynx Report Generator Presents Logged Sensor Data in Tabular or Graphical Format

Display trends over time for a complete understanding of the weather and irrigation system.

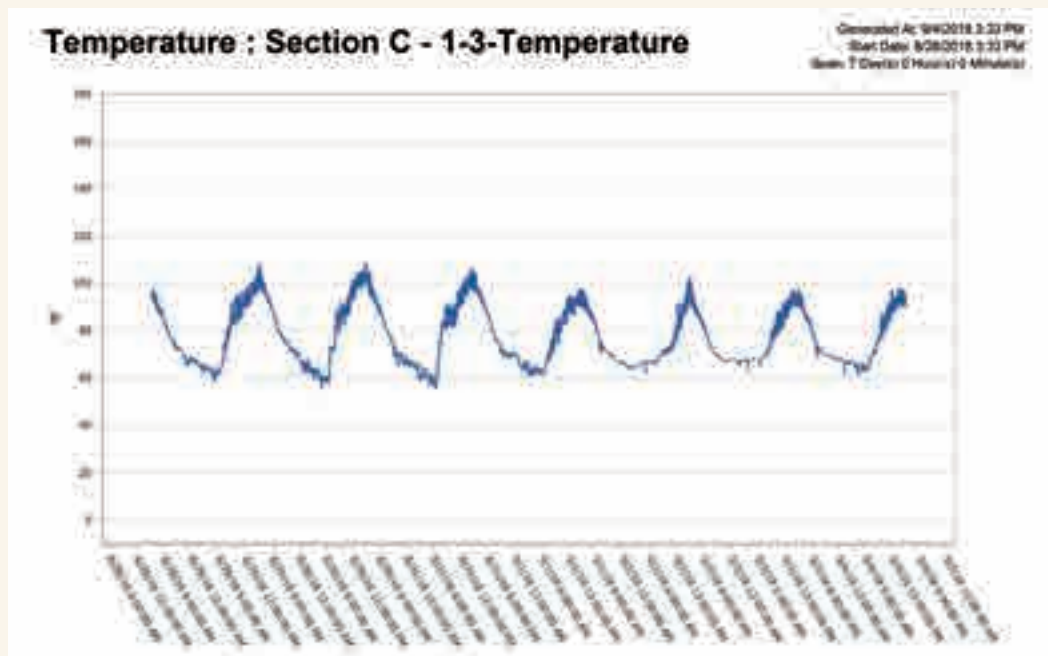

Sensor alarms and responses can be easily configured in Lynx with numerous options for responses to alarm conditions.

Automatically Safeguard Your Course, Eliminate Water Waste, and Ensure Efficient Irrigation

Alarm & Response Examples:

Pressure Sensor: Set alarm conditions and appropriate responses for high and/or low pressure values

- ✓ A text notification or email can be sent if measured pressure falls below a specified value.

Rain Gauge: Prevent, suspend or adjust irrigation in the event of a measurable rain event

- ✓ Lynx will account for measured rain on an hourly or daily basis and automatically apply a Rain Hold or adjust scheduled activity to account for the rain fall received.

Temperature Gauge: Set alarm conditions and appropriate responses for high and/or low air temperature

- ✓ Activate greens fans through a satellite switch output when air temperature exceeds the alarm value for a set duration
- ✓ Suspend irrigation when air temperature is near freezing.

Switch Status: Set alarm conditions and appropriate responses for changes in switch state

- ✓ Control pond or tank water level using level switches to trigger a pump or valve to transfer water, maintaining water level within a set range.

Flow Meter: Set alarm conditions and appropriate responses for high and/or low flow rate values

- ✓ A satellite switch can be closed if a flow out of tolerance is observed, signaling the pump station to shut down.



Photo credit: Jeremy Klotz

A flow out-of-tolerance condition, manageable with a sensor input kit, flow meter, an automatic alarm response in Lynx®.

Toro Sensors



Pressure Sensor

Approved Model: **PRESS200-SEN-KIT**
Toro Pressure Sensor Kit: 0 – 200 PSI



Temperature Sensor

Approved Model: **TEMP-SEN-KIT**
Toro Temperature Sensor Kit

SPECIFICATIONS

Sensors

The Sensor Input Kits can accept up to seven sensors; they are compatible with the following sensors:

- (1) Pressure sensor
- (1) Temperature sensor
- (5) Flow meter, rain gauge, or switch status

Satellites equipped with Sensor Input Kits can accommodate up to 56 station outputs:

- The Sensor Input Kit for Network VP includes a sensor input board that takes the place of an eight station output board
- The Sensor Input Kit for Lynx Smart Satellite is a module that contains eight station outputs and seven sensor inputs. It takes the place of a sixteen station output board.
- Lynx version 5.0 or later is required for interaction with the Sensor Input Kits
- The Sensor Input Kit for Network VP includes a new Timing Module with faster processor, larger display, and expanded memory

Sensor Input Kit for Network VP

Model: **VP-SEN-BUNDLE**

- 118-5487SK: VP Timing Module, Sensor compatible
- VP-SEN-BRD-KIT: Sensor Board and Level 4 Terminal Board

Sensor Input Kit for Lynx Smart Satellite

Model: **SMRT-SEN-BRD-KIT**

Toro Pressure Sensor Kit

Model: **PRESS200-SEN-KIT**

- 0 – 200 PSI
- 1/4" – 18 NPT male thread

Toro Temperature Sensor Kit

Model: **TEMP-SEN-KIT**

Recommended accessory: Radiation Shield Davis #7714

Rain Gauge

Recommended Model: Texas Electronics TR525I

Flow Meter

Recommended Models: Data Industrial 200 Series or Bermad 900M Series, reed switch signal

Recommended Sensors



Radiation Shield for Temperature Sensor

Recommended Model:
Davis® #7714



Rain Gauge – Tipping Bucket

Recommended Model:
Texas Electronics TR 525I



Flow Meter

Recommended Models:
Data Industrial® Series 200
or **Bermad® 900 M Series**

Lynx® GAC

The Lynx upgrade system uses modern electronic technology to enable users of older decoder control systems to upgrade to a modern central with new field hardware. New features like remote control from your phone, moisture sensing and sophisticated diagnostics are now available without replacing your entire irrigation system.

FEATURES & BENEFITS

Upgrade your old control system

Works with your existing sprinklers and wiring – just replace your field decoders and the central control.

Modern Electronics

Higher surge protection, more precise run times and 2-way communication.

Works with Toro's Lynx Central Control

Easy to Install, easy to support, easy to use.

Benefits for Users of Older CDS, Rain Bird** and Hunter*** Systems:

- ✓ Two-way communication
- ✓ More precise run times (+/- 1 second)
- ✓ Enhanced diagnostics – rapid communication check, voltage and amperage, cable length
- ✓ 20KV lightning protection
- ✓ Lynx Central Control (all the benefits, apps, NSN*)
- ✓ 1-station fits in Toro INFINITY® Series golf sprinklers with Smart Access®

* Rain Bird is a registered trademark of the Rain Bird Corporation.
 ** Hunter is a registered trademark of Hunter Industries



Lynx Central



Lynx GAC Modules



Feature	Toro GAC	CDS	Rain Bird FD	Hunter Pilot
Stations Per Wire Path	500	112	250	250
Devices Per Wire Path	125	112	250	250
Outputs	1,2,4	1,2,3,4	1,2,4,6	1,2,4,6
Maximum 14 AWG Wire Path Length	6800 ft	5400 ft	10,000 ft	8000 ft
Simultaneous Stations with 6800 ft of 14 AWG Cable	16	2	20	20
Distance from Decoder Module to Solenoid	575 ft	1200 ft	220 ft	240 ft
Solenoids Per Output	2	2	2	2
Surge Protection	20 KV	6-8 KV	6-8 KV	15 KV
Wire Paths Per Interface	2	4	2	4
Solenoid Characteristics 24VAC, 60 Hz	400mA inrush, 250mA holding	400mA inrush, 200mA holding	400mA inrush, 250mA holding	400mA inrush, 250mA holding
Holding Current	40mA	300mA	20mA	45mA
Two-Way Feedback from Decoder Module	VOLTS AMPS DISTANCE	NO	NO	VOLTS AMPS

SPECIFICATIONS

Operational

Enhanced diagnostics

- Communication
- Electrical shorts/opens
- Voltage
- Amperage

Module addresses are factory programmed

Low holding current

Installation

Maximum number of wire paths

- 2 per gateway

Maximum number of gateways

- 4 standard, 4 expansion

Electrical

- Input voltage: 100-240 VAC, 50/60 Hz
- Input current: 1.6A/1.0A (115/230)
- Output voltage: 40VAC max
- Output power: 75VA max
- Class 2, SELV
- Decoders and gateways have 20KV surge protection

Temperature

- Operating temperature: 32F to 140°F
- Storage temperature: -22F to 140°F

Specifying Information—GAC Module

DAC-ISP-X	
Type	Station Count
DAC-ISP	X
DAC-ISP-Module	1-1 Station, 2-2 Station, 4-4 Station

Specifying Information—Gateway

DAC-XXX-XXXX				
Type	Configuration	Cabinet	Station Count	Communication
DAC	XXX	X	XXXX	XXX
DAC	PCS - Central RS - Remote	WM Metal P—Green Plastic Pedestal B—Brown Plastic Pedestal T—Tan Plastic Pedestal	1000 1000-E	M—Wireline DR—Radio



Model	INF35-6/ INF55-6	INF35/ INF55	INF34/ INF54	FLX35-6/ FLX55-6	FLX35/ FLX55	FLX34/ FLX54
Catalog Pages	36-39	40-43	44-47	52-55	56-59	60-63
Radius	42'-100'	43'-92'	52'-99'	42'-100'	43'-92'	52'-99'
Short Radius (mainless)	25'-51'	25'-50'		25'-51'	25'-50'	
Radius Reduction Screw		X	X		Optional	Optional
Back Nozzle Capable	X	X		X	X	
Inlet Size	1" & 1½" ACME	1" & 1½" ACME	1" & 1½" ACME	1" & 1½" ACME	1" & 1½" ACME	1" & 1½" ACME
Below Grade Capable	Stealth-T	Stealth-D	Stealth-D			
Grade Height Adjustable	Razor	Razor	Razor			
Turf	X	X	X	X	X	X
High Wind	X	X	X	X	X	X
LSM 2-wire Systems	X	X	X	X	X	X
Normally Open Hydraulic System				X ¹	X ¹	X ¹
Spike Guard™ Solenoid	X	X	X	X	X	X
Full Circle	X	X	X	X	X	X
Part-circle Adjustable	X	X		X	X	
Part/Full Circle In One	40°-330° & 360°	40°-330° & 360°		40°-330° & 360°	40°-330° & 360°	
Ratcheting Riser	X	X		X	X	
Check Valve				X	X	X
Effluent Water Option	X	X	X	X	X	X
Trajectory Adjustment	7°-30°	25° & 15°	25° & 15°	7°-30°	25° & 15°	25° & 15°
Nozzle Base Clutching	X	X		X	X	
SMART ACCESS® Compartment	X	X	X			
SMART ACCESS® Cover	X	X	X			
Removable Marker	X	X	X			
Pilot Valve Serviceable Under Pressure	X	X	X			
Warranty	3 Years/ 5 Years*	3 Years/ 5 Years*	3 Years/ 5 Years*	3 Years/ 5 Years*	3 Years/ 5 Years*	3 Years/ 5 Years*

¹When purchased and installed with Toro Swing Joints.

X¹-Complete sprinkler requires the purchase and assembly of riserless bodies and conversions.
NPT and BSP models available as riserless bodies only.



Model	FLEX800 B SERIES	T7 Rotor	690	590GF
Catalog Pages	64-67	74-75	76-77	78-79
Radius	25'-95'	Low-flow: 38'-56' High-flow: 46'-75'	87'-108'	2'-26
Short Radius (mainless)	X	X		X
Radius Reduction Screw	Optional	X		X
Back Nozzle Capable	X			
Inlet Size	1" NPT, BSP, ACME	1" ACME	1½" NPT	1/2" NPT
Flow Range	7.1-56.3 gpm	Low-flow: 1.7-12.7 gpm High-flow: 6.8-30.5 gpm	51.0-82.2 gpm	.05-4.5 gpm
Recommended Operating Pressure	50-100 psi	40-100 psi	80-100 psi	20-50 psi
Turf	X	X	X	X
High Wind	X		X	
Low Pressure		X		X
Normally Open Hydraulic System			X	
Full Circle	X	X	1 and 2 Speed	X
Part-circle Adjustable	X	X		X
Part-circle Fixed			90° and 180°	X
Part/Full Circle In One	40°-330° & 360°	X		X
Ratcheting Riser	FLX35-6B/FLX35B			X
Check Valve	X	X	X	X
Effluent Water Option	X	X		X
Trajectory Adjustment	7°-30°/ 25° & 15°			
Warranty	3 Years/ 5 Years*	5 Years	3 Years/5 Years*	3 Years

*When purchased and installed with Toro Swing Joints.



With the industry's largest selection of high performance nozzles and TruJectory™ adjustment the INFINITY 35-6/55-6 Series with SMART ACCESS® allows you to put water precisely where you want it for maximum distribution uniformity. And the part/full circle drive and ratcheting riser allows you to simply and economically adjust the area of coverage to match your seasonal watering needs or meet water rationing mandates in seconds with no disassembly or additional parts required.

FEATURES & BENEFITS

Industry's Largest Nozzle Selection

Nozzles from 25' to 100' radius plus a wide assortment of back nozzles lets you put the precise amount of water exactly where you need it. All color coded and debris tolerant nozzles threaded in from the front.

Hot Spot Watering

Nozzle base can be turned in either direction and held to put down as much water as needed, precisely where you want it. Standard on all Toro part circle golf rotors!

Adjustment With No Disassembly

A Toro original, simply pull up the riser and ratchet it to the precise position you want to water.

True Part and Full-Circle in One (40° - 330° part circle)

These sprinklers can be full circle today and part circle tomorrow allowing you to simply and economically adjust the area of coverage to match your seasonal needs or meet water rationing mandates.



- ✓ Eliminates sprinkler interference
- ✓ Enhances course appearance



INFINITY® SERIES DISTANCE MARKERS

- Set your course apart with Toro's unique, customizable distance markers*
- White (118-6234) and Yellow (118-6235) color options provide excellent visibility
 - Customizable with any graphic image
 - Multiple number and orientation options available
 - Any font style
 - Easy snap-in installation into any INFINITY golf sprinkler

Smart Access®

Provides top accessibility to all critical components.

- ✓ No digging or unsightly turf repair scars
- ✓ No buried wire splices or ground faults
- ✓ Pilot valve removable with water "ON"
- ✓ Lower long term cost of ownership
- ✓ Customizable marker
- ✓ Replaceable cover if damaged
- ✓ Increased labor efficiency



Trajectory – 24 Positions
From 7° - 30° in 1° increments put water where you want it. Adjust from the top of the sprinkler in seconds, wet or dry. This flexibility lets you tackle every obstacle on the course; wind, trees, bunkers, mounds and more.

INF35-6 CONVERSION UPGRADES

MODELS	DESCRIPTION
• INF35-6-3134	INF35-6 w/31-34 Nozzles (33 Nozzle Installed)
• INF35-6-3537	INF35-6 w/35-37 Nozzles (35 Nozzle Installed)
• INF35-6-3134E	INF35-6 w/31-34 Nozzles (33 Nozzle Installed), Effluent
• INF35-6-3537E	INF35-6 w/35-37 Nozzles (35 Nozzle Installed), Effluent



INF55-6 CONVERSION UPGRADES

MODELS	DESCRIPTION
• INF55-6-5154	INF55-6 w/51-54 Nozzles (53 Nozzle Installed)
• INF55-6-5558	INF55-6 w/55-58 Nozzles (55 Nozzle Installed)
• INF55-6-59	INF55-6 w/59 Nozzle Installed
• INF55-6-5154E	INF55-6 w/51-54 Nozzles (53 Nozzle Installed), Effluent
• INF55-6-5558E	INF55-6 w/55-58 Nozzles (55 Nozzle Installed), Effluent
• INF55-6-59E	INF55-6 w/59 Nozzle Installed Effluent



SPECIFICATIONS

Operational

- Inlet:
 - INF35-6: 1" ACME
 - INF55-6: 1½" ACME
- Radius:
 - INF35-6: 42' - 92'
 - INF55-6: 52' - 100'
- Flow Rate:
 - INF35-6: 7.1 - 45.3 gpm
 - INF55-6: 13.9 - 61.1 gpm
- Precipitation Rates:
 - INF35-6: Minimum - .37"/hr; Maximum - .53"/hr
 - INF55-6: Minimum - .43"/hr; Maximum - .60"/hr
- Pilot Valve: Selectable at 50, 65, 80 and 100 psi
- Recommended Operating Pressure Range: 65-100 psi (maximum -150 psi and minimum - 40 psi)
- Activation types – Electric Valve-in-Head:
 - Standard Solenoid:
 - 24 VAC, 50/60 Hz
 - Inrush: 0.30 A
 - Holding 0.20 A
 - Spike Guard Solenoid:
 - 24 VAC, 50/60 Hz
 - Inrush: 0.12 A
 - Holding 0.10 A
 - Nickel-Plated Spike Guard Solenoid:
 - 24 VAC, 50/60 Hz
 - Inrush: 0.12 A
 - Holding 0.10 A
 - DC Latching Solenoid (DCLS):
 - Momentary low voltage pulse
 - Integrated Lynx Smart Module with DCLS:
 - Momentary low voltage pulse
- Trajectory: 24 positions from 7° - 30° in 1° increments

Additional Features

- INF35-6 has eight nozzle variations (30, 31, 32, 33, 34, 35, 36 and 37)
- INF55-6 has nine nozzle variations (51, 52, 53, 54, 55, 56, 57, 58 and 59)
- Four in-line nozzles, rotating stream pattern
- One back nozzle position
- Stator variations: INF35-6 – 3 and INF55-6 – 3
- Ratcheting riser
- Nozzle base clutching

Dimensions

- SMART ACCESS® Cover and Compartment Diameter:
 - INF35-6: 7 5/8"
 - INF55-6: 7 5/8"
- Body height:
 - INF35-6: 10"
 - INF55-6: 11 3/8"
- Weight:
 - INF35-6: 4.31 lbs.
 - INF55-6: 5.13 lbs.
- Weight – Intergrated with Lynx Smart Module:
 - INF35-6: 5.00 lbs.
 - INF55-6: 5.82 lbs.
- Pop-up height to nozzle: 3/4"

Warranty

- Three years
- Five years when installed with Toro Swing Joints

Specifying Information—INFINITY 35-6 & INFINITY 55-6

INFX5-XXX-X6-X						
Body Inlet	Arc	Nozzle	Pressure Regulation*	Activation Type	Trajectory	Optional
INFX	5	XX	X	X	6	X
3-1" 5-1½"	5-Part-circle and Full-circle In One	INF35-30, 31, 32, 33, 34, 35, 36, 37 INF55-51, 52, 53, 54, 55, 56, 57, 58, 59	6-65 psi 8-80 psi 1-100 psi	1-Standard Solenoid 2-Spike Guard™ Solenoid 3-Nickel-plated Spike Guard Solenoid 4-DC Latching Solenoid (DCLS) 6-Integrated Lynx Smart Module w/DCLS	6-24-position Trujectory	7-Effluent
Example: When specifying an INF35-6 Series Sprinkler with #34 nozzle, pressure regulation at 65 psi and Spike Guard you would specify: INF35-346-26						

Note: Not all models available.

* All sprinklers are equipped with the selectable pilot valve that allows settings at 50, 65, 80 and 100 psi.



INFINITY® 35-6/55-6 SERIES GOLF ROTORS

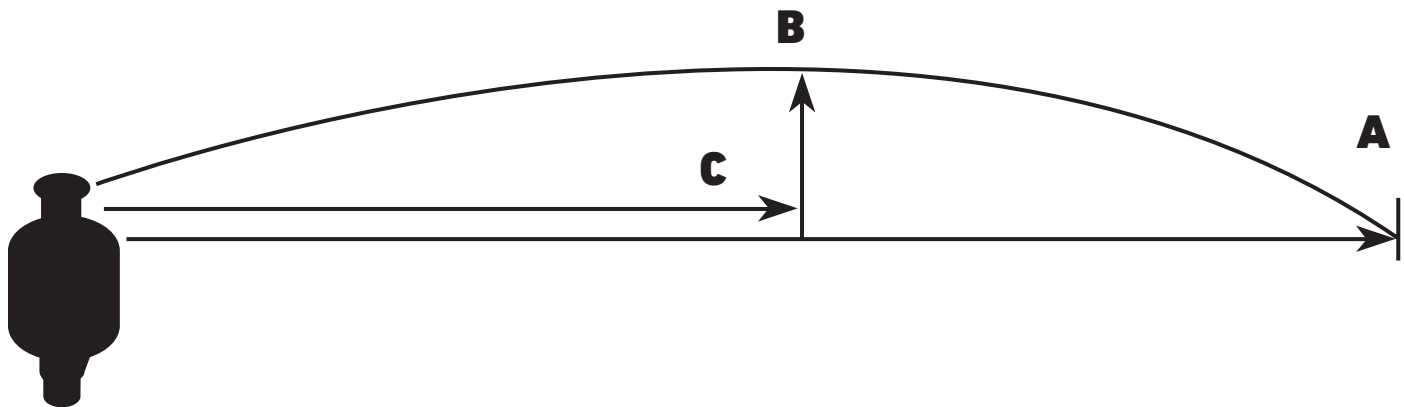

INFINITY 35-6 TRAJECTORY PERFORMANCE

Nozzle/psi/gpm	#31 Nozzle @ 65 psi, 15.5 gpm						#32 Nozzle @ 65 psi, 20.5 gpm						#33 Nozzle @ 65 psi, 22.9 gpm					
Trajectory	7°	10°	15°	20°	25°	30°	7°	10°	15°	20°	25°	30°	7°	10°	15°	20°	25°	30°
"A" Radius	46'	46'	50'	53'	54'	50'	46'	49'	51'	55'	63'	54'	54'	56'	59'	62'	66'	61'
"B" Spray Height	4'	4'	5'	8'	11'	13'	3'	4'	6'	9'	12'	15'	4'	5'	7'	9'	13'	15'
"C" Distance from Head	25'	25'	26'	33'	33'	33'	20'	24'	28'	34'	34'	34'	23'	28'	32'	34'	35'	35'

Nozzle/psi/gpm	#34 Nozzle @ 65 psi, 30.0 gpm						#35 Nozzle @ 65 psi, 32.4 gpm						#36 Nozzle @ 80 psi, 34.0 gpm					
Trajectory	7°	10°	15°	20°	25°	30°	7°	10°	15°	20°	25°	30°	7°	10°	15°	20°	25°	30°
"A" Radius	58'	60'	63'	67'	74'	70'	59'	61'	64'	70'	76'	74'	64'	68'	76'	80'	84'	82'
"B" Spray Height	4'	4'	6'	11'	14'	17'	4'	5'	7'	11'	15'	17'	5'	7'	9'	14'	17'	22'
"C" Distance from Head	24'	26'	35'	39'	39'	39'	30'	32'	36'	43'	43'	43'	25'	38'	40'	45'	49'	45'

Nozzle/psi/gpm	#37 Nozzle @ 80 psi, 39.8 gpm					
Trajectory	7°	10°	15°	20°	25°	30°
"A" Radius	65'	69'	78'	82'	86'	84'
"B" Spray Height	5'	7'	9'	14'	18'	22'
"C" Distance from Head	30'	39'	41'	46'	50'	46'

INFINITY 55-6 TRAJECTORY PERFORMANCE

Nozzle/psi/gpm	#51 Nozzle @ 65 psi, 15.7 gpm						#52 Nozzle @ 65 psi, 20.8 gpm						#53 Nozzle @ 65 psi, 23.4 gpm					
Trajectory	7°	10°	15°	20°	25°	30°	7°	10°	15°	20°	25°	30°	7°	10°	15°	20°	25°	30°
"A" Radius	46'	46'	51'	53'	54'	50'	49'	50'	51'	55'	64'	65'	54'	56'	59'	62'	68'	61'
"B" Spray Height	4'	4'	6'	10'	13'	15'	4'	4'	6'	9'	11'	13'	5'	6'	7'	9'	13'	15'
"C" Distance from Head	26'	27'	32'	38'	40'	41'	22'	26'	31'	35'	34'	30'	30'	33'	32'	35'	37'	37'

Nozzle/psi/gpm	#54 Nozzle @ 65 psi, 31.2 gpm						#55 Nozzle @ 65 psi, 33.8 gpm						#56 Nozzle @ 80 psi, 35.7 gpm					
Trajectory	7°	10°	15°	20°	25°	30°	7°	10°	15°	20°	25°	30°	7°	10°	15°	20°	25°	30°
"A" Radius	58'	60'	63'	67'	74'	70'	59'	62'	66'	70'	76'	77'	72'	73'	75'	82'	85'	82'
"B" Spray Height	5'	6'	8'	10'	15'	17'	6'	6'	9'	11'	15'	17'	5'	7'	9'	14'	17'	22'
"C" Distance from Head	31'	34'	40'	41'	41'	42'	34'	36'	43'	45'	45'	45'	25'	38'	40'	45'	49'	45'

Nozzle/psi/gpm	#57 Nozzle @ 80 psi, 41.9 gpm						#58 Nozzle @ 80 psi, 46.2 gpm						#59 Nozzle @ 80 psi, 53.3 gpm					
Trajectory	7°	10°	15°	20°	25°	30°	7°	10°	15°	20°	25°	30°	7°	10°	15°	20°	25°	30°
"A" Radius	72'	74'	77'	83'	89'	85'	75'	77'	83'	87'	92'	88'	77'	78'	84'	89'	96'	92'
"B" Spray Height	5'	7'	9'	14'	18'	22'	6'	7'	10'	15'	18'	22'	7'	8'	11'	16'	21'	25'
"C" Distance from Head	30'	39'	41'	46'	50'	46'	38'	40'	43'	47'	52'	48'	42'	44'	45'	47'	53'	49'

Information is for reference only. Actual results may vary.

INFINITY® 35-6/55-6 SERIES GOLF ROTORS



INFINITY 35-6 SERIES PERFORMANCE CHART

Base Pressure	Nozzle Set 30 (White)		Nozzle Set 31 (Yellow)		Nozzle Set 32 (Blue)		Nozzle Set 33 (Brown)		Nozzle Set 34 (Orange)		Nozzle Set 35 (Green)		Nozzle Set 36 (Gray)		Nozzle Set 37 (Black)	
	102-2208		102-4587		102-4588		102-4589		102-0728		102-0729		102-0730		102-4261	
	102-2925	102-2910	102-2925	102-2910	102-2928	102-2910	102-2926	102-2910	102-2926	102-2910	102-2925	102-2910	102-2925	102-2910	102-2926	102-2910
Back Nozzle Positions																
	Red Plug	Red Plug	Red Plug	Red Plug	Red Plug	Red Plug	Red Plug	Red Plug	Red Plug	Red Plug	Red Plug	Red Plug	Red Plug	Red Plug	Red Plug	Red Plug
	102-4335	102-4335	102-4335	102-4335	102-4335	102-4335	102-4335	102-4335	102-4335	102-4335	102-4335	102-4335	102-4335	102-4335	102-4335	102-4335
psi	Radius	gpm	Radius	gpm	Radius	gpm	Radius	gpm	Radius	gpm	Radius	gpm	Radius	gpm	Radius	gpm
50	42	7.1	52	13.7	61	17.1	64	20.2	69	27.4	—	—	—	—	—	—
65	45	8.7	54	15.5	63	20.5	66	22.9	74	30.0	76	32.4	—	—	—	—
80	46	9.6	57	17.0	67	22.6	70	25.3	77	33.2	79	35.8	84	37.5	86	40.8
100	48	11.2	59	18.9	72	25.2	74	28.2	80	37.0	84	39.9	88	42.5	92	45.3
Stator	102-6929 Blue				102-1939 Yellow				102-1940 White							
Conversions					INF35-6-3134								INF35-6-3537			

INFINITY 55-6 SERIES PERFORMANCE CHART

Base Pressure	Nozzle Set 51 (Yellow)		Nozzle Set 52 (Blue)		Nozzle Set 53 (Brown)		Nozzle Set 54 (Orange)		Nozzle Set 55 (Green)		Nozzle Set 56 (Gray)		Nozzle Set 57 (Black)		Nozzle Set 58 (Red)		Nozzle Set 59 (Beige)	
	102-4587		102-4588		102-4589		102-0728		102-0729		102-0730		102-4261		102-4260		102-4259	
	102-2925	102-2910	102-2928	102-2910	102-2926	102-2910	102-2926	102-2910	102-2925	102-2910	102-2925	102-2910	102-2926	102-2910	102-2925	102-2910	102-2925	102-2910
Back Nozzle Positions																		
	Red Plug	Red Plug	Red Plug	Red Plug	Red Plug	Red Plug	Red Plug	Red Plug	Red Plug	Red Plug	Red Plug	Red Plug	Red Plug	Red Plug	Red Plug	Red Plug	Red Plug	Red Plug
	102-4335	102-4335	102-4335	102-4335	102-4335	102-4335	102-4335	102-4335	102-4335	102-4335	102-4335	102-4335	102-4335	102-4335	102-4335	102-4335	102-4335	102-4335
psi	Radius	gpm	Radius	gpm	Radius	gpm	Radius	gpm	Radius	gpm	Radius	gpm	Radius	gpm	Radius	gpm	Radius	gpm
50	52	13.9	62	17.4	66	20.7	69	28.6	—	—	—	—	—	—	—	—	—	—
65	54	15.7	64	20.8	68	23.4	74	31.2	76	33.8	—	—	—	—	—	—	—	—
80	57	17.2	68	22.9	72	25.8	77	34.4	79	37.2	85	39.4	89	43.6	92	47.5	96	57.0
100	59	19.1	73	25.5	76	28.7	80	38.2	84	41.3	89	43.7	94	48.5	95	51.1	100	61.1
Stator	102-1939 Yellow								102-1940 White				102-1941					
Conver.	INF55-6-5154								INF55-6-5558				INF55-6-59					

■ Not recommended at these pressures. Radius shown in feet.
 Toro recommends the use of a 1¼" swing joint at flows over 25-gpm (95-LPM). Sprinkler radius data collected in Toro's zero wind test facility per ASAE standard S398.1.
 Actual site conditions must be considered when selecting the appropriate nozzle.
 All sprinklers are equipped with the selectable pilot valve that allows settings at 50, 65, 80 and 100 psi.



Main Nozzle Adapter
 A wide assortment of intermediate and inner nozzles for use in the main nozzle adapter and back nozzle position provide unmatched nozzle flexibility.

Note: Main Nozzle Adapter Data Located on Page 68. Back Nozzle Data Located on Page 73.



The INFINITY 35/55 Series with SMART ACCESS® features a dual trajectory main nozzle that provides exceptional nozzle performance at the 25° standard angle position and great performance in windy applications at the 15° low angle position. And the part/full circle drive and ratcheting riser allows you to adjust the area of coverage to match your seasonal watering needs or meet water rationing mandates in seconds with no additional parts required.

FEATURES & BENEFITS

Industry's Largest Nozzle Selection

Nozzles from 25' to 92' radius plus a wide assortment of back nozzles lets you put the precise amount of water exactly where you need it. All nozzles threaded in from front.

Stainless Steel Valve Seat

Eliminates body damage from rocks and debris. This indestructible stainless steel seat is molded to the body and virtually eliminates body replacements due to seat damage. Standard on all Toro Golf rotors!

Radius Reduction Screw

Allows for fine tuning the radius to exactly the distance you need. In combination with main nozzle sizing and trajectory adjustment the radius reduction screw can effectively reduce the sprinkler throw down to 30'.

True Part and Full-Circle in One (40° - 330° part circle)

These sprinklers can be full circle today and part circle tomorrow allowing you to adjust the area of coverage to match your seasonal needs or meet water rationing mandates.



- ✓ Eliminates sprinkler interference
- ✓ Enhances course appearance



INFINITY® SERIES DISTANCE MARKERS

- Set your course apart with Toro's unique, customizable distance markers
- White (118-6234) and Yellow (118-6235) color options provide excellent visibility
 - Customizable with any graphic image
 - Multiple number and orientation options available
 - Any font style
 - Easy snap-in installation into any INFINITY golf sprinkler

Smart Access®

Provides top accessibility to all critical components.

- ✓ No digging or unsightly turf repair scars
- ✓ No buried wire splices or ground faults
- ✓ Pilot valve removable with water "ON"
- ✓ Lower long term cost of ownership
- ✓ Customizable marker
- ✓ Replaceable cover if damaged
- ✓ Increased labor efficiency



25°

OR

15°

Dual Trajectory
The 25° setting provides maximum distance of throw and the 15° setting provides improved wind performance, radius reduction and obstacle avoidance.

INF35 CONVERSION UPGRADES

MODELS	DESCRIPTION
• INF35-3134	INF35 w/31–34 Nozzles (#3 Nozzle Installed)
• INF35-3537	INF35 w/35–37 Nozzles (#5 Nozzle Installed)
• INF35-3134E	INF35 w/31–34 Nozzles (#3 Nozzle Installed), Effluent
• INF35-3537E	INF35 w/35–37 Nozzles (#5 Nozzle Installed), Effluent



INF55 CONVERSION UPGRADES

MODELS	DESCRIPTION
• INF55-5154	INF55 w/51–54 Nozzles (#3 Nozzle Installed)
• INF55-5558	INF55 w/55–58 Nozzles (#5 Nozzle Installed)
• INF55-59	INF55 w/59 Nozzle
• INF55-5154E	INF55 w/51–54 Nozzles (#3 Nozzle Installed), Effluent
• INF55-5558E	INF55 w/55–58 Nozzles (#5 Nozzle Installed), Effluent
• INF55-59E	INF55 w/59 Nozzle, Effluent

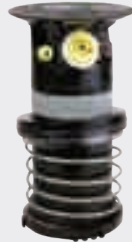

SPECIFICATIONS

Operational

- Inlet:
 - INF35: 1" ACME
 - INF55: 1½" ACME
- Radius:
 - INF35: 43' – 83'
 - INF55: 55' – 92'
- Flow Rate:
 - INF35: 8.2 – 47.3 gpm
 - INF55: 14.1 – 61.3 gpm
- Precipitation Rates:
 - INF35: Minimum - .41"/hr; Maximum - .45"/hr
 - INF55: Minimum - .46"/hr; Maximum - .58"/hr
- Pilot Valve: Selectable at 50, 65, 80 and 100 psi
- Recommended Operating Pressure Range: 65-100 psi (maximum – 150 psi and minimum – 40 psi)
- Activation types – Electric Valve-in-Head:
 - Standard Solenoid:
 - 24 VAC, 50/60 Hz
 - Inrush: 0.30 A
 - Holding 0.20 A
 - Spike Guard Solenoid:
 - 24 VAC, 50/60 Hz
 - Inrush: 0.12 A
 - Holding 0.10 A
 - Nickel-Plated Spike Guard Solenoid:
 - 24 VAC, 50/60 Hz
 - Inrush: 0.12 A
 - Holding 0.10 A
 - DC Latching Solenoid (DCLS):
 - Momentary low voltage pulse
 - Integrated Lynx Smart Module w/DCLS:
 - Momentary low voltage pulse

Additional Features

- INF35 has eight nozzle variations (30, 31, 32, 33, 34, 35, 36 & 37)
- INF55 has nine nozzle variations (51, 52, 53, 54, 55, 56, 57, 58 & 59)
- Three in-line nozzles, rotating stream pattern
- Two back nozzle positions
- Stator variations: 3
- Radius reduction screw 363-4839 for fine tuning
- Ratcheting riser
- Nozzle base clutching

Dimensions

- SMART ACCESS® Cover and Compartment Diameter:
 - INF35: 7 5/8"
 - INF55: 7 3/8"
- Body height:
 - INF35: 10"
 - INF55: 11 3/8"
- Weight:
 - INF35: 4.26 lbs.
 - INF55: 5.08 lbs.
- Weight – Intergrated with Lynx Smart Module:
 - INF35: 4.95 lbs.
 - INF55: 5.71 lbs.
- Pop-up height to nozzle: 3¼"

Warranty

- Three years
- Five years when installed with Toro Swing Joints

Specifying Information—INFINITY 35 & INFINITY 55

INF35-XXX-XX					
Body Inlet	Arc	Nozzle	Pressure Regulation*	Activation Type	Optional
INF35	5	XX	X	X	X
3–1" 5–1½"	5—Part-circle and Full-circle In One	INF35—30, 31, 32, 33, 34, 35, 36, 37 INF55—51, 52, 53, 54, 55, 56, 57, 58, 59	6—65 psi 8—80 psi 1—100 psi	1—Standard Solenoid 2—Spike Guard™ Solenoid 3—Nickel-plated Spike Guard Solenoid 4—DC Latching Solenoid (DCLS) 6—Integrated Lynx Smart Module w/DCLS	7—Effluent

Example: When specifying an INF35 Series Sprinkler with #34 nozzle, pressure regulation at 65 psi and Spike Guard you would specify: **INF35-346-2**

































Note: Not all models available.

* All sprinklers are equipped with the selectable pilot valve that allows settings at 50, 65, 80 and 100 psi.



INFINITY® 35/55 SERIES GOLF ROTORS

INFINITY 35 SERIES PERFORMANCE CHART—25°

Front Nozzle Positions	Nozzle Set 30  (White Plug)		Nozzle Set 31  (Yellow)		Nozzle Set 32  (Blue)		Nozzle Set 33  (Brown)		Nozzle Set 34  (Orange)		Nozzle Set 35  (Green)		Nozzle Set 36  (Gray)		Nozzle Set 37  (Black)	
	102-2208		102-6906		102-0726		102-6907		102-0728		102-6955		102-6935		102-6936	
																
	102-5670	102-6942	102-5670	102-5671	102-5670	102-6884	102-5670	102-6884	102-5670	102-6884	102-5670	102-6885	102-6531	102-6885	102-6531	102-6885
Back Nozzle Positions																
	Red Plug	Red Plug	Red Plug	Red Plug	Red Plug	Red Plug	Red Plug	Red Plug	Red Plug	Red Plug	Red Plug	Red Plug	Red Plug	Red Plug	Red Plug	
	102-4335	102-4335	102-4335	102-4335	102-4335	102-4335	102-4335	102-4335	102-4335	102-4335	102-4335	102-4335	102-4335	102-4335	102-4335	
psi	Radius	gpm	Radius	gpm	Radius	gpm	Radius	gpm	Radius	gpm	Radius	gpm	Radius	gpm	Radius	gpm
50	43	8.2	53	13.8	56	18.3	61	21.7	65	25.3	—	—	—	—	—	—
65	45	10.0	53	15.5	59	20.5	64	24.4	68	28.2	72	34.1	—	—	—	—
80	46	11.5	57	17.3	62	22.7	67	27.1	71	31.1	75	37.8	78	40.3	80	44.0
100	47	13.4	59	19.1	65	24.9	70	29.8	74	34.1	79	40.9	81	43.8	83	47.3

INFINITY 35 SERIES PERFORMANCE CHART—15°

psi	Radius	gpm	Radius	gpm	Radius	gpm	Radius	gpm	Radius	gpm	Radius	gpm	Radius	gpm	Radius	gpm
50	43	8.2	52	13.6	58	18.1	61	21.5	62	25.6	—	—	—	—	—	—
65	45	10.0	54	15.3	60	20.3	64	24.2	65	27.3	69	33.1	—	—	—	—
80	46	11.5	58	17.2	64	22.6	69	26.8	69	30.2	75	36.8	76	39.7	76	42.9
100	47	13.4	60	19.0	66	24.7	71	29.5	72	32.9	78	39.5	82	42.6	82	46.1
Stator	102-6929 Blue				102-1939 Yellow				102-1940 White							
Conversions					INF35-3134								INF35-3537			

Not recommended at these pressures. Radius shown in feet.
 Toro recommends the use of a 1¼" swing joint at flows over 25-Gpm (95-LPM). Sprinkler radius data collected in Toro's zero wind test facility per ASAE standard S398.1.
 Actual site conditions must be considered when selecting the appropriate nozzle.
 All sprinklers are equipped with the selectable pilot valve that allows settings at 50, 65, 80 and 100 psi.

INFINITY 35 NOZZLE APEX

Pressure	Nozzle	Apex at 15°	Apex at 25°
65 psi	31	6' @ 51'	13' @ 54'
	32	6' @ 51'	11' @ 64'
	33	7' @ 59'	13' @ 68'
	34	8' @ 63'	15' @ 74'
	35	9' @ 66'	15' @ 76'
80 psi	36	8' @ 75'	18' @ 83'
	37	9' @ 74'	19' @ 82'

INFINITY® 35/55 SERIES GOLF ROTORS



INFINITY 55 SERIES PERFORMANCE CHART—25°

Front Nozzle Positions	Nozzle Set 51		Nozzle Set 52		Nozzle Set 53		Nozzle Set 54		Nozzle Set 55		Nozzle Set 56		Nozzle Set 57		Nozzle Set 58		Nozzle Set 59	
	(Yellow)		(Blue)		(Brown)		(Orange)		(Green)		(Gray)		(Black)		(Red)		(Beige)	
	102-6906		102-0726		102-6907		102-0728		102-6955		102-6935		102-6936		102-6909		102-4259	
	Yellow	Brown	Yellow	Yellow	Yellow	Yellow	Yellow	Yellow	Yellow	Green	Green	Green	Green	Green	Green	Green	Green	Green
	102-5670	102-5671	102-5670	102-6884	102-5670	102-6884	102-5670	102-6884	102-5670	102-6885	102-6531	102-6885	102-6531	102-6885	102-6531	102-6885	102-6531	102-6885
Back Nozzle Positions																		
	Red Plug	Red Plug	Red Plug	Red Plug	Red Plug	Red Plug	Red Plug	Red Plug	Red Plug	Red Plug	Red Plug	Red Plug	Red Plug	Red Plug	Red Plug	Red Plug	Red Plug	Red Plug
	102-4335	102-4335	102-4335	102-4335	102-4335	102-4335	102-4335	102-4335	102-4335	102-4335	102-4335	102-4335	102-4335	102-4335	102-4335	102-4335	102-4335	102-4335
psi	Radius	gpm	Radius	gpm	Radius	gpm	Radius	gpm	Radius	gpm	Radius	gpm	Radius	gpm	Radius	gpm	Radius	gpm
50	55	14.1	57	18.5	62	22.3	66	25.8	73	35.9	—	—	—	—	—	—	—	—
65	57	15.8	60	20.9	65	25.1	69	28.7	76	39.7	80	43.1	83	48.2	85	50.0	89	57.5
80	59	17.5	61	23.1	68	27.8	72	31.7	76	39.7	80	43.1	83	48.2	85	50.0	89	57.5
100	61	19.3	63	25.3	71	30.3	75	34.5	80	43.5	83	49.0	88	51.5	90	53.9	92	61.3

INFINITY 55 SERIES PERFORMANCE CHART—15°

psi	Radius	gpm	Radius	gpm	Radius	gpm	Radius	gpm	Radius	gpm	Radius	gpm	Radius	gpm	Radius	gpm	Radius	gpm
50	55	14.0	59	16.5	62	22.2	63	25.6	—	—	—	—	—	—	—	—	—	—
65	56	15.6	62	20.7	65	25.0	66	28.5	75	35.3	—	—	—	—	—	—	—	—
80	59	17.4	66	23.0	69	27.7	70	31.5	78	39.0	78	42.4	79	46.9	79	49.5	82	57.2
100	60	19.2	68	25.1	71	30.2	72	34.3	80	41.9	81	47.2	83	52.1	83	53.4	85	60.8
Stator	102-1939 Yellow								102-1940 White								102-1941 White	
Conversions	INF35-3134								INF35-3537								INF55-59	

■ Not recommended at these pressures. Radius shown in feet.
 Toro recommends the use of a 1¼" swing joint at flows over 25-gpm (95-LPM). Sprinkler radius data collected in Toro's zero wind test facility per ASAE standard S398.1.
 Actual site conditions must be considered when selecting the appropriate nozzle.
 All sprinklers are equipped with the selectable pilot valve that allows settings at 50, 65, 80 and 100 psi.

INFINITY 55 NOZZLE APEX

Pressure	Nozzle	Apex at 15°	Apex at 25°
65 psi	51	6' @ 51'	13' @ 54'
	52	6' @ 51'	11' @ 64'
	53	7' @ 59'	13' @ 68'
	54	8' @ 63'	15' @ 74'
	55	9' @ 66'	15' @ 76'
80 psi	56	8' @ 75'	18' @ 83'
	57	9' @ 74'	19' @ 82'
	58	10' @ 82'	18' @ 87'
	59	11' @ 81'	21' @ 91'

Note: Main Nozzle Adapter Data Located on Page 68. Back Nozzle Data Located on Page 73.



The INFINITY 34/54 is Toro's Premium full-circle golf sprinkler series with SMART ACCESS®. The dual trajectory main nozzle provides exceptional nozzle performance at the 25° standard angle position and great performance in windy applications at the 15° low angle position. And the consistency of the constant velocity full circle drive ensures even water application across the coverage area every time you water.

FEATURES & BENEFITS

Industry's Largest Nozzle Selection

Nozzles from 52' to 100'. Color coded for easy flow and radius identification and threaded from the front to simplify servicing.

Constant Velocity Full Circle Drive

Ensures consistent rotation speeds when matched with station run times for even water application across the coverage area every time you water.

Radius Reduction Screw for Fine Tuning

In combination with main nozzle sizing and trajectory adjustment the radius reduction screw can effectively reduce the sprinkler throw down to 30'.

Five Activation Types

- ✓ Standard solenoid
- ✓ Spike Guard™ solenoid
- ✓ Nickel plated Spike Guard solenoid
- ✓ DC Latching Solenoid (DCLS)
- ✓ Integrated LSM module with DCLS
- ✓ Available on all INFINITY models!



- ✓ Eliminates sprinkler interference
- ✓ Enhances course appearance



INFINITY® SERIES DISTANCE MARKERS

- Set your course apart with Toro's unique, customizable distance markers*
- White (118-6234) and Yellow (118-6235) color options provide excellent visibility
 - Customizable with any graphic image
 - Multiple number and orientation options available
 - Any font style
 - Easy snap-in installation into any INFINITY golf sprinkler

Smart Access®

Provides top accessibility to all critical components.

- ✓ No digging or unsightly turf repair scars
- ✓ No buried wire splices or ground faults
- ✓ Pilot valve removable with water "ON"
- ✓ Lower long term cost of ownership
- ✓ Customizable marker
- ✓ Replaceable cover if damaged
- ✓ Increased labor efficiency



Dual Trajectory - 25° or 15°
Provides two selections for the main nozzle trajectory; the 25 degree setting provides maximum distance of throw and the 15 degree setting provides improved wind performance, radius reduction and obstacle avoidance.

INF34 CONVERSION UPGRADES

MODELS	DESCRIPTION
• INF34-3134	INF34 w/31-34 Nozzles (33 Nozzle Installed)
• INF34-3537	INF34 w/35-37 Nozzles (35 Nozzle Installed)
• INF34-3134E	INF34 w/31-34 Nozzles (33 Nozzle Installed), Effluent
• INF34-3537	INF34 w/35-37 Nozzles (35 Nozzle Installed), Effluent



INF54 CONVERSION UPGRADES

MODELS	DESCRIPTION
• INF54-5154	INF54 w/51-54 Nozzles (53 Nozzle Installed)
• INF54-5558	INF54 w/55-58 Nozzles (55 Nozzle Installed)
• INF54-59	INF54 w/59 Nozzle Installed
• INF54-5154E	INF54 w/51-54 Nozzles (53 Nozzle Installed), Effluent
• INF54-5558E	INF54 w/55-58 Nozzles (55 Nozzle Installed), Effluent
• INF54-59E	INF54 w/59 Nozzle Installed Effluent
• 102-5011	690 Adapter allows you to upgrade any 690 with FLX54 conversions
• 102-0950	Required to upgrade all 1.5" Series Sprinklers (650, 670, 680, 750, and 780)



SPECIFICATIONS

Features

- Dual Trajectory adjustment on main nozzle - 25° or 15°
- Constant velocity full circle drive
- Radius reduction screw can effectively reduce the sprinkler throw down to 30'

Operational

- Inlet:
 - INF34: 1" ACME
 - INF54: 1½" ACME
- Radius:
 - INF34: 52' - 91'
 - INF54: 52' - 99'
- Flow Rate:
 - INF34: 13.0 - 46.9 gpm
 - INF54: 13.2 - 61.8 gpm
- Precipitation Rates:
 - INF34: Minimum - .33"/hr; Maximum - .55"/hr
 - INF54: Minimum - .33"/hr; Maximum - .61"/hr
- Pilot Valve: Selectable at 50, 65, 80 and 100 psi
- Recommended Operating Pressure Range: 65-100 psi (maximum-150 psi and minimum-40 psi)
- Activation types - Electric Valve-in-Head:
 - Standard Solenoid:
 - 24 VAC, 50/60 Hz
 - Inrush: 0.30 A
 - Holding 0.20 A
 - Spike Guard Solenoid:
 - 24 VAC, 50/60 Hz
 - Inrush: 0.12 A
 - Holding 0.10 A
 - Nickel-Plated Spike Guard Solenoid:
 - 24 VAC, 50/60 Hz
 - Inrush: 0.12 A
 - Holding 0.10 A
 - DC Latching Solenoid (DCLS):
 - Momentary low voltage pulse
 - Integrated Lynx Smart Module w/DCLS:
 - Momentary low voltage pulse
- Trajectory: 25° or 15°

Dimensions

- SMART ACCESS® Cover and Compartment Diameter:
 - INF34: 7 5/8"
 - INF54: 7 5/8"
- Body height:
 - INF34: 10"
 - INF54: 11 3/8"
- Weight:
 - INF34: 4.22 lbs.
 - INF54: 5.04 lbs.
- Weight - Intergrated with Lynx Smart Module:
 - INF35: 4.95 lbs.
 - INF55: 5.71 lbs.
- Pop-up height to nozzle: 3 1/4"

Warranty

- Three years
- Five years when installed with Toro Swing Joints

Specifying Information—INFINITY 34 & INFINITY 54





































INF34-XXX-X-X					
Body Inlet	Arc	Nozzle	Pressure Regulation*	Activation Type	Optional
INF34	4	XX	X	X	X
3-1" 5-1½"	4-Full Circle	INF34-31, 32, 33, 34, 35, 36, 37 INF54-51, 52, 53, 54, 55, 56, 57, 58, 59	6-65 psi 8-80 psi 1-100 psi	1-Standard Solenoid 2-Spike Guard™ Solenoid 3-Nickel-plated Spike Guard Solenoid 4-DC Latching Solenoid (DCLS) 6-Integrated Lynx Smart Module w/DCLS	7-Effluent

Example: When specifying an INF34 Series Sprinkler with #34 nozzle, pressure regulation at 65 psi and Spike Guard you would specify: **INF34-346-2**

Note: Not all models available.

* All sprinklers are equipped with the selectable pilot valve that allows settings at 50, 65, 80 and 100 psi.

INFINITY 34 SERIES PERFORMANCE CHART—25°

Front Nozzle Positions	Nozzle Set 31  (Yellow)		Nozzle Set 32  (Blue)		Nozzle Set 33  (Brown)		Nozzle Set 34  (Orange)		Nozzle Set 35  (Green)		Nozzle Set 36  (Gray)		Nozzle Set 37  (Black)		
	102-0725		102-7001		102-0727		102-7002		102-6908		102-0730		102-4261		
															
	102-4335	102-4335	102-4335	102-4335	102-4335	102-4335	102-4335	102-4335	102-4335	102-4335	102-4335	102-4335	102-4335	102-4335	102-6883
Back Nozzle Positions															
	102-6937	102-2925	102-6937	102-2926	102-6937	102-2928	102-6937	102-2929	102-6937	102-2929	102-6937	102-6944	102-6937	102-6945	
psi	Radius	gpm	Radius	gpm	Radius	gpm	Radius	gpm	Radius	gpm	Radius	gpm	Radius	gpm	
50	57	13.0	58	15.5	64	21.9	68	24.4	—	—	—	—	—	—	
65	58	14.6	60	18.0	68	24.4	72	28.1	76	32.2	—	—	—	—	
80	60	16.2	63	20.5	72	26.9	76	31.1	80	35.6	83	38.2	85	41.5	
100	62	17.9	66	23.4	75	29.8	79	34.9	84	49.3	88	43.4	91	46.9	

INFINITY 34 SERIES PERFORMANCE CHART—15°

psi	Radius	gpm	Radius	gpm	Radius	gpm	Radius	gpm	Radius	gpm	Radius	gpm	Radius	gpm
50	52	12.9	53	15.6	60	21.7	62	25.5	—	—	—	—	—	—
65	53	14.4	54	17.1	61	24.2	64	28.0	67	32.1	—	—	—	—
80	56	16.0	57	19.0	65	26.6	69	31.0	73	35.5	76	38.0	77	41.3
100	57	17.5	59	20.5	67	29.5	71	33.9	75	38.4	80	43.1	81	46.8
Stator	102-6929 Blue						102-1940 White							
Conversions	INF34-3134						INF34-3537							

■ Not recommended at these pressures. Radius shown in feet.
 Toro recommends the use of a 1½" swing joint at flows over 25-gpm (95-LPM). Sprinkler radius data collected in Toro's zero wind test facility per ASAE standard S398.1.
 Actual site conditions must be considered when selecting the appropriate nozzle.
 All sprinklers are equipped with the selectable pilot valve that allows settings at 50, 65, 80 and 100 psi.

INFINITY 34 NOZZLE APEX

Pressure	Nozzle	Apex at 15°	Apex at 25°
65 psi	31	6' @ 51'	13' @ 54'
	32	6' @ 51'	11' @ 64'
	33	7' @ 59'	13' @ 68'
	34	8' @ 63'	15' @ 74'
	35	9' @ 66'	15' @ 76'
80 psi	36	8' @ 75'	18' @ 83'
	37	9' @ 74'	19' @ 82'



INFINITY 54 SERIES PERFORMANCE CHART—25°

Front Nozzle Positions	Nozzle Set 51		Nozzle Set 52		Nozzle Set 53		Nozzle Set 54		Nozzle Set 55		Nozzle Set 56		Nozzle Set 57		Nozzle Set 58		Nozzle Set 59		
	(Yellow)		(Blue)		(Brown)		(Orange)		(Green)		(Gray)		(Black)		(Red)		(Beige)		
	102-0725		102-7001		102-0727		102-7002		102-6908		102-0730		102-4261		102-4260		102-4259		
Red Plug	Red Plug	Red Plug	Red Plug	Red Plug	Red Plug	Red Plug	Red Plug	Red Plug	Red Plug	Red Plug	Red Plug	Red Plug	Red Plug	Brown	Red Plug	Brown	Red Plug	Red Plug	
102-4335	102-4335	102-4335	102-4335	102-4335	102-4335	102-4335	102-4335	102-4335	102-4335	102-4335	102-4335	102-4335	102-4335	102-6883	102-4335	102-6883	102-4335	102-4335	
Back Nozzle Positions																			
	Yellow	Blue	Yellow	Orange	Yellow	Red	Yellow	Beige	Yellow	Beige	Yellow	Red	Yellow	Gray	Yellow	Gray	Yellow	Gray	
	102-6937	102-2925	102-6937	102-2926	102-6937	102-2928	102-6937	102-2929	102-6937	102-2929	102-6937	102-6944	102-6937	102-6945	102-6937	102-6945	102-6937	102-6945	
psi	Radius	gpm	Radius	gpm	Radius	gpm	Radius	gpm	Radius	gpm	Radius	gpm	Radius	gpm	Radius	gpm	Radius	gpm	
50	58	13.2	59	15.7	64	22.0	70	26.2	—	—	—	—	—	—	—	—	—	—	
65	60	14.8	61	17.5	68	24.8	74	29.3	79	34.2	—	—	—	—	—	—	—	—	
80	61	16.4	64	20.0	72	27.6	78	32.6	83	38.0	85	40.7	87	44.9	91	50.2	96	55.6	
100	63	18.1	67	23.6	75	30.4	81	36.7	87	42.5	90	45.8	93	50.2	95	55.4	99	61.8	

INFINITY 54 SERIES PERFORMANCE CHART—15°

psi	Radius	gpm	Radius	gpm	Radius	gpm	Radius	gpm	Radius	gpm	Radius	gpm	Radius	gpm	Radius	gpm	Radius	gpm
50	52	13.2	53	15.6	61	22.0	65	26.0	—	—	—	—	—	—	—	—	—	—
65	53	14.8	54	17.1	63	24.8	67	29.2	69	34.1	—	—	—	—	—	—	—	—
80	56	16.4	58	19.0	68	27.6	72	32.5	75	37.8	79	40.4	81	44.6	85	49.9	87	55.3
100	58	18.1	60	20.5	71	30.4	75	36.4	79	42.3	84	45.5	87	49.9	89	55.1	94	61.5
Stator	102-6929 Blue								102-1940 White								102-1941 White	
Conversions	INF54-5154								INF54-5558								INF54-59	

■ Not recommended at these pressures. Radius shown in feet.
 Toro recommends the use of a 1/4" swing joint at flows over 25-gpm (95-LPM). Sprinkler radius data collected in Toro's zero wind test facility per ASAE standard S398.1.
 Actual site conditions must be considered when selecting the appropriate nozzle.
 All sprinklers are equipped with the selectable pilot valve that allows settings at 50, 65, 80 and 100 psi.

INFINITY 54 NOZZLE APEX

Pressure	Nozzle	Apex at 15°	Apex at 25°
65 psi	51	6' @ 51'	13' @ 54'
	52	6' @ 51'	11' @ 64'
	53	7' @ 59'	13' @ 68'
	54	8' @ 63'	15' @ 74'
	55	9' @ 66'	15' @ 76'
80 psi	56	8' @ 75'	18' @ 83'
	57	9' @ 74'	19' @ 82'
	58	10' @ 82'	18' @ 87'
	59	11' @ 81'	21' @ 91'



Main Nozzle Adapter
 A wide assortment of intermediate and inner nozzles for use in the main nozzle adapter and back nozzle position provide unmatched nozzle flexibility.

Note: Main Nozzle Adapter Data Located on Page 68. Back Nozzle Data Located on Page 73.



Extend the frequency of digging up and leveling sprinklers with the Toro[®] INFINITY Razor kits. Over time the application of topdressing and settling can result in the sprinkler being in a depression below grade level. This can interfere in the natural roll of the ball, create trip hazards and take away from the natural beauty of the course. The Razor kits are designed to raise the top of the sprinkler in 1/2" increments up to 1 1/2" (3 stages) without digging!!

FEATURES & BENEFITS

- ✓ Eliminates sprinkler interference
- ✓ Eliminates trip hazards
- ✓ Enhances course appearance
- ✓ Huge labor savings – no digging required!
- ✓ Retention features – hardware never gets lost
- ✓ Smart Access[®] compartment enables access to pilot valve, Lynx[®] Smart Module, wire splices and more



Pilot Valve stacker retention feature

Screw retention features (3 places)

INFINITY RAZOR KITS

Model	Description
RAZOR-10-1	Razor Kit, 1" INFINITY, Stage 1 with 1.5" screws and pilot valve stacker
RAZOR-10-2	Razor Kit, 1" INFINITY, Stage 2 with 2" screws and pilot valve stacker
RAZOR-10-3	Razor Kit, 1" INFINITY, Stage 3 with 2.5" screws and pilot valve stacker
RAZOR-15-1	Razor Kit, 1.5" INFINITY, Stage 1 with 1.5" screws and pilot valve stacker
RAZOR-15-2	Razor Kit, 1.5" INFINITY, Stage 2 with 2" screws and pilot valve stacker
RAZOR-15-3	Razor Kit, 1.5" INFINITY, Stage 3 with 2.5" screws and pilot valve stacker

For more details see installation instructions 373-1015



1" Models

1.5" Models





Eliminate sprinkler interference with the outcome of the game forever! Toro's INFINITY Stealth Kits can be installed onto any INFINITY sprinkler allowing turf growth directly atop the sprinkler to eliminate the hard surface bounce should a golf ball hit it. The seamless turf appearance adds to the beauty of the course and improves labor efficiency by minimizing trimming efforts around the sprinklers.

FEATURES & BENEFITS

- ✓ Eliminates sprinkler interference
- ✓ Enhances course appearance
- ✓ Natural turf atop sprinkler
- ✓ Kit fits existing INFINITY sprinklers
- ✓ Easy access to arc adjustment, snap rings, riser removal assembly, valve and rock screen
- ✓ Smart Access® compartment enables access to Pilot valve, Lynx Smart Module, wire splices & more
- ✓ Access to manual selector and TruJectory™ adjuster with minimal turf/soil displacement
- ✓ Turf cup grass can be grown in a nursery prior to being installed onto the sprinkler



STEALTH™ KIT MODELS

STEALTH-T – Kit attaches to INFINITY Series sprinklers with TruJectory™ style, 24-position main nozzle adjustment capability

STEALTH-D – Kit attaches to INFINITY Series sprinklers with dual trajectory main nozzle adjustment capability

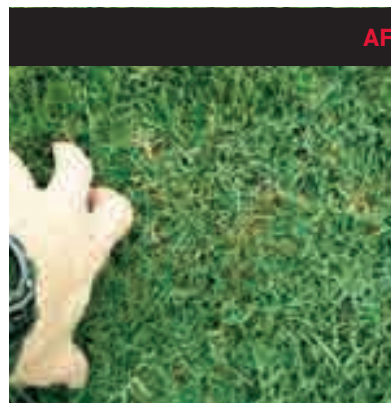
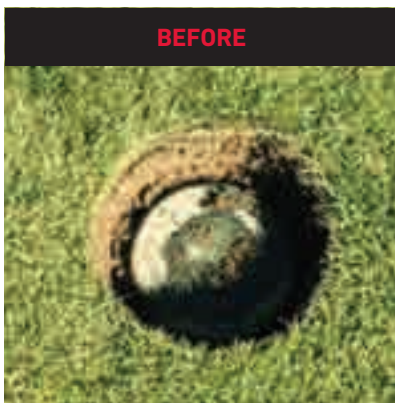

Enhanced appearance and increased efficiency

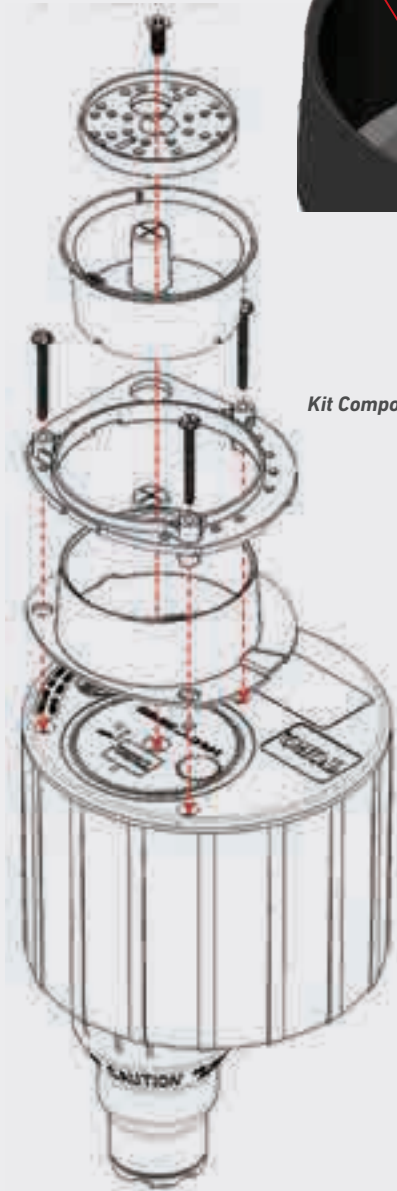

Kit Components



*Turf Removal for
Compartment Access
8" Cutter*





With the industry's largest selection of high performance nozzles and TruJectory™ adjustment the FLEX800 35-6/55-6 Series allows you to put water precisely where you want it for maximum distribution uniformity. And the part/full circle drive allows you to simply and economically adjust the area of coverage to match your seasonal watering needs or meet water rationing mandates in seconds with no disassembly or additional parts required.

FEATURES & BENEFITS

Industry's Largest Nozzle Selection

Nozzles from 42' to 100' radius plus a wide assortment of back nozzles lets you put the precise amount of water exactly where you need it. All nozzles threaded in from the front.

20,000 Volt Lightning Rating

Spike-Guard™ solenoid virtually eliminates the need for replacements in high lightning areas. Draws half the amperage of traditional solenoids so you can run twice as many sprinklers simultaneously, reduce the cost of wire during initial installation or increase the distance from controller to sprinkler.

Adjustment With No Disassembly

Toro exclusive, simply pull up the riser and ratchet it to the precise position you want to water.

True Part and Full-Circle in One (40° - 330° part circle)

These sprinklers can be full circle today and part circle tomorrow allowing you to simply and economically adjust the area of coverage to match your seasonal needs or meet water rationing mandates.



Trajectory – 24 Positions
From 7° - 30° in 1° increments put water where you want it. Adjust from the top of the sprinkler in seconds, wet or dry. This flexibility lets you tackle every obstacle on the course; wind, trees, bunkers, mounds and more.

FLX35-6 CONVERSION UPGRADES

MODELS	DESCRIPTION
• FLX35-6-3134	FLX35-6 w/31-34 Nozzles (33 Nozzle Installed)
• FLX35-6-3537	FLX35-6 w/35-37 Nozzles (35 Nozzle Installed)
• FLX35-6-3134E	FLX35-6 w/31-34 Nozzles (33 Nozzle Installed), Effluent
• FLX35-6-3537E	FLX35-6 w/35-37 Nozzles (35 Nozzle Installed), Effluent



FLX55-6 CONVERSION UPGRADES — RIBBED BODY

MODELS	DESCRIPTION
• FLX55-6-5154	FLX55-6 w/51-54 Nozzles (53 Nozzle Installed)
• FLX55-6-5558	FLX55-6 w/55-58 Nozzles (55 Nozzle Installed)
• FLX55-6-59	FLX55-6 w/59 Nozzle Installed
• FLX55-6-5154E	FLX55-6 w/51-54 Nozzles (53 Nozzle Installed), Effluent
• FLX55-6-5558E	FLX55-6 w/55-58 Nozzles (55 Nozzle Installed), Effluent
• FLX55-6-59E	FLX55-6 w/59 Nozzle Installed, Effluent
• 102-5011	690 Adapter allows you to upgrade any 690 with FLX55-6 conversions
• 102-0950	Required to upgrade all 650, 670, 680, 750, and 780 Series Sprinklers



FLX55-6 CONVERSION UPGRADES — RIBBLESS BODY

MODELS	DESCRIPTION
• FLX55-6-5154R	FLX55-6 w/51-54 Nozzles (53 Nozzle Installed)
• FLX55-6-5558R	FLX55-6 w/55-58 Nozzles (55 Nozzle Installed)
• FLX55-6-59R	FLX55-6 w/59 Nozzle Installed
• FLX55-6-5154RE	FLX55-6 w/51-54 Nozzles (53 Nozzle Installed), Effluent
• FLX55-6-5558RE	FLX55-6 w/55-58 Nozzles (55 Nozzle Installed), Effluent
• FLX55-6-59RE	FLX55-6 w/59 Nozzle Installed, Effluent



SPECIFICATIONS

Operational

- Inlet:
 - FLX35-6: 1" ACME
 - FLX55-6: 1½" ACME
- Radius:
 - FLX35-6: 42' - 92'
 - FLX55-6: 52' - 100'
- Flow Rate:
 - FLX35-6: 7.1 - 45.3 gpm
 - FLX55-6: 13.9 - 61.1 gpm
- Precipitation Rates:
 - FLX35-6: Minimum - .37"/hr; Maximum - .53"/hr
 - FLX55-6: Minimum - .43"/hr; Maximum - .60"/hr
- Pilot Valve: Selectable at 50, 65, 80 and 100 psi
- Recommended Operating Pressure Range: 65-100 psi (maximum -150 psi and minimum - 40 psi)
- Activation types - Electric Valve-in-Head:
 - Standard Solenoid:
 - 24 VAC, 50/60 Hz
 - Inrush: 0.30 A
 - Holding 0.20 A
 - Spike Guard Solenoid:
 - 24 VAC, 50/60 Hz
 - Inrush: 0.12 A
 - Holding 0.10 A
 - Nickel-Plated Spike Guard Solenoid:
 - 24 VAC, 50/60 Hz
 - Inrush: 0.12 A
 - Holding 0.10 A
 - DC Latching Solenoid (DCLS):
 - Momentary low voltage pulse
 - Integrated Lynx Smart Module w/DCLS:
 - Momentary low voltage pulse
- Trajectory: 24 positions from 7° - 30° in 1° increments

Additional Features

- FLX35-6 has eight nozzle variations (30, 31, 32, 33, 34, 35, 36 and 37)
- FLX55-6 has nine nozzle variations (51, 52, 53, 54, 55, 56, 57, 58 and 59)
- Four in-line nozzles, rotating stream pattern
- One back nozzle position
- Stator variations: FLX35-6 - 3 and FLX55-6 - 3
- Ratcheting riser
- Nozzle base clutching

Dimensions

- Body Flange Diameter:
 - FLX35-6: 6 1/2"
 - FLX55-6: 7 1/2"
- Body height:
 - FLX35-6: 10"
 - FLX55-6: 11 3/8"
- Weight:
 - FLX35-6: 2.94 lbs.
 - FLX55-6: 3.61 lbs.
- Weight Integrated Lynx Smart Module
 - FLX35-6: 3.63 lbs.
 - FLX55-6: 4.30 lbs.
- Pop-up height to nozzle: 3 1/4"

Warranty

- Three years
- Five years when installed with Toro Swing Joints

Specifying Information—FLEX800 35-6 & FLEX800 55-6

FLXX5-XXX-X6-X						
Body Inlet	Arc	Nozzle	Pressure Regulation*	Activation Type	Trajectory	Optional
FLXX	5	XX	X	X	6	X
3-1" 5-1½"	5-Part-circle and Full-circle In One	FLX35 -30, 31, 32, 33, 34, 35, 36, 37 FLX55 -51, 52, 53, 54, 55, 56, 57, 58, 59	6-65 psi 8-80 psi 1-100 psi	1-Standard Solenoid 2-Spike Guard™ Solenoid 3-Nickel-plated Spike Guard Solenoid 4-DC Latching Solenoid (DCLS) 6-Integrated Lynx Smart Module w/DCLS	6-24-position TruJectory	7-Effluent
Example: When specifying an FLX35-6 Series Sprinkler with #34 nozzle, pressure regulation at 65 psi and Spike Guard you would specify: FLX35-346-26						

Note: Not all models available.

* All sprinklers are equipped with the selectable pilot valve that allows settings at 50, 65, 80 and 100 psi.



FLEX800™ 35-6/55-6 SERIES GOLF ROTORS

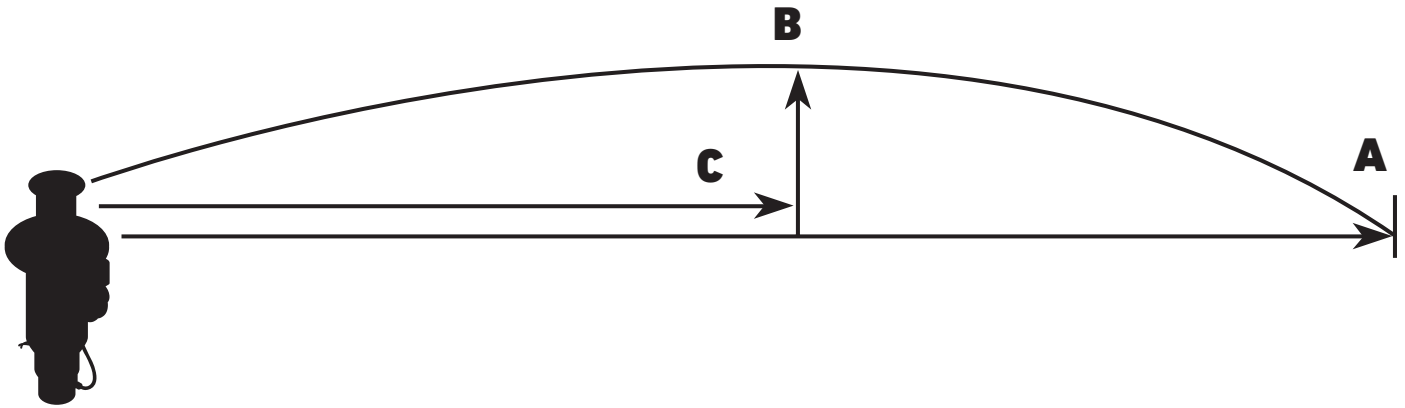

FLEX800 35-6 TRAJECTORY PERFORMANCE

Nozzle/psi/gpm	#31 Nozzle @ 65 psi, 15.5 gpm						#32 Nozzle @ 65 psi, 20.5 gpm						#33 Nozzle @ 65 psi, 22.9 gpm					
Trajectory	7°	10°	15°	20°	25°	30°	7°	10°	15°	20°	25°	30°	7°	10°	15°	20°	25°	30°
"A" Radius	46'	46'	50'	53'	54'	50'	46'	49'	51'	55'	63'	54'	54'	56'	59'	62'	66'	61'
"B" Spray Height	4'	4'	5'	8'	11'	13'	3'	4'	6'	9'	12'	15'	4'	5'	7'	9'	13'	15'
"C" Distance from Head	25'	25'	26'	33'	33'	33'	20'	24'	28'	34'	34'	34'	23'	28'	32'	34'	35'	35'

Nozzle/psi/gpm	#34 Nozzle @ 65 psi, 30.0 gpm						#35 Nozzle @ 65 psi, 32.4 gpm						#36 Nozzle @ 80 psi, 34.0 gpm					
Trajectory	7°	10°	15°	20°	25°	30°	7°	10°	15°	20°	25°	30°	7°	10°	15°	20°	25°	30°
"A" Radius	58'	60'	63'	67'	74'	70'	59'	61'	64'	70'	76'	74'	64'	68'	76'	80'	84'	82'
"B" Spray Height	4'	4'	6'	11'	14'	17'	4'	5'	7'	11'	15'	17'	5'	7'	9'	14'	17'	22'
"C" Distance from Head	24'	26'	35'	39'	39'	39'	30'	32'	36'	43'	43'	43'	25'	38'	40'	45'	49'	45'

Nozzle/psi/gpm	#37 Nozzle @ 80 psi, 39.8 gpm					
Trajectory	7°	10°	15°	20°	25°	30°
"A" Radius	65'	69'	78'	82'	86'	84'
"B" Spray Height	5'	7'	9'	14'	18'	22'
"C" Distance from Head	30'	39'	41'	46'	50'	46'

FLEX800 55-6 TRAJECTORY PERFORMANCE

Nozzle/psi/gpm	#51 Nozzle @ 65 psi, 15.7 gpm						#52 Nozzle @ 65 psi, 20.8 gpm						#53 Nozzle @ 65 psi, 23.4 gpm					
Trajectory	7°	10°	15°	20°	25°	30°	7°	10°	15°	20°	25°	30°	7°	10°	15°	20°	25°	30°
"A" Radius	46'	46'	51'	53'	54'	50'	49'	50'	51'	55'	64'	65'	54'	56'	59'	62'	68'	61'
"B" Spray Height	4'	4'	6'	10'	13'	15'	4'	4'	6'	9'	11'	13'	5'	6'	7'	9'	13'	15'
"C" Distance from Head	26'	27'	32'	38'	40'	41'	22'	26'	31'	35'	34'	30'	30'	33'	32'	35'	37'	37'

Nozzle/psi/gpm	#54 Nozzle @ 65 psi, 31.2 gpm						#55 Nozzle @ 65 psi, 33.8 gpm						#56 Nozzle @ 80 psi, 35.7 gpm					
Trajectory	7°	10°	15°	20°	25°	30°	7°	10°	15°	20°	25°	30°	7°	10°	15°	20°	25°	30°
"A" Radius	58'	60'	63'	67'	74'	70'	59'	62'	66'	70'	76'	77'	72'	73'	75'	82'	85'	82'
"B" Spray Height	5'	6'	8'	10'	15'	17'	6'	6'	9'	11'	15'	17'	5'	7'	9'	14'	17'	22'
"C" Distance from Head	31'	34'	40'	41'	41'	42'	34'	36'	43'	45'	45'	45'	25'	38'	40'	45'	49'	45'

Nozzle/psi/gpm	#57 Nozzle @ 80 psi, 41.9 gpm						#58 Nozzle @ 80 psi, 46.2 gpm						#59 Nozzle @ 80 psi, 53.3 gpm					
Trajectory	7°	10°	15°	20°	25°	30°	7°	10°	15°	20°	25°	30°	7°	10°	15°	20°	25°	30°
"A" Radius	72'	74'	77'	83'	89'	85'	75'	77'	83'	87'	92'	88'	77'	78'	84'	89'	96'	92'
"B" Spray Height	5'	7'	9'	14'	18'	22'	6'	7'	10'	15'	18'	22'	7'	8'	11'	16'	21'	25'
"C" Distance from Head	30'	39'	41'	46'	50'	46'	38'	40'	43'	47'	52'	48'	42'	44'	45'	47'	53'	49'

Information is for reference only. Actual results may vary.



FLEX800 35-6 SERIES PERFORMANCE CHART

Base Pressure	Nozzle Set 30		Nozzle Set 31		Nozzle Set 32		Nozzle Set 33		Nozzle Set 34		Nozzle Set 35		Nozzle Set 36		Nozzle Set 37			
	(White)		(Yellow)		(Blue)		(Brown)		(Orange)		(Green)		(Gray)		(Black)			
	102-2208		102-4587		102-4588		102-4589		102-0728		102-0729		102-0730		102-4261			
	Blue	Gray	Blue	Gray	Red	Gray	Orange	Gray	Orange	Gray	Blue	Gray	Blue	Gray	Orange	Gray		
	102-2925	102-2910	102-2925	102-2910	102-2928	102-2910	102-2926	102-2910	102-2926	102-2910	102-2925	102-2910	102-2925	102-2910	102-2926	102-2910		
Back Nozzle Positions																		
	Red Plug	Red Plug	Red Plug	Red Plug	Red Plug	Red Plug	Red Plug	Red Plug	Red Plug	Red Plug	Red Plug	Red Plug	Red Plug	Red Plug	Red Plug	Red Plug	Red Plug	
	102-4335	102-4335	102-4335	102-4335	102-4335	102-4335	102-4335	102-4335	102-4335	102-4335	102-4335	102-4335	102-4335	102-4335	102-4335	102-4335	102-4335	
psi	Radius	gpm	Radius	gpm	Radius	gpm	Radius	gpm	Radius	gpm	Radius	gpm	Radius	gpm	Radius	gpm	Radius	gpm
50	42	7.1	52	13.7	61	17.1	64	20.2	69	27.4	—	—	—	—	—	—	—	—
65	45	8.7	54	15.5	63	20.5	66	22.9	74	30.0	76	32.4	—	—	—	—	—	—
80	46	9.6	57	17.0	67	22.6	70	25.3	77	33.2	79	35.8	84	37.5	86	40.8	88	45.3
100	48	11.2	59	18.9	72	25.2	74	28.2	80	37.0	84	39.9	88	42.5	92	45.3	92	45.3
Stator	102-6929 Blue				102-1939 Yellow								102-1940 White					
Conversions					FLX35-6-3134								FLX35-6-3537					

FLEX800 55-6 SERIES PERFORMANCE CHART

Base Pressure	Nozzle Set 51		Nozzle Set 52		Nozzle Set 53		Nozzle Set 54		Nozzle Set 55		Nozzle Set 56		Nozzle Set 57		Nozzle Set 58		Nozzle Set 59			
	(Yellow)		(Blue)		(Brown)		(Orange)		(Green)		(Gray)		(Black)		(Red)		(Beige)			
	102-4587		102-4588		102-4589		102-0728		102-0729		102-0730		102-4261		102-4260		102-4259			
	Blue	Gray	Red	Gray	Orange	Gray	Orange	Gray	Blue	Gray	Blue	Gray	Orange	Gray	Blue	Gray	Blue	Gray		
	102-2925	102-2910	102-2928	102-2910	102-2926	102-2910	102-2926	102-2910	102-2925	102-2910	102-2925	102-2910	102-2926	102-2910	102-2925	102-2910	102-2925	102-2910		
Back Nozzle Positions																				
	Red Plug	Red Plug	Red Plug	Red Plug	Red Plug	Red Plug	Red Plug	Red Plug	Red Plug	Red Plug	Red Plug	Red Plug	Red Plug	Red Plug	Red Plug	Red Plug	Red Plug	Red Plug	Red Plug	
	102-4335	102-4335	102-4335	102-4335	102-4335	102-4335	102-4335	102-4335	102-4335	102-4335	102-4335	102-4335	102-4335	102-4335	102-4335	102-4335	102-4335	102-4335	102-4335	
psi	Radius	gpm	Radius	gpm	Radius	gpm	Radius	gpm	Radius	gpm	Radius	gpm	Radius	gpm	Radius	gpm	Radius	gpm	Radius	gpm
50	52	13.9	62	17.4	66	20.7	69	28.6	—	—	—	—	—	—	—	—	—	—	—	—
65	54	15.7	64	20.8	68	23.4	74	31.2	76	33.8	—	—	—	—	—	—	—	—	—	—
80	57	17.2	68	22.9	72	25.8	77	34.4	79	37.2	85	39.4	89	43.6	92	47.5	96	57.0	96	57.0
100	59	19.1	73	25.5	76	28.7	80	38.2	84	41.3	89	43.7	94	48.5	95	51.1	100	61.1	100	61.1
Stator	102-1939 Yellow								102-1940 White								102-1941			
Conver.	FLX55-6-5154								FLX55-6-5558								FLX55-6-59			

■ Not recommended at these pressures. Radius shown in feet.
 Toro recommends the use of a 1¼" swing joint at flows over 25-gpm (95-LPM). Sprinkler radius data collected in Toro's zero wind test facility per ASAE standard S398.1.
 Actual site conditions must be considered when selecting the appropriate nozzle.
 All sprinklers are equipped with the selectable pilot valve that allows settings at 50, 65, 80 and 100 psi.



Main Nozzle Adapter
 A wide assortment of intermediate and inner nozzles for use in the main nozzle adapter and back nozzle position provide unmatched nozzle flexibility.

Note: Main Nozzle Adapter Data Located on Page 68. Back Nozzle Data Located on Page 73.



The FLEX800 35/55 Series features a dual trajectory main nozzle that provides exceptional nozzle performance at the 25° standard angle position and great performance in windy applications at the 15° low angle position. And the part/full circle drive allows you to adjust the area of coverage to match your seasonal watering needs or meet water rationing mandates in seconds with no additional parts required.

FEATURES & BENEFITS

Industry's Largest Nozzle Selection

Nozzles from 43' to 92' radius plus a wide assortment of back nozzles lets you put the precise amount of water exactly where you need it. All nozzles threaded in from front.

Stainless Steel Valve Seat

Eliminates body damage from rocks and debris. This indestructible stainless steel seat is molded to the body and virtually eliminates body replacements due to seat damage.

Optional Radius Reduction Screw

Allows for fine tuning the radius to exactly the distance you need. In combination with main nozzle sizing and trajectory adjustment the radius reduction screw can effectively reduce the sprinkler throw down to 30'.

True Part and Full-Circle in One (40° - 330° part circle)

These sprinklers can be full circle today and part circle tomorrow allowing you to adjust the area of coverage to match your seasonal needs or meet water rationing mandates.

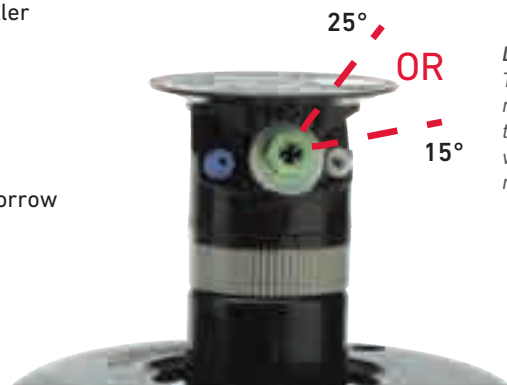

Dual Trajectory
The 25° setting provides maximum distance of throw and the 15° setting provides improved wind performance, radius reduction and obstacle avoidance.

FLX35 CONVERSION UPGRADES

MODELS	DESCRIPTION
• FLX35-3134	FLX35 w/31–34 Nozzles (#3 Nozzle Installed)
• FLX35-3537	FLX35 w/35–37 Nozzles (#5 Nozzle Installed)
• FLX35-3134E	FLX35 w/31–34 Nozzles (#3 Nozzle Installed), Effluent
• FLX35-3537E	FLX35 w/35–37 Nozzles (#5 Nozzle Installed), Effluent



FLX55 CONVERSION UPGRADES — RIBBED BODY

MODELS	DESCRIPTION
• FLX55-5154	FLX55 w/51–54 Nozzles (#3 Nozzle Installed)
• FLX55-5558	FLX55 w/55–58 Nozzles (#5 Nozzle Installed)
• FLX55-59	FLX55 w/59 Nozzle
• FLX55-5154E	FLX55 w/51–54 Nozzles (#3 Nozzle Installed), Effluent
• FLX55-5558E	FLX55 w/55–58 Nozzles (#5 Nozzle Installed), Effluent
• FLX55-59E	FLX55 w/59 Nozzle, Effluent
• 102-5011	690 Adapter allows you to upgrade any 690 with FLX55 conversions
• 102-0950	Required to upgrade all 650, 670, 680, 750, and 780 Series Sprinklers



FLX55 CONVERSION UPGRADES — RIBLESS BODY

MODELS	DESCRIPTION
• FLX55-5154R	FLX55 w/51–54 Nozzles (#3 Nozzle Installed)
• FLX55-5558R	FLX55 w/55–58 Nozzles (#5 Nozzle Installed)
• FLX55-59R	FLX55 w/59 Nozzle
• FLX55-5154RE	FLX55 w/51–54 Nozzles (#3 Nozzle Installed), Effluent
• FLX55-5558RE	FLX55 w/55–58 Nozzles (#5 Nozzle Installed), Effluent
• FLX55-59RE	FLX55 w/59 Nozzle, Effluent



SPECIFICATIONS

Operational

- Inlet:
 - FLX35: 1" ACME
 - FLX55: 1½" ACME
- Radius:
 - FLX35: 43' – 83'
 - FLX55: 55' – 92'
- Flow Rate:
 - FLX35: 8.2 – 47.3 gpm
 - FLX55: 14.1 – 61.3 gpm
- Precipitation Rates:
 - FLX35: Minimum - .41"/hr; Maximum - .45"/hr
 - FLX55: Minimum - .46"/hr; Maximum - .58"/hr
- Pilot Valve: Selectable at 50, 65, 80 and 100 psi
- Recommended Operating Pressure Range: 65-100 psi (maximum – 150 psi and minimum – 40 psi)
- Activation types – Electric Valve-in-Head:
 - Standard Solenoid:
 - 24 VAC, 50/60 Hz
 - Inrush: 0.30 A
 - Holding 0.20 A
 - Spike Guard Solenoid:
 - 24 VAC, 50/60 Hz
 - Inrush: 0.12 A
 - Holding 0.10 A
 - Nickel-Plated Spike Guard Solenoid:
 - 24 VAC, 50/60 Hz
 - Inrush: 0.12 A
 - Holding 0.10 A
 - DC Latching Solenoid (DCLS):
 - Momentary low voltage pulse
 - Integrated Lynx Smart Module with DCLS:
 - Momentary low voltage pulse

Additional Features

- FLX35 has eight nozzle variations (30, 31, 32, 33, 34, 35, 36 & 37)
- FLX55 has nine nozzle variations (51, 52, 53, 54, 55, 56, 57, 58 & 59)
- Three in-line nozzles, rotating stream pattern
- Two back nozzle positions
- Stator variations: 3
- Radius reduction screw 363-4839 for fine tuning
- Ratcheting riser
- Nozzle base clutching

Dimensions

- Body Flange Diameter:
 - FLX35: 6 1/2"
 - FLX55: 7 1/2"
- Body height:
 - FLX35: 10"
 - FLX55: 11 3/8"
- Weight:
 - FLX35: 2.89 lbs.
 - FLX55: 3.57 lbs.
- Weight Integrated Lynx Smart Module
 - FLX35: 3.58 lbs.
 - FLX55: 4.26 lbs.
- Pop-up height to nozzle: 3/4"

Warranty

- Three years
- Five years when installed with Toro Swing Joints



Specifying Information—FLEX800 35 & FLEX800 55

FLXX5-XXX-X-X

Body Inlet	Arc	Nozzle	Pressure Regulation*	Activation Type	Optional
FLXX	5	XX	X	X	X
3–1" 5–1½"	5—Part-circle and Full-circle In One	FLX35 —30, 31, 32, 33, 34, 35, 36, 37 FLX55 —51, 52, 53, 54, 55, 56, 57, 58, 59	6–65 psi 8–80 psi 1–100 psi	1—Standard Solenoid 2—Spike Guard™ Solenoid 3—Nickel-plated Spike Guard Solenoid 4—DC Latching Solenoid (DCLS) 6—Integrated Lynx Smart Module with DCLS	7—Effluent

Example: When specifying an FLX35-6 Series Sprinkler with #34 nozzle, pressure regulation at 65 psi and Spike Guard you would specify: **FLX35-346-2**

































Note: Not all models available.

* All sprinklers are equipped with the selectable pilot valve that allows settings at 50, 65, 80 and 100 psi.



FLEX800™ 35/55 SERIES GOLF ROTORS

FLEX800 35 SERIES PERFORMANCE CHART—25°

Front Nozzle Positions	Nozzle Set 30  (White Plug)		Nozzle Set 31  (Yellow)		Nozzle Set 32  (Blue)		Nozzle Set 33  (Brown)		Nozzle Set 34  (Orange)		Nozzle Set 35  (Green)		Nozzle Set 36  (Gray)		Nozzle Set 37  (Black)	
	102-2208		102-6906		102-0726		102-6907		102-0728		102-6955		102-6935		102-6936	
																
	102-5670	102-6942	102-5670	102-5671	102-5670	102-6884	102-5670	102-6884	102-5670	102-6884	102-5670	102-6885	102-6531	102-6885	102-6531	102-6885
Back Nozzle Positions																
	102-4335	102-4335	102-4335	102-4335	102-4335	102-4335	102-4335	102-4335	102-4335	102-4335	102-4335	102-4335	102-4335	102-4335	102-4335	102-4335
psi	Radius	gpm	Radius	gpm	Radius	gpm	Radius	gpm	Radius	gpm	Radius	gpm	Radius	gpm	Radius	gpm
50	43	8.2	53	13.8	56	18.3	61	21.7	65	25.3	—	—	—	—	—	—
65	45	10.0	53	15.5	59	20.5	64	24.4	68	28.2	72	34.1	—	—	—	—
80	46	11.5	57	17.3	62	22.7	67	27.1	71	31.1	75	37.8	78	40.3	80	44.0
100	47	13.4	59	19.1	65	24.9	70	29.8	74	34.1	79	40.9	81	43.8	83	47.3

FLEX800 35 SERIES PERFORMANCE CHART—15°

psi	Radius	gpm	Radius	gpm	Radius	gpm	Radius	gpm	Radius	gpm	Radius	gpm	Radius	gpm	Radius	gpm
50	43	8.2	52	13.6	58	18.1	61	21.5	62	25.6	—	—	—	—	—	—
65	45	10.0	54	15.3	60	20.3	64	24.2	65	27.3	69	33.1	—	—	—	—
80	46	11.5	58	17.2	64	22.6	69	26.8	69	30.2	75	36.8	76	39.7	76	42.9
100	47	13.4	60	19.0	66	24.7	71	29.5	72	32.9	78	39.5	82	42.6	82	46.1
Stator	102-6929 Blue		102-1939 Yellow						102-1940 White							
Conversions	FLX35-3134						FLX35-3537									

■ Not recommended at these pressures. Radius shown in feet.
 Toro recommends the use of a 1 1/4" swing joint at flows over 25-gpm (95-LPM). Sprinkler radius data collected in Toro's zero wind test facility per ASAE standard S398.1.
 Actual site conditions must be considered when selecting the appropriate nozzle.
 All sprinklers are equipped with the selectable pilot valve that allows settings at 50, 65, 80 and 100 psi.

FLEX800 35 NOZZLE APEX

Pressure	Nozzle	Apex at 15°	Apex at 25°
65 psi	31	6' @ 51'	13' @ 54'
	32	6' @ 51'	11' @ 64'
	33	7' @ 59'	13' @ 68'
	34	8' @ 63'	15' @ 74'
	35	9' @ 66'	15' @ 76'
80 psi	36	8' @ 75'	18' @ 83'
	37	9' @ 74'	19' @ 82'



FLEX800 55 SERIES PERFORMANCE CHART—25°

Front Nozzle Positions	Nozzle Set 51		Nozzle Set 52		Nozzle Set 53		Nozzle Set 54		Nozzle Set 55		Nozzle Set 56		Nozzle Set 57		Nozzle Set 58		Nozzle Set 59	
	(Yellow)		(Blue)		(Brown)		(Orange)		(Green)		(Gray)		(Black)		(Red)		(Beige)	
	102-6906		102-0726		102-6907		102-0728		102-6955		102-6935		102-6936		102-6909		102-4259	
Back Nozzle Positions																		
	Red Plug	Red Plug	Red Plug	Red Plug	Red Plug	Red Plug	Red Plug	Red Plug	Red Plug	Red Plug	Red Plug	Red Plug	Red Plug	Red Plug	Red Plug	Red Plug	Red Plug	Red Plug
	102-4335	102-4335	102-4335	102-4335	102-4335	102-4335	102-4335	102-4335	102-4335	102-4335	102-4335	102-4335	102-4335	102-4335	102-4335	102-4335	102-4335	102-4335
	psi	Radius	gpm	Radius	gpm	Radius	gpm	Radius	gpm	Radius	gpm	Radius	gpm	Radius	gpm	Radius	gpm	Radius
50	55	14.1	57	18.5	62	22.3	66	25.8	—	—	—	—	—	—	—	—	—	—
65	57	15.8	60	20.9	65	25.1	69	28.7	73	35.9	—	—	—	—	—	—	—	—
80	59	17.5	61	23.1	68	27.8	72	31.7	76	39.7	80	43.1	83	48.2	85	50.0	89	57.5
100	61	19.3	63	25.3	71	30.3	75	34.5	80	43.5	83	49.0	88	51.5	90	53.9	92	61.3

FLEX800 55 SERIES PERFORMANCE CHART—15°

psi	Radius	gpm	Radius	gpm	Radius	gpm	Radius	gpm	Radius	gpm	Radius	gpm	Radius	gpm	Radius	gpm	Radius	gpm
50	55	14.0	59	16.5	62	22.2	63	25.6	—	—	—	—	—	—	—	—	—	—
65	56	15.6	62	20.7	65	25.0	66	28.5	75	35.3	—	—	—	—	—	—	—	—
80	59	17.4	66	23.0	69	27.7	70	31.5	78	39.0	78	42.4	79	46.9	79	49.5	82	57.2
100	60	19.2	68	25.1	71	30.2	72	34.3	80	41.9	81	47.2	83	52.1	83	53.4	85	60.8
Stator	102-1939 Yellow						102-1940 White						102-1941 White					
Conversions	FLX55-5154						FLX55-5558						FLX55-59					

■ Not recommended at these pressures. Radius shown in feet.
 Toro recommends the use of a 1 1/4" swing joint at flows over 25-gpm (95-LPM). Sprinkler radius data collected in Toro's zero wind test facility per ASAE standard S398.1.
 Actual site conditions must be considered when selecting the appropriate nozzle.
 All sprinklers are equipped with the selectable pilot valve that allows settings at 50, 65, 80 and 100 psi.

FLEX800 55 NOZZLE APEX

Pressure	Nozzle	Apex at 15°	Apex at 25°
65 psi	51	6' @ 51'	13' @ 54'
	52	6' @ 51'	11' @ 64'
	53	7' @ 59'	13' @ 68'
	54	8' @ 63'	15' @ 74'
	55	9' @ 66'	15' @ 76'
80 psi	56	8' @ 75'	18' @ 83'
	57	9' @ 74'	19' @ 82'
	58	10' @ 82'	18' @ 87'
	59	11' @ 81'	21' @ 91'

Note: Main Nozzle Adapter Data Located on Page 68. Back Nozzle Data Located on Page 73.



The FLEX800 34/54 Series with dual trajectory main nozzle provides exceptional nozzle performance at the 25° standard angle position and great performance in windy applications at the 15° low angle position. And the consistency of the constant velocity full circle drive ensures even water application across the coverage area every time you water.

FEATURES & BENEFITS

Industry's Largest Nozzle Selection

Nozzles from 52' to 99' radius plus a wide assortment of back nozzles lets you put the precise amount of water exactly where you need it. All nozzles threaded in from front.

Stainless Steel Valve Seat

Eliminates body damage from rocks and debris. This indestructible stainless steel seat is molded to the body and virtually eliminates body replacements due to seat damage.

Optional Radius Reduction Screw

Allows for fine tuning the radius to exactly the distance you need. In combination with main nozzle sizing and trajectory adjustment the radius reduction screw can effectively reduce the sprinkler throw down to 30'.

Constant Velocity Full Circle Drive

Ensures consistent rotation speeds when matched with station run times for even water application across the coverage area every time you water.



Dual Trajectory
The 25° setting provides maximum distance of throw and the 15° setting provides improved wind performance, radius reduction and obstacle avoidance.

FLX34 CONVERSION UPGRADES

MODELS	DESCRIPTION
• FLX34-3134	FLX34 w/31-34 Nozzles (#3 Nozzle Installed)
• FLX34-3537	FLX34 w/35-37 Nozzles (#5 Nozzle Installed)
• FLX34-3134E	FLX34 w/31-34 Nozzles (#3 Nozzle Installed), Effluent
• FLX34-3537E	FLX34 w/35-37 Nozzles (#5 Nozzle Installed), Effluent



FLX54 CONVERSION UPGRADES

MODELS	DESCRIPTION
• FLX54-5154	FLX54 w/51-54 Nozzles (#3 Nozzle Installed)
• FLX54-5558	FLX54 w/55-58 Nozzles (#5 Nozzle Installed)
• FLX54-59	FLX54 w/59 Nozzle
• FLX54-5154E	FLX54 w/51-54 Nozzles (#3 Nozzle Installed), Effluent
• FLX54-5558E	FLX54 w/55-58 Nozzles (#5 Nozzle Installed), Effluent
• FLX54-59E	FLX55 w/59 Nozzle, Effluent
• 102-5011	690 Adapter allows you to upgrade any 690 with FLX54 conversions
• 102-0950	Required to upgrade all 1.5" Series Sprinklers (650, 670, 680, 750, and 780)



SPECIFICATIONS

Operational

- Inlet:
 - FLX34: 1" ACME
 - FLX54: 1½" ACME
- Radius:
 - FLX34: 52' - 91'
 - FLX54: 52' - 99'
- Flow Rate:
 - FLX34: 13.0 - 46.9 gpm
 - FLX54: 13.2 - 61.8 gpm
- Precipitation Rates:
 - FLX34: Minimum - .33"/hr; Maximum - .55"/hr
 - FLX54: Minimum - .33"/hr; Maximum - .61"/hr
- Pilot Valve: Selectable at 50, 65, 80 and 100 psi
- Recommended Operating Pressure Range: 65-100 psi (maximum-150 psi and minimum-40 psi)
- Activation types - Electric Valve-in-Head:
 - Standard Solenoid:
 - 24 VAC, 50/60 Hz
 - Inrush: 0.30 A
 - Holding 0.20 A
 - Spike Guard Solenoid:
 - 24 VAC, 50/60 Hz
 - Inrush: 0.12 A
 - Holding 0.10 A
 - Nickel-Plated Spike Guard Solenoid:
 - 24 VAC, 50/60 Hz
 - Inrush: 0.12 A
 - Holding 0.10 A
 - DC Latching Solenoid (DCLS):
 - Momentary low voltage pulse
 - Integrated Lynx Smart Module w/DCLS:
 - Momentary low voltage pulse
- Trajectory: 25° or 15°

Dimensions

- Body Flange Diameter:
 - FLX34: 6½"
 - FLX54: 7½"
- Body height:
 - FLX34: 10"
 - FLX54: 11 ¾"
- Weight:
 - FLX34: 2.87 lbs.
 - FLX54: 3.55 lbs.
- Weight Integrated Lynx Smart Module
 - FLX34: 3.56 lbs.
 - FLX54: 4.24 lbs.
- Pop-up height to nozzle: 3¼"

Warranty

- Three years
- Five years when installed with Toro Swing Joints

Specifying Information—FLEX800 34 & FLEX800 54

FLXX4-XXX-X-X					
Body Inlet	Arc	Nozzle	Pressure Regulation*	Activation Type	Optional
FLXX	4	XX	X	X	X
3-1" 5-1½"	4-Full-circle	FLX34-30, 31, 32, 33, 34, 35, 36, 37 FLX54-51, 52, 53, 54, 55, 56, 57, 58, 59	6-65 psi 8-80 psi 1-100 psi	1-Standard Solenoid 2-Spike Guard™ Solenoid 3-Nickel-plated Spike Guard Solenoid 4-DC Latching Solenoid (DCLS) 6-Integrated Lynx Smart Module with DCLS	7-Effluent

Example: When specifying an FLX34 Series Sprinkler with #34 nozzle, pressure regulation at 65 psi and Spike Guard you would specify: **FLX34-346-2**

Note: Not all models available.

* All sprinklers are equipped with the selectable pilot valve that allows settings at 50, 65, 80 and 100 psi.



FLEX800™ 34/54 SERIES GOLF ROTORS

FLEX800 34 SERIES PERFORMANCE CHART—25°

Front Nozzle Positions	Nozzle Set 31 (Yellow)		Nozzle Set 32 (Blue)		Nozzle Set 33 (Brown)		Nozzle Set 34 (Orange)		Nozzle Set 35 (Green)		Nozzle Set 36 (Gray)		Nozzle Set 37 (Black)	
	102-0725		102-7001		102-0727		102-7002		102-6908		102-0730		102-4261	
	Red Plug 102-4335	Red Plug 102-4335	Red Plug 102-4335	Red Plug 102-4335	Red Plug 102-4335	Red Plug 102-4335	Red Plug 102-4335	Red Plug 102-4335	Red Plug 102-4335	Red Plug 102-4335	Red Plug 102-4335	Red Plug 102-4335	Red Plug 102-4335	Red Plug 102-4335
Back Nozzle Positions														
	Yellow 102-6937	Blue 102-2925	Yellow 102-6937	Orange 102-2926	Yellow 102-6937	Red 102-2928	Yellow 102-6937	Beige 102-2929	Yellow 102-6937	Beige 102-2929	Yellow 102-6937	Red 102-6944	Yellow 102-6937	Gray 102-6945
	psi	Radius	gpm	Radius	gpm	Radius	gpm	Radius	gpm	Radius	gpm	Radius	gpm	Radius
50	57	13.0	58	15.5	64	21.9	68	24.4	—	—	—	—	—	—
65	58	14.6	60	18.0	68	24.4	72	28.1	76	32.2	—	—	—	—
80	60	16.2	63	20.5	72	26.9	76	31.1	80	35.6	83	38.2	85	41.5
100	62	17.9	66	23.4	75	29.8	79	34.9	84	39.3	88	43.4	91	46.9

FLEX800 34 SERIES PERFORMANCE CHART—15°

psi	Radius	gpm	Radius	gpm	Radius	gpm	Radius	gpm	Radius	gpm	Radius	gpm	Radius	gpm
50	52	12.9	53	15.6	60	21.7	62	25.5	—	—	—	—	—	—
65	53	14.4	54	17.1	61	24.2	64	28.0	67	32.1	—	—	—	—
80	56	16.0	57	19.0	65	26.6	69	31.0	73	35.5	76	38.0	77	41.3
100	57	17.5	59	20.5	67	29.5	71	33.9	75	38.4	80	43.1	81	46.8
Stator	102-6929 Blue								102-1940 White					
Conversions	FLX34-3134								FLX34-3537					

■ Not recommended at these pressures. Radius shown in feet.
 Toro recommends the use of a 1¼" swing joint at flows over 25-gpm (95-LPM).
 Sprinkler radius data collected in Toro's zero wind test facility per ASAE standard S398.1.
 Actual site conditions must be considered when selecting the appropriate nozzle.
 All sprinklers are equipped with the selectable pilot valve that allows settings at 50, 65, 80 and 100 psi.

FLEX800 34 NOZZLE APEX

Pressure	Nozzle	Apex at 15°	Apex at 25°
65 psi	31	6' @ 51'	13' @ 54'
	32	6' @ 51'	11' @ 64'
	33	7' @ 59'	13' @ 68'
	34	8' @ 63'	15' @ 74'
	35	9' @ 66'	15' @ 76'
80 psi	36	8' @ 75'	18' @ 83'
	37	9' @ 74'	19' @ 82'

FLEX800™ 34/54 SERIES GOLF ROTORS



FLEX800 54 SERIES PERFORMANCE CHART—25°

Front Nozzle Positions	Nozzle Set 51 (Yellow)		Nozzle Set 52 (Blue)		Nozzle Set 53 (Brown)		Nozzle Set 54 (Orange)		Nozzle Set 55 (Green)		Nozzle Set 56 (Gray)		Nozzle Set 57 (Black)		Nozzle Set 58 (Red)		Nozzle Set 59 (Beige)			
	102-0725		102-7001		102-0727		102-7002		102-6908		102-0730		102-4261		102-4260		102-4259			
	Red Plug	Red Plug	Red Plug	Red Plug	Red Plug	Red Plug	Red Plug	Red Plug	Red Plug	Red Plug	Red Plug	Red Plug	Red Plug	Red Plug	Brown	Red Plug	Brown	Red Plug	Red Plug	Red Plug
	102-4335	102-4335	102-4335	102-4335	102-4335	102-4335	102-4335	102-4335	102-4335	102-4335	102-4335	102-4335	102-4335	102-4335	102-6883	102-4335	102-6883	102-4335	102-4335	102-4335
Back Nozzle Positions	Yellow	Blue	Yellow	Orange	Yellow	Red	Yellow	Beige	Yellow	Beige	Yellow	Red	Yellow	Gray	Yellow	Gray	Yellow	Gray	Yellow	Gray
	102-6937	102-2925	102-6937	102-2926	102-6937	102-2928	102-6937	102-2929	102-6937	102-2929	102-6937	102-6944	102-6937	102-6945	102-6937	102-6945	102-6937	102-6945	102-6937	102-6945
psi	Radius	gpm	Radius	gpm	Radius	gpm	Radius	gpm	Radius	gpm	Radius	gpm	Radius	gpm	Radius	gpm	Radius	gpm	Radius	gpm
50	58	13.2	59	15.7	64	22.0	70	26.2	—	—	—	—	—	—	—	—	—	—	—	—
65	60	14.8	61	17.5	68	24.8	74	29.3	79	34.2	—	—	—	—	—	—	—	—	—	—
80	61	16.4	64	20.0	72	27.6	78	32.6	83	38.0	85	40.7	87	44.9	91	50.2	96	55.6	99	61.8
100	63	18.1	67	23.6	75	30.4	81	36.7	87	42.5	90	45.8	93	50.2	95	55.4	99	61.8	—	—

FLEX800 54 SERIES PERFORMANCE CHART—15°

psi	Radius	gpm	Radius	gpm	Radius	gpm	Radius	gpm	Radius	gpm	Radius	gpm	Radius	gpm	Radius	gpm	Radius	gpm	Radius	gpm		
50	52	13.2	53	15.8	61	22.0	65	26.0	—	—	—	—	—	—	—	—	—	—	—	—		
65	53	14.8	54	17.4	63	24.8	67	29.2	69	34.1	—	—	—	—	—	—	—	—	—	—		
80	56	16.4	58	19.4	68	27.6	72	32.5	75	37.8	79	40.4	81	44.6	85	49.9	87	55.3	87	55.3	87	55.3
100	58	18.1	60	21.1	71	30.4	75	36.4	79	42.3	84	45.5	87	49.9	89	55.1	94	61.5	94	61.5	94	61.5
Stator	102-6929 Blue								102-1940 White								102-1941 White					
Conversions	FLX54-5154								FLX54-5558								FLX54-59					

■ Not recommended at these pressures. Radius shown in feet.
 Toro recommends the use of a 1¼" swing joint at flows over 25-gpm (95-LPM).
 Sprinkler radius data collected in Toro's zero wind test facility per ASAE standard S398.1.
 Actual site conditions must be considered when selecting the appropriate nozzle.
 All sprinklers are equipped with the selectable pilot valve that allows settings at 50, 65, 80 and 100 psi.

FLEX800 54 NOZZLE APEX

Pressure	Nozzle	Apex at 15°	Apex at 25°
65 psi	51	6' @ 51'	13' @ 54'
	52	6' @ 51'	11' @ 64'
	53	7' @ 59'	13' @ 68'
	54	8' @ 63'	15' @ 74'
	55	9' @ 66'	15' @ 76'
80 psi	56	8' @ 75'	18' @ 83'
	57	9' @ 74'	19' @ 82'
	58	10' @ 82'	18' @ 87'
	59	11' @ 81'	21' @ 91'



Main Nozzle Adapter
 A wide assortment of intermediate and inner nozzles for use in the main nozzle adapter and back nozzle position provide unmatched nozzle flexibility.

Note: Main Nozzle Adapter Data Located on Page 68. Back Nozzle Data Located on Page 73.



The FLEX800™ B Series golf sprinkler family brings you all the great features and performance of the FLEX800 35-6, 34 and 35 Series sprinklers in a more economical body package specifically designed for block systems. With its rugged golf body design, small exposed surface diameter, flanged body for stability and check valve these sprinklers are perfect for every golf application.

FEATURES & BENEFITS

Industry's Largest Nozzle Selection

Nozzles from 25' to 95' radius, plus a wide assortment of intermediate and inner nozzles, provide unmatched flexibility allowing you to put the precise amount of water exactly where you need it. All nozzles are color-coded, debris tolerant, and thread in from front.

True Part and Full-Circle in One (40° - 330° part circle)

These sprinklers can be full circle or part circle allowing you to adjust the area of coverage to match your seasonal needs or meet water rationing mandates.

Flanged Cap Installs Below Grade

Stabilizes the body position and maintains optimum nozzle performance.

Small Exposed Diameter

Minimizes the appearance of the sprinkler to maximize the beauty of the course. Perfect for high traffic areas like tees, greens and surrounds.





FLX35-6B

FLX34B and FLX35B

Nozzle Trajectory Provides Unmatched Performance
 FLX35-6B with TruJectory™ adjustment from 7°-30° in 1° increments and FLX35/FLX34 models with dual trajectory settings of 25° or 15° provide improved wind performance, obstacle avoidance and radius adjustment.



Main Nozzle Adapter
 A wide assortment of intermediate and inner nozzles for use in the main nozzle adapter and back nozzle position provide unmatched nozzle flexibility.



SPECIFICATIONS

Operational

- Inlet: 1" NPT, BSP or ACME
- Radius:
 - FLX35-6B: 42' – 95'
 - FLX35B: 43' – 90'
 - FLX34B: 57' – 95'
- Flow Rate:
 - FLX35-6B : 7.1 – 52.5 gpm
 - FLX35B: 8.2 – 56.3 gpm
 - FLX34B : 13.0 – 55.4 gpm
- Precipitation Rates:
 - FLX35-6B : Minimum – .34"/hr; Maximum – .56"/hr
 - FLX35B: Minimum – .37"/hr; Maximum – .67"/hr
 - FLX34B : Minimum – .33"/hr; Maximum – .59"/hr
- Recommended Operating Pressure Range: 50-100 psi (maximum – 150 psi and minimum – 40 psi)
- Check-O-Matic models maintain up to 5' elevation change

Nozzle Selection

- Nozzle variations
 - FLX35-6B - Nine variations (30, 31, 32, 33, 34, 35, 36, 37 & 38)
 - FLX34B - Nine variations (30, 31, 32, 33, 34, 35, 36, 37 & 38)
 - FLX54B - Eight variations (31, 32, 33, 34, 35, 36, 37 & 38)
- Back nozzle capability on part circle models standard
 - FLX35-6B – one position available
 - FLX35B – two positions available
 - FLX34B – two additional front nozzle positions
- Main-less capability for short radius applications
- Stator variations - 2
- Radius reduction screw for fine tuning the radius (363-4839).
 Optional on: FLX35B, FLX34B and not available on FLX35-6B models
- Ratcheting riser – Part circle models
- Nozzle base clutching – Part circle models

Dimensions

- Body diameter: 6"
- Body height: 8.5"
- Weight:
 - FLX34B – 1.98 lbs.
 - FLX35B – 2.00 lbs.
 - FLX35-6B – 2.05 lbs.
- Pop-up height to nozzle: 3/4"

Warranty

- Three years
- Five years when installed with Toro Swing Joints

Specifying Information—FLEX800 B Series





























FLX3XB-X2-XXXXX						
Series	Arc	System	Thread Type	Valve Type	Nozzle	Optional
FLX3	X	B	X	2	XXXX	X
FLX3 – FLEX800 B Series	4—Full-Circle 5—Part-/Full-Circle 5-6—Part-/Full-Circle with TruJectory	B —Block	0—NPT 4—ACME 5—BSP	Check-O-Matic	3134— Includes nozzles #31, 32, 33 & 34 3538— Includes nozzles #35, 36, 37 & 38	E—Effluent Model

Example: When specifying a FLEX800 B Series Sprinkler with full circle – NPT threads #34 nozzles, you would specify: **FLX34B-02-3134**



FLEX800™ 35-6B/34B/35B SERIES GOLF ROTORS

FLEX800 35-6B SERIES PERFORMANCE CHART—25°

Base Pressure	Nozzle Set 30		Nozzle Set 31		Nozzle Set 32		Nozzle Set 33		Nozzle Set 34		Nozzle Set 35		Nozzle Set 36		Nozzle Set 37		Nozzle Set 38	
	 (White) 102-2208		 (Yellow) 102-4587		 (Blue) 102-4588		 (Brown) 102-4589		 (Orange) 102-0728		 (Green) 102-0729		 (Gray) 102-0730		 (Black) 102-4261		 (Red) 102-6909	
																		
102-2925	102-2910	102-2925	102-2910	102-2928	102-2910	102-2926	102-2910	102-2926	102-2910	102-2925	102-2910	102-2925	102-2910	102-2926	102-2910	102-2925	102-2910	
 Back Nozzle 102-4335 Red Plug																		
psi	Radius	gpm	Radius	gpm	Radius	gpm	Radius	gpm	Radius	gpm	Radius	gpm	Radius	gpm	Radius	gpm	Radius	gpm
50	42	7.1	52	14.0	58	18.0	—	—	—	—	—	—	—	—	—	—	—	—
60	43	7.9	54	15.2	60	19.5	66	21.9	—	—	—	—	—	—	—	—	—	—
70	45	8.8	55	16.4	63	21.0	68	23.6	74	32.7	77	35.2	—	—	—	—	—	—
80	46	9.6	57	17.4	65	22.6	70	25.3	77	35.1	79	37.7	84	39.6	86	43.4	90	47.5
90	47	10.4	58	18.5	68	23.9	72	26.8	79	37.0	82	9.9	86	41.9	88	45.9	93	50.0
100	48	11.2	59	19.4	70	25.2	74	28.2	80	38.9	84	41.8	88	44.1	90	48.4	95	52.5
Stator	102-6929 Blue				102-1939 Yellow								102-1940 White					
Conversions					INF35-6-3134								INF35-6-3537					



FLEX800 B Series with mainless short radius nozzle configuration.

FLEX800™ 35-6B/34B/35B SERIES GOLF ROTORS



FLEX800 35B SERIES PERFORMANCE CHART—25°

Front Nozzle Positions	Nozzle Set 30		Nozzle Set 31		Nozzle Set 32		Nozzle Set 33		Nozzle Set 34		Nozzle Set 35		Nozzle Set 36		Nozzle Set 37		Nozzle Set 38	
	(White Plug) 102-2208		(Yellow) 102-6906		(Blue) 102-0726		(Brown) 102-6907		(Orange) 102-0728		(Green) 102-6955		(Gray) 102-6935		(Black) 102-6936		(Red) 102-6909	
102-5670	102-6942	102-5670	102-5671	102-5670	102-6884	102-5670	102-6884	102-5670	102-6884	102-5670	102-6885	102-6531	102-6885	102-6531	102-6885	102-6531	102-6885	
Back Nozzles 102-4335 Red Plug																		
psi	Radius	gpm	Radius	gpm	Radius	gpm	Radius	gpm	Radius	gpm	Radius	gpm	Radius	gpm	Radius	gpm	Radius	gpm
50	43	8.2	55	13.6	56	18.3	—	—	—	—	—	—	—	—	—	—	—	—
60	44	9.3	56	15.0	58	20.1	63	24.2	—	—	—	—	—	—	—	—	—	—
70	45	10.4	58	16.2	60	21.8	65	26.3	69	30.0	73	37.0	—	—	—	—	—	—
80	46	11.5	59	17.3	62	23.3	67	28.0	71	32.1	75	39.6	78	42.9	80	48.6	85	50.6
90	47	12.5	60	18.4	64	24.7	69	29.8	73	34.2	77	42.0	80	45.4	82	51.5	88	53.6
100	47	13.4	61	19.3	65	26.0	70	31.4	74	35.9	79	44.2	81	48.8	83	54.2	90	56.3
Stator	102-6929 Blue				102-1939 Yellow								102-1940 White					
Conversions					FLX35-3134								FLX35-3537					

FLEX800 34B SERIES PERFORMANCE CHART—25°

Front Nozzle Positions	Nozzle Set 31		Nozzle Set 32		Nozzle Set 33		Nozzle Set 34		Nozzle Set 35		Nozzle Set 36		Nozzle Set 37		Nozzle Set 38			
	(Yellow) 102-0725		(Blue) 102-7001		(Brown) 102-0727		(Orange) 102-7002		(Green) 102-6908		(Gray) 102-0730		(Black) 102-4261		(Red) 102-4260			
	Front Nozzles 102-4335 Red Plug																	
														102-4335	102-6883	102-4335	102-6883	
Back Nozzle Positions																		
	102-6937	102-2925	102-6937	102-2926	102-6937	102-2928	102-6937	102-2929	102-6937	102-2929	102-6937	102-2929	102-6937	102-6944	102-6937	102-6945	102-6937	102-6945
	Yellow	Blue	Yellow	Orange	Yellow	Red	Yellow	Beige	Yellow	Beige	Yellow	Red	Yellow	Gray	Yellow	Gray		
psi	Radius	gpm	Radius	gpm	Radius	gpm	Radius	gpm	Radius	gpm	Radius	gpm	Radius	gpm	Radius	gpm	Radius	gpm
50	57	13.0	58	15.5	—	—	—	—	—	—	—	—	—	—	—	—	—	—
60	58	14.1	60	17.2	67	23.6	—	—	—	—	—	—	—	—	—	—	—	—
70	59	15.5	61	18.2	69	26.2	73	30.0	78	35.7	—	—	—	—	—	—	—	—
80	60	16.2	63	20.5	72	27.9	76	32.1	80	38.2	83	40.9	85	42.1	91	50.2	—	—
90	61	17.5	65	22.0	74	29.7	78	34.1	82	40.5	86	43.4	88	44.5	93	52.8	—	—
100	62	18.8	66	23.4	75	31.4	79	36.0	84	42.7	88	45.8	91	46.9	95	55.4	—	—
Stator	102-6929 Blue								102-1940 White									
Conversions	FLX34-3134								FLX34-3537									

Not recommended at these pressures. Radius shown in feet.
Toro recommends the use of a 1¼" swing joint at flows over 25-gpm (95-LPM). Sprinkler radius data collected in Toro's zero wind test facility per ASAE standard S398.1.

Note: Main Nozzle Adapter Data Located on Page 68. Back Nozzle Data Located on Page 73.



MAIN NOZZLE ADAPTER

Performance Charts

INTERMEDIATE NOZZLE PERFORMANCE CHARTS

102-2929 Beige		Trajectory		30°		25°		20°		15°		10°		7°	
Pressure		Flow		Radius		Radius		Radius		Radius		Radius		Radius	
psi	BAR	gpm	lpm	Feet	Meters	Feet	Meters	Feet	Meters	Feet	Meters	Feet	Meters	Feet	Meters
50	3.4	8.1	30.7	53	17.4	52	17.1	50	16.4	48	15.7	45	14.8	42	13.8
60	4.1	8.9	33.7	57	18.7	56	18.4	53	17.4	51	16.7	47	15.4	45	14.8
65	4.5	9.3	35.2	58	19.0	56	18.4	54	17.7	51	16.7	49	16.1	46	15.1
70	4.8	9.6	36.3	59	19.4	57	18.7	56	18.4	53	17.4	50	16.4	48	15.7
80	5.5	10.3	39.0	61	20.0	60	19.7	58	19.0	56	18.4	53	17.4	50	16.4
90	6.2	10.9	41.3	63	20.7	61	20.0	59	19.4	57	18.7	54	17.7	51	16.7
100	6.9	11.5	43.5	65	21.3	63	20.7	60	19.7	58	19.0	55	18.0	51	16.7

102-2928 Red		Trajectory		30°		25°		20°		15°		10°		7°	
Pressure		Flow		Radius		Radius		Radius		Radius		Radius		Radius	
psi	BAR	gpm	lpm	Feet	Meters	Feet	Meters	Feet	Meters	Feet	Meters	Feet	Meters	Feet	Meters
50	3.4	6.3	23.8	53	17.4	51	16.7	48	15.7	46	15.1	43	14.1	40	13.1
60	4.1	7.0	26.5	55	18.0	53	17.4	50	16.4	48	15.7	45	14.8	42	13.8
65	4.5	7.2	27.3	56	18.4	54	17.7	52	17.1	49	16.1	47	15.4	44	14.4
70	4.8	7.5	28.4	57	18.7	55	18.0	53	17.4	51	16.7	49	16.1	46	15.1
80	5.5	8.0	30.3	59	19.4	58	19.0	56	18.4	54	17.7	52	17.1	49	16.1
90	6.2	8.5	32.2	60	19.7	58	19.0	57	18.7	55	18.0	53	17.4	50	16.4
100	6.9	9.0	34.1	61	20.0	59	19.4	57	18.7	55	18.0	53	17.4	50	16.4

102-2927 Gray		Trajectory		30°		25°		20°		15°		10°		7°	
Pressure		Flow		Radius		Radius		Radius		Radius		Radius		Radius	
psi	BAR	gpm	lpm	Feet	Meters	Feet	Meters	Feet	Meters	Feet	Meters	Feet	Meters	Feet	Meters
50	3.4	5.0	18.9	50	16.4	48	15.7	46	15.1	44	14.4	41	13.5	38	12.5
60	4.1	5.5	20.8	52	17.1	50	16.4	48	15.7	46	15.1	43	14.1	40	13.1
65	4.5	5.7	21.6	53	17.4	51	16.7	49	16.1	46	15.1	44	14.4	41	13.5
70	4.8	5.9	22.3	53	17.4	51	16.7	49	16.1	47	15.4	45	14.8	42	13.8
80	5.5	6.3	23.8	54	17.7	52	17.1	50	16.4	48	15.7	46	15.1	43	14.1
90	6.2	6.7	25.4	55	18.0	53	17.4	52	17.1	50	16.4	48	15.7	45	14.8
100	6.9	7.1	26.9	55	18.0	54	17.7	53	17.4	52	17.1	50	16.4	46	15.1

102-2926 Orange		Trajectory		30°		25°		20°		15°		10°		7°	
Pressure		Flow		Radius		Radius		Radius		Radius		Radius		Radius	
psi	BAR	gpm	lpm	Feet	Meters	Feet	Meters	Feet	Meters	Feet	Meters	Feet	Meters	Feet	Meters
50	3.4	4.3	16.3	48	15.7	46	15.1	44	14.4	42	13.8	39	12.8	35	11.5
60	4.1	4.7	17.8	50	16.4	48	15.7	46	15.1	44	14.4	41	13.5	38	12.5
65	4.5	4.9	18.5	51	16.7	49	16.1	47	15.4	45	14.8	42	13.8	39	12.8
70	4.8	5.1	19.3	51	16.7	50	16.4	48	15.7	46	15.1	43	14.1	40	13.1
80	5.5	5.4	20.4	52	17.1	51	16.7	50	16.4	48	15.7	45	14.8	42	13.8
90	6.2	5.8	22.0	53	17.4	52	17.1	51	16.7	49	16.1	47	15.4	44	14.4
100	6.9	6.1	23.1	54	17.7	53	17.4	52	17.1	50	16.4	48	15.7	45	14.8

102-2925 Blue		Trajectory		30°		25°		20°		15°		10°		7°	
Pressure		Flow		Radius		Radius		Radius		Radius		Radius		Radius	
psi	BAR	gpm	lpm	Feet	Meters	Feet	Meters	Feet	Meters	Feet	Meters	Feet	Meters	Feet	Meters
50	3.4	2.7	10.2	42	13.8	41	13.5	39	12.8	38	12.5	36	11.8	34	11.2
60	4.1	3.0	11.4	43	14.1	42	13.8	40	13.1	39	12.8	37	12.1	35	11.5
65	4.5	3.2	12.1	43	14.1	42	13.8	40	13.1	39	12.8	37	12.1	35	11.5
70	4.8	3.3	12.5	44	14.4	42	13.8	41	13.5	39	12.8	38	12.5	36	11.8
80	5.5	3.5	13.2	44	14.4	43	14.1	41	13.5	40	13.1	38	12.5	36	11.8
90	6.2	3.7	14.0	45	14.8	44	14.4	42	13.8	41	13.5	39	12.8	37	12.1
100	6.9	3.9	14.8	45	14.8	44	14.4	43	14.1	42	13.8	40	13.1	38	12.5



Performance Charts

INTERMEDIATE NOZZLE PERFORMANCE CHARTS

102-6885 Green		Trajectory		30°		25°		20°		15°		10°		7°	
Pressure		Flow		Radius		Radius		Radius		Radius		Radius		Radius	
psi	BAR	gpm	lpm	Feet	Meters	Feet	Meters	Feet	Meters	Feet	Meters	Feet	Meters	Feet	Meters
50	3.4	5.4	20.4	51	16.7	50	16.4	48	15.7	45	14.8	42	13.8	39	12.8
60	4.1	5.9	22.3	52	17.1	51	16.7	49	16.1	46	15.1	43	14.1	41	13.5
65	4.5	6.1	23.1	52	17.1	51	16.7	50	16.4	47	15.4	44	14.4	42	13.8
70	4.8	6.3	23.8	53	17.4	52	17.1	50	16.4	47	15.4	44	14.4	42	13.8
80	5.5	6.7	25.4	53	17.4	52	17.1	51	16.7	48	15.7	45	14.8	43	14.1
90	6.2	7.1	26.9	54	17.7	53	17.4	52	17.1	50	16.4	47	15.4	45	14.8
100	6.9	7.4	28.0	55	18.0	55	18.0	54	17.7	52	17.1	49	16.1	47	15.4

102-6884 Yellow		Trajectory		30°		25°		20°		15°		10°		7°	
Pressure		Flow		Radius		Radius		Radius		Radius		Radius		Radius	
psi	BAR	gpm	lpm	Feet	Meters	Feet	Meters	Feet	Meters	Feet	Meters	Feet	Meters	Feet	Meters
50	3.4	4.1	15.5	48	15.7	47	15.4	45	14.8	41	13.5	38	12.5	35	11.5
60	4.1	4.5	17.0	49	16.1	48	15.7	47	15.4	44	14.4	41	13.5	38	12.5
65	4.5	4.7	17.8	50	16.4	49	16.1	48	15.7	45	14.8	42	13.8	39	12.8
70	4.8	4.8	18.2	50	16.4	49	16.1	48	15.7	45	14.8	43	14.1	40	13.1
80	5.5	5.1	19.3	51	16.7	50	16.4	49	16.1	47	15.4	44	14.4	41	13.5
90	6.2	5.4	20.4	53	17.4	52	17.1	50	16.4	48	15.7	45	14.8	42	13.8
100	6.9	5.8	22.0	54	17.7	53	17.4	51	16.7	49	16.1	46	15.1	43	14.1

102-6883 Brown		Trajectory		30°		25°		20°		15°		10°		7°	
Pressure		Flow		Radius		Radius		Radius		Radius		Radius		Radius	
psi	BAR	gpm	lpm	Feet	Meters	Feet	Meters	Feet	Meters	Feet	Meters	Feet	Meters	Feet	Meters
50	3.4	2.4	9.1	41	13.5	40	13.1	38	12.5	36	11.8	33	10.8	30	9.8
60	4.1	2.6	9.8	43	14.1	42	13.8	40	13.1	38	12.5	36	11.8	33	10.8
65	4.5	2.7	10.2	44	14.4	42	13.8	41	13.5	39	12.8	37	12.1	34	11.2
70	4.8	2.8	10.6	45	14.8	43	14.1	42	13.8	40	13.1	38	12.5	35	11.5
80	5.5	3.0	11.4	46	15.1	45	14.8	43	14.1	41	13.5	40	13.1	36	11.8
90	6.2	3.2	12.1	46	15.1	45	14.8	44	14.4	42	13.8	41	13.5	37	12.1
100	6.9	3.4	12.9	46	15.1	45	14.8	44	14.4	43	14.1	41	13.5	38	12.5

INNER NOZZLE PERFORMANCE CHARTS*

102-6937 Yellow		Trajectory		30°		25°		20°	
Pressure		Flow		Radius		Radius		Radius	
psi	BAR	gpm	lpm	Feet	Meters	Feet	Meters	Feet	Meters
50	3.4	3.7	14.0	26	8.5	24	7.9	20	6.6
60	4.1	4.0	15.1	28	9.2	25	8.2	22	7.2
65	4.5	4.2	15.9	28	9.2	25	8.2	22	7.2
70	4.8	4.4	16.7	28	9.2	26	8.5	23	7.5
80	5.5	4.7	17.8	28	9.2	26	8.5	24	7.9
90	6.2	5.0	18.9	29	9.5	27	8.9	25	8.2
100	6.9	5.2	19.7	30	9.8	29	9.5	27	8.9

102-6531 Green		Trajectory		30°		25°		20°	
Pressure		Flow		Radius		Radius		Radius	
psi	BAR	gpm	lpm	Feet	Meters	Feet	Meters	Feet	Meters
50	3.4	4.0	15.1	32	10.5	30	9.8	26	8.5
60	4.1	4.3	16.3	34	11.2	31	10.2	27	8.9
65	4.5	4.5	17.0	34	11.2	31	10.2	27	8.9
70	4.8	4.7	17.8	34	11.2	31	10.2	28	9.2
80	5.5	5.0	18.9	34	11.2	32	10.5	29	9.5
90	6.2	5.3	20.1	34	11.2	32	10.5	29	9.5
100	6.9	5.6	21.2	35	11.5	33	10.8	30	9.8



* Not recommended below 20°



The Toro FLEX800™ R Series Conversion Upgrades enable customers with existing Rain Bird® Eagle™ 900 and 1100* Series sprinklers to upgrade to Toro's industry leading sprinkler technology. The benefits of upgrading include the patented TruJectory™ adjustment, full and part circle in the same sprinkler, the ability to ratchet the riser and clutch the nozzle base, and an extra 1½" pop-up height.

FEATURES & BENEFITS

Industry's Largest Nozzle Selection

Nozzles from 42' to 100' radius plus a wide assortment of back nozzles lets you put the precise amount of water exactly where you need it.

20,000 Volt Lightning Rating

Spike Guard™ solenoid virtually eliminates the need for replacements in high lightning areas. Draws half the amperage of traditional solenoids so you can run twice as many sprinklers simultaneously, reduce the cost of wire during installation or increase the distance from controller to sprinkler.

Dual TruJectory

The 25° setting provides maximum distance of throw and the 15° setting provides improved wind performance, radius reduction and obstacle avoidance (FLX54RB and FLX55RB).

True Full-Circle in One (40° - 330° part circle)

These sprinklers can be full circle today and part circle tomorrow allowing you to simply and economically adjust the area of coverage to match your seasonal needs or meet water rationing mandates (FLX55-6RB and FLX55RB).

*Rain Bird is a registered trademark of Rain Bird Corporation. Eagle is a trademark of Rain Bird Corporation.



FLX55-6RB

FLX55RB

FLX54RB



Adds 1½" of Pop-up Height

20,000 Volt Lightning Rating

Left: Rain Bird Eagle 900

Right: Rain Bird Eagle 900 upgraded with Toro R Series upgrade assembly and optional Spike Guard solenoid/adaptor



SPECIFICATIONS

Operational

- Ratcheting riser allows riser positioning without riser removal
- Recommended Operating Pressure Range: 60-100 psi (maximum – 150 psi and minimum – 40 psi)
- Radius reduction screw for radius refinement
- Riser pull-up feature simplifies servicing
- Effluent identifier included
- Yardage marker capable
- 3.25" pop-up clears tall grasses

Nozzles

- 4 main nozzle combinations included provides a wide range of radius and flow capabilities
- Back nozzle capable (FLX55-6RB & FLX55RB)
- Two additional front nozzle positions (FLX54RB only)
- Nozzle base clutching (FLX55-6RB & FLX55RB) allows nozzle base movement by hand
- All nozzles threaded from the front with no other disassembly required

Specifying Information—FLEX800 R Series Conversion Assemblies

Model Number	Description
FLX55-6RB-5154	R Series Conversion with FLX55-6 riser assembly and low flow nozzle set #51 - #54
FLX55-6RB-5558	R Series Conversion with FLX55-6 riser assembly and high flow nozzle set #55 - #58
FLX55RB-5154	R Series Conversion with FLX55 riser assembly and low flow nozzle set #51 - #54
FLX55RB-5558	R Series Conversion with FLX55 riser assembly and high flow nozzle set #55 - #58
FLX54RB-5154	R Series Conversion with FLX54 riser assembly and low flow nozzle set #51 - #54
FLX54RB-5558	R Series Conversion with FLX54 riser assembly and high flow nozzle set #55 - #58
SPIKEGUARD-RB	Toro solenoid adapter with Spike Guard™ solenoid for Rain Bird® Eagle 700, 900 or 1100 Series sprinklers

Toro® has designed and manufactured this product to fit within a sprinkler housing made by Rain Bird® Corporation, but Toro's product is not manufactured by or affiliated with Rain Bird®. Rain Bird® is a registered trademark of Rain Bird Corporation.

TORO SPRINKLER CONVERSION ASSEMBLIES



CROSS REFERENCE GUIDE					Models Being Replaced										
New Model	Arc	Trajectory	Radius - Ft	Flow - gpm	634	664	734	764	765	864S	865S	834S	835S	DT34	DT35
FLX34-3134	Full Circle	25° or 15°	52' - 79'	12.9 - 34.9	X	X	X	X	X	X	X	X	X	X	X
FLX34-3537	Full Circle	25° or 15°	67' - 91'	32.1 - 46.9	X	X	X	X	X	X	X	X	X	X	X
FLX35-3134	Part/Full Circle	25° or 15°	52' - 74'	13.6 - 34.1			1	X	X	X	X	X	X	X	X
FLX35-3537	Part/Full Circle	25° or 15°	69' - 83'	33.1 - 47.3			1	X	X	X	X	X	X	X	X
FLX35-6-3134	Part/Full Circle	30° - 7°	46' - 80'	15.5 - 37.0			1	X	X	X	X	X	X	X	X
FLX35-6-3537	Part/Full Circle	30° - 7°	59' - 92'	32.4 - 45.3			1	X	X	X	X	X	X	X	X

1. Must have ribbed bodies manufactured after 1992 to use Part/Full circles.



CROSS REFERENCE GUIDE					Models Being Replaced													
New Model	Arc	Trajectory	Radius - Ft	Flow - gpm	654	655	670	684	690	754	784	785	884S	885S	854S	855S	DT54	DT55
FLX54-5154	Full Circle	25° or 15°	58' - 81'	13.2 - 36.7	2	2	2	2	4	2	2	2	X	X	X	X	X	X
FLX54-5558	Full Circle	25° or 15°	79' - 95'	34.2 - 55.4	2	2	2	2	4	2	2	2	X	X	X	X	X	X
FLX54-59	Full Circle	25° or 15°	96' - 99'	55.6 - 61.8	2	2	2	2	4	2	2	2	X	X	X	X	X	X
FLX55-5154	Part/Full Circle	25° or 15°	55' - 75'	14.0 - 34.5					4	2	2	2	X	X	X	X	X	X
FLX55-5558	Part/Full Circle	25° or 15°	73' - 90'	35.3 - 53.9					4	2	2	2	X	X	X	X	X	X
FLX55-59	Part/Full Circle	25° or 15°	82' - 92'	57.2 - 61.3					4	2	2	2	X	X	X	X	X	X
FLX55-6-5154	Part/Full Circle	30° - 7°	46' - 80'	13.9 - 38.2					4	2	2	2	X	X	X	X	X	X
FLX55-6-5558	Part/Full Circle	30° - 7°	59' - 95'	33.8 - 51.1					4	2	2	2	X	X	X	X	X	X
FLX55-6-59	Part/Full Circle	30° - 7°	77' - 100'	57.0 - 61.1					4	2	2	2	X	X	X	X	X	X
FLX55-5154R	Part/Full Circle	25° or 15°	55' - 75'	14.0 - 34.5	3	3	3	3										
FLX55-5558R	Part/Full Circle	25° or 15°	73' - 90'	35.3 - 53.9	3	3	3	3										
FLX55-59R	Part/Full Circle	25° or 15°	82' - 92'	57.2 - 61.3	3	3	3	3										
FLX55-6-5154R	Part/Full Circle	30° - 7°	46' - 80'	13.9 - 38.2	3	3	3	3										
FLX55-6-5558R	Part/Full Circle	30° - 7°	59' - 95'	33.8 - 51.1	3	3	3	3										
FLX55-6-59R	Part/Full Circle	30° - 7°	77' - 100'	57.0 - 61.1	3	3	3	3										

2 - Requires the separate purchase and use of 102-0950 conversion adapter

3 - Use the "R" Series (Ribless body) conversion for bodies dated prior to 1992.

4 - Requires the separate purchase and use of 102-5011 690 conversion adapter





FLEX800™ R SERIES CONVERSION UPGRADES

Main Nozzle Data

FLX55-6RB-5154 Performance Chart										FLX55-6RB-5558 Performance Chart							
Front Nozzle Positions	Nozzle Set 51 (Yellow)		Nozzle Set 52 (Blue)		Nozzle Set 53 (Brown)		Nozzle Set 54 (Orange)		Nozzle Set 55 (Green)		Nozzle Set 56 (Gray)		Nozzle Set 57 (Black)		Nozzle Set 58 (Red)		
	102-4587		102-4588		102-4589		102-0728		102-0729		102-0730		102-4261		102-4260		
Back Nozzle Positions																	
	Red Plug	Red Plug	Red Plug	Red Plug	Red Plug	Red Plug	Red Plug	Red Plug	Red Plug	Red Plug	Red Plug	Red Plug	Red Plug	Red Plug	Red Plug	Red Plug	
	102-4335	102-4335	102-4335	102-4335	102-4335	102-4335	102-4335	102-4335	102-4335	102-4335	102-4335	102-4335	102-4335	102-4335	102-4335	102-4335	
	psi	Rad/Ft	gpm	Rad/Ft	gpm	Rad/Ft	gpm	Rad/Ft	gpm	Rad/Ft	gpm	Rad/Ft	gpm	Rad/Ft	gpm	Rad/Ft	gpm
	60	55	16.1	63	20.3	69	23.4	75	31.3	—	—	—	—	—	—	—	—
	70	56	17.4	66	21.8	70	25.3	76	33.8	—	—	—	—	—	—	—	—
	80	57	18.5	68	23.3	72	27.0	77	36.0	80	39.1	85	41.0	88	45.4	92	49.7
	90	58	19.4	70	24.5	75	28.5	79	38.1	83	41.5	87	43.5	91	48.2	94	52.8
	100	59	20.5	72	25.9	76	30.0	80	40.2	86	43.7	90	45.7	94	50.6	96	55.3
Stator	102-1939 Yellow								102-1940 White								

FLX55RB-5154 Performance Chart										FLX55RB-5558 Performance Chart							
Front Nozzle Positions	Nozzle Set 51 (Yellow)		Nozzle Set 52 (Blue)		Nozzle Set 53 (Brown)		Nozzle Set 54 (Orange)		Nozzle Set 55 (Green)		Nozzle Set 56 (Gray)		Nozzle Set 57 (Black)		Nozzle Set 58 (Red)		
	102-6906		102-0726		102-6907		102-0728		102-6955		102-6935		102-6936		102-6909		
Back Nozzle Positions																	
	Red Plug	Red Plug	Red Plug	Red Plug	Red Plug	Red Plug	Red Plug	Red Plug	Red Plug	Red Plug	Red Plug	Red Plug	Red Plug	Red Plug	Red Plug	Red Plug	
	102-4335	102-4335	102-4335	102-4335	102-4335	102-4335	102-4335	102-4335	102-4335	102-4335	102-4335	102-4335	102-4335	102-4335	102-4335	102-4335	
	psi	Rad/Ft	gpm	Rad/Ft	gpm	Rad/Ft	gpm	Rad/Ft	gpm	Rad/Ft	gpm	Rad/Ft	gpm	Rad/Ft	gpm	Rad/Ft	gpm
	60	56	15.2	57	20.1	66	24.3	68	28.0	—	—	—	—	—	—	—	—
	70	58	16.5	60	21.7	67	26.2	71	30.4	—	—	—	—	—	—	—	—
	80	59	17.5	62	23.1	68	27.8	72	31.7	76	39.7	80	43.1	83	48.2	85	53.0
	90	60	18.4	64	24.5	71	28.8	74	34.5	78	43.1	81	45.1	86	51.2	87	56.0
	100	61	19.3	66	25.3	72	30.3	75	36.5	80	45.5	82	49.0	90	54.5	89	59.0





FLX54RB-5154 Performance Chart										FLX54RB-5558 Performance Chart							
Front Nozzle Positions	Nozzle Set 51 (Yellow)		Nozzle Set 52 (Blue)		Nozzle Set 53 (Brown)		Nozzle Set 54 (Orange)		Nozzle Set 55 (Green)		Nozzle Set 56 (Gray)		Nozzle Set 57 (Black)		Nozzle Set 58 (Red)		
	102-0725		102-7001		102-0727		102-7002		102-6908		102-0730		102-4261		102-4260		
Back Nozzle Positions																	
	102-6937	102-2925	102-6937	102-2926	102-6937	102-2928	102-6937	102-2929	102-6937	102-2929	102-6937	102-2928	102-6937	102-4965	102-6937	102-4965	
	psi	Rad/Ft	gpm	Rad/Ft	gpm	Rad/Ft	gpm	Rad/Ft	gpm	Rad/Ft	gpm	Rad/Ft	gpm	Rad/Ft	gpm	Rad/Ft	gpm
	60	59	14.6	62	17.4	68	24.3	71	28.2	—	—	—	—	—	—	—	—
	70	60	15.7	63	18.8	70	26.3	75	30.6	—	—	—	—	—	—	—	—
	80	61	16.4	64	20.0	72	27.6	78	32.6	83	39.5	85	42.7	87	45.9	91	50.2
	90	62	17.8	66	21.3	74	29.9	80	34.7	85	41.6	88	44.9	90	48.5	93	52.8
	100	63	18.1	67	23.6	75	30.4	81	36.7	87	43.7	90	46.8	93	51.2	95	55.4
Stator	102-6929 Blue								102-1940 White								

Not recommended at these pressures. Radius shown in feet. Toro recommends the use of a 1 1/4" swing joint at flows over 25-gpm (95-LPM). Sprinkler radius data collected in Toro's zero wind test facility per ASAE standard S398.1. Actual site conditions must be considered when selecting the appropriate nozzle.







Mainless Data

FLX55-6RB SERIES MAINLESS NOZZLE PERFORMANCE DATA

										
	Blue Plug Gray 102-2925 102-2208 102-2910		Orange Plug Gray 102-2926 102-2208 102-2910		Red Plug Gray 102-2928 102-2208 102-2910		Gray Plug Gray 102-2910 102-2208 102-2910		Gray Plug Gray 102-2930 102-2208 102-2910	
psi	Radius	gpm	Radius	gpm	Radius	gpm	Radius	gpm	Radius	gpm
65	46	8.7	46	10.4	50	12.4	42	10.2	47	13.9
SOR	5:02		4:16		3:36		4:19		4:06	
80	46	9.6	47	11.5	53	13.7	44	11.2	51	15.3
SOR	4:22		3:40		3:03		3:53		3:40	











Requires the low-flow stator 102-6929 for indicated rotation speeds.
SOR: Speed of rotation

FLX55RB MAINLESS NOZZLE PERFORMANCE DATA

								
	Green Plug Gray 102-6531 102-2208 102-2910		Green Plug Green 102-6531 102-2208 102-6885		Green Plug Red 102-6531 102-2208 102-2928		Green Plug Beige 102-6531 102-2208 102-2929	
psi	Radius	gpm	Radius	gpm	Radius	gpm	Radius	gpm
65	34	10.4	44	10.2	48	11.5	50	13.5
SOR	3:40		3:50		3:25		2:40	
80	37	11.6	44	11.4	48	12.9	50	15.0
SOR	3:15		3:25		3:00		2:30	

Requires the low-flow stator 102-6929 for indicated rotation speeds.
SOR: Speed of rotation

Back Nozzle Performance Data

Nozzles			65 psi		80 psi		Profile
Part #	Description	Color	Radius	gpm	Radius	gpm	
102-6937	Inner Nozzle w/ Yellow Restrictor	 Yel/Yel	29	3.7	30	4.1	
102-6531	Inner Nozzle w/ White Restrictor	 Grn/Wht	31	4.3	33	4.6	
102-6883	Intermediate Nozzle	 Brown	38	2.8	38	2.8	
102-6884	Intermediate Nozzle	 Yellow	41	4.1	43	4.5	
102-6885	Intermediate Nozzle	 Green	42	5.4	45	6.0	
102-2925	Intermediate Nozzle	 Blue	40	2.8	42	3.2	
102-2926	Intermediate Nozzle	 Orange	44	4.3	45	4.8	
102-2927	Intermediate Nozzle	 Gray	46	5.1	47	5.4	
102-2928	Intermediate Nozzle	 Red	48	6.5	50	7.0	
102-2929	Intermediate Nozzle	 Beige	51	8.1	53	9.1	



The T7 Series sprinkler is built rugged to withstand harsh golf course conditions. The low-flow version is perfect for shorter-radius golf course applications like tee boxes, surrounds and perimeters. The T7 has been designed and tested to ensure the high reliability demanded by the market.

FEATURES & BENEFITS

Water is Evenly Distributed

High efficiency nozzles with single port design ensure water is evenly distributed across the pattern.

Versatility

Available in standard and low-flow models to meet your application needs.

Vandal and Abuse Resistant

The Smart Arc™ memory safely returns the sprinkler to previously set arc even when turned beyond arc borders.

Clears Tall Grasses

The 5.75 inch pop-up ensures proper spray pattern and nozzle distribution uniformity even in taller grasses.

Additional Features

- ✓ Standard check valve
- ✓ Radius reduction screw – up to 25%
- ✓ Threaded cap-retained riser assembly
- ✓ Variable reversing stator
- ✓ Slip clutch
- ✓ Riser pull-up feature – adjustment/pull-up tool supplied
- ✓ Locking cap screw





Top Arc Indication
Arc setting indicator on top of the rotor allows for easy wet or dry adjustments. Part or full-circle from 45° to 360°.

Model Choices

- ✓ Plastic or stainless steel models
- ✓ Low-Flow or High-Flow models
- ✓ Effluent water indicator models

SPECIFICATIONS

Operational

- Inlet size: 1" threaded ACME
- Radius:
 - Low-flow models: 38' – 56'
 - High-flow models: 46' – 75'
- Flow rate:
 - Low-flow models: 1.7 – 13.0 gpm; 6 nozzle tree included with each head (2, 3, 4.5, 6, 7.5 and 9)
 - High-flow models: 6.8 – 30.5 gpm; 7 nozzle tree included with each head (7, 9, 12, 16, 20, 24 and 27)
- Operating pressure: 40-100 psi
- Arc adjustment: 45° - 360° (unidirectional at 360°)

Dimensions

- Body diameter: 2.7"
- Body height: 8.8"
- Rubber cover diameter: 2.2"
- Pop-up height to nozzle: 5.75"

Warranty

- Five years

NOZZLE PERFORMANCE DATA-HIGH FLOW MODELS

Nozzle	psi	Radius (ft)	gpm	Precip. Rate (in/hr) ▲	Precip. Rate (in/hr) ■
7.0	40	46	6.6	0.72	0.62
	50	47	7.4	0.75	0.65
	60	48	8.1	0.78	0.68
	70	49	8.8	0.82	0.71
	80	51	9.4	0.83	0.72
	90	52	10.3	0.85	0.73
9.0	100	54	10.7	0.83	0.72
	40	47	7.4	0.76	0.66
	50	50	8.3	0.73	0.64
	60	51	8.7	0.76	0.66
	70	52	9.4	0.81	0.70
	80	54	9.9	0.80	0.69
12.0*	90	55	10.9	0.82	0.71
	100	56	11.5	0.84	0.73
	40	50	9.5	0.89	0.77
	50	51	11.6	0.90	0.78
	60	53	12.7	0.91	0.79
	70	54	13.8	0.96	0.83
16.0	80	55	14.7	0.99	0.86
	90	56	15.6	1.02	0.88
	100	57	16.5	1.04	0.90
	40	53	13.0	1.06	0.92
	50	56	15.1	1.06	0.92
	60	58	16.2	1.04	0.90
20.0	70	59	17.5	1.09	0.95
	80	61	18.8	1.10	0.95
	90	62	20.0	1.14	0.98
	100	63	21.1	1.17	1.01
	40	53	16.0	1.28	1.10
	50	58	17.5	1.22	1.05
24.0	60	60	19.5	1.21	1.05
	70	61	20.6	1.26	1.09
	80	65	22.2	1.19	1.03
	90	66	23.6	1.23	1.06
	100	67	24.8	1.25	1.09
	40	52	15.8	1.27	1.10
27.0	50	60	17.5	1.09	0.95
	60	63	19.3	1.11	0.96
	70	65	20.7	1.14	0.99
	80	67	22.3	1.15	1.00
	90	68	23.8	1.20	1.04
	100	71	25.3	1.16	1.01
27.0	40	55	18.7	1.42	1.23
	50	65	23.4	1.16	1.00
	60	71	23.6	1.05	0.91
	70	72	25.8	1.10	0.95
	80	73	27.4	1.14	0.99
	90	74	29.1	1.18	1.02
100	75	30.6	1.21	1.05	

NOZZLE PERFORMANCE DATA-LOW FLOW MODELS

Nozzle	psi	Radius (ft)	gpm	Precip. Rate (in/hr) ▲	Precip. Rate (in/hr) ■
2.0	40	39	1.7	0.25	0.22
	50	39	2.0	0.29	0.25
	60	40	2.2	0.30	0.26
	70	40	2.4	0.33	0.28
	80	40	2.6	0.35	0.31
	90	41	2.7	0.36	0.31
3.0*	100	41	2.9	0.38	0.33
	40	39	2.4	0.36	0.31
	50	40	2.8	0.39	0.33
	60	41	3.1	0.41	0.36
	70	41	3.4	0.45	0.39
	80	42	3.6	0.46	0.40
4.5	90	42	3.9	0.47	0.41
	100	43	4.1	0.49	0.42
	40	38	4.1	0.63	0.54
	50	41	4.7	0.62	0.53
	60	41	5.2	0.68	0.59
	70	42	5.7	0.71	0.62
6.0	80	42	6.1	0.77	0.66
	90	43	6.5	0.78	0.68
	100	43	6.9	0.83	0.72
	40	43	5.0	0.59	0.51
	50	46	5.7	0.59	0.51
	60	48	6.3	0.61	0.52
7.5	70	49	7.0	0.65	0.57
	80	49	7.4	0.68	0.59
	90	50	7.9	0.70	0.61
	100	50	8.4	0.74	0.64
	40	44	5.8	0.66	0.58
	50	46	6.7	0.70	0.60
9.0	60	48	7.4	0.71	0.62
	70	49	8.0	0.75	0.65
	80	50	8.8	0.78	0.67
	90	50	9.5	0.84	0.73
	100	52	10.0	0.81	0.70
	40	45	7.4	0.81	0.70
9.0	50	49	8.5	0.78	0.68
	60	51	9.4	0.80	0.70
	70	53	10.4	0.83	0.72
	80	55	11.3	0.83	0.72
	90	55	12.0	0.89	0.77
	100	56	12.8	0.90	0.78

[†] When the sprinkler is adjusted to 360°, it will be uni-directional in that direction of rotation (clockwise or counterclockwise) at the moment when the sprinkler was changed to 360°
* Pre-installed nozzle. Data based on 180°.

Specifying Information—T7 Series Rotors

T7PSS-42XX			
Description	Optional	Thread	Optional
T7P	SS	42	X
T7P—Sports Rotor	SS—Stainless Steel Riser	42—ACME Thread	E—Effluent L—Low Flow

Example: A low flow T7P sprinkler with a stainless steel riser and effluent rubber cover would be specified as **T7PSS-42LE**



For nearly 50 years the 690 Series has set the standard for durability and reliability in golf applications. Two 2-speed models provide a slower speed in the non-overlap areas and a faster speed in the overlap areas to provide a more balanced precipitation rate than traditional single speed full circle sprinklers in these applications which lowers system costs.

FEATURES & BENEFITS

696 2-Speed Models

Used in single row applications these sprinklers operate at a slower speed over the 60 degree non-overlap area and a faster speed over the 120 degree overlapped areas to provide a balanced application rate.

698 2-Speed Models

Used in double row applications these sprinklers operate at a slower speed over the 180 degree non-overlap area and a faster speed over the 180 degree overlapped areas to provide a balanced application rate.

Artificial Playing Surfaces

Radius and flow capabilities are perfect for cooling and rinsing artificial playing surfaces.

Electric Valve In Head Models

Electric valve in head models provide individual head control that ensures run times can match differing soil, turf and terrain watering requirements, pressure regulation to ensure all nozzles perform at the same pressure and manual ON-OFF-Auto control at the head.



Additional Features

- ✓ Manual control at the sprinkler, On-Off-Auto (electric)
- ✓ Time-proven, gear-drive design
- ✓ All internal components serviceable from the top of the sprinkler
- ✓ Durable engineering plastic and stainless steel construction
- ✓ Nine arc selections

690 SERIES CONVERSIONS AND RISERLESS BODIES

Model	Description
69A-92	CONV,150DEG,92NOZ
69B-92	CONV,165DEG,92NOZ
69C-92	CONV,195DEG,92NOZ
69D-92	CONV,210DEG,92NOZ
691-91	CONV,90DEG,91NOZ
691-92	CONV,90DEG,92NOZ
692-90	CONV,180DEG,90NOZ
692-91	CONV,180DEG,91NOZ
692-92	CONV,180DEG,92NOZ
694-90	CONV,360DEG,90NOZ
694-91	CONV,360DEG,91NOZ
694-92	CONV,360DEG,92NOZ
696-91	CONV,60X120DEG,2SPD,91NOZ
696-92	CONV,60X120DEG,2SPD,92NOZ
698-91	CONV,180X180DEG,2SPD,91NOZ
698-92	CONV,180X180DEG,2SPD,92NOZ
690-06-1	BODY,RISERLESS,690,ADJPSI,STD
690-06-2	BODY,RISERLESS,690,ADJPSI,SG
690-06-4	BODY,RISERLESS,690,ADJPSI,DCL
690-COM	BODY,RISERLESS,690,CHECK-O-MATIC
690-NO	BODY,RISERLESS,690,NORMALLY OPEN



SPECIFICATIONS

Operational

- Inlet: 1½" NPT
- Radius: 87' – 108'
- Flow Rate: 51.0 – 82.2 gpm
- Recommended Operating Pressure Range: 80-100 psi
- Maximum pressure: 150 psi
- Minimum pressure: 40 psi
- Electric Valve-In-Head Solenoid: 24V ac, 50/60 Hz
- Inrush: 60 Hz, 0.30 Amps
- Holding: 60 Hz, 0.20 Amps
- Check-O-Matic: Maintains 37' of elevation

Dimensions

- Body diameter: 10"
- Body height: 16"
- Weight: 5.6 lbs.
- Pop-up height to nozzle: 3/4"

Warranty

- Three years
- Five years when installed with Toro Swing Joints



698
180 x 180 2SPD



696
60 x 120 2SPD



694
360°



69D
240°



69C
210°



692
180°



69B
150°



69A
120°



691
90°

Fixed Arc Drives

Nine fixed arc drive assemblies ensure positive retention of the coverage area with no arc drift.

690 SERIES PERFORMANCE CHART

Base Pressure	Nozzle Set 90		Nozzle Set 91		Nozzle Set 92	
	Radius	gpm	Radius	gpm	Radius	gpm
psi						
80	87	51.0	96	61.2	100	74.0
100	90	57.1	100	73.5	108	82.2

Radius shown in feet.
Sprinkler radius of throw per ASAE standard S398.1.

Specifying Information—690 Series Rotors

69X-0X-XXX			
Arc	Valve-In-Head Type	Nozzle	Pressure Regulation*
69X	0X	XX	X
1—90°	1—Normally Open	90	8—80 psi
2—180°	Hydraulic	91	1—100 psi
4—Full-circle	2—Check-O-Matic	92	
6—Full-circle, 2-speed (60°–120°)	6—Electric		
8—Full-circle, 2-speed (180°–180°)			

Example: When specifying a 690 Series Sprinkler with a 180° arc, electric valve-in-head, #91 nozzle, and pressure regulation at 80 Psi, you would specify: **692-06-918**

*Electric models only.



Toro's 590GF Series is the first spray head designed specifically for golf course irrigation with enhanced water management capabilities. The 590GF is built for the tough golf course environment, including harsh debris situations like top-dressing and sand, high water pressures, and daily mower and foot traffic. The 590GF is perfect around bunkers, on small tee boxes, and around the clubhouse. And with its patented X-Flow technology, the 590GF has a built-in shutoff device should a nozzle be damaged or removed and it's standard check valve feature minimizes low head drainage.

FEATURES & BENEFITS

Nozzle Options

In addition to the full line of Toro MPR, TVAN and specialty nozzles the 590GF accepts the revolutionary Precision™ Spray and Precision™ Rotating Series nozzles with optimized distribution uniformity that provides exceptional turf conditions with minimal water usage.

Designed Flush Rate

Sprinkler flushes during pop-up and retraction clearing debris from around the riser to eliminate stick-ups and ensure positive sealing and retraction.

X-Flow® Shut Off Device

The X-Flow shut off feature stops the flow of water if the nozzle is damaged or removed to eliminate flooding, water waste and soil erosion.

Prevent Low Head Drainage

The standard check valve prevents low head drainage with up to 10' of elevation change minimizing soil erosion and water waste.





*Without X-Flow®
Water waste, soil erosion and flooding occur*



*With X-Flow®
Eliminates water waste, soil erosion and flooding*



Flanged Cap
Flanged cap installs below grade to stabilize the body position and maintain optimum nozzle performance.

SPECIFICATIONS

Operational

- Radius: 2' – 26'
- Recommended pressure range: 25-50 psi (maximum – 75 psi)
- Flow rate: 0.05 – 4.5 gpm
- 2 gpm flush rate

Dimensions

- Body diameter:
 - 1³/₈" on 4P and 6P
 - 1⁵/₈" on 12P
- Cap diameter: 2"
- Inlet: 1/2" female-threaded

Warranty

- Three years

Additional Features

- ✓ Stainless steel retraction spring
- ✓ All bodies shipped with flush plug in place
- ✓ Ratcheting riser feature for arc adjustment

Risers and Extenders

570-6X

- Male-inlet threads install onto any 590GF sprinkler to provide a 6" extension
- Maximum pressure: 75 psi

570SR-6 and 570SR-18 Risers

- 1/2" male-threaded inlet for installation on pipe fittings
- Maximum pressure: 75 psi
- Height: 6" and 18"



Specifying Information—590GF Series Sprays

590GF-XX-E		
Model	Pop-Up Height	Optional
590GF	XX	E
590GF—590GF Series Sprays	4—4" Pop-Up 6—6" Pop-Up 12—12" Pop-Up	E—Effluent



Making use of the same patented gear drive technology found in Toro's world-leading Golf rotors, Toro® Precision™ Series Rotating Nozzles are powered by a planetary drive system that delivers a pattern of multiple wind resistant, multi-trajectory streams. The full circle and adjustable arc models deliver a radius range of 14 to 26 feet with exceptional uniformity and close-in watering characteristics at a precipitation rate of 0.6 inches per hour.

FEATURES & BENEFITS

Consistent, Gear-Driven Performance

Precision™ Series Rotating Nozzles are uniquely powered by a patented planetary gear drive, variable stator and turbine. Unlike competing rotating nozzles, the Precision™ Series Rotating Nozzle's gear drive is not system pressure dependent and delivers consistent rotation speed and performance across a wide range of operating pressures. The entire drive system is protected by the factory-installed fine mesh filter screen.

Fewer Models

Two Toro-threaded models and two female-threaded models are all that are required to cover radius requirements of 14 to 26 feet and infinitely adjustable arcs between 45° and 270° or 360°. Fewer models allow for less inventory and more flexibility.

Matched Precipitation Rate

These nozzles deliver water more slowly and evenly than standard spray nozzles, which helps prevent runoff and water waste. Moreover, the 0.6" per hour precipitation rate better positions users to meet watering window requirements than competing rotating nozzles.

EZ ARC™ Visual Arc Indicators

Toro Precision™ Series Rotating Nozzles are the only rotating nozzles available that allow the user to dial in the nozzle's arc setting before installation. Further, the nozzle features a right edge call-out on adjustable models that assists in quick and effective installations.



Female-threaded
PRN-A



Male-threaded
PRN-TA



Female-threaded
PRN-F



Male-threaded
PRN-TF



WATER MANAGEMENT HIGHLIGHT



Precision™ Series Rotating Nozzle Shrub & Slope Kit

Fully-assembled kit includes Precision™ Rotating Nozzle, 570S Shrub riser with patented X-Flow® Technology, and Precision™ Check Valve. This water-saving combination is ideally suited for stationary above-ground applications, such as slopes, shrub irrigation, and nursery settings.

(PRNA-S-PCV, PRNF-S-PCV)

PRECISION™ SERIES ROTATING NOZZLES PERFORMANCE DATA

Arc	psi	gpm	Radius	Precip. Rate	
				■ (in./hr.)	▲ (in./hr.)
45°	20	0.17	14.0	0.67	0.77
	30	0.19	15.0	0.65	0.75
	40	0.25	17.0	0.67	0.77
	50	0.31	18.5	0.70	0.81
	60	0.35	19.5	0.71	0.82
	75	0.43	22.0	0.68	0.79
90°	20	0.43	16.0	0.65	0.75
	30	0.49	17.5	0.62	0.71
	40	0.62	20.5	0.57	0.66
	50	0.75	22.5	0.57	0.66
	60	0.82	23.5	0.57	0.66
	75	0.92	25.0	0.57	0.65
120°	20	0.48	16.4	0.69	0.79
	30	0.57	17.5	0.72	0.83
	40	0.78	20.2	0.55	0.64
	50	0.97	22.5	0.55	0.64
	60	1.07	23.5	0.56	0.65
	75	1.18	25.0	0.55	0.63
180°	20	0.83	15.0	0.71	0.82
	30	0.94	17.0	0.63	0.72
	40	1.22	20.5	0.56	0.65
	50	1.46	22.5	0.56	0.64
	60	1.61	24.0	0.54	0.62
	75	1.81	26.0	0.52	0.60
240°	20	1.12	15.0	0.72	0.83
	30	1.27	17.0	0.63	0.73
	40	1.56	20.0	0.56	0.65
	50	1.80	21.5	0.56	0.65
	60	1.95	22.5	0.56	0.64
	75	2.20	24.0	0.55	0.64
270°	20	1.08	14.0	0.71	0.81
	30	1.23	16.0	0.62	0.71
	40	1.62	19.0	0.57	0.66
	50	2.00	21.5	0.55	0.64
	60	2.26	23.0	0.55	0.63
	75	2.60	25.0	0.53	0.61
360°	20	1.81	15.0	0.77	0.89
	30	2.00	17.2	0.65	0.75
	40	2.56	20.9	0.56	0.65
	50	3.09	22.9	0.57	0.65
	60	3.34	23.8	0.57	0.66
	75	3.68	25.6	0.54	0.62

Nozzle data subject to change.

PRECISION™ SERIES ROTATING NOZZLE MODEL LIST

Toro (male)-threaded	Description
PRN-TA	14-26 feet, Adjustable from 45°-270°
PRN-TF	14-26 feet, Full circle
Female-threaded	
PRN-A	14-26 feet, Adjustable from 45°-270°
PRN-F	14-26 feet, Full circle
Shrub & Slope Kit	
PRNA-S-PCV	Adjustable arc kit with X-Flow® and 15' Check Valve
PRNF-S-PCV	Full Circle kit with X-Flow® and 15' Check Valve

SPECIFICATIONS

Operational

- Radius: 14'-26'
- Operating pressure range: 20-75 psi
- Recommended operating pressure: 45 psi
- Flow Rate: 0.17-3.68 gpm

Warranty

- Two years

Additional Features

- ✓ Maximum trajectory height of 20° to help fight wind
- ✓ Threads onto nearly all manufacturers' spray heads and shrub adapters
- ✓ Pre-attached screen for easy installation
- ✓ Radius reduction up to 25% by turning set screw
- ✓ Color-coded to easily identify adjustable and full circle models



Step-Up™ Technology

Enables the delivery of a highly uniform pattern of water all the way out to the furthest point of the radius. The unique steps create fifteen streams, each designed to cover an area of the pattern.



Precision™ Series Rotating Nozzle Visual Arc Adjustment

The unique arc adjustment ring dial allows for pre-setting the arc by hand or with the PRNTOOL before the nozzle is installed or quickly after the nozzle is threaded onto the spray head and under pressure.

Specifying Information—Precision™ Series Rotating Nozzle

PRN-XX		
Model	Thread	Arc
PRN	X	X
PRN—Precision™ Rotating Nozzle	T—Toro (male)-thread Blank—Female-thread	A—Adjustable F— Full circle

Example: A male threaded Precision™ Series Rotating nozzle with a 24' radius and a 180° arc would be specified as: **PRN-TA**
A female threaded Precision™ Series Rotating nozzle with a 20' radius and 360° arc would be specified as: **PRN-F**

Note: For optimal performance in dirty water applications, a minimum of 120 mesh primary filtration is recommended.



Toro® Precision™ Series Spray Nozzles are the most efficient spray nozzles available and feature proprietary H²O Chip Technology. With a precipitation rate of 1" per hour, Precision™ Series Spray Nozzles help irrigation professionals better manage water usage, eliminate runoff, and reduce their customers' water bills. These nozzles are available in a wide variety of arcs and radii, as well as Toro (male) and female-threaded bodies, making them ideal for large scale installations and retrofits. In addition, the best-in-class Precision™ Series Spray nozzles are available with factory-installed Pressure Compensating Discs (PCD).

FEATURES & BENEFITS

Patented H²O Chip Technology

Each nozzle contains one or more H²O chips that create a high frequency oscillating stream and deliver a precipitation rate of 1" per hour – an industry first – while using up to 35% less water than a standard MPR nozzle.

Pressure-Compensating Versions Available

At a fraction of the cost of a pressure-regulating spray head, pressure-compensating Precision™ Series Spray Nozzles maintain a 1" per hour precipitation rate and minimize misting and water waste that results from higher pressure systems.

Design and Retrofit Effectiveness

The lower flow rate of Precision™ Series Spray Nozzles maximizes design efficiency and helps reduce overall material costs based on the need for fewer valves and controller stations.

Third-Party Performance Validation

Precision™ Series Spray Nozzles* have been tested and validated in the field and at the Center for Irrigation Technology (CIT).

* non-PCD models only



Male-threaded Model



Female-threaded Model

Pressure Compensating Disc (PCD)
The elastomeric PCD adjusts in response to changes in inlet pressure to maintain optimal nozzle performance. Recommended for use on systems operating above 40 psi, PCD models can easily be identified by the red Toro lettering across the top of the nozzle.



WATER MANAGEMENT HIGHLIGHT

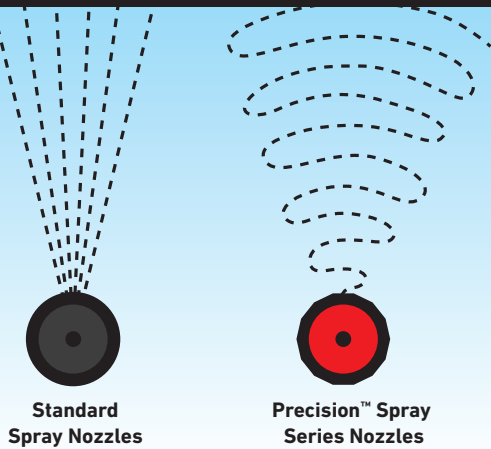

Patented H²O Chip Technology Delivers Improved Uniformity
Water enters a specially designed chamber within the H²O Chip where the water expands and collapses, creating an oscillating effect. Consistent-sized water droplets exit the Chip in the designed arc pattern and radius with clean edge definition, class-leading distribution uniformity, and reduced water usage.

SPECIFICATIONS

Operational

- Radius: 5'-15'
- Operating pressure range: 20-75 psi
- Recommended operating pressure: non-Pressure Compensating—30 psi, Pressure Compensating—50 psi
- Flow Rate: 0.04-2.4 gpm
- Nozzle trajectory:
 - 5': 5°
 - 8': 10°
 - 10': 15°
 - 12': 20°
 - 15': 27°
 - Corner and Side Strips: 20°

Warranty

- Two years

Additional Features

- ✓ Specialty Arcs available (60°, 120°, 150°, 210°, 240°)
- ✓ Radius reduction capability of 25%
- ✓ Matched precipitation rate after radius adjustment

PRECISION™ SERIES SPRAY NOZZLE MODEL LIST

5' NOZZLE (RED)			8' NOZZLE (GREEN)		
Male	Female	Pattern	Male	Female	Pattern
O-T-5-60	O-5-60	60° Arc	O-T-8-60	O-8-60	60° Arc
O-T-5-Q	O-5-Q	90° Arc	O-T-8-Q	O-8-Q	90° Arc
O-T-5-T	O-5-T	120° Arc	O-T-8-T	O-8-T	120° Arc
O-T-5-150	O-5-150	150° Arc	O-T-8-150	O-8-150	150° Arc
O-T-5-H	O-5-H	180° Arc	O-T-8-H	O-8-H	180° Arc
O-T-5-210	O-5-210	210° Arc	O-T-8-210	O-8-210	210° Arc
O-T-5-TT	O-5-TT	240° Arc	O-T-8-TT	O-8-TT	240° Arc
O-T-5-TQ	O-5-TQ	270° Arc	O-T-8-TQ	O-8-TQ	270° Arc
O-T-5-F	O-5-F	360° Arc	O-T-8-F	O-8-F	360° Arc
10' NOZZLE (BLUE)			12' NOZZLE (BROWN)		
O-T-10-60	O-10-60	60° Arc	O-T-12-60	O-12-60	60° Arc
O-T-10-Q	O-10-Q	90° Arc	O-T-12-Q	O-12-Q	90° Arc
O-T-10-T	O-10-T	120° Arc	O-T-12-T	O-12-T	120° Arc
O-T-10-150	O-10-150	150° Arc	O-T-12-150	O-12-150	150° Arc
O-T-10-H	O-10-H	180° Arc	O-T-12-H	O-12-H	180° Arc
O-T-10-210	O-10-210	210° Arc	O-T-12-210	O-12-210	210° Arc
O-T-10-TT	O-10-TT	240° Arc	O-T-12-TT	O-12-TT	240° Arc
O-T-10-TQ	O-10-TQ	270° Arc	O-T-12-TQ	O-12-TQ	270° Arc
O-T-10-F	O-10-F	360° Arc	O-T-12-F	O-12-F	360° Arc
15' NOZZLE (BLACK)			SPECIAL PATTERNS (GREY)		
O-T-15-60	O-15-60	60° Arc			
O-T-15-Q	O-15-Q	90° Arc			
O-T-15-T	O-15-T	120° Arc	O-T-4X9-RCS	O-4X9-RCS	Right Corner
O-T-15-150	O-15-150	150° Arc	O-T-4X9-LCS	O-4X9-LCS	Left Corner
O-T-15-H	O-15-H	180° Arc	O-T-4X18-SST	O-4X18-SST	Side Strip
O-T-15-210	O-15-210	210° Arc	O-T-4X15-RCS	O-4X15-RCS	Right Corner
O-T-15-TT	O-15-TT	240° Arc	O-T-4X15-LCS	O-4X15-LCS	Left Corner
O-T-15-TQ	O-15-TQ	270° Arc	O-T-4X30-SST	O-4X30-SST	Side Strip
O-T-15-F	O-15-F	360° Arc			

PRESSURE-COMPENSATING

PRECISION™ SERIES SPRAY NOZZLE MODEL LIST

5' NOZZLE (RED)			8' NOZZLE (GREEN)		
Male	Female	Pattern	Male	Female	Pattern
O-T-5-60P	O-5-60P	60° Arc	O-T-8-60P	O-8-60P	60° Arc
O-T-5-QP	O-5-QP	90° Arc	O-T-8-QP	O-8-QP	90° Arc
O-T-5-TP	O-5-TP	120° Arc	O-T-8-TP	O-8-TP	120° Arc
O-T-5-150P	O-5-150P	150° Arc	O-T-8-150P	O-8-150P	150° Arc
O-T-5-HP	O-5-HP	18° Arc	O-T-8-HP	O-8-HP	18° Arc
O-T-5-210P	O-5-210P	210° Arc	O-T-8-210P	O-8-210P	210° Arc
O-T-5-TTP	O-5-TTP	240° Arc	O-T-8-TTP	O-8-TTP	240° Arc
O-T-5-TQP	O-5-TQP	270° Arc	O-T-8-TQP	O-8-TQP	270° Arc
O-T-5-FP	O-5-FP	360° Arc	O-T-8-FP	O-8-FP	360° Arc
10' NOZZLE (BLUE)			12' NOZZLE (BROWN)		
O-T-10-60P	O-10-60P	60° Arc	O-T-12-60P	O-12-60P	60° Arc
O-T-10-QP	O-10-QP	90° Arc	O-T-12-QP	O-12-QP	90° Arc
O-T-10-TP	O-10-TP	120° Arc	O-T-12-TP	O-12-TP	120° Arc
O-T-10-150P	O-10-150P	150° Arc	O-T-12-150P	O-12-150P	150° Arc
O-T-10-HP	O-10-HP	18° Arc	O-T-12-HP	O-12-HP	18° Arc
O-T-10-210P	O-10-210P	210° Arc	O-T-12-210P	O-12-210P	210° Arc
O-T-10-TTP	O-10-TTP	240° Arc	O-T-12-TTP	O-12-TTP	240° Arc
O-T-10-TQP	O-10-TQP	270° Arc	O-T-12-TQP	O-12-TQP	270° Arc
O-T-10-FP	O-10-FP	360° Arc	O-T-12-FP	O-12-FP	360° Arc
15' NOZZLE (BLACK)			SPECIAL PATTERNS (GREY)		
O-T-15-60P	O-15-60P	60° Arc			
O-T-15-QP	O-15-QP	90° Arc			
O-T-15-TP	O-15-TP	120° Arc	O-T-4X9-RCSP	O-4X9-RCSP	Right Corner
O-T-15-150P	O-15-150P	150° Arc	O-T-4X9-LCSP	O-4X9-LCSP	Left Corner
O-T-15-HP	O-15-HP	18° Arc	O-T-4X18-SSTP	O-4X18-SSTP	Side Strip
O-T-15-210P	O-15-210P	210° Arc	O-T-4X15-RCSP	O-4X15-RCSP	Right Corner
O-T-15-TTP	O-15-TTP	240° Arc	O-T-4X15-LCSP	O-4X15-LCSP	Left Corner
O-T-15-TQP	O-15-TQP	270° Arc	O-T-4X30-SSTP	O-4X30-SSTP	Side Strip
O-T-15-FP	O-15-FP	360° Arc			

Specifying Information-Precision™ Series Spray Nozzle

O-X-XXXX-XXXX-P				
Nozzle	Thread	Radius	Arc	PCD
O	X	XXXX	XXXX	P
O—1" Per Hour	T—Toro Male-Threaded Nozzle Blank—Female-Threaded Nozzle	5—5' 8—8' 10—10' 12—12' 15—15' 4X15—4'X15' (PCD models only) 4X30—4'X30' (PCD models only) 4X9—4'X9' 4X18—4'X18'	60—60** Q—90° T—120° 150—150** H—180° 210—210** TT—240° TQ—270° F-360°—Full-circle LCS—Left Corner RCS—Right Corner SST—Side Strip	P—Pressure Compensating

Example: A female-threaded Precision™ Series Spray with a spray radius of 12' and a 90° arc would be specified as: O-12-Q

Example 2: A male-threaded Pressure-Compensating Precision™ Series Spray with a spray radius of 10' and a 180° arc would be specified as O-T-10-HP

*Not available with Pressure Compensating.



PERFORMANCE DATA PRESSURE COMPENSATING – PRECISION™ SERIES SPRAY NOZZLES

Arc	model # (O-XX-XX)	psi	gpm	Radius	Precip. Rate	Precip. Rate	model # (O-XX-XX)	psi	gpm	Radius	Precip. Rate	Precip. Rate	model # (O-XX-XX)	psi	gpm	Radius	Precip. Rate	Precip. Rate
					■ (in./hr.)	▲ (in./hr.)					■ (in./hr.)	▲ (in./hr.)					■ (in./hr.)	▲ (in./hr.)
60°	5-60P	40	0.07	6.0	1.2	1.4	8-60P	40	0.11	7.5	1.1	1.3	10-60P	40	0.16	9.5	1.0	1.2
		50	0.07	5.5	1.3	1.5		50	0.11	7.5	1.2	1.3		50	0.18	10.5	1.0	1.1
		60	0.07	6.0	1.0	1.2		60	0.12	7.5	1.3	1.4		60	0.20	11.0	1.0	1.1
		70	0.08	6.5	1.0	1.2		70	0.14	8.0	1.2	1.4		70	0.22	11.0	1.1	1.2
90°	5-QP	40	0.06	4.6	1.0	1.2	8-QP	40	0.14	7.0	1.1	1.3	10-QP	40	0.26	9.5	1.0	1.1
		50	0.08	5.1	1.2	1.4		50	0.17	7.7	1.2	1.3		50	0.28	10.0	1.1	1.2
		60	0.09	5.6	1.3	1.5		60	0.20	8.4	1.2	1.4		60	0.29	10.5	1.1	1.3
		70	0.11	6.2	1.5	1.7		70	0.23	9.1	1.3	1.4		70	0.31	11.1	1.2	1.4
120°	5-TP	40	0.07	4.4	1.0	1.1	8-TP	40	0.20	7.6	1.0	1.2	10-TP	40	0.31	9.5	1.0	1.1
		50	0.11	4.9	1.3	1.5		50	0.24	8.0	1.1	1.3		50	0.36	10.0	1.1	1.2
		60	0.15	5.5	1.7	2.0		60	0.27	8.5	1.2	1.4		60	0.41	10.5	1.2	1.4
		70	0.19	6.0	2.0	2.4		70	0.31	8.9	1.3	1.5		70	0.46	11.0	1.3	1.5
150°	5-150P	40	0.14	6.0	0.9	1.0	8-150P	40	0.32	8.0	1.1	1.3	10-150P	40	0.47	9.5	1.2	1.4
		50	0.14	6.0	0.9	1.0		50	0.32	8.5	1.0	1.2		50	0.49	10.0	1.1	1.3
		60	0.14	6.0	0.9	1.0		60	0.32	8.0	1.1	1.3		60	0.51	10.0	1.2	1.4
		70	0.14	6.0	0.9	1.0		70	0.32	8.0	1.1	1.3		70	0.53	10.5	1.1	1.3
180°	5-HP	40	0.10	4.4	1.0	1.2	8-HP	40	0.26	7.0	1.0	1.2	10-HP	40	0.48	9.7	1.0	1.1
		50	0.13	4.9	1.1	1.3		50	0.33	7.6	1.1	1.3		50	0.53	10.1	1.1	1.2
		60	0.16	5.4	1.3	1.5		60	0.39	8.1	1.2	1.4		60	0.57	10.4	1.1	1.3
		70	0.19	6.0	1.4	1.6		70	0.46	8.7	1.3	1.5		70	0.62	10.8	1.2	1.4
210°	5-210P	40	0.16	5.0	1.1	1.2	8-210P	40	0.34	8.0	0.9	1.0	10-210P	40	0.57	9.5	1.1	1.2
		50	0.18	5.5	1.0	1.1		50	0.38	8.0	1.0	1.1		50	0.64	10.0	1.1	1.2
		60	0.20	6.0	0.9	1.1		60	0.42	8.0	1.1	1.3		60	0.70	10.0	1.2	1.3
		70	0.21	6.0	1.0	1.1		70	0.45	8.0	1.2	1.3		70	0.75	10.0	1.2	1.4
240°	5-TTP	40	0.14	4.3	1.1	1.3	8-TTP	40	0.34	7.0	1.0	1.1	10-TTP	40	0.63	9.6	1.0	1.1
		50	0.20	4.9	1.3	1.5		50	0.43	7.8	1.1	1.2		50	0.70	9.9	1.1	1.2
		60	0.25	5.4	1.4	1.7		60	0.52	8.5	1.2	1.4		60	0.77	10.3	1.1	1.3
		70	0.31	6.0	1.6	1.8		70	0.61	9.3	1.3	1.5		70	0.84	10.6	1.2	1.4
270°	5-TQP	40	0.15	4.3	1.0	1.2	8-TQP	40	0.41	7.2	1.0	1.1	10-TQP	40	0.71	9.5	1.0	1.1
		50	0.21	4.9	1.2	1.4		50	0.48	7.9	1.1	1.2		50	0.77	9.9	1.0	1.2
		60	0.26	5.6	1.4	1.6		60	0.55	8.6	1.2	1.4		60	0.82	10.3	1.1	1.2
		70	0.32	6.2	1.5	1.7		70	0.62	9.3	1.3	1.5		70	0.88	10.7	1.1	1.3
360°	5-FP	40	0.17	4.0	1.0	1.2	8-FP	40	0.55	7.0	1.1	1.2	10-FP	40	0.95	9.6	1.0	1.1
		50	0.24	4.8	1.1	1.3		50	0.65	7.5	1.1	1.2		50	1.06	10.0	1.1	1.2
		60	0.31	5.5	1.2	1.4		60	0.74	8.0	1.1	1.3		60	1.16	10.5	1.1	1.3
		70	0.38	6.3	1.3	1.5		70	0.84	8.5	1.1	1.3		70	1.27	10.9	1.2	1.4

**Five Radii Available in Toro
(Male) & Female Threads**

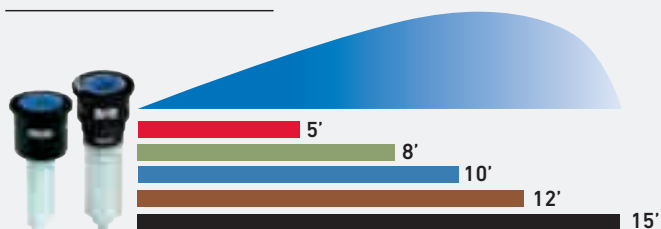

Nine Arcs, Plus Side and Center Strips Available



PERFORMANCE DATA PRESSURE COMPENSATING – PRECISION™ SERIES SPRAY NOZZLES

Arc	model # (O-XX-XX)	psi	gpm	Radius	Precip. Rate ■ (in./hr.)	Precip. Rate ▲ (in./hr.)	model # (O-XX-XX)	psi	gpm	Radius	Precip. Rate ■ (in./hr.)	Precip. Rate ▲ (in./hr.)	Arc	psi	gpm	Radius	Precip. Rate ■ (in./hr.)	Precip. Rate ▲ (in./hr.)
60°	12-60P	40	0.30	13.0	1.0	1.2	15-60P	40	0.36	14.0	1.1	1.2	4X30 SSTP	40	0.62	4x30	1.0	1.1
		50	0.30	13.0	1.0	1.2		50	0.41	15.0	1.0	1.2		50	0.65	4x30	1.0	1.2
		60	0.30	13.0	1.0	1.2		60	0.45	15.0	1.1	1.3		60	0.67	4x30	1.1	1.3
		70	0.30	13.0	1.0	1.2		70	0.48	15.0	1.2	1.4		70	0.70	4x30	1.1	1.3
90°	12-QP	40	0.34	12.0	1.0	1.2	15-QP	40	0.53	14.2	1.0	1.2	4X15 LCSP	40	0.32	4x15	1.0	1.2
		50	0.39	12.2	1.1	1.3		50	0.59	14.5	1.1	1.2		50	0.33	4x15	1.1	1.2
		60	0.43	12.5	1.2	1.3		60	0.64	14.8	1.1	1.3		60	0.34	4x15	1.1	1.3
		70	0.48	12.7	1.2	1.4		70	0.70	15.1	1.2	1.3		70	0.35	4x15	1.2	1.3
120°	12-TP	40	0.46	11.5	1.0	1.2	15-TP	40	0.72	14.3	1.0	1.2	4X15 RCSP	40	0.32	4x15	1.0	1.2
		50	0.50	11.8	1.0	1.2		50	0.77	14.8	1.0	1.2		50	0.33	4x15	1.1	1.2
		60	0.54	12.0	1.1	1.3		60	0.82	15.2	1.1	1.2		60	0.34	4x15	1.1	1.3
		70	0.58	12.3	1.1	1.3		70	0.87	15.7	1.1	1.2		70	0.35	4x15	1.2	1.3
150°	12-150P	40	0.59	12.0	1.0	1.1	15-150P	40	0.93	14.0	1.1	1.3	4X18 SSTP	40	0.36	4x18	1.0	1.1
		50	0.66	11.5	1.2	1.3		50	1.04	14.5	1.2	1.3		50	0.37	4x18	1.0	1.2
		60	0.72	12.0	1.2	1.3		60	1.14	14.5	1.3	1.5		60	0.38	4x18	1.0	1.2
		70	0.78	12.0	1.3	1.5		70	1.23	14.5	1.4	1.6		70	0.39	4x18	1.0	1.2
180°	12-HP	40	0.70	11.5	1.0	1.2	15-HP	40	1.10	14.5	1.0	1.2	4X9 LCSP	40	0.18	4x9	1.0	1.1
		50	0.75	11.8	1.0	1.2		50	1.20	14.3	1.1	1.2		50	0.19	4x9	1.1	1.2
		60	0.80	12.2	1.1	1.2		60	1.29	14.0	1.1	1.3		60	0.20	4x9	1.1	1.2
		70	0.85	12.5	1.1	1.2		70	1.39	13.8	1.2	1.3		70	0.21	4x9	1.2	1.3
210°	12-210P	40	0.86	11.0	1.2	1.4	15-210P	40	1.23	14.0	1.0	1.2	4X9 RCSP	40	0.18	4x9	1.0	1.2
		50	0.96	11.5	1.2	1.4		50	1.44	14.0	1.2	1.4		50	0.19	4x9	1.1	1.2
		60	1.05	12.0	1.2	1.4		60	1.56	14.0	1.3	1.5		60	0.20	4x9	1.1	1.2
		70	1.13	12.0	1.3	1.5		70	1.70	15.0	1.2	1.4		70	0.20	4x9	1.1	1.2
240°	12-TTP	40	0.90	11.4	1.0	1.2	15-TTP	40	1.45	14.5	1.0	1.2	4X9 RCSP	40	0.18	4x9	1.0	1.2
		50	1.03	11.5	1.1	1.3		50	1.57	14.8	1.0	1.2		50	0.19	4x9	1.1	1.2
		60	1.16	11.5	1.2	1.3		60	1.68	15.0	1.1	1.2		60	0.20	4x9	1.1	1.2
		70	1.29	11.6	1.2	1.4		70	1.80	15.3	1.1	1.3		70	0.21	4x9	1.2	1.3
270°	12-TQP	40	1.05	11.4	1.0	1.2	15-TQP	40	1.60	14.0	0.9	1.0	4X9 RCSP	40	0.18	4x9	1.0	1.2
		50	1.14	11.7	1.0	1.2		50	1.70	14.4	1.0	1.1		50	0.19	4x9	1.1	1.2
		60	1.23	12.0	1.1	1.3		60	1.80	14.8	1.0	1.2		60	0.20	4x9	1.1	1.2
		70	1.32	12.3	1.1	1.3		70	1.90	15.1	1.1	1.2		70	0.20	4x9	1.1	1.2
360°	12-FP	40	1.35	11.5	1.0	1.1	15-FP	40	2.20	14.5	1.0	1.2	4X9 RCSP	40	0.18	4x9	1.0	1.2
		50	1.49	11.8	1.0	1.2		50	2.36	14.8	1.0	1.2		50	0.19	4x9	1.1	1.2
		60	1.63	12.2	1.1	1.3		60	2.52	15.1	1.1	1.2		60	0.20	4x9	1.1	1.2
		70	1.77	12.5	1.1	1.3		70	2.68	15.4	1.1	1.3		70	0.21	4x9	1.2	1.3



PERFORMANCE DATA – PRECISION™ SERIES SPRAY NOZZLES

Arc	model # (O-XX-XX)	psi	gpm	Radius	Precip. Rate	Precip. Rate	model # (O-XX-XX)	psi	gpm	Radius	Precip. Rate	Precip. Rate	model # (O-XX-XX)	psi	gpm	Radius	Precip. Rate	Precip. Rate
					■ (in./hr.)	▲ (in./hr.)					■ (in./hr.)	▲ (in./hr.)					■ (in./hr.)	▲ (in./hr.)
60°	5-60	20	0.04	4.7	1.0	1.2	8-60	20	0.10	7.6	1.0	1.2	10-60	20	0.16	9.5	1.0	1.2
		30	0.04	5.0	1.0	1.2		30	0.11	8.0	1.0	1.1		30	0.17	10.0	1.0	1.1
		40	0.04	5.0	1.0	1.2		40	0.12	8.1	1.1	1.2		40	0.18	10.0	1.0	1.2
		50	0.05	5.3	1.0	1.1		50	0.13	8.3	1.1	1.3		50	0.19	10.0	1.1	1.3
90°	5-Q	20	0.06	4.6	1.0	1.2	8-Q	20	0.14	7.0	1.1	1.3	10-Q	20	0.26	9.5	1.0	1.1
		30	0.06	5.0	1.0	1.1		30	0.17	8.0	1.0	1.1		30	0.23	10.0	1.0	1.2
		40	0.07	5.0	1.0	1.2		40	0.18	8.2	1.0	1.2		40	0.28	1.2	1.0	1.2
		50	0.07	5.0	1.0	1.2		50	0.18	8.4	1.0	1.1		50	0.28	1.3	1.0	1.2
120°	5-T	20	0.07	4.4	1.0	1.2	8-T	20	0.20	7.6	1.0	1.2	10-T	20	0.31	9.5	1.0	1.1
		30	0.09	5.0	1.0	1.2		30	0.22	8.0	1.0	1.1		30	0.34	10.0	1.0	1.1
		40	0.09	5.2	1.0	1.2		40	0.23	8.2	1.0	1.1		40	0.36	10.0	1.0	1.2
		50	0.10	5.4	1.0	1.1		50	0.24	8.3	1.0	1.1		50	0.37	10.0	1.1	1.2
150°	5-150	20	0.07	4.0	1.0	1.2	8-150	20	0.25	7.5	1.0	1.2	10-150	20	0.41	9.8	1.0	1.1
		30	0.11	5.0	1.0	1.2		30	0.27	8.0	1.0	1.1		30	0.43	10.0	1.0	1.1
		40	0.12	5.2	1.0	1.2		40	0.28	8.1	1.0	1.1		40	0.44	10.2	1.0	1.1
		50	0.13	5.4	1.0	1.2		50	0.29	8.2	1.0	1.2		50	0.46	10.4	1.0	1.1
180°	5-H	20	0.10	4.4	1.0	1.2	8-H	20	0.26	7.0	1.0	1.2	10-H	20	0.48	9.7	1.0	1.1
		30	0.13	5.0	1.0	1.2		30	0.33	8.0	1.0	1.1		30	0.51	10.0	1.0	1.1
		40	0.14	5.1	1.0	1.2		40	0.34	8.0	1.0	1.2		40	0.55	10.3	1.0	1.2
		50	0.14	5.2	1.0	1.1		50	0.34	8.0	1.0	1.2		50	0.56	10.4	1.0	1.2
210°	5-210	20	0.10	4.4	1.0	1.2	8-210	20	0.33	7.6	1.1	1.3	10-210	20	0.56	9.8	1.1	1.3
		30	0.15	5.2	1.1	1.2		30	0.36	8.0	1.1	1.3		30	0.58	10.0	1.1	1.3
		40	0.16	5.3	1.1	1.3		40	0.37	8.1	1.1	1.3		40	0.60	10.4	1.1	1.2
		50	0.17	5.5	1.1	1.3		50	0.38	8.2	1.1	1.3		50	0.62	10.5	1.1	1.3
240°	5-TT	20	0.14	4.3	1.1	1.3	8-TT	20	0.34	7.0	1.0	1.2	10-TT	20	0.63	9.6	1.0	1.1
		30	0.17	5.0	1.0	1.1		30	0.44	8.0	1.0	1.1		30	0.69	10.0	1.0	1.2
		40	0.19	5.0	1.1	1.2		40	0.46	8.0	1.0	1.2		40	0.73	10.3	1.0	1.1
		50	0.19	5.0	1.1	1.3		50	0.46	8.0	1.0	1.2		50	0.74	10.4	1.0	1.1
270°	5-TQ	20	0.15	4.3	1.0	1.2	8-TQ	20	0.41	7.2	1.0	1.1	10-TQ	20	0.71	9.5	1.0	1.1
		30	0.20	5.0	1.0	1.2		30	0.49	8.0	1.1	1.1		30	0.79	10.0	1.0	1.1
		40	0.21	5.0	1.1	1.2		40	0.54	8.0	1.1	1.2		40	0.84	10.3	1.0	1.1
		50	0.22	5.0	1.1	1.3		50	0.55	8.0	1.1	1.2		50	0.86	10.4	1.0	1.1
360°	5-F	20	0.17	4.0	1.0	1.2	8-F	20	0.55	7.0	1.1	1.2	10-F	20	0.95	9.6	1.0	1.1
		30	0.26	5.0	1.0	1.2		30	0.66	8.0	1.0	1.1		30	1.03	10.0	1.0	1.1
		40	0.26	5.0	1.0	1.2		40	0.68	8.0	1.0	1.2		40	1.08	10.3	1.0	1.1
		50	0.26	5.0	1.0	1.2		50	0.71	8.0	1.1	1.2		50	1.12	10.4	1.0	1.2

**Five Radii Available in Toro
(Male) & Female Threads**

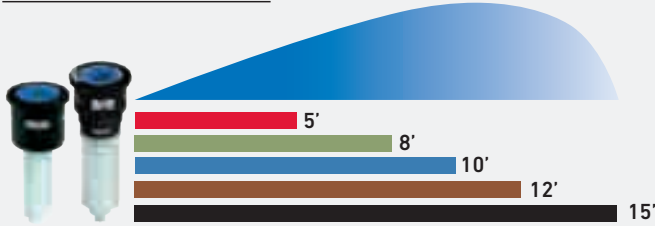

Nine Arcs, Plus Side and Center Strips Available

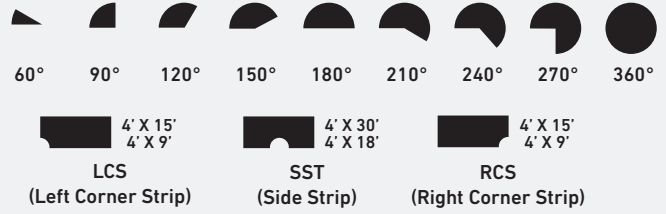

PERFORMANCE DATA – PRECISION™ SERIES SPRAY NOZZLES

Arc	model # (O-XX-XX)	psi	gpm	Radius	Precip. Rate ■ (in./hr.)	Precip. Rate ▲ (in./hr.)	model # (O-XX-XX)	psi	gpm	Radius	Precip. Rate ■ (in./hr.)	Precip. Rate ▲ (in./hr.)	Arc	psi	gpm	Radius	Precip. Rate ■ (in./hr.)	Precip. Rate ▲ (in./hr.)
60°	12-60	20	0.24	11.5	1.0	1.2	15-60	20	0.35	14.0	1.0	1.2	4X30 SST	20	0.62	4x28	1.0	1.1
		30	0.25	12.0	1.0	1.2		30	0.39	15.0	1.0	1.2		30	0.66	4x30	1.1	1.2
		40	0.26	12.1	1.0	1.2		40	0.40	15.1	1.0	1.2		40	0.67	4x30	1.1	1.2
		50	0.28	12.2	1.1	1.3		50	0.42	15.3	1.0	1.2		50	0.68	4x30	1.1	1.3
90°	12-Q	20	0.34	12.0	1.0	1.2	15-Q	20	0.53	14.2	1.0	1.2	4X15 LCS	20	0.32	4x15	1.0	1.2
		30	0.37	12.1	1.0	1.1		30	0.58	15.0	1.0	1.1		30	0.33	4x15	1.1	1.2
		40	0.39	11.4	1.0	1.2		40	0.60	15.1	1.0	1.2		40	0.34	4x15	1.1	1.2
		50	0.39	12.0	1.0	1.1		50	0.61	15.3	1.0	1.2		50	0.34	4x15	1.1	1.3
120°	12-T	20	0.46	11.5	1.0	1.2	15-T	20	0.72	14.3	1.0	1.2	4X15 RCS	20	0.32	4x15	1.0	1.2
		30	0.49	12.0	1.0	1.1		30	0.77	15.0	1.0	1.1		30	0.33	4x15	1.1	1.2
		40	0.51	12.2	1.0	1.1		40	0.81	15.3	1.0	1.2		40	0.34	4x15	1.1	1.3
		50	0.52	12.3	1.0	1.1		50	0.82	15.4	1.0	1.2		50	0.34	4x15	1.1	1.3
150°	12-150	20	0.60	11.6	1.0	1.2	15-150	20	0.92	14.7	1.0	1.2	4X18 SST	20	0.36	4x18	1.0	1.1
		30	0.62	12.0	1.0	1.1		30	0.96	15.0	1.0	1.2		30	0.37	4x18	1.0	1.1
		40	0.63	12.2	1.0	1.1		40	1.00	15.2	1.0	1.2		40	0.38	4x18	1.0	1.2
		50	0.64	12.3	1.0	1.1		50	1.10	15.3	1.1	1.3		50	0.38	4x18	1.0	1.2
180°	12-H	20	0.70	11.5	1.0	1.2	15-H	20	1.10	14.5	1.0	1.2	4X9 LCS	20	0.18	4x9	1.0	1.2
		30	0.74	12.0	1.0	1.1		30	1.16	15.0	1.0	1.1		30	0.19	4x9	1.0	1.2
		40	0.79	12.3	1.0	1.2		40	1.25	15.4	1.0	1.2		40	0.2	4x9	1.1	1.2
		50	0.80	12.4	1.0	1.2		50	1.28	15.5	1.0	1.2		50	0.2	4x9	1.1	1.1
210°	12-210	20	0.76	11.6	1.1	1.3	15-210	20	1.15	14.5	1.1	1.2	4X9 RCS	20	0.18	4x9	1.0	1.2
		30	0.82	12.0	1.1	1.3		30	1.20	15.0	1.0	1.2		30	0.19	4x9	1.0	1.2
		40	0.84	12.3	1.1	1.2		40	1.30	15.5	1.0	1.2		40	0.2	4x9	1.1	1.2
		50	0.85	12.4	1.1	1.2		50	1.40	15.6	1.1	1.3		50	0.2	4x9	1.1	1.2
240°	12-TT	20	0.90	11.4	1.0	1.2	15-TT	20	1.45	14.5	1.0	1.2	4X9 RCS	20	0.18	4x9	1.0	1.2
		30	0.99	12.0	1.0	1.1		30	1.54	15.0	1.0	1.1		30	0.19	4x9	1.0	1.2
		40	1.04	12.3	1.0	1.1		40	1.58	15.2	1.0	1.1		40	0.2	4x9	1.1	1.2
		50	1.05	12.4	1.0	1.1		50	1.61	15.3	1.0	1.1		50	0.2	4x9	1.1	1.2
270°	12-TQ	20	1.05	11.4	1.0	1.2	15-TQ	20	1.72	14.5	1.0	1.2	4X9 RCS	20	0.18	4x9	1.0	1.2
		30	1.15	12.0	1.0	1.2		30	1.78	15.0	1.0	1.1		30	0.19	4x9	1.0	1.2
		40	1.19	12.2	1.0	1.2		40	1.82	15.0	1.0	1.2		40	0.2	4x9	1.1	1.2
		50	1.22	12.3	1.0	1.2		50	1.90	15.3	1.0	1.2		50	0.2	4x9	1.1	1.2
360°	12-F	20	1.35	11.5	1.0	1.1	15-F	20	2.20	14.5	1.0	1.2	4X9 RCS	20	0.18	4x9	1.0	1.2
		30	1.48	12.0	1.0	1.1		30	2.31	15.0	1.0	1.1		30	0.19	4x9	1.0	1.2
		40	1.59	12.4	1.0	1.1		40	2.35	15.2	1.0	1.1		40	0.2	4x9	1.1	1.2
		50	1.60	12.5	1.0	1.1		50	2.40	15.3	1.0	1.1		50	0.2	4x9	1.1	1.2



Subsurface irrigation provides water directly to the root zone to ensure maximum utilization, minimizing waste from evaporation and surface runoff. These kits provide everything you need to set up a tee box, bunker system, lake perimeter or anywhere else a low volume subsurface system applies.

FEATURES & BENEFITS

Pressure Compensating Emitters

Every emitter is equipped with a pressure compensating device to ensure the optimum operating pressure and precise flow rates are distributed from each point throughout the zone regardless of distance or elevation change.

DL2000™ Tubing with ROOTGUARD® Root Inhibitor

Each emitter is impregnated with a powerful root inhibitor that prevents roots from entering and clogging the emitter opening. This ensures even water distribution uniformity and maximum efficiency from each point of emission.

Filtration and Pressure Regulation Provided

Each kit includes a Y filter with 150 mesh/100 micron element to prevent debris contamination and a 25 psi fixed regulator to eliminate damage from high pressure spikes.

Flush Valve

Provides a momentary high velocity in the tubing to move debris out of the piping system to eliminate emitter clogging every time the zone is activated.



Specifying Information—Subsurface Irrigation

Model Number	Description
SSDS-LF-500	DL2000 500' Drip System (Bunker)—Low Flow
SSDS-HF-1000	DL2000 1000' Drip System (Bunker)—High Flow
RGP-212-05	DL2000 500' (Roll, 0.5 GPH), 12" Spacing

Example: A 500' DL2000 Drip System, would be specified as: **SSDS-LF-500**



Specifying Information—Golf Zone Kits

Model	Description
GZK-25-LF-DCL	P220G valve with DC latching solenoid, 25 psi reg, low flow .1-8 gpm, 150 mesh SS filter
GZK-25-LF-SG	P220G valve with SPIKE GUARD™ solenoid, 25 psi reg, low flow .1-8 gpm, 150 mesh SS filter
GZK-25-MF-DCL	P220G valve with DC latching solenoid, 25 psi reg, medium flow 2-20 gpm, 150 mesh SS filter
GZK-25-MF-SG	P220G valve with SPIKE GUARD solenoid, 25 psi reg, medium flow 2-20 gpm, 150 mesh SS filter
GZK-40-MF-DCL	P220G valve with DC latching solenoid, 40 psi reg, medium flow 2-20 gpm, 150 mesh SS filter
GZK-40-MF-SG	P220G valve with SPIKE GUARD solenoid, 40 psi reg, medium flow 2-20 gpm, 150 mesh SS filter



FTT16-10 FEE16-10 FCC16-10 FAM16-10



FTF16-10 FJA16-10

Specifying Information—5/8" Loc-Eze™ Fittings

Model	Description
FTT16-10	Loc-Eze Tee (Bag of 10)
FEE16-10	Loc-Eze Elbow (Bag of 10)
FCC16-10	Loc-Eze Coupling (Bag of 10)
FAM16-10	Loc-Eze x 1/2" MPT Male Adapter (Bag of 10)
FTF16-10	Loc-Eze x 1/2" FPT Tee (Bag of 10)
FJA16-10	Loc-Eze x 3/4" MHT without Cap (Bag of 10)

Note: 5/8" EHW1645 is an equivalent hose size to DL2000 Dripline.



YD-500-34Z-10 FCH-H-FHT-10 FJQ16-10 SS6-50G

Specifying Information Accessories

Model	Description
YD-500-34Z-10	Air Vent — 1/2" MIPT Air Release & Vacuum Relief Valve (Bag of 10)
FCH-H-FHT-10	Flush Valve — 3/4" FHT (Hose Thread), 0.8 gpm, 2 psi Sealing Pressure (Bag of 10)
FJQ16-10	5/8" Figure-eight End Clamp (Bag of 10)
SS6-50G	3/4" Steel Soil Staple to Hold Tubing in Place (Bag of 50)



REG075251-8 REG100252-20 REG100402-20

Specifying Information Accessories

Model	Description
REG075251-8	Pressure regulator, 3/4" 25 psi, .1-8 gpm
REG100252-20	Pressure regulator, 1" 25 psi, 2-20 gpm
REG100402-20	Pressure regulator, 1" 40 psi, 2-20 gpm

SPECIFICATIONS

Drip System Specifications—Bunkers Only

- Flow range:
 - Low flow: 0.1 to 8.0 gpm
 - High flow: 2.0 to 20.0 gpm
- DL2000™ range:
 - Low flow: 12' to 1000'
 - High flow: 250' to 2500'
- Pressure compensating emitter: 0.5 gph
- Emitter spacing – 12"
- DL2000™ maximum run length: 360'
- Application rate (12" x 12" spacing): 0.85" per hour

Benefits On Bunkers

- Uniformly applies water to areas such as fingers
- Minimizes runoff
- Eliminates overspray into bunker keeping sand dry
- Cycle/soak allows for application on steep slopes
- Reduces bunker cave-ins
- Saves time, labor and money by eliminating the need for hand-watering

Benefits On Tees

- Applies water directly to the root zone allowing turf to stay dry
- Water is applied precisely to the tee box without watering the surrounding area

Bunker System Components

- DL2000™ subsurface dripline
- Drip Zone Valve Kit – includes control valve, pressure regulator, Y-filter and manual ball valve
- Air Vent Assembly – pre-assembled and ready to install (bunker only)
- Required inlet/outlet fittings
- Flush Assembly Fittings (8 gpm) 2 psi sealing flush valve (bunker only)
- Installation Fittings:
 - Includes Loc-Eze tees, couplings, elbows and end clamps
 - 10' of Blue Stripe® polyethylene tubing
 - Soil staples for secure tubing placement
- Pipe thread tap

Warranty

- Two years



ALFS75150-SG ALFS10150-SG AMP0004-1SG

Specifying Information Accessories

Model	Description
ALFS75150-SG	Filter, 3/4", 150 mesh stainless screen
ALFS10150-SG	Filter, 1", 150 mesh stainless screen
AMP0004-1SG	Filter Replacement, 150 mesh stainless screen



Toro offers a full line of swing joints that cover all Golf sprinkler thread types. Swing joints provide the flexibility to align the sprinkler to proper grade and level positioning to ensure optimum water use through maximum nozzle distribution uniformity.

FEATURES & BENEFITS

Minimize Friction Loss

1", 1¼" and 1½" models are available to cover flows exceeding 80 gpm, and minimize friction loss to ensure optimum pressure is available at each sprinkler.

Standard 2X90 And Ultra 4X90 Outlet Configurations

The standard 2x90 models provide two 90's at the outlet for alignment in two directions and the Ultra 4x90 models provide four 90's at the outlet for maximum alignment flexibility in four directions.

Saddle And Glue Tee Models

Glue tees for PVC piping applications and saddle tees for HDPE and PVC piping applications. Both tee styles are available with 1", 1¼" and 1½" double o-ring sealing outlets.

Quick Coupler Models

All swing joint styles are available with a quick coupler outlet that includes both an anti-rotation and position stabilizing feature to ensure the quick coupling valve stays secure during key installation and removal.





1 1/4" Female ACME x 1" Male ACME Adapter
Allows you to upgrade existing Rain Bird® Eagle™* 700 1 1/4" sprinklers to any Toro 800S or DT Series Sprinkler. P/N TA36-132

*Rain Bird is a registered trademark of Rain Bird Corporation. Eagle is a trademark of Rain Bird Corporation.

Durability And Reliability
Constructed from schedule 80 PVC for durability and provides double o-ring seals on all swing fittings to ensure a lifetime of reliability and leak free performance.

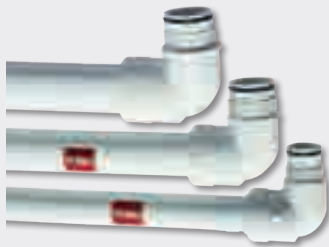

1", 1 1/4" and 1 1/2"



Standard 2x90 and Ultra 4x90



Quick Coupler

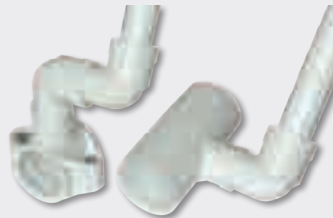

Glue tees, Saddle tees

Warranty

- Five years
- Toro Golf sprinkler warranty extended to 5 years when purchased and installed with a Toro Swing Joint

Additional Features

- ✓ Schedule 80 PVC construction
- ✓ Double o-ring swivel joints
- ✓ Low friction loss characteristics
- ✓ 315 psi pressure rating
- ✓ 800 psi burst pressure safety rating
- ✓ Standard models with 2x90 outlet configuration
- ✓ Ultra models with 4x90 outlet for maximum alignment flexibility
- ✓ 3 inlet fittings styles: ACME, male thread and 4" spigot
- ✓ 2 outlet fitting styles: ACME and male thread
- ✓ 8", 12" and 18" lay lengths
- ✓ Saddle Tee models: 2" tee with 1", 1 1/4" or 1 1/2" outlet
- ✓ Glue Tee models: 2" tee with 1", 1 1/4" or 1 1/2" outlet
- ✓ Glue 90° models: 2" 90° with 1", 1 1/4" or 1 1/2" outlet
- ✓ Quick coupler models with Dura-lock anti-rotation feature
- ✓ Compatible with all brands of service and saddle tees

Toro Tool Tip:

Use a 1 1/4" hole saw for the 1" Saddle Tee.

Use a 1 1/2" hole saw for the 1 1/4" and 1 1/2" Saddles.



Specifying Information—Toro Swing Joints

TSJ-XXXX-XX-XX-X-XXX*

Description	Inlet Size	Inlet Type	Size	Length	Number of Elbows	Outlet Size	Outlet Type
TSJ	XX	XX	XX	XX	X	XX	X
TSJ—Toro Swing Joint	10—1" 12—1 1/4" 15—1 1/2"	M—MIPT (male pipe thread) S—4" Spigot A—ACME Thread GE—Glue Elbow GT—Glue Tee ST—Saddle Tee AF—Aqua Fuse	Blank—same as inlet size 10—1" 12—1 1/4" 15—1 1/2"	8—8" Lay Length 12—12" Lay Length 18—18" Lay Length	3—Standard Unibody for Side Pipe Mount 4—Standard Unibody for Top Pipe Mount 5—Ultra Unibody for Side Pipe Mount Q* 6—Ultra Unibody for Top Pipe Mount	10—1" 15—1 1/2"	M—MIPT (Male pipe thread) A—ACME thread QC—Quick Coupler
Example: A Toro 1 1/2" Swing Joint with an ACME inlet, 12" lay length, 3 elbows (standard uni-body) and 1 1/4" ACME outlet fitting would be specified as: TSJ-15A-12-3-15A							

* Use QC to designate QC when the inlet size and size are the same (TSJ-10A-12-3-10QC) use Q when the inlet size and size are different (TSJ-15A10-12-3-10Q)



995-15 Selector Tool

- All electric golf sprinklers
- Allows user to manually turn the sprinkler "ON", turn or leave it "OFF" or place it into the "AUTO" position awaiting a command from the controller



995-83 Multi Purpose Tool

- All Golf sprinklers
- Riser pull up for INFINITY®, FLEX800, DT and 800S Series
- Riser screen removal on all models
- Upper snap ring remover on all models



995-82 Arc Adjustment Tool, 3/32" Allen Wrench

- 765,785,865S,885S Arc adjustment of the part circle drives
- INFINITY®, FLEX800, DT and 800S Series. Adjustment of the radius reduction screw



Riser Removal Tools

- 995-85 drive assembly extraction tool 730, 760, 780, 860S,880S
- Threads onto the drive output shaft and allows removal of the drive from the body



Valve Removal Tools

- 995-08 All 1" golf models and 640
- 995-09 All 1.5" models and 690



Nut Drivers

- **995-105** 5/16" INFINITY®, FLEX800, DT and 800S Series TruJectory adjustment on INFX5-6/ FLX5-6 models
- Inner, intermediate and back nozzle removal on all DT and 800S models
- **995-99** 5/8"
- Dual trajectory selection
- Main nozzle removal on all models
- **995-79** 7/16" 834S/854S pre August 2007
- Inner, intermediate and back nozzle removal
- 650/760/780/860S/880S Inner, intermediate and back nozzle removal
- **995-81** 9/16" 760/780 Series Main nozzle removal
- **995-80** 1/2" 760/780/860S/880S Nozzle base jam nut removal
- **995-52** 1/4" 660/680 Drive plate nut removal
- **995-53** 3/8" 660/680 Cap nut removal



Valve Insertion Tools

- Aligns and Installs Valve into the Body**
- 995-35 640 VIH body
- 995-76 All 1" golf models (Except INFINITY®)
- 995-101 All 1.5" golf models (Except INFINITY®)
- 995-12 690 body
- 118-1843 INFINITY® 1.5" models
- 118-1844 INFINITY® 1" models



995-100 Valve Snap Ring Pliers with Screen Remover

- All Golf sprinklers lower snap ring removal on all models
- Rock screen removal on all INFINITY®, FLEX800, DT and 800S Series
- Valve removal on all models



Riser Hold Up Tools

- Allow for Nozzle Servicing**
- 118-0954 Riser hold up tool, red
- 995-55 All 700 models
- 995-102 Universal hold up tool, all 700, 800S, DT, INFINITY® and FLEX800 models



PRNTOOL

- Adjustment tool for Precision™ Series Rotating Nozzles
- Adjusts arc and radius



PNOZZTOOL

- Riser Pull Up Tool**
- Used on 590GF sprays



102-6527

- T7 Rotor adjustment tool



118-0954

- Riser hold up tool





Valve Comparison Chart

Model		220G Brass Series	P220G Series	P220GS Series Scrubber
Catalog Pages		94-95	96-97	96-97
Flow Range		5.0-180 gpm	5.0-180 gpm	5.0-150 gpm
Operating Pressure		10-220 psi max	10-220 psi max	10-220 psi max
Conditions	Electrically Activated Systems	X	X	X
	Pressure Regulated Systems	X	X	X
	Effluent Water	X	X	X
Sizes	1"	X	X	X
	1 1/4"	X		
	1 1/2"	X	X	X
	2"	X	X	X
Configurations	Inline/Globe	X	X	X
	Angle/Globe		X	X
Inlet/Outlet	Threaded (Female)	X	X	X
Features	Manual Flow Control	X	X	X
	Pressure Regulation	X	X	X
	Internal Manual Bleed	X	X	X
	External Manual Bleed (Flush)	X	X	X
Body Construction	Glass-filled Nylon		X	X
	Brass	X		
Warranty		5 Years	5 Years	5 Years



Heavy-duty brass construction for superior performance under the harshest conditions. Toro 220G Brass Series valves are rugged and reliable, and offer dependable performance within the toughest of situations and settings.

FEATURES & BENEFITS

Leading Lighting Protection

A lightning rating that exceeds 20,000 volts – nearly three times the protection of competing products.

Dirty Water Ready

A stainless steel 120-mesh filter enables dependable valve operation in dirty and reclaimed water applications with a greatly reduced likelihood of clogging or failure to close.

Spike Guard™ Solenoid

Reduces wire size requirements and allows 2X as many valves to run simultaneously on a transformer, all while lowering power consumption and related costs.

EZReg® Pressure Regulator compatible

Available in two fully-adjustable models, Toro EZReg Pressure Regulators allow the consistent regulation of pressure within a zone, ensuring optimal operation of all downstream sprinklers. EZReg Pressure Regulators thread directly to the valve bonnet – no special adaptor required and no need to remove the solenoid. The desired pressure can be set fast and with a high level of accuracy thanks to an easy-to-read turn dial design.



220G-27-06



220G-27-04



Dirty Water Resistance

The 120 mesh stainless steel filter screen is positioned on the supply side of the water stream. It is constantly flushed by the flow, enabling the use of very dirty water without clogging. Stainless steel construction of both the filter screen and the valve solenoid seat ensures long component life in all types of water and pressures.

SPECIFICATIONS

Operational

- Flow Range:
 - 1" model: 1 to 40 gpm
 - 1 1/4" model: 20 to 100 gpm
 - 1 1/2" model: 20 to 120 gpm
 - 2" model: 30 to 170 gpm
- Operating Pressure: 10 to 220 psi
- Pressure Regulating:
 - Outlet (EZR-100): 5 to 100 psi ± 3
 - Minimum flow requirement of 5 gpm
- Minimum Pressure Differential (between inlet and outlet) for Pressure Regulation:
 - 1", 1 1/4", and 1 1/2" models: 10 psi
 - 2" models: 20 psi
- Burst Pressure Safety Rating: 750 psi
- Body Styles:
 - Globe orientation – 1", 1 1/4", 1 1/2", and 2" models, female threads

Dimensions

- 1" model: 5 1/4" H x 5" W
- 1 1/4" model: 6 1/2" H x 6" W
- 1 1/2" model: 6 1/2" H x 6" W
- 2" model: 7 1/2" H x 7" W

Warranty

- Five years

220G BRASS SERIES MODEL LIST

Model	Description
PRESSURE REGULATED WITH EZREG®	
220G-27-04	1" Inlet/Outlet; Globe
220G-27-05	1 1/4" Inlet/Outlet; Globe
220G-27-06	1 1/2" Inlet/Outlet; Globe
220G-27-08	2" Inlet/Outlet; Globe

Additional Features

- ✓ EZReg® Pressure Regulator can be installed as a service kit without having to drain the main line
- ✓ Pressure regulates in electric or manual modes, and is serviceable under pressure
- ✓ Built-in Schrader-type valve is standard on all models for fast downstream pressure verification
- ✓ Manual Flow Control; adjustable to full shut-off
- ✓ Robust, double-beaded, fabric-reinforced rubber diaphragm
- ✓ Commercial-grade 316 Stainless Steel stem for maximum corrosion resistance

220G BRASS SERIES PRESSURE LOSS DATA

Model	Type	Gallons Per Minute																		
		5	10	15	20	30	40	50	60	70	80	100	120	150	170	180	200	250	300	350
1"	Electric	1.8	2.0	2.2	3.1	5.1	7.8													
1 1/4"	Electric				1.9	2.5	2.7	3.5	4.1	5.6										
1 1/2"	Electric				2.2	2.5	2.8	3.1	3.8	5.0	6.6									
2"	Electric					3.1	3.2	2.9	3.0	3.3	3.4	4.5	6.6	10.1	13.5	14.9				

Notes: For optimal performance when designing a system, it is recommended that total Pressure Loss be calculated to ensure sufficient downstream pressure. For optimum pressure regulation performance, size regulating valves towards the higher flow ranges. Flow rates are recommended not to exceed 5 psi loss.

Specifying Information—220G Brass Series

220G-27-0XXX			
Type	Body Style	Size	Optional
220G	27	0X	XX
220G—220G Brass Series Valve	27—NPT, Pressure-regulated (5–100 psi)	4—1" 5—1 1/4" 6—1 1/2" 8—2"	DL—Latching Solenoid for 2-wire LSM Systems E—Effluent

Example: A 1" NPT pressure-regulated, 220G Brass Series Valve with 60 Hz solenoid, would be specified as: **220G-27-04**



The P220G and P220GS Series provide a full family of plastic valves that can deliver the water to meet the challenging needs of today's courses. With precise pressure regulation these valves deliver the optimum pressure and flow requirements to every sprinkler on the zone ensuring maximum uniformity of the water to the turf.

FEATURES & BENEFITS

EZReg® Pressure Regulating System

Can be adjusted from 5-100 psi to deliver the optimum pressure for every need.

Spike Guard™ Solenoid

With its 20,000 volt lightning rating, it virtually eliminates the need for solenoid replacements in high lightning environments.

Internal Manual Bleed

Ensures the optimum pressure of the system even when being operated manually.

Double-beaded Fabric Reinforced Diaphragm

Provides superior performance and extended life without tearing in high-pressure golf applications.



Self Cleaning Metering Pin
A self-cleaning feature that operates two times during every valve cycle ensuring smooth positive opening and closing.



Additional Features

- ✓ Glass-filled nylon and stainless steel construction
- ✓ Internal and External bleed
- ✓ No external tubing
- ✓ Standard, built-in Schrader-type valve for downstream pressure verification
- ✓ Flow control independent of solenoid
- ✓ Self-aligning bonnet to ensure correct installation
- ✓ Self-cleaning, stainless steel metering rod
- ✓ Low-flow capability down to 5 gpm
- ✓ Low-power requirement for longer wire runs

VALVE WIRE SIZING CHART

Maximum One-way Distance (in ft.) Between Controller and Valve Using Spike-Guard™ Solenoid*

Ground Wire	Control Wire						
	18	16	14	12	10	8	6
18	2040	2520	2940	3280	3540	3720	3860
16	2520	3260	4000	4660	5220	5620	5920
14	2940	4000	5180	6360	7420	8300	8960
12	3280	4660	6360	8240	10100	11800	13180
10	3540	5220	7420	10100	13180	16060	18770
8	3720	5260	8300	11800	16060	20800	25540
6	3860	5960	8960	13180	18700	25540	33080

* Solenoid Model: 24 V ac
Pressure: 150 psi
Voltage Drop: 4 V
Minimum Operating Voltage: 20 V
Amperage (peak) 0.12 A



"Scrubber" Turbine

Filter Surface

ACT™ System

Toro's patented technology employs a constantly rotating turbine to clean the metering/filtration area. This ensures that dirt, algae and particulates do not impede valve performance.

SPECIFICATIONS

Operational

- Flow Range:
 - 1" – 5 to 40 gpm
 - 1½" – 30 to 110 gpm
 - 2" – 80 to 180 gpm
- Operating Pressure (220 psi maximum pressure rating):
 - 1" – 1½" – 10 to 220 psi
 - 2" – 20 to 220 psi
- EZReg® Pressure regulating:
 - Outlet: 5 to 100 psi ± 3 psi
- Inlet: 10 to 220 psi
- Minimum pressure differential (between inlet and outlet) for pressure regulation: 10 psi
- Burst pressure safety rating: 750 psi
- Body styles:
 - Globe/Angle – 1", 1½", 2" female threads
- Spike Guard™ Solenoid: 24 VAC (50/60 Hz) Standard
 - Inrush: 60 Hz: 0.12 amps
 - Holding: 60 Hz: 0.1 amps
- DC latching – momentary low voltage pulse

Dimensions

- 1" – 6¾" H x 3⅝" W
- 1½" – 7¼" H x 3⅝" W
- 2" – 9½" H x 6⅛" W

Warranty

- Five years

P220G SERIES FRICTION LOSS DATA*

Size	Configuration	gpm Flow																	
		5	10	20	30	40	50	60	70	80	90	100	110	120	130	140	150	180	
1"	Globe	4.00	4.20	3.20	4.10	7.20													
	Angle	4.00	4.20	3.10	2.70	4.80													
1½"	Globe				1.60	2.30	3.60	5.20	7.00	9.20	11.20	13.60	16.40						
	Angle				1.30	1.60	2.80	4.00	5.50	7.10	8.90	10.90	13.50						
2"	Globe									2.10	2.70	3.30	4.00	4.80	5.60	6.50	7.50	8.70	
	Angle									1.20	1.60	2.00	2.40	2.80	3.30	3.90	4.40	5.20	

P220GS SERIES FRICTION LOSS DATA*

Size	Configuration	gpm Flow																	
		5	10	20	30	40	50	60	70	80	90	100	110	120	130	140	150		
1"	Globe	4.63	4.74	3.10	6.05	10.75													
	Angle	4.14	4.64	2.54	5.53	9.46													
1½"	Globe			1.14	1.56	2.85	4.36	6.28	8.57	11.20	14.03	17.20	20.46						
	Angle			0.95	1.51	2.28	3.69	5.29	6.97	9.26	11.80	14.60	17.40						
2"	Globe									3.57	4.62	5.33	6.80	8.20	9.02	10.46	11.61		
	Angle									2.79	3.50	4.41	5.62	6.39	7.35	8.81	9.37		

*Note: For optimum performance when designing a system, be sure to calculate total friction loss to ensure sufficient downstream pressure. For optimum regulation performance, size regulating valves toward the higher flow ranges. Flow rates are recommended not to exceed 5 psi loss.

Specifying Information—P220G and P220GS Series

P220GS-27-0X-XXX			
Type	Body Style	Size	Optional
P220GS	27	0X	XXX
P220G—P220G Series Plastic Valve P220GS—P220GS Series Plastic Scrubber Valve	27—NPT, Pressure-regulated (5–100 psi)	4–1" 6–1½" 8–2"	E—Effluent DL—DC Latching Solenoid for LSM System DLE—DC Latching Solenoid for LSM System, Effluent
Example: A 1" P220G Series plastic electric, pressure-regulating valve with a 60 Hz solenoid, would be specified as: P220G-27-04			



Valve boxes are used for practical, aesthetic and security reasons wherever valves or off-fairway GDC modules need to be installed below grade but remain accessible for monitoring or service. Toro offers a full line of valve boxes that will fit valves up to 4" and 1-, 2- and 4- station LSM modules.

FEATURES & BENEFITS

T-lip Lid Design

The T-lip lid design keeps dirt out to prevent jamming and provides improved grip for lid removal and easy access to the equipment inside. The secure snap fit and bolt retention ensure that only authorized personnel will have access.

Wide Range Of Sizes

Toro offers a wide range of round and rectangular boxes to meet every need. 6", 7" and 10" round; and 12" x 17" and 15" x 21" rectangular in both 12" standard depth and 6" shallow depth. With the reverse stack capability and rectangular 6" extensions tackling deeper installations can be easily accomplished.

Variety of Colors

Toro valve boxes and covers come in a wide variety of colors to blend into the surrounding environment or to identify specific applications. Green for grass, tan for sand and purple for non-potable water applications. Black and brown to blend in with a variety of soils and mulches and gray for electrical applications.

Durable Construction

Valve boxes are constructed of H.D.P.E. (High-Density Polyethylene) with heavy-duty wall sections designed to provide a secure enclosure to protect your equipment investment.



Reverse Stack
Allows for deeper installations in an initial 12" then 12" increments.



Rectangular Extension Boxes
Rectangular extensions allow for deeper installation in 6" increments

Specifying Information—Round Valve Boxes

TVB-XXRND-XX		
Type	Size	Color Description
TVB	XXRND	XX
TVB—Toro Valve Box	6—6" Round 7—7" Round 10—10" Round	Blank— Green lid and black box G—Green lid and box GY—Gray lid and box (electrical) T—Tan lid and box E—Purple lid and box (effluent) BK—Black lid and box BR—Brown lid w/black box
Example: A Toro 7" round valve box for effluent water applications would be specified as: TVB-7RND-E		

Description	A Length	B Width	C Height	Weight (lbs)
6"	6.3"	8.1"	9.0"	1.15 lbs
7"	6.8"	9.3"	9.0"	1.80 lbs
10"	9.9"	13.0"	10.3"	3.39 lbs



Specifying Information—Rectangular Valve Boxes

TVB-XXXX-XX-XX			
Type	Size	Height	Color Description
TVB	XXXX	XX	XX
TVB—Toro Valve Box	1217—12"X17" 1521—15"X21"	6—6" High 12—12" High	Blank— Green lid and black box G—Green lid and box GY—Gray lid and box (elect.) T—Tan lid and box E—Purple lid and box (effluent) BK—Black lid and box BR—Brown lid w/black box
Example: A Toro 12x17x6 rectangular valve box for effluent water applications would be specified as: TVB-1217-6-E			

Description	A Length	B Width	C Height	Weight (lbs)
12x17x6	18.8"	13.8"	6.8"	6.56 lbs
12x17x12	21.0"	16.0"	12.3"	9.05 lbs
15x21x6	24.3"	18.8"	7.2"	8.75 lbs
15x21x12	25.7"	19.1"	12.3"	12.11 lbs



Specifying Information—Rectangular Extensions

TVB-XXXX-EXT6BOX-XX			
Type	Size	Height	Color Description
TVB	XXXX	EXT6BOX	XX
TVB—Toro Valve Box	1217—12"X17" 1521—15"X21"	EXT6BOX—6" High	Blank— Black box G—Green box GY—Gray box (elect.) T—Tan box E—Purple box (effluent)
Example: A Toro 6" extension for a 12"x17" tan valve box would be specified as: TVB-1217-EXT6BOX-T			

Description	A Length	B Width	C Height	Weight (lbs)
12x17x6	18.8"	13.8"	6.8"	6.71 lbs
15x21x6	24.3"	17.8"	6.9"	8.89 lbs



Specifying Information—Round Valve Box Separates

TVB-XXXX-XX		
Type	Size Box or Lid	Color Description
TVB	XXXX	XX
TVB—Toro Valve Box	6LID—6" Round lid 7LID—7" Round lid 10LID—10" Round lid BOX6—6" Box (black only) BOX7—7" Box (black only) BOX10—10" Box (black only)	G—Green lid GY—Gray lid (electrical) T—Tan lid E—Purple lid (effluent) BK—Black lid BR—Brown lid
Example: A Toro 7" round valve box lid for effluent water applications would be specified as: TVB-7LID-E		

Description	A Length	B Width	C Height	Weight (lbs)
6" lid	6.3"	8.1"	1.2"	.31 lbs
7" lid	6.8"	9.3"	1.7"	.52 lbs
10" lid	9.9"	13.0"	2.1"	1.13 lbs



Description	A Length	B Width	C Height	Weight (lbs)
6" box	6.3"	8.1"	9.0"	.77 lbs
7" box	6.8"	9.3"	9.0"	1.19 lbs
10" box	9.9"	13.0"	10.3"	2.26 lbs



Specifying Information—Rectangular Valve Box Separates

TVB-XXXX-LID-XX			
Type	Size	Height	Color Description
TVB	XXXX	LID	XX
TVB—Toro Valve Box	1217—12"X17" 1521—15"X21"	LID—Lid	Blank— Green lid G—Green lid GY—Gray lid (elect.) T—Tan lid E—Purple lid (effluent) BK—Black lid BR—Brown lid
Example: A Toro 12x17 rectangular valve box lid for effluent water applications would be specified as: TVB-1217-LID-E			

TVB-XXXX-XXXX		
Type	Size	Height
TVB	XXXX	XX
TVB—Toro Valve Box	1217—12"X17" 1521—15"X21"	6BOX—6" High valve box 12BOX—12" High valve box
Example: A Toro 12x17x6 rectangular valve box would be specified as: TVB-1217-6BOX-BK		

Description	A Length	B Width	C Height	Weight (lbs)
12"x17" lid	16.9"	11.8"	2.0"	2.73 lbs
15"x21" lid	21.3"	14.9"	1.9"	3.23 lbs
12"x17"x6" box	18.8"	13.8"	6.8"	3.83 lbs
12"x17"x12" box	21"	16"	12.3"	6.32 lbs
15"x21"x6" box	24.3"	17.8"	6.9"	5.66 lbs
15"x21"x12" box	25.7"	19.1"	12.3"	8.88 lbs



- A Dual Bolt Retention covers**
Ensures proper sealing and vandal resistance.

- B Heavy Duty Lid**
Construction molded from High Density Polyethylene (H.D.P.E), available in Green, Tan, Purple, Black, Gray and Brown.

- C Accessory Plate (optional)**
Attaches directly to the lid and allows attachments of various components like GDC modules, elec/hyd converters, battery operated controllers and more.

- D Dual Seal Lid**
Keeps water and critters from creeping in from the top.

- E Heavy Duty Box**
Construction molded from High Density Polyethylene (H.D.P.E), available in Green, Tan, Purple, Black, Gray and Brown.

- F Dirt Skirt (optional)**
Attaches directly to the bottom of the valve box and provides an outer seal to prevent intrusion from burrowing rodents, water and critters.

Specifications

Static Vertical Load Rating: SCTE – Light Duty, Pedestrian

Properties of Base Material	ASTM Test Method	HDPE
Tensile Strength	D-638	2700-4,400 psi (Typical Range)
Flexural Modulus	D-790	Minimum 140,000 not to exceed 24,000 psi
Notched Izod Impact Strength	D-256	0.5 - 3.0 (Typical Range)
Deflection Temperature @ 66psi	D-648	150-200 F (Typical Range)
Density	D-792	Minimum 0.95- not to exceed 0.965
Electrical Dielectric Strength	D-149	400-600 V/mil (Typical Range)
Chemical Resistance	D-543	Very Resistant
Water Absorption	D-570	Less than 1% weight change
Warranty • Five years		



Specifying Information—Dry Box Valve Boxes

TVB-1217-12DB-XX			
Type	Size	Height	Color Description
TVB	1217	12DB	XX
TVB—Toro Valve Box	1217—12"X17"	12DB—12" High Dry Box	Blank— Green lid and black box G—Green lid and box GY—Gray lid and box (elect.) T—Tan lid and box E—Purple lid and box (effluent) BK—Black lid and box BR—Brown lid w/black box
Example: A Toro 12"x17"x12" valve box for electrical applications would be specified as: TVB-1217-12DB-GY			

Specifying Information—Dry Box Valve Boxes

TVB-12RND-DB-XX			
Type	Size	Height	Color Description
TVB	12RND	DB	XX
TVB—Toro Valve Box	12" Round	Dry Box	G—Green GY—Gray (electrical) T—Tan E—Purple (effluent) BK—Black BR—Brown
Example: A Toro 12" round Dry Box for effluent water applications would be specified as: TVB-12RND-DB-E			

Description	A Length	B Width	C Height	Weight (lbs)
12DB	21.0"	16.0"	12.3"	9.8 lbs



Description	A Length	B Width	C Height	Weight (lbs)
DBAP	11.5"	8.5"	.2"	0.99 lbs
DBDS	19.8"	14.5"	1.3"	2.8 lbs

Description	A Length	B Width	C Height	Weight (lbs)
DB	11.5"	14.5"	12.75"	7.12 lbs



Accessories	
TVB-1217-DBAP	DRY BOX Accessory Plate
TVB-1217-DBDS	DRY BOX Dirt Skirt

470 Quick Coupler Valves

Whether it's for hand watering the hot spots, fertilizer wash in, washing down equipment or filling the sprayer and lakes the 400 Series provides a full family of quick coupling valves and accessories that connect you directly to the main water source to fill all your hand watering needs.

FEATURES & BENEFITS

- ✓ Full range of flows from 0 to 100 gallons per minute
- ✓ 3/4", 1" and 1 1/2" one- and two-piece single-lug models including ACME thread key connections to meet a variety of installation requirements
- ✓ Hose swivel provides 360° movement without hose tangling for ease of use
- ✓ A variety of sizes meet various applications
- ✓ Metal and vinyl locking and non-locking covers
- ✓ Effluent (lavender-colored) locking cover



Warranty

- Five years

Ordering Information—Quick Coupler Valve Accessories

Order Number	Description
463-01	1/2" Female, 3/4" Male, Single-lug Coupler Key
464-01	3/4" Female, 1" Male, Single-lug Coupler Key
464-02	1" Female, Single-lug Coupler Key
464-03	1" ACME Thread Coupler Key
465-01	1 1/4" Inlet, 3/4" Female, 1" Male, Single-lug Coupler Key
466-01	1 1/4" Female, 1 1/2" Male, Single-lug Coupler Key
477-00	3/4" Female NPT x 3/4" MHT Hose Swivel
477-01	1" Female NPT x 3/4" MHT Hose Swivel
477-02	1" Female NPT x 1" MHT Hose Swivel

470 SERIES FRICTION LOSS DATA

Model	gpm Flow											
	10	15	20	25	30	35	40	50	60	70	85	100
473	1.5	3.1	5.3	8.5								
474			1.1	2.2	3.6	5.7	8.0					
475				1.0	1.8	2.7	3.6	6.4	9.8			
476							1.0	1.7	2.6	3.6	5.6	8.8

Note: For optimum sprinkler performance when designing a system, be sure to calculate total friction loss to ensure sufficient downstream pressure. Flow rates are recommended not to exceed 5 psi loss. Values listed in psi.

Specifying Information—Quick Couplers

Toro Model Number	Description	Inlet Size NPT Threads	Body Type	Outlet Key Size	Corresponding Key(s)	Valve Cover Type	Corresponding Swivel(s)*		
							477-00	477-01	477-02
473-00	QCV .75, SS CVR	3/4"	1 Piece	3/4"	463-01	Stainless Steel	A	B	B
474-00	QCV 1, SS CVR	1"	1 Piece	1"	464-01/464-02	Stainless Steel	B	A/B	A/B
474-01	QCV 1, VYL CVR	1"	1 Piece	1"	464-01/464-02	Yellow Vinyl, Spring Loaded	B	A/B	A/B
474-03	QCV 1, VYL CVR, W/LK	1"	1 Piece	1"	464-01/464-02	Yellow Vinyl, Locking, Spring Loaded	B	A/B	A/B
474-04	QCV 1, LAV VYL CVR	1"	1 Piece	1"	464-01/464-02	Lavender Vinyl, Locking, Spring Loaded	B	A/B	A/B
474-21	QCV 1, VYL CVR, 2PC	1"	2 Piece	1"	464-01/464-02	Yellow Vinyl, Spring Loaded	B	A/B	A/B
474-24	QCV 1, LAV VYL CVR, 2PC	1"	2 Piece	1"	464-01/464-02	Lavender Vinyl, Locking, Spring Loaded	B	A/B	A/B
474-40	QCV 1, SS CVR, ACME	1"	1 Piece	1"	464-03	Stainless Steel	B	A	A
474-41	QCV 1, VYL CVR, ACME	1"	1 Piece	1"	464-03	Yellow Vinyl, Spring Loaded	B	A	A
474-44	QCV 1, LAV VYL CVR, W/LK, ACME	1"	1 Piece	1"	464-03	Lavender Vinyl, Locking, Spring Loaded	B	A	A
475-00	QCV 1.25, SS CVR	1"	1 Piece	1 1/4"	465-01	Stainless Steel	B	B	B
475-01	QCV 1.25, VYL CVR	1"	1 Piece	1 1/4"	465-01	Yellow Vinyl	B	B	B
476-00	QCV 1.5, SS CVR	1 1/2"	1 Piece	1 1/2"	466-01	Stainless Steel	B	B	B
476-01	QCV 1.5, VYL CVR	1 1/2"	1 Piece	1 1/2"	466-01	Yellow Vinyl, Spring Loaded	B	B	B
476-04	QCV 1.5, LAV VYL CVR	1 1/2"	1 Piece	1 1/2"	466-01	Lavender Vinyl, Locking, Spring Loaded	B	B	B

*A - Attaches directly to the quick coupler key. B - Requires additional fittings to be used with the quick coupler key.



The Twilight™ Golf Cup promotes twilight putting and evening special events. Highlight the beauty of the course to attract special events to the venue and drive additional revenue. The Twilight™ Golf Cup will set you apart from your competition by lighting up the putting green allowing members, guests and customers to remain longer and enjoy other attractions your facility has to offer like dining, lounges and the Pro Shop.

FEATURES & BENEFITS

Twilight Golf Cup

The wireless Twilight™ Golf Cup is sized to easily install into any standard cup hole. Convenient battery operation and wireless technology makes it quick to install. With high illumination, energy efficient LED lamps, and a proprietary optical lens, the flag and cup placements pop off the green. Their Lithium-Ion battery will provide illumination for a full eight hours and requires about five hours charge time to achieve full capacity. Charger charges up to three golf cups at once.

Quick-Connect Perimeter Lighting

The quick-connect system for perimeter lighting is a snap. The perimeter lights plug in for use during evening activities and are removable during daytime hours. Simply flip open the top of the perimeter in-ground stake and snap the lighting fixture into place creating a low voltage connection. Permanently installed receptacles are flush mounted to grade, just off the putting green surface. The directional luminaire is crafted from solid brass and has an adjustable knuckle to place the light just where you want it.



LED Technology Provides High Illumination

Working in conjunction with a proprietary optical lens design, the LEDs provide a narrow beam of light to brightly illuminate the flag.



Quick-Connect Perimeter Stake



Quick-Connect Perimeter Light

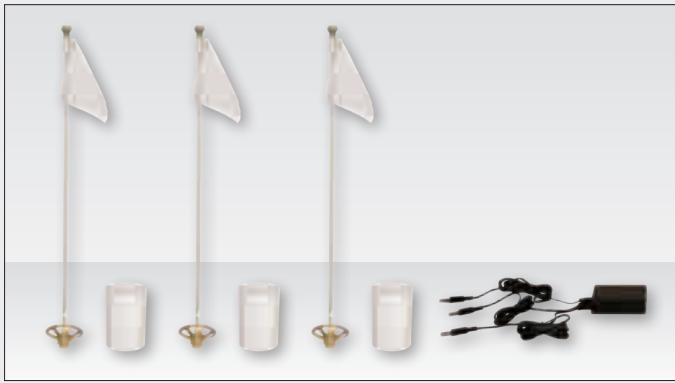

TWGC-3P



TWGC-CUPANDCATCH



TWGP-STAKE



TWGP-STAR36-12-L5



TWGC

SPECIFICATIONS

Operational

Twilight™ Golf Cup (TWGC)

- White ABS cup aligns notches in solid brass ball catch with notches in cup. Fits most standard and putting green flags.
- CREE XB-D white LEDs, 3200K color temperature
- Bottom compartment houses the on/off switch, charging port and Lithium-Ion battery.
- Charger will charge up to three golf cups at one time – estimated charging time is 5 hours.
- Lithium-Ion battery will run the cup light for up to 8 hours

Perimeter Post Light (TWGP)

- Solid brass die cast construction of the luminaire – Tempered glass lens encased in a silicone gasket to create a weather resistant seal.
- Provided with a 5W LED MR16 lamp
- Solid brass quick-connect adaptor is mounted to the bottom of the 36" stem
- Adjustable head rotates vertically allowing for on-site adjustability, includes low-glare lamp shield

Perimeter In-Ground Stake (TWGP-STAKE)

- Sturdy, in-grade, 3" diameter stake provides electrical connection to the transformer and stability for the 36" tall perimeter post light
- Resin flip top for easy connection
- Flush mount to grade when not in use with fixture inserted
- Powered by a TUV certified low voltage transformer

Electrical

Twilight™ Golf Cup (TWGC)

- LEDs – 12VDC, (3) 1 Watt light emitting diodes
- Lithium-Ion Battery – 11.1 VDC 2600 mAh
- Charger – 120VAC/12VDC

Perimeter Light (TWGP)

- 5 Watt LED lamp, 12V AC

TWGP-TRANS-XXXXX - Transformer

- 120V AC 6' long cord
- 12V-15V output for the 360SS
- 12V-22V output for the 1120SS

Dimensions

- TWGC Cup light only: 4⁵/₁₆" Dia. x 6⁵/₁₆" H
- Flag height: 30¹/₄" H
- TWGP Perimeter Post Light: 43" H installed
- TWGP Receptacle – exposed diameter 3⁵/₈"

Warranty

- Twilight™ Golf Cup, 2 years
- Perimeter Post Light, limited lifetime warranty
- Perimeter in-ground stake & Hub, 3 years
- Transformers, limited lifetime warranty
- LED lamp in Perimeter Post Light, 5 years
- Lithium-Ion Battery, 2 years

Specifying Information—Twilight Perimeter Lighting

Model Number	Description
TWGP-STAR36-12-L5	Perimeter Post Light w/Starburst Luminaire on 36" Post, w/12-Volt, 5-Watt LED, Vertical-Spread Lens
TWGP-STAKE	Stake, Stabilizing, w/Electrical Receptacle Assembly, w/2 Waterproof Wire Splices
TWGP-TRANS-360SS	360-Watt Transformer, Indoor/Outdoor, Wall-Mountable
TWGP-TRANS-360DB	360-Watt Transformer, Direct-Burial
TWGP-TRANS-1120SS	1120-Watt Transformer, Indoor/Outdoor, Wall-Mountable
TWGP-HUB	Hub Electrical Enclosure, w/4 InLine Fuse Holders, w/4 5-Amp Fuses, 4 Spare 5-Amp Fuses, 4 Waterproof Wire Splices
TWGP-WIRE-12-2-500	Direct-Burial Cable, 12-Gauge, 2-Conductor, 500-Foot Spool
TWGP-ELECREC	Receptacle, Electrical, w/2-Wire Splice, Replacement
TWGP-5WLAMP	Lamp, LED, 5-Watt, Flood, 27K, Replacement
TWGP-LID	Receptacle, Electrical, Lid, Replacement
TWGP-LENS	Vertical-Spread Lens, Replacement
TWGP-HEXLOUVER	Hex Louver, Replacement
TWGP-GREASE	Grease, Lubricating/Sealing, for Replacement LED Installation

Specifying Information—Twilight Cup Lights

Model Number	Description
TWGC	Twilight Wireless Golf Cup Light, Single Unit
TWGC-3P	Kit, Twilight Golf Cup, 3-Pack
TWGC-BALLCATCH	Ball Catch, Brass
TWGC-CHARGER-S	Charger, Power Supply
TWGC-CUP	Twilight Wireless Golf Cup, Single Cup
TWGC-CUPANDCATCH	Twilight Wireless Golf Cup, Single Unit, w/Ball Catch, Brass
TWGC-FLAG	Twilight Wireless Golf Cup Flag, Pole and Nut
TWGC-LIBATT	Battery, Lithium Ion, Rechargeable

Wire Sizing Current Draw (Amperage)

Standard Wattage Solenoid

Product	Solenoids	Assumes 24 VAC, 50/60 Hz Output			
		120 VAC, 60 Hz		240 VAC, 50 Hz	
		Inrush	Holding	Inrush	Holding
Lynx Smart Satellite	0	—	0.20	—	0.19
	1	0.26	0.25	0.30	0.22
	2	0.35	0.30	0.34	0.25
	3	0.40	0.34	0.36	0.28
	4	0.46	0.39	0.39	0.30
	5	0.50	0.43	0.42	0.33
	6	0.64	0.48	0.44	0.36
	7	0.70	0.52	0.46	0.38
	8	0.73	0.56	0.50	0.41
	9	0.77	0.61	0.53	0.43
	10	0.80	0.65	0.57	0.46
	11	0.85	0.69	0.57	0.48
	12	0.91	0.73	0.57	0.51
	13	1.00	0.77	0.61	0.53
	14	1.03	0.81	0.62	0.55
	15	1.05	0.85	0.63	0.58
16	1.14	0.88	0.66	0.60	
OSMAC® G3 Satellite	0	0.05	0.05	0.03	0.03
	1	0.13	0.11	0.07	0.06
	2	0.21	0.17	0.12	0.09
	3	0.29	0.23	0.17	0.12
	4	0.37	0.29	0.21	0.15
	5	0.45	0.35	0.26	0.19
	6	0.53	0.41	0.31	0.22
	7	0.61	0.47	0.35	0.25
	8	0.69	0.53	0.40	0.28
	9	0.77	0.59	0.45	0.31
	10	0.85	0.65	0.50	0.35
	11	0.93	0.71	0.54	0.38
	12	1.01	0.77	0.59	0.41
	13	1.09	0.83	0.64	0.44
	14	1.17	0.89	0.68	0.47
	15	1.25	0.95	0.73	0.51
16	1.33	1.01	0.81	0.54	

Spike Guard™ Low Wattage Solenoid

Product	Solenoids	Assumes 24 VAC, 50/60 Hz Output			
		120 VAC, 60 Hz		240 VAC, 50 Hz	
		Inrush	Holding	Inrush	Holding
Lynx Smart Satellite	0	—	0.20	0.21	0.20
	1	0.24	0.22	0.22	0.21
	2	0.26	0.24	0.23	0.22
	3	0.29	0.27	0.24	0.23
	4	0.31	0.29	0.25	0.24
	5	0.33	0.31	0.26	0.26
	6	0.35	0.33	0.28	0.27
	7	0.39	0.37	0.29	0.28
	8	0.41	0.39	0.30	0.30
	9	0.43	0.41	0.32	0.31
	10	0.46	0.44	0.34	0.33
	11	0.47	0.46	0.35	0.35
	12	0.49	0.48	0.36	0.36
	13	0.52	0.50	0.37	0.38
	14	0.54	0.52	0.38	0.39
	15	0.56	0.54	0.40	0.40
	16	0.58	0.56	0.43	0.42
	17	0.60	0.58	0.44	0.43
	18	0.61	0.60	0.46	0.45
	19	0.63	0.62	0.47	0.46
	20	0.66	0.64	0.49	0.48
	21	0.68	0.66	0.50	0.49
	22	0.70	0.68	0.51	0.50
	23	0.74	0.70	0.53	0.52
	24	0.76	0.72	0.54	0.53
	25	0.79	0.74	0.55	0.54
	26	0.80	0.75	0.57	0.56
	27	0.85	0.77	0.58	0.57
	28	0.90	0.79	0.59	0.58
	29	0.93	0.81	0.60	0.59
	30	0.96	0.82	0.61	0.60
	31	1.01	0.84	0.62	0.61
32	1.04	0.86	0.64	0.62	
OSMAC® G3 Satellite	0	0.05	0.05	0.03	0.03
	1	0.07	0.07	0.05	0.05
	2	0.10	0.09	0.06	0.06
	3	0.12	0.11	0.08	0.08
	4	0.15	0.13	0.10	0.09
	5	0.17	0.15	0.12	0.11
	6	0.19	0.17	0.13	0.12
	7	0.22	0.19	0.15	0.14
	8	0.24	0.21	0.17	0.15
	9	0.27	0.23	0.18	0.17
	10	0.29	0.25	0.20	0.18
	11	0.31	0.27	0.22	0.20
	12	0.34	0.29	0.23	0.21
	13	0.36	0.31	0.25	0.23
	14	0.39	0.33	0.27	0.24
	15	0.41	0.35	0.29	0.26
16	0.44	0.37	0.30	0.27	

CONVERSION INFORMATION

- All gallons per minute are shown in U.S.
- To convert to imperial gallons per minute, multiply by 0.833
- To convert to liters per minute, multiply by 3.78
- To convert pounds per square inch (psi) to atmospheres, divide by 14.7
- To convert pounds per square inch (psi) to kilograms per square centimeter (kg/cm²), divide by 14.22
- To convert feet to meters, divide by 3.28

WINTERIZING SPECIFICATIONS

In freezing climates, valves should be properly winterized to prevent freeze-related damage.

SPRINKLER SPACING

The Toro Company does not recommend designing for zero (0) mph wind conditions.

■ Square Spacing

- No wind - 55% of diameter
- 4 mph wind - 50% of diameter
- 6,4 kph wind - 50% of diameter
- 8 mph wind - 45% of diameter
- 12,8 kph - 45% of diameter

■ Triangular Spacing

- No wind - 60% of diameter
- 4 mph wind - 55% of diameter
- 6,4 kph wind - 55% of diameter
- 8 mph wind - 50% of diameter
- 12,8 kph - 50% of diameter

■ Single Row Spacing

- No wind - 50% of diameter
- 4 mph wind - 50% of diameter
- 6,4 kph wind - 50% of diameter
- 8 mph wind - 45% of diameter
- 12,8 kph - 45% of diameter

Design in consideration of the worst wind conditions.

PRECIPITATION RATE FORMULAS

■ Square-spaced sprinklers in pattern:

$$\frac{\text{gpm of full-circle} \times 96.3}{(\text{Spacing})^2}$$

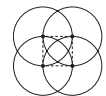

■ Triangular-spaced sprinklers in pattern:

$$\frac{\text{gpm of full-circle} \times 96.3}{(\text{Spacing})^2 (1.866)}$$

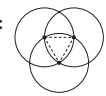

■ Area and flow:

$$\frac{\text{Total gpm of zone} \times 96.3}{\text{Total irrigated square feet of zone}}$$



■ Single row:

$$\frac{\text{gpm of full-circle} \times 96.3}{(\text{Spacing}) (\text{Scallop})}$$

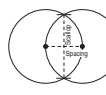



The Toro Company and its affiliate, Toro Warranty Company, pursuant to an agreement between them, jointly warrants to the owner, each new piece of irrigation equipment (featured in the current catalog at date of installation) against defects in material and workmanship for a period described below, provided they are used for irrigation purposes under manufacturer's recommended specifications and instructions.

During the warranty period, we will repair or replace, at our option, any part found to be defective. Your remedy is limited solely to the replacement or repair of defective parts.

This warranty does not apply (i) to Acts of God (e.g., lightning, flooding, etc.); or (ii) to products not manufactured by Toro when used in conjunction with Toro products; or (iii) where equipment is used, or installation is performed in any manner contrary to Toro's specifications and instructions, or where equipment is altered or modified.

Return the defective part to your irrigation contractor or installer, or your local Golf Irrigation Distributor, or contact:

The Toro Company
5825 Jasmine Street, Riverside, CA 92504
(800) 664-4740

For the location of your nearest Toro distributor outside the U.S., call: (951) 688-9221.

Neither Toro nor Toro Warranty Company is liable for indirect, incidental or consequential damages in connection with the use of equipment, including but not limited to: vegetation loss, the cost of substitute equipment or services required during periods of malfunction or resulting non-use, property damage or personal injury resulting from installer's actions, whether negligent or otherwise.

Some states do not allow the exclusion of incidental or consequential damages, so the above exclusion may not apply to you.

All implied warranties, including those of merchantability and fitness for a particular purpose, are limited to the duration of this express warranty. Some states do not allow limitations on how long an implied warranty lasts, so the above limitation may not apply to you.

This warranty gives you specific legal rights and you may have other rights which vary from state to state. Proof of installation date required for any warranty claim and for any product covered by this warranty.

Lynx® Smart Satellite

Lynx Smart Satellite is covered by this warranty for 2 years from the date of installation.

Golf Sprinklers

All Toro golf sprinklers and conversion assemblies are covered by this warranty for 3 years from the date of installation.

All Toro golf sprinklers purchased and installed with a Toro swing joint will be covered by a five-year warranty*. Proof of simultaneous installation required for any warranty claim.

INFINITY add-on accessories will be covered by a 1 year warranty.

* Excludes 590GF Series and sprinkler conversion assemblies.

Swing Joints

Toro swing joints are covered by this warranty for 5 years from the date of installation.

Warranty covers defects in manufacturing and excludes damage resulting from natural phenomena such as frost heave.

Valves

220G Series, P-220G Series and P-220GS Series valves are covered by this warranty for 5 years from date of installation. 470 Series quick coupler valves are covered by this warranty for 2 years from date of installation.

DL2000™ Subsurface Drip Irrigation

Toro DL2000™ Subsurface Drip Irrigation products are covered by this warranty for 2 years from date of installation.

Control Systems, Turf Guard®, Valve Boxes, Dry Boxes and Lynx Smart Module

All Toro golf control systems (central controls, field satellite controllers, GDC, Turf Guard and Sensor Input Kits), Valve Boxes and Dry Boxes, unless covered by a Toro NSN Support Plan, are covered by this warranty for 1 year from date of installation.

Twilight™ Golf Lighting

All Twilight Golf Lighting products are warranted for a period of 3 years from the date of installation with the exceptions shown below. Proof of installation date required for all warranty claims.

- **TWGP perimeter post lights** – limited lifetime
- **Transformers** – limited lifetime
- **FLEX GOLD™ Series LED lamps** – 5 years
- **Lithium Ion battery** – 2 years

To request warranty on all Toro Golf Lighting products, please contact:

Lighting Customer Support
(800) 955-4831 (7:00 a.m. and 5:00 p.m. PST)
Monday – Friday

Limited lifetime warranties may require that the defective product be returned to Toro for repair. Please contact the Lighting Customer Support Department for direction.

All failed Golf Lighting products must be returned to Toro at the following address:

The Toro Company
5825 Jasmine Street, Riverside, CA 92504

Att: Lighting warranty

We reserve the right to improve our products and make changes in the specifications and designs without notice and without incurring obligation. Products depicted in this brochure are for demonstration purposes only. Actual products offered for sale may vary in design and features.

i International distributors can be found at:
www.toro.com/locator



Our American Partners

1. Century Equipment, Inc.
(419) 865-7400
2. E. H. Griffith, Inc.
(412) 271-3365
3. Grassland Equipment & Irrigation Corp.
(518) 785-5841
4. Kona Irrigation Supply, Ltd.
(808) 329-1167
5. Hector Turf
(954) 429-3200
6. Jerry Pate Turf & Irrigation, Inc.
(850) 479-4653
7. Kenney Machinery Corp.
(317) 872-4793
8. L. L. Johnson Distributing Company
(303) 320-1270
9. Midland Implement Company, Inc.
(406) 248-7771
10. Midwest Turf & Irrigation, Inc.
(402) 895-8900
11. MTI Distributing, Inc.
(763) 592-5600
12. Professional Turf Products
(817) 785-1900
13. Reinders, Inc.
(262) 786-3300
14. Simpson Norton Corporation
(623) 932-5116
15. Smith Turf & Irrigation L.L.C.
(704) 393-8873
16. Spartan Distributors, Inc.
(616) 887-7301
17. Storr Tractor Company
(908) 722-9830
18. Turf Equipment & Irrigation
(801) 566-3256
19. Turf Equipment & Supply Company, Inc.
(410) 799-5575
20. Turf Products L.L.C.
(860) 763-3581
21. Turf Star, Inc.
(800) 585-8001
22. Wesco Turf Inc.
(941) 377-6777

Our Canadian Partners

23. Ful-Flo Industries, Ltd.
(204) 633-4414
24. Oakcreek Golf and Turf Inc.
(403) 279-2907
25. Turf Care Products Canada
(905) 836-0988





**Toro is always there to help you care for your landscapes the way you want,
when you want, better than anyone else.**



www.toro.com

5825 Jasmine Street
Riverside, CA 92504-1183
Phone: 877-345-8676
Fax: 800-862-8676

©2019 The Toro Company
All Rights Reserved

PN: 19-5003-IG

We reserve the right to improve our products and make changes in the specifications and designs without notice and without incurring obligation.

Products depicted in this brochure are for demonstration purposes only. Actual products offered for sale may vary in design and features.



facebook.com/Toro.Company
twitter.com/torogolf
youtube.com/toro