

# We've got it.

## HVAC Product Catalog

Issue 23

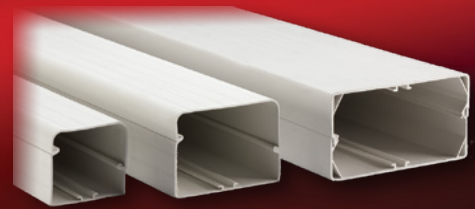
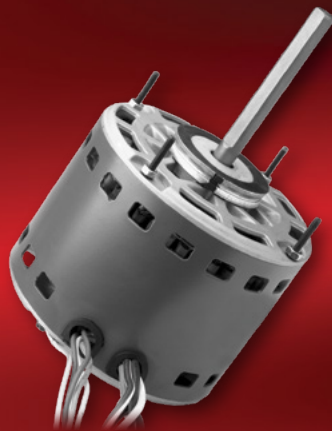

Simplify your Work.™

1

**PADS**



25

**MOUNTING SYSTEMS**



45

**AIR MOVEMENT**



51

**HEATING PRODUCTS**



63

**CONDENSATE MANAGEMENT**



91

**GENERAL INDUSTRIAL**

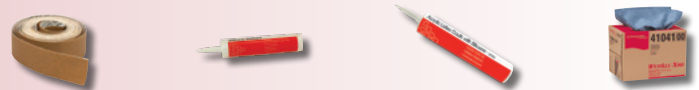

103

**DEVCO**

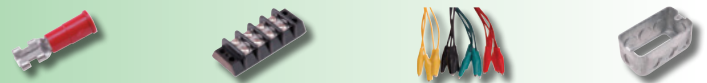

133

**ELECTRICAL**



179

**TOOLS**



195

**PLUMBING**



205

**DUCTLESS SYSTEMS**



215

**MAINTENANCE CHEMICALS**

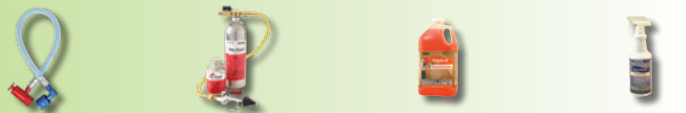

245

**INLINE COMPONENTS**



263

**DISTRIBUTOR SUPPORT**



# PADS

Anti-Vibration Pads.....	24
Cladlite® Lightweight Equipment Pads.....	20
E Lite® Plastic Equipment Pads.....	19
EcoPad™.....	23
Heat Pump Pads.....	23
Hef-T-Pad®.....	22
The Black Pad®.....	22
The Hurricane Pad™.....	21
Ultralite® Lightweight Concrete Equipment Pads....	18-19

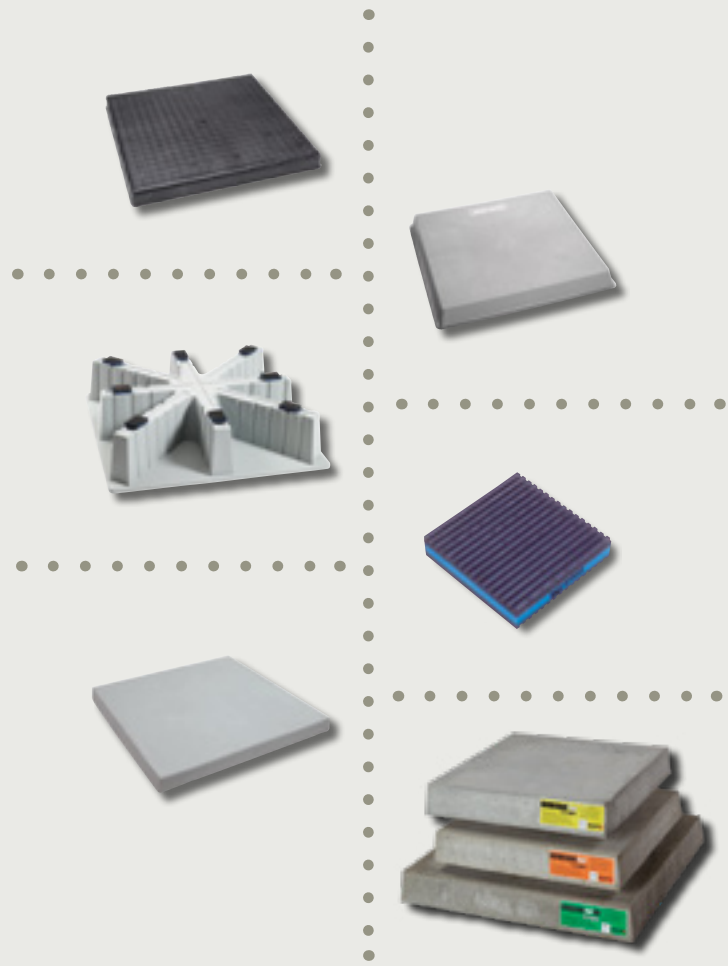

# E Lite® Plastic Equipment Pads

**E** Lite® is a plastic pad designed as a mounting base for equipment. The rugged design provides uniform and generous ribbing for optimum, self-leveling ground support without inserts. E Lite® is injection molded from polypropylene, resulting in a pad that is lightweight, but not too light. A subtle texture prevents unit slide and presents a classic appearance, which is enhanced by rounded edges and a concrete gray color. Each pad is molded with its size in raised letters.



## TECHNICAL DATA

### MATERIAL

Polypropylene

### FREEZE/THAW

Flawless performance under the 25-cycle regimen specified by ASTM C67

### CHEMICAL RESISTANCE

Does not crack, flake, or warp when tested per ASTM D2299 with the following:

- R-22 and R-134a
- Synthetic canine urine
- Compressor oil
- Salt solution, 20% by volume



Each pad is molded with its size in raised letters.

## FEATURES AND BENEFITS

- Lightweight, yet rugged
- Drillable for securing unit
- Uniform ribbing transfers load evenly
- Unaffected by UV or weather
- Subtle texture resists unit slide

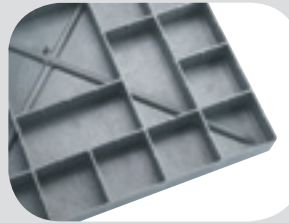

The bottom of an E Lite® pad shows extensive ribbing, plus additional surface support.



E Lite® plastic equipment pads are manufactured at DiversiTech's Conyers, Georgia plant.

# Hef-T-Pad® Equipment Pads

*Hef-T-Pad® is an injection molded equipment pad created from high impact polypropylene with UV inhibitors making it easy to handle, yet durable and strong. It does not require any additional equipment for moving and handling. Hef-T-Pad® is resistant to impact, ultraviolet degradation and weathering and will not crack, flake, or warp. It is virtually impervious to climatic variations. Hef-T-Pad® is drillable to permit installation of refrigerant and electrical lines under and through the pad and to allow equipment to be easily secured to the pad.*



## FEATURES AND BENEFITS OF THE HEF-T-PAD®

The thick walled polymer is suitable for drilling and screw fastening of equipment, line sets, and electrical connections.

Stabilization flange provides a wide perimeter that reduces sinking in soft soil under heavy load. Both the flange and ribbing provide reinforcement for the corners.

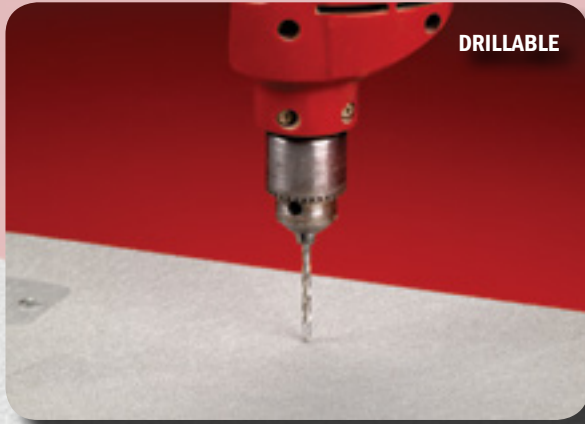

Textured surface provides good aesthetics and a non-skid surface.

Attractive neutral gray color with pad size and branding clearly embossed on pad surface.

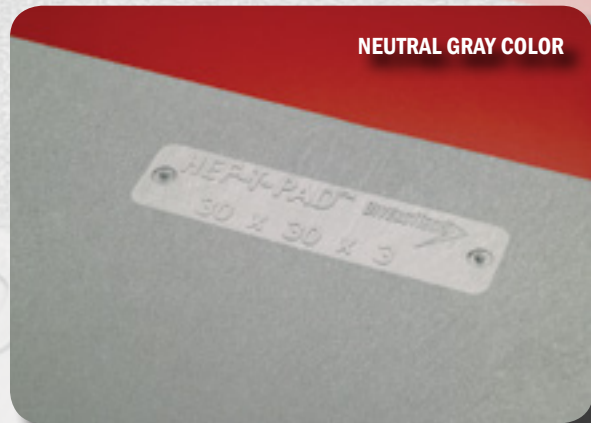
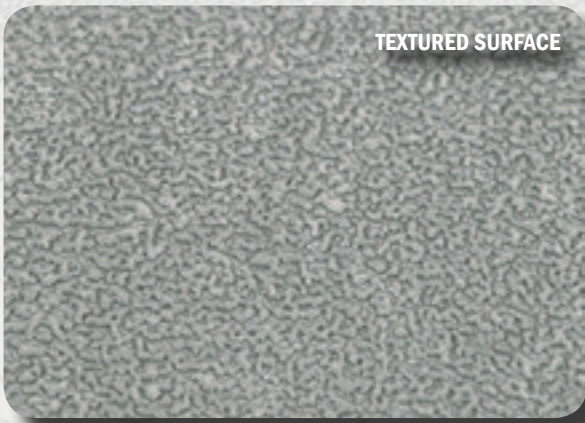

Pad size is molded into the side of the pad as well as the top surface.



# The Black Pad™ replaces Concrete Equipment Bases

## Eco-friendly

The Black Pad™ is extremely durable, resistant to ultraviolet light, and heavier than E Lite®. The Black Pad™ is ideal for HVAC equipment, pool and spa pumps, filters and heaters. The Black Pad™ is extremely weather resistant and easy to drill and secure equipment.

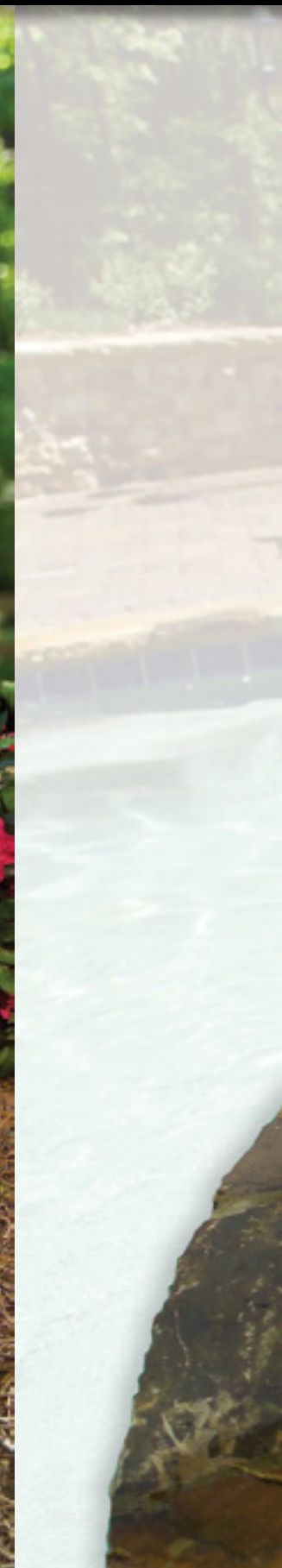



- No cracking and less breakage than concrete
- Extremely durable, yet lightweight
- UV resistant; unaffected by weather
- Generous ribbing for optimum, self-leveling ground support
- Outer edges have rounded corners with double-thick walls
- Uniform ribbing transfers load evenly
- Textured surface prevents equipment slippage
- Drillable for securing equipment
- ICC Certified to Standard Swimming Pool Code sections 305.2 Mounting and section 405 Equipment Foundations and Enclosures.

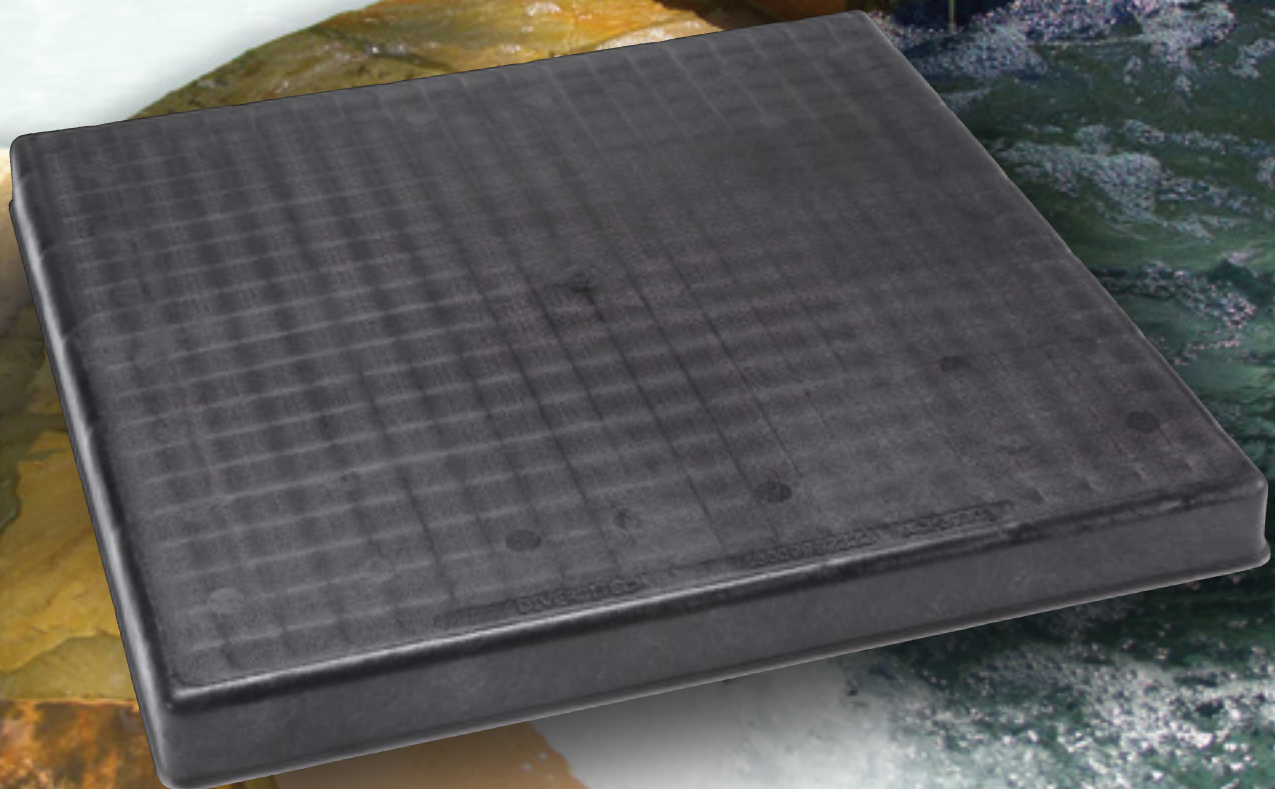
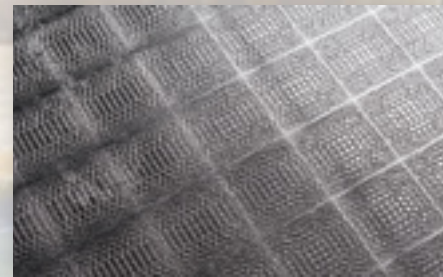

# UltraLite® Equipment Pads



- *Lightweight concrete pad*
- *Installs in seconds - easier and faster than pouring your own pad*
- *Engineered for long term outside weather resistance*
- *Will not degrade or discolor*
- *Freeze/thaw resistant - will not crack*

UltraLite® Pads are made by DiversiTech, North America's largest manufacturer of equipment pads.

## FEATURES AND BENEFITS

**LIGHTWEIGHT** At an average weight of 2-1/2 pounds per square foot (12 kg. per square metre), the UltraLite lightweight concrete pad is one of the lightest equipment mounting products available today. Lightweight products are important for ease of handling on job site.

**DURABLE** The exterior of the UltraLite lightweight concrete pad is specifically engineered for long-term exterior weather resistance.

**DUCTILE** The skin and core of the UltraLite lightweight concrete pad is specifically engineered for flexibility and ductility demanded of job site handling. Additionally, the ductility of the outer skin facilitates conformance to slight ground contours without fracture.

**TIME/LABOR SAVINGS** Time is money, and hence any time savings on site translates into money saved. The UltraLite lightweight concrete pad literally installs in seconds while providing a solid foundation for the condensing unit.

**CONCRETE SURFACE** The concrete external skin of the UltraLite lightweight concrete pad is not subject to ultraviolet degradation or weathering discoloration.

**VIBRATION ABSORBING** The engineered polystyrene core in the UltraLite lightweight concrete pad absorbs and dampens vibration associated with normal operation of a condensing unit.

**FREEZE/THAW RESISTANT** The UltraLite lightweight concrete pad is vapor permeable. Water vapor evaporates through the pad, hence the concrete outer skin is not subject to expansion cracks.

**FLAME RESISTANT** The concrete outer skin of the UltraLite lightweight concrete pad is resistant to heating caused by the compressor. Additionally, the surface is resistant to heat from incidental torch flame during site installation.

**OUTSIDE STORAGE** The UltraLite lightweight concrete pad is intended for life in the outdoors. As such, the pad is suitable for exterior storage prior to site installation.

## TECHNICAL DATA

### LOADING

To achieve the maximum permissible pad load capacity, the earth under the pad must be capable of supporting the transmitted compression load of the UltraLite pad. All values tabulated assume the earth has a bearing capacity of at least 1000 pounds per square foot (48 kPa).

The allowable loads assume a uniformly distributed loading on the pad surface (that is, a relatively flat-bottomed condenser unit in contact with the pad). For condenser units with footpads or other point loads, the maximum concentrated load for any size UltraLite pad is 125 pounds per 2" (56 kg per 50 mm) diameter (or equivalent surface area) footpad.

### CHEMICAL RESISTANCE

In normal usage conditions an equipment pad can be exposed to a variety of chemicals. The UltraLite pad has been fully tested in accordance with ASTM D2299 for resistance against:

- R-22 and R-134a
- Compressor oil
- Salt solution, 20 percent by volume
- Synthetic canine urine

The UltraLite pad performs extraordinarily well under these testing criteria. UltraLite does not craze, soften, delaminate, or spall under exposure in this test.

### FREEZE/THAW TESTING

The UltraLite pad has been independently tested to the rigorous freeze-thaw regimen specified by ASTM C67. This standard dictates a twenty-five cycle freeze-thaw sequence. The freeze portion of the sequence takes place with the top surface of the UltraLite pad under 1/2" (12 mm) of water. Once twenty-five cycles are complete, the pad is examined using visual magnification. No cracks or crazing is permitted. UltraLite has performed flawlessly.



# CladLite® Equipment Pads



***Tough. Durable. Strong.***

CladLite® Equipment Pads provide the strength and durability customers demand in an easy to install pad. CladLite® Pads are up to 80% lighter than solid concrete but still provide rock solid support for equipment. Once it's set, so are you. CladLite® Pads stay in place and can withstand anything mother nature can throw at them. These pads provide superior resistance to sun, moisture, and freeze-thaw conditions. And the vibration dampening EPS foam core is unaffected by water, soil, fungus or bacteria. Cladlite® Pads are available in 2" and 3" thickness and more than 70 different sizes so you can get the exact pad you need for the job. Get the concrete pads that homeowners prefer – Cladlite®.

## CLADLITE® SPECIFICATIONS

Allowable Load: 125 lbs. per 2" diameter foot

Freeze/Thaw: Flawless performance under the 25-cycle regimen specified by ASTM C67

Chemical Resistance: Does not craze, soften, delaminate, or spall when tested per ASTM D2299 with the following:

- R-22 and R-134a
- Compressor oil
- Synthetic canine urine
- Salt solution, 20% by volume

Foam Core: ASTM Type 1 EPS

Flame Resistance:

Cladding resists compressor heat and incidental torch contact.

Not to be used under heating devices.



# Heat Pump Pad™



*Ideal for snowy climates, the DiversiTech Heat Pump Pad™ is the perfect solution for protecting equipment and ensuring proper operation year round. The Heat Pump Pad™ provides*

*a full 8" clearance from ground level in a compact square footprint. Included with every Heat Pump Pad™ are 8 anti-vibration pads, specifically molded into slots in the pad to reduce vibration and provide quiet operation of your equipment. The base of the pad is also angled to direct melting snow or condensate away from the unit and pad. Heat Pump Pads are made from recycled polypropylene so they are eco-friendly and are built tough to provide many years of service. These pads also nest together for easier transportation and warehousing.*

Each Heat Pump Pad™ includes eight Anti-Vibration pads fitted into special slots in the risers to reduce equipment vibration and noise.

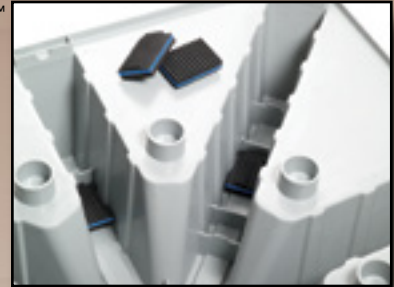

**Stackable!**





# The Hurricane Pad™

## THE HURRICANE PAD™ CONCRETE EQUIPMENT PAD

**Hurricane strength equipment pads designed to Florida's tough standards.**

DiversiTech's family of Hurricane Pads provide complete protection when the weather turns the worst. Three different models and dozens of sizes of The Hurricane Pad™ ensure you have the right pad for any area or need. Each DiversiTech Hurricane Pad™ includes these features:

- Steel reinforced
- 7,000 psi minimum concrete, mandatory to meet strict anchor pullout requirements
- Easier to install
- Will not float (unlike air filled pads)
- Uses standard Tapcon™ brand screws and no inserts are necessary
- Superior screw pullout strength



### FLORIDA BUILDING CODE NOTICE

This product meets the following Florida Building Code requirements:

1. Florida Building Commission (DCA02-DEC-183) declares this pad to be an acceptable alternative material to solid concrete pads.
2. This pad meets Mechanical Volume, Section 304.10 – clearance from grade.
3. Pad weight and wind load requirements have been calculated by Master Consulting Engineers. For up to date calculations and documentation, visit our website: [www.diversitech.com](http://www.diversitech.com).



## THE HURRICANE PAD™

The Hurricane Pad is designed for installations up to 150 MPH. The Hurricane Pad provides a solid base for mounting and protecting equipment threatened by adverse conditions.



## THE HURRICANE PAD™ T CLASS

The Hurricane Pad T-Class is designed for even higher wind loads - up to 175 MPH. Ideal for south Florida counties and other heavily threatened areas, the T Class Hurricane Pads are heavier and provide additional concrete for superior anchor pullout strength.



## THE HURRICANE PAD™ MD

The ultimate in protection, The Hurricane Pad MD is specifically designed for the strict regulations of Miami-Dade county. These solid concrete pads meet the Florida Building Code Notice and can withstand winds up to 175 MPH. This pad is made from a minimum 7000PSI solid concrete.



*Equipment must be properly attached to The Hurricane Pad™ in order to prevent sliding and tipping in high winds.*

# Anti-Vibration Pads

## EVA™ PAD: The BEST Performer

EVA™ (Extreme Vibration Attenuation) is the latest generation in vibration dampening technology. In the most severe vibration extremes, testing shows the EVA™ pad outperforms cork and rubber by greater than 3:1 and outperforms our competitor's "waffle" pad by greater than 8:1! The enhanced performance comes from the special composite foam center which is structurally more sound than cork. EVA™ is not affected by oils or chemicals that can break down cork and is much more effective at vibration dampening than solid rubber. Designed to withstand 50 psi. Choose EVA™ to get the best of both worlds!

ANTI-VIBRATION PAD PERFORMANCE

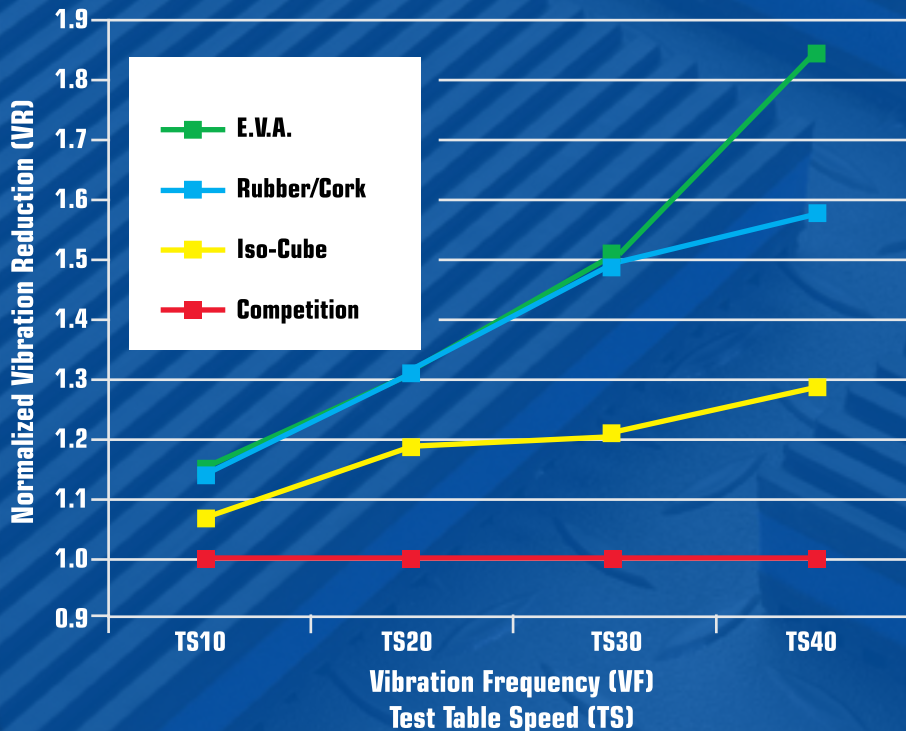

## RUBBER/CORK PAD: The Industry Standard

These pads are made with the highest quality elastomeric oil resistant padding. Designed to withstand 50 psi. The rubber pads are corrugated on both sides and laminated to the cork center.

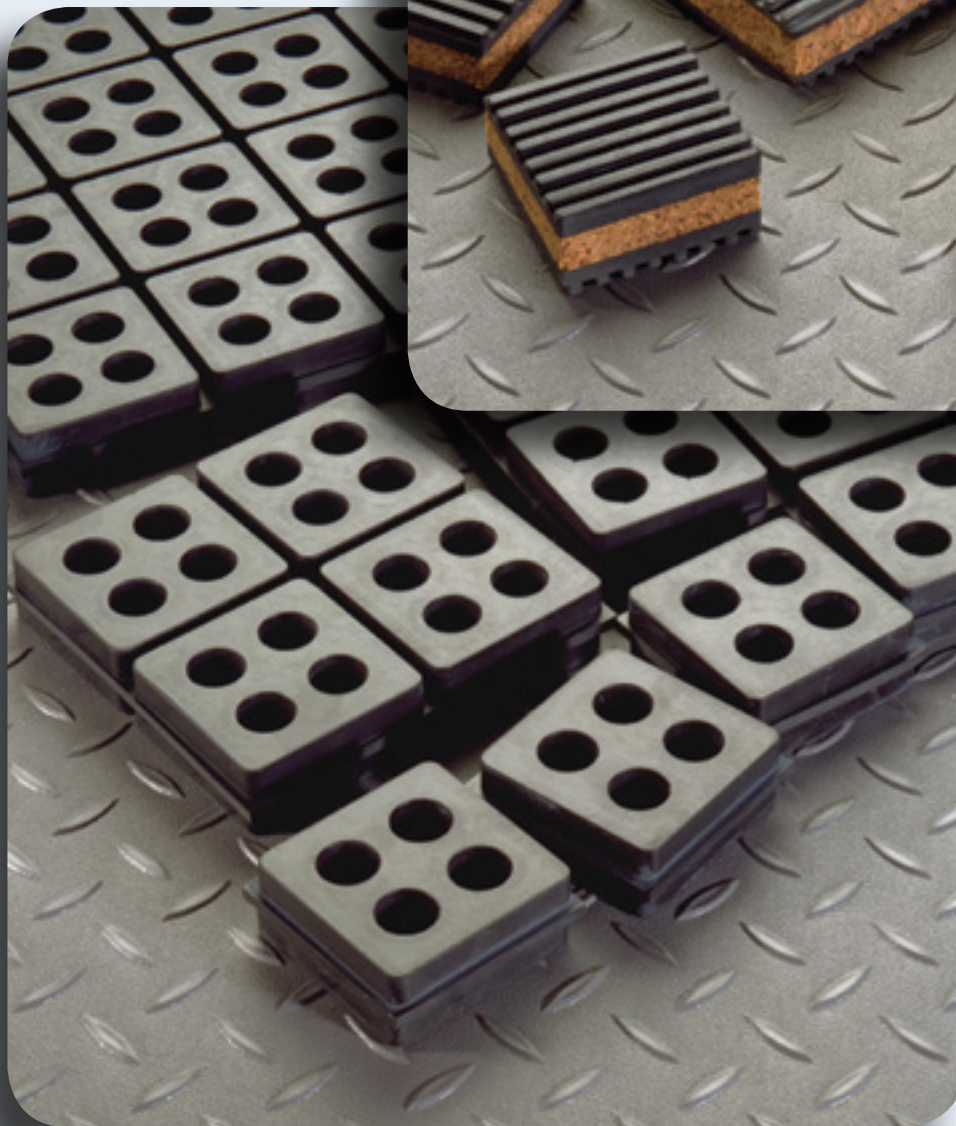
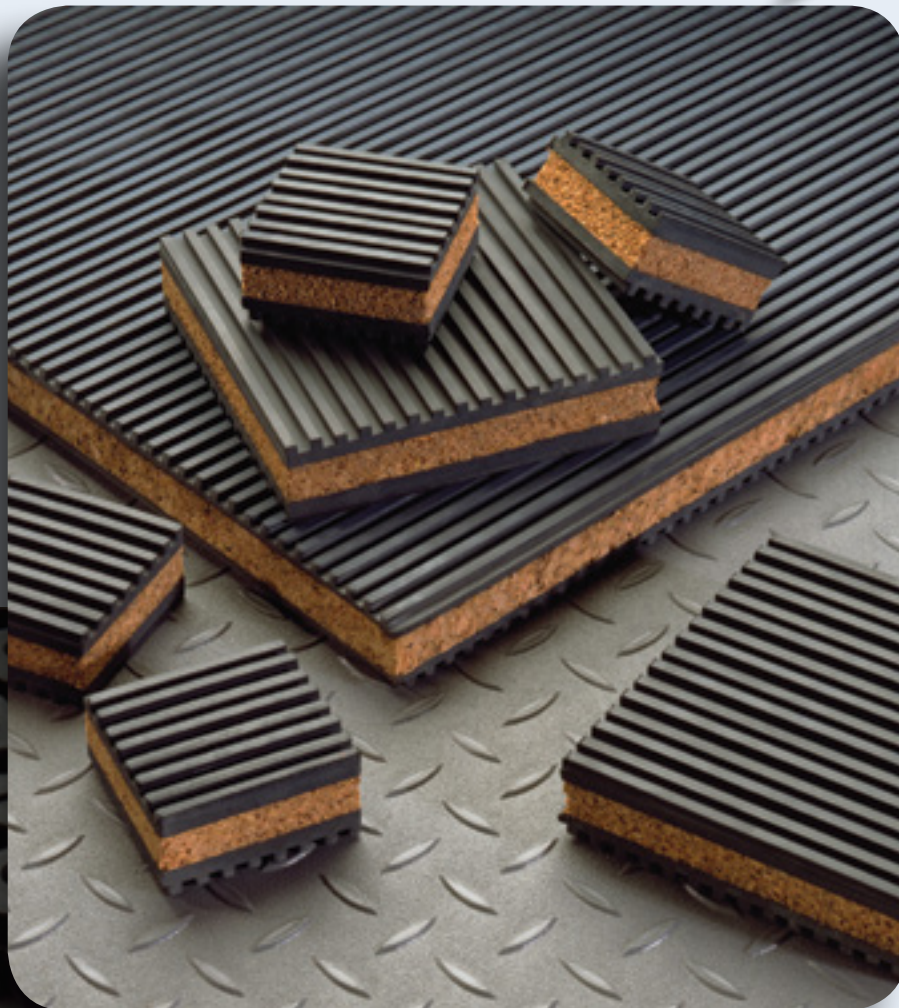

## ISO-CUBE: Solid Rubber Tough

Natural rubber pads designed to reduce vibration and noise emanating from refrigeration or AC equipment. Circular design offers a suction cup effect eliminating the need to bolt the pads down. A standard 18" pad divides into eighty-one 2" segments which may be cut or torn into smaller pads. The 50 durometer pads will withstand a load of 180 psi with great resiliency.

**ULTRALITE® LIGHTWEIGHT CONCRETE EQUIPMENT PADS**

A true concrete equipment pad at the weight of plastic (about 2.5 lbs. per square foot). UltraLite® is strengthened by miles of fiber in each square foot of fiber-cement coating. This fiber allows the pad to flex instead of cracking or breaking. The textured surface prevents the condensing unit or portable generator from sliding, and allows water drainage, while the engineered expanded polystyrene (EPS) core prevents warping and provides a solid bottom to resist settling. Unaffected by soil conditions, ultraviolet (UV) light, temperature extremes, and other weather conditions.

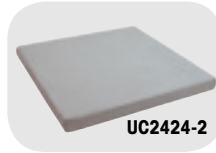

**3" UltraLite® Pads**

Where codes have moved toward requiring 3" pads, UltraLite® is the solution. Check local codes for your requirements.

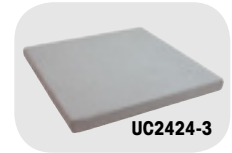

**2" UltraLite® Pads**

The 2" thick UltraLite® pad is the industry standard. Used across a wide variety of applications. Codes have moved toward requiring 3" pads, check local codes for your requirements.

CATALOG NO.	SIZE	PAD WT.	PALLET QTY.	PALLET WT.	UOM	ORDER MULTIPLE
<b>UC1636-2</b>	16 X 36	11	40	250	EA	40
<b>UC2424-2</b>	24 X 24	15	20	323	EA	20
<b>UC2430-2</b>	24 X 30	17	20	361	EA	20
<b>UC2436-2</b>	24 X 36	22	20	455	EA	20
<b>UC2448-2</b>	24 X 48	18	20	385	EA	20
<b>UC2626-2</b>	26 X 26	17	20	365	EA	20
<b>UC2628-2</b>	26 X 28	19	20	397	EA	20
<b>UC3030-2</b>	30 X 30	21	20	441	EA	20
<b>UC3036-2</b>	30 X 36	27	20	571	EA	20
<b>UC3232-2</b>	32 X 32	24	20	501	EA	20
<b>UC3636-2</b>	36 X 36	27	20	555	EA	20
<b>UC3640-2</b>	36 X 40	29	20	608	EA	20
<b>UC3648-2</b>	36 X 48	35	20	725	EA	20
<b>UC4040-2</b>	40 X 40	32	20	644	EA	20

U.S. Patents 7,334,385; 7,232,589; 6,931,822; 6,927,183; 5,728,458; 5,664,394; 5,268,226; 5,209,968, and patents pending. ICBO PFC-5112.

CATALOG NO.	SIZE	PAD WT.	PALLET QTY.	PALLET WT.	UOM	ORDER MULTIPLE
<b>UC1636-3</b>	16 X 36	18	30	297	EA	30
<b>UC1838-3</b>	18 X 38	18	30	297	EA	30
<b>UC2424-3</b>	24 X 24	18	15	294	EA	15
<b>UC2436-3</b>	24 X 36	26	15	412	EA	15
<b>UC2442-3</b>	24 X 42	28	15	441	EA	15
<b>UC2448-3</b>	24 X 48	28	15	443	EA	15
<b>UC2626-3</b>	26 X 26	17	15	279	EA	15
<b>UC3030-3</b>	30 X 30	23	15	370	EA	15
<b>UC3040-3</b>	30 X 40	33	15	517	EA	15
<b>UC3232-3</b>	32 X 32	26	15	411	EA	15
<b>UC3237-3</b>	32 X 37	27	15	436	EA	15
<b>U3353-3</b>	33 X 53	68	15	1,045	EA	15
<b>UC3434-3</b>	34 X 34	27	15	427	EA	15
<b>UC3445-3</b>	34 X 45	39	15	612	EA	15
<b>UC3636-3</b>	36 X 36	34	15	528	EA	15
<b>UC3642-3</b>	36 X 42	32	15	510	EA	15
<b>UC3648-3</b>	36 X 48	37	15	579	EA	15
<b>U3650-3</b>	36 X 50	38	15	595	EA	15
<b>U3654-3</b>	36 X 54	71	15	1,096	EA	15
<b>U3660-3</b>	36 X 60	49	15	767	EA	15
<b>UC3842-3</b>	38 X 42	35	15	550	EA	15
<b>U3865-3</b>	38 X 65	85	15	1,300	EA	15
<b>U3870-3</b>	38 X 70	113	15	1,720	EA	15
<b>UC4040-3</b>	40 X 40	34	15	510	EA	15
<b>UC4042-3</b>	40 X 42	36	15	565	EA	15
<b>U4054-3</b>	40 X 54	81	15	1,240	EA	15
<b>U4550-3</b>	45 X 50	81	15	1,240	EA	15
<b>U4558-3</b>	45 X 58	93	15	1,420	EA	15
<b>U4848-3</b>	48 X 48	85	15	1,300	EA	15
<b>U4854-3</b>	48 X 54	91	15	1,390	EA	15
<b>U4866-3</b>	48 X 66	108	15	1,645	EA	15
<b>U5053-3</b>	50 X 53	92	15	1,405	EA	15
<b>U5056-3</b>	50 X 56	97	15	1,480	EA	15
<b>U5252-3</b>	52 X 52	94	15	1,435	EA	15
<b>U5557-3</b>	55 X 57	109	15	1,660	EA	15

**ULTRALITE® LIGHTWEIGHT CONCRETE EQUIPMENT PADS cont'd**

**3" UltraLite® Wedge Pads**

The UltraLite® Wedge Pad is designed for Lennox condensing units.



CATALOG NO.	SIZE	PAD WT.	PALLET QTY.	PALLET WT.	UOM	ORDER MULTIPLE
<b>UC3132-3L</b>	31 X 32	23.33	15	350	EA	15
<b>UC3539-3L</b>	35 X 39	33.46	15	502	EA	15
<b>UC4044-3L</b>	40 X 44	37.53	15	563	EA	15

**UltraLite® Earthquake Code Compliant Pads**

Required nearly exclusively in Southern California, the UltraLite® pad is available for compliance with strict attachment provisions detailed in earthquake prone local building codes. UltraLite® earthquake code compliant pads are only available for sale in regions where local codes mandate installation of pads with these particular characteristics. Currently these locales include most of Southern California, portions of Washington, and portions of Oregon.



CATALOG NO.	SIZE	PAD WT.	PALLET QTY.	PALLET WT.	UOM	ORDER MULTIPLE
<b>UC1838-3CA</b>	18 X 38	18	15	273	EA	15
<b>UC2424-3CA</b>	24 X 24	14	15	241	EA	15
<b>UC2436-3CA</b>	24 X 36	22	15	349	EA	15
<b>UC2448-3CA</b>	24 X 48*	28	15	443	EA	15
<b>UC2636-3CA</b>	26 X 36	29	15	428	EA	15
<b>UC3030-3CA</b>	30 X 30	22	15	351	EA	15
<b>UC3036-3CA</b>	30 X 36	25	15	400	EA	15
<b>UC3232-3CA</b>	32 X 32	24	15	381	EA	15
<b>UC3636-3CA</b>	36 X 36	28	15	441	EA	15
<b>UC3642-3CA</b>	36 X 42	32	15	510	EA	15
<b>UC3648-3CA</b>	36 X 48	37	15	579	EA	15
<b>UC4040-3CA</b>	40 X 40	34	15	510	EA	15

**E LITE® PLASTIC EQUIPMENT PADS**

E Lite's rugged design provides uniform and generous ribbing for optimum, self-leveling ground support without inserts. The result is a pad that is lightweight, but not too light. A subtle texture prevents unit slide and presents a classic appearance, which is enhanced by rounded edges and a concrete gray color. Each pad is molded with a size label and a symbol representing content of recycled material.



**2" E Lite® Pads**

The 2" thick E Lite® pad is the choice for plastic pads. Codes have moved toward requiring 3" pads, check local codes for your requirements.

CATALOG NO.	SIZE	PAD WT.	PALLET QTY.	PALLET WT.	UOM	ORDER MULTIPLE
<b>EL2424-2</b>	24 X 24	6	44	322	EA	44
<b>EL2430-2</b>	24 X 30	9	22	219	EA	22
<b>EL2436-2</b>	24 X 36	10	22	249	EA	22
<b>EL2626-2</b>	26 X 26	9	22	220	EA	22
<b>EL3030-2</b>	30 X 30	9	22	220	EA	22
<b>EL3036-2</b>	30 X 36	13	22	313	EA	22
<b>EL3040-2</b>	30 X 40	14	22	308	EA	22
<b>EL3232-2</b>	32 X 32	10	22	216	EA	22
<b>EL3434-2</b>	34 X 34	14	22	350	EA	22
<b>EL3636-2</b>	36 X 36	12	22	290	EA	22
<b>EL3640-2</b>	36 X 40	18	22	396	EA	22
<b>EL3648-2</b>	36 X 48	25	22	445	EA	22
<b>EL3842-2</b>	38 X 42	17	22	417	EA	22

**3" E Lite® Pads**

Codes have moved toward requiring 3" pads, check local codes for your requirements.



CATALOG NO.	SIZE	PAD WT.	PALLET QTY.	PALLET WT.	UOM	ORDER MULTIPLE
<b>EL1838-3</b>	18 X 38	9	32	286	EA	32
<b>EL2424-3</b>	24 X 24	9	16	160	EA	16
<b>EL2436-3</b>	24 X 36	12	16	225	EA	16
<b>EL2448-3</b>	24 X 48	14	32	244	EA	32
<b>EL3030-3</b>	30 X 30	12	16	225	EA	16
<b>EL3232-3</b>	32 X 32	13	16	230	EA	16
<b>EL3244-3</b>	32 X 44	21	16	360	EA	16
<b>EL3434-3</b>	34 X 34	17	16	300	EA	16
<b>EL3636-3</b>	36 X 36	16	16	471	EA	16
<b>EL3640-3</b>	36 X 40	23	16	400	EA	16
<b>EL3648-3</b>	36 X 48	25	16	445	EA	16
<b>EL3842-3</b>	38 X 42	18	16	320	EA	16
<b>EL3870-3</b>	38 X 70	36	16	604	EA	16
<b>EL4040-3</b>	40 X 40	26	16	420	EA	16
<b>EL4558-3</b>	45 X 58	43	16	732	EA	16
<b>EL4848-3</b>	48 X 48	36	16	651	EA	16
<b>EL5042-3</b>	50 X 42	28	16	490	EA	16
<b>EL5060-3</b>	50 X 60	40	16	685	EA	16
<b>EL5070-3</b>	50 X 70	47	16	800	EA	16
<b>EL5252-3</b>	52 X 52	40	16	677	EA	16
<b>EL5658-3</b>	56 X 58	55	16	919	EA	16

**CLADLITE® LIGHTWEIGHT CONCRETE EQUIPMENT PADS**

Concrete surface and superior performance at 20% the weight of conventional concrete pads. The cladding provides superior resistance to sun, moisture and freeze-thaw conditions; the engineered expanded polystyrene (EPS) core is virtually impervious to water, soil conditions, fungus and bacteria. Large CladLite® pads are further strengthened by continuous steel reinforcement throughout the cladding. CladLite® is code approved for installation throughout the U.S.

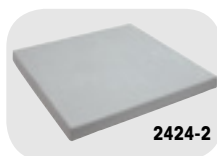

**2424-2**

**2" CladLite® Pads**

The 2" thick CladLite® pad is the choice for equipment pads, Codes have moved toward requiring 3" pads, check local codes for your requirements.

CATALOG NO.	SIZE	PAD WT.	PALLET QTY.	PALLET WT.	UOM	ORDER MULTIPLE
<b>2424-2</b>	24 X 24	36	25	913	EA	25
<b>2436-2</b>	24 X 36	50	25	1,275	EA	25
<b>2442-2</b>	24 X 42	57	25	1,450	EA	25
<b>3030-2</b>	30 X 30	48	25	1,225	EA	25
<b>3036-2</b>	30 X 36	60	25	1,525	EA	25
<b>3040-2</b>	30 X 40	70	25	1,775	EA	25
<b>3143-2</b>	31 X 43	83	25	2,100	EA	25
<b>3232-2</b>	32 X 32	54	25	1,375	EA	25
<b>3434-2</b>	34 X 34	63	25	1,600	EA	25
<b>3636-2</b>	36 X 36	76	25	1,925	EA	25
<b>3640-2</b>	36 X 40	81	25	2,050	EA	25
<b>3648-2</b>	36 X 48	115	25	2,900	EA	25
<b>4147-2</b>	41 X 47	115	25	2,900	EA	25

U.S. Patent number 4,505,449, and patents pending. ICBO No. PFC-5112.

**3" CladLite® Pads**

Used where codes have moved toward requiring 3" pads, check local codes for your requirements.



**2424-3**

CATALOG NO.	SIZE	PAD WT.	PALLET QTY.	PALLET WT.	UOM	ORDER MULTIPLE
<b>1636-3</b>	16 X 36	46	20	945	EA	20
<b>2424-3</b>	24 X 24	49	20	995	EA	20
<b>2436-3</b>	24 X 36	63	20	1,285	EA	20
<b>2448-3</b>	24 X 48	71	20	1,445	EA	20
<b>3030-3</b>	30 X 30	62	20	1,265	EA	20
<b>3036-3</b>	30 X 36	71	20	1,445	EA	20
<b>3040-3</b>	30 X 40	94	20	1,905	EA	20
<b>32-3</b>	32 Round	67	20	1,365	EA	20
<b>3232-3</b>	32 X 32	68	20	1,385	EA	20
<b>3237-3</b>	32 X 37	87	20	1,765	EA	20
<b>3636-3</b>	36 X 36	100	20	2,025	EA	20
<b>3640-3</b>	36 X 40	120	20	2,425	EA	20
<b>3648-3</b>	36 X 48	132	20	2,665	EA	20
<b>3660-3</b>	36 X 60	163	15	2,470	EA	15
<b>3842-3</b>	38 X 42	132	20	2,700	EA	20
<b>4042-3</b>	40 X 42	170	10	1,700	EA	10
<b>4550-3</b>	45 X 50	158	15	2,395	EA	15
<b>4558-3</b>	45 X 58	177	15	2,680	EA	15
<b>4766-3</b>	47 X 66	219	10	2,215	EA	10
<b>4848-3</b>	48 X 48	150	15	2,275	EA	15
<b>5053-3</b>	50 X 53	194	15	2,935	EA	15

**THE HURRICANE PAD™ CONCRETE EQUIPMENT PADS**

**The Hurricane Pad™**

Designed specifically for the hurricane prone regions of Florida and the Gulf Coast, The Hurricane Pad™ meets stringent local code requirements for wind resistance. Heavier than a normal concrete pad, this 4” pad provides sufficient weight to meet code. The Hurricane Pad meets the Florida Building Code Notice and can withstand winds up to 150 MPH. For certain taller equipment, The Hurricane T Class Pad™ is needed. Due to their extra weight, standard freight terms only apply for shipments to Florida. All other shipments are shipped FOB Conyers, GA.

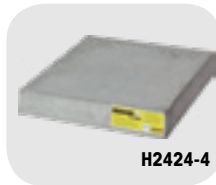

**H2424-4**

CATALOG NO.	SIZE	PALLET QTY.	UOM	ORDER MULTIPLE
H1840-4	18 X 40	16	EA	16
H2424-4	24 X 24	16	EA	16
H2436-4	24 X 36	8	EA	16
H3030-4	30 X 30	8	EA	16
H3232-4	32 X 32	8	EA	16
H3636-4	36 X 36	8	EA	16
H3642-4	36 X 42	8	EA	16
H3648-4	36 X 48	8	EA	16
H3652-4	36 X 52	8	EA	8
H3654-4	36 X 54	8	EA	8
H3656-4	36 X 56	8	EA	8
H3672-4	36 X 72	8	EA	8
H3852-4	38 X 52	8	EA	8
H3865-4	38 X 65	8	EA	8
H3872-4	38 X 72	8	EA	8
H4040-4	40 X 40	8	EA	8
H4242-4	42 X 42	8	EA	8
H4558-4	45 X 58	8	EA	8
H5557-4	55 X 57	8	EA	8

**The Hurricane T-Class Pad™**

The Hurricane T Class Pad™ is even heavier than The Hurricane Pad™ and is designed to meet the higher wind loads of taller equipment. The taller the piece of equipment mounted to the pad, the greater the wind load on the pad. These heavier 4” pads provide sufficient weight to meet code for these taller condensing units. The Hurricane T-Class Pad meets the Florida Building Code Notice and can withstand winds up to 175 MPH. Due to their extra weight, standard freight terms for The Hurricane T Class Pad™ only apply for shipments to Florida. All other shipments are shipped FOB Conyers, GA.



**HT3030-4**

CATALOG NO.	SIZE	PALLET QTY.	UOM	ORDER MULTIPLE
HT1840-4	18 X 24	10	EA	10
HT2436-4	24 X 36	5	EA	5
HT3030-4	30 X 30	5	EA	5
HT3232-4	32 X 32	5	EA	5
HT3636-4	36 X 36	5	EA	5
HT3648-4	36 X 48	5	EA	5
HT3842-4	38 X 42	5	EA	5
HT4040-4	40 X 40	5	EA	5
HT4242-4	42 X 42	5	EA	5
HT4558-4	45 X 58	5	EA	5

**The Hurricane Pad™ MD**

The new Hurricane Pad™ MD is the newest in concrete pad technology from DiversiTech. The Hurricane Pad MD is a solid concrete pad designed for the strict requirements of Miami Dade county. The Hurricane Pad MD meets the Florida Building Code Notice and can withstand winds up to 175 MPH. This pad is made from a minimum 7000PSI solid concrete. For Florida shipments only.

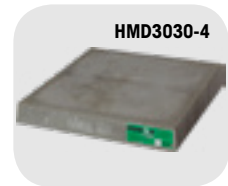

**HMD3030-4**

CATALOG NO.	SIZE	PALLET QTY.	UOM	ORDER MULTIPLE
HMD1840-4	18 X 40 X 4	5	EA	5
HMD3030-4	30 X 30 X 4	5	EA	5
HMD3636-4	36 X 36 X 4	5	EA	5
HMD3648-4	36 X 48 X 4	5	EA	5
HMD4040-4	40 X 40 X 4	5	EA	5

**Potential Hurricane Winds Map**



**The Hurricane Pad Attachment Bracket**

Bracket secures condenser to The Hurricane Pad. Use #8 self drilling or self tapping screws to secure condenser to brackets. Be sure to place brackets according to local building code requirements. Made of 12 gauge ASTM A653 Grade 40 steel with G90 coating.



**HC-1**

CATALOG NO.	DESCRIPTION	UOM	ORDER MULTIPLE
HC-1	The Hurricane Pad Attachment Bracket, pack of 4 PK		1
HC-1-100	The Hurricane Pad Attachment Bracket, pack of 100 PK		1

**THE BLACK PAD® BLACK PLASTIC EQUIPMENT PADS**

The Black Pad® is an innovative equipment pad. The pad is extremely durable, resistant to ultraviolet light, and heavier than a completely plastic pad. The Black Pad® is suitable for use with pool pumps, filters, and heaters and complies with the 1997 Standard Swimming Pool Code sections 305.2 Mounting and section 405 Equipment Foundations and Enclosures.



**ACP24242**

**The Black Pad® — 3"**

Used where codes have moved toward requiring 3" pads. Check local codes for your requirements.



**ACP24243**

**The Black Pad® — 2"**

The 2" thick Black Pad® is the choice for plastic pads. Codes have moved toward requiring 3" pads, check local codes for your requirements.

CATALOG NO.	SIZE	PAD WT.	PALLET QTY.	PALLET WT.	UOM	ORDER MULTIPLE
<b>ACP24242</b>	24 X 24	10	24	240	EA	24
<b>ACP24362</b>	24 X 36	15	24	360	EA	24
<b>ACP30302</b>	30 X 30	13	24	312	EA	24
<b>ACP32322</b>	32 X 32	16	24	384	EA	24
<b>ACP36362</b>	36 X 36	19	24	456	EA	24
<b>ACP38422</b>	38 X 42	25	24	600	EA	24

CATALOG NO.	SIZE	PAD WT.	PALLET QTY.	PALLET WT.	UOM	ORDER MULTIPLE
<b>ACP24243</b>	24 X 24	12	16	192	EA	16
<b>ACP30303</b>	30 X 30	20	16	320	EA	16
<b>ACP32323</b>	32 X 32	25	16	400	EA	16
<b>ACP36363</b>	36 X 36	23	16	368	EA	16
<b>ACP36483</b>	36 X 48	37	16	592	EA	16

**HEF-T-PAD™ PLASTIC EQUIPMENT PADS**

Hef-T-Pad® is an injection molded equipment pad created from high impact polypropylene with UV inhibitors making it easy to handle, yet durable and strong. It does not require any additional equipment for moving and handling. It is resistant to impact, ultra violet degradation and weathering and will not crack, flake, or warp. The Hef-T-Pad® is virtually impervious to climatic variations. It is drillable to permit installation of refrigerant and electrical lines under and through the pad and to allow equipment to be easily secured to the pad.

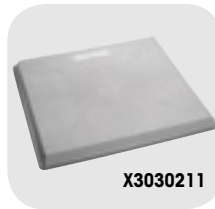

**X3030211**

**Hef-T-Pad® — 3"**

Used where codes have moved toward requiring 3" pads. Check local codes for your requirements.

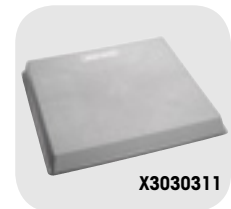

**X3030311**

**Hef-T-Pad® — 2"**

The 2" thick Hef-T-Pad® is the choice for plastic pads. Codes have moved toward requiring 3" pads, check local codes for your requirements.

CATALOG NO.	SIZE	PAD WT.	PALLET QTY.	PALLET WT.	UOM	ORDER MULTIPLE
<b>X2424211</b>	24 X 24 X 2	6	24	208	EA	24
<b>X2430211</b>	24 X 30 X 2	8	24	251	EA	24
<b>X2436211</b>	24 X 36 X 2	10	24	290	EA	24
<b>X3030211</b>	30 X 30 X 2	10	24	290	EA	24
<b>X3232211</b>	32 X 32 X 2	11	24	312	EA	24
<b>X3244211</b>	32 X 44 X 2	14	24	382	EA	24
<b>X3636211</b>	36 X 36 X 2	13	24	367	EA	24
<b>X3836211</b>	38 X 36 X 2	14	24	376	EA	24
<b>X3842211</b>	38 X 42 X 2	17	24	464	EA	24

CATALOG NO.	SIZE	PAD WT.	PALLET QTY.	PALLET WT.	UOM	ORDER MULTIPLE
<b>X2424311</b>	24 X 24 X 3	9	16	200	EA	16
<b>X3030311</b>	30 X 30 X 3	13	16	264	EA	16
<b>X3232311</b>	32 X 32 X 3	16	16	300	EA	16
<b>X3636311</b>	36 X 36 X 3	17	16	319	EA	16
<b>X3848311</b>	38 X 48 X 3	24	16	400	EA	16



## ECOPAD™ BLACK PLASTIC EQUIPMENT PADS

An injection molded equipment pad created from 100% recycled materials to minimize environmental impact. It does not require any additional equipment for moving and handling. EcoPad™ is resistant to impact, ultra-violet degradation and weathering (virtually impervious to climatic variations), and will not crack, flake, or warp. Drillable to permit installation of refrigerant and electrical lines under and through the pad and to allow equipment to easily secure to the pad.



EP2424-2

### EcoPad™ — 3"

Used where codes have moved toward requiring 3" pads, check local codes for your requirements.



EP2424-3

### EcoPad™ — 2"

The 2" thick EcoPad™ is the choice for plastic pads. Codes have moved toward requiring 3" pads, check local codes for your requirements.

CATALOG NO.	SIZE	PAD WT.	PALLET QTY.	PALLET WT.	UOM	ORDER MULTIPLE
EP2424-2	24 X 24 X 2	6	24	322	EA	24
EP2436-2	24 X 36 X 2	10	24	249	EA	24
EP2626-2	26 X 26 X 2	9	24	220	EA	24
EP3030-2	30 X 30 X 2	9	24	220	EA	24
EP3036-2	30 X 36 X 2	13	24	345	EA	24
EP3232-2	32 X 32 X 2	10	24	216	EA	24
EP3434-2	34 X 34 X 2	14	24	350	EA	24
EP3636-2	36 X 36 X 2	12	24	290	EA	24
EP3648-2	36 X 48 X 2	19	24	500	EA	24
EP3842-2	38 X 42 X 2	17	24	417	EA	24

CATALOG NO.	SIZE	PAD WT.	PALLET QTY.	PALLET WT.	UOM	ORDER MULTIPLE
EP1838-3	18 X 38 X 3	9	32	286	EA	32
EP2424-3	24 X 24 X 3	9	16	160	EA	16
EP2436-3	24 X 36 X 3	12	16	225	EA	16
EP2448-3	24 X 48 X 3	14	32	244	EA	32
EP3030-3	30 X 30 X 3	12	16	225	EA	16
EP3232-3	32 X 32 X 3	13	16	230	EA	16
EP3434-3	34 X 34 X 3	21	16	360	EA	16
EP3636-3	36 X 36 X 3	16	16	471	EA	16
EP3640-3	36 X 40 X 3	23	16	400	EA	16
EP3648-3	36 X 48 X 3	25	16	445	EA	16
EP3842-3	38 X 42 X 3	18	16	320	EA	16
EP3870-3	38 X 70 X 3	36	16	604	EA	16
EP4040-3	40 X 40 X 3	26	16	420	EA	16
EP4558-3	45 X 58 X 3	43	16	732	EA	16
EP4848-3	48 X 48 X 3	36	16	651	EA	16
EP5042-3	50 X 42 X 3	28	16	490	EA	16
EP5060-3	50 X 60 X 3	40	16	685	EA	16
EP5070-3	50 X 70 X 3	47	16	800	EA	16
EP5252-3	52 X 52 X 3	40	16	677	EA	16
EP5658-3	56 X 58 X 3	55	16	919	EA	16

## HEAT PUMP PAD™

### Heat Pump Pad™

Provides an effective base for heat pump equipment installed in snowy climates. Rather than a combination of a typical 2" (or 3") equipment pad and 6" heat pump risers, the Heat Pump Pad™ provides a full 8" of elevation in a simple square footprint. The star pattern of the integral risers allows for installation of equipment with different size footprints up to 36" x 36". Also included are eight anti vibration pads uniquely designed to fit into the guide slots on the top of the integral risers. The base is sloped outward to allow for easy drainage of condensate or defrost cycle condensate when the outdoor coil is operating in heat pump mode. Nestable for efficient shipping, transportation, and warehousing. Injection molded from concrete gray, recycled polypropylene material, the Heat Pump Pad™ is environmentally friendly and designed to last longer than the equipment it supports. US Patent Number 7,891,635, and other patent(s) pending.



HP3636-8



Stackable!

CATALOG NO.	DESCRIPTION	UOM	ORDER MULTIPLE
HP3232-8	32" x 32" x 8"	EA	16
HP3636-8	36" x 36" x 8"	EA	16

ANTI-VIBRATION PADS

**E.V.A. Anti-Vibration Pad**

The latest generation in vibration dampening technology. The most effective vibration dampening pad available on the market. The EVA Pad was tested against other pads at four different vibration settings. In the most severe vibration extremes, the EVA Pad outperforms cork and rubber by a margin of greater than 3:1! This is due to the special composite foam center which is much more structurally sound than cork. It is not affected by oils or chemicals that can break down cork and is much more effective at vibration dampening than solid rubber. All this at a very competitive price. Designed to withstand 50 psi.

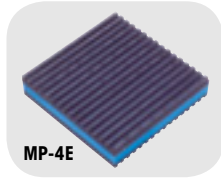

CATALOG NO.	DESCRIPTION	UOM	ORDER MULTIPLE
<b>MP-2E</b>	2" x 2" x 7/8" E.V.A. Pad	EA	48
<b>MP-3E</b>	3" x 3" x 7/8" E.V.A. Pad	EA	36
<b>MP-4E</b>	4" x 4" x 7/8" E.V.A. Pad	EA	24
<b>MP-6E</b>	6" x 6" x 7/8" E.V.A. Pad	EA	24
<b>MP-12E</b>	12" x 12" x 7/8" E.V.A. Pad	EA	12
<b>MP-18E</b>	18" x 18" x 7/8" E.V.A. Pad	EA	6

**Rubber Anti-Vibration Pad**

Highest quality elastomeric oil resistant padding. Designed to withstand 50 lbs. psi. The rubber pads are corrugated on both sides. Ideal for air conditioners, compressors, cooling towers, presses, machines, etc.

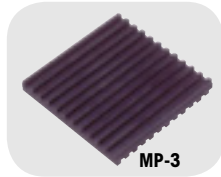

CATALOG NO.	DESCRIPTION	UOM	ORDER MULTIPLE
<b>MP-2</b>	2" x 2" x 3/8" Rubber	EA	48
<b>MP-3</b>	3" x 3" x 3/8" Rubber	EA	36
<b>MP-4</b>	4" x 4" x 3/8" Rubber	EA	24
<b>MP-6</b>	6" x 6" x 3/8" Rubber	EA	24
<b>MP-8</b>	8" x 8" x 3/8" Rubber	EA	12
<b>MP-12</b>	12" x 12" x 3/8" Rubber	EA	12
<b>MP-18</b>	18" x 18" x 3/8" Rubber	EA	6

**Rubber/Cork Anti-Vibration Pad**

Highest quality elastomeric oil resistant padding. Designed to withstand 50 psi. The rubber pads are corrugated on both sides. The cork is laminated between two corrugated pads. Ideal for air conditioners, compressors, cooling towers, presses, machines, etc.

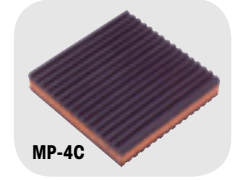

CATALOG NO.	DESCRIPTION	UOM	ORDER MULTIPLE
<b>MP-2C</b>	2" x 2" x 7/8" Rubber/Cork	EA	48
<b>MP-3C</b>	3" x 3" x 7/8" Rubber/Cork	EA	36
<b>MP-4C</b>	4" x 4" x 7/8" Rubber/Cork	EA	24
<b>MP-6C</b>	6" x 6" x 7/8" Rubber/Cork	EA	24
<b>MP-8C</b>	8" x 8" x 7/8" Rubber/Cork	EA	12
<b>MP-12C</b>	12" x 12" x 7/8" Rubber/Cork	EA	12
<b>MP-18C</b>	18" x 18" x 7/8" Rubber/Cork	EA	6

**Iso-Cube Economy Anti-Vibration Pad**

Natural rubber pads, designed to reduce vibration and noise emanating from refrigeration and air conditioning equipment. The circular design in each pad offers a suction cup effect, which eliminates the need to bolt the pads down. A standard 18" (46cm) pad is divided into eighty-one 2" (5cm) segments, each of which may be cut or torn to provide smaller pads. These 50 durometer pads will withstand a load of 180 psi with greater resiliency.



CATALOG NO.	DESCRIPTION	UOM	ORDER MULTIPLE
<b>ISO-2</b>	2" x 2" x 3/4" Iso-Cube	EA	24
<b>ISO-4</b>	4" x 4" x 3/4" Iso-Cube	EA	12
<b>ISO-18</b>	18" x 18" x 3/4" Iso-Cube	EA	6

# MOUNTING SYSTEMS

Equipment Stands .....	33-34
Hanging Brackets.....	35
Heat Pump Risers .....	30
Hooks, Springs & Fixture Support.....	42
Mini-Split Stands .....	32
Mounting Blocks.....	30-31
Mounting Brackets.....	31-32
Mounting Straps .....	42-43
Spring Fitting & Beam Clamps .....	40-41
Strut Clips & Clamps .....	38-39
Strut, Threaded Rod & Accessories.....	39-40

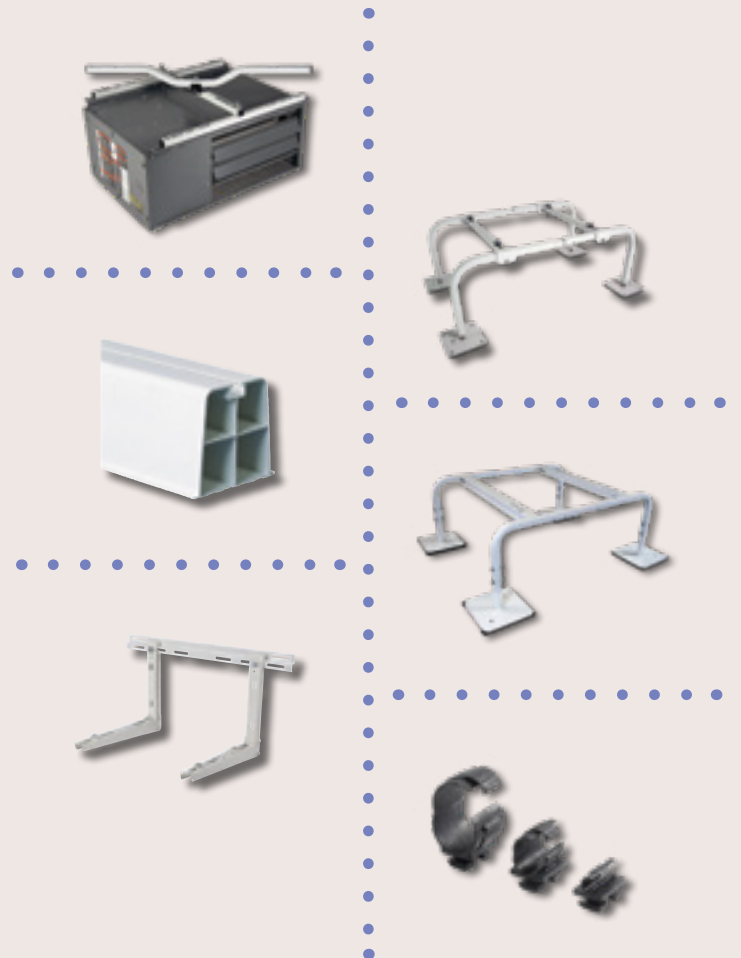



## MINI-SPLIT OUTDOOR UNIT STANDS

QSMS1201

## MINI-SPLIT WALL BRACKETS

QSWB2000



## UNIT HEATER SWIVEL BRACKETS

QSWI3000





**SUPER STAND**®  
QSSS1019

**CASSETTE  
HANGER**  
QSCH1000



# Hef-T-Foot™

*Recycled rubber condensing unit and accessory mounting blocks.*



## ROOFTOP INSTALLATIONS



*Hef-T-Foot™ —  
Rooftop/Ground Mount  
Installation*



*Hef-T-Foot™ —  
Rooftop/Ground Mount  
Accessory/Pipe Support  
Installation*

## UTILITY ROOM INSTALLATIONS



*Hef-T-Foot™ —  
Utility Room Installation,  
Gravity Drain*

**Condensate management is needed for heat pumps.**



*Hef-T-Foot™ —  
Utility Room Installation,  
Condensate Pump*

## Hef-T-Bracket™ — Wall Mounted Mini-Split Brackets



### HEF-T-BRACKET™ TYPE 2

These brackets feature a cross bar that is attached to a wall and two L-shaped brackets that are hooked and bolted into place on the cross bar.

When operating in heat pump mode, the unit will produce condensate which is easily captured and managed using this snap on drain pan.

## HEAT PUMP RISERS

### One Piece Heat Pump Risers

Sturdy and stable, DiversiTech's Heat Pump Riser provides the desired elevation for condensers, heat pumps, and air handlers. The one piece, heavy duty plastic unit is manufactured in three heights. Butyl mastic on the top and bottom guarantees no slipping and reduced vibration and noise.



CATALOG NO.	DESCRIPTION	UOM	ORDER MULTIPLE
<b>HPR-3</b>	Riser – 3"	EA	48
<b>HPR-3BL</b>	Riser – 3", Black	EA	48
<b>HPR-6</b>	Riser – 6"	EA	36
<b>HPR-6BL</b>	Riser – 6", Black	EA	36
<b>HPR-12</b>	Riser – 12"	EA	16

### Two Piece Heat Pump Risers

Sturdy and stable, DiversiTech's Heat Pump Riser provides the desired elevation for condensers, heat pumps, and air handlers. The one piece, heavy duty plastic unit is manufactured in two heights and an extension. Butyl mastic on the top and bottom guarantees no slipping and reduced vibration and noise.



CATALOG NO.	DESCRIPTION	UOM	ORDER MULTIPLE
<b>HPR-3-2P</b>	Two Piece Riser – 3"	EA	32
<b>HPR-6-2P</b>	Two Piece Riser – 6"	EA	16
<b>HPR-3-2PG</b>	Two Piece Black Riser – 3"	EA	32
<b>HPR-6-2PG</b>	Two Piece Black Riser – 6"	EA	16
<b>HPR-EXT</b>	4" Extension	EA	28

### Adjustable Equipment Risers

Adjustable equipment risers easily adjust up or down as needed to secure equipment at the correct height. The large center barrel twists up from starting height of 5" to a max of 8". A separate top cap allows for raising or lowering the riser even with equipment already on it. Convenient height markings provided for reference.



CATALOG NO.	DESCRIPTION	UOM	ORDER MULTIPLE
<b>AER-8</b>	Adjustable Equipment Riser - 8"	EA	4
<b>AER-8BL</b>	Adjustable Equipment Riser - 8" Black	EA	4

## MOUNTING BLOCKS

### Air Handler Block

Lightweight styrofoam block (concrete gray) provides A/C air handler support in attic installations.

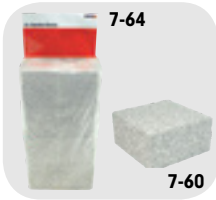

CATALOG NO.	DESCRIPTION	UOM	ORDER MULTIPLE
<b>7-60</b>	Air Handler Block 8" x 8" x 4"	EA	144
<b>7-64</b>	Air Handler Block 8" x 8" x 4", pack of 4	PK	4

### Base Pad

Used as a mounting base when condensing units must be bolted down. Maximum load capacity is 220 lbs. per pad. Sliding rail design for easy and fast installation. Includes mounting bolts. Available in 17" lengths. Ivory color.



CATALOG NO.	DESCRIPTION	UOM	ORDER MULTIPLE
<b>230-BP17W</b>	17" Base Pad, pack of 2	PK	10

### Furnace Mounting Blocks

Each furnace mounting block can support 40% more weight than competitive products – over 500 pounds! Easy peel and stick installation.



CATALOG NO.	DESCRIPTION	UOM	ORDER MULTIPLE
<b>FB-1</b>	Furnace Mounting Block	EA	72

### Hef-T-Block™

Used as mounting bases when condensing units must be bolted down. Available in three lengths. Furnished complete with end caps and mounting bolts. Maximum load capacity is 440 pounds per mounting block. Installation temperature range from -4°F (-20°C) to 140°F (60°C). Hef T Blocks fit all mini split condensing units with a unique sliding rail feature.



CATALOG NO.	DESCRIPTION	UOM	ORDER MULTIPLE
<b>230-MB14W</b>	14" Hef-T-Block™ (White), pack of 2	PK	6
<b>230-MB17W</b>	17" Hef-T-Block™ (White), pack of 2	PK	6
<b>230-MB36W</b>	36" Hef-T-Block™ (White), pack of 2	PK	2
<b>230-MBCW</b>	Hef-T-Block™ Replacement End Cap (White), pack of 4	PK	25



**MOUNTING BLOCKS** cont'd

**Hef-T-Foot™**

The Hef-T-Foot™ is used to support small pipework, runs of cable tray, or an alternative to supporting condensing units, air source heat pumps or a variety of outdoor equipment.

The Hef-T-Foot™ with strut comes in four lengths — 9.8", 15.7", 23.6", 39.4". They are manufactured from heavy duty recycled rubber and come complete with .8" x 1.6" galvanized steel strut adhered to the rubber with industrial adhesive. The rubber is strong and durable with drain slots moulded into the underside to allow standing water to flow under the foot.



**Hef-T-Foot™ Installation Variants**



CATALOG NO.	DESCRIPTION	UOM	ORDER MULTIPLE
<b>FF-250-S</b>	Hef-T-Foot™ – 9.8" with 1.6" x .8" strut	EA	1
<b>FF-400-S</b>	Hef-T-Foot™ – 15.7" with 1.6" x .8" strut	EA	1
<b>FF-600-S</b>	Hef-T-Foot™ – 23.6" with 1.6" x .8" strut	EA	1
<b>FF-1000-S</b>	Hef-T-Foot™ – 39.4" with 1.6" x .8" strut	EA	1
<b>FF-250-UNI</b>	Hef-T-Foot™ – 9.8" Universal	EA	1

**MOUNTING BRACKETS**

**Boiler Bracket**

Our boiler bracket works well with all wall hung boilers and tankless hot water heaters available.



CATALOG NO.	DESCRIPTION	UOM	ORDER MULTIPLE
<b>QSBB1000</b>	Boiler Bracket Wall Hung	EA	1
<b>QSBB2000</b>	Boiler Bracket Leg Kit	EA	1

**Hef-T-Bracket™**

Used for supporting condensing units, Hef-T-Brackets (Type 2) feature a cross bar that is attached to a wall, and two L shaped brackets that are hooked and bolted into place on the cross bar. The condensing unit is mounted onto the L shaped brackets, and fastened using the bolts and anti vibration washers provided.

\*Not approved for South Florida.



CATALOG NO.	DESCRIPTION	ARM LENGTH	LOAD RATING PER ARM	UOM	ORDER MULTIPLE
<b>230-B2M</b>	Hef-T-Bracket™ – Medium	18"	176#	EA	1
<b>230-B2L</b>	Hef-T-Bracket™ – Large	21"	176#	EA	1

**Wall Brackets - Flat Wall**

The QSWB1000 Condenser Wall Bracket provides a quick and safe mount that is perfectly designed for installation to a flat wall surface and can hold up to 500lbs. It also has the flexibility to be installed in the up and out orientation or down and out.



CATALOG NO.	DESCRIPTION	UOM	ORDER MULTIPLE
<b>QSWB1000</b>	Mini Split Wall Bracket	EA	1

**Wall Brackets - Siding**

This condenser wall bracket combines the installation flexibility of the QSWB1000 and the slider track mounting rail of the QSWB2000 to create a Heavy Duty, versatile mounting solution.



CATALOG NO.	DESCRIPTION	UOM	ORDER MULTIPLE
<b>QSWB1100</b>	Wall Bracket w/Rails Light Dty	EA	1

**MOUNTING BRACKETS cont'd**

**Wall Bracket - Siding**

These hurricane rated wall brackets are strong, easy to install and are designed to be mounted into framing studs at 12" or 16" on center. These fit most mini-split models on the market today and provides the required distance between the wall and the condenser for optimal air flow. The QSWB2000 is rated for 300lbs and the heavy duty QSWB4000 is rated for 600lbs. Both models are also available in 316 stainless steel.



CATALOG NO.	DESCRIPTION	UOM	ORDER MULTIPLE
<b>QSWB2000</b>	Wall Bracket w/Z Bend	EA	1
<b>QSWB2000SS</b>	Wall Bracket w/Z Bend	EA	1
<b>QSWB4000</b>	Wall Bracket w/Z Bend	EA	1
<b>QSWB4000SS</b>	Wall Bracket w/Z Bend	EA	1

**Wall Bracket - Foundation Mount**

This unique, 300lb condenser mounting bracket is designed to install directly to a foundation and still provides 7" clearance between the wall and the unit. The shelf depth is 19" and allows plenty of room for piping and service.



CATALOG NO.	DESCRIPTION	UOM	ORDER MULTIPLE
<b>QSWB3000</b>	Wall Bracket w/Rails Heavy Duty	EA	1

**Air Conditioner Brackets**

These heavy duty 10ga thick steel AC brackets are perfect for hanging A/C condensers and heat pumps outside the home. Mount at any height to allow for easy maintenance under units. No need to wait for finished grade or landscaping prior to installation of AC unit. Pre punched holes for easy installation. Powder coated gray finish. Load rating 600 lbs. per pair.

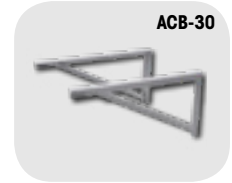

CATALOG NO.	DESCRIPTION	UOM	ORDER MULTIPLE
<b>ACB-30</b>	AC Mounting Bracket - 30", pack of 2	PK	1
<b>ACB-36</b>	AC Mounting Bracket - 36", pack of 2	PK	1
<b>ACB-42</b>	AC Mounting Bracket - 42", pack of 2	PK	1
<b>ACB-48</b>	AC Mounting Bracket - 48", pack of 2	PK	1

**MINI-SPLIT STANDS**

**Mini-Split Stands**

Our Quick-Sling® Mini-Split Stands provide a safe, stable platform to mount your unit on. It keeps unit elevated above lawn mowers, weed whackers, pets, snow, and flooding. The elevated height allows for ease of installation, maintenance and service. **Now available in Stainless Steel.**



CATALOG NO.	DESCRIPTION	UOM	ORDER MULTIPLE
<b>QSMS1200</b>	Mini-Split Stand Thin - 12"	EA	1
<b>QSMS1201</b>	Mini-Split Stand Wide - 12"	EA	1
<b>QSMS1201SS</b>	Mini-Split Stand Wide - 12" Stainless Steel	EA	1
<b>QSMS1800</b>	Mini-Split Stand Thin - 18"	EA	1
<b>QSMS1801</b>	Mini-Split Stand Wide - 18"	EA	1
<b>QSMS1801SS</b>	Mini-Split Stand Wide - 18" Stainless Steel	EA	1
<b>QSMS2400</b>	Mini-Split Stand Thin - 24"	EA	1
<b>QSMS2401</b>	Mini-Split Stand Wide - 24"	EA	1
<b>QSMS2401SS</b>	Mini-Split Stand Wide - 24" Stainless Steel	EA	1

**Mini-Split Dual Fan Stands**

Our Quick-Sling® Mini-Split Dual Fan Stands provide a safe, stable platform to mount your unit on. It keeps unit elevated above lawn mowers, weed whackers, pets, snow, and flooding. The elevated height allows for ease of installation, maintenance and service.



CATALOG NO.	DESCRIPTION	UOM	ORDER MULTIPLE
<b>QSMS1202</b>	Mini-Split Dual Fan Stand - 12"	EA	1
<b>QSMS1802</b>	Mini-Split Dual Fan Stand - 18"	EA	1
<b>QSMS2402</b>	Mini-Split Dual Fan Stand - 24"	EA	1

**Mini-Split Double Stack Stand**

Our Quick-Sling® Mini-Split Double Stack Stand provide a safe, stable platform to mount your unit on. It keeps unit elevated above lawn mowers, weed whackers, pets, snow, and flooding. The elevated height allows for ease of installation, maintenance and service.



CATALOG NO.	DESCRIPTION	UOM	ORDER MULTIPLE
<b>QSMS1203</b>	Mini-Split Double Stack Stand	EA	1

**Ductless Cassette Hangers**

The Ductless Cassette Hangers are an innovative bracket design that is made of light-weight aluminum to provide quick and easy installation of ductless cassettes. Only two sku's are compatible with most of the ductless cassettes on the market today. The built-in adjustability allows the alignment of the unit after it has been hung.



CATALOG NO.	DESCRIPTION	UOM	ORDER MULTIPLE
<b>QSCH1000</b>	Ductless Cassette Hanger - Small Holds up to 200lbs.	EA	1
<b>QSCH2000</b>	Ductless Cassette Hanger - Large Holds up to 200lbs.	EA	1

EQUIPMENT STANDS

### Air Handler Base – Heavy Duty Adjustable

Made of 14 gauge galvanized steel for excellent corrosion resistance and longevity. 22" high x 22" deep. Width is adjustable from 16" – 26". Supports up to 200 lbs.



6-HAB-BG

CATALOG NO.	DESCRIPTION	UOM	ORDER MULTIPLE
6-HAB-BG	Steel Air Handler Base	EA	1

### Horizontal Air Handler Stand

Our Quick-Stand is made of 14-gauge square tubing. This not only cuts down on vibration but allows the stand to hold up to 500 lbs. Each leg individually extends in 1" increments using thumb screws & wing nuts for speed and versatility. Installs as low as 22" on flat or uneven surfaces.



QSTD1000



CATALOG NO.	DESCRIPTION	UOM	ORDER MULTIPLE
QSTD1000	Quick-Stand Heavy Duty	EA	1
QSTD2000	Quick-Stand Light Duty	EA	1

### Mini-Split Super Stand

The Quick Sling Mini-Split Super Stand accommodates up to 6 outdoor mini-split condensing units on a single stand. With the addition of the extender kits condensing units can be added in increments of 2 per kit. The Mini-Split Super Stand is made from the same heavy-duty steel structural design as the VRF Super Stands.



QSMS3001-12



CATALOG NO.	DESCRIPTION	UOM	ORDER MULTIPLE
QSMS3001-12	Mini-Split Super Stand, 6 systems, 12" High	EA	1
QSMS3001-18	Mini-Split Super Stand, 6 systems, 18" High	EA	1
QSMS3001-24	Mini-Split Super Stand, 6 systems, 24" High	EA	1
QSMS3001-12EXT	Mini-Split Super Stand Extender Kit, 2 systems, 12" High	EA	1
QSMS3001-18EXT	Mini-Split Super Stand Extender Kit, 2 systems, 18" High	EA	1
QSMS3001-24EXT	Mini-Split Super Stand Extender Kit, 2 systems, 24" High	EA	1

### Heat Pump Stand

Our 18" Quick-Sling® Heat Pump Stand provides a safe stable platform to mount your unit on. Keep it elevated above lawn mowers, weed whackers, pets, snow, and flooding. Elevated height allows for ease of installation, service, and maintenance.



QSTD3000



CATALOG NO.	DESCRIPTION	UOM	ORDER MULTIPLE
QSTD3000	Quick Heat Pump Stand	EA	1

### Vertical Air Handler Stand

Our Quick-Sling® Vertical Air Handler Stand fits all LG, Unico and Mitsubishi Air Handlers. It is adjustable left to right in 1" increments up to 6". 18" and 24" stands include 2 stability arms. 500 lbs Max Capacity.



QSTD4000



CATALOG NO.	DESCRIPTION	UOM	ORDER MULTIPLE
QSTD4000	12" Vert Air Hdler Std 19" Arm	EA	1
QSTD4001	12" Vert Air Hdler Std 23" Arm	EA	1
QSTD4002	12" Vert Air Hdler Std 27" Arm	EA	1
QSTD5000	18" Vert Air Hdler Std 19" Arm	EA	1
QSTD5001	18" Vert Air Hdler Std 23" Arm	EA	1
QSTD5002	18" Vert Air Hdler Std 27" Arm	EA	1
QSTD6000	24" Vert Air Hdler Std 19" Arm	EA	1
QSTD6001	24" Vert Air Hdler Std 23" Arm	EA	1
QSTD6002	24" Vert Air Hdler Std 27" Arm	EA	1

## VRF/VRV/HRV Super Stand®

Super Stands come with single and double-sided U Bars to accommodate any multi-unit combination.

## U Bar Details:

- 1.5" x 1.5" - U Bars made from 11 gauge steel square tubing.
- Adjustable width in 1" increments.
- Adjustable height in 1/4" and 1/2" increments.
- Rubber roof friendly.
- 12" x 12" feet made from 7 gauge steel with 3/8" holes for mounting.



**QUICK-SLING**  
by DiversiTech

CATALOG NO.	DESCRIPTION	UOM	ORDER MULTIPLE
QSSS1003-12	Super Stand 12" Type A	EA	1
QSSS1003-18	Super Stand 18" Type A	EA	1
QSSS1003-24	Super Stand 24" Type A	EA	1
QSSS1004-12	Super Stand 12" Type B	EA	1
QSSS1004-18	Super Stand 18" Type B	EA	1
QSSS1004-24	Super Stand 24" Type B	EA	1
QSSS1005-12	Super Stand 12" Type C	EA	1
QSSS1005-18	Super Stand 18" Type C	EA	1
QSSS1005-24	Super Stand 24" Type C	EA	1
QSSS1006-12	Super Stand 12" Type A+A	EA	1
QSSS1006-18	Super Stand 18" Type A+A	EA	1
QSSS1006-24	Super Stand 24" Type A+A	EA	1
QSSS1007-12	Super Stand 12" Type A+C	EA	1
QSSS1007-18	Super Stand 18" Type A+C	EA	1
QSSS1007-24	Super Stand 24" Type A+C	EA	1
QSSS1008-12	Super Stand 12" Type B+B	EA	1
QSSS1008-18	Super Stand 18" Type B+B	EA	1
QSSS1008-24	Super Stand 24" Type B+B	EA	1
QSSS1009-12	Super Stand 12" Type B+C	EA	1
QSSS1009-18	Super Stand 18" Type B+C	EA	1
QSSS1009-24	Super Stand 24" Type B+C	EA	1
QSSS1010-12	Super Stand 12" Type C+C	EA	1
QSSS1010-18	Super Stand 18" Type C+C	EA	1
QSSS1010-24	Super Stand 24" Type C+C	EA	1
QSSS1011-12	Super Stand 12" Type C+A+A	EA	1
QSSS1011-18	Super Stand 18" Type C+A+A	EA	1
QSSS1011-24	Super Stand 24" Type C+A+A	EA	1
QSSS1012-12	Super Stand 12" Type A+B+C	EA	1
QSSS1012-18	Super Stand 18" Type A+B+C	EA	1
QSSS1012-24	Super Stand 24" Type A+B+C	EA	1
QSSS1013-12	Super Stand 12" Type A+C+C	EA	1
QSSS1013-18	Super Stand 18" Type A+C+C	EA	1
QSSS1013-24	Super Stand 24" Type A+C+C	EA	1
QSSS1014-12	Super Stand 12" Type B+C+C	EA	1
QSSS1014-18	Super Stand 18" Type B+C+C	EA	1
QSSS1014-24	Super Stand 24" Type B+C+C	EA	1
QSSS1015-12	Super Stand 12" Type C+C+C	EA	1
QSSS1015-18	Super Stand 18" Type C+C+C	EA	1
QSSS1015-24	Super Stand 24" Type C+C+C	EA	1
QSSS1016-12	Super Stand 12" Type A+A+A	EA	1
QSSS1016-18	Super Stand 18" Type A+A+A	EA	1
QSSS1016-24	Super Stand 24" Type A+A+A	EA	1
QSSS1017-12	Super Stand 12" Type A+B+B	EA	1
QSSS1017-18	Super Stand 18" Type A+B+B	EA	1
QSSS1017-24	Super Stand 24" Type A+B+B	EA	1
QSSS1018-12	Super Stand 12" Type B+B+B	EA	1
QSSS1018-18	Super Stand 18" Type B+B+B	EA	1
QSSS1018-24	Super Stand 24" Type B+B+B	EA	1
QSSS1019-12	Super Stand 12" Type D	EA	1

CATALOG NO.	DESCRIPTION	UOM	ORDER MULTIPLE
QSSS1019-18	Super Stand 18" Type D	EA	1
QSSS1019-24	Super Stand 24" Type D	EA	1
QSSS1020-12	Super Stand 12" Type D+D	EA	1
QSSS1020-18	Super Stand 18" Type D+D	EA	1
QSSS1020-24	Super Stand 24" Type D+D	EA	1
QSSS1021-12	Super Stand 12" Type D+D+D	EA	1
QSSS1021-18	Super Stand 18" Type D+D+D	EA	1
QSSS1021-24	Super Stand 24" Type D+D+D	EA	1
QSSS1022-12	Super Stand 12" Type A+B	EA	1
QSSS1022-18	Super Stand 18" Type A+B	EA	1
QSSS1022-24	Super Stand 24" Type A+B	EA	1
QSSS1023-12	Super Stand 12" Type A+A+B	EA	1
QSSS1023-18	Super Stand 18" Type A+A+B	EA	1
QSSS1023-24	Super Stand 24" Type A+A+B	EA	1
QSSS1024-12	Super Stand 12" Type A+D	EA	1
QSSS1024-18	Super Stand 18" Type A+D	EA	1
QSSS1024-24	Super Stand 24" Type A+D	EA	1
QSSS1025-12	Super Stand 12" Type A+D+D	EA	1
QSSS1025-18	Super Stand 18" Type A+D+D	EA	1
QSSS1025-24	Super Stand 24" Type A+D+D	EA	1
QSSS1026-12	Super Stand 12" Type A+A+D	EA	1
QSSS1026-18	Super Stand 18" Type A+A+D	EA	1
QSSS1026-24	Super Stand 24" Type A+A+D	EA	1
QSSS1027-12	Super Stand 12" Type A+A+D+D	EA	1
QSSS1027-18	Super Stand 18" Type A+A+D+D	EA	1
QSSS1027-24	Super Stand 24" Type A+A+D+D	EA	1
QSSS1028-12	Super Stand 12" Type B+B+D	EA	1
QSSS1028-18	Super Stand 18" Type B+B+D	EA	1
QSSS1028-24	Super Stand 24" Type B+B+D	EA	1
QSSS1029-12	Super Stand 12" Type C+D+B	EA	1
QSSS1029-18	Super Stand 18" Type C+D+B	EA	1
QSSS1029-24	Super Stand 24" Type C+D+B	EA	1
QSSS1030-12	Super Stand 12" Type B+D	EA	1
QSSS1030-18	Super Stand 18" Type B+D	EA	1
QSSS1030-24	Super Stand 24" Type B+D	EA	1
QSSS1031-12	Super Stand 12" Type B+B+C	EA	1
QSSS1031-18	Super Stand 18" Type B+B+C	EA	1
QSSS1031-24	Super Stand 24" Type B+B+C	EA	1
QSSS36	Super Stand Cross Rail - 36 in.	EA	1
QSSS48	Super Stand Cross Rail - 48 in.	EA	1
QSSS55	Super Stand Cross Rail - 55 in.	EA	1
QSSS70	Super Stand Cross Rail - 70 in.	EA	1
QSSS100-12	Super Stand U Bar - Single	EA	1
QSSS100-12	Super Stand U Bar - Double	EA	1

\*NOTE: Please contact Diversitech for additional configurations.

Cross Rail Types: Type A: 36" Cross Rail; Type B: 48" Cross Rail; Type C: 70" Cross Rail; Type D: 55" Cross Rail

### Quick-Sling® - Air Handler Hanging Bracket

Our Quick-Sling is made of 14-gauge square tubing. This not only cuts down on vibration but allows the stand to hold up to 400 lbs. Extension arms individually adjust in one inch increments using thumb screws & wing nuts for speed & versatility. Installs as high as 24" or as low as 48" on flat or pitched roofs.



**QSLG1000**  
QUICK-SLING®  
by DiversiTech

CATALOG NO.	DESCRIPTION	UOM	ORDER MULTIPLE
<b>QSLG1000</b>	Sling Bracket Light Duty 1 Arm	EA	1
<b>QSLG2000</b>	Sling Bracket Heavy Duty 2 Arm	EA	1

### Quick Swivel "U" Mount - Unit Heater Bracket

Our Quick Swivel is made of 14-gauge steel able to hold 200 lbs. The swivel allows for 360° rotation for setting the perfect direction of air flow.



**QSWI1000**  
QUICK-SLING®  
by DiversiTech

CATALOG NO.	DESCRIPTION	UOM	ORDER MULTIPLE
<b>QSWI1000</b>	Swivel "U" Mount w/H-Bracket	EA	1
<b>QSWI2000</b>	Swivel "U" Mount w/I-Bracket	EA	1

### Quick Swivel Flush Mount w/"H" Bracket - Unit Heater Bracket

Our Quick Swivel is made of 14-gauge steel able to hold 200 lbs. The swivel allows for 360° rotation for setting the perfect direction of air flow.



**QSWI3000**  
QUICK-SLING®  
by DiversiTech

CATALOG NO.	DESCRIPTION	UOM	ORDER MULTIPLE
<b>QSWI3000</b>	Swivel Flush H Bracket	EA	1
<b>QSWI3001</b>	Swivel Flush H Bracket 36" Spd	EA	1
<b>QSWI3002</b>	Swivel Flush H Bracket 17" Spd	EA	1

### Quick Swivel Flush Mount w/"I" Bracket - Unit Heater Bracket

Our Quick Swivel is made of 14-gauge steel able to hold 200 lbs. The swivel allows for 360° rotation for setting the perfect direction of air flow.



**QSWI4000**  
QUICK-SLING®  
by DiversiTech

CATALOG NO.	DESCRIPTION	UOM	ORDER MULTIPLE
<b>QSWI4000</b>	Swivel Flush w/ I Bracket	EA	1
<b>QSWI5000</b>	Swivel Flush Heavy Duty	EA	1
<b>QSWI6000</b>	Swivel Flush w/2 I Brackets	EA	1

### Quick-Sling® Accessories - Steel & Wood Beam Adapters

- The QSAC1000 (set of 4) & 1100 (set of 2) steel beam adapters are made out of aluminum & able to hold up to 250 lbs each.
- Each QSAC1000 is slotted to receive 3/8 threaded rod or C - clamps for easy mounting.
- The QSAC2000 (set of 4) & 2100 (set of 2) wood beam adapters are made of steel & are 12" long & 2" wide.
- Each of our adapters are able to hold up to 200 lbs.
- They have a 1.5" bend that simply clips over the wood joist. All the necessary hardware is provided.
- QSAC1000 and QSAC2000 adapts: QSLG1000 & QSLG2000
- QSAC1100 and QSAC2100 adapts: QSWI1000 & QSWI2000



**QSAC1000**  
QUICK-SLING®  
by DiversiTech

CATALOG NO.	DESCRIPTION	UOM	ORDER MULTIPLE
<b>QSAC1000</b>	Adapters, Steel Pk of 4	EA	1
<b>QSAC1100</b>	Adapters, Steel Pk of 2	EA	1
<b>QSAC2000</b>	Adapters, Wood Pk of 4	EA	1
<b>QSAC2100</b>	Adapters, Wood Pk of 2	EA	1



# RAPID POSITIONING CLIPS

The RPC line of mounting clips are cost-effective and time-saving solutions for refrigeration, A/C tubing, PEX piping, conduits and cabling support. Their unique, simple and effective one-piece design requires no tools and they are 20 times faster to install when compared to the traditional mounting clamps.



All RPC clips are made from durable polyamide material and have a wide working temperature range from -40°F to 284°F (-40°C to 140°C). They meet the UL2043 requirement for plenum rating and have the UL94 HB flame rating, suitable for use in air handling spaces.



## Product Type

### Rapid Positioning Clips

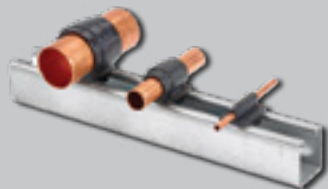

- Prevent cracking and fracturing of joints by allowing secured pipe to expand.
- Available in 9 sizes to fit pipes with 1/4" to 1-5/8" outer diameter (OD).

### InsulClips



- Ideal for insulated pipes, these clips maintain the vapor barrier seal in the insulation and eliminate sweating on metal fittings.
- Available in 11 sizes to fit pipes with 5/8" to 2-1/8" outer diameter (OD).

### Studded Clips



- Ideal for insulated pipes, these clips maintain the vapor barrier seal in the insulation and eliminate sweating on metal fittings.
- Available in 11 sizes to fit pipes with 5/8" to 2-1/8" outer diameter (OD) for 5/16" (M8) or 3/8" (M10) threaded rod size.

### Cable Tie Channel Clips



- Work with PVC or metal cable ties with width up to 11/16" (17mm).
- Available in 3 sizes.

## Features and Benefits

### Fast installation, 20 times faster!



With their unique and simple one-piece design, installation takes seconds versus minutes for the traditional methods. Less time, more money!

### No tools required!



Easy to install. Can be done with one hand. No need to worry about finding the right tool for the job!

### Fits onto standard size strut channel or threaded rods.



Designed for a wide variety of applications. The Rapid Positioning Clips, InsulClips and Cable Tie Channel Clips fit directly into a standard 1-5/8" wide strut channel. The Studded Clips fit directly onto a 5/16" (M8) or 3/8" (M10) size threaded rod.

### Strong and Lightweight!



All clips are made of a strong and lightweight, black composite Nylon. This eliminates metal to metal contact and corrosion problems.

### Meets UL2043 requirements, plenum rated.



All clips are compliant with UL2043 and suitable for use in air handling spaces.

**STRUT CLIPS & CLAMPS**

**Rapid Positioning Clips**

Rapid Positioning Clips fit directly into vertical and horizontal standard 1-5/8" strut channels. No tool required to install. Use for refrigeration, A/C tubing, PEX piping, and conduit support. They prevent cracked and fractured joints by allowing secured pipe to expand. The clips are UL2043 compliant and suitable for Plenum spaces. They are heat, light and U.V. stabilized for outdoor use. Available in 9 sizes to fit pipes with 1/4" to 1-5/8" outer diameter.



CATALOG NO.	TUBE O.D. (inch)	UOM	ORDER MULTIPLE
<b>RPC-0014</b>	1/4"	10 Pack	1
<b>RPC-0038</b>	3/8"	10 Pack	1
<b>RPC-0012</b>	1/2"	10 Pack	1
<b>RPC-0058</b>	5/8"	10 Pack	1
<b>RPC-0034</b>	3/4"	10 Pack	1
<b>RPC-0078</b>	7/8"	10 Pack	1
<b>RPC-0118</b>	1-1/8"	10 Pack	1
<b>RPC-0138</b>	1-3/8"	10 Pack	1
<b>RPC-0158</b>	1-5/8"	10 Pack	1

\*Add "-100" to the end of part numbers for 100 pieces pack.

**InsulClips**

InsulClips fit directly into vertical and horizontal standard 1-5/8" strut channels. No tool required to install. Use for refrigeration, A/C tubing, PEX piping, conduit and cabling support. They are ideal for insulated pipes, to maintain vapor seal of the insulation and eliminates sweating. The clips are UL2043 compliant and suitable for Plenum spaces. They are heat, light and U.V. stabilized for outdoor use. Available in 11 sizes to fit pipes with 5/8" to 2-1/8" outer diameter.



CATALOG NO.	TUBE O.D. (inch)	UOM	ORDER MULTIPLE
<b>IC00-15</b>	5/8"	10 Pack	1
<b>IC00-20</b>	3/4"	10 Pack	1
<b>IC00-22</b>	7/8"	10 Pack	1
<b>IC00-25</b>	1"	10 Pack	1
<b>IC00-28</b>	1-1/8"	10 Pack	1
<b>IC00-32</b>	1-1/4"	10 Pack	1
<b>IC00-35</b>	1-3/8"	10 Pack	1
<b>IC00-40</b>	1-1/2"	10 Pack	1
<b>IC00-42</b>	1-5/8"	10 Pack	1
<b>IC00-50</b>	2"	10 Pack	1
<b>IC00-54</b>	2-1/8"	10 Pack	1

\*Add "-100" to the end of part numbers for 100 pieces pack.

**Studded Clips**

Studded Clips fit directly onto 5/16" (M8) or 3/8" (M10) size threaded rods. No tool required to install. Use for refrigeration, A/C tubing, PEX piping, conduit, and cabling support. The clips are UL2043 compliant and suitable for Plenum spaces. They are heat, light and U.V. stabilized for outdoor use. Available in 11 sizes to fit pipes with 5/8" to 2-1/8" outer diameter.



CATALOG NO.	ROD SIZE	TUBE O.D. (inch)	UOM	ORDER MULTIPLE
<b>SC08-15</b>	5/16"	5/8"	10 Pack	1
<b>SC08-20</b>	5/16"	3/4"	10 Pack	1
<b>SC08-22</b>	5/16"	7/8"	10 Pack	1
<b>SC08-25</b>	5/16"	1"	10 Pack	1
<b>SC08-28</b>	5/16"	1-1/8"	10 Pack	1
<b>SC08-32</b>	5/16"	1-1/4"	10 Pack	1
<b>SC08-35</b>	5/16"	1-3/8"	10 Pack	1
<b>SC08-40</b>	5/16"	1-1/2"	10 Pack	1
<b>SC08-42</b>	5/16"	1-5/8"	10 Pack	1
<b>SC08-50</b>	5/16"	2"	10 Pack	1
<b>SC08-54</b>	5/16"	2-1/8"	10 Pack	1
<b>SC10-15</b>	3/8"	5/8"	10 Pack	1
<b>SC10-20</b>	3/8"	3/4"	10 Pack	1
<b>SC10-22</b>	3/8"	7/8"	10 Pack	1
<b>SC10-25</b>	3/8"	1"	10 Pack	1
<b>SC10-28</b>	3/8"	1-1/8"	10 Pack	1
<b>SC10-32</b>	3/8"	1-1/4"	10 Pack	1
<b>SC10-35</b>	3/8"	1-3/8"	10 Pack	1
<b>SC10-40</b>	3/8"	1-1/2"	10 Pack	1
<b>SC10-42</b>	3/8"	1-5/8"	10 Pack	1
<b>SC10-50</b>	3/8"	2"	10 Pack	1
<b>SC10-54</b>	3/8"	2-1/8"	10 Pack	1

\*Add "-100" to the end of part numbers for 100 pieces pack.

**Cable Tie Channel Clips**

Cable Tie Channel Clips fit directly into vertical and horizontal standard 1-5/8" strut channels. No tool required to install. Use for refrigeration, A/C tubing, PEX piping, conduit and cabling support. The clips are compliant with UL2043 and suitable for Plenum spaces. They are heat, light and U.V. stabilized for outdoor use. They accommodate PVC or metal cable ties up to a width of 11/16" (17mm). Three support base lengths available in 2" (50mm), 2-1/2" (65mm) and 3" (80mm).



CATALOG NO.	LENGTH	UOM	ORDER MULTIPLE
<b>CTC-050</b>	2"	10 Pack	1
<b>CTC-065</b>	2-1/2"	10 Pack	1
<b>CTC-080</b>	3"	10 Pack	1

\*Add "-100" to the end of part numbers for 100 pieces pack.



**STRUT CLIPS & CLAMPS cont'd**

**Cushion Clamps**

An industry standard universal clamp that mounts to standard strut. Steel with electrochromate finish to resist corrosion. The lock nut has a nylon insert for a positive lock. The polymeric grommet withstands temperatures from -25°C TO 125°C and resists the effects of most oils, chemicals, and industrial cleaning compounds.



538-1/4

CATALOG NO.	DESCRIPTION	UOM	ORDER MULTIPLE
<b>538-1/4</b>	Clamp Cushion - 1/4"	EA	25
<b>538-3/8</b>	Clamp Cushion - 3/8"	EA	25
<b>538-1/2</b>	Clamp Cushion - 1/2"	EA	25
<b>538-5/8</b>	Clamp Cushion - 5/8"	EA	25
<b>538-3/4</b>	Clamp Cushion - 3/4"	EA	25
<b>538-7/8</b>	Clamp Cushion - 7/8"	EA	25
<b>538-1-1/8</b>	Clamp Cushion - 1-1/8"	EA	10
<b>538-1-3/8</b>	Clamp Cushion - 1-3/8"	EA	10
<b>538-1-5/8</b>	Clamp Cushion - 1-5/8"	EA	10
<b>538-2-1/8</b>	Clamp Cushion - 2-1/8"	EA	10
<b>538-2-5/8</b>	Clamp Cushion - 2-5/8"	EA	10
<b>538-3-1/8</b>	Clamp Cushion - 3-1/8"	EA	10
<b>538-4-1/8</b>	Clamp Cushion - 4-1/8"	EA	10

**Universal Strut Clamp**

A highly versatile Universal Strut Clamp. Fits both pipe (rigid conduit)/IMC and thin walled tubing (EMT) in the corresponding sizes. Secures conduit to strut. Zinc Electro-Plate Finish.



17532

CATALOG NO.	PINCH SIZE (inch)	O.D. (inch)	DESIGN LOAD (Lbs)	UOM	ORDER MULTIPLE
<b>17532</b>	1/2"	0.773"	400	EA	100
<b>17533</b>	3/4"	0.986"	600	EA	100
<b>17534</b>	1"	1.239"	600	EA	100
<b>17535</b>	1-1/4"	1.585"	600	EA	50
<b>17536</b>	1-1/2"	1.820"	800	EA	50
<b>17537</b>	2"	2.286"	800	EA	50

**Rigid Strut Clamp**

Extra durable Zinc Electroplate Finished Strut Clamps to secure rigid and IMC conduits and pipes to struts. The Clamps with 2-1/2" through 8" diameter are suitable for rigid and EMT conduits.



17515

CATALOG NO.	PINCH SIZE (inch)	O.D. (inch)	DESIGN LOAD (Lbs)	UOM	ORDER MULTIPLE
<b>17515</b>	3/4"	1.050"	600	EA	100
<b>17516</b>	1"	1.315"	600	EA	100
<b>17518</b>	1-1/2"	1.900"	800	EA	50
<b>17519</b>	2"	2.375"	800	EA	50
<b>17520</b>	2-1/2"	2.875"	800	EA	50
<b>17521</b>	3"	3.500"	800	EA	25
<b>17522</b>	3-1/2"	4.000"	1000	EA	25
<b>17523</b>	4"	4.500"	1000	EA	25

**EMT Strut Clamp**

Zinc Electroplate Finished Strut Clamps to secure EMT conduits and pipes to struts.



17542

CATALOG NO.	PINCH SIZE (inch)	O.D. (inch)	DESIGN LOAD (Lbs)	UOM	ORDER MULTIPLE
<b>17542</b>	1/2"	0.706"	400	EA	100
<b>17543</b>	3/4"	0.922"	400	EA	100
<b>17544</b>	1"	1.163"	600	EA	100
<b>17545</b>	1-1/4"	1.510"	600	EA	50
<b>17546</b>	1-1/2"	1.740"	800	EA	50
<b>17547</b>	2"	2.197"	800	EA	50

**STRUT, THREADED ROD AND ACCESSORIES**

**Strut Channel**

Robust Strut Channels made of pre-galvanized steel with 11/8" x 9/16" slots on 2" centers.



ST15810

CATALOG NO.	DESCRIPTION	SIZE	UOM	ORDER MULTIPLE
<b>ST15810</b>	12 Gauge Strut Channel	1-5/8" x 1-5/8" x 10'	EA	20

**Threaded Rod**

3/8" Threaded Rods for multiple applications including conduit, pipe and cable installation.



TR3810

CATALOG NO.	DESCRIPTION	SIZE	UOM	ORDER MULTIPLE
<b>TR3806</b>	3/8" Threaded Rod	6'	EA	25
<b>TR3810</b>	3/8" Threaded Rod	10'	EA	25

**STRUT, THREADED ROD AND ACCESSORIES cont'd**

**Channel Nuts**

Spring Channel Nuts to attach a threaded rod to a strut. They are available with short springs for 13/16" & 1" channels and with regular springs for 1-3/8" & 1-5/8" channels. Zinc Electroplate finished.



CATALOG NO.	DESCRIPTION	THREAD	THICKNESS	UOM	ORDER MULTIPLE
17412	Channel Nut-Short Spring	1/4" - 20"	.25"	EA	100
17420	Channel Nut-Short Spring	3/8" - 16"	.37"	EA	100
17430	Channel Nut-Regular Spring	1/4" - 20"	.25"	EA	100
17438	Channel Nut-Regular Spring	3/8" - 16"	.37"	EA	100
17442	Channel Nut-Regular Spring	1/2" - 13"	.50"	EA	100

**Connection Plates for 1-5/8" Strut Channels**

Connection Plates are used to connect strut channels to each other. Splice plates allow to make extensions by connecting several channels while corner and angle plates make 90° connections. All plates are manufactured of steel with Zinc Electroplate finish, are 1/4" thick, and designed to be used with 1-5/8" strut channels.



CATALOG NO.	DESCRIPTION	UOM	ORDER MULTIPLE
17616	Square Washer 3/8"	EA	100
17618	Square Washer 1/2"	EA	100
17626	4 Hole Splice Plate	EA	25
17628	2 Hole Corner Angle	EA	50
17630	2 Hole Cross Corner Angle	EA	50
17632	3 Hole Corner Plate	EA	25
17633	3 Hole Cross Corner Angle	EA	50
17634	4 Hole 3 Way Corner Angle	EA	25
17636	4 Hole Tee Plate	EA	20
17638	2 Hole Open 45° Corner Angle	EA	25

**Channel Post Base for 1-5/8" Strut Channels**

A Post Base secures a strut assembly to the floor or other surfaces. These Post Bases are made of galvanized steel and are available as 2 and 4 hole, heavy-duty, mounting option.



CATALOG NO.	DESCRIPTION	SIZE	UOM	ORDER MULTIPLE
17450	Post Base 2 Hole	4" x 6"	EA	5
17452	Post Base 4 Hole, Corner Orientation	6" x 6"	EA	5
17454	Post Base 4 Hole, Side Orientation	6" x 6"	EA	5

**Strut to Beam Clamps**

These clamps connect a beam to a strut installation. They are designed for a load up to 1200 lbs. when used in pairs. Zinc Electroplate Finish.



CATALOG NO.	DESCRIPTION	UOM	ORDER MULTIPLE
17462	Beam Clamp for 13/16" & 1-5/8" Channel	EA	25
17464	Beam Clamp for 2-7/16" & 3-1/4" Channel	EA	25

**Plastic White End Caps**

Plastic White End Caps are used to cover the ends of a strut channel. Made of soft PVC material they provide a safe, smooth capping.

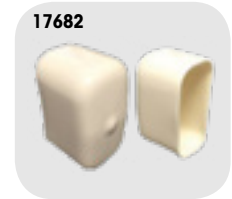

CATALOG NO.	DESCRIPTION	UOM	ORDER MULTIPLE
17682	Plastic White End Caps for 13/16" Channel	EA	100
17684	Plastic White End Caps for 1-5/8" Channel	EA	100

**SPRING FITTINGS & BEAM CLAMPS**

**Beam Clamps**

This fast-installing Beam Clamp fits beam flanges up to 1/2". It can be used with 1/4" and 3/8" threaded rod, "S" hooks, conduit hangers, electrical boxes, and #10-24 or 1/4"-20 bridle rings.



CATALOG NO.	DESCRIPTION	UOM	ORDER MULTIPLE
18016	Beam Clamp	EA	100

**Spring Steel Beam Clamps**

Spring Steel Clamps allow to suspend boxes, fixtures and bridle rings to 1/8" through 3/4" beam flanges.



CATALOG NO.	DESCRIPTION	FLANGE THICKNESS	STATIC LOAD	UOM	ORDER MULTIPLE
18123	Spring Steel Beam Clamps 1/4"-20 x 3/8" Stud	1/8" to 1/4"	75Lbs	EA	100
18124	Spring Steel Beam Clamps 5/16" to 1/2" 1/4"-20 x 3/8" Stud	1/8" to 1/4"	75Lbs	EA	100
18018	Spring Steel Beam Clamps Universal	1/8" to 1/4"	200Lbs	EA	100

**SPRING FITTINGS & BEAM CLAMPS cont'd**

**Flange Mount Conduit Assembly - Bottom Mount**

The Assembly suspends a conduit from the bottom of a beam with a Posi-Lock mechanism. It installs with a hammer only and can pivot 360°. The rated static load limit is 75 lbs.



CATALOG NO.	DESCRIPTION	FLANGE THICKNESS	FITS CONDUIT	UOM	ORDER MULTIPLE
<b>18200</b>	Flange Mount Conduit Assembly - Bottom Mount - Posi-Lock	1/8"-1/4"	3/8"	EA	100
<b>18050</b>	Flange Mount Conduit Assembly - Bottom Mount - Posi-Lock	1/8"-1/4"	1/2" - 3/4"	EA	100
<b>18202</b>	Flange Mount Conduit Assembly - Bottom Mount - Posi-Lock	1/8"-1/4"	1	EA	100

**Flange Mount Conduit Assembly - Side Mount**

The Assembly suspends a conduit from the side of a beam with a Posi-Lock mechanism. It installs with a hammer only and can pivot 360°. The rated static load limit is 25 lbs.



CATALOG NO.	DESCRIPTION	FLANGE THICKNESS	FITS CONDUIT	UOM	ORDER MULTIPLE
<b>18231</b>	Flange Mount Conduit Assembly - Side Mount - Posi-Lock	1/8"-1/4"	1/2" - 3/4"	EA	100
<b>18232</b>	Flange Mount Conduit Assembly - Side Mount - Posi-Lock	1/8"-1/4"	1"	EA	100
<b>18240</b>	Flange Mount Conduit Assembly - Side Mount - Posi-Lock	5/16"-1/2"	1/2" - 3/4"	EA	100

**Beam Clamp to Conduit Hanger Assembly**

The Spring Steel Beam Clamp with a Pre-Installed Posi-Lock conduit hanger is available for bottom and side mount of conduits. The rated static load is 100 lbs. for the vertical, and 25 lbs. for the horizontal installation.

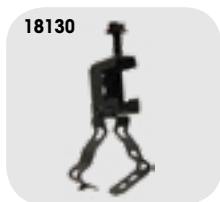

CATALOG NO.	DESCRIPTION	FITS CONDUITS	UOM	ORDER MULTIPLE
<b>18130</b>	Bottom Mount	1/2"-3/4"	EA	100
<b>18140</b>	Side Mount	1/2"-3/4"	EA	100

**Z Purlin Hanger**

Z Purlin Angled Flange Hangers are used to attach threaded rod or hooks and straps to an angled Z purlin. The Hangers are holding up to 100 lbs.



CATALOG NO.	DESCRIPTION	FOR USE WITH	UOM	ORDER MULTIPLE
<b>18180</b>	Z Purlin Flange Hanger	Flange from 1/16" to 1/4"	EA	100
<b>18160</b>	Z Purlin Rod Hanger Assembly	1/4" Threaded Rod	EA	100
<b>18161</b>	Z Purlin Rod Hanger Assembly	3/8" Threaded Rod	EA	100

**Spring Steel Cable Clip**

The Cable Clip for MC, AC, or BX support 14-2, 14-3 & 12-2 cables in horizontal or vertical position.

NOTE: The product is designed for positioning only, with no load rating.



CATALOG NO.	DESCRIPTION	FOR USE WITH	UOM	ORDER MULTIPLE
<b>18026</b>	Spring Steel Cable Clips	OD's from .433 to .535	EA	100

## HOOKS, SPRINGS AND FIXTURE SUPPORT

### Bridle Rings

Zinc-Plated Bridle Rings are a good support for communication cables & other low voltage uses. They are available as Bolt-On, commonly used with Beam Clamps, and as Screw-In, commonly used with Wooden Beams. The Cable Support Bridle Rings with saddle are a cost-effective alternative to expensive cable tray. Their wide surface saddle provides support without stress for Category 5, fiber-optic, and other sensitive voice/Datacom cables.



CATALOG NO.	DESCRIPTION	RING DIAMETER	THREAD	UOM	ORDER MULTIPLE
18421	Bridle Rings - Bolt-On	1/4" - 20"	1/4" -20	EA	100
18422	Bridle Rings - Bolt-On	2"	1/4" -20	EA	100
18425	Bridle Rings - Screw-On	1"	3/16"	EA	100
18426	Bridle Rings - Screw-On	1-1/2"	1/4"	EA	100
18427	Bridle Rings - Screw-On	2"	1/4"	EA	100
18058	Bridle Rings - Bolt-On with Saddle	2"	1/4"-20	EA	50
18060	Bridle Rings - Bolt-On with Saddle	4"	1/4"-20	EA	50

### Box Stabilizer Support

This Stabilizer for electrical boxes is made of pre-galvanized steel. The box support is designed to be screwed to 2-1/2", 3-1/2" & 4" wood or metal studs.



CATALOG NO.	STUD SIZE	UOM	ORDER MULTIPLE
18370	2-1/2", 3-1/2"	EA	100
18052	2-1/2", 3-1/2", 4"	EA	100

### J-Hooks

2" J Hooks for Datacom applications are a cost-effective alternative to expensive cable tray. Their wide base provides support without stress for Cat5, fiber-optic and other sensitive voice/Datacom cables. The continuous wide base radius supports the natural curve of cables and ensures eliminating kinks & bending. A cable wire retainer is supplied with every part. Its unique design eliminates the need for an attachment plate when stacked. These J-Hooks can be attached to a wide variety of structures using beam clamps, clips and many other components.



CATALOG NO.	DESCRIPTION	UOM	ORDER MULTIPLE
18056	J Hooks - 2", Screw Mount	EA	25

### Box To T-Bar Fastener

A Snap-On 24" span box hanger with dual height adjustment that allows flush or 3/4" offset mounting of boxes. It is produced of pre-galvanized steel with spring steel hardware and has 1 BBC mounting clip with screw included.



CATALOG NO.	DESCRIPTION	UOM	ORDER MULTIPLE
18054	24" Span Box to T-Bar Fastener	EA	100

### T-Bar Scissor Clips

This 2-piece T-Bar Scissor Clip mounts fixtures or boxes to a 1" T-bar. Includes a wing nut washer. Static Load Limit of 100 lbs.



CATALOG NO.	DESCRIPTION	UOM	ORDER MULTIPLE
18387	24" Span Box to T-Bar Fastener	EA	50

## MOUNTING STRAPS

### 2 Hole PVC Pipe Straps

Designed to accommodate Schedule 40 PVC Conduit. The Heavy-Duty Polythene material resists deterioration from UV rays and breakage from extreme cold.



CATALOG NO.	TRADE SIZE	UOM	ORDER MULTIPLE
19490	1/2"	EA	100
19492	3/4"	EA	100
19494	1"	EA	100
19496	1-1/4"	EA	50
19498	1-1/2"	EA	50
19500	2"	EA	50
19501	2-1/2"	EA	25
19502	3"	EA	25
19503	4"	EA	25

### BX 1 Hole Strap

These one-hole pipe straps are ideal for hanging tubing, pipe, conduit and BX cable. They are made of pre-galvanized zinc plated steel with a reinforced rib for extra strength.



CATALOG NO.	CABLE SIZE	UOM	ORDER MULTIPLE
19463	BX: 14 - 2 Thru 10 - 3	EA	100

### 1 Hole EMT Pipe Straps - Steel

Zinc Plated Steel Pipe Straps with a reinforced hole and rib for extra strength to secure EMT conduits. Easy Snap-On installation.



CATALOG NO.	TRADE SIZE	UOM	ORDER MULTIPLE
<b>19400</b>	1/2"	EA	100
<b>19401</b>	3/4"	EA	100
<b>19402</b>	1"	EA	100

### 1 Hole Rigid Pipe Straps - Heavy Duty – Steel

The 1 Hole Rigid Pipe Strap is made of zinc plated steel with a reinforced hole and rib for heavy duty applications. It can be easily Snap-On installed and is used to secure Rigid & IMC conduit.



CATALOG NO.	TRADE SIZE	UOM	ORDER MULTIPLE
<b>19426</b>	1"	EA	25

### 2 Hole Rigid Pipe Straps - Steel

The 2 Hole Rigid Zinc Plated Steel Pipe Straps with reinforced holes and rib for extra strength are used to secure Rigid & IMC conduit. Easy Snap-On installation.



CATALOG NO.	TRADE SIZE	UOM	ORDER MULTIPLE
<b>19438</b>	1"	EA	25
<b>19439</b>	1-1/4"	EA	20
<b>19440</b>	1-1/2"	EA	10
<b>19441</b>	2"	EA	5
<b>19443</b>	3"	EA	1
<b>19444</b>	4"	EA	1
<b>19445</b>	5"	EA	1
<b>19446</b>	6"	EA	1

# Patch It Up!

Item # FP-36

## Repair almost any surface with Flexi-Patch™

- Extremely durable fiberglass reinforced patch
- Flexible and waterproof
- Weather and UV resistant
- Temperature safe from -30°C to 365°C
- Will not shrink or expand during or after application
- Bonds to all surfaces except polypropylene
- Cure quickly – as fast as 5 minutes.

Flexi-Patch™ is an easy to use flexible repair patch ideal for repairing almost any surface. It cures quickly using only UV light from sunlight or a UV flashlight for a long lasting, permanent repair. Flexi-Patch is a fiberglass-reinforced polyester ideal for use on PVC, plastics, metal, wood, concrete and more. It's the easy way to permanently patch almost any surface. It dries hard for permanent repair. Can be drilled, tapped and painted once dry.



**BEFORE**

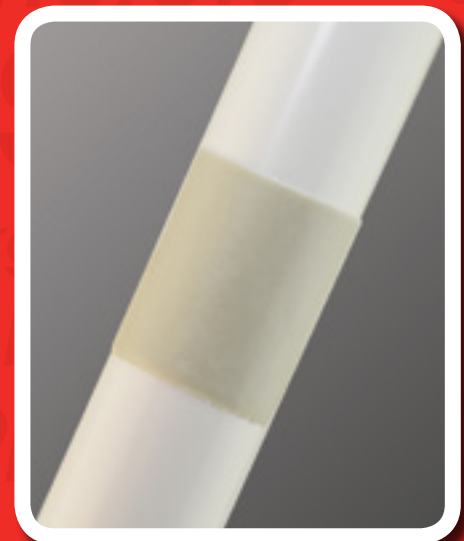

**AFTER**



Display  
box of 20

**DIVERSiTECH**®

# AIR MOVEMENT

Dryer Duct, Vent Hose, Hose Clamps .....	48-49
Duct Strap, Ties, Clamps .....	49-50
Pure-Beam™ Ultraviolet Light .....	48
Tapes .....	50
Ventilation Products.....	47



# PURE-BEAM™ Ultraviolet Light

*The Pure-Beam™ ultraviolet light is designed for HVAC air disinfection and surface irradiation. Exposure to Pure-Beam™ significantly reduces air contamination caused by fungus, mold, and viruses and can cleanse surfaces overcome by mold and slime.*

- The Pure-Beam™ ultraviolet light is an excellent way to maintain indoor air quality.
- This UV Light includes a ballast, transformer, and bracket for even more convenience.
- Overall dimensions are small which makes installation easy.
- The included transformer allows operation using 120, 208, and 240/220 VAC power.
- UV lights are unobtrusive and transparent in operation, requiring little maintenance.

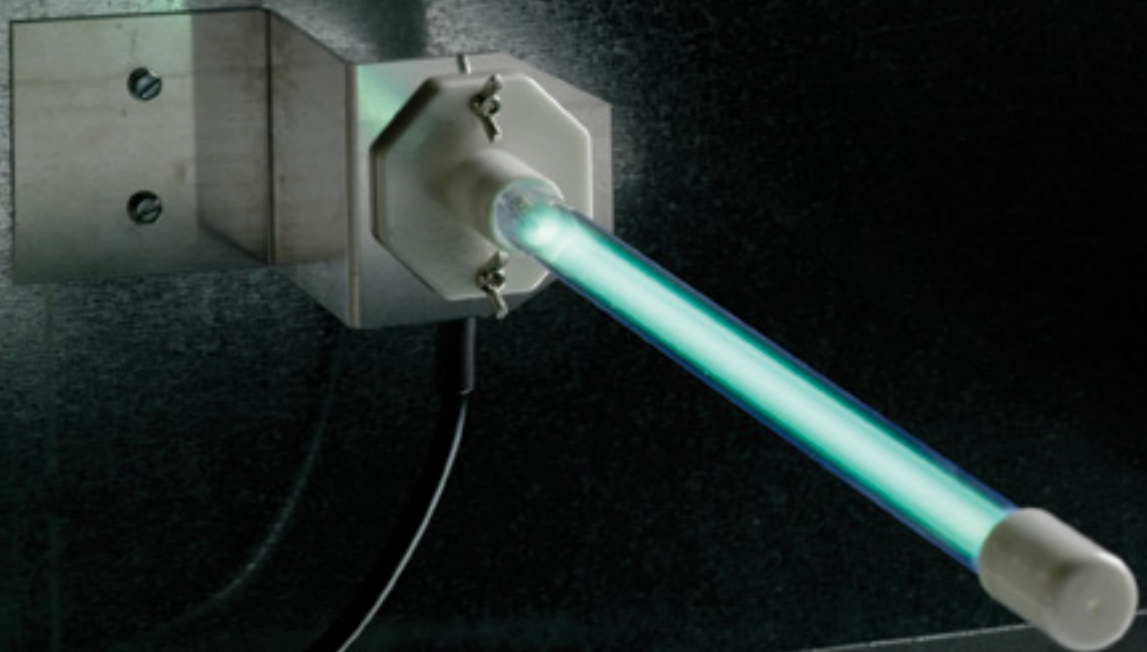



### Duct Fans

Features electrical junction box for UL and code compliant electrical connection. An efficient way to increase air circulation, keep room temperatures consistent, and lower heating and cooling costs. Metal construction, powerful no-maintenance motors and a one-use thermal fuse mean these fans will be up to the task for years. Straight forward installation into any 120V system with detailed instructions, templates, and diagrams. Available in many sizes. A great way to give slow vents a boost. Conforms to UL STD 507, Certified to CSA STD C22.2 #113

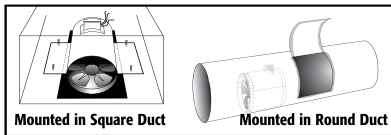

CATALOG NO.	DESCRIPTION	UOM	ORDER MULTIPLE
625-AF6	Duct Fan 6" dia., 240 CFM, 37W	EA	4
625-AF8	Duct Fan 8" dia., 420 CFM, 37W	EA	4
625-AF10	Duct Fan 10" dia., 650 CFM, 35W	EA	4
625-AF12	Duct Fan 12" dia., 975 CFM, 65W	EA	2
625-AF14	Duct Fan 14" dia., 1350 CFM, 65W	EA	1

### Roof Flashing

Easy to install. The no-caulk flashing slips over vent stack and automatically adjusts to pipe size and roof angle. 24 gauge galvanized steel.



**Oatey**

CATALOG NO.	DESCRIPTION	UOM	ORDER MULTIPLE
5-11830	Roof Flashing – 1/2" – 3/4" – 1"	EA	12
5-11840	Roof Flashing – 1-1/4" – 1-1/2"	EA	12
5-11853	Roof Flashing – 2"	EA	12
5-11866	Roof Flashing – 3"	EA	12
5-11879	Roof Flashing – 4"	EA	12

### Roof Louver

Unique interior louver design, eliminating the need for a screen. The square hood has been designed for maximum air movement. Large nailing flange for easy installation. U.L. Listed.



CATALOG NO.	DESCRIPTION	UOM	ORDER MULTIPLE
6-R50A	Roof Louver – Aluminum	EA	10

### Flue Caps

PVC Flue Caps are an affordable way to protect today's high efficiency furnaces from dirt, moisture and other debris.

- Protection for high efficiency furnaces
- Universal flue cap fits 1.5", 2" and 3" PVC pipe
- Reduces draft inducer motor rust
- Helps to eliminate pressure switch service calls
- Resistant to UV radiation and oxidative degradation
- CSA approved for use in 90% AFUE heating applications



CATALOG NO.	DESCRIPTION	UOM	ORDER MULTIPLE
EC-1	E cap Flue Cap	EA	12

### Smokeys

Smoke emitter cartridges provide effective, low cost leak testing of heat exchangers, air ducts, tanks and boilers. Visual air balancing of HVAC systems. Cartridges produce clean, non toxic, oil free smoke through chemical reaction. Use also for fire drills as well as the placement and testing of smoke alarms/ detectors.



CATALOG NO.	DESCRIPTION	UOM	ORDER MULTIPLE
14145	45 second burn time, 150 cu. ft., pack of 10	PK	1
14175	75 second burn time, 600 cu. ft., pack of 10	PK	1
14250	2-1/2 minute burn time, 1,100 cu. ft., pack of 5	PK	1
14340	4 minute burn time, 2,500 cu. ft., pack of 5	PK	1

### Versa Cap® Flue and Hot Stack Caps

Non clogging positive draft design, recommended for flue or hot stack installation. Clamp fitting adjustable for all standard sizes. Aluminum model. U.L. Listed.



CATALOG NO.	PIPE O.D.	DOUBLE WALL	SINGLE WALL	J-M TRANS. SITE	HEIGHT/OVERALL DIAMETER	ORDER UOM MULTIPLE
6-3050	2-7/8"–5"	3 and 4	3 and 4	3 and 4	4-1/2" x 6-5/8"	EA 12
6-5070	4-7/8"–7"	5 and 6	5 and 6	5 and 6	4-3/4" x 9-1/2"	EA 12
6-7090	6-7/8"–9"	7 and 8	7 and 8	7 and 8	5-7/8" x 11-5/8"	EA 12
6-9011	8-7/8"–11"	9 and 10	9 and 10	9 and 10	6-1/2" x 12-3/4"	EA 6
6-1200	11-7/8"–14-1/2"	12	12 and 14	12	8-11/16" x 17-9/16"	EA 2

### Egg Crate Louvers – Air Return Diffusers

White polystyrene 1/2 in. open cell grid louvers are beneficial for air return.

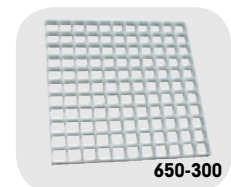

CATALOG NO.	DESCRIPTION	UOM	ORDER MULTIPLE
650-300	Egg Crate Louvers – 2' x 2' x 1/2"	EA	20
650-200	Egg Crate Louvers – 2' x 4' x 3/8"	EA	15
650-100	Egg Crate Louvers – 2' x 4' x 1/2"	EA	10

**PURE BEAM™ ULTRAVIOLET LIGHT**

**Pure-Beam™ Ultraviolet Light**

Pure Beam™ ultraviolet light is designed for HVAC air disinfection and surface irradiation. The 17 watt UV C lamp is a powerful tool for improved indoor air quality. Installs in the HVAC system or ductwork on either the return or supply air side of the furnace or air handler. DiversiTech's Pure Beam™ ultraviolet light provides a healthier environment in your home, thanks to the germicidal qualities of the UV light spectrum present in the Pure Beam™ light. Ultraviolet light deactivates the DNA of dust mites, bacteria, viruses and other pathogens and destroys their ability to multiply and cause disease. Placement of a Pure Beam™ light in an airstream or near a drain pan can help to decrease the air contamination of any home. Exposure to Pure Beam™ significantly reduces air contamination caused by fungus, mold, and viruses and can cleanse surfaces overcome by mold and slime. Overall size is 14 in. L x 2 in. W x 2 in. H for easy placement. Includes the UV lamp, a UL listed ceramic base, and mounting bracket.



UV-1

CATALOG NO.	DESCRIPTION	UOM	ORDER MULTIPLE
UV-1	Ultraviolet Light with 24 VAC elec. ballast	EA	1
UV-BULB	Replacement Bulb – 24V	EA	1

**DRYER DUCT, VENT HOSE, HOSE CLAMPS**

**Aluminum Dryer Vent Hoods, Kits, and Fittings**

Aluminum vent hood with flange plate.



650-001

CATALOG NO.	DESCRIPTION	UOM	ORDER MULTIPLE
650-001	4" Aluminum Hood	EA	24
650-002	3" Aluminum Hood	EA	24
650-003	4" Hood / 8' Tubing	EA	24
650-038	4" Aluminum Wide Mouth	EA	10

**Plastic Wide Mouth Dryer Vent Hood**

Hood, aluminum pipe and collar.



650-012

CATALOG NO.	DESCRIPTION	UOM	ORDER MULTIPLE
650-031	3" White Hood – Assembled	EA	12
650-012	4" White Hood – Assembled	EA	12
650-013	4" White Hood – Unassembled	EA	18
650-023	4" Brown Hood – Assembled	EA	12

**Louvered Dryer Vent Hood**

Louvered vent hoods are available with aluminum pipe and collar or hood only. Ideal for dryer and bathroom fan exhausts.



650-014

CATALOG NO.	DESCRIPTION	UOM	ORDER MULTIPLE
650-014	4" Hood Only – White	EA	12
650-016	4" Hood, Pipe and Collar – White (Assembled)	EA	12
650-017	4" Hood, Pipe and Collar – White (Unassembled)	EA	18
650-036	3" Hood, Pipe and Collar – White (Assembled)	EA	12

**Dryer Vent Hose**

High quality flexible white vinyl tubing. Available in 3in. or 4in. diameters. One 50ft roll per box.



650-005

CATALOG NO.	DESCRIPTION	UOM	ORDER MULTIPLE
650-005	Dryer Vent Hose – 3" x 50'	EA	1
650-006	Dryer Vent Hose – 4" x 50'	EA	1

**Semi-Rigid Aluminum Duct**

8ft. length compressed to 28in.



650-011

CATALOG NO.	DESCRIPTION	UOM	ORDER MULTIPLE
650-011	4" x 8' Flexible Aluminum Duct	EA	9
650-021	3" x 8' Flexible Aluminum Duct	EA	14
650-074	6" x 8' Flexible Aluminum Duct	EA	3

**Metallic Duct – 5 Ply**

Pure aluminum 5 ply multi layered flexible metallic duct. U.L. 181 Listed. Will contain a fire up to 265°F.



FUL0425

CATALOG NO.	DESCRIPTION	UOM	ORDER MULTIPLE
FUL0425	4" x 25' 5 Ply Metallic Duct	EA	4
FUL0625	6" x 25' 5 Ply Metallic Duct	EA	4

**DRYER DUCT, VENT HOSE, HOSE CLAMPS cont'd**

**Dryer Hose Clamps**

Available for 3 in. or 4in. dryer vent hose. Steel screw design or convenient spring action design.



CATALOG NO.	DESCRIPTION	UOM	ORDER MULTIPLE
<b>650-008</b>	Steel Screw Clamp for 4" Hose	EA	50
<b>650-010</b>	Spring Clamp for 4" Hose	EA	500

**Periscope Connection Kit**

For tight space duct venting. Contains one male snap lock fitting and one draw band with clamp. Adjustable 17in. to 28in..



CATALOG NO.	DESCRIPTION	UOM	ORDER MULTIPLE
<b>650-020</b>	4" Periscope Kit	EA	9

**Metallic Duct – 2 Ply**

2 ply metallic duct — aluminum outside, polyester inside. Ideal for bath fan ducting and all purpose venting.



CATALOG NO.	DESCRIPTION	UOM	ORDER MULTIPLE
<b>FM0450</b>	4" x 50' 2 Ply Metallic Duct	EA	1

**DUCT STRAP, TIES, CLAMPS**

**Heavy Duty Cable Ties**

6.6 nylon, the heavy duty duct straps feature smooth insertion, and a locking mechanism that gives ductwork a firm hold. Accommodates 7 to 15 inch duct. Tensioning tool for 32 in. plus allows operator to adjust strap to any desired tension.



CATALOG NO.	DESCRIPTION	UOM	ORDER MULTIPLE
<b>7-P24</b>	24" Long – Fits up to 6" Duct – 175 lb. Tensile	EA	50
<b>7-P36</b>	36" Long – Fits up to 10" Duct – 175 lb. Tensile	EA	50
<b>7-P36B</b>	36" Long – Black – Fits up to 10" Duct – 175 lb. Tensile	EA	50
<b>7-P48</b>	48" Long – Fits up to 14" Duct – 175 lb. Tensile	EA	50
<b>7-P48B</b>	48" Long – Black – Fits up to 14" Duct – 175 lb. Tensile	EA	25
<b>7-L300</b>	Tensioning Tool for 120-175 lb. Ties	EA	1

**Strapping Hanger Iron**

Galvanized 3/4 in. vent strapping, hanger iron, plumber's tape, pipe hanger tape and many other uses. 1/4 in. centers for bolts or nails.



CATALOG NO.	DESCRIPTION	UOM	ORDER MULTIPLE
<b>710-A1710</b>	Hanger Iron (Galv.) – 10' Rolls – 28 Gauge	EA	50
<b>710-A1650</b>	Hanger Iron (Galv.) – 50' Rolls – 28 Gauge	EA	10
<b>710-A16100</b>	Hanger Iron (Galv.) – 100' Rolls – 28 Gauge	EA	6

**Duct Strap – Metallic – Roll**

Galvanized duct strap in a convenient cardboard dispenser is not only easy to drill or nail, but also solid strapping. Plenum rated.



CATALOG NO.	DESCRIPTION	UOM	ORDER MULTIPLE
<b>710-001</b>	Metallic Duct Strap – 26 Gauge – 1" x 100'	EA	1
<b>710-002</b>	Metallic Duct Strap – 30 Gauge – 1" x 100'	EA	1
<b>710-003</b>	Metallic Duct Strap – 30 Gauge – 1-1/2" x 100'	EA	1
<b>710-004</b>	Metallic Duct Strap – 26 Gauge – 1-1/2" x 100'	EA	1
<b>710-005</b>	Metallic Duct Strap – 22 Gauge – 1" x 100'	EA	1

**Hanging Wire**

The 18 gauge galvanized can be used to hang HVAC duct work.



CATALOG NO.	DESCRIPTION	UOM	ORDER MULTIPLE
<b>710-182G</b>	2# Roll – 330' – 18 Gauge Galvanized	EA	8
<b>710-185G</b>	5# Roll – 830' – 18 Gauge Galvanized	EA	8

**DUCT STRAP, TIES, CLAMPS cont'd**

**Duct Strap – Woven Polypropylene**

Webbed duct strap possessing high tensile and abrasion resistance. This can be used for flex duct as it is easy to cut and staple to joists. The product is chemical resistant and tested to meet UL Standard 2043. 710-104 through 710-106 are UL rated.

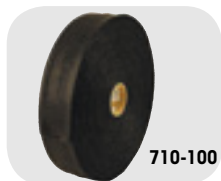

CATALOG NO.	DESCRIPTION	UOM	ORDER MULTIPLE
<b>710-100</b>	Duct Strap – 1-3/4" x 100 Yards – Black	EA	24
<b>710-101</b>	Duct Strap – 1-3/4" x 100 Yards – Silver	EA	24
<b>710-102</b>	Duct Strap – 3" x 100 Yards – Black	EA	8
<b>710-103</b>	Duct Strap – 3" x 100 Yards – Silver	EA	8
<b>710-104</b>	Duct Strap – 1-3/4" x 100 Yards – Black UL	EA	24
<b>710-105</b>	Duct Strap – 1-3/4" x 100 Yards – Silver UL	EA	24
<b>710-106</b>	Duct Strap – 3" x 100 Yards – Black UL	EA	8

**Plastic Hanger Strap**

Flexible, non-conductive. 3/4 in. wide x .050 in. thick. Load tested to 120 lbs.



CATALOG NO.	DESCRIPTION	UOM	ORDER MULTIPLE
<b>710-P100</b>	3/4" x 100' Roll	EA	20

**TAPES**

**Stick-E-Tape**

Self adhesive aluminum tape with temperature range of 40 degree F to 200 degree F. Easily pointed. Excellent vapor barrier; effective UV and water shield over urethane foam. Preferred duct and pipe wrap.



CATALOG NO.	DESCRIPTION	UOM	ORDER MULTIPLE
<b>50302</b>	Stick-E-Tape – AFT-701-2 – 2" x 50' Roll	EA	24

**Aluminum Foil Tape**

Prevents heating and cooling losses. Blocks odors and moisture. Easy to handle. Use for HVAC and refrigeration systems. 35 degree F to plus 260 degree F working temperatures. 3-5 year shelf life. Made in USA.

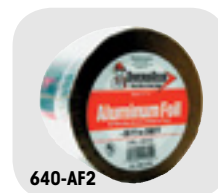

CATALOG NO.	DESCRIPTION	UOM	ORDER MULTIPLE
<b>640-AF2</b>	2" Aluminum Foil Tape – 50 yds.	EA	24
<b>640-AF25</b>	2-1/2" Aluminum Foil Tape – 50 yds.	EA	20
<b>640-AF3</b>	3" Aluminum Foil Tape – 50 yds.	EA	16

**Flex Duct Tape**

Specially designed to meet new UL181B FX code for flex duct. Higher adhesion and tack than traditional cloth duct tapes. Conformable, hand tearable foil; 3 mil thickness. 2 in. x 120 yds. Code identification printed on the tape. Acrylic adhesive for superior performance in extreme environments. ( 35°F to 260°F)



CATALOG NO.	DESCRIPTION	UOM	ORDER MULTIPLE
<b>640-FD2S</b>	Flex Duct Tape – Silver – 2"	EA	24
<b>640-FD2B</b>	Flex Duct Tape – Black – 2"	EA	24
<b>640-FD3S</b>	Flex Duct Tape – Silver – 3"	EA	16

**Foil Scrim Kraft Tape**

Non tearable, diamond patterned backing with an aggressive rubber based adhesive system for consistently dependable performance. Made in the USA.



CATALOG NO.	DESCRIPTION	UOM	ORDER MULTIPLE
<b>640-FSK2</b>	Foil Scrim Kraft Tape – 2" – 50 Yards	EA	24
<b>640-FSK3</b>	Foil Scrim Kraft Tape – 3" – 50 Yards	EA	16

**UL Listed Foil Tape**

Unique acrylic adhesive for airtight bonds on joints and seams of fiberglass duct systems. Flexible, easy to use. Meets or exceeds performance standard AFLS 100 73 and UL 181 A P.



CATALOG NO.	DESCRIPTION	UOM	ORDER MULTIPLE
<b>640-UL25</b>	UL 181 Listed Foil Tape – 2-1/2" – 60 Yards	EA	16
<b>640-UL3</b>	UL 181 Listed Foil Tape – 3" – 60 Yards	EA	16

**Cloth Duct Tapes**

High tack, excellent strength. Superior performance in sealing air handling systems. Heavy cloth content for easier tearing and additional strength. Made in the USA.



CATALOG NO.	DESCRIPTION	UOM	ORDER MULTIPLE
<b>PC-622-S</b>	2" x 60 Yards – Premium Grade Duct Tape – Silver	EA	24
<b>PC-622-B</b>	2" x 60 Yards – Premium Grade Duct Tape – Black	EA	24
<b>PC-609-S</b>	2" x 60 Yards – Industrial Grade Duct Tape – Silver	EA	24
<b>PC-609-B</b>	2" x 60 Yards – Industrial Grade Duct Tape – Black	EA	24
<b>PC-600-S</b>	2" x 60 Yards – Contractor Grade Duct Tape – Silver	EA	24
<b>PC-600-B</b>	2" x 60 Yards – Contractor Grade Duct Tape – Black	EA	24
<b>PC-857</b>	2" x 60 Yards – Metallized UL181B-FX Flex Duct Tape	EA	24

# HEATING PRODUCTS

Black Steel Welded Nipples.....	60
Carbon Monoxide & Smoke Alarms.....	59
DiversiTech Gas Connectors.....	58
Dormont Gas Valves and Connectors.....	59
Malleable Black Iron Pipe Fittings.....	60-61
TrueStart® Hot Surface Igniters.....	56
TrueStart® Ignition Accessories.....	57
Vent Termination Kits.....	57

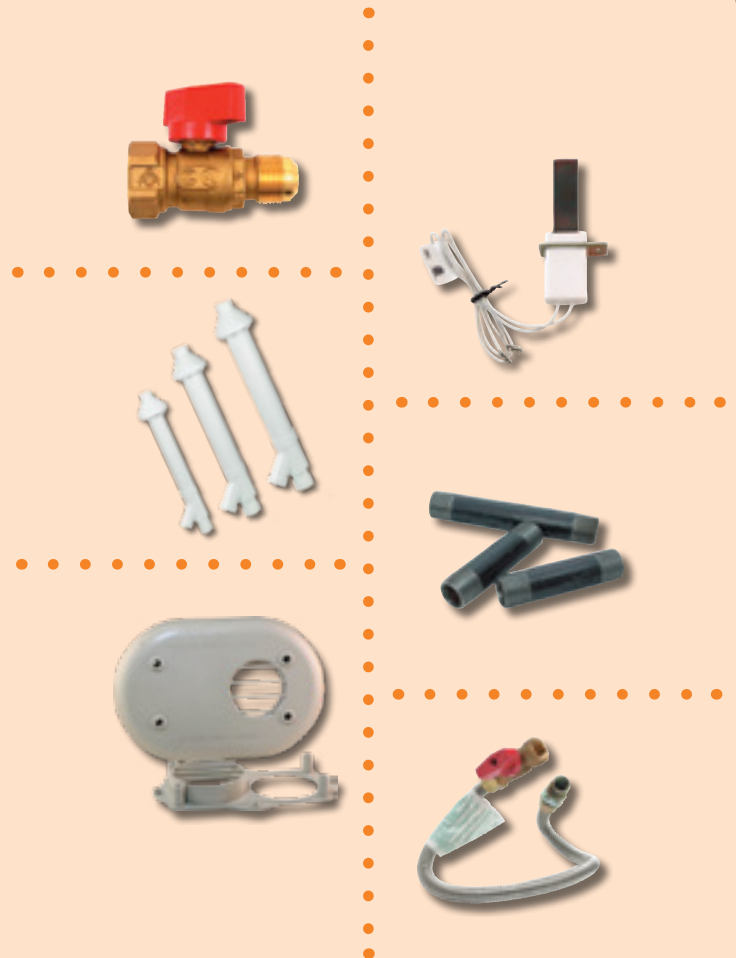

# TrueStart® Hot Surface Igniters



*TrueStart® hot surface igniters have been  
100% tested and approved.*

*TrueStart® hot surface igniters are completely reliable  
right out of the package and are certified by CSA  
for use in electrical equipment.*





TrueStart® universal hot surface igniters by DiversiTech are high quality replacements that fit hundreds of OEM components. TrueStart® universal igniters are durable and are designed to provide years of reliable service.

## BUILT TO LAST

TrueStart® universal igniters are available in silicon nitride and silicon carbide models. Silicon nitride is a very durable ceramic that is high fracture and temperature resistant and has a long life expectancy. Silicon nitride is a longer lasting material that is also more shock resistant. Silicon carbide is a naturally high temperature resistant metal that has been the standard used in heating equipment for years.

## JUST ONE REPLACES HUNDREDS

TrueStart® universal hot surface igniters feature a universal bracket kit that can be used to fit most all OEM furnaces. And TrueStart® hot surface igniters feature a unique universal electrical plug kit. This plug kit includes the most common crimp terminals and connector housings to fit the majority of OEM furnaces.

- ✓ *Durable ceramic material*
- ✓ *High thermal shock and chemical resistance*
- ✓ *Fracture resistant*
- ✓ *Long life*

## LONG WARRANTY

Every TrueStart® universal igniter includes a generous warranty period to ensure your satisfaction. The warranty on silicon nitride models is 3 full years and the warranty for silicon carbide igniters is 18 months.

## 100% TESTED

TrueStart® universal hot surface igniters have been 100% tested and approved. TrueStart® hot surface igniters are completely reliable right out of the package and are certified by CSA for use in electrical equipment.



*Each TrueStart® universal igniter also includes:*

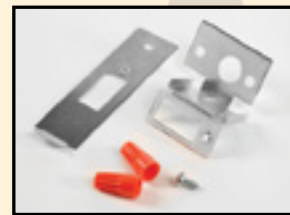

*A universal bracket kit for a fast, easy installation.*



*A universal electrical plug connection kit to simplify installation.*



*Color coded packaging.*



**Made in U.S.A.**



# Vent Termination Kits

**Concentric vents** and termination kits allow both intake for combustion air and the exhaust vent to pass through a standard roof or sidewall. This makes it easier to have a two-pipe installation for high efficiency furnaces. These vents simplify installation and only require one hole through the wall or roof where the pipes terminate. Without using these vents, the installation would require cutting two holes through the home, one for each pipe. These vents save time and money by reducing the amount of work required.

**Horizontal vent kits** for use in venting high efficiency fossil fuel appliances. The low profile kit hides the vent from view.



### All Fittings included

DiversiTech's CVENT series concentric vent kit includes all fittings a contractor will need to install the vent. No additional fittings for outside connections are needed. Only piping from the vent kit to the furnace will need to be provided separately. Models are available for 2", 3" or 4" intake/vent systems.



### Low profile

The low profile of the HVENT series product creates a neat look for the vent connection. The simple and clean looking vent hides both the intake and exhaust pipework. Models are available for 2" or 3" vent systems.





## Flexible installation

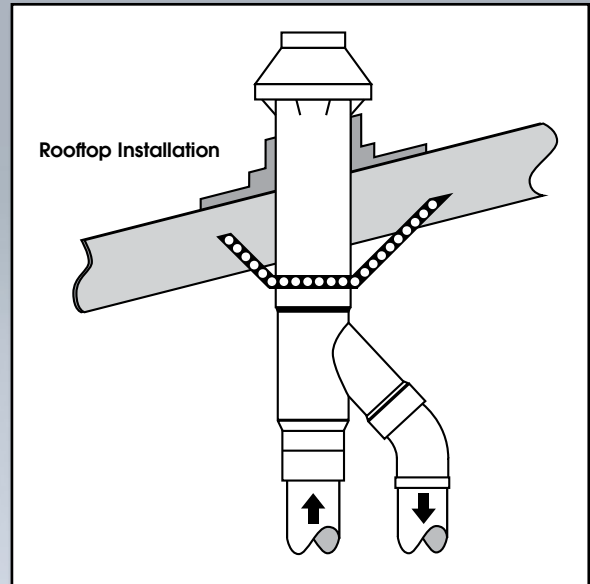
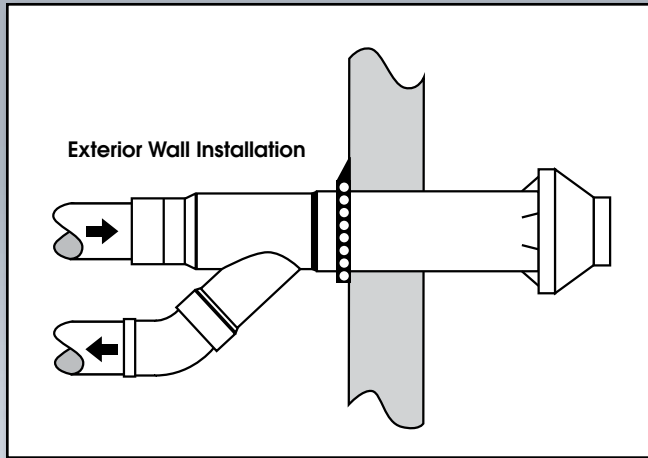

The same CVENT series vent kit can be used in either a horizontal (through the wall) or vertical (through the roof) installation.

**TRUESTART® HOT SURFACE IGNITERS**

**Wolverine® Universal Hot Surface Igniter**

Wolverine® hot surface igniters feature protective, dynamic, and informative packaging. Wolverine® hot surface igniters are 100% tested and completely reliable. They are compatible with all OEM furnaces. Universal hot surface igniters allow a contractor to reduce truck stock and replace hundreds of OEM igniters with just one SKU.

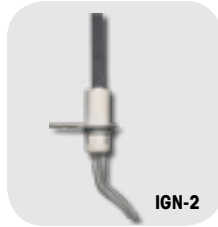

CATALOG NO.	DESCRIPTION	UOM	ORDER MULTIPLE
<b>IGN-2</b>	Wolverine Hot Surface Igniter by TrueStart, Universal, Silicon Nitride	EA	6
<b>IGN-2-6P</b>	Wolverine Hot Surface Igniter by TrueStart, Universal, Silicon Nitride – Contractor Pack, pack of 6	PK	1

**Universal Silicon Carbide Igniters**

TrueStart® hot surface igniters feature protective, dynamic, and informative packaging. TrueStart™ hot surface igniters are 100% tested and completely reliable. They are compatible with all OEM furnaces. TrueStart® hot surface igniters are available as a universal silicon carbide igniter.

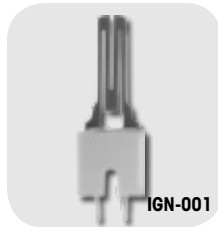

CATALOG NO.	DESCRIPTION	UOM	ORDER MULTIPLE
<b>IGN-001</b>	TrueStart™ Hot Surface Igniter, Universal, Silicon Carbide	EA	6

**Direct Replacement Igniters**

TrueStart® hot surface igniters feature protective, dynamic, and informative packaging. TrueStart™ hot surface igniters are 100% tested and completely reliable. They are compatible with all OEM furnaces. TrueStart® hot surface igniters are available as direct replacement for OEM silicon carbide igniters.

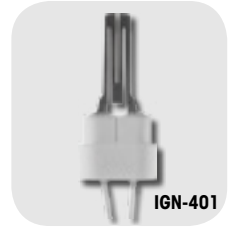

CATALOG NO.	DESCRIPTION	UOM	ORDER MULTIPLE
<b>IGN-401</b>	TrueStart™ Hot Surface Igniter, Direct Replacement, Silicon Carbide for 41-401	EA	6
<b>IGN-402</b>	TrueStart™ Hot Surface Igniter, Direct Replacement, Silicon Carbide for 41-402	EA	6
<b>IGN-403</b>	TrueStart™ Hot Surface Igniter, Direct Replacement, Silicon Carbide for 41-403	EA	6
<b>IGN-405</b>	TrueStart™ Hot Surface Igniter, Direct Replacement, Silicon Carbide for 41-405	EA	6
<b>IGN-406</b>	TrueStart™ Hot Surface Igniter, Direct Replacement, Silicon Carbide for 41-406	EA	6
<b>IGN-407</b>	TrueStart™ Hot Surface Igniter, Direct Replacement, Silicon Carbide for 41-407	EA	6
<b>IGN-408</b>	TrueStart™ Hot Surface Igniter, Direct Replacement, Silicon Carbide for 41-408	EA	6
<b>IGN-409</b>	TrueStart™ Hot Surface Igniter, Direct Replacement, Silicon Carbide for 41-409	EA	6
<b>IGN-410</b>	TrueStart™ Hot Surface Igniter, Direct Replacement, Silicon Carbide for 41-410	EA	6
<b>IGN-412</b>	TrueStart™ Hot Surface Igniter, Direct Replacement, Silicon Carbide for 41-412	EA	6



*TrueStart® hot surface igniters have been 100% tested and approved.*

*TrueStart® hot surface igniters are completely reliable right out of the package and are certified by CSA for use in electrical equipment.*



**TRUESTART® IGNITION ACCESSORIES**

**TrueStart® Flame Sensors**

TrueStart® flame sensors are a direct replacement for Carrier/BDP flame sensors, cross reference part numbers are detailed in the item descriptions. TrueStart® flame sensors are not manufactured by Carrier Corporation.



CATALOG NO.	DESCRIPTION	UOM	ORDER MULTIPLE
<b>900-3</b>	TrueStart™ FLAME SENSOR replaces Carrier® LH33WZ516	EA	1
<b>900-5</b>	TrueStart™ FLAME SENSOR replaces Carrier® LH33WZ518	EA	1
<b>900-6</b>	TrueStart™ FLAME SENSOR replaces Carrier® LH33WZ520	EA	1

**VENT TERMINATION KITS**

**Concentric Vents**

Concentric vents make it easier to have a two pipe installation for high efficiency furnaces. These vents simplify installation and only require one hole through the wall or roof where the pipes terminate. Without using these vents, the installation would require cutting two holes through the home, one for each pipe. These vents save time and money by reducing the amount of work required. Available in 2", 3" or 4" intake vent sizes.

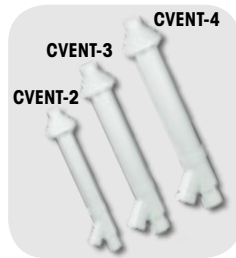

CATALOG NO.	DESCRIPTION	UOM	ORDER MULTIPLE
<b>CVENT-2</b>	2" Concentric Vent	EA	1
<b>CVENT-3</b>	3" Concentric Vent	EA	1
<b>CVENT-4</b>	4" Concentric Vent	EA	1
<b>CVENTCAP2</b>	Replacement cap for CVENT-2	EA	1
<b>CVENTCAP3</b>	Replacement cap for CVENT-3	EA	1
<b>CVENTCAP4</b>	Replacement cap for CVENT-4	EA	1
<b>CVS-2</b>	Vent screen for CVENT-2	EA	1
<b>CVS-3</b>	Vent screen for CVENT-3	EA	1
<b>CVENT-2AB</b>	Accelerator Bushing for 2" CVENT	EA	1

**Horizontal Vent Termination Kits**

Horizontal vent kits for use in venting high efficiency fossil fuel appliances. The low profile kit hides the vent from view.



CATALOG NO.	DESCRIPTION	UOM	ORDER MULTIPLE
<b>HVENT-2</b>	Horizontal Termination Kit - 2 inch	EA	6
<b>HVENT-3</b>	Horizontal Termination Kit - 3 inch	EA	6

**Concentric Vent Flexible Installation**

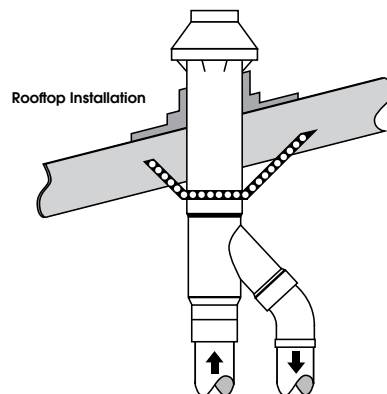
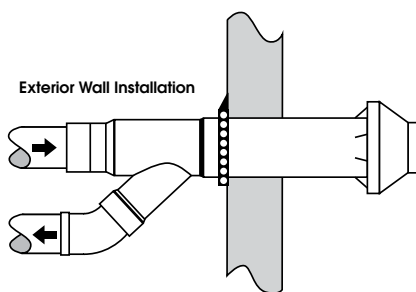

**TANKLESS WATER HEATER CONNECTION KITS**

**EasyFlex Tankless Water Heater Connection Kits**

The Tankless Water Heater Connection Kits by EASYFLEX are customized kits. Each kit includes one 1" OD, 3/4" MXF Gas Connector, two 3/4" ID, 3/4" FIP x 3/4" MIP Water Connectors, Hot & Cold Isolation Valve Set, and Pressure Relief Valve. One box has it all! Installation and maintenance are made easy for contractors and homeowners.



Global Pipe Manufacturer  
**EASYFLEX**

CATALOG NO.	DESCRIPTION	UOM	ORDER MULTIPLE
<b>EFLF-ISV-HCTP</b>	Isolation Valve Set	EA	1
<b>EFHC-0118-3Y0118</b>	Isolation Valve Set + 18" Connectors	EA	1
<b>EFHC-0124-3Y0124</b>	Isolation Valve Set + 24" Long Connectors	EA	1

**DIVERSITECH GAS CONNECTORS**

**DiversiTech Gas Connectors 1/2" OD**

Combining flexibility, durability, and functionality, DiversiTech stainless steel gas connectors are CSA design certified and 100% leak tested for quality and security. DiversiTech gas connectors are durable and reliable to give you everything you need. Available in a variety of sizes and lengths.



**D20-3132-18**

CATALOG NO.	DESCRIPTION	UOM	ORDER MULTIPLE
<b>D20-3132-18</b>	Gas Connector – 18" long, 1/2" OD x 3/8" ID, M x F	EA	12
<b>D20-3132-24</b>	Gas Connector – 24" long, 1/2" OD x 3/8" ID, M x F	EA	12
<b>D20-3132-36</b>	Gas Connector – 36" long, 1/2" OD x 3/8" ID, M x F	EA	12
<b>D20-3132-48</b>	Gas Connector – 48" long, 1/2" OD x 3/8" ID, M x F	EA	12

**Epoxy Coated Gas Connectors**

Yellow coated gas connectors include an epoxy coating for added durability and extra protection from corrosion, chemical stains from common household products and plumbing repairs.



**DC30-3132-18**

CATALOG NO.	DESCRIPTION	UOM	ORDER MULTIPLE
<b>DC30-3132-18</b>	Gas Connector coated – 18" long, 5/8" OD x 1/2" ID, M x F	EA	12
<b>DC30-3132-24</b>	Gas Connector coated – 24" long, 5/8" OD x 1/2" ID, M x F	EA	12
<b>DC30-3132-36</b>	Gas Connector coated – 36" long, 5/8" OD x 1/2" ID, M x F	EA	12
<b>DC30-3132-48</b>	Gas Connector coated – 48" long, 5/8" OD x 1/2" ID, M x F	EA	12
<b>DC30-3131-18</b>	Gas Connector coated – 18" long, 5/8" OD x 1/2" ID, M x M	EA	12
<b>DC30-3131-48</b>	Gas Connector coated – 24" long, 5/8" OD x 1/2" ID, M x M	EA	12
<b>DC30-3131-48</b>	Gas Connector coated – 36" long, 5/8" OD x 1/2" ID, M x M	EA	12
<b>DC30-3131-48</b>	Gas Connector coated – 48" long, 5/8" OD x 1/2" ID, M x M	EA	12

**DiversiTech Gas Connectors 5/8" OD**

Combining flexibility, durability, and functionality, DiversiTech stainless steel gas connectors are CSA design certified and 100% leak tested for quality and security. DiversiTech gas connectors are durable and reliable to give you everything you need. Available in a variety of sizes and lengths.



**D30-3132-18**

CATALOG NO.	DESCRIPTION	UOM	ORDER MULTIPLE
<b>D30-3131-24</b>	Gas Connector – 24" long, 5/8" OD x 1/2" ID, M x M	EA	12
<b>D30-3131-36</b>	Gas Connector – 36" long, 5/8" OD x 1/2" ID, M x M	EA	12
<b>D30-3131-48</b>	Gas Connector – 48" long, 5/8" OD x 1/2" ID, M x M	EA	12
<b>D30-3132-18</b>	Gas Connector – 18" long, 5/8" OD x 1/2" ID, M x F	EA	12
<b>D30-3132-24</b>	Gas Connector – 24" long, 5/8" OD x 1/2" ID, M x F	EA	12
<b>D30-3132-36</b>	Gas Connector – 36" long, 5/8" OD x 1/2" ID, M x F	EA	12
<b>D30-3132-48</b>	Gas Connector – 48" long, 5/8" OD x 1/2" ID, M x F	EA	12

**DORMONT GAS CONNECTORS AND VALVES**

**Dormont 20 Series**

1/2" O.D. x 3/8" I.D. 1/2" MIP x 1/2" FIP Connectors



20-3132-18

CATALOG NO.	DESCRIPTION	UOM	ORDER MULTIPLE
20-3132-18	Gas Connector – 18" Long	EA	12
20-3132-24	Gas Connector – 24" Long	EA	12
20-3132-36	Gas Connector – 36" Long	EA	12
20-3132-48	Gas Connector – 48" Long	EA	12

**Dormont 20 Series with Valve**

Corrugated stainless steel connectors with special Supr Safe design to increase flexibility. Maximum service and safety and is approved for both indoor and outdoor use. This is perfect for range and furnace connections. This Series is AA and CGA approved. This connector comes in 20 3135 18 1/2" O.D. x 3/8" I.D. x 1/2" FIP Ball Valve.



20-3135-18

CATALOG NO.	DESCRIPTION	UOM	ORDER MULTIPLE
20-3135-18	Gas Connector – 18" Long	EA	12
20-3135-24	Gas Connector – 24" Long	EA	12
20-3135-36	Gas Connector – 36" Long	EA	12
20-3135-48	Gas Connector – 48" Long	EA	12

**Dormont 30 Series**

Corrugated, stainless steel connectors with special Supr Safe® design to increase flexibility. Maximum service and safety, approved for indoor or outdoor use. Perfect for range and furnace connection. AGA and CGA approved. 3131 Series: 5/8" O.D. x 1/2" I.D. 1/2" MIP x 1/2" MIP Connectors. 3132 Series: 5/8" O.D. x 1/2" I.D. 1/2" MIP x 1/2" FIP Connectors.



30-3132-18

CATALOG NO.	DESCRIPTION	UOM	ORDER MULTIPLE
30-3131-24	Gas Connector – 24" Long	EA	12
30-3131-36	Gas Connector – 36" Long	EA	12
30-3131-48	Gas Connector – 48" Long	EA	12
30-3132-12	Gas Connector – 12" Long	EA	12
30-3132-18	Gas Connector – 18" Long	EA	12
30-3132-24	Gas Connector – 24" Long	EA	12
30-3132-30	Gas Connector – 30" Long	EA	12
30-3132-36	Gas Connector – 36" Long	EA	12
30-3132-48	Gas Connector – 48" Long	EA	12
30-3132-60	Gas Connector – 60" Long	EA	12
30-3132-72	Gas Connector – 72" Long	EA	12

**Gas Ball Valve**

Gas Ball Valves meet the stringent ISO 9000 quality standard. AGA and CGA certified.



91-3042

CATALOG NO.	DESCRIPTION	UOM	ORDER MULTIPLE
91-3042	5/8" O.D. Flare x 3/4" FIP for "30 Series" Gas Conn.	EA	10
91-2032	1/2" O.D. Flare x 1/2" FIP for "20 Series" Gas Conn.	EA	10
92-3232	1/2" FIP x 1/2" FIP	EA	10
92-4242	3/4" FIP x 3/4" FIP	EA	10

**CARBON MONOXIDE & SMOKE ALARMS**

**Carbon Monoxide Alarms**

- 10 year sealed batteries provide continuous protection
- Microprocessor intelligence combined with electrochemical sensor virtually eliminates nuisance alarms
- Red LED indicates the status of power and CO
- Table top (free standing) or wall mounted. Mounting hardware included.
- Exceeds industry standards, ETL listed to UL Standard UL 2034 and California State Fire Marshal approved.
- 10 year limited warranty on both battery and alarm



CM-1000

CATALOG NO.	DESCRIPTION	UOM	ORDER MULTIPLE
CM-1000	Carbon Monoxide Smart Alarm	EA	1

**IoPhic® Smoke & Fire, Carbon Monoxide & Natural Gas Alarm**

- 4-in-1 smart alarm uses a single sensor to detect both CO & Natural Gas AND protects against both fast flaming & slow smoldering fires
- 120-volt AC hardwired alarm with backup 9 volt battery is suitable for houses, apartments and mobile homes
- Mount the bracket to any standard wiring junction box and use the large mounting base to cover imperfections in drywall
- Features a quick activation pull-tab and a front-loading battery drawer for replacement without removing the alarm from the bracket
- Comes with a 7 year limited warranty



MDSCN111

CATALOG NO.	DESCRIPTION	UOM	ORDER MULTIPLE
MDSCN111	Smoke & Fire, Carbon Monoxide and Natural Gas Alarm	EA	4

**BLACK STEEL WELDED NIPPLES**

**Black Steel Welded Nipples**

Welded Steel that withstands 700 PSI test pressure is perfect for everyday use. The specs for this product are ASTM A 120 (Nom B 10) and the thickness is Sch. 40.



CATALOG NO.	DESCRIPTION	UOM	ORDER MULTIPLE
BPN-1	1/2" x CL Black Welded Nipple	EA	25
BPN-2	1/2" x 1-1/2" Black Welded Nipple	EA	25
BPN-3	1/2" x 2" Black Welded Nipple	EA	25
BPN-4	1/2" x 2-1/2" Black Welded Nipple	EA	25
BPN-5	1/2" x 3" Black Welded Nipple	EA	25
BPN-6	1/2" x 3-1/2" Black Welded Nipple	EA	25
BPN-7	1/2" x 4" Black Welded Nipple	EA	20
BPN-8	1/2" x 4-1/2" Black Welded Nipple	EA	15
BPN-9	1/2" x 5" Black Welded Nipple	EA	15
BPN-10	1/2" x 5-1/2" Black Welded Nipple	EA	25
BPN-11	1/2" x 6" Black Welded Nipple	EA	15
BPN-12	1/2" x 7" Black Welded Nipple	EA	25
BPN-13	1/2" x 8" Black Welded Nipple	EA	15
BPN-14	1/2" x 9" Black Welded Nipple	EA	25
BPN-15	1/2" x 10" Black Welded Nipple	EA	15
BPN-16	1/2" x 11" Black Welded Nipple	EA	25
BPN-17	1/2" x 12" Black Welded Nipple	EA	15
BPN-18	3/4" x CL Black Welded Nipple	EA	25
BPN-19	3/4" x 1-1/2" Black Welded Nipple	EA	25
BPN-20	3/4" x 2" Black Welded Nipple	EA	25
BPN-21	3/4" x 2-1/2" Black Welded Nipple	EA	25
BPN-22	3/4" x 3" Black Welded Nipple	EA	15
BPN-23	3/4" x 3-1/2" Black Welded Nipple	EA	15
BPN-24	3/4" x 4" Black Welded Nipple	EA	15
BPN-25	3/4" x 4-1/2" Black Welded Nipple	EA	20

**Black Steel Welded Nipples (cont'd)**

CATALOG NO.	DESCRIPTION	UOM	ORDER MULTIPLE
BPN-26	3/4" x 5" Black Welded Nipple	EA	20
BPN-28	3/4" x 6" Black Welded Nipple	EA	15
BPN-30	3/4" x 8" Black Welded Nipple	EA	10
BPN-32	3/4" x 10" Black Welded Nipple	EA	10
BPN-34	3/4" x 12" Black Welded Nipple	EA	15
BPN-35	1" x CL Black Welded Nipple	EA	25
BPN-37	1" x 2" Black Welded Nipple	EA	25
BPN-38	1" x 2-1/2" Black Welded Nipple	EA	25
BPN-39	1" x 3" Black Welded Nipple	EA	5
BPN-40	1" x 3-1/2" Black Welded Nipple	EA	5
BPN-41	1" x 4" Black Welded Nipple	EA	10
BPN-43	1" x 5" Black Welded Nipple	EA	5
BPN-44	1" x 5-1/2" Black Welded Nipple	EA	10
BPN-45	1" x 6" Black Welded Nipple	EA	5
BPN-47	1" x 8" Black Welded Nipple	EA	5
BPN-51	1" x 12" Black Welded Nipple	EA	5
BPN-52	1/2" x 18" Black Welded Nipple	EA	5
BPN-53	1/2" x 24" Black Welded Nipple	EA	3
BPN-54	1/2" x 36" Black Welded Nipple	EA	5
BPN-A12	1/2" Assortment Pack, 6 each of CL thru 6", pack of 66	PK	2
BPN-A34	3/4" Assortment Pack, 6 each of CL thru 6", pack of 66	PK	2

**MALLEABLE BLACK IRON PIPE FITTINGS**

**90 Degree Ell**

- Material: ASTM A 197 Cupola Malleable Iron, 150 lb.
- Dimensions:
  - ANSI B 16.3 - Malleable Iron Threaded Fittings
  - ANSI B 16.14 - Ferrous Pipe Plugs, Bushings etc.
  - ANSI B 16.39 - Malleable Iron Threaded Pipe Unions
- Threads: ANSI B 2.1 or BS 21
- Tensile Strength: 28.4 kg/mm.min



CATALOG NO.	DESCRIPTION	UOM	ORDER MULTIPLE
BPF-01	1/2" 90 Degree Elbow	EA	50
BPF-02	3/4" 90 Degree Elbow	EA	35
BPF-03	1" 90 Degree Elbow	EA	20

**45 Degree Ell**

The 45 Degree Ell fitting is made of ASTM A 197 Cupola Malleable Iron, 150 LB. The dimensions for this fitting are ANSI B 16.3. The threads are ANSI V 2.1 or BS 21 and the tensile strength is 28.4 kg/mm.min for this fitting.



CATALOG NO.	DESCRIPTION	UOM	ORDER MULTIPLE
BPF-04	1/2" 45 Degree Elbow	EA	50
BPF-05	3/4" 45 Degree Elbow	EA	40
BPF-06	1" 45 Degree Elbow	EA	15

### Coupling

The Coupling fitting is made of ASTM A 197 Cupola Malleable Iron, 150 LB. The dimensions for this fitting are ANSI B 16.3. The threads are ANSI V 2.1 or BS 21 and the tensile strength is 28.4 kg/mm.min for this fitting.



CATALOG NO.	DESCRIPTION	UOM	ORDER MULTIPLE
<b>BPF-07</b>	1/2" Coupling	EA	60
<b>BPF-08</b>	3/4" Coupling	EA	50
<b>BPF-09</b>	1" Coupling	EA	25

### Reducing Coupling

The Reducing Coupling fitting is made of ASTM A 197 Cupola Malleable Iron, 150 LB. The dimensions for this fitting are ANSI B 16.3. The threads are ANSI V 2.1 or BS 21 and the tensile strength is 28.4 kg/mm.min for this fitting.



CATALOG NO.	DESCRIPTION	UOM	ORDER MULTIPLE
<b>BPF-10</b>	3/4" x 1/2" Reducing Coupling	EA	60
<b>BPF-11</b>	1" x 1/2" Reducing Coupling	EA	30
<b>BPF-12</b>	1" x 3/4" Reducing Coupling	EA	25

### 90 Degree Street El

The 90 Degree Street El fitting is made of ASTM A 197 Cupola Malleable Iron, 150 LB. The dimensions for this fitting are ANSI B 16.3. The threads are ANSI V 2.1 or BS 21 and the tensile strength is 28.4 kg/mm.min for this fitting.



CATALOG NO.	DESCRIPTION	UOM	ORDER MULTIPLE
<b>BPF-13</b>	1/2" 90 Degree Street Elbow	EA	60
<b>BPF-14</b>	3/4" 90 Degree Street Elbow	EA	35

### Tee

The Tee fitting is made of ASTM A 197 Cupola Malleable Iron, 150 LB. The dimensions for this fitting are ANSI B 16.3. The threads are ANSI V 2.1 or BS 21 and the tensile strength is 28.4 kg/mm.min for this fitting.



CATALOG NO.	DESCRIPTION	UOM	ORDER MULTIPLE
<b>BPF-16</b>	1/2" Tee	EA	40
<b>BPF-17</b>	3/4" Tee	EA	35
<b>BPF-18</b>	1" Tee	EA	20

### Reducing Tee

The Reducing Tee fitting is made of ASTM A 197 Cupola Malleable Iron, 150 LB. The dimensions for this fitting are ANSI B 16.3. The threads are ANSI V 2.1 or BS 21 and the tensile strength is 28.4 kg/mm.min for this fitting.



CATALOG NO.	DESCRIPTION	UOM	ORDER MULTIPLE
<b>BPF-20</b>	3/4" x 1/2" x 1/2" Reducing Tee	EA	25
<b>BPF-21</b>	3/4" x 1/2" x 3/4" Reducing Tee	EA	20
<b>BPF-34</b>	1" x 1" x 1/2" Reducing Tee	EA	15

### Bushing

The Bushing fitting is made of ASTM A 197 Cupola Malleable Iron, 150 LB. The dimensions for this fitting are ANSI B 16.14. The threads are ANSI V 2.1 or BS 21 and the tensile strength is 28.4 kg/mm.min for this fitting.



CATALOG NO.	DESCRIPTION	UOM	ORDER MULTIPLE
<b>BPF-22</b>	3/4" x 1/2" Hex Bushing	EA	75
<b>BPF-23</b>	1" x 1/2" Hex Bushing	EA	50

### Cap

The Cap fitting is made of ASTM A 197 Cupola Malleable Iron, 150 LB. The dimensions for this fitting are ANSI B 16.3. The threads are ANSI V 2.1 or BS 21 and the tensile strength is 28.4 kg/mm.min for this fitting.



CATALOG NO.	DESCRIPTION	UOM	ORDER MULTIPLE
<b>BPF-25</b>	1/2" Cap	EA	75
<b>BPF-26</b>	3/4" Cap	EA	40
<b>BPF-27</b>	1" Cap	EA	35

### Plug

The Plug fitting is made of ASTM A 197 Cupola Malleable Iron, 150 LB. The dimensions for this fitting are ANSI B 16.14. The threads are ANSI V 2.1 or BS 21 and the tensile strength is 28.4 kg/mm.min for this fitting.



CATALOG NO.	DESCRIPTION	UOM	ORDER MULTIPLE
<b>BPF-28</b>	1/2" Plug	EA	50
<b>BPF-29</b>	3/4" Plug	EA	30

### Union

The Union fitting is made of ASTM A 197 Cupola Malleable Iron, 150 LB. The dimensions for this fitting are ANSI B 16.39. The threads are ANSI V 2.1 or BS 21 and the tensile strength is 28.4 kg/mm.min for this fitting.



CATALOG NO.	DESCRIPTION	UOM	ORDER MULTIPLE
<b>BPF-31</b>	1/2" Union	EA	50
<b>BPF-32</b>	3/4" Union	EA	35
<b>BPF-33</b>	1" Union	EA	20

In a class by itself.



The **ClearVue™** condensate pump isn't like all the other pumps. It features Floatless Sensor™ technology for super reliable operation without a mechanical float — No Float, No Problems. And ClearVue even has a brain. Built-in Variable Speed and Lift adjusts pump speed and lift as needed so ClearVue can adapt to any conditions. ClearVue even cleans itself to ensure worry-free operation. Learn more about how ClearVue stands out from the crowd at [www.diversitech.com](http://www.diversitech.com)



# CONDENSATE MANAGEMENT

ClearVue™ Tube & Traps.....	86
Condensate Drain Line Cleaning .....	86-87
Condensate Drain Line Switches .....	85
Condensate Drain Pans, Fittings, Adapters.....	87-89
Condensate Pumps.....	84-85
Drain Line, Tubing .....	89
Tapes .....	90

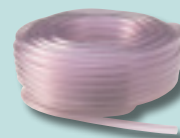

# ClearVue™ Pump

## About ClearVue™

The new ClearVue™ condensate pump from DiversiTech is unlike any other pump available. ClearVue™ features Variable Speed and Lift which makes ClearVue™ the smartest condensate pump on the market. Variable Speed and Lift provides ClearVue™ the ability to “think” and adapt to changing conditions. It’s not just off or on like a regular pump. ClearVue™ senses the amount of condensate water in the tank and its rate of inflow and adjusts its speed and lift to match the conditions and keep the tank clear. ClearVue™ starts pumping slowly and only accelerates if needed. And since it pumps slowly, ClearVue™ is super quiet and easy to live with.

With its Floatless Sensor™ technology, ClearVue™ doesn’t have the usual problems associated with float switch pumps. No more stuck floats or misaligned contacts to cause problems and potential damage. ClearVue™ uses Floatless Sensor™ technology to detect the condensate level in the tank and make the right decision about what to do next. ClearVue™ pump also features a see-through tank to give the contractor and homeowner a clear view of water, blockage, and buildup in the tank. This clear tank allows for quick troubleshooting due to normal buildup caused by daily condensate generation. ClearVue™ gives you the most improved, user-inspired features on the market.

## What makes ClearVue™ Better?

- The ClearVue™ pump features Variable Speed and Lift which allows ClearVue™ to change pump speed and lift based on condensate flow. Other pumps are simply off or on but ClearVue™ starts pumping slowly, then gradually accelerates its lift if needed.
- Floatless Sensor™ technology means more reliable operation and no problems from stuck or fouled mechanical floats. ClearVue’s Floatless Sensor™ detects the condensate level without a float for reliable, accurate operation. **No float, no problems.**
- World’s only self-cleaning condensate pump. ClearVue™ features a unique self-cleaning mode to maintain itself and help help keep drain lines clear. Also, if ClearVue™ senses a blockage, it will begin self-cleaning and pulse the condensate water to try to remove the blockage.
- ClearVue™ also offers a clear tank that allows the user to see what’s happening inside. This means faster and more accurate troubleshooting.



**FLOATLESS  
SENSOR™**

## ClearVue™ PUMP™

**0-22'**  
Variable Speed  
and Lift  
Self-Cleaning



Stainless Steel  
Mounting Tabs

Reversible  
Deck

Clear Tank

**FLOATLESS  
SENSOR™**

Silicone  
Rubber Feet

## NO FLOAT, NO PROBLEMS



### Floatless Sensor™ Technology

ClearVue's sensors tell it how high the water is in the tank and how fast the inflow is. It then adjusts pump speed and lift to keep the tank clear and the system running properly. *No float, no problems.*



### Push Button Drain

Need to drain the tank quickly? Simply push the DRAIN button and ClearVue™ removes all the water in the tank—fast.



### Clear Tank

ClearVue™ also offers a clear tank so you can easily see what's happening inside the tank. The clear tank makes it easy to see the water level and diagnose other issues if needed.



### Check Valve

Removable duckbill check valve resists corrosion and wear and is self-cleaning.



### Molded Silicone Rubber Feet

Specially designed rubber feet dampen vibration and noise, making ClearVue™ quiet and easy to live with. And like the feet on all DiversiTech pumps, they are installed at the factory and stay in place.



### Stainless Steel Hang Tabs

Two stainless steel hanging tabs offer many installation options. The tabs are sturdy and durable and will last longer than standard plastic mounts.



### LED Indicator Lights

4 LED indicator lights – Ready, Pumping, Cleaning, and Alarm. LED lights tell you what mode the pump is in at any given time.

# ClearVue™ Mini Pump

*ClearVue™ Mini is the newest innovation in Ductless System pumps from DiversiTech. It's small, quiet and offers a host of unique features that help it outperform other mini-split pumps. And just like the original ClearVue™ and ClearVueKube™ pumps, ClearVue™ Mini features Variable Speed and Lift and Floatless Sensor™ technology that help the pump think and respond to changing conditions.*



Look at everything ClearVue™ Mini offers:

## NO FLOAT, NO PROBLEMS



### Variable Speed and Lift

ClearVue™ Mini determines how fast condensate is entering the tank and adjusts its speed and lift to match the conditions and keep the tank clear.



### Aluminum Pump Housing

ClearVue™ Mini features an aluminum housing that is built to last. This tough housing protects the pump from physical damage and helps contribute to the super quiet operation of the pump.

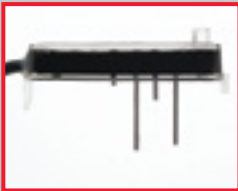

### Floatless Sensor™ Technology

*No float, no problem!* That's what ClearVue™ Mini's Floatless Sensor™ will provide you and your customers. ClearVue™ Mini's Floatless Sensor™ eliminates many of the typical problems associated with conventional condensate pumps. By eliminating the float, ClearVue™ Mini won't fail like conventional float-switch pumps.



### Rubber Mounting Pad

The molded rubber mounting pad can be used to mount ClearVue™ Mini to a vertical or horizontal surface; or to copper refrigerant lines with cable ties. The rubber pad decreases sound and vibration, contributing to a very quiet pump.

ClearVue™ Mini uses Floatless Sensor™ technology in different levels in the tank to provide the most accurate water level information to the pump's brain. And better information means a better pump. ClearVue's Floatless Sensor™ technology tells it how high the water is in the tank and how fast the inflow is. ClearVue™ Mini then uses this information to adjust its pump speed and lift to keep the tank clear and the system running properly.

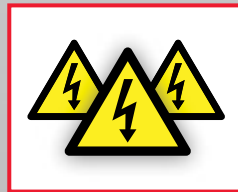

### Multiple Voltages

ClearVue™ Mini can be powered with any voltage from 120 to 240V, 50 or 60 Hz. With one product suitable for multiple voltages, there is no need to stock separate SKUs for different voltages.



### Super Quiet

With Variable Speed and Lift ClearVue™ Mini is nearly inaudible. You literally can hardly hear the pump run. This quiet operation allows maximum installation flexibility, as you can place the pump right in the room where people are.



### LED Lights

ClearVue™ Mini features three LED indicator lights: Ready, Pumping, and Alarm. The LED lights tell you what mode the pump is in at any given time.

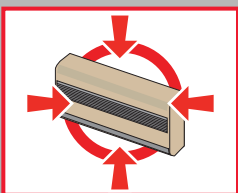

### Flexible Installation

ClearVue™ Mini is compact — only 3-1/2" x 2" x 3". It fits almost anywhere including inside a line set cover, inside the wall cassette unit (on some cassette models), and easily installs in the ceiling or behind a wall. ClearVue™ Mini features suction lift of up to 6.5'.



### Separate Tank

ClearVue™ Mini features a separate tank that can be located away from pump if needed, providing a more flexible installation. This small tank fits inside most indoor cassettes.



### Built-in Overflow Switch

ClearVue™ Mini also include a built-in overflow switch that shuts down the compressor in case of clogged line. This prevents damage to equipment or the environment.



### 2 Year Warranty

ClearVue Mini includes an extended 2 year warranty.

QUICK, EASY INSTALLATION
HIGHEST LIFT: 22FT.
SAFETY SWITCH
AVAILABLE WITH TUBING
LOW PROFILE MODELS AVAILABLE

SAVE INSTALLATION TIME WITH

# CP-22

## CONDENSATE

# PUMPS

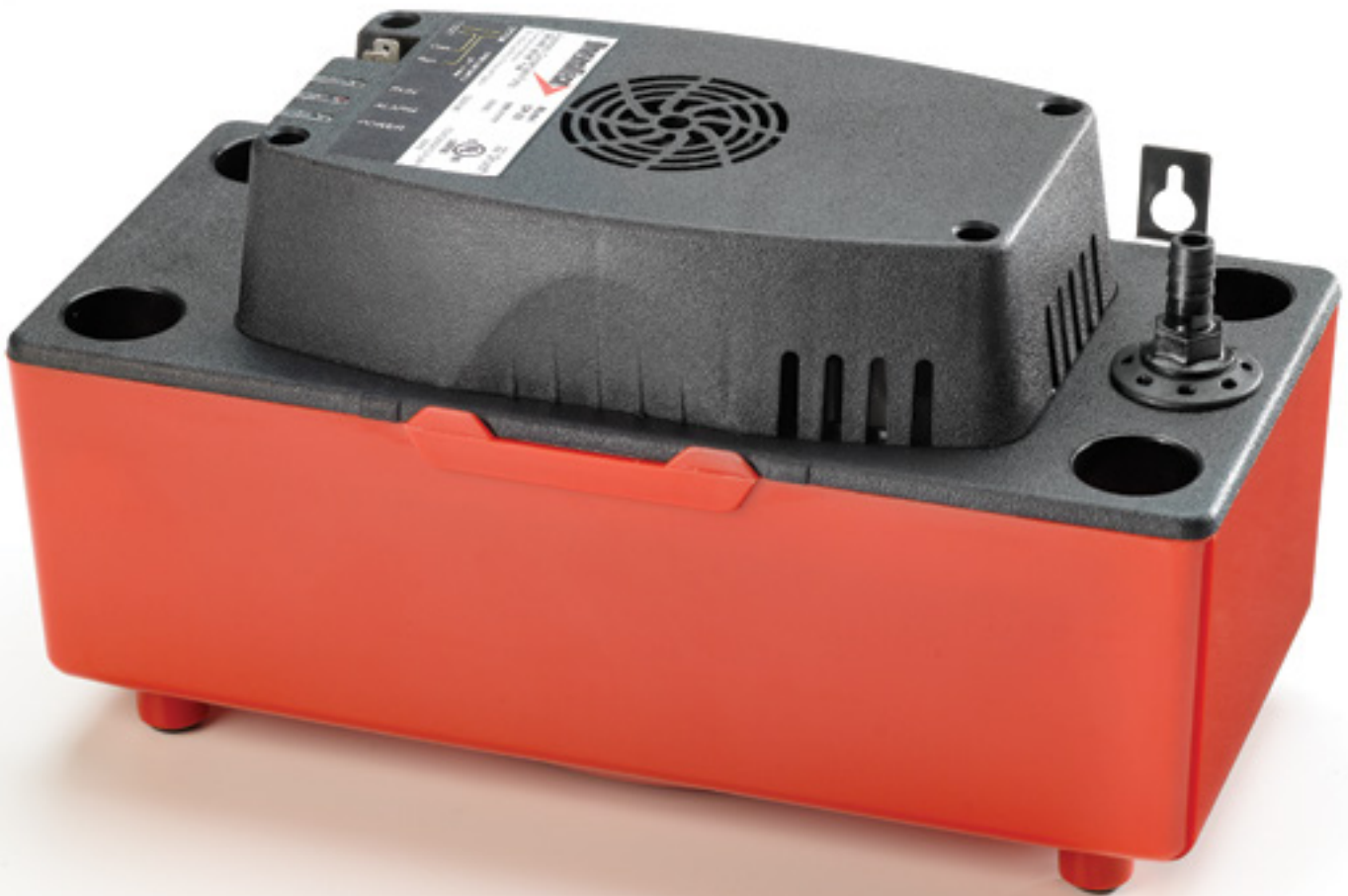

# DiversiTech Condensate Pumps



**Metal Hang Tabs**

Shatterproof metal hang tabs have hole-and-slot design for easy mounting. Tabs are located on convenient 8" centers.



**Indicator Lights**

Red, yellow, and green indicator lights show the pump status. Green for power applied, yellow for pump running, and red for high level alarm.



**Overflow Safety Switch**

1/4" quick connect terminals provide easy connection to the built-in overflow switch. Two terminals are provided allowing the installer flexibility to connect air handler shut-down. Switch features SPDT isolated contacts ready for connection to building automation systems.



**Four Inlet Holes**

Four inlets versus two or three on other pumps provide the greatest installation versatility. Inlet holes have a reinforced wall for durability.



**Rubber Feet**

Rubber feet dampen vibration which reduces noise.



**Check Valve**

Removable check valve for easy cleaning.

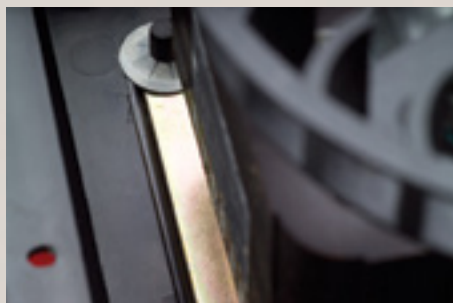

**Vibration Isolation**

An elastomeric motor mounting gasket dampens vibration.

# High Rise Pan™

The High Rise Pan™ is an innovative new plastic drain pan design which allows placement of an air handler 2-3/4" above the outside lip of the pan without the need for separate, cumbersome mounting blocks. The pan has a molded-in network of risers to give a 5" lift. The risers are positioned to accept a wide variety of air handler sizes. Each riser has a specially shaped area at each end to accommodate a 2" x 2" anti-vibration pad which allows for quiet operation at all times.

Other features include heavy duty reinforcement throughout to give plenty of support as well as rolled edges for durability. One-piece plastic construction ensures no rust, leaks, or seams to split.

Each High Rise Pan™ comes complete with a Condensate Cop™ float switch, six E.V.A. anti-vibration pads, and one 3/4" PVC male adapter. Installation is straightforward and hassle-free.

*Water pushes to the side of the pan preventing stagnant water from building up in inaccessible areas. This helps prevent slime and algae accumulations, eliminating call backs due to foul smells.*

**Now available in a Single Pack box, too!**

**Nestable! High Rise Pans™ take up less space.**

*Diversitech High Rise Pans™ are nestable, thus creating a tremendous decrease in volume needed to store and transport the pans.*



## FEATURE

## BENEFIT

### Nestable

Because DiversiTech High Rise Pans™ are nestable, there is a tremendous decrease in volume needed to store and transport the pans.



### Eliminates a single line vendor

Eliminating a vendor cuts distributor costs and saves warehouse and transportation costs.

### Water pushes to the side of the pan

This prevents stagnant water in inaccessible areas which helps prevent slime and algae buildup, eliminating call backs because of smell.

### Includes EVA™ pads

EVA™ pads increase the overall height of the unit which increases available drain line pitch. EVA™ pads also create better sound and vibration dampening for a quieter installation, meaning less call backs due to noise.

### Standard anti-vibration pad

Uses a standard, easily available anti-vibration pad, eliminating the need to stock extra SKUs of anti-vibration pads. Competitor products use specialized grommets which are not commonly available.



### Installation kit includes six EVA™ pads and Condensate Cop™ float switch

The universal CC-1 can be placed anywhere on the pan. It can also be used on other secondary drain pans (metal or plastic). You will never forget a part because you have a complete kit!

### 80% thicker than the standard drain pan

Stronger and more durable for job site installations; resists work place installation damage, minimizing the need to replace drain pans damaged at job site.



### ABS construction/flexible material

Time-tested material has been used for 15 years in the market. Flexibility allows for easier fit in tight work places and a faster installation. You'll have peace of mind for long term performance.

### Heat/cold resistance

Meets structural and temperature requirements for attic installations.

### 5" riser

5" riser gives additional height needed to assure proper drain line pitch. Stack EVA™ pads for additional height.

### Heavy-duty reinforced construction

Gives support for a wider range of air handler applications, minimizing the need to replace drain pans damaged at the job site.



# Metal Drain Pan

*DiversiTech introduces the ultimate in drain pan design - the seamless, nestable, metal drain pan with rolled edges.*



## FEATURES

## BENEFITS

### Seamless

The seamless design of DiversiTech metal drain pans virtually eliminates leaks from seams and folded corners found in conventional metal drain pans.

### Nestable

Because DiversiTech drain pans are nestable, there is a tremendous decrease in volume needed to store and transport metal drain pans. A stack of seventy DiversiTech metal drain pans is only 12" high. Therefore, seventy DiversiTech pans fit in the same space as six conventional 2" deep non-nesting drain pans!

### Single Piece Design

The DiversiTech metal drain pan is stamped from a single sheet of 26 gauge galvanized steel which prevents leaks.

### Rolled Edge

The rolled edge virtually eliminates hand injuries during handling.

### Two Outlets

Easy, flexible installation with an outlet on both the long and short side of the pan — no need to cut an outlet if you have the wrong pan on the job.

### Fittings Included

Get everything you need for the installation of the pan in a single package. Fittings are included with DiversiTech metal drain pans.

A stack of  
70 DiversiTech  
metal drain pans  
is only  
12" high!

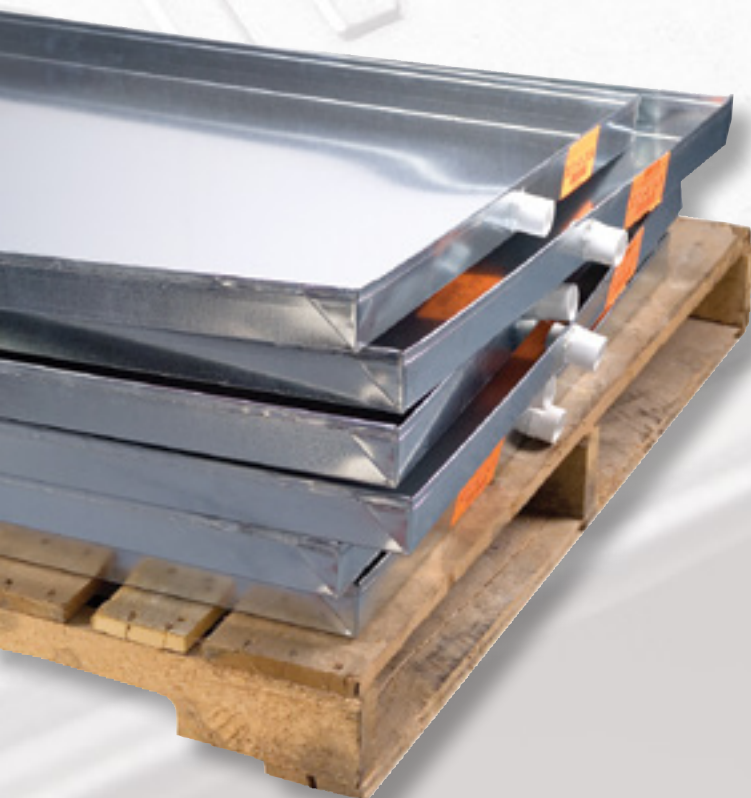

*70 DiversiTech drain pans fit in the same space as 6 conventional 2" deep non-nesting drain pans!*



**Faster Install**

**Hinged Fast Lock Clamp**

Hinged clamp bar self adjusts to angle of pan wall for a level switch. One-step installation with single screw fastener. Single screw fastens switch to pan – no drilling and no fussing with multiple thumb screws.



**Works Everywhere**

**Universal Pan Mount**

Easy twist to adjust to pan walls of 0, 8, 15 or 22 degrees. Fast, simple, easy, and level installation on metal or plastic pans for reliable moisture detection. Angled installation on other switches reduces their ability to detect condensate overflow.

# CS1200 AC Shutoff Switch

The CS1200 Multi-Position AC Shutoff Switch from DiversiTech is a reliable, easy to use float switch that clips on to any pan size. Designed with contractor feedback in mind, the CS1200 features an adjustable housing that twists to match any pan angle for easy installation. The CS1200 detects water in the pan quickly and shuts off the equipment to prevent damage. The CS1200 also includes these great features:

- Hinged fast lock clamp
- LED Indicator light
- Universal pan mount
- Large water openings for fast detection
- Push to test button
- Simple 2 wire installation
- 5 AMP switching, 24 Volt



**LED Indicator Light**

Easy to see visual trip indicator alarm displays red if switch is tripped. CS1200 is the only pan switch with a light for fast troubleshooting.



**Push to Test**

Know instantly with the push of a button that your switch is installed and functioning properly. The bright LED indicator visually confirms proper operation.



**Reliable Mechanical Contact Float Switch**

Trouble free design reduces overflow failures and call backs. All electronics are mounted above the waterline, eliminating the chance of malfunction. The one piece molded float protects switch from water and debris. This is the same design used for safety interlocks because it gives you years of reliable, maintenance free service.



**10x Open Area**

10 times more open area for water to enter the detection chamber with our large open area design. No detection failure from small holes that can get clogged. Prevents switch failure from clogged water holes. No call backs due to clogged switches.



**Simple 2 Wire Installation**

With a simple 2 wire connection, the CS1200 is simple, easy, and fast to install. No checking polarity, just connect the switch in the red or yellow wire. Simple well designed electrical connections using 6 feet of the standard 18AWG wire and high current (5 amp) switching. The CS1200 gives you everything you need in one simple switch.



**Clear Design**

CS1200 is the only pan switch with a clear design for fast troubleshooting. Clear design lets you see the float and switch. Know instantly that the switch is working and components are functioning.



# Wet Switch® Flood Detector

## WHAT IS THE WET SWITCH®?

**T**he Wet Switch® is a solid state device designed to detect the presence of condensate water overflow. The Wet Switch® is placed into the secondary drain pan — a normally dry pan. If the primary drain pan fails, condensate water will overflow into the secondary drain pan. Upon sensing moisture, the Wet Switch® will turn the system off (typically the cause of the condensing water) to help prevent damage to carpets, walls, woodwork, ceilings, and other property.

- Hydrophilic Pad
- Integral Feet
- Stainless Steel Sensor Array
- Solid State Electronics
- Epoxy Encapsulated Electronics
- Double Throw Relay
- Standard 24VAC control
- Multiple Unit Connectivity

The Wet Switch® is designed to interrupt the operation of cooling systems. However, it is a water activated switch and can be used in a variety of other applications.

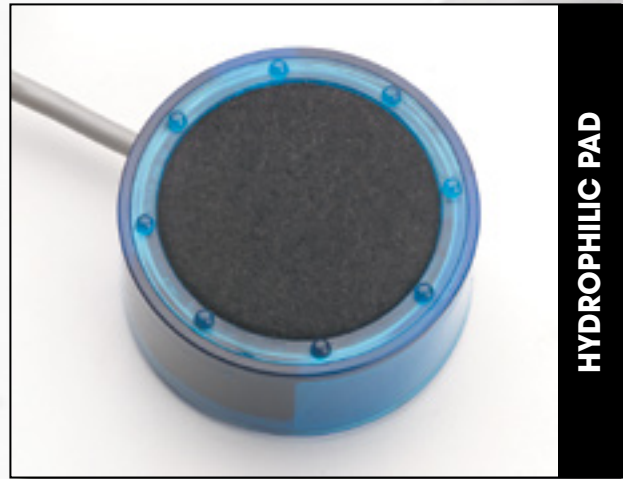

HYDROPHILIC PAD



INTEGRAL FEET



STAINLESS STEEL SENSORS

## HYDROPHILIC PAD

A high tech polymeric fiber quickly draws water into the sensor array using proven capillary technology.

## INTEGRAL FEET

Integral feet raise the hydrophilic pad and sensor array off the drain pan slightly to prevent nuisance tripping and pan corrosion (metal pans only) from interfering with the sensor array.

## STAINLESS STEEL SENSOR ARRAY

A high tech array of multiple stainless steel sensors detects even a minimal amount of water drawn into the hydrophilic pad.

## COMPACT PACKAGE

This technology is packed into a 3-5/8" diameter by 1-1/4" high cylinder. Furnished complete with 5-conductor 22AWG stranded cable, 6' long.

## DOUBLE THROW RELAY

Allows for wiring to interrupt system and to sound an alarm (by others) when moisture is detected.

## SOLID STATE ELECTRONICS

Proven electronics prevent mechanical failure in an aggressive operating environment.

## MULTIPLE UNIT CONNECTIVITY

Multiple unit connectivity allows for multiple Wet Switches to be connected in series to adequately cover large drain pan areas.

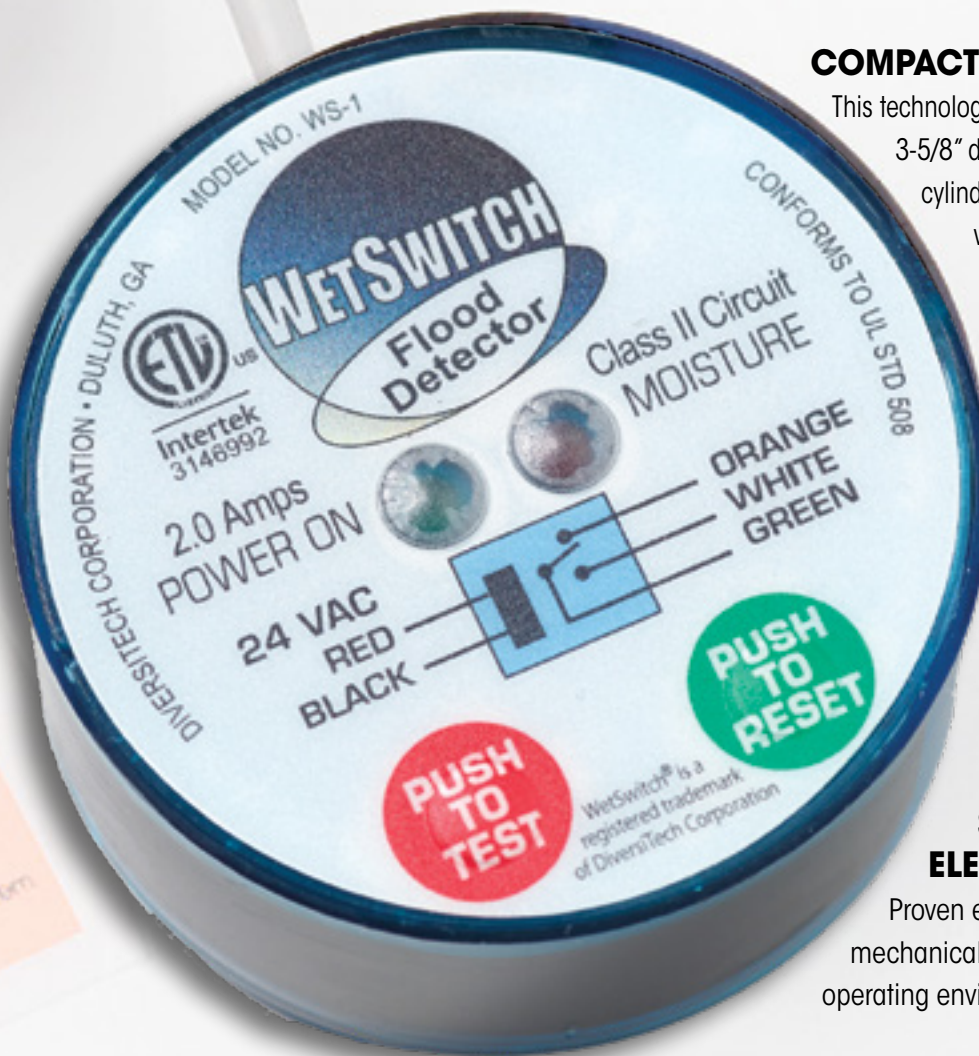

# DrainGun™



**T**he DrainGun is a lightweight (3 oz.) portable tool designed to blow out condensate drain lines instantly. Simply insert a Swoosh CO<sub>2</sub> cartridge into the Charles Gallo DrainGun and with a press of the trigger - SWOOSH - 800 psi of oil free air clears the line.

## INSTRUCTIONS:

- Unscrew cup and insert cartridge with the narrow end up.
- Without depressing the trigger, screw the cup slowly into the head until the cartridge contacts the puncture pin.
- Quickly and firmly screw the unit together to puncture and seal the cartridge in the same motion.  
Note: Not completely screwing the unit together may result in escaping gas.
- Release the red safety catch.
- Depress the trigger to discharge the Swoosh CO<sub>2</sub> cartridge. For condensate drains, a quick and full discharge is best.

*The DrainGun™ is for use with condensate drain and oil burner lines only.*





## SMALL AND LIGHTWEIGHT

The DrainGun™ packs cleaning power into a small, lightweight package. This prevents the need for carrying heavy air or nitrogen tanks.

## AIR POWER

The DrainGun™ uses CO<sub>2</sub>, eliminating the mess caused by water back flushing drain lines.

## ENVIRONMENTALLY FRIENDLY

The DrainGun™ uses carbon dioxide (CO<sub>2</sub>), a common component of air, and is totally safe for use in the environment. The DrainGun™ is an excellent alternative to the environmentally unfriendly practice of using refrigerant to clean the drain line.

## FLEXIBLE HOSE ASSEMBLY

The flexible hose assembly enables you to maneuver through cabinets, coils, and hard to reach drains.

## ADAPTER KIT

An adapter kit is available to allow for use on oil burner lines and tighter areas with a 90° fitting.



*Fittings increase the versatility of the innovative DrainGun™ and are available from your distributor.*

### 90° FITTING FOR TIGHT AREAS



### FITTING FOR OIL BURNER LINES



### FITTING FOR LARGER DRAINS



# Condensate Drain Line Cleaners

DiversiTech offers a family of products designed to help make condensate drain line cleaning faster and easier. From the super lightweight handheld DrainGun™ to the full power of the DrainDawg®, DiversiTech has the right solution for every need. These products also have multiple other uses including operating air power tools, purging and testing copper tubing and more.



## DrainGun™ HANDHELD POWER

- Clears condensate drain lines with a SWOOSH!
- Lightweight and portable - goes anywhere
- Environmentally friendly
- Uses CO<sub>2</sub> refill cartridges



## DrainKat™ PORTABLE POWER

- Uses Nitrogen or CO<sub>2</sub>
- Lightweight and portable
- Includes boxed fitting kit
- Easy to refill at your truck
- Multiple uses
- Includes inflatable DrainDawg™ fitting to clear lines fast



## DrainDawg™ ULTIMATE POWER

- Uses Nitrogen or CO<sub>2</sub>
- Includes 10' flexible hose and blowgun assembly
- Includes boxed fitting kit
- Multiple uses
- Includes inflatable DrainDawg™ fitting to clear lines fast



# A/C Easy Tee®

*The A/C Easy Tee® from DiversiTech is the easy way to unclog and clean drain lines in just seconds. It installs quickly and provides permanent, fast access for routine drain line maintenance. And with the Service Tool Kit adapters you can use water or compressed gas to quickly clean out the lines to maintain proper flow. Ideal for both commercial and residential systems.*



**Make your service calls faster and simpler with the A/C Easy Tee®.**



**Flexible to Use**  
The A/C Easy Tee® can be installed in many different ways. There is no designated inlet or outlet. Both connections can be either. The Service Tool Kit allows the technician to close off backflow creating full discharge of water or nitrogen to clean out the drain line. It can also be used with a wet/dry vac to suction dirt, debris, and gunk out of a primary drain pan.



**Code Required**  
A Service Port – also called a Cleanout – is required by code (IMC - SECTION 307.2.5, IRC-SECTION M1411.3.3). Don't get your jobs red tagged by code inspectors. Install an A/C Easy Tee®.



**Simple Design**  
The A/C Easy Tee® Service Port is a compact, simple design with no moving parts. Small, fiddly parts can and will fail. The A/C Easy Tee® has a simple cap that screws off for easy access to the condensate drain line.



**No Drainage Block**  
Featuring a simple, easy design without flappers or ball valves like other products. Flappers and ball valves can fail or be left closed in the drain line.



[www.aceasytee.com](http://www.aceasytee.com)

## CONDENSATE PUMPS

### ClearVue™ Pump

No Float, No Problems! ClearVue's Variable Speed and Lift and Floatless Sensor™ make this the most advanced condensate pump ever. This new pump can provide up to 22' of lift if needed. ClearVue™ runs at the minimum speed needed, saving wear on the pump. The pump selects the lowest effective speed, making it quieter than a regular pump. Its unique self cleaning feature senses problems and automatically enters a self cleaning mode using condensate water to fix the issue. The ClearVue™ pump features a clear bottom tank to easily check the water level. Other features include: stainless steel mounting tabs, silicone rubber feet, reversible deck, four inlet holes, and LED indicator lights. ETL Listed File Number 3190890



IQP-120

CATALOG NO.	DESCRIPTION	UOM	ORDER MULTIPLE
IQP-120	ClearVue™ Pump – 120V – 0-22' Lift	EA	6
IQP-120T	ClearVue™ Pump w/Tube – 120V – 0-22' Lift	EA	6

### FP-22 Furnace Pump

**NEW!**

The FP-22 Furnace Pump is a full featured condensate pump designed for condensing furnaces and other hot water applications. It handles hot condensate water up to 190 degrees F. Other features include 22' lift, built-in P traps, steam resistant electronics, and a super tough tank. Available in 120 and 230V models.



FP-22

CATALOG NO.	DESCRIPTION	UOM	ORDER MULTIPLE
FP-22	Furnace Pump 120V 22' Lift 190°F Condensate	EA	1
FP-22-230	Furnace Pump 230V 22' Lift 190°F Condensate	EA	1

### BP-46 Boiler Pump

**NEW!**

The BP-46 Boiler Pump is a heavy duty, full featured condensate pump for hot water applications up to 212 degrees F. It features a 46' lift, oil resistant tank and impeller, two inlet holes and 1/4 turn check valve. Additional features include high impact construction, large tank and is available in 120 and 230V models.



BP-46

CATALOG NO.	DESCRIPTION	UOM	ORDER MULTIPLE
BP-46	High Temperature Boiler Pump 115V, 46' Lift 212°F Condensate	EA	1
BP-46-230	High Temperature Boiler Pump 230V, 46' Lift 212°F Condensate	EA	1

### ClearVue™ Mini Ductless System Pump

Featuring super quiet operation, specifically designed for ductless system installations, and including Variable Speed and Lift and Floatless Sensor™, ClearVue™ Mini is chock full of innovative features, and priced competitively.



CVMINI

CATALOG NO.	DESCRIPTION	UOM	ORDER MULTIPLE
CVMINI	ClearVue Mini - Ductless System Pump	EA	6

### CP-22 Pumps

Suitable for use with condensate from HVAC equipment which produce condensate. 22' of lift compared to the typical 20'. Features include vibration dampening feet and motor mounts, metal hang tabs, four inlet holes, a clear indicator display, a float switch and check valve. Integrating the CP-22 into your system is easy. 1/4" quick connect terminals provide easy connection to the built in overflow switch. 2 terminals are provided allowing flexibility to connect air handler shut down. UL Listed File Numbers E253155 and E258186.



CP-22

CATALOG NO.	DESCRIPTION	UOM	ORDER MULTIPLE
CP-22	Condensate Pump – 120V	EA	6
CP-22T	Condensate Pump – 120V w/20' 3/8" Tube	EA	6
CP-22-230	Condensate Pump – 230V	EA	6
CP-22-230T	Condensate Pump – 230V w/20' 3/8" Tube	EA	6

### CP-22 Low Profile Pumps

The new CP-22LP comes packed with all the same great features found in the CP-22, but now in a low profile package. This pump is only 4-3/8" tall so it's a good fit for those instances where space is at a premium. The shorter reservoir holds 1/3 gallon. Suitable for use with condensate up to 160 degree F. UL Listed File Numbers E253155 and E258186.



CP-22LP

CATALOG NO.	DESCRIPTION	UOM	ORDER MULTIPLE
CP-22LP	Condensate Pump – 120V – Low Profile	EA	6
CP-22LP-230	Condensate Pump – 230V – Low Profile	EA	6

### General Purpose Pumps

The DiversiTech CP-16 condensate pump is an economical alternative that's based off of the proven CP-22 design. More compact than the CP-22, it's designed to lift to a maximum of 16 feet. The CP-16 shares many of the great features of the CP-22, including hang tabs, four inlet holes, float switch, overflow switch, and a check valve. UL Listed File Numbers E253155 and E258186.



CP-16

CATALOG NO.	DESCRIPTION	UOM	ORDER MULTIPLE
CP-16	Condensate Pump 16' Lift 120V	EA	6
CP-16-230	Condensate Pump 16' Lift 230V	EA	6

### Pump Parts & Accessories

Check valve installs easily and prevents water from travelling backwards into the pump and overflowing.



CP-CV

CATALOG NO.	DESCRIPTION	UOM	ORDER MULTIPLE
CP-CV	Replacement Check Valve for CP-22	EA	1

**CONDENSATE PUMPS cont'd**

**Mini-Split Pumps**

DiversiTech's Mini-Split Condensate Pump is a quiet, super compact, and feature rich pump that fits almost anywhere. Compatible with all brands of mini-split units. Provides 24' of lift with 6' suction lift. Pump fits easily in most line set covers and includes all needed accessories. Available in 115V and 230V versions.



CATALOG NO.	DESCRIPTION	UOM	ORDER MULTIPLE
<b>CP-M115</b>	Mini-Split Condensate Pump, 115V	EA	10
<b>CP-M230</b>	Mini-Split Condensate Pump, 230V	EA	10

**CONDENSATE DRAIN LINE SWITCHES**

**PAN MOUNTED SWITCHES**

**Wet Switch® Flood Detector**

A solid state control designed to help prevent flooding, damage to carpets, walls, furniture, ceilings, etc. Now has a built in test and reset button for easier installation. Turns system off when detecting moisture due to condensate or drain leaks. One or two drops will cause Wet Switch® to turn off a unit, alerting a serviceman to a moisture problem. A lit LED indicates the Wet Switch® is activated and has turned the unit off. Reset simply by drying the absorbent pad with a paper towel and pressing the reset switch. Connects to 24 VAC. More than one unit may be connected to a system. 2 amp contact rating. Simple 5 wire installation. Sales displays available. ETL Listed File Number 3146992. UL508 Approved.



CATALOG NO.	DESCRIPTION	UOM	ORDER MULTIPLE
<b>WS-1</b>	Wet Switch® Flood Detector	EA	1

**CS1200 AC Shutoff Switch**

The CS1200 is a fast installing, reliable, condensate overflow detection pan switch. Featuring a unique universal pan mount design to assure accurate detection in metal or plastic secondary drain pans. UL508 Approved.



CATALOG NO.	DESCRIPTION	UOM	ORDER MULTIPLE
<b>CS1200</b>	CS1200 AC Shutoff Switch	EA	12

**Pipe Mounted Switches**

DiversiTech condensate overflow prevention switches for primary or auxiliary lines are small, simple to install and easy to service reed switch technology. Both are signed designed with a pull-to-test lever to validate installation. As water level in the auxiliary or main drain pipe rises due to a clogged condensate drain line, the switch shuts off the system - thus preventing water from overflowing and causing damage to doors, walls and ceilings. A red LED illuminating light notifies a homeowner/service technician that the switch has triggered. At the heart of the switch is a durable yet precise magnetic reed switch. Constructed of materials that will not rust or stick, both switches are plenum rated, conforming to UL2043 and are UL508 approved.



CATALOG NO.	DESCRIPTION	UOM	ORDER MULTIPLE
<b>CS-1</b>	Condensate Switch – Tee	EA	12
<b>CS-2</b>	Condensate Switch – Elbow	EA	12

**Condensate Cop™**

Condensate Cop™ is a unique clamp on float switch intended for HVAC drain pan installation. The Condensate Cop™ features a large over clamping area that fits easily over the edge of all types of drain pans; including formed plastic and galvanized sheet metal. A separate float/probe assembly swivels to accommodate drain pans having sloped sides. The swivel action allows the installer to position the float switch for best operation and then clamp it into place. The probe features an inlet grill which prevents the float from being blocked or damaged by insulation or other debris. Sealed inside the probe is a magnetically actuated normally closed switch. The switch opens when rising water presents a potential flooding condition. Two wire connection for easy hook up to a thermostat "Y" (compressor) circuit. Provided complete with 5' (1.5 meter) leads, wire nuts, and clamping screws. Small size, 24V/1.5 amp NC reed switch. ETL Listed File Number 3166285. UL508 Approved.

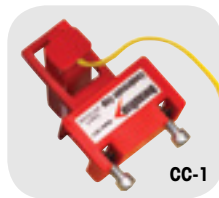

CATALOG NO.	DESCRIPTION	UOM	ORDER MULTIPLE
<b>CC-1</b>	Condensate Cop™ Drain Pan Switch	EA	12

**CS-3 Condensate Pan Switch**

The CS-3 is a clip-on pan switch that use a magnetic reed switch for condensate overflow protection.



CATALOG NO.	DESCRIPTION	UOM	ORDER MULTIPLE
<b>CS-3</b>	Condensate Switch – Clip	EA	12

**Universal Alarm**

A universal low voltage alarm that can indicate possible system trouble. Use with the Wet Switch®, SOS, Condensate Cop, CP 22 (all types) and all float switches on 24VAC control circuits. If an alarm condition exists, the homeowner can turn the alarm off with a "silence" button until service is obtained, however a red trouble LED will remain lit. Also features: easy 2 wire connection, label to print contractor information, and low current draw. Actuates at greater than 18V to prevent any false alarms due to low voltage. Includes 2 wire nuts, a sheet metal screw, and double sided tape for convenient installation options. Also includes instructions for wiring normally open switch systems (for the CP 22 or other condensate pumps).



CATALOG NO.	DESCRIPTION	UOM	ORDER MULTIPLE
<b>UA-1</b>	Universal Alarm for 24VAC	EA	12

**CLEARVUE™ TUBE & TRAPS**

**ClearVue™ Tube**

Clear, schedule 40 PVC ideal for installing as condensate drain lines in other areas where seeing the inside of the tubing is helpful. ClearVue™ Tube makes it easy to quickly spot build up or obstructions in drain lines for faster troubleshooting. Available in 5ft lengths.

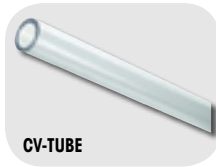

CATALOG NO.	DESCRIPTION	UOM	ORDER MULTIPLE
<b>CV-TUBE</b>	ClearVue™ Tube – 5' section	EA	50

**Drain Trap Kits**

Drain trap kits feature clear PVC traps with multiple cleanouts for easy maintenance. Available in several fitting styles with or without float switch to match any installation need.



CATALOG NO.	DESCRIPTION	UOM	ORDER MULTIPLE
<b>DTK113</b>	Drain Trap Kit, 3/4 in Blow Molded	EA	1
<b>DTK113B</b>	Drain Trap Kit, 3/4 in, w/Brush	EA	1
<b>DTK205</b>	Drain Trap Kit, 3/4 in, Deep w/switch	EA	1
<b>DTK207</b>	Drain Trap Kit, 3/4 in, Standard w/switch and cross	EA	1
<b>DTK210</b>	Drain Trap Kit, 3/4 in, Standard w/switch	EA	1

**ClearVue™ Traps**

DiversiTech introduces new ClearVue™ P and R traps. These traps are made from smooth, clear PVC with no flat spots to restrict flow. With these new ClearVue™ traps its easy to see directly into them to detect blockages and prevent problems before they become severe. Ideal for installation in condensate drain lines.

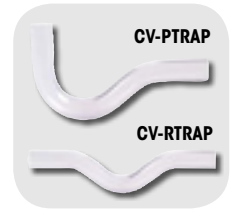

CATALOG NO.	DESCRIPTION	UOM	ORDER MULTIPLE
<b>CV-PTRAP</b>	ClearVue™ 3/4" P trap	EA	25
<b>CV-RTRAP</b>	ClearVue™ 3/4" R trap	EA	25
<b>CV-UTRAP</b>	ClearVue™ 3/4" U trap	EA	25

**Drain Trap Kit Cross Reference**

DIVERSITECH CATALOG NO.	RECTORSEAL PART NO.
<b>DTK113</b>	<b>EZT-113</b>
<b>DTK113B</b>	<b>EZT-113B</b>
<b>DTK205</b>	<b>EZT-205</b>
<b>DTK207</b>	<b>EZT-207</b>
<b>DTK210</b>	<b>EZT-210</b>

**CONDENSATE DRAIN LINE CLEANING**

**DrainGun™ - SWOOSH CO<sub>2</sub> Cartridges**

Clears condensate drains with a SWOOSH! A lightweight (3 oz.) portable tool designed to blow out drain lines instantly. New larger SWOOSH CO<sub>2</sub> cartridges now deliver 800 PSI of oil free air to clear the line. Each unit comes equipped with a tapered fitting to work on 3/8 in. – 3/4 in. drain openings. Flexible hose assembly maneuvers through cabinets, coils and hard to reach drains. Cartridges are environmentally safe and recyclable. No need for air or nitrogen tanks. Reduces labor costs and time on service calls.



CATALOG NO.	DESCRIPTION	UOM	ORDER MULTIPLE
<b>GG-1</b>	DrainGun™ for A/C Condensate Lines	EA	6
<b>GGC-12</b>	SWOOSH CO <sub>2</sub> Cartridges, pack of 12	PK	1
<b>GGC-6</b>	SWOOSH CO <sub>2</sub> Cartridges, pack of 6	PK	1
<b>GG-1A</b>	DrainGun™ Adapter Kit	EA	1
<b>GG-1H</b>	DrainGun™ Hose Assembly	EA	1
<b>GG-1TF</b>	DrainGun™ replacement tip	EA	1
<b>GG-1BOR</b>	DrainGun™ bottom o-ring, pack of 5	PK	1

**DrainDawg™**

The DrainDawg™ is a complete condensate drain cleaning kit, including the CT-475M deluxe nitrogen / CO<sub>2</sub> 0-475 psi regulator, the TG-10 & BS-25 ten foot hose and blowgun assembly, and the CW-15 fifteen inch whip hose. Also included is the AP-DD DrainDawg™ Accessory Fitting Kit which contains the DF-75 DrainDawg™ inflatable tip, the CK-141 3/4"-1" cone fitting, the FA-02 CO<sub>2</sub> to nitrogen adapter, the QN-S3 needle tip, and the TC-25 tire chuck. Made in USA.



CATALOG NO.	DESCRIPTION	UOM	ORDER MULTIPLE
<b>CB-2</b>	DrainDawg™ Kit	EA	3

**DrainKat™**

The DrainKat™ is an over the shoulder refillable, nitrogen or CO<sub>2</sub> mini drain cleaning kit. Featuring a small cylinder that holds 9 cubic feet of nitrogen or 2-1/2 pounds of CO<sub>2</sub>. The cylinder includes an integral mounted regulator for quick and easy adjustment of discharge pressure. Get exactly the amount of pressure you need with a quick adjustment on the regulator. Furnished complete with an 87" hose and drain gun kit, the CW-15 whip hose, and the AP-DK DrainKat™ Accessory Fitting Kit which contains the DF-75 DrainDawg™ inflatable tip, the CB-03 3/4"-1" cone fitting, the FA-01 male to male CO<sub>2</sub> to nitrogen adapter, the FA-03 CO<sub>2</sub> trans-fill adapter, and the the QN-S3 needle tip. Made in the USA.



CATALOG NO.	DESCRIPTION	UOM	ORDER MULTIPLE
<b>MBK-6</b>	DrainKat™ Kit	EA	2



**CONDENSATE DRAIN LINE CLEANING cont'd**

**A/C Easy Tee®**

A/C Easy Tee® is a simple, inexpensive way to comply with the International Mechanical Code M32-12. It provides a Condensate Drain Service Port that is flexible and easy to use with nitrogen, water, or shop vac. A/C Easy Tee® has no valve or moving parts that could fail.

CATALOG NO.	DESCRIPTION	UOM	ORDER MULTIPLE
<b>ET75</b>	A/C Easy Tee®	EA	20
<b>ET75-KIT</b>	A/C Easy Tee® Kit - 2 Tees and ST75	EA	6
<b>ST75</b>	Service Tool Kit	EA	6



**DrainDawg™ and DrainKat™ Fittings**

The DrainDawg™ and DrainKat™ products are compatible with a series of fittings to connect to condensate drain lines and hoses. The fittings are available individually, or as kits for the DrainDawg™ and DrainKat™.

CATALOG NO.	DESCRIPTION	UOM	ORDER MULTIPLE
<b>AP-DD</b>	DrainDawg™ Accessory Pack	EA	1
<b>AP-DK</b>	DrainKat™ Accessory Pack	EA	1
<b>BS-25</b>	Blow gun with safety tip for DrainDawg™ or DrainKat™	EA	1
<b>CB-03</b>	3/4 in. cone tip with female thread for DrainDawg™ or DrainKat™ blow gun	EA	1
<b>CK-141</b>	3/4 in. cone with male thread for use with whip hose for DrainDawg™ or DrainKat™	EA	1
<b>CW-15</b>	15 in. whip hose for DrainDawg™ or DrainKat™	EA	1
<b>DF-75</b>	DrainDawg™ inflatable tip for drain line blowout	EA	1
<b>FA-01</b>	Nitrogen to CO <sub>2</sub> adapter, male by male for DrainKat™	EA	1
<b>FA-02</b>	Nitrogen to CO <sub>2</sub> adapter, female by female for DrainDawg™	EA	1
<b>FA-03</b>	CO <sub>2</sub> transfill adapter for DrainKat™	EA	1
<b>QN-S3</b>	Needle tip with female thread for DrainDawg™ or DrainKat™ blow gun	EA	1
<b>TC-25</b>	Tire chuck for DrainDawg™	EA	1
<b>TG-10</b>	120 in. blow gun hose for DrainDawg™	EA	1
<b>TG-87A</b>	87 in. blow gun hose for DrainKat™	EA	1



**CONDENSATE DRAIN PANS, FITTINGS, ADAPTERS**

**A/C Secondary Condensate Drain Pans**

Rolled edges for durability, ribbed bottoms for rigidity, and reinforced corners for strength. 3/4 in. PVC fittings are included with each pan. No seams, no rust, and no leakage. ABS materials will not put out toxic smoke. Available in over 20 convenient sizes. Five pans per clip.

CATALOG NO.	BOTTOM DIMENSION		OVERALL DIMENSION		DEPTH		UOM	ORDER MULTIPLE
	IN.	CM.	IN.	CM.	IN.	CM.		
<b>6-1838L</b>	18" x 38"	46 x 97	20" x 40"	51 x 102	2"	5	EA	5
<b>6-1838S</b>	18" x 38"	46 x 97	20" x 40"	51 x 102	2"	5	EA	5
<b>6-2424L</b>	24" x 24"	61 x 61	26" x 26"	66 x 66	2"	5	EA	5
<b>6-2626L</b>	26" x 26"	66 x 66	28" x 28"	71 x 71	2"	5	EA	5
<b>6-2739L</b>	27" x 39"	69 x 99	29" x 41"	74 x 104	2"	5	EA	5
<b>6-2748L</b>	27" x 48"	69 x 122	29" x 50"	74 x 127	2"	5	EA	5
<b>6-2748L-100</b>	27" x 48"	69 x 122	29" x 50"	74 x 127	2"	5	EA	100
<b>6-2763L</b>	27" x 63"	69 x 160	29" x 65"	74 x 165	2"	5	EA	5
<b>6-3030L</b>	30" x 30"	76 x 76	32" x 32"	81 x 81	2"	5	EA	5
<b>6-3050L</b>	30" x 50"	76 x 127	32" x 52"	81 x 132	2"	5	EA	5
<b>6-3060L</b>	30" x 60"	76 x 152	32" x 62"	81 x 157	2"	5	EA	5
<b>6-3060S</b>	30" x 60"	76 x 152	32" x 62"	81 x 157	2"	5	EA	5
<b>6-3060L-100</b>	30" x 60"	76 x 152	32" x 62"	81 x 157	2"	5	EA	100
<b>6-3263L</b>	32" x 63"	81 x 160	34" x 65"	86 x 165	2"	5	EA	5
<b>6-3263S</b>	32" x 63"	81 x 160	34" x 65"	86 x 165	2"	5	EA	5
<b>6-3660L</b>	36" x 60"	91 x 152	38" x 62"	97 x 157	2"	5	EA	5
<b>6-3660S</b>	36" x 60"	91 x 152	38" x 62"	97 x 157	2"	5	EA	5

L = Drain Line Outlets in Long Side      S = Drain Line Outlets in Short Side



**CONDENSATE DRAIN PANS, FITTINGS, ADAPTERS cont'd**

**High Rise Pans™**

The High Rise Pan™ is an innovative new plastic drain pan design which allows placement of an air handler 2 3/4in. above the outside lip of the pan without the need for separate, cumbersome mounting blocks. The pan has a molded in network of risers to give a 5in. lift. The risers are positioned to accept a wide variety of air handler sizes. Each riser has a specially shaped area at each end to accommodate a 2in. x 2in. anti vibration pad which allows for quiet operation at all times. Other features include heavy duty reinforcement throughout to give plenty of support as well as rolled edges for durability. One piece plastic construction ensures no rust, leaks, or seams to split. Each High Rise Pan™ comes complete with a Condensate Cop™ float switch, 6 EVA™ anti vibration pads, and 1 3/4in. PVC male adapter. Installation is straightforward and hassle free.

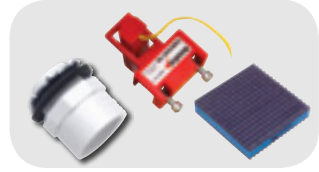

CATALOG NO.	DESCRIPTION	UOM	ORDER MULTIPLE
6-HK2748	High Rise Pan™ 27" x 48" with Installation Kit including: One CC-1 Condensate Cop, Six MP-2E 2" x 2" EVA™ Pads, One 6-1 3/4" PVC male adapter	EA	5
6-HK2748-1	Single Pack Kit – High Rise Pan™ 27" x 48" with Installation Kit including: One CC-1 Condensate Cop, Six MP-2E 2" x 2" EVA™ Pads, One 6-1 3/4" PVC male adapter	EA	1
6-HK2766	High Rise Pan™ 27" x 66" with Installation Kit including: One CC-1 Condensate Cop, Six MP-2E 2" x 2" EVA™ Pads, One 6-1 3/4" PVC male adapter	EA	5
6-HK2766-1	Single Pack Kit – High Rise Pan™ 27" x 66" with Installation Kit including: One CC-1 Condensate Cop, Six MP-2E 2" x 2" EVA™ Pads, One 6-1 3/4" PVC male adapter	EA	1
6-HK3050	High Rise Pan™ 30" x 50" with Installation Kit including: One CC-1 Condensate Cop, Six MP-2E 2" x 2" EVA™ Pads, One 6-1 3/4" PVC male adapter	EA	5
6-HK3050-1	Single Pack Kit – High Rise Pan™ 30" x 50" with Installation Kit including: One CC-1 Condensate Cop, Six MP-2E 2" x 2" EVA™ Pads, One 6-1 3/4" PVC male adapter	EA	1
6-HK3060	High Rise Pan™ 30" x 60" with Installation Kit including: One CC-1 Condensate Cop, Six MP-2E 2" x 2" EVA™ Pads, One 6-1 3/4" PVC male adapter	EA	5
6-HK3060-1	Single Pack Kit – High Rise Pan™ 30" x 60" with Installation Kit including: One CC-1 Condensate Cop, Six MP-2E 2" x 2" EVA™ Pads, One 6-1 3/4" PVC male adapter	EA	1

**Heavy Duty High Rise Pans**

A thicker, tougher version of our regular High Rise Pans. Each pan includes a kit with one CS1200 float switch, six EVA™ anti-vibration pads and one 3/4" PVC male adapter.



CATALOG NO.	DESCRIPTION	UOM	ORDER MULTIPLE
6-HK3050HD	Heavy Duty High Rise Pan 30" x 50"	EA	5
6-HK3060HD	Heavy Duty High Rise Pan 30" x 60"	EA	5
6-HK3070HD	Heavy Duty High Rise Pan 30" x 70"	EA	5

**Metal Drain Pan**

The ultimate in drain pan design — tailored for easy distribution and installation. Full of features to make life easier on both the distributor and the contractor. Seamless, one piece metal construction with rolled edges on all sides for maximum safety and integrity. Nestable as well — a stack of 70 pans is only a foot high! Once on site, you'll never have to return to the distributor for missing parts. The fittings are packaged with the pan for simple and efficient installation. Choose between two possible drain outlet positions and install with confidence.



CATALOG NO.	DESCRIPTION	UOM	ORDER MULTIPLE
6-M2748	26 Gauge Metal Drain Pan – 27" x 48"	EA	5
6-M2763	26 Gauge Metal Drain Pan – 27" x 63"	EA	5
6-M3030	26 Gauge Metal Drain Pan – 30" x 30"	EA	5
6-M3050	26 Gauge Metal Drain Pan – 30" x 50"	EA	5
6-M3060	26 Gauge Metal Drain Pan – 30" x 60"	EA	5
6-M3263	26 Gauge Metal Drain Pan – 32" x 63"	EA	5

**Furnace Pans**

DiversiTech furnace pans are designed specifically for furnace installations. Their one piece construction provides strength and durability for any furnace installation.



CATALOG NO.	DESCRIPTION	UOM	ORDER MULTIPLE
6-HK3364FUR	Furnace Pan – 33" x 64" with installation kit	EA	
6-HK3378FUR	Furnace Pan – 33" x 78" with installation kit	EA	

**A/C Condensate Drain Pan Fittings**

The Drain Pan Fittings are designed to be used with our Condensate Drain Pans.



CATALOG NO.	DESCRIPTION	UOM	ORDER MULTIPLE
6-1	3/4" Slip	EA	50
6-2	1" Slip	EA	50
6-3	3/4" Slip with Plastic Nut	EA	50
6-5	3/4" Female Pipe Thread	EA	50

**Water Heater Pans**

Aluminum water heater pans can be installed under gas or electric water heaters to protect from water damage. Includes a 1" PVC drain fittings to allow for connection to indirect drain. Each pan is manufactured from .032 in. prime aluminum with a pre-cut side opening to accommodate a drain fitting. Pan depth is a minimum 2.5 in.



CATALOG NO.	DESCRIPTION	UOM	ORDER MULTIPLE
6-M22	Aluminum Water Heater Pan - 22 in.	EA	6
6-M24	Aluminum Water Heater Pan - 24 in.	EA	6
6-M26	Aluminum Water Heater Pan - 26 in.	EA	6
6-M30	Aluminum Water Heater Pan - 30 in.	EA	6

**CONDENSATE DRAIN PANS, FITTINGS, ADAPTERS cont'd**

**Mini-Split Drain Adapters**

Mini Split fan units — either ceiling cassettes or wall cassettes — typically have a unique (metric) drain line fitting. DiversiTech's adapters convert this metric fitting to standard drain line tubing sizes.



CATALOG NO.	DESCRIPTION	UOM	ORDER MULTIPLE
<b>230-DLFY</b>	Mini-Split Drain Line Wye	EA	1
<b>230-DLF16</b>	16mm Mini-Split Drain Line Adapter	EA	1
<b>230-DLF18</b>	18mm Mini-Split Drain Line Adapter	EA	1
<b>230-DLF20</b>	20mm Mini-Split Drain Line Adapter	EA	1
<b>230-DLF25</b>	25mm Mini-Split Drain Line Adapter	EA	1
<b>230-DLF32</b>	32mm Mini-Split Drain Line Adapter	EA	1

**Condensate Drain Pans**

When a mini split system operates in heat pump mode, the outdoor coil becomes the evaporator coil. Typically, condensation generates from the evaporator coil. In certain installations, the condenser coil may be mounted overhead on brackets affixed to a wall. In these overhead applications, dripping condensation may be a nuisance. Condensate drain pans bolt onto the condenser mounting brackets, and the drain line can be plumbed to a nearby drain location. Furnished complete with all mounting hardware and drain pan outlet, condensate drain pans are available in either plastic or powder coated steel.

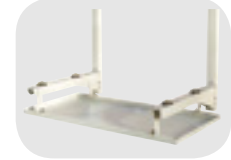

CATALOG NO.	DESCRIPTION	UOM	ORDER MULTIPLE
<b>230-DPPL</b>	Poly Condensate Drain Pan (Large)	EA	1
<b>230-DPPM</b>	Poly Condensate Drain Pan (Medium)	EA	1

**DRAIN LINE, TUBING**

**Mini-Split Condensate Drain Line**

A unique drain line for mini-split units. This large diameter drain line is typical for mini-split installations. Furnished in 160 feet lengths with cut marks every 3.28 feet. Accommodates 5/8" and 3/4" connections.



CATALOG NO.	DESCRIPTION	UOM	ORDER MULTIPLE
<b>230-DL16</b>	5/8" ID Mini-Split Drain Line	EA	160'
<b>230-DL16-20</b>	5/8" ID Mini-Split Drain Line – 20' section	EA	1

**Clear Vinyl Tubing**

Clear vinyl hose applications include: air conditioning and refrigeration condensate drains, condensate pump discharge lines and humidifier overflows.



CATALOG NO.	DESCRIPTION	UOM	ORDER MULTIPLE
<b>7-316</b>	3/16" ID Clear Vinyl Tubing – 100' section	EA	100'
<b>7-CVMINITUBE</b>	3/16" ID CVMINI Tubing – 100' section	EA	100'
<b>7-14</b>	1/4" ID Clear Vinyl Tubing – 100' section	EA	100'
<b>7-38</b>	3/8" ID Clear Vinyl Tubing – 100' section	EA	100'
<b>7-12</b>	1/2" ID Clear Vinyl Tubing – 100' section	EA	100'
<b>7-58</b>	5/8" ID Clear Vinyl Tubing – 100' section	EA	100'
<b>7-34</b>	3/4" ID Clear Vinyl Tubing – 100' section	EA	100'
<b>7-78</b>	7/8" ID Clear Vinyl Tubing – 100' section	EA	50'
<b>7-10</b>	1" ID Clear Vinyl Tubing – 100' section	EA	50'

**Gorilla Tube® Clear Vinyl Tubing**

Applications include: air conditioning and refrigeration condensate drains, condensate pump discharge lines, and humidifier overflows.

Several sizes from 1/4" to 1" diameter. Non-toxic clear vinyl chloride.

Select Gorilla Tube® over standard clear vinyl tube because:

- Extra rigid design resists crimping and kinking due to durometer value of 80 (Shore A) and thicker wall
- Maximum service temperature 140°F (60°C)
- Better performance in cold weather climates.



CATALOG NO.	DESCRIPTION	UOM	ORDER MULTIPLE
<b>7-14P</b>	1/4", .250" I.D., .360" O.D., .055 wall thickness	EA	100'
<b>7-38P</b>	3/8", .375" I.D., .495" O.D., .060 wall thickness	EA	100'
<b>7-12P</b>	1/2", .500" I.D., .631" O.D., .066 wall thickness	EA	100'
<b>7-58P</b>	5/8", .625" I.D., .771" O.D., .073 wall thickness	EA	100'
<b>7-34P</b>	3/4", .750" I.D., .913" O.D., .082 wall thickness	EA	100'
<b>7-78P</b>	7/8", .875" I.D., 1.050" O.D., .088 wall thickness	EA	50'
<b>7-10P</b>	1", 1.000" I.D., 1.215" O.D., .108 wall thickness	EA	50'

**Braided Clear Vinyl Tubing**

Braided clear vinyl offers better strength and sealing than regular clear vinyl tubing and is very kink-resistant.



CATALOG NO.	DESCRIPTION	UOM	ORDER MULTIPLE
<b>7-14B</b>	1/4" ID Braided Clear Vinyl Tubing – 100' section	EA	100'
<b>7-14B50</b>	1/4" ID Braided Clear Vinyl Tubing – 50' section	EA	50'
<b>7-38B</b>	3/8" ID Braided Clear Vinyl Tubing – 100' section	EA	100'
<b>7-38B50</b>	3/8" ID Braided Clear Vinyl Tubing – 50' section	EA	50'
<b>7-12B</b>	1/2" ID Braided Clear Vinyl Tubing – 100' section	EA	100'
<b>7-12B50</b>	1/2" ID Braided Clear Vinyl Tubing – 50' section	EA	50'
<b>7-58B</b>	5/8" ID Braided Clear Vinyl Tubing – 100' section	EA	100'
<b>7-58B50</b>	5/8" ID Braided Clear Vinyl Tubing – 50' section	EA	50'
<b>7-34B</b>	3/4" ID Braided Clear Vinyl Tubing – 100' section	EA	100'
<b>7-34B50</b>	3/4" ID Braided Clear Vinyl Tubing – 50' section	EA	50'

**TAPES**

**Cork Insulation Tape**

Adheres firmly to all metals. Use on hot or cold pipes to stop condensation and drips.



CATALOG NO.	DESCRIPTION	UOM	ORDER MULTIPLE
<b>6-330</b>	Cork Insulation Tape – 1/8" x 2" x 30' Roll – Black	EA	12

**Foam Insulation Tape**

Superior self-adhesive foam tape can be used on hot or cold pipes. Fits well around valves and fittings. Easily cut and molded.



CATALOG NO.	DESCRIPTION	UOM	ORDER MULTIPLE
<b>6-9718</b>	Foam Insulation Tape – 1/8" x 2" x 30' Roll – Black	EA	12

**PTFE Tape**

Made of pure white PTFE. Non toxic. For use with chemicals, solvents, oxygen, and on food lines. Withstands up to 2000 psi of pressure.



CATALOG NO.	DESCRIPTION	UOM	ORDER MULTIPLE
<b>6-733</b>	Teflon Tape – 1/2" x 520"	EA	100
<b>6-734</b>	Teflon Tape – 1/2" x 260"	EA	100
<b>6-735</b>	Teflon Tape – 3/4" x 520"	EA	100
<b>6-736</b>	Teflon Tape – 3/4" x 260"	EA	100

# GENERAL INDUSTRIAL

Abrasive Cloths.....	92
Aerosols.....	92
Batteries By Rayovac®.....	93
Carton Sealing Tape and Dispenser.....	93
Contact Cleaners.....	93-94
Degreasers.....	94
Drop Cloths.....	94
Hand Cleaners.....	94
Industrial Towels.....	95
Lubricants.....	95-96
Markers.....	97
Paints and Primers.....	97
Safety Supplies, Devices.....	98
Sealant, Epoxy, Glue.....	99
Sealing Compounds, Adhesive.....	99-101
Sheet Metal Screws.....	101-102
Wasp, Hornet and Yellow Jacket Killers.....	102



**ABRASIVE CLOTHS**

**All Purpose Cleaning Pads**

For cleaning copper tubes and fittings. Made of nylon and will not rust. Can be used wet or dry. Leaves no residue and is long lasting.



**ACP-10**

CATALOG NO.	DESCRIPTION	UOM	ORDER MULTIPLE
<b>ACP-10</b>	All Purpose Cleaning Pads – pack of 10	PK	1

**Abrasive Cloth**

Aluminum oxide, high quality 120 grit, abrasive cloth to thoroughly clean copper and steel tubing. Works wet or dry. Exceeds industry standards for abrasive cloth.



**SC-10**

CATALOG NO.	DESCRIPTION	UOM	ORDER MULTIPLE
<b>SC-10</b>	Abrasive Cloth – 1-1/2" x 10 yds.	EA	1
<b>SC-25</b>	Abrasive Cloth – 1-1/2" x 25 yds.	EA	1

**Grip-Cut™**

Open mesh sand screen cloth. Aluminum oxide grain resin bonded to synthetic nylon cloth. 100% waterproof, but can also be used dry for sanding by hand or with portable tools. Most effective where clogging is a problem, such as soft materials. 180 grit.



**SCM-5**

CATALOG NO.	DESCRIPTION	UOM	ORDER MULTIPLE
<b>SCM-5</b>	Grip-Cut™ – 1-1/2" x 5 yds.	EA	1
<b>SCM-10</b>	Grip-Cut™ – 1-1/2" x 10 yds.	EA	1
<b>SCM-25</b>	Grip-Cut™ – 1-1/2" x 25 yds.	EA	1

**AEROSOLS**

**Sure-Stick Heavy Duty Adhesive Spray**

Wide web spray adhesive ideal for both temporary or permanent bonding. Waterproof, transparent and non-staining. Use for the toughest adhesive applications with leather, cardboard, most plastics, polyethylene sheeting and insulation in HVAC applications. Cleans with mineral spirits. Not for use on vinyl.



**315-20**

CATALOG NO.	DESCRIPTION	UOM	ORDER MULTIPLE
<b>315-20</b>	Sure-Stick Adhesive Spray – 12 oz. Aerosol	EA	12

**CBC II Contact Cleaner**

A plastic safe, non flammable electronic contact and circuit board cleaner. Dries fast, leaves no residue. No harsh fumes or odors.



**362-16**

CATALOG NO.	DESCRIPTION	UOM	ORDER MULTIPLE
<b>362-16</b>	CBC II Contact Cleaner – 10 oz. Aerosol	EA	12

**Sweat-Free Pipe Insulation Spray**

An aerosol spray on insulation specifically developed for cold water pipes, refrigeration and air conditioning lines. Stops sweating and dripping problems. Dries to a clean, white, flexible and water resistant coating. Adheres to galvanized, black iron, steel, brass, copper and PVC piping.



**770-15**

CATALOG NO.	DESCRIPTION	UOM	ORDER MULTIPLE
<b>770-15</b>	Sweat-Free Pipe Insulation – 15 oz. Aerosol	EA	12

**Glass Cleaner**

A foaming premium glass cleaner that powers through the toughest grease and grime on any glass or hard surface. Leaves a streak-free shine.



**325-12**

CATALOG NO.	DESCRIPTION	UOM	ORDER MULTIPLE
<b>325-12</b>	Glass Cleaner – 19 oz. Aerosol	EA	12

## BATTERIES BY RAYOVAC®

**Rayovac® is the Industrial Product Leader!** Rayovac® is the leader in the industrial battery market and has been for years, with an estimated 50% share of the traditional industrial distribution channel. Rayovac® introduced the top-selling industrial flashlight to the market, and set the quality standard by which all other industrial flashlights are measured today. Whether your customer is searching for a toolbox-tough flashlight or high-performance batteries, Rayovac® offers a broad range of products to meet your needs.

### Rayovac® Industrial Maximum Alkaline Batteries – Shrink Packed

- Same battery performance as the Contractor Packs at a lower cost
- Formulated specifically to exceed the everyday demands of industrial applications
- Outstanding dependability for “must work” applications



CATALOG NO.	DESCRIPTION	UOM	ORDER MULTIPLE
<b>7-ALAA</b>	Alkaline AA Battery – Shrink Packed, pack of 8	EA	8
<b>7-ALAAA</b>	Alkaline AAA Battery – Shrink Packed, pack of 8	EA	8
<b>7-ALC</b>	Alkaline C Battery – Shrink Packed, pack of 6	EA	6
<b>7-ALD</b>	Alkaline D Battery – Shrink Packed, pack of 6	EA	6
<b>7-AL9V</b>	Alkaline 9V Battery – Shrink Packed, pack of 6	EA	6

### Rayovac® Lantern Batteries

- Dependable performance — for “must work” applications
- Available in General Purpose, Heavy Duty, and Alkaline Maximum



CATALOG NO.	DESCRIPTION	UOM	ORDER MULTIPLE
<b>7-806</b>	6 Volt Alkaline Maximum – Spring Terminals, pack of 6	EA	6

### Rayovac® Industrial Maximum Alkaline Batteries — Contractor Packs

- Contractor preferred, clear, re-sealable package
- Greater battery per pack quantities command higher battery sales
- Displays much more readily than other competitive batteries
- In an HVAC test market, the Contractor Packs outsold the standard packs by a greater than 2 to 1 ratio!



CATALOG NO.	DESCRIPTION	UOM	ORDER MULTIPLE
<b>7-ALAA-24</b>	Alkaline AA Battery – Contractor Pack, pack of 24	EA	24
<b>7-ALAAA-18</b>	Alkaline AAA Battery – Contractor Pack, pack of 18	EA	18
<b>7-ALC-12</b>	Alkaline C Battery – Contractor Pack, pack of 12	EA	12
<b>7-ALD-12</b>	Alkaline D Battery – Contractor Pack, pack of 12	EA	12
<b>7-AL9V-12</b>	Alkaline 9V Battery – Contractor Pack, pack of 12	EA	12

## CARTON SEALING TAPE AND DISPENSER

### Carton Sealing Tape

This Clear 2.4 mil Sealing Tape is 2 in. nominal width and is 110 yds. in length



CATALOG NO.	DESCRIPTION	UOM	ORDER MULTIPLE
<b>540-2110C</b>	Carton Sealing Tape – 2” x 110 Yards – Clear	EA	36

### Carton Tape Dispenser

A Heavy Duty Tape Dispenser that holds 2 in. Tape.



CATALOG NO.	DESCRIPTION	UOM	ORDER MULTIPLE
<b>540-DISP</b>	2” Carton Tape Dispenser	EA	1

## CONTACT CLEANERS

### HF™ Contact Cleaner

A petroleum distillate based precision cleaner with a flash point of 205°F. It can be an alternative to CFCs when applications require higher flashpoints.



CATALOG NO.	DESCRIPTION	UOM	ORDER MULTIPLE
<b>CRC-4-140</b>	HF™ Contact Cleaner – 11 oz.	EA	12

### QD® Contact Cleaner

This contact cleaner is suitable for cleaning sensitive electronics and electrical equipment and does not leave any residue. It evaporates quickly and is safe to use on all plastics. This product is more useful where lower flashpoint cleaners are acceptable. The QD® Contact Cleaner is NSF K2 Registered.



CATALOG NO.	DESCRIPTION	UOM	ORDER MULTIPLE
<b>CRC-4CF</b>	QD® Contact Cleaner – 11 oz.	EA	12

**CONTACT CLEANERS** *cont'd*

**Electronic Degreaser**

This Advanced Technology Formula is non-chlorinated, non-conductive, non-corrosive and non-staining. It rapidly dissolves grease, oil and sludge for better efficiency of mechanical equipment. The Electronic Degreaser has no flash or fire point.



CATALOG NO.	DESCRIPTION	UOM	ORDER MULTIPLE
<b>CRC-4NU</b>	Electronic Degreaser – 15 oz.	EA	12

**DEGREASERS**

**Heavy Duty Degreaser**

This degreaser rapidly and effectively removes grease, oil, tar, and other residue to increase operating efficiency of equipment. It has no flash or fire point, making it an excellent alternative to 1,1,1-based cleaners. Please use caution on plastics.



CATALOG NO.	DESCRIPTION	UOM	ORDER MULTIPLE
<b>CRC-7X</b>	Heavy Duty Degreaser – 19 oz.	EA	12

**Heavy Duty Degreaser II**

The Heavy Duty Degreaser II is a non-chlorinated, zero VOC formula for cleaning where chlorinated solvents are prohibited. It has a high flashpoint of 180°F. This degreaser effectively removes soils with no residue build-up. Please exercise caution on plastics.



CATALOG NO.	DESCRIPTION	UOM	ORDER MULTIPLE
<b>CRC-7-140</b>	Heavy Duty Degreaser II – 15 oz.	EA	12

**Chlor-Free® Degreaser**

Non-chlorinated degreasing solvent which is used to remove oil, grease and other contaminants. It is especially useful for applications requiring a quick turnaround and where a low flashpoint solvent can be used.



CATALOG NO.	DESCRIPTION	UOM	ORDER MULTIPLE
<b>CRC-7Z</b>	Chlor-Free® Degreaser – 14 oz.	EA	12

**Citrus Degreaser**

The Citrus Degreaser has a new Low VOC Formula. The product removes grease, oil and lubricants with no water wash-off. It evaporates quickly and leaves no residue. The product gives off a pleasant citrus scent and is NSF C1 Registered.



CATALOG NO.	DESCRIPTION	UOM	ORDER MULTIPLE
<b>CRC-7PS</b>	Citrus Degreaser – 15 oz.	EA	12

**DROP CLOTHS**

**Canvas Drop Cloths**

Premium grade canvas drop cloths are made of first quality and full piece 100% cotton duck canvas fabric. The industrial grade canvas fabric is durable since it is tightly woven using virgin cotton yarn. The drop cloths are washable and reusable. Double stitched seams with heavy-duty rot resistant thread.

CATALOG NO.	DESCRIPTION	UOM	ORDER MULTIPLE
<b>DC-4128</b>	Canvas Drop Cloth - 4' x 12'	EA	1
<b>DC-9128</b>	Canvas Drop Cloth - 9' x 12'	EA	1



**HAND CLEANERS**

**Fast Orange® Hand Cleaner**

Three out of five people prefer Fast Orange® over other hand cleaners. The first biodegradable, waterless hand cleaner with aloe, lanolin, and jojoba. Smooth lotion and extra-fine pumice available. USDA Approved.



CATALOG NO.	DESCRIPTION	UOM	ORDER MULTIPLE
<b>HCO-7</b>	Fast Orange® – 7-1/2 fl. oz. Smooth Squeeze Bottle	EA	12
<b>HCO-15</b>	Fast Orange® – 15 oz. Smooth Squeeze Bottle	EA	12
<b>HCO-128</b>	Fast Orange® – 1 Gallon Smooth with Dispenser	EA	4
<b>HCP-7</b>	Fast Orange® – 7-1/2 fl. oz. Pumice Squeeze Bottle	EA	12
<b>HCP-15</b>	Fast Orange® – 15 oz. Pumice Squeeze Bottle	EA	12

**Kimberly-Clark Waterless Hand Wipes**

These wipes go wherever hands go to get dirty. Full sized 12" x 12" wipes for full sized cleaning. Natural cleaning agent is tough on grease, grime, ink, and paint. Dual textured – smooth for wiping on one side and tough for scrubbing on the other. More wipes with our 75 count bucket.



CATALOG NO.	DESCRIPTION	UOM	ORDER MULTIPLE
<b>5-42272</b>	Kimberly-Clark Waterless Hand Wipes – Bucket	EA	1



## INDUSTRIAL TOWELS

### WypAll Plus

Absorbs grease, oil, water and solvents from floors, hands, parts, tools and machinery. Tough enough for extra heavy jobs. Comes in a convenient pop-up box of 100 towels.



5-05790

CATALOG NO.	DESCRIPTION	UOM	ORDER MULTIPLE
5-05790	WypAll Plus Towels—White, pack of 100	PK	1

### Kimtex® Towels

Long lasting Kimtex® stands up to oils, chemicals and solvents better than ordinary shop towels. Cloth-like feel and performance. Towel size is 9-3/4" x 16-3/4". 100 towels/box. 5 boxes/case.

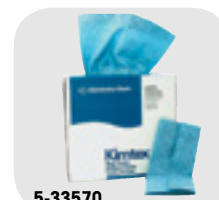

5-33570

CATALOG NO.	DESCRIPTION	UOM	ORDER MULTIPLE
5-33570	Kimtex Shop Towels, pack of 100	PK	1

### Teri® Towels

The Teri® reinforced towels feature multi-ply tissue reinforced with nylon webbing for added strength on the job. Made from 100% recycled paper. Towel size is 9-3/4" x 16-3/4". Towel color is white. Comes in a convenient pop up box. 126 towels/box. 10 boxes/case.



5-34790

CATALOG NO.	DESCRIPTION	UOM	ORDER MULTIPLE
5-34790	Teri Reinforced Towels, pack of 126	PK	1

### WypAll ShopPro X80 Towels

Like a rental shop towel, only more consistent. Engineered to feel like cloth and work even better. Absorbs more oil and water faster pound for pound than laundered shop towels. The ShopPro X80 is simply the heaviest duty towel in the Kimberly Clark line. 160 towels/box.



5-41041

CATALOG NO.	DESCRIPTION	UOM	ORDER MULTIPLE
5-41041	WypAll ShopPro X80 Towels, pack of 160	PK	1

### Workhorse® Manufactured Rags

The economical alternative to scrap rags. Workhorse® Manufactured Rags is the first product to be made from Kimberly-Clark's advanced new material – Hydroknit®. Durable, rag tough construction stands up to any task. Can be re-used time and time again. Available in white or blue.



5-41455

CATALOG NO.	DESCRIPTION	UOM	ORDER MULTIPLE
5-41455	9-3/4" x 16-3/4" White, pack of 100	PK	1
5-41411	9-3/4" x 16-3/4" Blue, pack of 100	PK	1

### Terry Towels

100% cotton. Minimum of 14" x 17". Pre-washed for absorbency, fully-hemmed, all-white, and reusable.



DTT-10

CATALOG NO.	DESCRIPTION	UOM	ORDER MULTIPLE
DTT-10	Terry Towels, pack of 10	PK	1
DTT-24	Terry Towels, pack of 24	PK	8

### Shop Towels

Heavy duty reusable towels. For wipe ups of grease, oil, water, etc. 100% cotton material is pre-shrunk and hemmed. Each towel measures 13" x 16".



ST-10

CATALOG NO.	DESCRIPTION	UOM	ORDER MULTIPLE
ST-4	Shop Towels, pack of 4	PK	1
ST-10	Shop Towels, pack of 10	PK	1
ST-24	Shop Towels, pack of 24	PK	1

## LUBRICANTS

### Knock'er Loose® Penetrating Solvent

An industrial strength, low viscosity penetrant designed to rapidly loosen and free seized, bound or frozen fasteners. This product also quickly permeates rust, scale, gum, grease and corrosion. Independent tests reveal that it outperforms its competition.



CRC-1KB

CATALOG NO.	DESCRIPTION	UOM	ORDER MULTIPLE
CRC-1KB	Knock'er Loose® Penetrating Solvent – 13 oz.	EA	12

### Screwloose® Industrial Penetrating Oil

A no compromise penetrant that attacks corrosion to free corroded fasteners and mechanical components. A super fast, powerful, concentrated penetrating solvent that loosens rust scale and corrosion and instantly penetrates minute and tightly fitted crevices.



CRC-8

CATALOG NO.	DESCRIPTION	UOM	ORDER MULTIPLE
CRC-8	Screwloose® Industrial Penetrating Oil – 11 oz.	EA	12

LUBRICANTS cont'd

**White Lithium Grease**

White Lithium Grease has superior lubrication and durability in any weather or temperature. It is useful as a break in lubricant for bearings or as a general purpose lubricant and corrosion inhibitor for tools, machinery and equipment.



CATALOG NO.	DESCRIPTION	UOM	ORDER MULTIPLE
<b>CRC-9</b>	White Lithium Grease – 10 oz.	EA	12

**Ultra Lite 3-36® Ultra Thin Non Staining Lubricant**

Ultra thin, non staining lubricant that resists oil, dirt and dust build up. This lubricant also seals out moisture and protects against corrosion. It is excellent for drying out electrical components.



CATALOG NO.	DESCRIPTION	UOM	ORDER MULTIPLE
<b>CRC-1</b>	Ultra Lite 3-36® Ultra Thin Non Staining Lubricant – 11 oz.	EA	12

**Cutting Oil**

Cutting Oil is a superior thread cutting lubricant for use on all types of metals, including brass, copper and aluminum. For use on ferrous and non-ferrous metals. Clings to vertical surfaces for improved performance.



CATALOG NO.	DESCRIPTION	UOM	ORDER MULTIPLE
<b>CRC-CF2</b>	Cutting Oil - 16 oz. aerosol	EA	1

**SP-400™ Corrosion Inhibitor**

Long-term corrosion inhibitor that protects equipment subject to heat, humidity, chemicals or severely corrosive atmospheres. This product is best to use on machined surfaces and assemblies subjected to long periods of storage.



CATALOG NO.	DESCRIPTION	UOM	ORDER MULTIPLE
<b>CRC-3</b>	SP-400™ Corrosion Inhibitor – 10 oz.	EA	12

**3-36® Multi-Purpose Lubricant & Corrosion Inhibitor**

A multi-purpose petroleum based compound that forms a clear, thin film that lubricates and protects against wear and corrosion. The product also displaces moisture and cleans.



CATALOG NO.	DESCRIPTION	UOM	ORDER MULTIPLE
<b>CRC-2</b>	3-36® Multi-Purpose Lubricant & Corrosion Inhibitor – 11 oz.	EA	12

**Sta-Plex™ Extreme Pressure Premium Red Grease**

A superior multi-purpose certified lithium complex based grease which contains extreme pressure, anti-wear, and anti-oxidation additives. The product is very useful in high temperature and performance applications. The drop point is 500°F.



CATALOG NO.	DESCRIPTION	UOM	ORDER MULTIPLE
<b>CRC-13</b>	Sta-Plex™ Extreme Pressure Premium Red Grease – 14 oz.	EA	10

**Zinc-It® Instant Cold Galvanize™ Zinc Rich Galvanize Coating**

High-performance zinc coating that electrochemically bonds with ferrous metals to form a galvanic cell. The product also fights rust and corrosion and can be used as a touch-up for damaged galvanized coatings. Zinc-It® Instant Cold Galvanize™ Zinc Rich Galvanize Coating dries quickly.



CATALOG NO.	DESCRIPTION	UOM	ORDER MULTIPLE
<b>CRC-5</b>	Zinc-It® Instant Cold Galvanize™ Zinc Rich Galvanize Coating – 13 oz.	EA	12

**Heavy Duty Silicone Mold Release**

This product provides maximum releases and is useful in difficult to remove parts. The Heavy Duty Silicone Mold Release is colorless, odorless, non-staining and non-corrosive.



CATALOG NO.	DESCRIPTION	UOM	ORDER MULTIPLE
<b>CRC-6</b>	Heavy Duty Silicone Mold Release – 12 oz.	EA	12

**WD-40®**

Loosens rusted parts. Stops squeaks. Removes tar, grease and adhesives. Displaces moisture. Protects metal. New Smart Straw can.



CATALOG NO.	DESCRIPTION	UOM	ORDER MULTIPLE
<b>741-001</b>	WD-40 – 8 oz.	EA	12
<b>741-002</b>	WD-40 – 11 oz.	EA	12
<b>741-003</b>	WD-40, 14.4oz with E-Z Reach	EA	12

**Pull-A-Spout Oiler**

All purpose oiler with a 14in. telescoping spout. Zooms out for long shots, and in for short shots, even zooms around corners. Squeeze bottle action. Perfect lubricant for general industrial use. Contains four ounces of finest quality carbon free, rust and oxidation inhibited lubricating oil. Plastic container won't short out around electrical connections. No leakage.



CATALOG NO.	DESCRIPTION	UOM	ORDER MULTIPLE
<b>CO-1</b>	Pull-A-Spout Oiler – 4 oz. – (Display)	EA	12
<b>CR-1</b>	Lubricant, Rust Breaker – 4 oz.	EA	12

**MARKERS**

**Valve Action Marker**

Large ink supply for increased mileage. Fast drying, smear and water resistant. Utilizes a patented valve-activated ink feed mechanism to supply ink as required, down to the last drop.



CATALOG NO.	DESCRIPTION	UOM	ORDER MULTIPLE
<b>540-799</b>	Valve Action Marker-Regular Tip – Red	EA	12
<b>540-800</b>	Valve Action Marker-Regular Tip – Black	EA	12

**Felt Tip Markers**

Sharpie® King-Sized Permanent Marker for metal, glass, paper and plastic. Durable metal body.



CATALOG NO.	DESCRIPTION	UOM	ORDER MULTIPLE
<b>540-811B</b>	Sharpie® King-Sized Marker	EA	12

**Valve Action Paint Marker**

Bright, crisp, opaque colors. The oil-based paint is quick drying and permanent on most surfaces. These markers also feature the patented valve-operated feed mechanism and a medium point.



CATALOG NO.	DESCRIPTION	UOM	ORDER MULTIPLE
<b>540-805</b>	Valve Action Paint Marker – Black	EA	12
<b>540-806</b>	Valve Action Paint Marker – Red	EA	12
<b>540-807</b>	Valve Action Paint Marker – White	EA	12
<b>540-808</b>	Valve Action Paint Marker – Yellow	EA	12

**PAINTS AND PRIMERS**

**General Purpose Spray Paint**

New, more complete line of professional quality fast drying spray paints. Color code compressors or refrigerant recovery cylinders to match standard refrigerant identifying colors. Touch up equipment housings. Product meets most recent VOC legislation and is currently compliant.



CATALOG NO.	DESCRIPTION	UOM	ORDER MULTIPLE
<b>799-001</b>	Spray Paint – Gloss Black – 12 oz.	EA	6
<b>799-002</b>	Spray Paint – Flat Black – 12 oz.	EA	6
<b>799-003</b>	Spray Paint – Gloss White – 12 oz.	EA	6
<b>799-004</b>	Spray Paint – Flat White – 12 oz.	EA	6
<b>799-005</b>	Spray Paint – Dark Machinery Gray – 12 oz.	EA	6
<b>799-006</b>	Spray Paint – Gray Primer – 12 oz.	EA	6
<b>799-010</b>	Spray Paint – Orange – 12 oz.	EA	6
<b>799-011</b>	Spray Paint – Aluminum (Silver) – 12 oz.	EA	6
<b>799-012</b>	Spray Paint – Zinc Rich Primer – 14 oz.	EA	6

**Industrial Enamel**

Finally an aerosol paint that sprays in any direction without clogging. We guarantee it! Dries tack free in 10 to 20 minutes; fully dry in just one hour. Excellent corrosion and solvent resistance. Resists heat up to 250°F. Now in 20 oz. cans. Product meets most recent VOC legislation and is currently compliant.



CATALOG NO.	DESCRIPTION	UOM	ORDER MULTIPLE
<b>799-021</b>	Industrial Enamel – Flat Black – 12 oz.	EA	6
<b>799-022</b>	Industrial Enamel – Gloss White – 12 oz.	EA	6
<b>799-024</b>	Industrial Enamel – Machinery Light Gray – 12 oz.	EA	6
<b>799-025</b>	Industrial Enamel – Aluminum – 12 oz.	EA	6

**High Heat Spray Paint**

An ultra high temperature coating formulated to resist temperatures up to 1300°F. Great for use on boilers, furnaces, steam pipes, chimney collars, compressors and engine manifolds. Product meets most recent VOC legislation and is currently compliant.



CATALOG NO.	DESCRIPTION	UOM	ORDER MULTIPLE
<b>799-040</b>	High Heat Spray Paint – Aluminum – 12 oz.	EA	6
<b>799-041</b>	High Heat Spray Paint – Black – 12 oz.	EA	6

**SAFETY SUPPLIES, DEVICES**

**Latex Gloves**

Disposable natural latex rubber which provide a natural feel and grip. Powdered.



**23010**

CATALOG NO.	DESCRIPTION	UOM	ORDER MULTIPLE
<b>23010</b>	Latex Gloves, pack of 50 pairs	PK	1

**Dust Masks**

Extremely lightweight, disposable, nuisance dust mask for non-toxic particles. Metal noseclips to fit individual facial contours.



**5-500**

CATALOG NO.	DESCRIPTION	UOM	ORDER MULTIPLE
<b>5-500</b>	Dust Masks, pack of 50	PK	1

**Nitrile Gloves**

Foam control gloves for industrial use that provide a high level of wet and dry grip. Standard in applications where tactile sensitivity is required.



**540-1005L**

CATALOG NO.	DESCRIPTION	UOM	ORDER MULTIPLE
<b>540-1005L</b>	Nitrile Gloves - Large, 1 pair per pack	EA	1

**Leather Work Gloves**

Versatile leather work gloves ideal for many industrial jobs. These leather work gloves offer: wing thumb pattern, continuous pull patch, seamless full leather index finger, leather knuckle strap, leather finger tips with elastic gather on back. Generously sized for a good working fit.

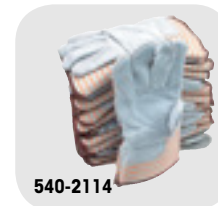

**540-2114**

CATALOG NO.	DESCRIPTION	UOM	ORDER MULTIPLE
<b>540-2114</b>	Leather Glove w/Safety Cuff, 1 pair per pack	EA	12

**Heavy Duty Work Gloves**

Your choice of durable work gloves. Washable, breathable, and durable for everyday use.



**540-HU1L**

CATALOG NO.	DESCRIPTION	UOM	ORDER MULTIPLE
<b>540-HU1L</b>	Heavy Utility Gloves - Large, 1 pair per pack	EA	1
<b>540-BH1L</b>	Box Handler Gloves - Large, 1 pair per pack	EA	1

**First Aid Kits**

10 and 25-unit first aid kits packaged in economy plastic boxes to assist when industrial accidents occur.



**FAK-25**

CATALOG NO.	DESCRIPTION	UOM	ORDER MULTIPLE
<b>FAK-10</b>	10-Unit First Aid Kit	EA	1
<b>FAK-25</b>	25-Unit First Aid Kit	EA	1

**Shoe Covers**

Slip these shoe covers on in seconds to protect carpet, tile, or wood from dirt and scuff marks. Customers will appreciate your professional appearance.



**SC-1**

CATALOG NO.	DESCRIPTION	UOM	ORDER MULTIPLE
<b>SC-1</b>	Navy Blue Shoe Covers, pack of 50 pairs	PK	1
<b>SC-1WP</b>	Waterproof Shoe Covers, pack of 50 pairs	PK	1
<b>SC-1SHU</b>	Dark Blue Shoe Covers, pack of 50 pairs	PK	1

**SEALANT, EPOXY, GLUE**

**Thread Sealant with PTFE**

General purpose sealant with the lubricity of PTFE for metal pipes. Won't shred like PTFE Tape. Allows easy disassembly. Resists common shop fluids. 60° to 400°F temp. resistance. Pressure resistance of 5000 PSI.



CATALOG NO.	DESCRIPTION	UOM	ORDER MULTIPLE
7-80632	Thread Sealant – 1/4 Pint Brush Can	EA	12
7-80633	Thread Sealant – 1 Pint Brush Can., 12 per pack	EA	12

**Wagner Adhesive Sealant**

For refrigerant sealing. Eliminates fastener loosening, leakage, and corrosion. Cures between thread flanks to seal against leakage and prevents thread corrosion. Offers sealing with maximum solvent resistance to the action of refrigerant (11, 12 and 22), ammonia and sulfur dioxide. Withstands corrosive liquids used in metal finishings and process industries. Ideal sealant for refrigeration, A/C, and process equipment using corrosive chemicals.



CATALOG NO.	DESCRIPTION	UOM	ORDER MULTIPLE
CAS-2712	Wagner Adhesive Sealant – 0.34 fl. oz.	EA	12

**Super Glue**

This adhesive can be used on dirty, greasy surfaces and the medium viscosity penetrates into preassembled and close fitting parts. It can be used on aluminum, metal, rubber, and most plastics for most tough jobs.



CATALOG NO.	DESCRIPTION	UOM	ORDER MULTIPLE
DEP052	Super Glue – 2 Gram Tube	EA	12

**Fast Cure Epoxy**

An easy-to-use, two part putty you simply mix and mold like clay. No complicated weighing or measuring required. Easy 1:1 cut-what-you-need mix ratio. Form it into any shape. It hardens in one hour and makes a final, steel-hard cure in 12 hours and can be sanded, drilled, machined, sawed and painted. Use on metal, wood, brick, stone, concrete, fiberglass, porcelain, tile and most plastics. Cures under water. 1.0 lb.

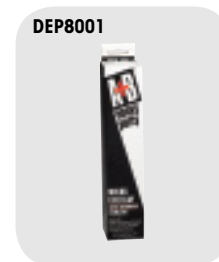

CATALOG NO.	DESCRIPTION	UOM	ORDER MULTIPLE
DEP8001	Gray Epoxy Putty – 1 lb. Kit	EA	24
DEP8002	White Epoxy Putty – 1 lb. Kit	EA	24

**J-B Weld**

The world's finest cold-weld compound for use when welding or soldering is out of the question due to cost, down time for repairs, or technical or environmental considerations. A remarkably easy, convenient, and inexpensive alternative to welding, soldering, and brazing. Literally pennies per use.



CATALOG NO.	DESCRIPTION	UOM	ORDER MULTIPLE
JB8265	J-B Weld 2 Part Epoxy	EA	6

**SEALING COMPOUNDS, ADHESIVE**

**Flexi-Patch™**

Flexi-Patch™ is an easy to use flexible repair patch ideal for repairing almost any surface. It cures quickly using only UV light from sunlight or a UV flashlight for a long lasting, permanent repair. Flexi-Patch is a fiberglass-reinforced polyester ideal for use on PVC, plastics, metal, wood, concrete and more. It's the easy way to permanently patch almost any surface. It dries hard for permanent repair. Can be drilled, tapped and painted once dry.



CATALOG NO.	DESCRIPTION	UOM	ORDER MULTIPLE
FP-36	Flexi-Patch fiberglass patch	EA	20

**Foam Sealant – One Component**

One component closed-cell expanding polyurethane foam sealant for lineal caulking applications. Air-moisture cure. Tack free in 20 minutes; fully cured in 12 hours. Paintable. Use for insulating and sealing around windows, doors, pipes, ducts and vents. Non-toxic when cured. Paint to protect from UV exposure. "R" value 4.7 (1" thickness). Foam contains fire retarding chemical and is U.L. Listed but not rated as a firestop product. Environmental concerns have led us to replace CFC's and HCFC's with hydrocarbon material in our one component foam products. See instructions on each product to ensure safe use and quality results.



CATALOG NO.	DESCRIPTION	UOM	ORDER MULTIPLE
01714	Foam Sealant – 12 oz. Can – Yields 275' (3/8" bead)	EA	12
01724	Foam Sealant – 20 oz. Can – Yields 460' (3/8" bead)	EA	12

### Foam Sealant – Two Component

Two component closed-cell expanding polyurethane foam sealant for cavity filling, surface coating and insulation applications. Rapid chemical cure (Component A and Component B). Tack free in 2 minutes, fully cured in 20 minutes. Use for insulation repairs in refrigerated enclosures. Spray coat and insulate tanks, pipes, tubs and panels. Non-toxic when cured. Paint to protect from UV exposure. "R" value 5 (1" thickness). Kits include dispensing nozzles, hose and flow control mechanism. Foam contains fire retarding chemicals and is U.L. Listed but is not rated as a firestop product.

10012



CATALOG NO.	DESCRIPTION	UOM	ORDER MULTIPLE
10012	Foam – 2 Kit – 15 bd. ft. Kit – Yields 1 cu. ft.	EA	12

### Firestop Products for Class A Buildings

U.L. Classified. Code Approved. Seal penetrations of plumbing, refrigeration and AC lines, ducts, vents and electrical cable through fire-rated floors, walls and ceilings. Easy-to-use, non-shrinking, non-toxic and permanently flexible. Blocks fire, gas, smoke, air and water migration. Use ceramic fiber filler together with putty or caulk for thick penetrations. Technical bulletins available.

16491



CATALOG NO.	DESCRIPTION	UOM	ORDER MULTIPLE
16491	Firestop Caulk – Red – 10.3 fl. oz. cartridge	EA	12

### Caulk Gun

Caulk guns can be used to hold the sealant to seal duct work.

7-100

7-200



CATALOG NO.	DESCRIPTION	UOM	ORDER MULTIPLE
7-100	Caulk Gun – Super Ratchet Type	EA	12
7-200	Caulk Gun – Standard Duty	EA	1

### High Temp Red Silicone Sealant

A one part non-slumping paste that cures to a tough, rubbery solid at room temperature. Formulated to perform at temperatures ranging from -85°F to 500°F for continuous operation, and to 600°F for intermittent exposure. Tack free cure time – 15 minutes. Full cure time – 24 hours.

7-4300



CATALOG NO.	DESCRIPTION	UOM	ORDER MULTIPLE
7-4300	High Temp Red Silicone Sealant – 10.1 oz. Cartridge	EA	12

### Geocel Caulking Sealant

Exceptional bonding and sealing caulk for interior and exterior applications involving seams, joints, ductwork, flashing and any similar use. Excellent adhesion to virtually any surface (metals, fiberglass, wood, concrete, brick and most plastics) even if moisture is present. Resealable, paintable, flexible. Will not crack, chip or peel. Specially formulated for the HVACR industry. Not available in California.

18001



CATALOG NO.	DESCRIPTION	UOM	ORDER MULTIPLE
18001	Clear Geocel Sealant – 10.3 oz. Cartridge	EA	24
18002	White Geocel Sealant – 10.3 oz. Cartridge	EA	24
18003	Aluminum/Gray Geocel Sealant – 10.3 oz. Cartridge	EA	24

### DiversiGum Sealing Compound

Non-hardening. For plugging openings through foundations or around refrigeration tube entry.

6-202-2



CATALOG NO.	DESCRIPTION	UOM	ORDER MULTIPLE
6-202-1	DiversiGum Sealing Compound – 1 lb. Slug	EA	24
6-202-2	DiversiGum Sealing Compound – 2 lb. Slug	EA	20
AG-25	DiversiGum Sealing Compound – 3/8" x 25' Caulking Cord	EA	12

### Silicone Sealant

Food grade 100% RTV Silicone Sealant. Can be used in applications for continuous use to 450°F. UV and water resistant. Long-term flexibility. Non-paintable. Available in 10.3 fl. oz. tube for use in standard caulk gun or in 3 fl. oz. squeeze tube.

7-4000

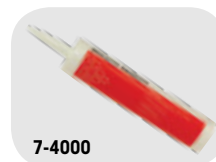

CATALOG NO.	DESCRIPTION	UOM	ORDER MULTIPLE
7-4000	Clear Silicone Sealant – 10.3 fl. oz. Tube	EA	12
7-4001	Clear Silicone Sealant – 3 fl. oz. Squeeze Tube	EA	48
7-4100	White Silicone Sealant – 10.3 fl. oz. Tube	EA	12
7-4101	White Silicone Sealant – 3 fl. oz. Squeeze Tube	EA	48
7-4200	Aluminum Silicone Sealant – 10.3 fl. oz. Tube	EA	12
7-80045	Pipe Joint Compound – 6 fl. oz. Tube	EA	12

**SEALING COMPOUNDS, ADHESIVE cont'd**

**25 Year Acrylic Latex Painter's Caulk**

For both interior and exterior use. DiversiTech's 25 Year Acrylic Latex Painter's Caulk forms a tough, paintable resilient bond to all building material surfaces. Excellent resistance to water, weathering and moisture vapor.



CATALOG NO.	DESCRIPTION	UOM	ORDER MULTIPLE
<b>7-4500</b>	White Acrylic Latex Caulk – 10.1 oz. Cartridge	EA	12
<b>7-4400</b>	Clear Acrylic Latex Caulk – 10.1 oz. Cartridge	EA	12

**Pro-Air Industrial Grade Spray Adhesive**

A clear, pressure sensitive aerosol adhesive with exceptional tack and shear strength characteristics. An excellent choice for most permanent adhesive applications: duct liner and wrap, sheet aluminum, fiberglass insulation board, and much more. The aerosol package offers a specially designed web spray pattern for even, controlled distribution. Flammability meets aerosol flame extension test requirements. Coverage is approximately 90-100 square feet per pound.



CATALOG NO.	DESCRIPTION	UOM	ORDER MULTIPLE
<b>GP1-40BL</b>	Pro-Air Spray Adhesive – 38 lb. Disposable Cylinder	EA	1
<b>GN-23H</b>	Spray Gun	EA	1

**Pro-Air Duct Sealant – UL 181 AM-BM Listed**

Water-based fiber-reinforced duct sealant/mastic formulated for indoor/outdoor use. Meets U.L. Class 1 rating and local codes while featuring long term flexibility and strength. Use on metal heating, ventilating, and A/C duct systems; as well as fiberglass duct board systems and flex duct systems. Recommended for use to 10" of water column pressure without the need for fiberglass mesh reinforcement.



CATALOG NO.	DESCRIPTION	UOM	ORDER MULTIPLE
<b>800-008</b>	Pro-Air Duct Sealant – 1/10 Gallon Tube – 10.5 oz.	EA	12
<b>800-009</b>	Pro-Air Duct Sealant – 1 Gallon Pail	EA	4

**Black Jack® Roof Cement**

Black Jack® All-Weather Roof Cement is an asphalt based patching compound designed to repair cracks, splits, seams and holes in roofing materials. It also works great in new construction and in setting flashings, drip edges and roofing material edges.

- Use in wet or dry conditions
- Seals flashings, and other roof projections
- Fiber reinforced
- Thick trowel grade



CATALOG NO.	DESCRIPTION	UOM	ORDER MULTIPLE
<b>RM-1G</b>	Black Jack All Weather Roof Cement – 1 gallon	EA	6
<b>RM-10</b>	Black Jack All Weather Roof Cement – 10 oz. tube	EA	12

**SHEET METAL SCREWS**

**Masonry Bit**

This bit is suitable for brick, tile, slate, cement, and cinder block. This bit is a nice addition to the toolbox.



CATALOG NO.	DESCRIPTION	UOM	ORDER MULTIPLE
<b>540-DB6</b>	Masonry Bit – 3/16" x 6"	EA	1

**Masonry Screw**

This product comes in a pack of 250 and is suitable for brick, tile, slate, cement, and cinder block. The screws are a nice addition to the toolbox.



CATALOG NO.	DESCRIPTION	UOM	ORDER MULTIPLE
<b>5-SCRMS</b>	Masonry Screw – 1/4" x 1-1/4", pack of 250	PK	1

**Anchor Kit**

Plastic anchor kit for sheet rock applications. Kit includes 100 anchors, screws and 1 masonry bit.



CATALOG NO.	DESCRIPTION	UOM	ORDER MULTIPLE
<b>540-AK100</b>	Anchor size 1/4 x 1, Screw Size 10 x 1-1/4 HWH Head Size 5/16 hex	EA	1

SHEET METAL SCREWS cont'd

Sheet Metal Screws  
– Taper Point

Hex washer slotted head. Burr-free. Full 5/16" head will not strip out of hex driver opening. Heat treated tapered point will not break or "walk". Packaged in resealable plastic cartons.



Sheet Metal Screws  
– Drill Point

Self-drilling, self-tapping. Hex washer head. Produces the optimum hole size, resulting in a tighter fit. Made from special heat treated steel for extra strength. Packaged in resealable plastic cartons.



CATALOG NO.	DESCRIPTION	UOM	ORDER MULTIPLE
5-SCR63-8	6 x 3/8 Taper Point, pack of 1,000	PK	1
5-SCR63-8BULK	6 x 3/8 Taper Point – Bulk, pack of 20,000	PK	1
5-SCR71-2	7 x 1/2 Taper Point, pack of 1,000	PK	1
5-SCR71-2BULK	7 x 1/2 Taper Point – Bulk, pack of 15,000	PK	1
5-SCR81-2	8 x 1/2 Taper Point, pack of 1,000	PK	1
5-SCR81-25M	8 x 1/2 Taper Point, pack of 5,000	PK	1
5-SCR81-2BULK	8 x 1/2 Taper Point – Bulk, pack of 12,000	PK	1
5-SCR83-4	8 x 3/4 Taper Point, pack of 1,000	PK	1
5-SCR83-4BULK	8 x 3/4 Taper Point – Bulk, pack of 10,000	PK	1
5-SCR81	8 x 1 Taper Point, pack of 500	PK	1
5-SCR81BULK	8 x 1 Taper Point – Bulk, pack of 7,500	PK	1
5-SCR81-12	8 x 1-1/2 Taper Point, pack of 250	PK	1
5-SCR81-12-100	8 x 1-1/2 Taper Point, pack of 100	PK	1
5-SCR81-12W	8 x 1-1/2 Taper Point w/White Head, pack of 250	PK	1
5-SCR81-12BULK	8 x 1-1/2 Taper Point – Bulk, pack of 5,000	PK	1
5-SCR82-100	8 x 2 Taper Point, pack of 100	PK	1
5-SCR82	8 x 2 Taper Point, pack of 350	PK	1
5-SCR82W	8 x 2 Taper Point w/White Head, pack of 250	PK	1
5-SCR82BULK	8 x 2 Taper Point – Bulk, pack of 3,000	PK	1
5-SCR103-4	10 x 3/4 Taper Point, pack of 1,000	PK	1
5-SCR103-4BULK	10 x 3/4 Taper Point – Bulk, pack of 10,000	PK	1
5-SCR101	10 x 1 Taper Point, pack of 500	PK	1
5-SCR101-2	10 x 1/2 Taper Point, pack of 1,000	PK	1
5-SCR101BULK	10 x 1 Taper Point – Bulk, pack of 7,000	PK	1

CATALOG NO.	DESCRIPTION	HEAD SIZE	UOM	ORDER MULTIPLE
5-SCR61-2DP	6 x 1/2 Drill Point, pack of 1,000	1/4"	PK	1
5-SCR61-2DPBULK	6 x 1/2 Drill Point – Bulk, pack of 15,000	1/4"	PK	1
5-SCR81-2DP	8 x 1/2 Drill Point, pack of 1,000	1/4"	PK	1
5-SCR81-2DPBULK	8 x 1/2 Drill Point – Bulk, pack of 10,000	1/4"	PK	1
5-SCR83-4DP	8 x 3/4 Drill Point, pack of 500	1/4"	PK	1
5-SCR83-4DPBULK	8 x 3/4 Drill Point – Bulk, pack of 10,000	1/4"	PK	1
5-SCR81DP	8 x 1 Drill Point, pack of 500	1/4"	PK	1
5-SCR81DPBULK	8 x 1 Drill Point – Bulk, pack of 7,500	1/4"	PK	1
5-SCR101-2DP	10 x 1/2 Drill Point, pack of 500	5/16"	PK	1
5-SCR101-2DPBULK	10 x 1/2 Drill Point – Bulk, pack of 10,000	5/16"	PK	1
5-SCR103-4DP	10 x 3/4 Drill Point, pack of 500	5/16"	PK	1
5-SCR103-4DP100	10 x 3/4 Drill Point, pack of 100	5/16"	PK	1
5-SCR103-4DPBULK	10 x 3/4 Drill Point – Bulk, pack of 5,000	3/4"	PK	1
5-SCR101DP	10 x 1 Drill Point, pack of 500	5/16"	PK	1
5-SCR101DPBULK	10 x 1 Drill Point – Bulk, pack of 5,000	5/16"	PK	1
5-SCR101-12DP	10 x 1-1/2 Drill Point, pack of 250	5/16"	PK	1
5-SCR101-12DPBULK	10 x 1-1/2 Drill Point – Bulk, pack of 3,500	5/16"	PK	1
5-SCR102DP	10 x 2 Drill Point, pack of 350	5/16"	PK	1
5-SCR102DPBULK	10 x 2 Drill Point – Bulk, pack of 2,500	5/16"	PK	1

WASP, HORNET, AND YELLOW JACKET KILLERS

Sting Less Wasp & Hornet Killer

Kills wasps, hornets and yellow jackets. Very fast-acting when insects are hit directly. Allow approximately 24 hours for those that were not directly hit. This container delivers a 20-foot jet blast to knock down the insects and allow for the user to remain at a safe distance.



CATALOG NO.	DESCRIPTION	UOM	ORDER MULTIPLE
436-20	Sting Less Wasp & Hornet Spray – 14 oz. Aerosol	EA	12

Wasp & Hornet Killer by ENFORCER

Enforcer's Wasp & Hornet Killer shoots a 20-foot jet blast for instant knockdown of wasps, hornets, and yellow jackets. Enforcer's Wasp & Yellow Jacket Foam is a 20-foot blast of blanketing foam that plugs yellow jacket holes and clings to wasp and hornet nests, preventing their escape.



CATALOG NO.	DESCRIPTION	UOM	ORDER MULTIPLE
8-WH16	Enforcer Wasp & Hornet Killer – 16 oz. Aerosol	EA	12
8-FWH16	Enforcer Wasp & Yellow Jacket Foam – 16 oz. Aerosol	EA	12





Anchors.....	116
Boxes, Rings, and Covers.....	118-119
Cable Connectors.....	119-120
Cable Ties and Accessories.....	120-121
Conduit Fittings.....	121-122
General Tools.....	122
High Temperature Solderless Terminals.....	114
Nuts and Bolts.....	123-124
Plastic Anchor Kits.....	117
Power Cords and Work Lights.....	124
Screws.....	124
Slip-On Solderless Terminals.....	110-111
Special Purpose Solderless Terminals.....	111-112
Specialty Fasteners.....	125
Specialty Fittings.....	126
Standard Solderless Terminals.....	112-113
Storage Containers.....	126
Tapes.....	126
Terminal Kits.....	115
Testers, Leads, Clips, Fuses.....	127
Wire.....	127-128
Wiring Devices.....	128-132

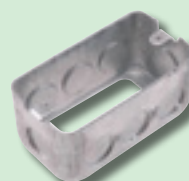
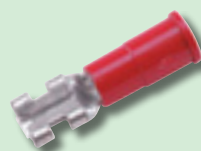

# How to sell DEVCO® products

*DEVCO® merchandising displays are an easy and attractive way to showcase a variety of DEVCO® products in your store. Offered in three different versions, each display rack includes everything you need to create extra sales for your business.*

## Easy to Display

DEVCO® provides turnkey merchandising solutions for wholesale distribution. Attractive, easy to set-up merchandising displays provide a great way to highlight DEVCO® products and make it easy for customers to find what they need. The point of sale display merchandises the products, enabling the distributor to add additional sales.

The products merchandised on the carousel are impulse buy items. The items are packed so they cost the contractor only a few dollars, and most are less than \$10 each.

## Easy to Profit

DEVCO® displays provide a typical distributor branch with easy add-on sales that build profits. Each display can generate significant sales and margins for the store while providing contractors with the parts they need to finish the job. These self-service displays are a great way to increase revenue with minimal effort.

## The Perfect Plan

Each DEVCO® Merchandising display comes with a complete plan-o-gram to make merchandising it simple and fast. And there are three different versions available so you can choose the display that's right for your business and customers.

And when you purchase the DEVCO® products to fill it up, the merchandising rack is **loaned free of charge.**



Display Rack	Featured Products
<b>EZC</b>	Solderless terminals, ground connectors, fasteners, anchor kits, cable ties, washers, hex nuts, cable clamps, sheet metal screws and hose clamps
<b>Electrical</b>	Ground adaptors, outlets, boxes, bushings, cable connectors, extension rings, indicator lights, plugs and connectors, receptacles, reducing washers, toggle switches and hook up wire
<b>Combo</b>	Solderless terminals, insulated rings, ground adaptors, covers, reducing washers, plugs and connectors, hook up wire, fasteners, hex nuts and self drilling screws



**PLAN-O-GRAM FOR DEVCO ELEC RACK (MKT-POP-DEVELEC)**

**PANEL A**

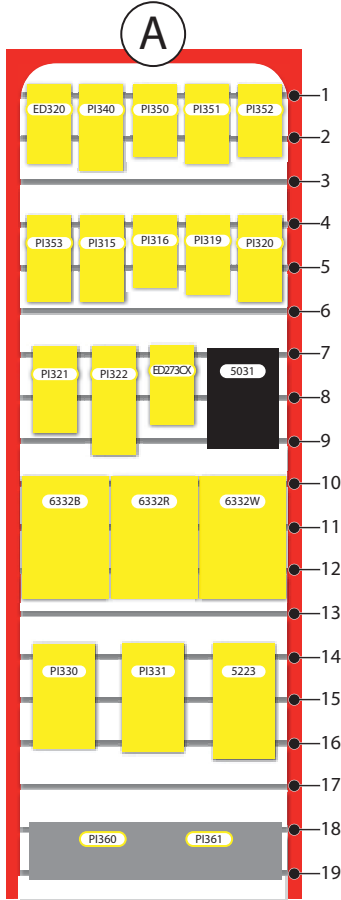

**PANEL B**

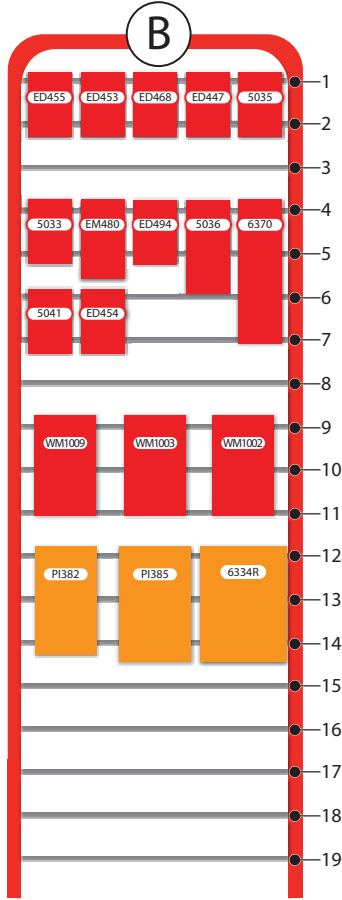

**PANEL C**

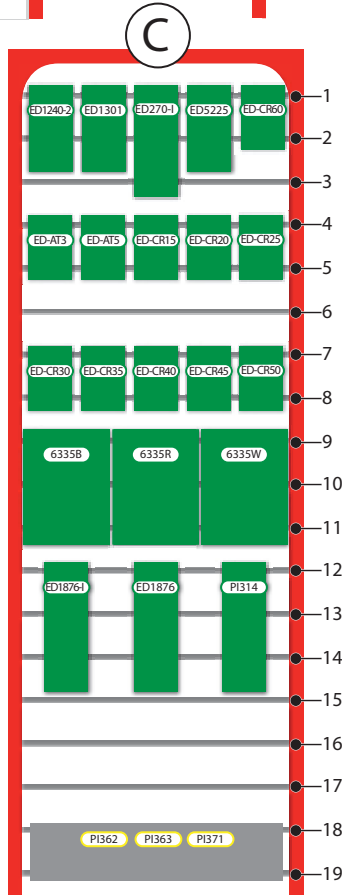

**PANEL D**

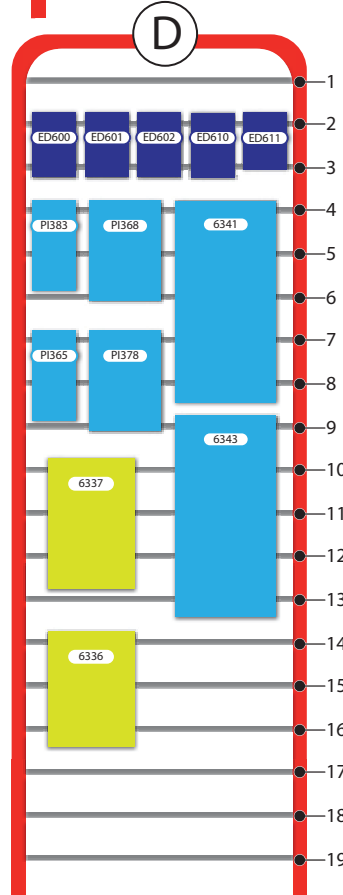

**MKT-POP-DEVELEC**

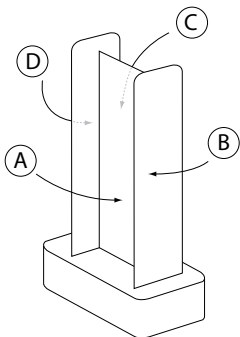

**MKT-POP-DEVELEC**  
Merchandising Rack  
72" x 22" x 20.5"

NOTE: Item numbers in **RED** indicate Made in the U.S.A.



PLAN-O-GRAM FOR DEVCO EZC RACK (MKT-POP-DEVEZC)

PANEL

A

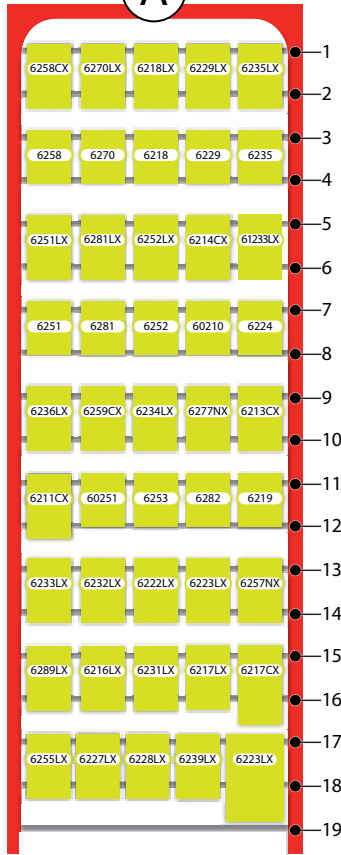

PANEL

B

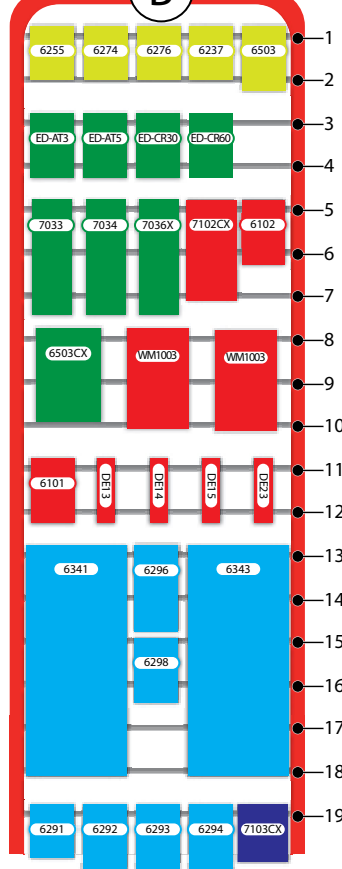

PANEL

C

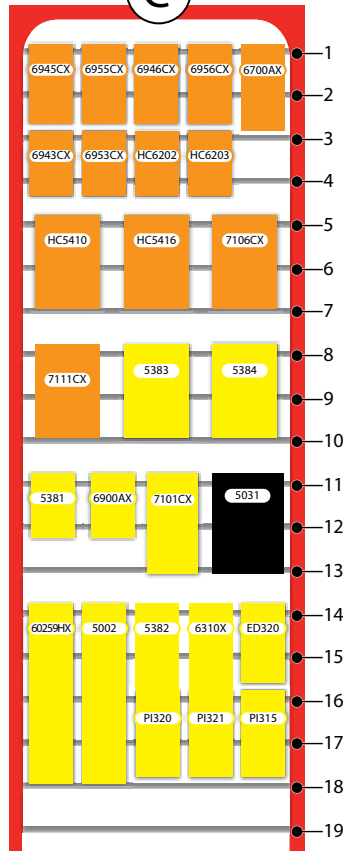

PANEL

D

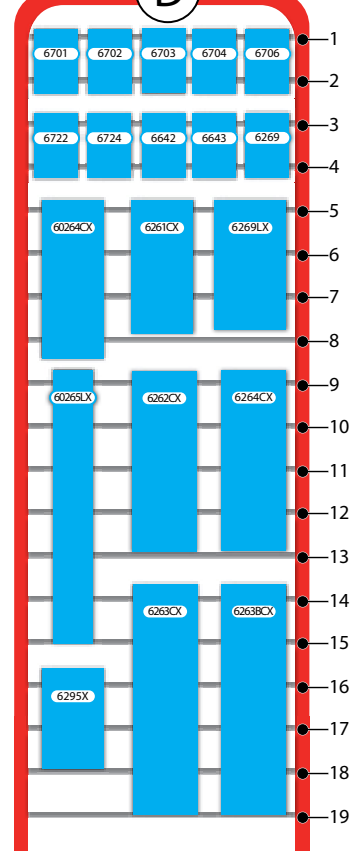

MKT-POP-DEVEZC

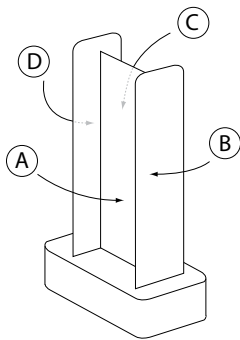

MKT-POP-DEVEZC  
Merchandising Rack  
72" x 22" x 20.5"

**PLAN-O-GRAM FOR DEVCO COMBO RACK (MKT-POP-DEVCOMBO)**

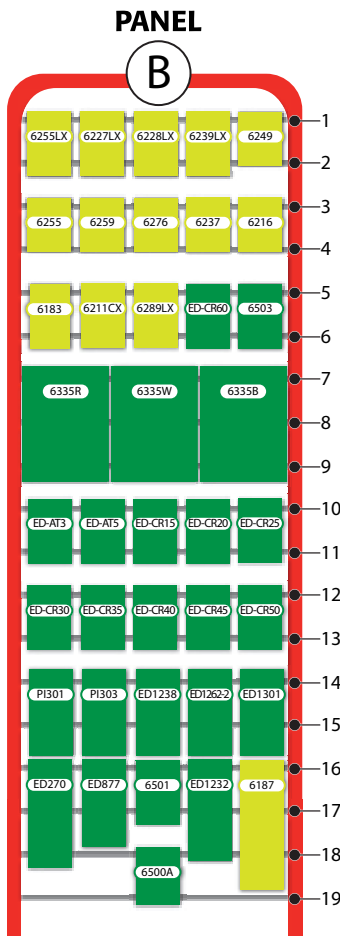
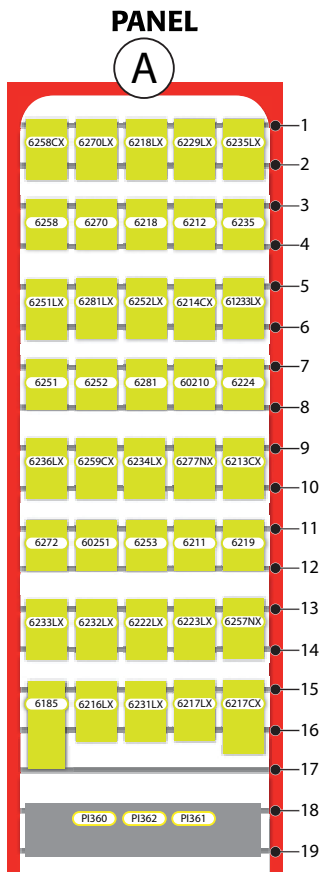

**MKT-POP-DEVCOMBO**

**PANEL C**

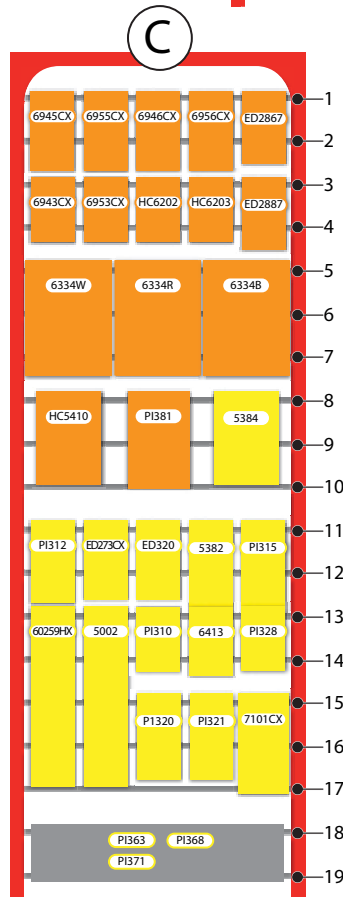

**PANEL D**

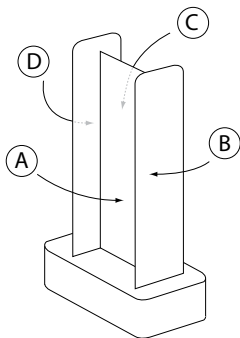
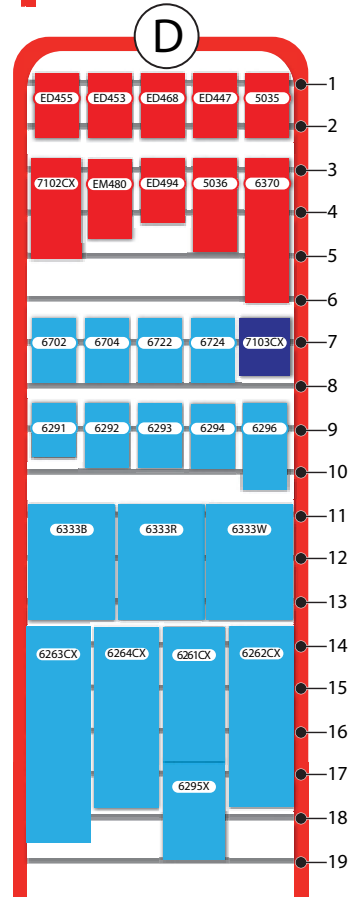

**MKT-POP-DEVCOMBO Merchandising Rack**  
72" x 22" x 20.5"

NOTE: Item numbers in **RED** indicate Made in the U.S.A.





## DEVCO RACKS MASTER ITEM LIST (BY RACK)

This DEVCO product list includes any DEVCO item that is part of the plan-o-gram display for either the EZC, ELEC or COMBO versions of the DEVCO rack. This cross reference indicates on which display rack each item should be placed.

ITEM #	ITEM DESCRIPTION	ELEC	EZC	COMBO
5002	Crimp Tool w/ Cutter & Stripper Ins.		X	X
5031	Test Leads (ins. Alligator clips) Low Voltage 22in 8pcs	X	X	
5033	Alligator Clips (steel) 2in long for probes .075in-.08in	X		
5035	Alligator Clips (copper) B&R Ins 2in long	X		X
5036	Test Clip (steel 20A) B&R Insulators 2-7/16in long	X		X
5041	Test Leads Low Voltage Hook Ty22ga 36in red & black	X		
5223	Triple Outlet 2 Pole 3 Wire 15A-125V Polarized plastic	X		
5381	Nylon Cable Clamp 1/8in I.D.		X	
5382	Nylon Cable Clamp 1/4in I.D.		X	X
5383	Nylon Cable Clamp 3/8in I.D.		X	
5384	Nylon Cable Clamp 1/2in I.D.		X	X
6900AX	Self-Drilling Screw Repair Kit		X	
6101	Motor Shaft Keys (1/8in 3/16in 1/4in 3/16in x 1/4in) zn Pltd.		X	
6102	Motor Shaft Keys (1/4insq 5/16insq 3/8insq) zn Pltd.		X	
6183	Terminal Block 20A-250V 6 pos			X
6185	Terminal Block 20A-250V 10 pos			X
6187	Terminal Block 20A-250V 14 pos			X
6211	Tab Ad. S. F Dbl M. .250 Non-Ins.			X
6212	Dbl. M. Tab Ad. . S. F . Non-Ins.			X
6216	Ring 16-14 Ins. #10 Stud			X
6218	Slip-on F 16-14 Ins. .250		X	X
6219	Slip-on M 16-14 Ins. .250		X	X
6224	Flag F QD 12-10 Non-Ins. .250		X	X
6229	Slip-on F 16-14 Full Ins. .250		X	
6235	Slip-on F 22-18 Ins. .250		X	X
6237	Spade 22-18 Ins. #8 Stud		X	X
6249	M Tab 1 pair bent 90 Non-Ins.			X
6251	Slip-on F 12-10 Ins. .250		X	X
6252	Ring 12-10 Ins. #10 Stud		X	X
6253	Ring 12-10 Ins. 1/4in Stud		X	X
6255	Spade 12-10 Ins. #10 Stud		X	X
6258	Comp. Flag F. 16-14 Non-Ins. .250		X	X
6259	Comp. Flag F. 12-10 Non-Ins. .250			X
6269	Cable Tie Mount		X	
6270	Comp. Flag F. 12-8 Non-Ins. .250		X	X
6272	Ring 16-14 Ins. #6 Stud			X
6274	Spade 16-14 Ins. #6 Stud		X	
6276	Spr. Spade 16-14 Ins. #6 Stud		X	X
6281	Slip-on F 16-14 Ins. .187		X	X
6282	Slip-on F 22-18 Ins. .187		X	
6291	Wire Connector Mini-Gray		X	X
6292	Wire Connector Tiny-Blue		X	X
6293	Wire Connector Small-Orange		X	X
6294	Wire Connector Medium-Yellow		X	X
6296	Wire Connector Large-Red		X	X
6298	Wire Connector XLarge-Gray		X	
6336	Thermostat Wire 3 Conduct.40 ft.	X		
6337	Thermostat Wire 5 Conduct.40 ft.	X		
6341	SJTO Service Cord 16 GA 20 ft.	X	X	
6343	SJTO Service Cord 14 GA 20 ft.	X	X	
6370	Heat Shrink Tubing Assort. B&W 1/8in & 1/4in supplied 6in	X		X
6413	Fin. Hex Nut 1/4in-20 zn Pltd.			X
6501	Fin. Hex Nut 1/4in-20 zn Pltd.		X	X
6503	Fin. Hex Nut 3/8in-16 zn Pltd.		X	X
6642	HH Cap Screw 3/8in-16 x 1in		X	
6643	HH Cap Screw 3/8in-16 x1 1/2in		X	
6701	Flat Washer 3/16in Uss zn Pltd.		X	
6702	Flat Washer 1/4in Uss zn Pltd.		X	X

ITEM #	ITEM DESCRIPTION	ELEC	EZC	COMBO
6703	Flat Washer 5/16in Uss zn Pltd.		X	
6704	Flat Washer 3/8in Uss zn Pltd.		X	X
6706	Flat Washer 1/2in Uss zn Pltd.		X	
6722	Fender Washer 1/4in zn Pltd.		X	X
6724	Fender Washer 3/8in zn Pltd.		X	X
7033	Toggle Bolt w/wing 3/16inx4inzn Pltd.		X	
7034	Toggle Bolt w/wing 1/4inx4in zn Pltd.		X	
60210	Tab Ad. Ins. .250 16-14 multi stack male & female		X	X
60251	Slip-On F 12-10 Non-Ins. .250		X	X
60259HX	Comp. Lead Kt 12in 10ga wire		X	X
60264CX	Cable Tie 6in w/ #8 Hole 30# 1-3/8in B. Dia nat 100/PK		X	
60265LX	Cable Tie 14in 50# 4in B. Dia natural 50 pcs		X	
61233LX	Slip-on M & F 16-14 .250 Full Ins Nylon 50 pcs		X	X
6211CX	Tab Ad. S. F Dbl M Non-Ins.100 pcs		X	X
6213CX	Flag F QD 16-14 Non-Ins. .250 100 pcs		X	X
6214CX	Slip-on F 16-14 Non-Ins. .250 100 pcs		X	X
6216LX	Ring 16-14 Ins. #10 Stud 50 pcs		X	X
6217CX	Butt Conn. 16-14 Ins. 100 pcs		X	X
6217LX	Butt Conn. 16-14 Ins. 50 pcs		X	X
6218LX	Slip-on F 16-14 Ins. .250 50 pcs		X	X
6222LX	Dead End Conn. 22-14 Fully Ins. 50 pcs		X	X
6223LX	Dead End Conn. 18-10 Fully Ins. 50 pcs		X	X
6227LX	Spade 16-14 Ins. #8 Stud		X	X
6228LX	Spade 16-14 Ins. #10 Stud 50 pcs		X	X
6229LX	Slip-on F 16-14 Full Ins. .250		X	X
6231LX	Butt Conn. 12-10 Ins. 50 pcs		X	X
6232LX	Butt Conn. 22-18 Ins. 50 pcs		X	X
6233LX	Slip-on F 16-14 .250 Full Ins. Nylon 50 pcs		X	X
6234LX	Slip-on M 16-14 .250 Full Ins. Nylon 50 pcs		X	X
6235LX	Slip-on F 22-18 Ins. .250 50 pcs		X	X
6236LX	Ring 22-18 Ins. #8 Stud 50 pcs		X	X
6239LX	Spr. Spade 16-14 Ins. #8 Stud		X	X
6251LX	Slip-on F 12-10 Ins. .250		X	X
6252LX	Ring 12-10 Ins. #10 Stud		X	X
6255LX	Spade 12-10 Ins. #10 Stud 50 pcs		X	X
6257NX	Ring #8 Ins. 1/4in Stud 25 pc		X	X
6258CX	Comp. Flag F. 16-14 Non-Ins. .250 100 pcs		X	X
6259CX	Comp. Flag F. 12-10 Non-Ins. .250 100 pcs		X	X
6261CX	Cable Tie 6in 18# 1-3/8in B. Dia natural 100 pcs		X	X
6262CX	Cable Tie 7-1/2in 50# 1-3/4in B. Dia natural 100 pcs		X	X
6263CX	Cable Tie 11in 50# 3in B. Dia natural 100 pcs		X	X
6263BCX	Cable Tie 11in 50# 3in B. Dia black 100 pcs		X	
6264CX	Cable Tie 7in w/ #10 Hole 50# 1-3/4in B. Dia nat 100/PK		X	X
6269LX	Cable Tie Mount 50 pcs		X	
6270LX	Comp. Flag F. 12-8 Non-Ins. .250 50 pcs		X	X
6277NX	Flag F QD 16-14 .250 Fully Ins. Nylon 25 pcs		X	X
6281LX	Slip-on F 16-14 Ins. .187 50 pcs		X	X
6289LX	Bullet Plug & Rec. 16-14 Ins. 50 pcs		X	X
6295X	Assorted Wire Connectors		X	X
6310X	Grease Fitting Assortment box		X	
6332B	Hook-up Wire 16ga blk. 48 ft	X		
6332R	Hook-up Wire 16ga red. 48 ft	X		
6332W	Hook-up Wire 16ga wht. 48 ft	X		
6333B	Hook-up Wire 14ga blk. 48 ft			X
6333G	Hook-up Wire 14ga grn. 48 ft			
6333R	Hook-up Wire 14ga red. 48 ft			X
6333W	Hook-up Wire 14ga wht. 48 ft			X
6334B	Hook-up Wire 12ga blk. 48 ft			X

continued

**DEVCO RACKS MASTER ITEM LIST (BY RACK) cont'd**

ITEM #	ITEM DESCRIPTION	ELEC	EZC	COMBO
6334R	Hook-up Wire 12ga red 48 ft	X		X
6334W	Hook-up Wire 12ga wht. 48 ft			X
6335B	Hook-up Wire 10ga blk. 48 ft	X		X
6335R	Hook-up Wire 10ga red 48 ft	X		X
6335W	Hook-up Wire 10ga wht. 48 ft	X		X
6500A	Asst Mach. Screw Hex Nuts 6-32 8-32 10-32 zn Pltd.			X
6503CX	Fin. Hex Nut 3/8in-16 zn Pltd. 100 pcs		X	
6700AX	Flat Washer Assortment Pack 3/16 1/4 5/16 3/8 1/2 5/8 inch		X	
6943CX	Self Drilling Screw #8x1/2in 1/4in Hex Head zn Pltd. 100/PK	X	X	
6945CX	Self Drilling Screw #8x3/4in 1/4in Hex Head zn Pltd. 100/PK	X	X	
6946CX	Self Drilling Screw #8x1in 1/4in Hex Head zn Pltd. 100/PK	X	X	
6953CX	Drill Tip Screw #10x1/2in 5/16in Hex Head 100/PK	X	X	
6955CX	Drill Tip Screw #10x3/4in 5/16in Hex Head 100/PK	X	X	
6956CX	Self Drilling Screw #10x1in 5/16in Hex Head zn Pltd. 100/PK	X	X	
7036X	Toggle Bolt w/wing 3/8inx4in zn Pltd.		X	
7101CX	Anch Kit Yellow #8x1in w 3/16in bit 100 s + 100 a		X	X
7102CX	Anch Kit Red #10x1-1/4in w 1/4in bit 100 s + 100 a		X	X
7103CX	Anch Kit Blue #4x3/4in w 5/32in bit 100 s + 100 a		X	X
7106CX	Plug Anchor Kit Green #10x1in 1/4in bit 100 s + 100 a bag		X	
7111CX	Plug Anchor Kit Blue #14x1in w 5/16in bit 100 s + 100 a bag		X	
DE13	Magnetic Hex Chuck 1/4in x 1-3/4in		X	
DE14	Magnetic Hex Chuck 5/16in x 1-3/4in		X	
DE15	Magnetic Hex Chuck 3/8in x 1-7/8 in		X	
DE23	Magnetic Hex Chuck 1/4in x 2-9/16 in		X	
ED1232	Toggle Switch D.P. 30A-120/277V brown			X
ED1238	Toggle Switch S.P. 20A-120/277V brown			X
ED1240-2	Toggle Switch S.P. 15A-120/277V brown	X		
ED1262-2	Toggle Switch D.P. 15A-120/277V brown			X
ED1301	Toggle Switch S.P. 15A-120V brown	X		X
ED1876	Single Receptacle 20A-250V 2 pl. 3 wr. brown	X		
ED1876-I	Single Receptacle 20A-250V 2 pl. 3 wr. ivory	X		
ED270	Duplex Receptacle 15A-125V 2 pl. 3 wr. brown			X
ED270-I	Duplex Receptacle 15A-125V 2 pl. 3 wr. ivory	X		
ED273CX	Electrical Staple insul size #5 5/8in x 1/4in 100/PK	X	X	
ED2867	Armored Plug 15A-125V 2pl. 3 wr. vinyl enclosed			X
ED2887	Armored Connector 15A-125V 2pl. 3 wr. vinyl enclosed			X
ED320	Vinyl Grommet Asst. contains: ED300 thru ED316	X	X	X
ED447	Bat Handle Switch metal SPST on-off 10A/277V-20A/125V AC	X	X	
ED453	Bat Handle Switch metal DPDT on-on 10A/277V-20A/125V AC	X	X	
ED454	Bat Handle Switch metal SPDT on-on 10A/277V-20A/125V AC	X		
ED455	Bat Handle Switch metal DPST on-off 10A/277V-20A/125V AC	X	X	
ED468	Bat Handle Switch metal SPDT on-off-on 10A/277V-20A/125V	X	X	
ED494	Bat Handle Switch metal DPDT on-off-on 10A/277V-20A/125V	X	X	
ED5225	Switch & Receptacle 2p 3w (sw:15A-120VAC& rec:15A-125VAC) brn	X		
ED600	Indicator Light 28V red PC lens incandescent bulb	X		
ED601	Indicator Light 28V green PC lens incandescent bulb	X		
ED602	Indicator Light 28V amber PC lens incandescent bulb	X		
ED610	Indicator Light 105-125V AC red nylon lens neon bulb	X		
ED611	Indicator Light 105-125V AC grn PC lensneon blb-G2B Imp&resstr	X		
ED877	Duplex Receptacle 20A-125V 2 pl. 3 wr. brown			X
EM480	In-Line Fuse Holder 1-1/4 x 1/4in fuses to 20A/32V 14ga	X	X	X
ED-AT3	Blade Fuses - 3 Amp - Purple, Pack of 10	X	X	X
ED-AT5	Blade Fuses - 5 Amp - Tan, Pack of 10	X	X	X
ED-CR15	Dual Element Fuses - 15 Amp, Pack of 2	X		X
ED-CR20	Dual Element Fuses - 20 Amp, Pack of 2	X		X
ED-CR25	Dual Element Fuses - 25 Amp, Pack of 2	X		X
ED-CR30	Dual Element Fuses - 30 Amp, Pack of 2	X	X	X
ED-CR35	Dual Element Fuses - 35 Amp, Pack of 2	X		X
ED-CR40	Dual Element Fuses - 40 Amp, Pack of 2	X		X
ED-CR45	Dual Element Fuses - 45 Amp, Pack of 2	X		X

ITEM #	ITEM DESCRIPTION	ELEC	EZC	COMBO
ED-CR50	Dual Element Fuses - 50 Amp, Pack of 2	X		X
ED-CR60	Dual Element Fuses - 60 Amp, Pack of 2	X	X	X
HC5410	Hose Clamp 9/16in-1-1/8in SShousing&band st hex screw		X	X
HC5416	Hose Clamp 3/4in-1-1/2in SShousing&band st hex screw		X	
HC6202	Hose Clamp 1/4in-5/8in SS housing&band st hex screw		X	X
HC6203	Hose Clamp 5/16in-7/8in SShousing&band st hex screw		X	X
PI301	Cond Nip 1/2in offset zn w pltd. stl locknuts insul. bushings			X
PI303	Cond Nip 1/2in strt galv steel w pltd. stl lock insul.			X
PI310	Reduc. Wash 3/4in to 1/2in Rsd Fin Galv St			X
PI312	BX Conct set screw 3/8in Tr. 1/2in KO. zn die cast			X
PI315	BX Connector 90 3/8inTr. 1/2in KO zn die cast	X	X	X
PI316	Knockout Seal for 1/2in KO zn Pltd. steel	X		
PI319	Romex Connector 3/4in Tr. 3/4in KO. zn Pltd. die cast	X		
PI320	Romex Connector 3/8in Tr. 1/2in KO. zn Pltd. die cast 25/PK	X	X	X
PI321	Romex Connector 3/8in Tr. 1/2 in KO. zn Pltd. die cast	X	X	X
PI322	BX Conct str saze 3/8in Tr. 1/2in KO. zn die cast	X		
PI328	Split Bolt Connector Cu use (6 max sol & 7 max strnd)			X
PI330	Romex Stop plastic 3/8inx1/2in for 2 cond. romex 12/2-14/2	X		
PI331	Plastic in Anti-Shortin Bush 14/2 14/3 & 12/2 BX cable	X		
PI340	Combo Cable Connector for romex & BX 3/8in Tr. 1/2in KO	X		
PI350	Metal LT Connec straight 1/2in Tr. 1/2in K.O	X		
PI351	Metal LT Connec straight 3/4in Tr. 3/4in K.O.	X		
PI352	Liquid Tight Connector 90 1/2in Tr. 1/2in K.O. zn die cast	X		
PI353	Liquid Tight Connector 90 3/4in Tr. 3/4in K.O. zn die cast	X		
PI360	Box galv. steel 4in x 2-1/8inx 1-7/8in 1/2in KO 13 in³	X		X
PI361	Box galv. steel 4in x 2-1/8inx 2-1/8in 1/2in KO 14.5 in³	X		X
PI362	1900 Box galv. steel 4X4X1-1/2 1/2&3/4 KO 21 in³	X		X
PI363	1900 Box galv. steel 4X4X2-1/8in 1/2&3/4 KO 30.3 in³	X		X
PI365	Utility Cover Toggle Switch 2-11/32in x 4-1/4in Pltd. steel	X		
PI368	1900 Cover Sw/Dup Rec cad fin. steel 4in x 4in raisd 1/2in	X		X
PI371	1900 Cover Blank Flat galv. steel	X		X
PI378	1900 Cover Duplex Recep cadil fin. steel 4X4 raisd 1/2in	X		
PI381	Fuse Outlet & Switch w cover 1/2HP-125V AC galv. steel			X
PI382	Weatherproof Cover Blank Al 1 Gang w gasket anodized	X		
PI385	Wthprf Box AL2-3/4inx4-1/2inx23 1/2in holes 2 plugs 19in³	X		
WM1002	Cable Marker Book alpha numer	X		
WM1003	Cable Marker Book numeric contains 10 each: 1 - 45	X	X	
WM1009	Cable Marker Book line & term	X		



## SLIP-ON SOLDERLESS TERMINALS

### Insulated Male Slip-Ons

These male terminals crimp to the wires which relieves the need to solder. A variety of sizes are available and the slip ons are fully insulated in either vinyl or nylon.



CATALOG NO.	DESCRIPTION	WIRE RANGE	TAB SIZE	UOM	ORDER MULTIPLE
<b>60219</b>	Insulated Male Slip-On, pack of 23	22-18	.250	PK	1
<b>60220</b>	Insulated Male Slip-On, pack of 23	16-14	.187	PK	1
<b>60220LX</b>	Insulated Male Slip-On, pack of 50	16-14	.187	PK	1
<b>6219</b>	Insulated Male Slip-On, pack of 22	16-14	.250	PK	1
<b>6219LX</b>	Insulated Male Slip-On, pack of 50	16-14	.250	PK	1
<b>61221LX</b>	Insulated Male Slip-On, pack of 50	12-10	.250	PK	1
<b>61221CX</b>	Insulated Male Slip-On, pack of 100	12-10	.250	PK	1

### Insulated Female Slip-Ons

These female terminals crimp to the wires which relieves the need to solder. A variety of sizes are available and the slip ons are fully insulated in either vinyl or nylon.



CATALOG NO.	DESCRIPTION	WIRE RANGE	TAB SIZE	UOM	ORDER MULTIPLE
<b>6282</b>	Insulated Female Slip-On, pack of 22	22-18	.187	PK	1
<b>6282LX</b>	Insulated Female Slip-On, pack of 50	22-18	.187	PK	1
<b>6235</b>	Insulated Female Slip-On, pack of 22	22-18	.250	PK	1
<b>6235LX</b>	Insulated Female Slip-On, pack of 50	22-18	.250	PK	1
<b>6235CX</b>	Insulated Female Slip-On, pack of 100	22-18	.250	PK	1
<b>6281</b>	Insulated Female Slip-On, pack of 22	16-14	.187	PK	1
<b>6281LX</b>	Insulated Female Slip-On, pack of 50	16-14	.187	PK	1
<b>6218</b>	Insulated Female Slip-On, pack of 22	16-14	.250	PK	1
<b>6218LX</b>	Insulated Female Slip-On, pack of 50	16-14	.250	PK	1
<b>6218CX</b>	Insulated Female Slip-On, pack of 100	16-14	.250	PK	1
<b>6251</b>	Insulated Female Slip-On, pack of 17	12-10	.250	PK	1
<b>6251LX</b>	Insulated Female Slip-On, pack of 50	12-10	.250	PK	1
<b>6251CX</b>	Insulated Female Slip-On, pack of 100	12-10	.250	PK	1
<b>61223LX</b>	Insulated Female Slip-On, pack of 50	12-10	.340	PK	1

### Fully Insulated Female Slip-Ons

These female terminals crimp to the wires which relieves the need to solder. A variety of sizes are available and the slip ons are fully insulated in either vinyl or nylon. This terminal features insulation grip. This terminal is usually supplied vinyl and has an insulation grip.



CATALOG NO.	DESCRIPTION	WIRE RANGE	TAB SIZE	UOM	ORDER MULTIPLE
<b>6229**</b>	Fully Insulated Female Slip-On, pack of 11	16-14	.250	PK	1
<b>6229LX**</b>	Fully Insulated Female Slip-On, pack of 50	16-14	.250	PK	1
<b>6233</b>	Fully Insulated Female Slip-On, pack of 14	16-14	.250	PK	1
<b>6233LX</b>	Fully Insulated Female Slip-On, pack of 50	16-14	.250	PK	1
<b>61234LX</b>	Fully Insulated Female Slip-On, pack of 50	12-10	.250	PK	1

\*This terminal features insulation grip.

\*\*This terminal is usually supplied vinyl and has an insulation grip.

### Non-Insulated Male Slip-Ons

These non insulated male terminals crimp to the wires which relieves the need to solder. A variety of sizes are available



CATALOG NO.	DESCRIPTION	WIRE RANGE	TAB SIZE	UOM	ORDER MULTIPLE
<b>6220</b>	Non-Insulated Male Slip-On, pack of 38	16-14	.250	PK	1
<b>6220CX</b>	Non-Insulated Male Slip-On, pack of 100	16-14	.250	PK	1
<b>61220</b>	Non-Insulated Male Slip-On, pack of 37	16-14	.250	PK	1

### Non-Insulated Female Slip-Ons

These non insulated female terminals crimp to the wires which relieves the need to solder. A variety of sizes are available. This terminal features insulation grip.



CATALOG NO.	DESCRIPTION	WIRE RANGE	TAB SIZE	UOM	ORDER MULTIPLE
<b>6214</b>	Non-Insulated Female Slip-On, pack of 35	16-14	.250	PK	1
<b>6214CX</b>	Non-Insulated Female Slip-On, pack of 100	16-14	.250	PK	1
<b>60251</b>	Non-Insulated Female Slip-On, pack of 26	12-10	.250	PK	1
<b>60251CX</b>	Non-Insulated Female Slip-On, pack of 100	12-10	.250	PK	1

\*This terminal features insulation grip.

### Fully Insulated Male Slip-Ons

These male terminals crimp to the wires which relieves the need to solder. A variety of sizes are available and the slip ons are fully insulated in either vinyl or nylon.



CATALOG NO.	DESCRIPTION	WIRE RANGE	TAB SIZE	UOM	ORDER MULTIPLE
<b>6234</b>	Fully Insulated Male Slip-On, pack of 14	16-14	.250	PK	1
<b>6234LX</b>	Fully Insulated Male Slip-On, pack of 50	16-14	.250	PK	1
<b>61235LX</b>	Fully Insulated Male Slip-On, pack of 50	12-10	.250	PK	1

### Non-Insulated Flag Female Slip-Ons

These non insulated female terminals crimp to the wires which relieves the need to solder. A variety of sizes are available. Part 6213 features insulation grip.



CATALOG NO.	DESCRIPTION	WIRE RANGE	TAB SIZE	UOM	ORDER MULTIPLE
<b>6213</b>	Non-Insulated Flag Female Slip-On, pack of 34	16-14	.250	PK	1
<b>6213CX</b>	Non-Insulated Flag Female Slip-On, pack of 100	16-14	.250	PK	1
<b>6224</b>	Non-Insulated Flag Female Slip-On, pack of 20	12-10	.250	PK	1
<b>6224CX</b>	Non-Insulated Flag Female Slip-On, pack of 100	12-10	.250	PK	1





**SLIP-ON SOLDERLESS TERMINALS cont'd**

**Fully Insulated Flag Female Slip-Ons**

These female terminals crimp to the wires which relieves the need to solder. A variety of sizes are available and the slip ons are fully insulated in either vinyl or nylon.



CATALOG NO.	DESCRIPTION	WIRE RANGE	TAB SIZE	UOM	ORDER MULTIPLE
6277	Fully Insulated Flag Female Slip-On, pack of 9	16-14	.250	PK	1
6277NX	Fully Insulated Flag Female Slip-On, pack of 25	16-14	.250	PK	1

**Combination Pack: Set of 6233 and 6234**

Our Combination pack holds both a Fully Insulated Male and Female Slip On.



CATALOG NO.	DESCRIPTION	WIRE RANGE	TAB SIZE	UOM	ORDER MULTIPLE
61233LX	Set of Fully Insulated M/F Slip-Ons, pack of 25 pairs	16-14	.250	PK	1

**Flag Female Compressor Terminal Kit**

Parts 6258, 6271, 6259, 6273, 6270 in a four compartment, clear plastic box. Parts 6270 and 6273 are put in the same compartment.



CATALOG NO.	DESCRIPTION	UOM	ORDER MULTIPLE
6200HX	Flag Female Compressor Terminal Kit	EA	1

**Flag Female Compressor Terminals**

Also known as hermetic header terminals, these non-insulated terminals are designed with a larger distance between the "rolls" to allow for the rod in hermetic header applications. The increased distance allows the rod to slip in between them. Parts 6258 and 6259 are notched for bending. The notches are cut between the slip-on portion and the conductor barrel and enable the back of the slip-on portion to be folded against the conductor barrel after the wire connection is made. This terminal features insulation grip.



CATALOG NO.	DESCRIPTION	WIRE RANGE	FITS	UOM	ORDER MULTIPLE
6270	Flag Female Compressor Terminal, pack of 9	12-8	.250 tab	PK	1
6270LX	Flag Female Compressor Terminal, pack of 50	12-8	.250 tab	PK	1
6258*	Flag Female Compressor Terminal, pack of 17	16-14	.250 tab	PK	1
6258CX*	Flag Female Compressor Terminal, pack of 100	16-14	.250 tab	PK	1
6259	Flag Female Compressor Terminal, pack of 14	12-10	.250 tab	PK	1
6259CX	Flag Female Compressor Terminal, pack of 100	12-10	.250 tab	PK	1

\*This terminal features insulation grip.

**Compressor Lead Kit**

Our Compressor Lead kit includes the following products: a flag female compressor terminal (.250 tab; part 62589), a waterproof butt connector (12 10 wire range; part 62231), and a piece of 10 gauge wire.



CATALOG NO.	DESCRIPTION	UOM	ORDER MULTIPLE
60259HX	Compressor Lead Kit with 12" wire	EA	1

**SPECIAL PURPOSE SOLDERLESS TERMINALS**

**Insulated Plugs**

These insulated terminals crimp to the wires which relieves the need to solder.



CATALOG NO.	DESCRIPTION	WIRE RANGE	UOM	ORDER MULTIPLE
6283LX	Insulated Plugs, pack of 50	22-18	PK	1
6285	Insulated Plugs, pack of 17	16-14	PK	1
6285LX	Insulated Plugs, pack of 50	16-14	PK	1

**Combination Packs**

These insulated terminals crimp to the wires which relieves the need to solder.



CATALOG NO.	DESCRIPTION	UOM	ORDER MULTIPLE
6288	Combination Pack with parts 6283 and 6284, pack of 7 pairs	PK	1
6288LX	Combination Pack with parts 6283 and 6284, pack of 25 pairs	PK	1
6289	Combination Pack with parts 6285 and 6286, pack of 7 pairs	PK	1
6289LX	Combination Pack with parts 6285 and 6286, pack of 25 pairs	PK	1

**Fully Insulated Receptacles**

These insulated terminals crimp to the wires which relieves the need to solder.



CATALOG NO.	DESCRIPTION	WIRE RANGE	UOM	ORDER MULTIPLE
6286	Fully Insulated Receptacles, pack of 12	16-14	PK	1

## SPECIAL PURPOSE SOLDERLESS TERMINALS cont'd

### Tab Adapters – Quick Disconnect with Screw

These insulated terminals crimp to the wires which relieves the need to solder.



CATALOG NO.	DESCRIPTION	UOM	ORDER MULTIPLE
6209	Fits .250 Tab, #6-32 x 1/4" Screw, pack of 5	PK	1
6209LX	Fits .250 Tab, #6-32 x 1/4" Screw, pack of 50	PK	1

### Tab Adapters – Piggy Back Slip-Ons

These insulated terminals crimp to the wires which relieves the need to solder. Multi-stack, .250 male tab, .250 female slip-on.



CATALOG NO.	DESCRIPTION	WIRE RANGE	UOM	ORDER MULTIPLE
6210	Non-Insulated Piggy Back Slip-Ons, pack of 20	16-14	PK	1
60210	Insulated Piggy Back Slip-Ons, pack of 11	16-14	PK	1
60210LX	Insulated Piggy Back Slip-Ons, pack of 50	16-14	PK	1
60210CX	Insulated Piggy Back Slip-Ons, pack of 100	16-14	PK	1

### Tab Adapters – Single Female Double Male Tabs

These insulated terminals crimp to the wires which relieves the need to solder. .250 male, .250 female.



CATALOG NO.	DESCRIPTION	TAB SIZE	UOM	ORDER MULTIPLE
6208	Tab Adapter; 1 female, 2 male; Bent 90°, pack of 12	.250	PK	1
6208LX	Tab Adapter; 1 female, 2 male; Bent 90°, pack of 50	.250	PK	1
6211	Tab Adapter; 1 female, 2 male; Wye, pack of 27	.250	PK	1
6211CX	Tab Adapter; 1 female, 2 male; Wye, pack of 100	.250	PK	1
6212	Tab Adapter; 1 female, 2 male; Stacked, pack of 16	.250	PK	1
6212CX	Tab Adapter; 1 female, 2 male; Stacked, pack of 100	.250	PK	1

### Tab Adapters – Male Tabs

These insulated terminals crimp to the wires which relieves the need to solder.



CATALOG NO.	DESCRIPTION	TAB SIZE	STUD	UOM	ORDER MULTIPLE
6230	Male Tabs – Straight, pack of 28	.250	#8	PK	1
6230CX	Male Tabs – Straight, pack of 100	.250	#8	PK	1

### Tap Connectors

These insulated terminals crimp to the wires which relieves the need to solder. Designed to make tap splices.



CATALOG NO.	DESCRIPTION	WIRE RANGE	UOM	ORDER MULTIPLE
6241	Tap Splice – blue, pack of 15	16-14	PK	1

### Fully Insulated Dead End Connectors

These insulated terminals crimp to the wires which relieves the need to solder.



CATALOG NO.	DESCRIPTION	WIRE RANGE	UOM	ORDER MULTIPLE
6222	Fully Insulated Dead End Connectors, pack of 27	22-14	PK	1
6222LX	Fully Insulated Dead End Connectors, pack of 50	22-14	PK	1
6223	Fully Insulated Dead End Connectors, pack of 21	18-10	PK	1
6223LX	Fully Insulated Dead End Connectors, pack of 50	18-10	PK	1

## STANDARD SOLDERLESS TERMINALS

### Insulated Hooks

These insulated terminals crimp to the wires which relieves the need to solder.



CATALOG NO.	DESCRIPTION	WIRE RANGE	STUD	UOM	ORDER MULTIPLE
6242	Insulated Hooks, pack of 22	22-18	#8	PK	1
6242LX	Insulated Hooks, pack of 50	22-18	#8	PK	1
6244	Insulated Hooks, pack of 20	16-14	#8	PK	1
6244LX	Insulated Hooks, pack of 50	16-14	#8	PK	1

### Insulated Butt Connectors

These insulated terminals crimp to the wires which relieves the need to solder.



CATALOG NO.	DESCRIPTION	WIRE RANGE	UOM	ORDER MULTIPLE
6232	Insulated Butt Connector, pack of 26	22-18	PK	1
6232LX	Insulated Butt Connector, pack of 50	22-18	PK	1
6232CX	Insulated Butt Connector, pack of 100	22-18	PK	1
6217	Insulated Butt Connector, pack of 27	16-14	PK	1
6217LX	Insulated Butt Connector, pack of 50	16-14	PK	1
6217CX	Insulated Butt Connector, pack of 100	16-14	PK	1
6231	Insulated Butt Connector, pack of 16	12-10	PK	1
6231LX	Insulated Butt Connector, pack of 50	12-10	PK	1
6231CX	Insulated Butt Connector, pack of 100	12-10	PK	1
6287XX	Insulated Butt Connector, pack of 10	8	PK	1
6287CX	Insulated Butt Connector, pack of 100	8	PK	1





## STANDARD SOLDERLESS TERMINALS *cont'd*

### Butt Connector Assortment Kit

This Assortment is a perfect addition to the HVAC kit. It includes an Insulated Butt Connector, a Non Insulated Butt Connector, and a Nylon Insulated Butt Connector. Includes parts 6217, 6231, and 6232.



CATALOG NO.	DESCRIPTION	UOM	ORDER MULTIPLE
6200BSX	Butt Connector Assortment Kit	EA	1

### Insulated Spades

These insulated terminals crimp to the wires which relieves the need to solder.



CATALOG NO.	DESCRIPTION	WIRE RANGE	STUD	UOM	ORDER MULTIPLE
61214	Insulated Spades, pack of 23	22-18	#6	PK	1
6237	Insulated Spades, pack of 22	22-18	#8	PK	1
6237LX	Insulated Spades, pack of 50	22-18	#8	PK	1
61256LX	Insulated Spades, pack of 50	22-18	#10	PK	1
6274	Insulated Spades, pack of 22	16-14	#6	PK	1
6274LX	Insulated Spades, pack of 50	16-14	#6	PK	1
6227	Insulated Spades, pack of 22	16-14	#8	PK	1
6227LX	Insulated Spades, pack of 50	16-14	#8	PK	1
6228	Insulated Spades, pack of 22	16-14	#10	PK	1
6228LX	Insulated Spades, pack of 50	16-14	#10	PK	1
60254	Insulated Spades, pack of 18	12-10	#8	PK	1
60254LX	Insulated Spades, pack of 50	12-10	#8	PK	1
60254CX	Insulated Spades, pack of 100	12-10	#8	PK	1
6255	Insulated Spades, pack of 17	12-10	#10	PK	1
6255LX	Insulated Spades, pack of 50	12-10	#10	PK	1
6255CX	Insulated Spades, pack of 100	12-10	#10	PK	1

### Non-Insulated Rings

These non insulated terminals crimp to the wires which relieves the need to solder.



CATALOG NO.	DESCRIPTION	WIRE RANGE	STUD	UOM	ORDER MULTIPLE
6215	Non-Insulated Rings, pack of 27	16-14	#8	PK	1

### Non-Insulated Spades

These non insulated terminals crimp to the wires which relieves the need to solder.



CATALOG NO.	DESCRIPTION	WIRE RANGE	STUD	UOM	ORDER MULTIPLE
6226CX	Non-Insulated Spades, pack of 100	16-14	#10	PK	1

### Insulated Spring Spades

These insulated terminals crimp to the wires which relieves the need to solder.



CATALOG NO.	DESCRIPTION	WIRE RANGE	STUD	UOM	ORDER MULTIPLE
6238	Insulated Spring Spades, pack of 22	22-18	#8	PK	1
6238LX	Insulated Spring Spades, pack of 50	22-18	#8	PK	1
6276	Insulated Spring Spades, pack of 21	16-14	#6	PK	1
6276LX	Insulated Spring Spades, pack of 50	16-14	#6	PK	1
6239	Insulated Spring Spades, pack of 22	16-14	#8	PK	1
6239LX	Insulated Spring Spades, pack of 50	16-14	#8	PK	1
60256CX	Insulated Spring Spades, pack of 100	12-10	#8	PK	1

### Insulated Rings

These insulated terminals crimp to the wires which relieves the need to solder.



CATALOG NO.	DESCRIPTION	WIRE RANGE	STUD	UOM	ORDER MULTIPLE
61202	Insulated Rings, pack of 22	22-18	#6	PK	1
6236LX	Insulated Rings, pack of 50	22-18	#8	PK	1
6272	Insulated Rings, pack of 22	16-14	#6	PK	1
6216	Insulated Rings, pack of 23	16-14	#10	PK	1
6216LX	Insulated Rings, pack of 50	16-14	#10	PK	1
6216CX	Insulated Rings, pack of 100	16-14	#10	PK	1
60247	Insulated Rings, pack of 17	12-10	#6	PK	1
60252CX	Insulated Rings, pack of 100	12-10	#8	PK	1
6252	Insulated Rings, pack of 17	12-10	#10	PK	1
6252LX	Insulated Rings, pack of 50	12-10	#10	PK	1
6253LX	Insulated Rings, pack of 50	12-10	1/4"	PK	1
6253CX	Insulated Rings, pack of 100	12-10	1/4"	PK	1
6257	Insulated Rings, pack of 6	8	1/4"	PK	1
6257NX	Insulated Rings, pack of 25	8	1/4"	PK	1
61252NX	Insulated Rings, pack of 25	6	5/16"	PK	1

## HIGH TEMPERATURE SOLDERLESS TERMINALS

### High Temperature Male Slip-Ons

The High Temperature Male Slip Ons are constructed of nickel plated steel. These non insulated terminals are rated at 900 degree F (482 degree C).



4220

CATALOG NO.	DESCRIPTION	WIRE RANGE	TAB SIZE	UOM	ORDER MULTIPLE
4220	High Temp. Male Slip-Ons, pack of 21	16-14	.250	PK	1
4220CX	High Temp. Male Slip-Ons, pack of 100	16-14	.250	PK	1

### High Temperature Flag Female Slip-Ons

The High Temperature Flag Female Slip Ons are constructed of nickel plated steel. These non insulated terminals are rated at 900 degree F (482 degree C).



4213

CATALOG NO.	DESCRIPTION	WIRE RANGE	TAB SIZE	UOM	ORDER MULTIPLE
4213	High Temp. Flag Female Slip-Ons, pack of 16	16-14	.250	PK	1
4213CX	High Temp. Flag Female Slip-Ons, pack of 100	16-14	.250	PK	1
4224	High Temp. Flag Female Slip-Ons, pack of 11	12-10	.250	PK	1
4224NX	High Temp. Flag Female Slip-Ons, pack of 25	12-10	.250	PK	1
4224CX	High Temp. Flag Female Slip-Ons, pack of 100	12-10	.250	PK	1

### High Temperature Rings

The High Temperature Rings are constructed of nickel plated steel. These non insulated terminals are rated at 900 degree F (482 degree C).



4252

CATALOG NO.	DESCRIPTION	WIRE RANGE	STUD	UOM	ORDER MULTIPLE
4215	High Temp. Rings, pack of 21	16-14	#10	PK	1
4215CX	High Temp. Rings, pack of 100	16-14	#10	PK	1
4205CX	High Temp. Rings, pack of 100	16-14	1/4"	PK	1
4252	High Temp. Rings, pack of 14	12-10	#10	PK	1
4252CX	High Temp. Rings, pack of 100	12-10	#10	PK	1
4253	High Temp. Rings, pack of 14	12-10	1/4"	PK	1
4253CX	High Temp. Rings, pack of 100	12-10	1/4"	PK	1

### High Temperature Female Slip-Ons

The High Temperature Female Slip Ons are constructed of nickel plated steel. These non insulated terminals are rated at 900 degree F (482 degree C).



4221

CATALOG NO.	DESCRIPTION	WIRE RANGE	TAB SIZE	UOM	ORDER MULTIPLE
4221	High Temp. Female Slip-Ons, pack of 20	16-14	.187	PK	1
4221CX	High Temp. Female Slip-Ons, pack of 100	16-14	.187	PK	1
4214	High Temp. Female Slip-Ons, pack of 21	16-14	.250	PK	1
4214CX	High Temp. Female Slip-Ons, pack of 100	16-14	.250	PK	1
4204	High Temp. Female Slip-Ons, pack of 17	12-10	.250	PK	1
4204CX	High Temp. Female Slip-Ons, pack of 100	12-10	.250	PK	1

### High Temperature Spades

The High Temperature Spades Slip Ons are constructed of nickel plated steel. These non insulated terminals are rated at 900 degree F (482 degree C).



4226

CATALOG NO.	DESCRIPTION	WIRE RANGE	STUD	UOM	ORDER MULTIPLE
4226	High Temp. Spades, pack of 23	16-14	#10	PK	1
4226CX	High Temp. Spades, pack of 100	16-14	#10	PK	1
4254CX	High Temp. Spades, pack of 100	12-10	#10	PK	1

### High Temperature Butt Connectors

The High Temperature Butt Connectors are constructed of nickel plated steel. These non insulated terminals are rated at 900 degree F (482 degree C).



4231

CATALOG NO.	DESCRIPTION	WIRE RANGE	UOM	ORDER MULTIPLE
4231	High Temp. Butt Connectors, pack of 17	12-10	PK	1

### High Temperature Assortment

The High Temperature Assortment Pack holds terminals that are constructed of nickel plated steel. These non insulated terminals are rated at 900 degree F (482 degree C). Includes parts 4213, 4215, and 4204, and 4254.



4200AX

CATALOG NO.	DESCRIPTION	UOM	ORDER MULTIPLE
4200AX	High Temp. Assortment	EA	1

# DEVCO TERMINAL KITS



CATALOG NO.	DESCRIPTION	TERMINALS																
	<p><b>NOTE:</b> Some kits have parts not shown in chart. Please refer to the DESCRIPTION for these parts. Except where noted, kits come in clear plastic boxes.</p>			<b>HIGH TEMP</b>														
<b>6200HX</b>	<b>Flag Female Compressor Terminal Kit:</b> 8-18 wire range in a 4-compartment box with parts 6270 and 6273 in the same compartment.												6258	6259	6270 6271 6273			
<b>6200MX</b> <b>6200MSX*</b>	.187, .250 tabs; 12-10 wire range; #8, #10 studs in a 13-compartment polypropylene box.	6217 6231 6232	6218 6235 6251 6281		6216 6252				6213					6259			6211	
<b>6201MX</b>	.187, .250 tabs; 22-10 wire range; #8, #10 studs in a 21-compartment metal box. (Includes parts 6233, 6234, and 6277, not shown in chart).	6217 6231 6232	6218 6235 6251 6281 6282		6216 6236 6252	6228	6238 6239		6224				6258	6259			6211	
<b>6202MX</b>	<b>Insulated Terminal Kit:</b> .187, .250 tabs; 22-10 wire range; #8, #10, #6, 1/4" studs in an 18-compartment box. Parts 6233 & 6234, and parts 6222 & 6223 are pairs (not shown in chart).	6217 6231 6232	6218 6235 6251 6281 6282		6216 6252 6253 6272 60246	60254	6238 6239											
<b>6203MX</b>	<b>Non-Insulated Terminal Kit:</b> Includes High Temp. Terminals and Flag Female Compressor Terminals. .250 tab; 22-10 wire range; #8, #10 studs in an 18-compartment box. (Includes parts 6209 and 6210, not shown in chart).			4204 4213 4214 4215 4252 4254				6214	6213	6224			6258	6259	6270 6271	6230	6208	6211
<b>4200AX</b>	<b>High Temperature Terminal Kit:</b> .250 tab; 16-10 wire; #10 stud in a bag.			4204 4213 4215 4254														
<b>6200X</b>	.250 tab; 16-14 wire; #8 stud in a 6-compartment box.	6217						6214	6213		6215					6230		6211
<b>6200AX</b>	.250 tab; 16-14 wire range; #8, #10 studs in a 6-compartment box.	6217	6218		6216				6213							6230		6211
<b>6200BSX</b>	22-10 wire range in a bag.	6217 6231 6232																
<b>6200CX</b>	.250 tab; 16-14 wire; #10 stud in a 4-compartment box.		6218		6216				6213									6211

\*Contains a crimper.

**ANCHORS**

**Metal Drive Anchors**

The anchors offer a Quick and Easy Solution for Light Duty Anchoring Jobs in Concrete and Masonry and Easy through type fastening, even when used in bottomless holes



CATALOG NO.	DESCRIPTION	SIZE	EMBEDMENT	PULLOUT LOAD	UOM	ORDER MULTIPLE
<b>7233RLX</b>	Drive Anchor, pack of 50	1/4" X 3/4"	5/8"	500 lb.	PK	1
<b>7234RLX</b>	Drive Anchor, pack of 50	1/4" X 1"	7/8"	944 lb.	PK	1
<b>7235RLX</b>	Drive Anchor, pack of 50	1/4" X 1-1/4"	1-1/8"	1,146 lb.	PK	1
<b>7236RLX</b>	Drive Anchor, pack of 50	1/4" X 1-1/2"	1-3/8"	854 lb.	PK	1

**Drop-In Expansion Anchor Setting Tool**

This tool is great for use while setting an anchor.



CATALOG NO.	DESCRIPTION	UOM	ORDER MULTIPLE
<b>7146</b>	For use with anchor part number 7142	EA	1

**Self-Drilling Gypsum Wallboard Anchors**

These anchors pre drill precise holes in gypsum wallboard with no special tools required. The anchors are easily installed with a #2 or #3 Phillips screwdriver, slotted driver, or power driver. Plastic plugs toggles and toggles are easily replaced with the deep threaded products. There is a full range to cover all wall fastening applications and are available in corrosion resistant and non conductive white nylon. The product has a low profile head and can easily be backed out. They provide and strong engagement in 3/4in., 1/2in., and 5/8in. gypsum wallboard and are supplied with combo head screws.



CATALOG NO.	DESCRIPTION	SCREW SIZE	MAX. FIXTURE	UOM	ORDER MULTIPLE
<b>7316X</b>	E-Z Ancor®; nylon, pack of 10	#8 x 1-1/4"	3/4"	PK	1
<b>7316L</b>	E-Z Ancor®; nylon, pack of 50	#8 x 1-1/4"	3/4"	PK	1
<b>7311L</b>	E-Z Ancor®; zinc die cast*, pack of 50	#6 x 1-1/4"	3/4"	PK	1
<b>7317X</b>	E-Z Ancor Lite™; nylon, pack of 10	#6 x 1-1/4"	3/4"	PK	1
<b>7317L</b>	E-Z Ancor Lite™; nylon, pack of 50	#6 x 1-1/4"	3/4"	PK	1
<b>7321X</b>	E-Z Toggle™; zinc die cast; heavy-duty, pack of 10	#8 x 2-1/8"	5/8"	PK	1

\*Smaller version of the E-Z Ancor® with a versatile core that can use #6 or #8 sheet metal screws or #6, #7, #8 drywall screws.

**Drive Fasteners**

These steel fasteners can be driven into dry wall like a nail and are secured by turning the screw down completely to expand the ribs.



CATALOG NO.	DESCRIPTION	HOLE SIZE	GRIP RANGE	UOM	ORDER MULTIPLE
<b>7301</b>	Drive Fastener, pack of 6	1/4"	3/16" to 3/8"	PK	1
<b>7302</b>	Drive Fastener, pack of 6	1/4"	1/8" to 1/2"	PK	1
<b>7303</b>	Drive Fastener, pack of 6	1/4"	1/8" to 3/16"	PK	1



























**Drop-In Expansion Anchors**

These heavy duty anchors are made of carbon steel. They are set by means of an internal plug and setting tool.



CATALOG NO.	DESCRIPTION	BOLT SIZE	THREADS PER INCH	HOLE DEPTH	THREAD DEPTH	DRILL BIT SIZE	UOM	ORDER MULTIPLE
<b>7142</b>	Anchor, pack of 4	3/8"	18	1-5/8"	1/2"	1/2"	PK	1
<b>7142LX</b>	Anchor, pack of 50	3/8"	18	1-5/8"	1/2"	1/2"	PK	1

# DEVCO PLASTIC ANCHOR KITS

CATALOG NO.		ANCHOR	DRILL SIZE	DRILL BIT INCLUDED	SCREW	SCREW SIZE
SMALL PACK*	100 PACK					
	<b>7103CX</b>		<u>5/32</u> 			<b>#4 x 3/4"</b>
	<b>7101CX</b>		<u>3/16</u> 			<b>#8 x 1"</b>
	<b>7101HCX</b>					<b>#8 x 1"</b>
	<b>7102CX</b>		<u>1/4</u> 			<b>#10 x 1-1/4"</b>
	<b>7102HCX</b>					<b>#10 x 1"</b>
	<b>7106CX</b>		<u>1/4</u> 			<b>#10 x 1"</b>
<b>7105LX</b>			<u>5/16</u> 			<b>#14 x 1-1/2"</b>
<b>7111X</b>	<b>7111CX</b>		<u>5/16</u> 			<b>#14 x 1"</b>

*SMALL PACK	COUNT
7106	28
7111X	40
7105LX	50



**BOXES, RINGS, AND COVERS**

**Steel Utility Boxes\***

Steel Utility Boxes are used for convenience outlets, switch boxes and small junction boxes. Galvanized steel.



CATALOG NO.	LENGTH	WIDTH	DEPTH	CAPACITY (cubic in.)	KNOCKOUT (in.)	UOM	ORDER MULTIPLE
<b>PI360</b>	4"	2-1/8"	1-7/8"	13.0	1/2	EA	1
<b>PI361</b>	4"	2-1/8"	2-1/8"	14.5	1/2	EA	1

**Steel 1900 Boxes\***

Steel Utility Boxes are used for convenience outlets, switch boxes and small junction boxes. Galvanized steel.



CATALOG NO.	LENGTH	WIDTH	DEPTH	CAPACITY (cubic in.)	KNOCKOUT (in.)	UOM	ORDER MULTIPLE
<b>PI362</b>	4"	4"	1-1/2"	21.0	3/4 & 1/2	EA	1
<b>PI363</b>	4"	4"	2-1/8"	30.3	3/4 & 1/2	EA	1

**Steel Octagon Box\***

Steel Utility Boxes are used for convenience outlets, switch boxes and small junction boxes. Galvanized steel.



CATALOG NO.	LENGTH	WIDTH	DEPTH	CAPACITY (cubic in.)	KNOCKOUT (in.)	UOM	ORDER MULTIPLE
<b>PI364</b>	4"	4"	1-1/2"	15.5	3/4 & 1/2	EA	1

**Extension Rings\***

Extension rings are used when extra cubic inch capacity is needed for additional wiring. Galvanized steel.



CATALOG NO.	LENGTH	WIDTH	DEPTH	CAPACITY (cubic in.)	KNOCKOUT (in.)	UOM	ORDER MULTIPLE
<b>PI390</b>	4"	2-1/8"	1-7/8"	13.0	1/2	EA	1
<b>PI391</b>	4"	4"	1-1/2"	21.0	3/4 & 1/2	EA	1

**Device Rings\***

Device rings are designed for projects of preexisting locations. They can help narrow an opening for a box in the sheet rock. They are also known as Plaster Rings. Galvanized steel.



CATALOG NO.	DESCRIPTION	NUMBER DEVICES	RAISED	UOM	ORDER MULTIPLE
<b>PI387</b>	1900 Device Ring	1	1/2"	EA	1

**Plated Steel Utility Covers\***

Ideal for exposed work applications, providing an easy method for the installation of electrical devices (switches, receptacles, fans, lights, etc.)



CATALOG NO.	DESCRIPTION	WIDTH	LENGTH	UOM	ORDER MULTIPLE
<b>PI365</b>	Toggle Switch	2-11/32"	4-1/4"	EA	1
<b>PI366</b>	Duplex Receptacle	2-11/32"	4-1/4"	EA	1
<b>PI367</b>	Blank Cover	2-11/32"	4-1/4"	EA	1
<b>PI375</b>	Standard Single Receptacle	2-11/32"	4-1/4"	EA	1

**Utility Covers\***

These covers are 4 1/4in. x 2 11/32in. and are designed for appliances or emergency oil burners.



CATALOG NO.	DESCRIPTION	UOM	ORDER MULTIPLE
<b>PI383</b>	Appliance Switch, .4687" dia. hole, baked cadillite finish	EA	1
<b>PI374</b>	Red finish, "Emergency Gas Burner" in white letters	EA	1

**Utility Plates\***

These plates are 4 1/4in. x 2 11/32in. and are designed for emergency oil burners.



CATALOG NO.	DESCRIPTION	UOM	ORDER MULTIPLE
<b>PI393</b>	Red finish, "Emergency Oil Burner" in white letters	EA	1
<b>PI394</b>	Red finish, "Emergency Gas Burner" in white letters	EA	1

\*Items in this section are Underwriter's Laboratories listed or recognized under the prime manufacturer's name.





**BOXES, RINGS, AND COVERS cont'd**

**Steel 1900 Covers\***

The covers are baked in a cadillite finished steel and are raised 1/2in. with fully depressed corners. Size: 4" x 4".



CATALOG NO.	DESCRIPTION	UOM	ORDER MULTIPLE
PI377	Single Toggle	EA	1
PI378	Single Duplex Receptacle	EA	1
PI379	One Standard Single Receptacle	EA	1
PI368	Toggle Switch and Duplex Receptacle	EA	1
PI370	Toggle Switch and Standard Single Receptacle	EA	1
PI371	Flat, Blank, Galvanized steel (not Cadillite finished)	EA	1

**Weatherproof Covers\***

These covers can be used with item PI385 and come with gaskets.

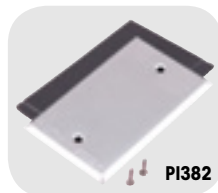

CATALOG NO.	DESCRIPTION	UOM	ORDER MULTIPLE
PI382	Blank Cover	EA	1
PI386	Lever Switch Cover for standard toggle type switches	EA	1
PI389	Duplex Receptacle Cover	EA	1
PI389-GFI	GFI Receptacle Cover	EA	1

**Weatherproof Boxes\***

Heavy duty die cast aluminum with baked aluminum finish. Boxes have two closure plugs and three holes. Item is Underwriter's Laboratories listed or recognized under the prime manufacturer's name.



CATALOG NO.	LENGTH	WIDTH	DEPTH	CAPACITY (cubic in.)	HOLE SIZE (in.)	UOM	ORDER MULTIPLE
PI385	4-1/2"	2-3/4"	2"	19.0	1/2	EA	1
PI385-34	4-1/2"	2-3/4"	2"	19.0	3/4	EA	1

**Weatherproof Box with Lever Switch Cover\***

The box is heavy duty die cast aluminum with baked aluminum finish and has two closure plugs and three holes. The cover comes with the gaskets. Includes parts PI385 and PI386.



CATALOG NO.	DESCRIPTION	UOM	ORDER MULTIPLE
PI384	Weatherproof Box and Lever Switch Cover	EA	1

**Safety Plates\***

Safety plates, also called nail in plates, or nail plates, install quickly and protect wire, cable and pipes that may be installed in upright wood stud walls.



CATALOG NO.	DESCRIPTION	UOM	ORDER MULTIPLE
PI232CX	Safety Plate – approximately 6"	EA	100

**CABLE CONNECTORS**

**Zinc Plated Die Cast Steel Romex Connectors\***

These zinc plated die cast connectors are for use with Romex, Service, and UF Cables.



CATALOG NO.	DESCRIPTION	TRADE SIZE	KNOCKOUT	UOM	ORDER MULTIPLE
PI321	Zinc plated die cast Romex Connector, pack of 8	3/8"	1/2"	PK	1
PI320	Zinc plated die cast Romex Connector, pack of 25	3/8"	1/2"	PK	1
PI319	Zinc plated die cast Romex Connector, pack of 4	3/4"	3/4"	PK	1
PI319CX	Zinc plated die cast Romex Connector, pack of 100	3/4"	3/4"	PK	1

**Rigid Conduit Bodies\***

These bodies are Aluminum and can be use indoor or outdoor. Use to gain access to the interior of a raceway for wire pulling, splicing (with limitations as specified by the NEC), and maintenance. This item comes with cover and gasket.



CATALOG NO.	DESCRIPTION	TRADE SIZE	BODY TYPE	UOM	ORDER MULTIPLE
PI458	Includes steel cover, screws, gasket	1/2"	Back (LB)	EA	1
PI459	Includes steel cover, screws, gasket	3/4"	Back (LB)	EA	1

\*Items in this section are Underwriter's Laboratories listed or recognized under the prime manufacturer's name.



**CABLE CONNECTORS cont'd**

**BX and Greenfield Connectors\***

These connectors are used to terminate Flexible Metal Conduit to a knock out in a dry location box or enclosure. Zinc die cast.



CATALOG NO.	DESCRIPTION	TRADE SIZE	KNOCKOUT	UOM	ORDER MULTIPLE
PI311	Set Screw Type Connector, 25 per pack	3/8"	1/2"	PK	1
PI312	Set Screw Type Connector, 8 per pack	3/8"	1/2"	PK	1
PI322	Straight Connector, squeeze type, for armored cable and flexible conduit, 8 per pack	3/8"	1/2"	PK	1
PI315	90° Connector, 3 per pack	3/8"	1/2"	PK	1
PI341	90° Connector, 4 per pack	1/2"	1/2"	PK	1
PI340	Combination Cable Connector suitable for Romex or BX and Greenfield, 8 per pack	3/8"	1/2"	PK	1
PI318	Duplex Connector with single screw, clamp type, 2 per pack	3/8"	1/2"	PK	1

**Liquid-Tite Connectors\***

These connectors are made of zinc die cast and can be used with Flexible Metal Conduits and non metallic conduits. Zinc die cast.



CATALOG NO.	DESCRIPTION	TRADE SIZE	KNOCKOUT	UOM	ORDER MULTIPLE
PI350	Straight Liquid-Tite Connector, 2 per pack	1/2"	1/2"	PK	1
PI351	Straight Liquid-Tite Connector, 2 per pack	3/4"	3/4"	PK	1
PI352	90° Liquid-Tite Connector	1/2"	1/2"	EA	1
PI353	90° Liquid-Tite Connector	3/4"	3/4"	EA	1

**Thinwall E.M.T. Connectors\***

These are used to join EMT conduit to boxes on enclosures. Zinc die cast.



CATALOG NO.	DESCRIPTION	TRADE SIZE	KNOCKOUT	UOM	ORDER MULTIPLE
PI411	Compression Type Connectors, 8 per pack	1/2"	1/2"	PK	1
PI412	Compression Type Connectors, 8 per pack	3/4"	3/4"	PK	1
PI416	Compression Type Couplings, 8 per pack	3/4"		PK	1
PI426	Compression Type Straight Connectors for connecting E.M.T. to Liquid-Tight, 8 per pack	3/4"		PK	1
PI419	Set Screw Type Connectors, 8 per pack	1/2"	1/2"	PK	1

**CABLE TIES AND ACCESSORIES**

**Heavy Duty Nylon Cable Ties**

Black ties are weather and UV resistant. Items in this section are Underwriters' Laboratories listed or recognized under the prime manufacturer's name.



CATALOG NO.	DESCRIPTION	LENGTH	COLOR	MAX. BUNDLE DIAMETER	TENSILE STRENGTH	UOM	ORDER MULTIPLE
6265BLX	Nylon; Heavy-duty, pack of 50	14"	Black	4"	175 lb.	PK	1
6265BCX	Nylon; Heavy-duty, pack of 100	14"	Black	4"	175 lb.	PK	1
6266BLX	Nylon; Heavy-duty, pack of 50	36"	Black	11"	175 lb.	PK	1

**Nylon Cable Ties with Mounting Hole**

Black ties are weather and UV resistant. Items in this section are Underwriters' Laboratories listed or recognized under the prime manufacturer's name.



CATALOG NO.	DESCRIPTION	MOUNTING HOLE	LENGTH	COLOR	MAX. BUNDLE DIAMETER	TENSILE STRENGTH	UOM	ORDER MULTIPLE
60264CX	Tie w/mtg. hole, pack of 100	#8	6"	Natural	1-3/8"	30 lb.	PK	1
60264BCX	Tie w/mtg. hole, pack of 100	#8	6"	Black	1-3/8"	30 lb.	PK	1
6264LX	Tie w/mtg. hole, pack of 50	#10	7"	Natural	1-3/4"	50 lb.	PK	1
6264CX	Tie w/mtg. hole, pack of 100	#10	7"	Natural	1-3/4"	50 lb.	PK	1
6264BCX	Tie w/mtg. hole, pack of 100	#10	7"	Black	1-3/4"	50 lb.	PK	1
60263CX	Tie w/mtg. hole, pack of 100	#10	11"	Natural	3"	50 lb.	PK	1
60263BLX	Tie w/mtg. hole, pack of 50	#10	11"	Black	3"	50 lb.	PK	1
60263BCX	Tie w/mtg. hole, pack of 100	#10	11"	Black	3"	50 lb.	PK	1

\*Items in this section are Underwriter's Laboratories listed or recognized under the prime manufacturer's name.



## CABLE TIES AND ACCESSORIES cont'd

### Nylon Cable Ties

Black ties are weather and UV resistant. Items in this section are Underwriters' Laboratories listed or recognized under the prime manufacturer's name.

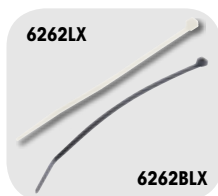

CATALOG NO.	DESCRIPTION	LENGTH	COLOR	MAX. BUNDLE DIAMETER	TENSILE STRENGTH	UOM	ORDER MULTIPLE
6267MX	Nylon Cable Ties, pack of 1,000	4"	Natural	13/16"	18 lb.	PK	1
6261CX	Nylon Cable Ties, pack of 100	6"	Natural	1-3/8"	18 lb.	PK	1
6261BCX	Nylon Cable Ties, pack of 100	6"	Black	1-3/8"	18 lb.	PK	1
6268BMX	Nylon Cable Ties, pack of 1,000	6"	Black	1-3/8"	30 lb.	PK	1
6262LX	Nylon Cable Ties, pack of 50	7-1/2"	Natural	1-3/4"	50 lb.	PK	1
6262CX	Nylon Cable Ties, pack of 100	7-1/2"	Natural	1-3/4"	50 lb.	PK	1
6262MX	Nylon Cable Ties, pack of 1,000	7-1/2"	Natural	1-3/4"	50 lb.	PK	1
6262BLX	Nylon Cable Ties, pack of 50	7-1/2"	Black	1-3/4"	50 lb.	PK	1
6262BCX	Nylon Cable Ties, pack of 100	7-1/2"	Black	1-3/4"	50 lb.	PK	1
6262BMX	Nylon Cable Ties, pack of 1,000	7-1/2"	Black	1-3/4"	50 lb.	PK	1
6263LX	Nylon Cable Ties, pack of 50	11"	Natural	3"	50 lb.	PK	1
6263CX	Nylon Cable Ties, pack of 100	11"	Natural	3"	50 lb.	PK	1
6263DX	Nylon Cable Ties, pack of 500	11"	Natural	3"	50 lb.	PK	1
6263BLX	Nylon Cable Ties, pack of 50	11"	Black	3"	50 lb.	PK	1
6263BCX	Nylon Cable Ties, pack of 100	11"	Black	3"	50 lb.	PK	1
6263BDX	Nylon Cable Ties, pack of 500	11"	Black	3"	50 lb.	PK	1
60265LX	Nylon Cable Ties, pack of 50	14"	Natural	4"	50 lb.	PK	1
60265BLX	Nylon Cable Ties, pack of 50	14"	Black	4"	50 lb.	PK	1

### Black Nylon Cable Tie Assortment

Black ties are weather and UV resistant. Items in this section are Underwriters' Laboratories listed or recognized under the prime manufacturer's name.

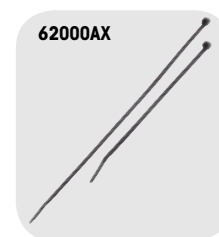

CATALOG NO.	DESCRIPTION	LENGTH	COLOR	MAX. BUNDLE DIAMETER	TENSILE STRENGTH	UOM	ORDER MULTIPLE
62000AX	Assortment	7-1/2"	Black	1-3/4"	50 lb.	PK	1
		11"	Black	3"	50 lb.		

### Cable Tie Mounts

Approximately 1in. square adhesive backed. These mounts can be mounted with a screw and will accept up to 75 lb. ties.



CATALOG NO.	DESCRIPTION	UOM	ORDER MULTIPLE
6269	Cable Tie Mounts; 1" square; adhesive backed, pack of 11	PK	1
6269LX	Cable Tie Mounts; 1" square; adhesive backed, pack of 50	PK	1
6269MX	Cable Tie Mounts; 1" square; adhesive backed, pack of 1,000	PK	1

## CONDUIT FITTINGS

### Straps

Our zinc plated steel straps are designed to hold conduit pipe.



CATALOG NO.	DESCRIPTION	UOM	ORDER MULTIPLE
PI306	Straps fit 1/2" E.M.T. Conduit, pack of 20	PK	1
PI306CX	Straps fit 1/2" E.M.T. Conduit, pack of 100	PK	1
PI307	Straps fit 3/4" E.M.T. Conduit, pack of 12	PK	1
PI307CX	Straps fit 3/4" E.M.T. Conduit, pack of 100	PK	1
PI908	Straps fit 1" E.M.T. Conduit, pack of 10	PK	1
PI908CX	Straps fit 1" E.M.T. Conduit, pack of 100	PK	1
PI909LX	Straps fit 1-1/4" E.M.T. Conduit, pack of 50	PK	1
PI206	Straps for 14-2 Romex, pack of 20	PK	1

### Knockout Seals and Hole Plug



CATALOG NO.	DESCRIPTION	UOM	ORDER MULTIPLE
PI316	For 1/2" knockouts, zinc plated steel, pack of 10	PK	1
PI317	For 3/4" knockouts, zinc plated steel, pack of 10	PK	1
ED406	Nylon Hole Plug for 3/8" hole, pack of 28	PK	1

### Reducing Washers

Reducing washers are for reducing knockout holes. These washers have raised flanges for a tight fit and are made of galvanized steel. PI308 reduces hole to fit appliance switch.



CATALOG NO.	DESCRIPTION	UOM	ORDER MULTIPLE
PI304	Reducing Washer - reduces hole from 1" to 1/2", pack of 10	PK	1
PI305	Reducing Washer - reduces hole from 1" to 3/4", pack of 10	PK	1
PI310	Reducing Washer - reduces hole from 3/4" to 1/2", pack of 28	PK	1
PI310LX	Reducing Washer - reduces hole from 3/4" to 1/2", pack of 50	PK	1
PI912	Reducing Washer - reduces hole from 2" to 3/4", pack of 5	PK	1
PI912LX	Reducing Washer - reduces hole from 2" to 3/4", pack of 50	PK	1
PI913	Reducing Washer - reduces hole from 1-1/2" to 1/2", pack of 4	PK	1
PI914	Reducing Washer - reduces hole from 1-1/2" to 3/4", pack of 4	PK	1

### Conduit Nipples\*

Used to connect two electrical utility boxes where room is limited. Zinc die cast steel. Comes with plated steel locknuts.



CATALOG NO.	DESCRIPTION	SIZE	CONNECTION	UOM	ORDER MULTIPLE
PI203	Conduit Nipple, pack of 6	1/2"	Straight	PK	1

## CONDUIT FITTINGS *cont'd*

### Conduit Nipples\*

PI301 is zinc die cast steel. PI303 is galvanized steel. All come with plated steel locknuts and plastic insulating bushings.



CATALOG NO.	DESCRIPTION	SIZE	CONNECTION	UOM	ORDER MULTIPLE
PI301	Conduit Nipple, pack of 2	1/2"	Offset	PK	1
PI303	Conduit Nipple, pack of 2	1/2" x 2"	Straight	PK	1

### Bushings and Locknuts

The locknuts and bushing are straight connectors provide excellent pullout strength and can be installed without disassembly. The compression nut ratchet prevents unintentional loosening.



CATALOG NO.	DESCRIPTION	UOM	ORDER MULTIPLE
PI331	Plastic "Anti-Short" Bushings for 14/2, 14/3, 12/2 BX cable, pack of 35	PK	1

### Electrical Staples

We have steel, insulated copper finish, and plastic electrical staples available.



CATALOG NO.	DESCRIPTION	SIZE	UOM	ORDER MULTIPLE
PI330	Plastic; for 2 conductor Romex and other NM cable conductor; 12/2-14/2 range; UV protected, pack of 50	3/8" x 1/2"	PK	1
PI332	Plastic; for 3 conductor Romex and other NM cable conductor; 12/3-14/3 range; UV protected, pack of 50	3/8" x 3/4"	PK	1
PI309	Steel; non-insulated for Romex and NM cable; 14/2-10/3 range, pack of 154	1" x 1/2"	PK	1
ED273	Insulated coppered finish; size #5, pack of 50	5/8" x 1/4"	PK	1
ED273CX	Insulated coppered finish; size #5, pack of 100	5/8" x 1/4"	PK	1

## GENERAL TOOLS

### Devco Crimpers

Crimps insulated and non insulated terminals 22 to 10 AWG, cuts bolts #4 40 through #10 24, and strips stranded wire 22 to 10 AWG and solid wire 18 to 8 AWG. Features two precision ground wire cutters, one on the nose and the other behind the pivot point. Plastic cushion handle.



CATALOG NO.	DESCRIPTION	UOM	ORDER MULTIPLE
5002	Devco Crimpers; plastic coated handle	EA	1

### Blind Rivet Tools

Heavy duty hand rivet tool that offers long handles to increase leverage and to secure the rivet in the nosepiece while the tool is in use. Powerful riveting capacity with 4 standard nosepieces to set 3/32, 1/8, 5/32, and 3/16" blind rivets.



CATALOG NO.	DESCRIPTION	UOM	ORDER MULTIPLE
5107	Heavy-duty tool; 4 interchangeable nose pieces to accommodate 3/32", 1/8", 5/32", 3/16" steel or aluminum rivets	EA	1

### Magnetic Hex Chucks

Magnetic Hex Chucks may be used with an electric drill to drive hex washer head screws.



CATALOG NO.	DESCRIPTION	HEX HEAD SIZE	HEX HEAD DIAMETER	LENGTH	UOM	ORDER MULTIPLE
DE13	Magnetic Hex Chuck	1/4"	7/16"	1-3/4"	EA	1
DE14	Magnetic Hex Chuck	5/16"	1/2"	1-3/4"	EA	1
DE15	Magnetic Hex Chuck	3/8"	9/16"	1-7/8"	EA	1
DE23	Magnetic Hex Chuck	1/4"	7/16"	2-9/16"	EA	1
DE24	Magnetic Hex Chuck	5/16"	1/2"	2-9/16"	EA	1
DE33**	Magnetic Hex Chuck	1/4"	7/16"	3"	EA	1

\*\*Magnetic insert bit holder with a "C" ring retainer

\*Items in this section are Underwriter's Laboratories listed or recognized under the prime manufacturer's name.



## NUTS AND BOLTS

### Finished Hex Nuts

The hex nuts are zinc plated steel.



CATALOG NO.	DESCRIPTION	SIZE	UOM	ORDER MULTIPLE
6501	Finished Hex Nuts, pack of 60	1/4" - 20	PK	1
6501CX	Finished Hex Nuts, pack of 100	1/4" - 20	PK	1
6502	Finished Hex Nuts, pack of 38	5/16" - 18	PK	1
6503	Finished Hex Nuts, pack of 25	3/8" - 16	PK	1
6503CX	Finished Hex Nuts, pack of 100	3/8" - 16	PK	1
6505	Finished Hex Nuts, pack of 11	1/2" - 13	PK	1
6505LX	Finished Hex Nuts, pack of 50	1/2" - 13	PK	1

### Stove Bolts

Stove Bolts are a combination of slotted round head machine screws and finished hex nuts. They are made of zinc plated steel.



CATALOG NO.	DESCRIPTION	SIZE	LENGTH	UOM	ORDER MULTIPLE
6401	Stove Bolts, pack of 42	#10 - 24	1/2"	PK	1
6402	Stove Bolts, pack of 38	#10 - 24	3/4"	PK	1
6403	Stove Bolts, pack of 34	#10 - 24	1"	PK	1
6404	Stove Bolts, pack of 27	#10 - 24	1-1/2"	PK	1
6411	Stove Bolts, pack of 22	1/4" - 20	1/2"	PK	1
6412	Stove Bolts, pack of 20	1/4" - 20	3/4"	PK	1
6413	Stove Bolts, pack of 18	1/4" - 20	1"	PK	1
6414	Stove Bolts, pack of 15	1/4" - 20	1-1/2"	PK	1
6415	Stove Bolts, pack of 13	1/4" - 20	2"	PK	1
6416	Stove Bolts, pack of 11	1/4" - 20	2-1/2"	PK	1

### Flat Washers

These washers are zinc plated steel with a USS Classification.

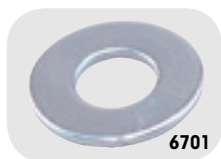

CATALOG NO.	DESCRIPTION	SIZE	INNER DIAMETER	OUTER DIAMETER	UOM	ORDER MULTIPLE
6701	Flat Washers (USS), pack of 160	3/16"	1/4"	9/16"	PK	1
6702	Flat Washers (USS), pack of 72	1/4"	5/16"	3/4"	PK	1
6703	Flat Washers (USS), pack of 33	5/16"	3/8"	7/8"	PK	1
6704	Flat Washers (USS), pack of 37	3/8"	7/16"	1"	PK	1
6704-2X	Flat Washers (USS), pack of 134	3/8"	7/16"	1"	PK	1
6706	Flat Washers (USS), pack of 11	1/2"	9/16"	1-3/8"	PK	1
6706-2X	Flat Washers (USS), pack of 52	1/2"	9/16"	1-3/8"	PK	1
6700AX	Assortment	All sizes included			EA	1

### Machine Screw Hex Nuts

The hex nuts are zinc plated steel.



CATALOG NO.	DESCRIPTION	SIZE	UOM	ORDER MULTIPLE
6526	Machine Screw Hex Nuts, pack of 49	#8 - 32	PK	1
6528	Machine Screw Hex Nuts, pack of 44	#10 - 24	PK	1
6500A	Assortment, 23 of each	#6-32, #8-32, #10-32	EA	1

### Toggle Bolts

The toggle bolts are slotted round head machine screws with spring wings and are made of zinc plated steel.



CATALOG NO.	DESCRIPTION	LENGTH	BOLT SIZE	HOLE SIZE	UOM	ORDER MULTIPLE
7033	Toggle Bolts, pack of 6	4"	3/16"	1/2"	PK	1
7034	Toggle Bolts, pack of 5	4"	1/4"	5/8"	PK	1
7036X	Toggle Bolts, pack of 4	4"	3/8"	1"	PK	1
7066X	Toggle Bolts, pack of 4	6"	3/8"	1"	PK	1

### Hex Head Cap Screws

Hex Screw Cap Screws are made of low carbon, grade 2 steel and are USS Classified. The total thread length on these screws equal 2x diameter + 1/4in.



CATALOG NO.	DESCRIPTION	SIZE	LENGTH	UOM	ORDER MULTIPLE
6601	Hex Head Cap Screws, pack of 28	1/4" - 20	3/4"	PK	1
6602	Hex Head Cap Screws, pack of 25	1/4" - 20	1"	PK	1
6603	Hex Head Cap Screws, pack of 18	1/4" - 20	1-1/2"	PK	1
6622	Hex Head Cap Screws, pack of 15	5/16" - 18	1"	PK	1
6623	Hex Head Cap Screws, pack of 12	5/16" - 18	1-1/2"	PK	1
6641	Hex Head Cap Screws, pack of 14	3/8" - 16	3/4"	PK	1
6642	Hex Head Cap Screws, pack of 12	3/8" - 16	1"	PK	1
6643	Hex Head Cap Screws, pack of 8	3/8" - 16	1-1/2"	PK	1
6644	Hex Head Cap Screws, pack of 7	3/8" - 16	2"	PK	1
6645	Hex Head Cap Screws, pack of 5	3/8" - 16	2-1/2"	PK	1
6685	Hex Head Cap Screws, pack of 3	1/2" - 13	2-1/2"	PK	1

### Medium Split Lock Washers

Spring type. These washers are made of zinc plated steel.



CATALOG NO.	DESCRIPTION	SIZE	UOM	ORDER MULTIPLE
6730	Medium Split Lock Washers, pack of 95	3/16"	PK	1
6731	Medium Split Lock Washers, pack of 72	1/4"	PK	1
6732	Medium Split Lock Washers, pack of 59	5/16"	PK	1
6733	Medium Split Lock Washers, pack of 38	3/8"	PK	1
6735	Medium Split Lock Washers, pack of 18	1/2"	PK	1

**NUTS AND BOLTS cont'd**

**Fender Washers**

These washers are made of zinc plated steel.

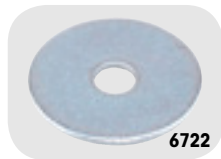

CATALOG NO.	DESCRIPTION	SIZE	INNER DIAMETER	OUTER DIAMETER	UOM	ORDER MULTIPLE
<b>6722</b>	Fender Washers, pack of 20	1/4"	9/32"	1-1/4"	PK	1
<b>6722-2X</b>	Fender Washers, pack of 92	1/4"	9/32"	1-1/4"	PK	1
<b>6724</b>	Fender Washers, pack of 12	3/8"	13/32"	1-1/2"	PK	1
<b>6724-2X</b>	Fender Washers, pack of 66	3/8"	13/32"	1-1/2"	PK	1

**POWER CORDS AND WORK LIGHTS**

**Round Extension Cords\***

Comes in bright orange or yellow, depending upon availability.



CATALOG NO.	DESCRIPTION	WIRE	LENGTH	RATING	UOM	ORDER MULTIPLE
<b>5230</b>	Round Extension Cord	14/3	100'	13A/125V	EA	1

**Trouble Lights\***

These all weather lights are extra flexible with metal guards.



CATALOG NO.	DESCRIPTION	WIRE	CORD LENGTH	RATING	UOM	ORDER MULTIPLE
<b>5200</b>	Trouble Light	16/3	25'	13A/125V	EA	1
<b>5201</b>	Trouble Light	16/3	50'	13A/125V	EA	1

**SCREWS**

**Combo Head Sheet Metal Screws**

These screws are used on sheet metal items.



CATALOG NO.	DESCRIPTION	LENGTH	SCREW SIZE	UOM	ORDER MULTIPLE
<b>6853</b>	Combo Head Screws, pack of 48	1/2"	#10	PK	1
<b>6855</b>	Combo Head Screws, pack of 46	3/4"	#10	PK	1
<b>6858</b>	Combo Head Screws, pack of 26	1-1/2"	#10	PK	1
<b>6859</b>	Combo Head Screws, pack of 19	2"	#10	PK	1
<b>6865</b>	Combo Head Screws, pack of 32	3/4"	#12	PK	1
<b>6866</b>	Combo Head Screws, pack of 26	1"	#12	PK	1
<b>6876</b>	Combo Head Screws, pack of 20	1"	#14	PK	1

**Sheet Metal Screw Assortments**

6800BX and 6800HX come in a four compartment, clear plastic box.



CATALOG NO.	DESCRIPTION	UOM	ORDER MULTIPLE
<b>6800HX</b>	Slotted Hex Washer Head Screws: #6 x 3/8", #8 x 1/2", #8 x 3/4", #10 x 3/4", #10 x 1"	EA	1

**Self-Drilling Screw Repair Kit**

These screws are used for replacements in striped holes.



CATALOG NO.	DESCRIPTION	UOM	ORDER MULTIPLE
<b>6900AX</b>	Contains: #12 x 3/4", #12 x 1", #14 x 3/4", #14 x 1"	EA	1

**Self-Drilling Screws**

Zinc plated steel. Self drilling screws drill and tap holes in one step. Hex washer heads. #8 and #10 screws are designed for use with material thickness of .035" to .110"; #12 and #14 screws are designed for use with .110" to .220" material thickness.



CATALOG NO.	DESCRIPTION	UOM	ORDER MULTIPLE
<b>6943CX</b>	Hex Head Self Drilling Screw, 1/4in. Head #8 x 1/2in., 100 pcs	EA	1
<b>6945CX</b>	Hex Head Self Drilling Screw, Zinc Plated, #8 x 3/4in., 100 pcs	EA	1
<b>6946CX</b>	Hex Head Self Drilling Screw, 1/4in. Head #8 x 1in, 100 pcs	EA	1
<b>6953CX</b>	Hex Washer Head Self Drilling Screws 5/16in. Head #10 x 1/2in 100 pcs	EA	1
<b>6955CX</b>	Hex Head Self Drilling Screw, 5/16in. Head #10 x 3/4in., 100 pcs	EA	1
<b>6956CX</b>	Hex Washer Head Self Drilling Screws 5/16in. Head #10 x 1in 100 pcs	EA	1



**SPECIALTY FASTENERS**

**Nylon Cable Clamps**

These cable clamps are perfect for securing wire or pipes.



CATALOG NO.	DESCRIPTION	FITS PIPE OUTER DIAMETER	THICKNESS	WIDTH	UOM	ORDER MULTIPLE
<b>5381</b>	Nylon Cable Clamps, pack of 54	1/8"	.050"	3/8"	PK	1
<b>5382</b>	Nylon Cable Clamps, pack of 48	1/4"	.050"	3/8"	PK	1
<b>5383</b>	Nylon Cable Clamps, pack of 41	3/8"	.050"	3/8"	PK	1
<b>5384</b>	Nylon Cable Clamps, pack of 35	1/2"	.050"	3/8"	PK	1
<b>5385</b>	Nylon Cable Clamps, pack of 21	5/8"	.060"	1/2"	PK	1
<b>5380AX</b>	Assortment	1/8" - 1"			EA	1

**Pipe Hanging Strap**

Non plated Steel Pipe hanging Strap is perfect for hanging pipes, fastening faucets and valves, as well as repair jobs.



CATALOG NO.	DESCRIPTION	SIZE	UOM	ORDER MULTIPLE
<b>P1335</b>	Pipe Hanging Strap; 28 gauge AWG	3/4" x 10'	EA	1

**Cotter Pins**

Cotter Pins provide smooth locking between two parts. This set includes an assortment of regular Cotter Pins with extended prongs.



CATALOG NO.	DESCRIPTION	UOM	ORDER MULTIPLE
<b>6011</b>	Cotter Pins: 1/16" x 1-1/2"; 3/32" x 1-1/2"; 1/8" x 1-1/2", pack of 51	PK	1

**Motor Shaft Key Assortments**

You can use choose from either a large assortment or a small assortment. The keys are made of cold rolled 1018 steel and are zinc plated.



CATALOG NO.	DESCRIPTION	UOM	ORDER MULTIPLE
<b>6101</b>	Small Assortment includes: 1/8" x 1/8" x 1-3/16"; 3/16" x 3/16" x 1-3/16"; 3/16" x 1/4" x 1-3/16"; 1/4" x 1/4" x 1-3/4"	EA	1
<b>6102</b>	Large Assortment includes: 1/4" x 1/4" x 1-3/4"; 5/16" x 5/16" x 3"; 3/8" x 3/8" x 3	EA	1

**Hose Clamps**

Hose Clamps have stainless steel housings and bands. The screws are plated steel and have slotted hex heads allowing a socket wrench, nut driver, or screwdriver to be used.



CATALOG NO.	DESCRIPTION	SAE NO.	SAE DIAMETER RANGE (in.)	APPROX. RANGE (in.)	UOM	ORDER MULTIPLE
<b>HC6202</b>	Hose Clamps, pack of 6	*	N/A	1/4 to 5/8	PK	1
<b>HC6203</b>	Hose Clamps, pack of 6	6	.44 - .78	5/16 to 7/8	PK	1
<b>HC5410</b>	Hose Clamps, pack of 6	10	.56 - 1.06	9/16 to 1-1/8	PK	1
<b>HC5410X</b>	Hose Clamps, pack of 10	10	.56 - 1.06	9/16 to 1-1/8	PK	1
<b>HC5416</b>	Hose Clamps, pack of 6	16	.81 - 1.50	3/4 to 1-1/2	PK	1
<b>HC5416X</b>	Hose Clamps, pack of 10	16	.81 - 1.50	3/4 to 1-1/2	PK	1
<b>HC5420</b>	Hose Clamps, pack of 6	20	.81 - 1.75	13/16 to 1-3/4	PK	1
<b>HC5424</b>	Hose Clamps, pack of 6	24	1.06 - 2.00	1-1/16 to 2	PK	1
<b>HC5436</b>	Hose Clamps, pack of 4	36	1.81 - 2.75	1-1/2 to 2-3/4	PK	1

**Set Screws**

Set Screws have cup points and hex socket heads. Class 3A threads. Made of heat treated alloy steel.



CATALOG NO.	DESCRIPTION	SIZE	UOM	ORDER MULTIPLE
<b>6000</b>	Large Assortment; course thread	1/4"-20; 5/16"-18; 3/8"-16	EA	1
<b>6001</b>	Small Assortment; fine thread	#8-32; #10-32; 1/4"-28	EA	1

\*Items in this section are Underwriter's Laboratories listed or recognized under the prime manufacturer's name.

## SPECIALTY FITTINGS

### Grease Fittings

Case hardened steel fittings plated with yellow dip chromate and built-in ball checks. Assortment available in clear plastic box.

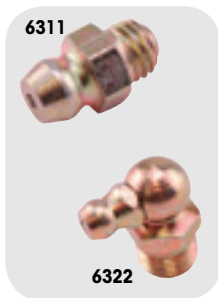

CATALOG NO.	DESCRIPTION	UOM	ORDER MULTIPLE
<b>6311</b>	Grease Fittings: 1/4"-28 Tapered Thread; straight, pack of 8	PK	1
<b>6312</b>	Grease Fittings: 1/8" Pipe Thread; straight, pack of 5	PK	1
<b>6321</b>	Grease Fittings: 1/4"-28 Tapered Thread; 90°, pack of 3	PK	1
<b>6322</b>	Grease Fittings: 1/8" Pipe Thread; 90°, pack of 3	PK	1
<b>6310X</b>	Assortment includes: 6311, 6312, 6321, 6322	EA	1

## STORAGE CONTAINERS

### Metal Parts Boxes

Metal Parts Boxes are prime cold rolled steel with baked gray enamel finish. The finish is rust and acid resistant. Each box comes with high impact plastic tray, positive pull down catch, and stick back parts labels for lid interiors.



### Satchel Style Case

Parts box made from rugged copolymer material with high impact translucent lid and handle on the side. 15 removable dividers allow up to 24 compartments.



CATALOG NO.	DESCRIPTION	NO. OF COMPARTMENTS	DIMENSIONS (L x W x D)	UOM	ORDER MULTIPLE
<b>8200M</b>	Metal Parts Box	21	13-3/8" x 9-1/4" x 2"	EA	1
<b>8220M</b>	Metal Parts Box	24	18" x 12" x 3"	EA	1

CATALOG NO.	DESCRIPTION	NO. OF COMPARTMENTS	DIMENSIONS (L x W x D)	UOM	ORDER MULTIPLE
<b>8233</b>	Satchel Style Case	Up to 24	15" x 11-3/4" x 2-1/2"	EA	1

### Polypropylene Parts Boxes

This box is ideal for holding your different sized nuts and bolts along with your additional bits. It can be stored in a tool box as well.



CATALOG NO.	DESCRIPTION	COLOR	NO. OF COMPARTMENTS	DIMENSIONS (L x W x D)	UOM	ORDER MULTIPLE
<b>8201C</b>	Polypropylene Parts Box Translucent		13	11" x 6-3/4" x 1-1/4"	EA	1
<b>8203C</b>	Polypropylene Parts Box Translucent		24	13-1/8" x 9" x 2-5/8"	EA	1

## TAPES

### Tape

Vinyl electrical tape. Part 5247 holds up to 7 pounds per square inch when attached to steel surface.



### Teflon® Tape

This PTFE Tape is made of non toxic, pure white PTFE. The tape can be used with chemicals, solvents, oxygen, and on food lines. The product can withstand up to 2000 psi of pressure.



CATALOG NO.	DESCRIPTION	LENGTH	UOM	ORDER MULTIPLE
<b>5255</b>	Vinyl Electrical Tape	3/4" x 60'	EA	1

CATALOG NO.	DESCRIPTION	LENGTH	UOM	ORDER MULTIPLE
<b>5246</b>	Teflon® Thread Seal Tape	1/2" x 520'	EA	1





## TESTERS, LEADS, CLIPS, FUSES

### Clips

The clips are alligator clips and have vinyl red and black insulators.



CATALOG NO.	DESCRIPTION	UOM	ORDER MULTIPLE
5033	Steel Alligator Clips for use with test probes (.075"-.080"); 1-31/32" long; jaws open 5/16" max., pack of 2 red, 2 black, 4 clips	PK	1
5035	Copper Alligator Clips; 1-31/32" long; jaws open 5/16" max.; crimpers slotted screw connection, pack of 2 red, 2 black, 4 clips	PK	1
5036	Steel Test Clips; 20A, 2-7/16" long; jaws open 5/8" max.; crimpers slotted screw connection, pack of 1 red, 1 black, 2 clips	PK	1

### Test Leads

These are replacement leads.



CATALOG NO.	DESCRIPTION	UOM	ORDER MULTIPLE
5031	Low Voltage Test Leads; eight 22" long, color-coded leads with fully insulated alligator clips	EA	1
5041	Small Hook Type Low Voltage Test Leads; retractable hooks, 36" thermoplastic 22 gauge wire, nylon body/plunger, red/black	EA	1
5042	Large Hook Type Low Voltage Test Leads; retractable hooks, 36" PVC insulated 20 gauge wire, nylon body/plunger, red/black	EA	1
5046	Flexible Test Leads; steel alligator clips with vinyl red and black insulators; 36" 20 gauge wire; extremely flexible	EA	1

### Blade (Auto) Fuses

These fuses are used to protect circuits in the wiring harness that are usually found under the hood, in a fuse panel or supplementary panel near the battery. MAX fuses are used in domestic and import vehicles.

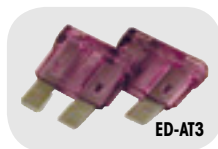

CATALOG NO.	DESCRIPTION	UOM	ORDER MULTIPLE
ED-AT3	Blade Fuse – 3 Amp – Purple, pack of 10	PK	1
ED-AT5	Blade Fuse – 5 Amp – Tan, pack of 10	PK	1

### Dual Element Fuses – 250V

Provides time delay for temporary over-current conditions and motor running protection for heating and air conditioning equipment. Eliminates unnecessary maintenance from harmless overloads.



CATALOG NO.	DESCRIPTION	UOM	ORDER MULTIPLE
ED-CR15	Dual Element Fuse – 15 Amps, pack of 2	PK	1
ED-CR20	Dual Element Fuse – 20 Amps, pack of 2	PK	1
ED-CR25	Dual Element Fuse – 25 Amps, pack of 2	PK	1
ED-CR30	Dual Element Fuse – 30 Amps, pack of 2	PK	1
ED-CR35	Dual Element Fuse – 35 Amps, pack of 2	PK	1
ED-CR40	Dual Element Fuse – 40 Amps, pack of 2	PK	1
ED-CR45	Dual Element Fuse – 45 Amps, pack of 2	PK	1
ED-CR50	Dual Element Fuse – 50 Amps, pack of 2	PK	1
ED-CR60	Dual Element Fuse – 60 Amps, pack of 2	PK	1

U.L. Class RK-5, Standard for Safety 198E, Current Limiting Fuses, Interrupting Rating 200,000 Amps. rms. A.C.

## WIRE

### TFFN Stranded Hook-Up Wire\*

Packaged in handy dispenser bag. Polyvinyl chloride insulation. Wire rating: 600V, 90°C. Insulation: oil resistant nylon coating.



CATALOG NO.	COLOR	GAUGE	STRANDS	O.D.	LENGTH	UOM	ORDER MULTIPLE
60331B	Black, pack of 50'	18	16	.09"	48'	PK	1
60331BE	Blue, pack of 50'	18	16	.09"	48'	PK	1
60331R	Red, pack of 50'	18	16	.09"	48'	PK	1
6332B	Black, pack of 50'	16	26	.10"	48'	PK	1
6332G	Green, pack of 50'	16	26	.10"	48'	PK	1
6332R	Red, pack of 50'	16	26	.10"	48'	PK	1
6332W	White, pack of 50'	16	26	.10"	48'	PK	1

### THHN Stranded Hook-Up Wire\*

Packaged in handy dispenser bag. Polyvinyl chloride insulation. Wire rating: 600V, 90°C. Insulation: oil resistant nylon coating.

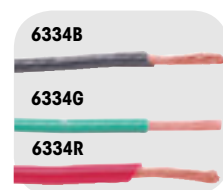

CATALOG NO.	COLOR	GAUGE	STRANDS	O.D.	LENGTH	UOM	ORDER MULTIPLE
6333B	Black, pack of 50'	14	19	.11"	48'	PK	1
6333G	Green, pack of 50'	14	19	.11"	48'	PK	1
6333R	Red, pack of 50'	14	19	.11"	48'	PK	1
6333W	White, pack of 50'	14	19	.11"	48'	PK	1
6334B	Black, pack of 50'	12	19	.13"	48'	PK	1
6334G	Green, pack of 50'	12	19	.13"	48'	PK	1
6334R	Red, pack of 50'	12	19	.13"	48'	PK	1
6334W	White, pack of 50'	12	19	.13"	48'	PK	1
6335B	Black, pack of 50'	10	19	.17"	48'	PK	1
6335G	Green, pack of 50'	10	19	.17"	48'	PK	1
6335R	Red, pack of 50'	10	19	.17"	48'	PK	1
6335W	White, pack of 50'	10	19	.17"	48'	PK	1
6360B	Black, pack of 50'	8	19	.22"	25'	PK	1
6360R	Red, pack of 50'	8	19	.22"	25'	PK	1
6360W	White, pack of 50'	8	19	.22"	25'	PK	1

WIRE cont'd

Thermostat Wire\*

Thermoplastic insulated, jacketed wire for low voltage applications. Conductors are solid copper, individually insulated and color coded.



CATALOG NO.	DESCRIPTION	CONDUCTORS	WIRE GAUGE	LENGTH	UOM	ORDER MULTIPLE
6331	Thermostat Wire, pack of 40'	2	20	40'	PK	1
6336	Thermostat Wire, pack of 40'	3	20	40'	PK	1
6330-4	Thermostat Wire, pack of 40'	4	20	40'	PK	1
6337	Thermostat Wire, pack of 40'	5	20	40'	PK	1
6330-6	Thermostat Wire, pack of 40'	6	20	40'	PK	1
6338	Thermostat Wire, pack of 40'	8	20	40'	PK	1
6339XL	Thermostat Wire, pack of 40'	10	20	40'	PK	1

High Temperature Range Wire\*

200°C glass braided, three conductor twisted wire. 600V; silicone rubber insulated. This product also contains a crimper.



CATALOG NO.	COLOR	WIRE GAUGE	LENGTH	UOM	ORDER MULTIPLE
6383-35	Black, Red, and White, pack of 5'	14	5'	PK	1
6383-325	Black, Red, and White, pack of 25'	14	25'	PK	1
6384-35	Black, Red, and White, pack of 5'	12	5'	PK	1
6384-325	Black, Red, and White, pack of 25'	12	25'	PK	1

SJTO Service Cord\*

Features stranded bare copper, PVC insulation; PVC jacket. Cord is oil resistant. Cords have 3 individually insulated conductors. Ratings: 300V; 60°C.

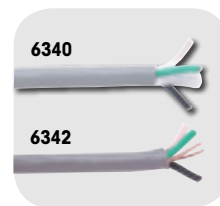

CATALOG NO.	DESCRIPTION	WIRE GAUGE	LENGTH	UOM	ORDER MULTIPLE
6340	SJTO Service Cord, pack of 12'	16	12'	PK	1
6341	SJTO Service Cord, pack of 20'	16	20'	PK	1
6342	SJTO Service Cord, pack of 12'	14	12'	PK	1
6343	SJTO Service Cord, pack of 20'	14	20'	PK	1

Stranded High Temperature Wire\*

Thermoplastic equipment insulated wire. CSA listed at 105°C; 600V. Insulation thickness: .03". MTW/AWM/TEW

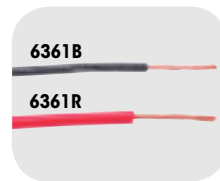

CATALOG NO.	COLOR	GAUGE	STRANDS	O.D.	LENGTH	UOM	ORDER MULTIPLE
6361B	Black, pack of 48'	18	16	.113"	48'	PK	1
6361R	Red, pack of 48'	18	16	.113"	48'	PK	1
6362B	Black, pack of 48'	16	26	.125"	48'	PK	1
6362R	Red, pack of 48'	16	26	.125"	48'	PK	1
6362W	White, pack of 48'	16	26	.125"	48'	PK	1
6363W	White, pack of 48'	14	19	.139"	48'	PK	1
6364B	Black, pack of 48'	12	19	.158"	48'	PK	1
6364R	Red, pack of 48'	12	19	.158"	48'	PK	1
6364W	White, pack of 48'	12	19	.158"	48'	PK	1
6365R	Red, pack of 48'	10	19	.182"	48'	PK	1

WIRING DEVICES

Thermoplastic Handle Plug\*

This plug is a standard grade with flexible spring prongs and is furnished with a face washer. This product's rating is a 15A 125V and also contains a crimper.



CATALOG NO.	DESCRIPTION	MAX. CORD DIAMETER	POLES	WIRES	MATERIAL	UOM	ORDER MULTIPLE
ED179	Handle Plug	.406"	2	2	Thermoplastic	EA	1

Grounding Rubber Handle Plug\*

The rubber back design allows for sure grip and protection against dirt and moisture entry. This plug is designed to operate in the widest possible temperature ranges.



CATALOG NO.	DESCRIPTION	FITS CORD DIAMETER	POLES	WIRES	RATING	UOM	ORDER MULTIPLE
ED1709	Grounding Handle Plug	.25"-.60"	2	3	15A-125V	EA	1

Tandem Grounding Rubber Handle Plug\*

The rubber back design allows for sure grip and protection against dirt and moisture entry. This plug is designed to operate in the widest possible temperature ranges



CATALOG NO.	DESCRIPTION	FITS CORD DIAMETER	POLES	WIRES	RATING	UOM	ORDER MULTIPLE
ED1711	Tandem Handle Plug	.25"-.60"	2	3	15A-250V	EA	1

Armored Plug\*

This plug has a round dead front and is vinyl enclosed.



CATALOG NO.	DESCRIPTION	FITS CORD DIAMETER	POLES	WIRES	RATING	UOM	ORDER MULTIPLE
ED2867	Armored Plug	.25"-.625"	2	3	15A-125V	EA	1



**WIRING DEVICES cont'd**

**Right Angle Plug\***

Our right angle plug is ergonomically designed fluted body with radial gripping ridge creates an ideal surface for gripping and pulling.



CATALOG NO.	DESCRIPTION	FITS CORD DIAMETER	POLES	WIRES	RATING	UOM	ORDER MULTIPLE
<b>ED4409</b>	Right Angle Plug	.25"-.655"	2	3	20A-125V	EA	1
<b>ED4509</b>	Right Angle Plug	.25"-.655"	2	3	20A-250V	EA	1
<b>ED4867</b>	Right Angle Plug	.25"-.655"	2	3	15A-125V	EA	1

**Rubber Connector\***

This is a standard grade rubber connector with a 3 pole opening.



CATALOG NO.	DESCRIPTION	FITS CORD DIAMETER	POLES	WIRES	RATING	UOM	ORDER MULTIPLE
<b>ED252</b>	Rubber Connector	.25"-.60"	2	3	15A-125V	EA	1

**Armored Connector\***

The Armor Connector is ideal for shops, garages, and heavier duty work areas. Vinyl enclosed.



CATALOG NO.	DESCRIPTION	FITS CORD DIAMETER	POLES	WIRES	RATING	UOM	ORDER MULTIPLE
<b>ED2887</b>	Armored Connector	.225"-.60"	2	3	15A-125V	EA	1

**Ground Adapter\***

This adapter is polarized with 2 pole to 3 wire grounding. The body is made of polypropylene.



CATALOG NO.	DESCRIPTION	RATING	UOM	ORDER MULTIPLE
<b>ED419</b>	Ground Adapter	15A-125V	EA	2

**Triple Outlets\***

These outlets are polarized and are made of high impact resistant plastic.



CATALOG NO.	DESCRIPTION	RATING	UOM	ORDER MULTIPLE
<b>5223</b>	Heavy duty, 2 pole, 3 wire	15A-125V	EA	1

**Power Supply Replacement Cords\***

For power tools or appliances. Black vinyl cord is flexible in very cold environments. Wire type is SJEW-A.



CATALOG NO.	DESCRIPTION	WIRE	RATING	LENGTH	UOM	ORDER MULTIPLE
<b>5240</b>	Black Replacement Cord	16/3	13A/125V	10'	EA	1
<b>5242</b>	Black Replacement Cord	14/3	15A/125V	10'	EA	1

**Receptacles\***

Our receptacles are available in either singles or duplexes. This is a 2 pole, 3 wire product with ground included. Standard Grade.



CATALOG NO.	DESCRIPTION	RATING	COLOR	UOM	ORDER MULTIPLE
<b>ED1876</b>	Single Receptacle	20A-250V	Brown	EA	1
<b>ED1876-I</b>	Single Receptacle	20A-250V	Ivory	EA	1
<b>ED1877</b>	Single Receptacle	20A-125V	Brown	EA	1
<b>ED270**</b>	Duplex Receptacle	15A-125V	Brown	EA	1
<b>ED270-I**</b>	Duplex Receptacle	15A-125V	Ivory	EA	1
<b>ED877</b>	Duplex Receptacle	20A-125V	Brown	EA	1

\*\*Standard Grade

**Toggle Switch and Receptacle Combination Device\***

This device is a single pole switch with 15A 120V AC. The receptacle is 15A 125V AC and it is a 2 pole, three wire grounding.



CATALOG NO.	DESCRIPTION	UOM	ORDER MULTIPLE
<b>ED5225</b>	Toggle Switch and Receptacle - Brown Body	EA	1

\*Items in this section are Underwriter's Laboratories listed or recognized under the prime manufacturer's name.

## WIRING DEVICES cont'd

### Metal Bat Handle Toggle Switches\*

Features black phenolic plastic case; brass terminals; steel and zinc chromate frame and support; all other external parts are brass/bright nickel. These heavy duty toggle switches have screw terminals. Part ED447 has an "ON-OFF" face plate.

Specifications: 10A/277V–20A/125V AC

Single Pole: 3/4HP 125–250V AC

Double Pole: 1-1/2HP 125–250V AC



ED447

CATALOG NO.	DESCRIPTION	SEQUENCE	CIRCUIT	UOM	ORDER MULTIPLE
ED447	Bat Handle Toggle Switch	ON-OFF	Single Pole, Single Throw	EA	1
ED453	Bat Handle Toggle Switch	ON-ON	Double Pole, Double Throw	EA	1
ED454	Bat Handle Toggle Switch	ON-ON	Single Pole, Double Throw	EA	1
ED455	Bat Handle Toggle Switch	ON-OFF	Double Pole, Single Throw	EA	1
ED468	Bat Handle Toggle Switch	ON-OFF-ON	Single Pole, Double Throw	EA	1
ED494	Bat Handle Toggle Switch	ON-OFF-ON	Double Pole, Double Throw	EA	1
ED448B	Bat Handle Toggle Switch	ON-OFF	Single Pole, Single Throw	EA	1

### Toggle Switch with Neon Pilot Light Combination Device\*

Switch: 15A-120V AC

Neon Pilot Light: 1/25W, 120V AC



ED277

CATALOG NO.	DESCRIPTION	UOM	ORDER MULTIPLE
ED277	Toggle Switch with Neon Pilot Light – Brown Body	EA	1

### Utility Fuse Outlets\*

This is designed to break up electrical surges on equipment.



PI381

CATALOG NO.	DESCRIPTION	UOM	ORDER MULTIPLE
PI381	Utility Fuse Outlet and Switch with Cover; 1/2HP-125V AC only; galvanized steel construction	EA	1

### 6180 Series Terminal Blocks\*

These terminal blocks are constructed of high barrier thermoplastic are rated 20A 250V.



6182

CATALOG NO.	DESCRIPTION	NO. OF POSITIONS	LENGTH (in.)	WIDTH (in.)	SCREW SIZE	MAX. WIRE SIZE	UOM	ORDER MULTIPLE
6182	Terminal Block	4	2.16	.88	6-32	22-14	EA	1
6183	Terminal Block	6	2.91	.88	6-32	22-14	EA	1
6184	Terminal Block	8	3.66	.88	6-32	22-14	EA	1
6185	Terminal Block	10	4.41	.88	6-32	22-14	EA	1
6186	Terminal Block	12	5.16	.88	6-32	22-14	EA	1
6187	Terminal Block	14	5.91	.88	6-32	22-14	EA	1

### Toggle Switches\*

Our toggle switch is a silent switch with ground included. Standard Grade.



ED1232

ED1301-I

CATALOG NO.	DESCRIPTION	RATING	COLOR	UOM	ORDER MULTIPLE
ED1240-2	Single Pole	15A–120/277V AC	Brown	EA	1
ED1238	Single Pole	20A–120/277V AC	Brown	EA	1
ED1301**	Single Pole	15A–120V AC	Brown	EA	1
ED1301-I**	Single Pole	15A–120V AC	Ivory	EA	1
ED1262-2	Double Pole	15A–120/277V AC	Brown	EA	1
ED1262-2I	Double Pole	15A–120/277V AC	Ivory	EA	1
ED1232	Double Pole	30A–120/277V AC	Brown	EA	1

\*\*Standard Grade

### Porcelain Outlet Box Lampholders\*

Features one-piece pull chain. Two screw terminals, 2 pole, 2 wire. 4-1/2" outer diameter. These lamp- holders fit 3-1/4" and 4" boxes. Rating: Lampholder: 660W/125V. Outlet: 15A/125V.



ED9726

CATALOG NO.	DESCRIPTION	UOM	ORDER MULTIPLE
ED9726	Porcelain Outlet Box Lampholder – U ground outlet	EA	1

### Fuse Holders

Used to mount and protect fuses, fuse holders also enable fuses to be changed quickly and easily. Fuse holders are used in a variety of applications, including consumer electronics, industrial, telecom and datacom, automotive, and many others.



EM480

EM484

CATALOG NO.	DESCRIPTION	UOM	ORDER MULTIPLE
EM480	In-Line Fuse Holder for use with 1-1/4 x 1/4" fuses up to 20 amps, 32 volts, 15" lead; 14 gauge red vinyl insulated wire	EA	1
EM484	Self-Stripping Fuse Holder mates with blade-type fuse .205 x .025". 18-14 AWG. Size: 1.37" L x .44" H x .95" W Max. Insulation Outer Diameter: .145"	EA	2

\*Items in this section are Underwriter's Laboratories listed or recognized under the prime manufacturer's name.



**WIRING DEVICES cont'd**

**Vinyl Grommet Assortment Packs**

These grommets exhibit high dielectric strength and are oil, ozone, and UV resistant.



CATALOG NO.	DESCRIPTION	UOM	ORDER MULTIPLE
<b>ED320</b>	General Assortment – contains all grommet sizes	EA	1

**Heat Shrink Tubing Assortments\***

Heat Shrink Tubing is made of flame-retardant polyolefin. Thin walled, all purpose tubing. Rated 600V, 125°C. 2500 volts/mil. dielectric strength. Inert to fungus. Virtually unaffected by corrosives, common fluids, and solvents. Pieces are 6" in length.



CATALOG NO.	COLOR	INNER DIAMETER		UOM	ORDER MULTIPLE
		MAX SUPPLIED	MIN. RECOVERED		
<b>6370</b>	Black & White, pack of 12	1/8", 1/4"	1/16", 1/8"	PK	1
<b>6371</b>	Black & White, pack of 7	1/8", 1/4", 3/8"	1/16", 1/8", 3/16"	PK	1
<b>63070</b>	Black, pack of 3	3/8" – 1/2"	3/16" – 1/4"	PK	1

**Indicator Lights**

Terminals are tin plated brass. Wire leads are 22 AWG, 4.4"–4.8" long, 1/2" stripped. Mounting will snap-fit into .500-.505 diameter hole in .020"-.100" thick panels.



CATALOG NO.	LENS COLOR	LENS MATERIAL	VOLTAGE	BULB TYPE	UOM	ORDER MULTIPLE
<b>ED600</b>	Red, pack of 2	Polycarbonate	28V	Incandescent	PK	1
<b>ED601</b>	Green, pack of 2	Polycarbonate	28V	Incandescent	PK	1
<b>ED602</b>	Amber, pack of 2	Polycarbonate	28V	Incandescent	PK	1
<b>ED603</b>	Blue, pack of 2	Polycarbonate	28V	Incandescent	PK	1
<b>ED610</b>	Red, pack of 2	Nylon	105–125V AC	Neon	PK	1
<b>ED611</b>	Green, pack of 2	Polycarbonate	105–125V AC	Neon**	PK	1
<b>ED612</b>	Amber, pack of 2	Nylon	105–125V AC	Neon	PK	1
<b>ED613</b>	Blue, pack of 2	Polycarbonate	105–125V AC	Neon†	PK	1
<b>ED620</b>	Red, pack of 2	Polycarbonate	208–250V AC	Neon	PK	1
<b>ED621</b>	Green, pack of 2	Polycarbonate	208–250V AC	Neon**	PK	1

**6190 Series Terminal Blocks\***

These terminal blocks are constructed of phenolic 9/16 in. centers. They are rated 30A 600V.



CATALOG NO.	DESCRIPTION	NO. OF POSITIONS	LENGTH (in.)	WIDTH (in.)	SCREW SIZE	MAX. WIRE SIZE	UOM	ORDER MULTIPLE
<b>6193</b>	Terminal Block	6	4.34	1.31	8-32	14-12	EA	1
<b>6194</b>	Terminal Block	8	5.47	1.31	8-32	14-12	EA	1
<b>6195X</b>	Terminal Block	10	6.59	1.31	8-32	14-12	EA	1

**Indicator Lights\***

Terminals are tin plated brass. Wire leads are 22 AWG, 4.4"–4.8" long, 1/2" stripped. .31" minimum diameter mounting.



CATALOG NO.	LENS COLOR	LENS MATERIAL	VOLTAGE	BULB TYPE	UOM	ORDER MULTIPLE
<b>ED710</b>	Red, pack of 2	Polycarbonate	105–125V AC	Neon	PK	1

**Winged Wire Connectors\***

Durable thermoplastic material. Flame retardant, abrasion resistant, non porous, and non corrosive. Expandable spring grips into the wire and adjusts itself to the wire size and shape so pre twisting is unnecessary. Even during temperature changes, they resist vibrations and retain holding power. Parts 8284 and 8286 are for use with copper to copper, aluminum to aluminum, and copper to aluminum (dry locations only).



CATALOG NO.	DESCRIPTION	UOM	ORDER MULTIPLE
<b>8284</b>	Small Yellow Winged Wire Connectors, pack of 18	PK	1
<b>8284CX-B</b>	Small Yellow Winged Wire Connectors, pack of 100	PK	1
<b>8286</b>	Medium Red Winged Wire Connectors, pack of 14	PK	1
<b>8286CX-B</b>	Medium Red Winged Wire Connectors, pack of 100	PK	1
<b>8282LX</b>	X-Large Blue Winged Wire Connectors, pack of 50	PK	1

\*-B indicates boxed product. All other catalog numbers are poly bagged.

\*Items in this section are Underwriter's Laboratories listed or recognized under the prime manufacturer's name.

### Standard Wire Connectors\*

Connectors are color coded with spring inserts. Heat resistant (105°C) thermoplastic. Connectors are for copper to copper connections. Parts 6294 and 6296 can connect aluminum to aluminum and copper to aluminum (dry locations only).

6292



CATALOG NO.	DESCRIPTION	UOM	ORDER MULTIPLE
6291	Mini Gray Standard Wire Connectors, pack of 29	PK	1
6291CX	Mini Gray Standard Wire Connectors, pack of 100	PK	1
6292	Tiny Blue Standard Wire Connectors, pack of 25	PK	1
6292CX	Tiny Blue Standard Wire Connectors, pack of 100	PK	1
6293	Small Orange Standard Wire Connectors, pack of 20	PK	1
6293CX	Small Orange Standard Wire Connectors, pack of 100	PK	1
6294	Medium Yellow Standard Wire Connectors, pack of 18	PK	1
6294CX	Medium Yellow Standard Wire Connectors, pack of 100	PK	1
6296	Large Red Standard Wire Connectors, pack of 12	PK	1
6296CX	Large Red Standard Wire Connectors, pack of 100	PK	1
6298	X-Large Gray Standard Wire Connectors, pack of 6	PK	1
6298LX	X-Large Gray Standard Wire Connectors, pack of 50	PK	1
6295X	Assortment: Includes 6291, 6292, 6293, 6294, 6296	EA	1

### Aluminum Solderless Lugs\*

Our aluminum solder less lug are made from high strength aluminum alloy. These lugs are suitable for use with either copper or aluminum conductors.



PI221

CATALOG NO.	DESCRIPTION	WIRE RANGE	AMP RATING	UOM	ORDER MULTIPLE
PI221	Small Lug for aluminum or copper wire, pack of 6	4-14	2	PK	1
PI222	Large Lug for aluminum or copper wire, pack of 6	2-14	2	PK	1

### Pigtails

The wire has a #10 spade on one end and a 10 32 x 3/8in. slotted round head screw on the other. This allows for easy positioning in the outlet box.

PI337-3



CATALOG NO.	DESCRIPTION	WIRE LENGTH	WIRE GAUGE	WIRE TYPE	UOM	ORDER MULTIPLE
PI337-3	Pigtails, pack of 5	8"	14	Stranded	PK	1

### Cable Markers

Cable markers come in books of 450 markers with matching terminal markers. Markers are mounted on dispenser cards in the book. Cable markers are suitable for above and below ground applications. Books are made of vinyl impregnated cloth that resists moderate amounts of dirt, oil and heat. The blank Write-On Markers (WM1014) are made of durable vinyl film that resists water, oils, and fungus. They can also withstand extremes in temperature.



WM1002

CATALOG NO.	DESCRIPTION	UOM	ORDER MULTIPLE
WM1002	Alpha-Numeric Cable Marker Book; contains 10 each: A-Z, 0-15, +, -, /	EA	1
WM1003	Numeric Cable Marker Book; contains 10 each: 1-45	EA	1
WM1009	Line and Terminal Cable Marker Book; contains 45 each: 1, 2, 3, A, B, C; contains 30 each: T1, T2, T3, L1, L2, L3	EA	1
WM1014	180 Blank Write-On Markers, 1/2" x 1-1/2"	EA	1

### Porcelain Wire Connectors\*

For high temperature applications over 105°C (300 volts maximum). For stranded copper connections only.

4293



CATALOG NO.	DESCRIPTION	UOM	ORDER MULTIPLE
4293	Small White Porcelain Wire Connectors, pack of 17	PK	1
4293CX	Small White Porcelain Wire Connectors, pack of 100	PK	1
4294	Medium White Porcelain Wire Connectors, pack of 15	PK	1
4294CX	Medium White Porcelain Wire Connectors, pack of 100	PK	1
4296	Large White Porcelain Wire Connectors, pack of 13	PK	1
4296CX	Large White Porcelain Wire Connectors, pack of 100	PK	1

### Electrolytic Copper Solderless Lugs\*

Our solder less lugs are manufactured from high strength pure electrolytic copper to insure both maximum strength and conductivity.

PI227



CATALOG NO.	DESCRIPTION	WIRE RANGE	AMP RATING	UOM	ORDER MULTIPLE
PI227	Medium Lug for copper wire, pack of 6	6-14	35-50	PK	1
PI228	Large Lug for copper wire, pack of 6	4-14	70	PK	1

### Split Bolt Connectors\*

These connectors are made of silicone bronze and are designed for copper use only.

PI327



CATALOG NO.	DESCRIPTION	MAX. SOLID WIRE	MAX. STRANDED WIRE	UOM	ORDER MULTIPLE
PI326	Split Bolt Connector, pack of 3	10	12	PK	1
PI327	Split Bolt Connector, pack of 3	8	8	PK	1
PI328	Split Bolt Connector, pack of 3	6	7	PK	1
PI929	Split Bolt Connector, pack of 3	4	5	PK	1

### Ground Fitting Clamp\*

A ground fitting clamp is ideal for surface mounting small amounts of electrical wiring or communication cables.

PI237



CATALOG NO.	DESCRIPTION	UOM	ORDER MULTIPLE
PI237	For 8, 6, 4 bare grounding wire; fits 1/2"-1" pipe	EA	1

\*Items in this section are Underwriter's Laboratories listed or recognized under the prime manufacturer's name.

\*\*Neon bulb incorporates G2B lamp and resistor.

\* Neon bulb incorporates T2B lamp and resistor.



# ELECTRICAL

Capacitors.....	156-157
Conduit, Fittings, Cable .....	154-155
Contactors.....	159-160
DiversiTech Electrical Disconnects.....	153
Eaton Electrical Disconnects.....	154
Electrical Supplies .....	165-168
Electrical Tapes.....	169-170
Fan Centers.....	162
Fuses .....	162-163
Hard Start Kits .....	159
Monitors.....	164
Motor Brackets .....	152
Motor Run Capacitors (USA Made).....	158
Motors .....	144-152
Relays.....	161
Stranded Copper THHN Wire.....	175
Terminals, Connectors.....	170-171
Thermal Controls .....	172
Thermostat Guards .....	173
Thermostat Wire .....	174
Thermostats .....	173
Time Delays .....	164
Transformers .....	161
Whips .....	152-153
Wire Connectors.....	176
Wire/Cable Ties, Mounts, Clamps .....	177-178



# A/C Disconnect Switches

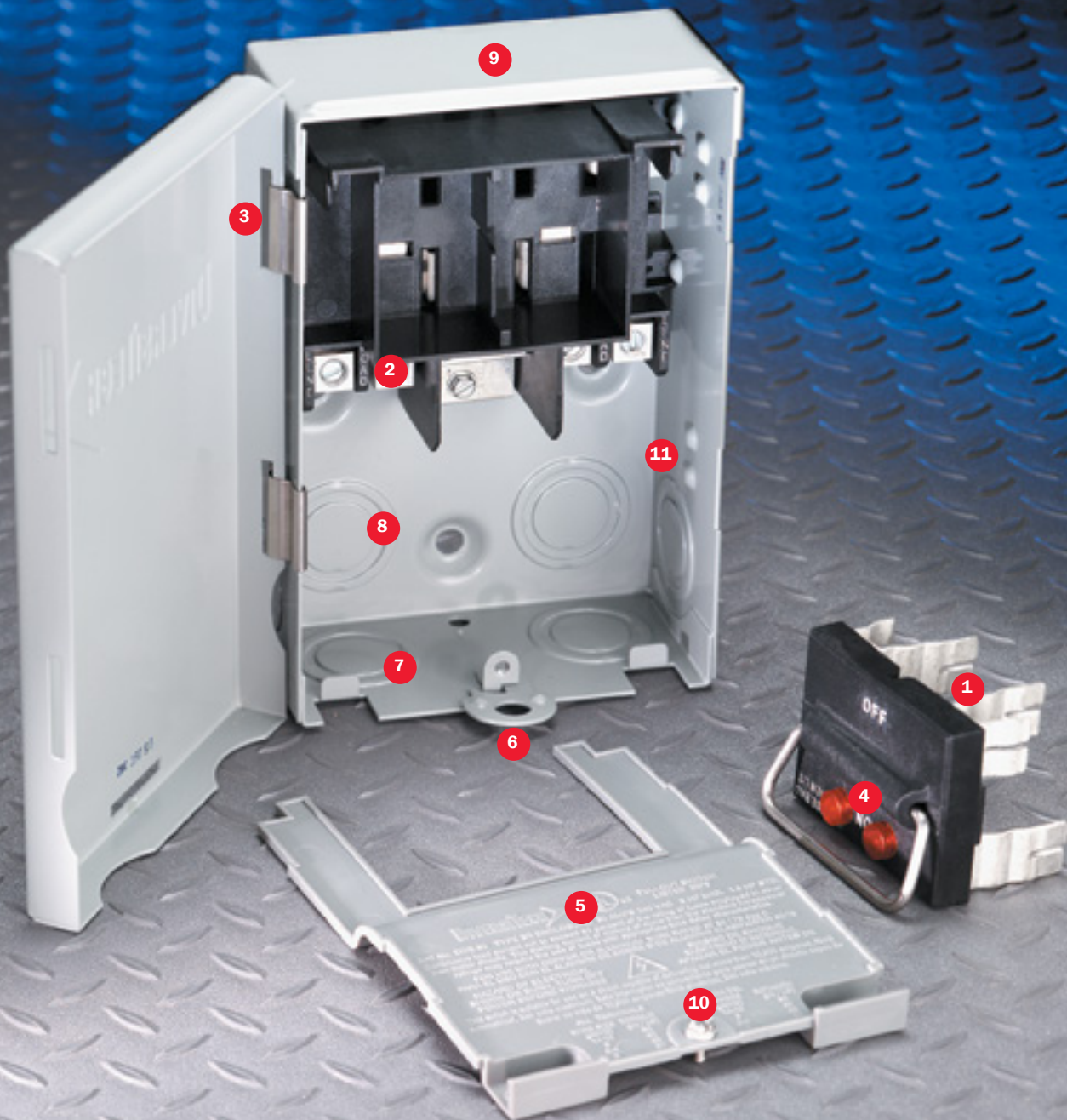



## A/C DISCONNECT FEATURES AND BENEFITS

- 1 Fuses install into pull-out handle
- 2 Line, load, and ground terminals aligned for easy hook up with heavy wires
- 3 Reversible side-opening door
- 4 Indicator lights for blown fuses
- 5 Full dead front
- 6 Folding pivot locking tab
- 7 Knockouts accommodate three sizes (1/2", 3/4", and 1")
- 8 Rear entry knockouts
- 9 Heavy gauge steel case
- 10 Standard 1/4" head screw on dead front
- 11 Large internal wiring space



### FUSES INSTALL INTO PULL-OUT HANDLE

The DiversiTech disconnect switch is available in two versions – fusible and non-fusible. On the fusible configuration, the pull-out handle also functions as a removable fuse holder. This feature permits easy removal and replacement of fuses. Rather than requiring a fuse puller to reach inside the disconnect switch and remove the blown fuses, one can easily change the fuses with the fuse holder removed from the disconnect switch.

### INDICATOR LIGHT FOR BLOWN FUSE

The fusible disconnect switch has an indicator light for fuse condition. When a fuse is blown, the red indicator light illuminates to show not only that a fuse is bad, but specifically, which fuse needs replacement. This feature provides rapid troubleshooting for the contractor inspecting an installation. One can tell instantly (visually) whether a fuse is bad.



### MOUNTING AND INLINE WIRING

A unique feature to the DiversiTech disconnect switch is the design of wiring terminals inline. This straight-line arrangement provides for quick and easy wire connection — no need to cut the connection wires to different lengths. All wires are easily installed without unnecessary bending or twisting.

### REVERSIBLE SIDE OPENING DOOR

The unique reversible side opening door provides for easy field change from left-hand hinge to right-hand hinge. The standard left-hand hinge is adequate for most all installations except for tight, inside, right-hand corners. In these instances, simply remove the two stainless steel hinge clips and move them to the right-hand side. This permits the door to hinge on the right.



# Fractional Horsepower Motors

## FEATURES AND BENEFITS



**COLOR PACKAGING**

Bright, colorful, easy to read packaging removes confusion about motors. The distributor can easily identify the stock of motors on the shelf. The application, voltage, and horsepower of a motor are visible at a glance.



**CARTON HANDLE**

The motor carton has been designed with an innovative handle to make the motors much easier to carry.



**CAPACITOR SIZE**

The appropriate size 370 VAC run capacitor is noted on every motor carton.



**LARGER DIAGRAM**

An extra large wiring diagram is supplied on the motor itself, on the motor carton, and also in the installation and safety instruction sheet. This large wiring diagram makes it very easy to read.

CROSS REFERENCE GUIDE		
WGS40728		
208-230 VAC	1/4 hp	
MARS	03728	
PACKARD	83128	
GEMLINE	EM3728	
MARATHON	X213	
AO SMITH	F8E1028S	
FASCO	D609	

**CROSS REFERENCE**

For your convenience, Wagner provides a complete manufacturer cross-reference on the side of every motor carton.



**EXTENDED BOLTS**

Extended mounting bolts provide for easier installation in cramped spaces. With the longer bolts, the installer is able to more easily start the threaded mounting nut.



**BALL BEARINGS**

Ball bearing design improves motor performance and reliability. It also increases heat endurance and motor life. Now standard on Condenser Fan Motor models.



**REVERSING PLUG**

The electrical reversing plug simplifies rotation direction changes.



**Wagner Motors are available in many different versions to meet motor application needs.**

- Direct Drive Furnace Blower Motors
- Multiple Horsepower Motors
- Condenser Fan Motors
- High Temperature Condenser Fan Motors



**All Wagner Motors have a 2 year warranty.**

## MULTIPLE HORSEPOWER MOTORS

Multiple horsepower motors allow the contractor and distributor to consolidate multiple part codes into a single stocking unit. The multiple horsepower motor allows the contractor to carry one motor that can be used as a replacement for a wide variety of OEM and other replacement motors, saving time and money.



- All the features and benefits of standard motors
- Plus multiple horsepower
- Variety of voltages, applications, and speeds are available.



# Evergreen<sup>®</sup>

EVER EFFICIENT. EVER RELIABLE. EVER PROFITABLE.



 genteq<sup>®</sup>

**Upgrade/Replace Indoor PSC Blower motors with Evergreen® IM**



RESIDENTIAL/LIGHT COMMERCIAL HVAC SYSTEMS

- Reduce truck stock
- Increase energy savings
- Increase comfort and home health
- Decrease continuous fan noise and power consumption
- Easy drop-in replacement - connects directly to fan boards or relays
- Two year warranty

**FURNACE AIR HANDLERS**  
INCLUDES PACKAGE SYSTEMS

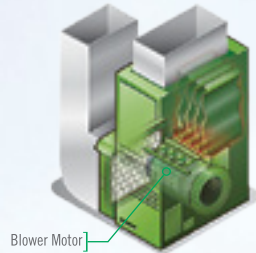

**Evergreen® IM**

Replace Permanent Split Capacitor (PSC), direct drive, induction motors with the following ratings:

- Horsepower: 1/4-1
- RPM Rating: 1075
- Voltage: 120 & 208-230
- Rotation: CW & CCW

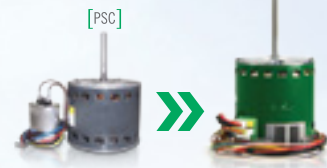

**Replace OEM ECM X13 motors with Evergreen® EM**



RESIDENTIAL/LIGHT COMMERCIAL HVAC SYSTEMS

- Replaces X13 and similar Constant Torque ECM
- Maintains system efficiency and performance
- Compatible with OEM harness
- Pre-programmed for truck stock
- No complex wiring or configuration
- Two year warranty

**FURNACE AIR HANDLERS**  
INCLUDES PACKAGE SYSTEMS

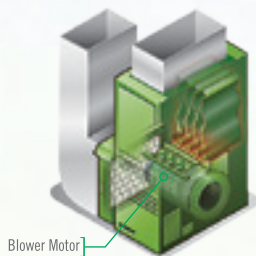

**Evergreen® EM**

Replaces OEM Constant Torque ECM built with 24v speed taps with the following ratings:

- Horsepower: 1/3-1
- RPM Rating: 1070
- Voltage: 115 or 208-230
- Rotation: CW & CCW

[Constant Torque ECM Genteq X13 or Similar Competitors' Models]



**Upgrade/Replace PSC Outdoor Fan motors with Evergreen® OM**



- Drop-in replacement for induction motors
- Easy Retrofit - line voltage connections
- Quiet start and operation
- Dual rotation (CW/CCW)
- Efficiency up to 80%
- Two year warranty

**A/C & HEAT PUMP UNITS**  
INCLUDES PACKAGE SYSTEMS

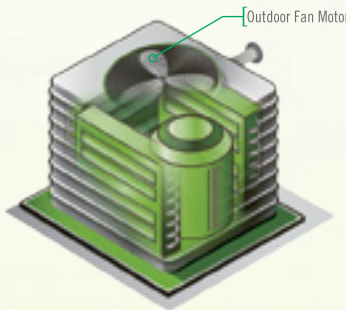

**Evergreen® OM**

[PSC]



# Digital 3-Phase Line Voltage Monitor

The DTP-3 is an automatic digital voltage monitor and control system.

By continuously measuring the incoming line voltage, the DTP-3 monitor will detect voltages outside of the tolerance that you set.

If these limits are exceeded, the response timer is started. This timer may be set to a long time value to avoid nuisance tripping, or to a short time value to offer a higher level of load protection.

If the voltage remains outside of the selected tolerance after the time has elapsed, the DTP-3 will turn off its output relay and protect your device. While the load is off, an additional lockout timer is activated to avoid rapid restarts.

- Read Line and Load Side Voltage Instantly
- Simple Three Button Access for Easy Monitoring and Set-Up
- Fault Memory Records Problems for Later Display
- Six Digital Voltmeters Built In
- Sequential Start Timer Built In
- Lock Out Timer Built In
- Response Timer Built In

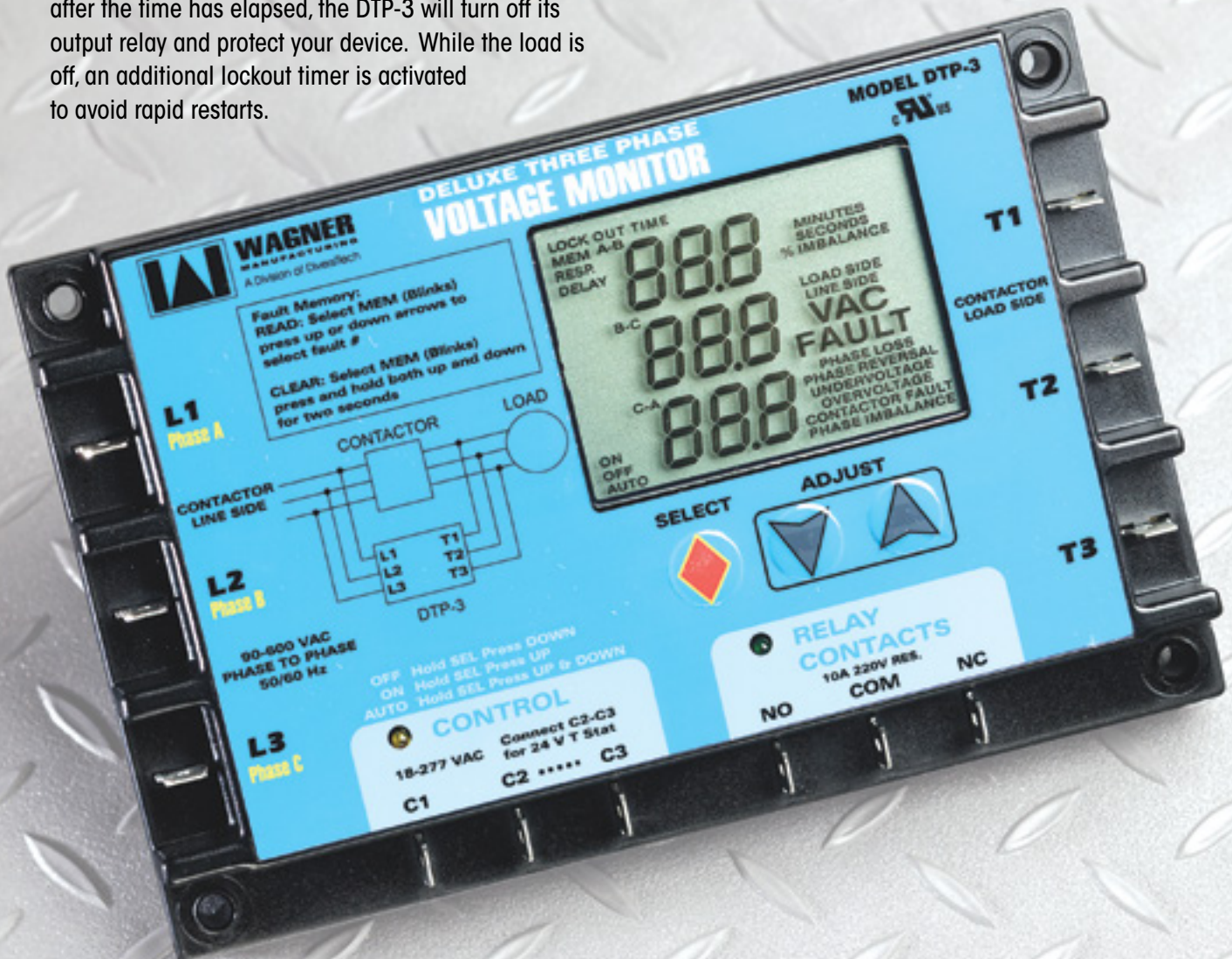

## FEATURES AND BENEFITS

### Large Digital LCD Display

Provides instant display of the system's operating voltage, not just indicator lights. System setup is simplified by using the display to set the exact voltage range you want to monitor. Other controls use dials for system adjustment that can lead to inaccurate settings and motor burnout.

### Super Simple Operation

Just three buttons set up everything. Easy adjustment of voltage tolerance and timers.

### Small Size

Small footprint and low profile fits where other can't.

### 10 Amp Rated Output Relay with Isolated Contacts

Powerful relay can connect to just about any control circuit. Normally-Open and Normally-Closed contacts are provided for connection to any type of system, motor control or alarm.

### 2 LED Indicators

Glowing light-emitting-diodes show applied control voltage and output relay operation at a glance.

### Precision Digital Circuitry

Completely eliminates the ambiguity associated with analog controls and screwdriver adjustments.

### Adjustable Response Time

This timer sets the amount of time between when a voltage outside of the selected tolerance is detected and when the output relay is de-energized. Setting low time values offers faster protection. Setting longer times provides greater resistance to nuisance tripping.

### Adjustable Delay Time

This timer sets the amount of time before the protected system is allowed to restart. Typically this timer is set to a value which allows the protected system to bleed-off high pressures or to cool down to a safe value for restarting.

### Broad Voltage Adjustment Range

User adjustable monitored voltage range from 160 to 650 VAC. This broad adjustment range incorporates voltages for the majority of compressor installation requirements. Therefore, this single unit can be used across a broad range of installations.

## DTP-3 FACTS

### Protection

Loss of Phase, Phase Reversal, Voltage Imbalance, Low Voltage, High Voltage.

### Display

Large custom LCD indicates all operating conditions at a glance. Three large sets of digits provide easy system troubleshooting.

### Voltmeter

Simultaneous display of all three line voltage pairs. One button switches to contactor load side voltage reading.

### Input Voltage Range

90 – 650 VAC at 50 or 60 hertz.

### Voltage Trip Point

Adjustable in 1 percent increments between 6% and 18% of the selected operating voltage. Restart voltage set point fixed at +3%.

### Voltage Symmetry

Adjustable imbalance set point from 2% to 25% of selected operating voltage.

### Lockout Delay Timer

Fully adjustable 0 to 720 seconds (0 to 12 minutes). Digital display shows remaining time and user set points.

### Sequential Start Timer

0 – 30 seconds in 1 second increments.

### Response Timer

0.1 to 20 seconds digital display shows remaining time and user set points.

### Memory

Up to 25 previous fault conditions are recorded for display as desired.

# Monitor Digital Trifasico de Linea de Voltaje

El DTP-3 es un monitor de voltaje y sistema de control automático digital.

Por estar midiendo continuamente la entrada de la línea de voltaje, este monitor detectará voltajes fuera de la tolerancia que se fijó.

Si este limite es excedido arrancará el Regulador de respuesta. Este regulador podrá ser fijado a una mayor escala de tiempo para evitar el ruido molesto del corte y arranque, o a una escala menor de tiempo para ofrecer un mayor nivel de protección de carga.

Si el voltaje permanece fuera de la tolerancia seleccionada después que el tiempo ha transcurrido, el DTP-3 apagará su relevador de rendimiento y protegerá su aparato. Mientras la carga esta apagada un regulador de cierre adicional es activado para evitar arranques inmediatos.

- Lectura de línea y de la carga de voltaje instantáneamente
- Tres simples botones de acceso para fácil monitoreo e instalación
- Registro de problemas en falla de memoria para posterior exhibición
- Seis volfímetros digitales integrados
- Regulador de arranque secuencial integrado
- Regulador de cierre integrado
- Regulador de respuesta integrado

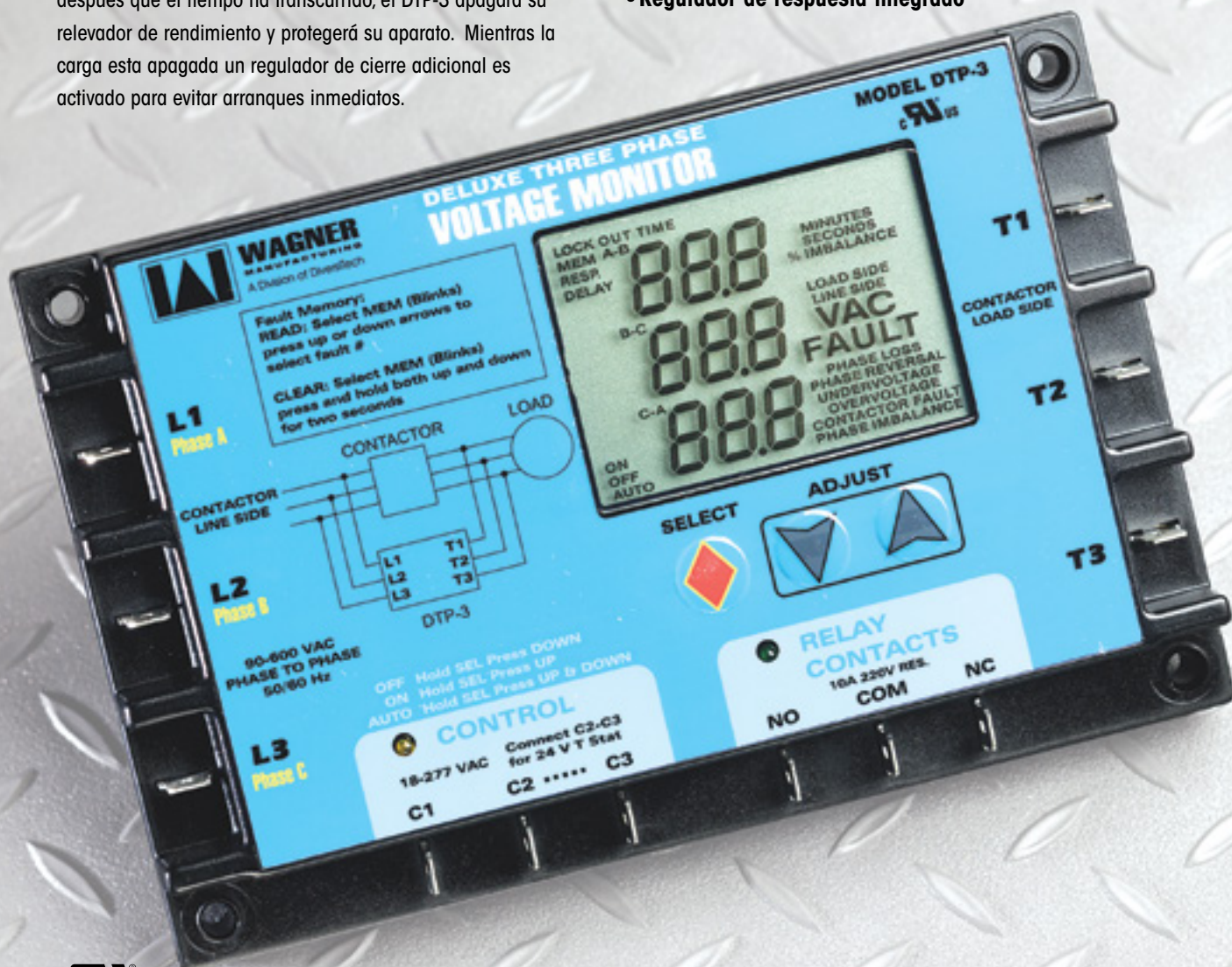



## DTP-3 CARACTERISTICAS Y BENEFICIOS

### La gran pantalla digital LCD

suministra al instante la operación del sistema de voltaje no solo luces indicadoras. El sistema programable es simplificado por usar la pantalla para fijar el rango exacto de voltaje que quiera monitorear. Otros controles usan botones para ajustar el sistema, que pueden dirigir hacia una programación inexacta y falla de motor.

### Operación super simple

solo tres botones operan todo. Fácil ajuste de tolerancia de voltaje y reguladores de tiempo.

### Pequeña medida

y su práctico contorno el cual se ajusta donde otros no pueden.

### Relevador de salida de 10 amps con contactos aislados

Relevador de poder que puede conectarse con cualquier circuito de control. Normalmente-Abierto y Normalmente-Cerrado contactos son suministrados para conectarse a cualquier tipo de sistema, control de motor o alarma.

### 2 indicadores LED

muestran el voltaje de control aplicado y la operación del relevador de salida en un solo vistazo.

### Los circuitos de precisión digital

eliminan completamente la ambigüedad asociada con controles análogos y ajustes de desarmador.

### Regulador de respuesta ajustable

Este regulador fija la cantidad de tiempo cuando un voltaje externo de la tolerancia seleccionada es detectado y cuando el relevador de salida es de-energizado. El fijar valores de tiempo bajos ofrece una más rápida protección. El fijar un tiempo prolongado suministra gran resistencia evitando el ruido molesto del corte y arranque.

### Regulador retardador de tiempo ajustable

Este regulador fija la cantidad de tiempo antes que al sistema de protección se le permita re-iniciar. Típicamente este regulador es fijado a un valor el cual permita al sistema de protección descargar altas presiones o que se enfríe a un valor seguro para re-iniciar.

### Amplio ajuste del rango de voltaje

El usuario monitorea el rango ajustable del voltaje de 160 a 650 VAC. Este amplio rango de ajuste incorpora voltajes para la mayoría de los requerimientos de instalación de compresores. Así mismo, esta unidad puede ser usada a través de un rango amplio de instalaciones.

## DTP-3 HECHOS

### Proteccion

Pérdida de fase, cambio de fase, desequilibrio de voltaje, bajo voltaje, alto voltaje.

### Pantalla

Los LCD hechos a la medida indican todas las condiciones de operación en un vistazo. Tres juegos grandes de dígitos suministran fácilmente los problemas del sistema.

### Voltimetro

Pantalla simultanea de las tres líneas pares de voltaje. Un botón cambia al contactor para la lectura de la carga de voltaje.

### Suministro de voltaje

90-650 VAC a 50 o 60 hertz.

### Margen de error del voltaje

Ajustable en un porcentaje de entre 6% y 18% de la operación del voltaje seleccionado. Re-inicio con un +3% del voltaje establecido.

### Simetria del voltaje

Desequilibrio ajustable establecido de 2% a 25% de la operación del voltaje seleccionado.

### Regulador retardador de cierre

Completamente ajustable de 0 a 720 segundos (0 a 12 minutos) la pantalla digital muestra el tiempo restante y los puntos establecidos por el usuario.

### Arrancador secuencial de tiempo

0 – 30 segundos en incrementos de 1 segundo.

### Regulador de respuesta

0.1 a 20 segundos la pantalla digital muestra el tiempo restante y los puntos establecidos por el usuario.

### Memoria

Hasta 25 condiciones de falla previas son almacenadas para mostrarse según se requiera.

**MOTORS**

**Wagner® Single Speed Condenser Fan Motors**

- Installs with all Standard 48 Frame Mounting Brackets
- Standard Shaft Length, Diameter, and Flats
- Drain Holes with Plugs in both end plates
- Automatic Thermal Overload Protector
- Standard 48 Frame Motor Casing Size
- Low Power Consumption
- 60 C Ambient Design
- Electrically Reversible
- Continuous Air Over
- Class B Insulation
- Quiet Operation
- Extended Studs
- 30" Leads
- 60 HZ



**BALL BEARINGS NOW STANDARD**



CATALOG NO.	HP	VOLTAGE	SPEED	FLA	UOM	ORDER MULTIPLE
WG840727	1/6	208-230	1075/1	1.3	EA	1
WG840728	1/4	208-230	1075/1	2.2	EA	1
WG840729	1/3	208-230	1075/1	2.8	EA	1
WG840730	1/2	208-230	1075/1	4.2	EA	1
WG840731	3/4	208-230	1075/1	4.5	EA	1
WG840203	1/6	208-230	825/1	1.3	EA	1
WG840204	1/4	208-230	825/1	1.5	EA	1
WG840205	1/3	208-230	825/1	2.2	EA	1
WG840746	1/2	208-230	825/1	2.9	EA	1

**Wagner® High Temperature Condenser Fan Motors**

- 70°C Ambient Temperature
- Installs with all Standard 48 Frame Mounting Brackets
- Standard Shaft Length, Diameter, and Flats
- Drain Holes with Plugs in both end plates
- Automatic Thermal Overload Protector
- Standard 48 Frame Motor Casing Size
- Low Power Consumption
- Electrically Reversible
- Continuous Air Over
- Class B Insulation
- Quiet Operation
- Extended Studs
- 30" Leads
- 60 HZ



**BALL BEARINGS NOW STANDARD**



CATALOG NO.	HP	VOLTAGE	SPEED	FLA	UOM	ORDER MULTIPLE
WG840727HT	1/6	208-230	1075/1	1.3	EA	1
WG840728HT	1/4	208-230	1075/1	2.2	EA	1
WG840729HT	1/3	208-230	1075/1	2.8	EA	1
WG840730HT	1/2	208-230	1075/1	4.2	EA	1
WG840731HT	3/4	208-230	1075/1	5.3	EA	1
WG840736HT	1/4	460	1075/1	1.65	EA	1
WG840737HT	1/3	460	1075/1	2.85	EA	1
WG840738HT	1/2	460	1075/1	4.3	EA	1
WG840739HT	3/4	460	1075/1	5.3	EA	1
WG840203HT	1/6	208-230	825/1	1.3	EA	1
WG840204HT	1/4	208-230	825/1	1.5	EA	1
WG840205HT	1/3	208-230	825/1	2.2	EA	1
WG840746HT	1/2	208-230	825/1	2.9	EA	1

**Wagner® Multiple Horsepower Condenser Fan Motors**

The Multi-Horsepower motors are specially designed to cover a range of applications. The condenser fan motors range from 1/2 to 1/5; 1/3 to 1/6 both at 1075 rpm; 1/3 to 1/6 at 825rpm. These motors feature reversing plugs, extended thru bolts 36 inch leads and are designed for 370 volt capacitors. Installs with all 48 frame mounting brackets.



**BALL BEARINGS NOW STANDARD**



CATALOG NO.	APPLICATION	VOLTAGE	SPEED	(1) HP-FLA	(2) HP-FLA	(3) HP-FLA	(4) HP-FLA	(5) HP-FLA	UOM	ORDER MULTIPLE
WG840458	CF	208-230	1075/1	1/3-2.8	1/4-1.8	1/5-1.7	1/6-1.6	-	EA	1
WG840459	CF	208-230	1075/2	1/3-2.1	1/4-1.55	1/5-1.4	1/6-1.34	1/8-1.3	EA	1
WG840465	CF	208-230	1075/2	1/3-2.8	1/4-2.0	1/5-1.7	1/6-1.5	-	EA	1
WG840468	CF	208-230	1075/2	1/2-3.0	1/3-2.5	1/4-2.0	1/5-1.3	-	EA	1
WG840469	CF	208-230	825/2	1/3-2.1	1/4-1.7	1/5-1.5	1/6-1.2	-	EA	1

## Wagner® High Temperature Multiple Horsepower Condenser Fan Motors

The Multi-Horsepower motors are specially designed to cover a range of applications. The condenser fan motors range from 1/2 to 1/5; 1/3 to 1/6 both at 1075 rpm; 1/3 to 1/6 at 825rpm. These motors feature reversing plugs, extended thru bolts, 36 inch leads and are designed for 370 volt capacitors. Installs with all 48 frame mounting brackets.



**BALL BEARINGS  
NOW STANDARD**



CATALOG NO.	APPLICATION	VOLTAGE	SPEED	(1) HP-FLA	(2) HP-FLA	(3) HP-FLA	(4) HP-FLA	(5) HP-FLA	UOM	ORDER MULTIPLE
<b>WG840465HT</b>	CF	208-230	1075/2	1/3-2.8	1/4-2.0	1/5-1.7	1/6-1.5	-	EA	1
<b>WG840469HT</b>	CF	208-230	825/2	1/3-1.9	1/4-1.7	1/5-1.5	1/6-1.2	-	EA	1
<b>WG840468HT</b>	CF	208-230	1075/2	1/2-3.8	1/3-2.5	1/4-2.0	1/5-1.5	-	EA	1
<b>WG840459HT</b>	CF	208-230	825/1	1/3-2.1	1/4-1.55	1/5-1.4	1/6-1.34	1/8-1.3	EA	1
<b>WG840458HT</b>	CF	208-230	1075/1	1/3-2.8	1/4-1.8	1/5-1.7	1/6-1.6	-	EA	1
<b>WG840884HT</b>	CF	460	825/1	1/3-1.1	1/4-0.82	1/5-0.72	1/6-0.7	1/8-0.68	EA	1

## Wagner® Direct Drive Furnace Blower Motors

- Installs with all Standard 48 Frame Mounting Brackets
- Standard Shaft Length, Diameter, and Flats
- Uses 370V Capacitors
- Standard 48 Frame Motor Casing Size
- 2.5" Diameter Hub Rings included
- Low Power Consumption
- Automatic Thermal Overload Protector
- Continuous Duty, Air Over
- Electrically Reversible
- Class B Insulation
- Speed: 1075/3
- Quiet Operation
- 60 HZ

CATALOG NO.	HP	VOLTAGE	SPEED	FLA	UOM	ORDER MULTIPLE
<b>WG840583</b>	1/4	115	1075/3	4.2	EA	1
<b>WG840584</b>	1/4	208-230	1075/3	2.0	EA	1
<b>WG840585</b>	1/3	115	1075/3	5.5	EA	1
<b>WG840586</b>	1/3	208-230	1075/3	2.8	EA	1
<b>WG840587</b>	1/2	115	1075/3	7.5	EA	1
<b>WG840588</b>	1/2	208-230	1075/3	3.6	EA	1
<b>WG840589</b>	3/4	115	1075/3	10.2	EA	1
<b>WG840590</b>	3/4	208-230	1075/3	5.5	EA	1
<b>WG840595</b>	1	115	1075/3	12.6	EA	1
<b>WG840596</b>	1	208-230	1075/3	5.59	EA	1

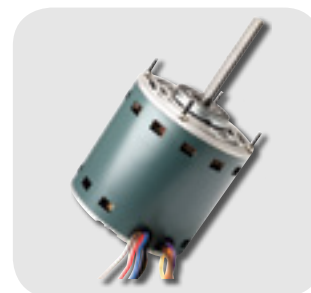

## Wagner® Multiple Horsepower Furnace Blower Motors

The Multi-Horsepower motors are specially designed to cover a range of applications. The direct drive furnace blower motors range from 1/2 to 1/6 in both 115 and 230 volts and 3/4 to 1/5 in both 115 and 230 volts all at 1075rpm. These motors feature reversing plugs, extended thru bolts 36 inch leads and are designed for 370 volt capacitors. Installs with all 48 frame mounting brackets.

CATALOG NO.	APPLICATION	VOLTAGE	SPEED	(1) HP-FLA	(2) HP-FLA	(3) HP-FLA	(4) HP-FLA	(5) HP-FLA	UOM	ORDER MULTIPLE
<b>WG840463</b>	DDFB	115	1075/4	1/2-7.0	1/3-6.7	1/4-4.4	1/5-3.2	1/6-2.4	EA	1
<b>WG840464</b>	DDFB	208-230	1075/4	1/2-3.9	1/3-3.6	1/4-2.5	1/5-1.8	1/6-1.3	EA	1
<b>WG840466</b>	DDFB	115	1075/4	3/4-8.1	1/2-6.6	1/3-4.6	1/4-3.8	1/5-3.1	EA	1
<b>WG840467</b>	DDFB	208-230	1075/4	3/4-3.8	1/2-3.7	1/3-2.5	1/4-1.8	1/5-1.7	EA	1

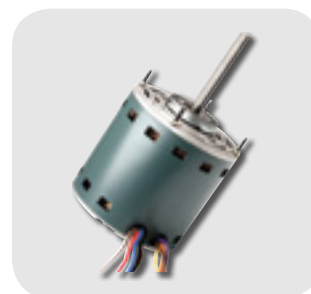

**MOTORS** cont'd

**Evergreen® CM ECM Motors**

The Evergreen CM is made with the same field-proven, high-efficiency ECM technology that has been used for more than 20 years in new HVAC equipment. It features flexible control methods to help the installer balance airflow in HVAC systems such as VAV (Variable Air Volume) boxes and Packaged HVAC systems. The Evergreen CM is designed as a direct replacement for OEM (Original Equipment Manufacturer) Genteq model X13 (Constant Torque ECM) or as a field replacement for existing PSC (Permanent Split Capacitor) motors.

CATALOG NO.	HP	VOLTAGE	SPEED	FLA	RPM	SHAFT	UOM	ORDER MULTIPLE
<b>6703CM</b>	1/3	208-230/277	5/PWM	2.8	1075	.5"X4" (3.5" SF)	EA	1
<b>6705CM</b>	1/2	208-230/277	5/PWM	4.1	1075	.5"X4" (3.5" SF)	EA	1
<b>6707CM</b>	3/4	208-230/277	5/PWM	6.0	1075	.5"X4" (3.5" SF)	EA	1
<b>6710CM</b>	1	208-230/277	5/PWM	7.6	1075	.5"X4" (3.5" SF)	EA	1
<b>6405CM</b>	1/2	460	5/PWM	2.1	1075	.5"X4" (3.5" SF)	EA	1
<b>6407CM</b>	3/4	460	5/PWM	3.2	1075	.5"X4" (3.5" SF)	EA	1
<b>6410CM</b>	1	460	5/PWM	4.0	1075	.5"X4" (3.5" SF)	EA	1

6703CM



**Evergreen® EM ECM Motors**

The Evergreen EM was designed to replace direct-drive blower motors in residential and light commercial indoor furnaces, air handlers and package systems that were designed with a standard ECM motor, such as X13 or equivalent competitor model. It can also be used to retrofit PSC motors in commercial building series VAV boxes and packaged heat pump systems. It is NOT intended to replace premium ECM constant airflow products, such as EON, 2.3, 3.0 and 2.5.

CATALOG NO.	HP	VOLTAGE	SPEED	FLA	RPM	SHAFT	UOM	ORDER MULTIPLE
<b>6103E</b>	1/3	115	5/PWM	4.8	1075	.5" X 5" (4.5" SF)	EA	1
<b>6105E</b>	1/2	115	5/PWM	6.8	1075	.5" X 5" (4.5" SF)	EA	1
<b>6107E</b>	3/4	115	5/PWM	8.4	1075	.5" X 5" (4.5" SF))	EA	1
<b>6110E</b>	1	115	5/PWM	10.9	1075	.5" X 5" (4.5" SF)	EA	1
<b>6203E</b>	1/3	208/230	5/PWM	2.8	1075	.5" X 5" (4.5" SF)	EA	1
<b>6205E</b>	1/2	208/230	5/PWM	4.1	1075	.5" X 5" (4.5" SF)	EA	1
<b>6207E</b>	3/4	208/230	5/PWM	6.0	1075	.5" X 5" (4.5" SF)	EA	1
<b>6210E</b>	1	208/230	5/PWM	7.6	1075	.5" X 5" (4.5" SF)	EA	1

6103E



**Evergreen® IM ECM Motors**

The Evergreen IM is an ECM designed to replace an existing PSC (Permanent Split Capacitor), direct drive, indoor blower motor. It is constructed with more than 20 years of proven ECM technology and reliability.

CATALOG NO.	HP	VOLTAGE	SPEED	FLA	RPM	SHAFT	UOM	ORDER MULTIPLE
<b>6005</b>	1/2 (1/2, 1/3, 1/4)	115/230	5	6.7/4.0	1075	.5" X 5" (4.5" SF)	EA	1
<b>6010</b>	1 (1, 3/4, 1/2)	115/230	5	11.0/6.7	1075	.5" X 5" (4.5" SF)	EA	1

6005



**Evergreen® OM ECM Motors**

The Evergreen Outdoor Motor, also known as Evergreen OM, is designed for direct-drive fan propeller applications in residential systems up to 5-tons. Easily replaces 6 Pole (1,100 rpm rated) and 8 pole (850 rpm rated) shaded pole or PSC motors.

CATALOG NO.	HP	VOLTAGE	SPEED	FLA	RPM	SHAFT	UOM	ORDER MULTIPLE
<b>6301</b>	1/5	208-240	2	2.8	850/1100	.5" X 3" (2.5" SF)	EA	1
<b>6303</b>	1/3	208-240	2	3.5	850/1100	.5" X 3" (2.5" SF)	EA	1
<b>6903</b>	1/3	460	2/PWM	1.6	850/1100	.5" X 6" (5.5" SF)	EA	1
<b>6905</b>	1/2	460	2/PWM	2.5	850/1100	.5" X 6" (5.5" SF)	EA	1
<b>6907</b>	3/4	460	2/PWM	3.1	850/1100	.5" X 6" (5.5" SF)	EA	1

6301



**MOTORS** cont'd

**Evergreen® PF ECM Motors**

The Evergreen PF is a drop-in replacement or proactive upgrade for pedestal and wall mount fan motors in warehouses, factory floors, amusement parks, institutional buildings and other similar applications. With a rated efficiency of up to 82% and three operating speeds, Evergreen PF makes it easy to provide energy savings and reduce operating noise. It is easy for retrofit as it comes with a power cord, switch and welded mount. The Evergreen PF also includes a pull chain for easy speed selection from 1160/970/650 operating speeds.

CATALOG NO.	HP	VOLTAGE	SPEED	FLA	RPM	SHAFT	UOM	ORDER MULTIPLE
<b>6803</b>	1/3	115	3	5.8	1160/970/650	.5" X 3" (2.5" SF)	EA	1



**Evergreen® InTune™ Programmer for ECM Motors**

InTune is two components - a WIFI programmer (catalog #5K006) that connects in series with the motors existing connections and a free app. The WIFI programmer is purchased once and re-used on each motor during the tuning process. Free apps are available at the App Store and Google Play.

CATALOG NO.	Description	UOM	ORDER MULTIPLE
<b>5K006</b>	Evergreen InTune™ WIFI Programmer	EA	1



**Genteq® Single Speed Condenser Fan Motors**

- Standard 48 frame size
- Single speed with reversible rotation
- Designed for 370V capacitors with mounting holes
- 26" motor leads
- 6" shaft extension
- Automatic thermal overload protection

CATALOG NO.	HP	VOLTAGE	SPEED	FLA	UOM	ORDER MULTIPLE
<b>3727</b>	1/6	208/230	1075/1	1.0	EA	1
<b>3728</b>	1/4	208/230	1075/1	1.8	EA	1
<b>3729</b>	1/3	208/230	1075/1	2.3	EA	1
<b>3730</b>	1/2	208/230	1075/1	3.5	EA	1
<b>3731</b>	3/4	208/230	1075/1	4.7	EA	1
<b>3202*</b>	1/8	208/230	825/1	0.9	EA	1
<b>3203*</b>	1/6	208/230	825/1	1.0	EA	1
<b>3205*</b>	1/3	208/230	825/1	1.9	EA	1
<b>3746</b>	1/2	208/230	825/1	3.4	EA	1

\*Ball Bearing



**Genteq® Multiple Horsepower Condenser Fan Motors**

- Standard 48 frame size
- One or two speeds with reversible rotation
- Extended clamp screws and resilient rings with Rheem mounting holes
- Hardware included
- Water slinger on shaft
- Automatic thermal overload protection
- Ball Bearing

CATALOG NO.	HP	VOLTAGE	SPEED	FLA	UOM	ORDER MULTIPLE
<b>3458</b>	1/3-1/6	208/230	1075/1	2.7	EA	1
<b>3459</b>	1/3-1/8	208/230	825/1	1.9	EA	1
<b>3465</b>	1/3-1/6	208/230	1075/2	6.2	EA	1
<b>3468</b>	1/3-1/6	208/230	1075/2	4.2	EA	1
<b>3469</b>	1/2-1/5	208/230	825/2	8.4	EA	1



### Genteq® High Temperature Condenser Fan Motors

- Standard 48 frame size
- Designed for 70°C ambient operation
- 48" motor leads
- Extended thru bolts on both ends
- Drain holes in both endshields with plug
- Automatic thermal overload protection
- Ball Bearing

CATALOG NO.	HP	VOLTAGE	SPEED	FLA	UOM	ORDER MULTIPLE
3726HS	1/6	208/230	1075/1	1.0	EA	1
3732HS	1/4	208/230	1075/1	1.7	EA	1
3733HS	1/3	208/230	1075/1	2.6	EA	1
3734HS	1/2	208/230	1075/1	3.0	EA	1
3735HS	3/4	208/230	1075/1	4.1	EA	1
3203HS	1/6	208/230	825/1	0.9	EA	1
3204HS	1/4	208/230	825/1	1.3	EA	1
3205HS	1/3	208/230	825/1	1.8	EA	1
3747HS	1/2	208/230	825/1	2.8	EA	1
3736HS	1/4	460	1075/1	0.7	EA	1
3737HS	1/3	460	1075/1	1.2	EA	1
3738HS	1/2	460	1075/1	1.7	EA	1
3739HS	3/4	460	1075/1	2.0	EA	1
3469HS	1/3-1/6	208/230	825/2	2.0	EA	1
3465HS	1/3-1/6	208/230	1075/2	2.5	EA	1
3468HS	1/2-1/5	208/230	1075/2	3.1	EA	1
3459HS	1/3-1/8	208/230	825/1	1.8	EA	1
3458HS	1/3-1/6	208/230	1075/1	2.6	EA	1



### Genteq® Direct Drive Furnace Blower Motors

- Standard 48 frame size
- 3 speeds at 1075 RPM
- 115V or 208-230V options available
- 4" shaft extension
- Reversible rotation
- Mounting holes for capacitor mounting bracket
- Automatic thermal overload protection

CATALOG NO.	HP	VOLTAGE	SPEED	FLA	UOM	ORDER MULTIPLE
3583	1/4	115	1075/3	4.2	EA	1
3584	1/4	208/230	1075/3	2.0	EA	1
3585	1/3	115	1075/3	6.1	EA	1
3586	1/3	208/230	1075/3	2.7	EA	1
3587	1/2	115	1075/3	9.0	EA	1
3588	1/2	208/230	1075/3	5.0	EA	1
3589	3/4	115	1075/3	11.8	EA	1
3590	3/4	208/230	1075/3	5.0	EA	1
3595*	1	115	1075/3	11.8	EA	1
3596*	1	208/230	1075/3	5.6	EA	1

\*Ball Bearing



### Genteq® Multiple Horsepower Furnace Blower Motors

- Standard 48 frame size
- Four speeds with reversible rotation
- Extended clamp screws and resilient rings with Rheem mounting holes
- Hardware included
- 115V or 208-230V options available
- Automatic thermal overload protection

CATALOG NO.	HP	VOLTAGE	SPEED	FLA	UOM	ORDER MULTIPLE
3463	1/2-1/6	115	1075/4	6.2	EA	1
3464	1/2-1/6	208/230	1075/4	2.7	EA	1
3466*	3/4-1/5	115	1075/4	8.5	EA	1
3467*	3/4-1/5	208/230	1075/4	4.2	EA	1

\*Ball Bearing



**Fasco® OEM Replacement Draft Inducers**

Designed, engineered and life-tested in the USA by FASCO. OEM approved for aftermarket replacement.

- Performance to match the original design.
- Fit for proper operation of the safety pressure switch and condensate management system.
- UL recognized, CSA or cUL certified.
- Safety for your customers and your business.



CATALOG NO.	HP	VOLTAGE	SPEED	AMPS	TYPE	RPM	ROT.	BRNG.	FRAME	OEM CROSS REFERENCE	UOM	ORDER MULTIPLE
<b>AMANA</b>												
A129	1/20	115	1	1.95	SP	3250	CW	SLV	3.3	Amana, 7021-9064, 7021-9259	EA	1
<b>ARMSTRONG</b>												
A155	1/30	115	1	1.4	SP	3000	CCW	BALL	3.3	7021-10046	EA	1
<b>GOODMAN</b>												
A140	1/50	115	1	1.4	SP	3400	CW	SLV	3.3	7021-9087, 7021-9000	EA	1
A157	1/35	115	1	1.3	SP	3000	CCW	SLV	-	7002-2307	EA	1
A182	1/35	115	1	1.2	SP	3125	CCW	SLV	3.3	7002-3036, B4059000	EA	1
<b>INTERCITY PRODUCTS</b>												
A051	1/60	115	1	1.6	SP	3000	CW	BALL	-	1013833, J238-1393	EA	1
A067	1/20	115	1	2.6	SP	3000	CW	BALL	3.3	1014338 119225-00	EA	1
A134	1/25	115	1	1.5	SP	3060	CW	SLV	3.3	7021-9335, 7021-8735, 7021-9499, 7021-8736	EA	1
A169	1/25	230	1	0.75	SP	2800	CW	SLV	3.3	7021-10048, 7021-10580	EA	1
A170	1/25	115	1	2.3	SP	3400	CCW	BALL	3.3	7021-10702, 7021-10299	EA	1
A171	1/25	115	1	0.7	PSC	3450	CCW	BALL	3.3	7062-4783, 1011412	EA	1
A172	1/35	115	1	1.6	SP	3000	CW	BALL	-	7002-2792, 1010975P	EA	1
A173	1/18	115	1	0.8	PSC	3450	CCW	BALL	3.3	7062-4578, 1011350	EA	1
<b>JANITROL</b>												
A079	1/50	115	1	1.1	SP	3000	CCW	SLV	3.3	7062-6804	EA	1
<b>JOHNSON FURNACE</b>												
A081 <sup>1</sup>	1/40	230	1	0.5	SP	3000	CCW	BALL	3.3	HWC Series Unit	EA	1
<b>LENNOX</b>												
A163	1/20	115	1	1.8	SP	3400	CCW	BALL	3.3	7021-9450	EA	1
A200	1/30	115	1	1.95	SP	3000	CCW	BALL	-	7002-2975, 31L5501	EA	1
A202	1/30	115	1	1.8	SP	3400	CCW	BALL	3.3	7021-10602, 45037-001	EA	1
A213	1/25	115	2	2.1	SP	3200	CCW	BALL	3.3	7021-10376, 18L0401	EA	1
<b>RHEEM-RUUD</b>												
A066	1/30	120	1	1.27	SP	3000	CW	BALL	3.3	70-24157-03, 117847-00	EA	1

All rotation is determined by looking at shaft end.  
Note: 1. 3-1/2" motor body length

**MOTORS cont'd**

**Rotom® 51 Frame Unit Bearing Motors**

These Rotom 3.5 in. diameter, 51 frame, totally enclosed motors are for replacement of Morrill and EMS OEM motors commonly found in refrigeration equipment.

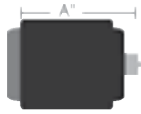

CATALOG NO.	WATTS	AMPS	VOLTS	ROT.	RPM	A DIM	SHAFT	CROSS REFERENCE	UOM	ORDER MULTIPLE
04-R5311	6	0.50	115	CW	1550	2.83"	HUBLESS	G.E. 5311, 5KSP51CL501, TECUMSEH TFM61, C	EA	1
04-R5411	9	0.58	115	CW	1550	2.80"	HUBLESS	G.E. 5411, 5KSP51ECL551, TECUMSEH TFM91, C	EA	1
04-R5412	9	0.60	115	CCW	1550	3.40"	HUBLESS	G.E. 5412, 5KSP51ECL553	EA	1
04-R5421	9	0.30	230	CW	1550	2.83"	HUBLESS	TECUMSEH TFM62, TFM92, G.E. 5421, 5KSP51ECL552	EA	1
04-R5611	9	0.60	115	CW	1550	3.07"	HUBLESS	HUSSMANN 47000, 58698	EA	1
04-R5811	16	1.00	115	CW	1550	3.03"	HUBLESS	050-0164-00, 050-0247-00, 401-0032-01, G.E. 5811	EA	1
04-R5821	16	0.50	230	CW	1550	3.03"	HUBLESS	G.E. 5821, 5KSP51GL582T	EA	1
04-R2511	25	1.10	115	CW	1500	3.50"	HUBLESS	TECUMSEH TFM191, 810E019A73, 810E019A80	EA	1
04-R2512	25	0.60	230	CW	1550	3.50"	HUBLESS	G.E. 0253	EA	1
04-R3511	35	1.40	115	CW	1500	3.50"	HUBLESS	TECUMSEH TFM351, HUSSMANN 328346, COPELAND 050-0227-01	EA	1
04-R3512	35	0.70	230	CW	1500	3.50"	HUBLESS	TECUMSEH TFM352, 810M35A12, 810M35121, 810M35A28, COPELAND	EA	1
04-R5011	50	1.70	115	CW	1500	4.50"	1.5"X3/8"	COPELAND 050-0011-01, 0017-02, 050-0237-01, 998100800	EA	1
04-R5012	50	0.85	230	CW	1500	4.50"	1.5"X3/8"	COPELAND 050-0017-01, 03, 0011-00, 0101-00, 0237-00, 998100700	EA	1
04-R5112	50	0.85	230	CW	1500	4.50"	1.4"X5/16"	TECUMSEH, 810M50A62	EA	1
04-R5122	50	0.85	230	CCW	1500	4.00"	2.0"X5/16"	TECUMSEH, TFM502, 810G050A50, 050-0264-0	EA	1

Motors are sleeve bearing unless indicated - rotation determined opposite shaft end (double shaft determined by lead end)

**Rotom® 51 Frame Refrigeration Motors**

- 3.5" diameter
- Totally enclosed
- GE Replacements
- Unit Bearing
- CW rotation
- 51 Frame
- Hubless Shaft
- Shaded Pole

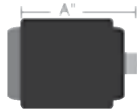

CATALOG NO.	WATTS	VOLTS	AMPS	SPD/RPM	TYPE	FIG.	"A"	SHAFT	TERMINATION	UOM	ORDER MULTIPLE
EE-5311	6	115	0.40	1/1550	SP	1	2.74"	1/4" X 20 HUBLESS		EA	1
EE-5411	9	115	0.52	1/1550	SP	1	2.74"	1/4" X 20 HUBLESS		EA	1
EE-5611	9	115	0.52	1/1550	SP	2	2.74"	1/4" X 20 HUBLESS		EA	1
EE-5811	16	115	0.90	1/1550	SP	1	2.97"	1/4" X 20 HUBLESS		EA	1

Motors are sleeve bearing unless indicated - rotation determined opposite shaft end (double shaft determined by lead end)



**MOTORS cont'd**

**Rotom® 3.3" Diameter Refrigeration Motors**

These Rotom 3.3 in. diameter motors are easy to install. They are replacement motors for refrigeration equipment.



**120 Volt**

CATALOG NO.	HP	RPM	AMPS	ROT.	TYPE	ENCL.	BODY	SHAFT	BEARING	CROSS REFERENCE	UOM	ORDER MULTIPLE
R3-R360	1/35	1/1550	1.00	CW	SP	OPEN	2.60"	1.6" X 1/4"	SLEEVE	KEEPRITE	EA	1
R3-R370	1/20	1/1550	.75	CW	PSC	OPEN	3.98"	2.7" X 5/16"	BALL	KEEPRITE	EA	1
R3-R358	1/20	1/1550	2.00	CCW	SP	OPEN	3.35"	3.2" X 5/16"	SLEEVE	BLANCHARD, BOHN	EA	1
R3-R368	1/20	1/1550	1.7	CW	SP	OPEN	2.70"	2.7" X 5/16"	SLEEVE	REF PLUS	EA	1
R3-R313	1/15	1/1550	2.20	CCW	SP	OPEN	3.60"	3.0" X 5/16"	BALL	KRACK 1055, BOHN, BLANCHARD, TORIN, 7627401	EA	1
R3-R356	1/20	1/1500	1.80	CCW	SP	OPEN	2.60"	2.2" X 5/16"	SLEEVE	FASCO, D132, U.E. 42, 2868-511-104	EA	1
R3-R357	1/20	1/1500	1.75	CW	SP	OPEN	2.30"	2.3" X 5/16"	SLEEVE	FASCO D133, U.E. 31, 43 2868-511-104 BLANCHARD	EA	1

**115/230 Volt**

CATALOG NO.	HP	RPM	AMPS	ROT.	TYPE	ENCL.	BODY	SHAFT	BEARING	CROSS REFERENCE	UOM	ORDER MULTIPLE
US-R91189	1/20	1550	1.6-0.8	CCW	SP	TE	3.15"	1.65" X 5/16"	SLEEVE	KRACK	EA	1
US-R90671	1/15	1550	2.1-1.1	CW	SP	OPEN	5.00"	2.24" X 5/16"	BALL	GE 11 FRAME REPLACEMENT	EA	1
US-R90672	1/15	1550	2.1-1.1	CCW	SP	OPEN	5.00"	2.24" X 5/16"	BALL	GE 11 FRAME REPLACEMENT	EA	1

**240 Volt**

CATALOG NO.	HP	RPM	AMPS	ROT.	TYPE	ENCL.	BODY	SHAFT	BEARING	CROSS REFERENCE	UOM	ORDER MULTIPLE
R3-R371	1/20	1550	0.38	CW	PSC	OPEN	3.98"	2.7" X 5/16"	BALL	KEEPRITE	EA	1
US-R90575	1/20	1550	0.89	CW	SP	OPEN	2.75"	2.48" X 5/16"	SLEEVE	LARKIN, HEATCRAFT	EA	1
R3-R369	1/20	1550	0.90	CW	SP	OPEN	2.70"	2.7" X 5/16"	SLEEVE	REF PLUS	EA	1
R3-R1053	1/20	1550	1.00	CCW	SP	OPEN	3.10"	3.2" X 5/16"	BALL	KEEPRITE, BLANCHARD	EA	1
R3-R359	1/20	1550	1.00	CCW	SP	OPEN	3.35"	3.2" X 5/16"	SLEEVE	KEEPRITE, BLANCHARD	EA	1
R3-R314	1/15	1550	1.30	CCW	SP	OPEN	3.60"	3.0" X 5/16"	SLEEVE	KRACK, TORIN, BOHN, BLANCHARD	EA	1

Motors are sleeve bearing unless indicated - rotation determined opposite shaft end (double shaft determined by lead end)

**Fasco® 3.3 in. Walk-In Cooler/Freezer Refrigeration Motors**

The Fasco 3-in-1 motor is a universal replacement motor for walk-in cooler and freezer evaporator applications. This motor replaces 1/12, 1/15 & 1/20hp PSC and Shaded pole motors. Designed for use down to 40°C applications with low temp lubrication.

CATALOG NO.	HP	VOLTAGE	SPEED	FLA	UOM	ORDER MULTIPLE
9721	1/12, 1/15, 1/20	115/208-230	1550	1.1/0.5	EA	1



**MOTORS cont'd**

**Rotom® EMC Unit Bearing Motor**

- Constant speed programworks to maintain speed even in restricted airflow situations
- 15" Leads with Lyall plug
- Cast iron
- Vertical up or horizontal
- Oil Rated -20°F to 120°F
- Suitable for use in evaporator and condenser applications
- 5 drilled and tapped mounting holes allows for standard 3-hole and Hussmann 4-hole mounting.
- Leg Mount features four drilled & tapped mounting holes on each side
- Traditional 3 Point Mount or New Hussmann 4 Point Mount



CATALOG NO.	VOLTS	WATTS	AMPS	RPM	ROT.	A DIM.	CROSS REFERENCE	UOM	ORDER MULTIPLE
<b>04-R6711</b>	115	6,9,12	.20,30	1550	CW	2.53"	HUSSMANN SVC #110.441.0546	EA	1

**Wellington® ECM Refrigeration Motors**

Wellington ECM Refrigeration Motors are electronically commutated brushless DC motors. Top quality electronics and design make these motors extremely efficient, quiet and reliable. Long design life and reliability are the result of Wellington's moisture proof patented design and the use of ball bearings; and allow significant maintenance and cost savings. Wellington motors use the same mounting systems as shaded pole motors and are provided with a plug in connection for easy, fast replacement.



CATALOG NO.	WATT	VOLTAGE	SPEED	FLA	UOM	ORDER MULTIPLE
<b>ECR01-9W</b>	9	115	1500	0.23	EA	1
<b>ECR01-12W</b>	12	115	1550	0.31	EA	1

**MOTOR BRACKETS**

**DiversiTech® Motors Bracket**

These brackets help hold the motor securely.

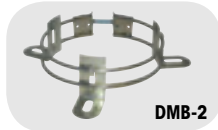

CATALOG NO.	DESCRIPTION	UOM	ORDER MULTIPLE
<b>DMB-1</b>	Fixed Lug Assembly for 5-1/2" diameter motors	EA	1
<b>DMB-2</b>	Adjustable Lug Assembly for 5-1/2" diameter motors	EA	1

**Motor Mount – Flex Bracket**

Torsion Flex Bracket holds motor securely. Fits 5-1/2" motors. Typically used for Goodman equipment.



CATALOG NO.	DESCRIPTION	UOM	ORDER MULTIPLE
<b>DMB-3</b>	5-1/2" Motor Mount Torsion Flex Bracket	EA	1

**WHIPS**

**DiversiWhips**

Liquid tight flexible conduit system. A labor saving convenience kit for A/C unit hookup. Also use for heat pumps, refrigeration, hot tubs, swimming pools and outdoor lighting. Three distinct wire colors for ease of hook up. 1 straight and 1 90 degree metallic or non metallic connector. 90 degree connector is removable for straight connections. (Second straight connector not included.) U.L. and C.U.L Listed.



CATALOG NO.	DESCRIPTION	UOM	ORDER MULTIPLE
<b>6-12-4</b>	1/2 x 4' #10 THHN Wire – Metallic Connectors	EA	6
<b>6-12-6</b>	1/2 x 6' #10 THHN Wire – Metallic Connectors	EA	6
<b>6-34-4</b>	3/4 x 4' #8 THHN Wire – Metallic Connectors	EA	6
<b>6-34-6</b>	3/4 x 6' #8 THHN Wire – Metallic Connectors	EA	6
<b>6-34-8</b>	3/4 x 8' #8 THHN Wire – Metallic Connectors	EA	3
<b>6-12-4NM</b>	1/2 x 4' #10 THHN Wire – Non-Metallic Connectors	EA	6
<b>6-12-6NM</b>	1/2 x 6' #10 THHN Wire – Non-Metallic Connectors	EA	6
<b>6-34-4NM</b>	3/4 x 4' #8 THHN Wire – Non-Metallic Connectors	EA	6
<b>6-34-6NM</b>	3/4 x 6' #8 THHN Wire – Non-Metallic Connectors	EA	6
<b>6-34-8NM</b>	3/4 x 8' #8 THHN Wire – Non-Metallic Connectors	EA	3
<b>6-12-6NMS</b>	1/2 x 6' #10 THHN Wire – 2 Non-Metallic Straight Connectors	EA	6
<b>6-34-6NMS</b>	3/4 x 6' #8 THHN Wire – 2 Non-Metallic Straight Connectors	EA	6

\*For DiversiWhips produced with 2 straight connectors, add S to part number (ex: 6-12-4S).

**DiversiWhips Pallet Packs**

DiversiWhips are now available in a convenient, bulk packaged pallet pack at a discounted price. Pallet pack makes an attractive floor standing display. 1 straight and 1 90 degrees metallic or non metallic connector.



CATALOG NO.	DESCRIPTION	UOM	ORDER MULTIPLE
<b>B6-12-4</b>	1/2 x 4' #10 THHN Wire – Metallic Connectors	EA	90
<b>B6-12-6</b>	1/2 x 6' #10 THHN Wire – Metallic Connectors	EA	60
<b>B6-34-6</b>	3/4 x 6' #8 THHN Wire – Metallic Connectors	EA	45
<b>B6-12-4NM</b>	1/2 x 4' #10 THHN Wire – Non-Metallic Connectors	EA	90
<b>B6-12-6NM</b>	1/2 x 6' #10 THHN Wire – Non-Metallic Connectors	EA	60
<b>B6-34-4NM</b>	3/4 x 4' #8 THHN Wire – Non-Metallic Connectors	EA	60
<b>B6-34-6NM</b>	3/4 x 6' #8 THHN Wire – Non-Metallic Connectors	EA	45

**WHIPS cont'd**

**DiversiWhips for the Swimming Pool Industry**

A labor saving kit for hookup of swimming pool motors, pumps, filters, and timers. Three distinct wire colors for ease of hookup. 1 straight and 1 90 degree non-metallic connector included.



6-12-6NMP

**DiversiWhips with Extended Length Wires**

DiversiWhips are available with extra long lead wires for those difficult to wire applications. These whips offer 10in. of lead wire on the straight side and 18in. of lead wire on the 90 degree side.



6-12-4R

CATALOG NO.	DESCRIPTION	UOM	ORDER MULTIPLE
6-12-6NMP	1/2 x 6' #12 THHN Wire – In Bag	EA	6
6-12-4NMSWP	1/2 x 4' #10 THHN Wire – In Box	EA	6
6-12-6NMSWP	1/2 x 6' #10 THHN Wire – In Box	EA	6
6-34-4NMSWP	3/4 x 4' #8 THHN Wire – In Box	EA	6
6-34-6NMSWP	3/4 x 6' #8 THHN Wire – In Box	EA	6

CATALOG NO.	DESCRIPTION	UOM	ORDER MULTIPLE
6-12-6NMR	1/2 x 6' #10 THHN Wire – Non-Metallic Connectors	EA	6
6-34-6NMR	3/4 x 6' #8 THHN Wire – Non-Metallic Connectors	EA	6

**Solid Wire Whips**

6-12-4NMSWP	1/2 x 4' #12 Solid 3 Wire – Non-Metallic Conn.	EA	6
6-12-6NMSWP	1/2 x 6' #12 Solid 3 Wire – Non-Metallic Conn.	EA	6
6-12-8NMSWP	1/2 x 8' #12 Solid 3 Wire – Non-Metallic Conn.	EA	3

**DIVERSITECH ELECTRICAL DISCONNECTS**

**Disconnects—Metal Case**

Fused model designed with fuses in pull out handle for easy replacement. The line, load, and ground terminals are aligned for ease of wiring. This product has a reversible door which opens to either the left or right. The side open door opens more than 180 degrees for maximum access and has a full dead front. The fused models have indicator lights for blown fuses. This is rain tight and sleet resistant. The UL Listed number is IRF9, NEMA Type 3R and the US Patent is 6,630,637.



DDS-60

**Low Profile Disconnects—Metal Case**

This low profile disconnect switch is a slightly smaller design than that of the standard DiversiTech disconnects. This has a side opening door with a full dead front. This is rain tight and sleet resistant. The UL Listed number is IRF9, NEMA Type 3R.



EDS-60U

EDS-12-6NM

CATALOG NO.	DESCRIPTION	UOM	ORDER MULTIPLE
DDS-30	30A Fusible Disconnect Switch	EA	10
DDS-60	60A Fusible Disconnect Switch	EA	10
DDS-60U	60A Non-Fusible Disconnect Switch	EA	10

CATALOG NO.	DESCRIPTION	UOM	ORDER MULTIPLE
EDS-60U	60A Non-Fusible Disconnect Switch	EA	10
EDS-12-6NM	Disconnect and Whip Combo Kit	EA	3

**Disconnects—Non-Metallic Case**

This 60 amp non-fusible disconnect is housed in a lightweight, non-metallic case. It features a side opening door with more than 180° access, full dead front, and a locking tab.



750-P60NF

**Molded Case Switch Disconnect**

The DDS-60SW Molded Case Switch Disconnect is rugged and easy to use like an ordinary light switch. It eliminates the pullout handle used in traditional AC disconnects and is easy to install. It is UL listed and rated for indoor and outdoor applications with NEMA 3R rating.



DDS-60SW

CATALOG NO.	DESCRIPTION	UOM	ORDER MULTIPLE
750-P60NF	60A Non Fusible Disconnect Switch, Non-Metallic Case, Plastic	EA	10

CATALOG NO.	DESCRIPTION	UOM	ORDER MULTIPLE
DDS-60SW	Molded Case Switch Disconnect, 60A 240 VAC	EA	10

**EATON ELECTRICAL DISCONNECTS**

**Eaton Switch A/C Disconnect**

This A/C Disconnect is 60 amps switch rated for 10 HP motors at 240VAC. The switch is an on off circuit breaker with no pull out head that could be lost or stolen. It has easy-to-remove front cover with no screws or fasteners to remove.



DPB222R



CATALOG NO.	DESCRIPTION	UOM	ORDER MULTIPLE
DPB222R	60A molded case switch	EA	1

**Eaton Three Phase Disconnects**

These disconnects are UL listed and meet UL 98 for enclosed switches and NEMA Std. KS-1. They are suitable as service entrance equipment when applied with neutral or ground lug kit. They come with rainproof NEMA 3R enclosure.



DG322NRB



CATALOG NO.	DESCRIPTION	UOM	ORDER MULTIPLE
DG321NRB	Fusible 30 Amp, 240VAC	EA	1
DG322NRB	Fusible 60 Amp, 240VAC	EA	1
DG322URB	Non-fusible 60 Amp, 240VAC	EA	1

**CONDUIT, FITTINGS, CABLE**

**DiversiTite™ Flexible Conduit**

For electrical applications: outside, inside and industrial uses including transformer connections, air conditioning and heating. Joins with metallic or non-metallic connectors, easy to cut. Impact resistant, chemical resistant, and will not kink. U.L. and C.U.L. Listed. For use as indicated in Article 351 of the 1987 NEC.



750-12100

CATALOG NO.	DESCRIPTION	UOM	ORDER MULTIPLE
750-38100	3/8" x 100' Liquid Tite Conduit – Non-Metallic, 100' per roll	EA	1
750-12100	1/2" x 100' Liquid Tite Conduit – Non-Metallic, 100' per roll	EA	1
750-500	1/2" x 100' Liquid Tite Conduit – Metallic, 100' per roll	EA	1
750-34100	3/4" x 100' Liquid Tite Conduit – Non-Metallic, 100' per roll	EA	1
750-600	3/4" x 100' Liquid Tite Conduit – Metallic, 100' per roll	EA	1
750-10100	1" x 100' Liquid Tite Conduit – Non-Metallic, 100' per roll	EA	1
750-125100	1-1/4" x 100' Liquid Tite Conduit – Non-Metallic, 100' per roll	EA	1
750-1550	1-1/2" x 50' Liquid Tite Conduit – Non-Metallic, 50' per roll	EA	1
750-2050	2" x 50' Liquid Tite Conduit – Non-Metallic, 50' per roll	EA	1
750-10500	1" x 500' Liquid Tite Conduit – Non-Metallic, 500' per roll	EA	1
750-121000	1/2" x 1000' Liquid Tite Conduit – Non-Metallic, 1000' per roll	EA	1
750-34800	3/4" x 800' Liquid Tite Conduit – Non-Metallic, 800' per roll	EA	1

**Single Piece Liquid Tite Fittings**

Conduit threads onto ferrule and up inside the outer body. An inside taper squeezes down on the outside of conduit for a superior liquid tight seal. The cut portion of the conduit does not show, giving a more finished appearance. Easy to use at a lower cost than regular liquid tite fittings.



750-SLTC9050

750-SLTC50

CATALOG NO.	DESCRIPTION	UOM	ORDER MULTIPLE
750-SLTC50	1/2" Straight Screw-On Fitting	EA	25
750-SLTC9050	1/2" 90° Screw-On Fitting	EA	25
750-SLTC75	3/4" Straight Screw-On Fitting	EA	25
750-SLTC9075	3/4" 90° Screw-On Fitting	EA	25

**Liquid Tite Connectors**

For use with metallic and non metallic liquid tite conduit, Type B. Provides smooth connection, no sharp edges to strip wire. Wiring easily pulled through. U. L. Listed. C.U.L. Listed.



750-MLT50

750-NMLT50

750-NMLT9050

CATALOG NO.	DESCRIPTION	UOM	ORDER MULTIPLE
750-NMLT50	1/2" Non-Metallic Straight Connector	EA	25
750-NMLT4550	1/2" Non-Metallic 45 Degree Elbow Connector	EA	10
750-NMLT9050	1/2" Non-Metallic 90 Degree Elbow Connector	EA	10
750-NMLT75	3/4" Non-Metallic Straight Connector	EA	10
750-NMLT4575	3/4" Non-Metallic 45 Degree Elbow Connector	EA	10
750-NMLT9075	3/4" Non-Metallic 90 Degree Elbow Connector	EA	10
750-NMLT100	1" Non-Metallic Straight Connector	EA	5
750-NMLT90100	1" Non-Metallic 90 Degree Elbow Connector	EA	5
750-MLT50	1/2" Metallic Straight Connector	EA	25
750-MLT9050	1/2" Metallic 90 Degree Elbow Connector	EA	10
750-MLT75	3/4" Metallic Straight Connector	EA	10
750-MLT9075	3/4" Metallic 90 Degree Elbow Connector	EA	10
750-NMLT125	1-1/4" Non-Metallic Straight Connector	EA	1
750-NMLT150	1-1/2" Non-Metallic Straight Connector	EA	10
750-NMLT90125	1-1/4" Non-Metallic 90 Degree Elbow Connector	EA	1
750-NMLT5090-F	1/2" Non-Metallic Adjustable Connector	EA	10
750-NMLT7590-F	3/4" Non-Metallic Adjustable Connector	EA	10
750-TZNMLT200	2" NM Topaz	EA	2
750-TZNMLT90200	2" NM Topaz 90 Degree	EA	1
750-TZNMLT150	1-1/2" NM Topaz	EA	5
750-TZNMLT90150	1-1/2" NM Topaz 90 Degree	EA	2
750-TZNMLT125	1-1/4" NM Topaz	EA	5
750-TZNMLT90125	1-1/4" NM Topaz 90 Degree	EA	2
750-TZNMLT100	1" NM Topaz	EA	5
750-TZNMLT90100	1" NM Topaz 90 Degree	EA	5
750-TZNMLT38	3/8" NM Topaz	EA	10
750-TZNMLT9038	3/8" NM Topaz 90 Degree	EA	25
750-TZNMLT50	1/2" NM Topaz	EA	25
750-TZNMLT9050	1/2" NM Topaz 90 Degree	EA	10
750-TZNMLT75	3/4" NM Topaz	EA	10
750-TZNMLT9075	3/4" NM Topaz 90 Degree	EA	10

**CONDUIT, FITTINGS, CABLE cont'd**

**Aluminum Armored MC Cable**

90° C Rated aluminum metal clad cable system. THHN solid copper with specially compounded heat-resistant U.L. Listed insulation and jacket. Flexible interlocked aluminum armor. Extremely durable – withstands severe handling. U.L. Listed #4. Conforms to NEC article 333.



CATALOG NO.	DESCRIPTION	UOM	ORDER MULTIPLE
640-122	12-2 Aluminum Armored MC Cable – 100' per roll EA		1
640-142	14-2 Aluminum Armored MC Cable – 100' per roll EA		1

**Romex Connectors – Metallic**

These Metallic Romex Connectors are made of zinc die cast are cable connectors for Romex wire. U.L. Listed C.S.A. Approved.



CATALOG NO.	DESCRIPTION	UOM	ORDER MULTIPLE
750-RC841	3/8" Romex Connector for 1/2" Knockouts	EA	100
750-RC842	3/4" Romex Connector for 3/4" Knockouts	EA	50

U.L. Listed and C.S.A. Approved.

**BX Set Screw Connectors**

These connectors are for BX cable range of .445 to .630 in diameter. This product is UL listed and CSA approved.



CATALOG NO.	DESCRIPTION	UOM	ORDER MULTIPLE
640-845	Trade Size – 3/8"	EA	100

**Non-Metallic Sheathed Cable (Romex Wire)**

600V building wire. Easy to pull and strip, flame and moisture resistant. Saves time, labor and money. Color coded conductors of copper, PVC insulation and outer jacket with ground. U.L. Listed 719 Federal Specifications J C94.



CATALOG NO.	DESCRIPTION	UOM	ORDER MULTIPLE
620-6-2	6 AWG, 2 Conductors with Ground – 125' per pack	EA	1
620-8-2	8 AWG, 2 Conductors with Ground – 125' per pack	EA	1
620-10-2	10 AWG, 2 Conductors with Ground – 250' per pack	EA	1
620-12-2	12 AWG, 2 Conductors with Ground – 250' per pack	EA	1
620-14-2	14 AWG, 2 Conductors with Ground – 250' per pack	EA	1

U.L. Listed 719 Federal Specifications J-C94.

**EMT (Thinwall) Fittings**

These are used to join EMT conduit to boxes or enclosures.



CATALOG NO.	DESCRIPTION	UOM	ORDER MULTIPLE
625-800	Set Screw Connector – 1/2"	EA	50
625-801	Set Screw Connector – 3/4"	EA	25
625-304	Strap – One Hole – 1/2"	EA	100
625-305	Strap – One Hole – 3/4"	EA	100
625-810	Set Screw Coupling – 1/2"	EA	50
625-811	Set Screw Coupling – 3/4"	EA	25

**Cable Staples**

Cable Staples for NMB Cable (Romex) and Copper Insulated Staples for thermostat wire.



CATALOG NO.	DESCRIPTION	UOM	ORDER MULTIPLE
625-183	Romex Staples – 1/2", pack of 100	PK	1
625-IS5	Copper Insulated #5 Staples for T-Stat Wire	EA	100

**CAPACITORS**

**Motor Run Capacitors—370VAC,  
Metal, Oval Can**

These single capacitance oval, metal can capacitors are designed for continuous run.



CATALOG NO.	uf	UOM	ORDER MULTIPLE
37030H	3	EA	1
37040H	4	EA	1
37050H	5	EA	1
37050HB	5	EA	100*
37060H	6	EA	1
37075H	7.5	EA	1
37075HB	7.5	EA	100*
37100H	10	EA	1
37100HB	10	EA	100*
37125H	12.5	EA	1
37150H	15	EA	1
37175H	17.5	EA	1
37200H	20	EA	1
37250H	25	EA	1
37300H	30	EA	1
37350H	35	EA	1
37400H	40	EA	1
37450H	45	EA	1
37500H	50	EA	1
37600H	60	EA	1
37700H	70	EA	1
37800H	80	EA	1

\*100 per pack

**Motor Run Capacitors—370VAC**

This single capacitance round, metal can capacitors are designed for continuous run.



CATALOG NO.	uf	UOM	ORDER MULTIPLE
37050R	5	EA	1
37075R	7.5	EA	1
37125R	12.5	EA	1
37150R	15	EA	1
37175R	17.5	EA	1
37200R	20	EA	1
37250R	25	EA	1
37300R	30	EA	1
37350R	35	EA	1
37400R	40	EA	1
37450R	45	EA	1
37500R	50	EA	1
37550R	55	EA	1
37600R	60	EA	1
37800R	80	EA	1
37300R-SWP*	30	EA	1
37350R-SWP*	35	EA	1

\*Compact size, ideal for swimming pool motors.

**Motor Run Capacitors—370VAC**

Dual capacitance. Oval, metal can.



CATALOG NO.	uf	UOM	ORDER MULTIPLE
3GJ0515	15+5	EA	1
3GJ0520	20+5	EA	1
3GJ1520	20+15	EA	1
3GJ0525	25+5	EA	1
3GJ1025	25+10	EA	1
3GJ0330	30+3	EA	1
3GJ0530	30+5	EA	1
3GJ7530	30+7.5	EA	1
3GJ0535	35+5	EA	1
3GJ7535	35+7.5	EA	1
3GJ7545	45+7.5	EA	1
3GJ0540	40+5	EA	1
3GJ0545	45+5	EA	1
3GJ0555	55+5	EA	1
3GJ7555	55+7.5	EA	1
3GJ1060	60+10	EA	1

**Motor Run Capacitors—370VAC**

This dual capacitance round metal can capacitors are designed for continuous run.



CATALOG NO.	uf	UOM	ORDER MULTIPLE
3GR0515	15+5	EA	1
3GR0520	20+5	EA	1
3GR0325	25+3	EA	1
3GR0425	25+4	EA	1
3GR0525	25+5	EA	1
3GR0330	30+3	EA	1
3GR0530	30+5	EA	1
3GR7530	30+7.5	EA	1
3GR0335	35+3	EA	1
3GR0435	35+4	EA	1
3GR0535	35+5	EA	1
3GR1035	35+10	EA	1
3GR0340	40+3	EA	1
3GR0540	40+5	EA	1
3GR7540	40+7.5	EA	1
3GR0545	45+5	EA	1
3GR0550	50+5	EA	1
3GR0555	55+5	EA	1
3GR7555	55+7.5	EA	1
3GR0560	60+5	EA	1
3GR7560	60+7.5	EA	1
3GR0570	70+5	EA	1
3GR0580	80+5	EA	1
3GR7580	80+7.5	EA	1
3GR1080	80+10	EA	1

**Motor Run Capacitors—440VAC**

These single capacitance oval, metal can capacitors are designed for continuous run.



CATALOG NO.	uf	UOM	ORDER MULTIPLE
45020H	2	EA	1
45030H	3	EA	1
45040H	4	EA	1
45050H	5	EA	1
45060H	6	EA	1
45075H	7.5	EA	1
45100H	10	EA	1
45125H	12.5	EA	1
45150H	15	EA	1
45175H	17.5	EA	1
45200H	20	EA	1
45250H	25	EA	1
45300H	30	EA	1
45350H	35	EA	1
45400H	40	EA	1
45450H	45	EA	1
45500H	50	EA	1
45550H	55	EA	1
45600H	60	EA	1
45700H	70	EA	1
45800H	80	EA	1

**Motor Run Capacitor—440VAC**

Single capacitance. Round, metal can.



CATALOG NO.	uf	UOM	ORDER MULTIPLE
45050R	5	EA	1
45075R	7.5	EA	1
45100R	10	EA	1
45125R	12.5	EA	1
45150R	15	EA	1
45200R	20	EA	1
45250R	25	EA	1
45300R	30	EA	1
45350R	35	EA	1
45400R	40	EA	1
45450R	45	EA	1
45500R	50	EA	1
45550R	55	EA	1
45600R	60	EA	1
45700R	70	EA	1
45800R	80	EA	1

**Motor Run Capacitor—440VAC**

Dual capacitance. Oval, metal can.



CATALOG NO.	uf	UOM	ORDER MULTIPLE
4JJ0525	25+5	EA	1
4JJ0530	30+5	EA	1
4JJ0535	35+5	EA	1
4JJ0540	40+5	EA	1
4JJ0545	45+5	EA	1
4JJ0555	55+5	EA	1
4JJ7535	35+7.5	EA	1
4JJ7540	40+7.5	EA	1
4JJ7545	45+7.5	EA	1
4JJ1055	55+10	EA	1
4JJ0560	60+5	EA	1

**Motor Run Capacitor—440VAC**

Dual capacitance. Round, metal can.



CATALOG NO.	uf	UOM	ORDER MULTIPLE
4JR0520	20+5	EA	1
4JR0525	25+5	EA	1
4JR7525	25+7.5	EA	1
4JR0530	30+5	EA	1
4JR7530	30+7.5	EA	1
4JR0535	35+5	EA	1
4JR7535	35+7.5	EA	1
4JR0440	40+4	EA	1
4JR0540	40+5	EA	1
4JR7540	40+7.5	EA	1
4JR0545	45+5	EA	1
4JR7545	45+7.5	EA	1
4JR0550	50+5	EA	1
4JR7550	50+7.5	EA	1
4JR0555	55+5	EA	1
4JR1055	55+10	EA	1
4JR7555	55+7.5	EA	1
4JR0560	60+5	EA	1
4JR7560	60+7.5	EA	1
4JR1060	60+10	EA	1
4JR0570	70+5	EA	1
4JR7570	70+7.5	EA	1
4JR0580	80+5	EA	1
4JR7580	80+7.5	EA	1
4JR1080	80+10	EA	1

**MOTOR RUN CAPACITORS (USA MADE)**

**Made in the U.S.A. Capacitors  
Round Metal Can**

Line of made in the USA capacitors featuring dual voltage for both 370V and 440V applications. Designed specifically for the demands of aftermarket service parts.



CATALOG NO.	VOLTAGE	uf	UOM	ORDER MULTIPLE
4JR0525U	370V/440V	25+5	EA	1
4JR0530U	370V/440V	30+5	EA	1
4JR7530U	370V/440V	30+7.5	EA	1
4JR0535U	370V/440V	35+5	EA	1
4JR7535U	370V/440V	35+7.5	EA	1
4JR0540U	370V/440V	40+5	EA	1
4JR7540U	370V/440V	40+7.5	EA	1
4JR0545U	370V/440V	45+5	EA	1
4JR7545U	370V/440V	45+7.5	EA	1
4JR0550U	370V/440V	50+5	EA	1
4JR7550U	370V/440V	50+7.5	EA	1
4JR0555U	370V/440V	55+5	EA	1
4JR7555U	370V/440V	55+7.5	EA	1
4JR0560U	370V/440V	60+5	EA	1
4JR7560U	370V/440V	60+7.5	EA	1
4JR0580U	370V/440V	80+5	EA	1

**Motor Start Capacitors –  
110/125 VAC**

Variable capacitance. Round, plastic can.



CATALOG NO.	uf	UOM	ORDER MULTIPLE
56-72	56-72	EA	1
88-108	88-108	EA	1
108-130	108-130	EA	1
124-156	124-156	EA	1
145-175	145-175	EA	1
161-193	161-193	EA	1
189-227	189-227	EA	1
200-240	200-240	EA	1
216-259	216-259	EA	1
233-292	233-292	EA	1
270-324	270-324	EA	1
324-388	324-388	EA	1
340-408	340-408	EA	1
378-440	378-440	EA	1
400-480	400-480	EA	1
460-552	460-552	EA	1
540-648	540-648	EA	1
590-708	590-708	EA	1
708-850	708-850	EA	1
829-995	829-995	EA	1
1000-1200	1000-1200	EA	1

**Made in the U.S.A. Capacitors  
Oval Metal Can**

Line of made in the USA capacitors featuring dual voltage for both 370V and 440V applications. Designed specifically for the demands of aftermarket service parts.



CATALOG NO.	VOLTAGE	uf	UOM	ORDER MULTIPLE
45050HU	370V/440V	5	EA	1
45075HU	370V/440V	7.5	EA	1
45100HU	370V/440V	10	EA	1
45150HU	370V/440V	15	EA	1
45200HU	370V/440V	20	EA	1
45250HU	370V/440V	25	EA	1
45300HU	370V/440V	30	EA	1
45350HU	370V/440V	35	EA	1
45400HU	370V/440V	40	EA	1
45450HU	370V/440V	45	EA	1
45125HU	370V/440V	12.5	EA	1
45500HU	370V/440V	50	EA	1
45600HU	370V/440V	60	EA	1
45700HU	370V/440V	70	EA	1
45800HU	370V/440V	80	EA	1

**Motor Start Capacitors –  
220/250 VAC**

Variable capacitance. Round, plastic can.



CATALOG NO.	uf	UOM	ORDER MULTIPLE
43-53220	43-53	EA	1
56-72220	56-72	EA	1
72-88220	72-88	EA	1
88-108220	88-108	EA	1
108-130220	108-130	EA	1
124-156220	124-156	EA	1
145-175220	145-175	EA	1
161-193220	161-193	EA	1
189-227220	189-227	EA	1
216-259220	216-259	EA	1
233-292220	233-292	EA	1
270-324220	270-324	EA	1

**Motor Start Capacitors –  
330 VAC**

Variable capacitance. Round, plastic can.



CATALOG NO.	uf	UOM	ORDER MULTIPLE
72-88330	72-88	EA	1
88-108330	88-108	EA	1
108-130330	108-130	EA	1
124-156330	124-156	EA	1
145-175330	145-175	EA	1
161-193330	161-193	EA	1
189-227330	189-227	EA	1
216-259330	216-259	EA	1
270-324330	270-324	EA	1



## HARD START KITS

### Torque Plus—Hard Start Kits

Totally solid state, our DST 5 is just right for all permanent split capacitor (PSC) compressors from 1/2 to 10 H.P. It can be used on units that operate on 120 through 288 Volts. The DST 6 offers a larger capacitor for severely hard to start compressors. The DST 6 can be used on all PSC single phase compressors from 1 1/2 to 10 H.P. A unique combination of relay and safety timer. The capacitor is automatically disconnected in 0.5 seconds if the compressor fails to start.



CATALOG NO.	DESCRIPTION	UOM	ORDER MULTIPLE
<b>DST-5</b>	Torque Plus – 300% Torque Multiplier	EA	1
<b>DST-6</b>	Torque Plus – 500% Torque Multiplier	EA	1

### DiversiTech Hard Start Kits

DiversiTech hard start kits reduce contractor call backs by boosting the starting capacitor for a compressor. This prevents home brownouts and improves homeowner satisfaction with your service. DiversiTech's hard start kits feature a potential relay that disconnects the start capacitor from the circuit at exactly the moment it is no longer needed to boost the compressor. This results in a precision compressor start even under hard starting conditions. Replaces the Kickstart KS-1 and the 5-n-1 kit.



CATALOG NO.	DESCRIPTION	UOM	ORDER MULTIPLE
<b>HSK1</b>	Hard Start Kit for 3.5 to 5HP Compressor	EA	1
<b>HSK5</b>	Hard Start Kit for 1 to 3HP Compressor	EA	1

## CONTACTORS

### DiversiTech® Two Pole Definite Purpose Contactors

Definite purpose contactors can be used for heating, air conditioning, refrigeration, data processing, and food service equipment. Quick connect terminals provide for easy wiring. This contactor comes as a two pole on a small frame.



CATALOG NO.	FL AMPS	COIL VAC	UOM	ORDER MULTIPLE
<b>EC25224</b>	25	24	EA	1
<b>EC252120</b>	25	120	EA	1
<b>EC252240</b>	25	240	EA	1
<b>EC252277</b>	25	277	EA	1
<b>EC30224</b>	30	24	EA	1
<b>EC302120</b>	30	120	EA	1
<b>EC302240</b>	30	240	EA	1
<b>EC40224</b>	40	24	EA	1
<b>EC402120</b>	40	120	EA	1
<b>EC402240</b>	40	240	EA	1

### DiversiTech® Three Pole Definite Purpose Contactors

Definite purpose contactors can be used for heating, air conditioning, refrigeration, data processing, and food service equipment. Quick connect terminals provide for easy wiring. This contactor comes as a three pole on a large frame.



CATALOG NO.	FL AMPS	COIL VAC	UOM	ORDER MULTIPLE
<b>EC30324</b>	30	24	EA	1
<b>EC303120</b>	30	120	EA	1
<b>EC303240</b>	30	240	EA	1
<b>EC303277</b>	30	277	EA	1
<b>EC40324</b>	40	24	EA	1
<b>EC403120</b>	40	120	EA	1
<b>EC403240</b>	40	240	EA	1
<b>EC403277</b>	40	277	EA	1
<b>EC50324</b>	50	24	EA	1
<b>EC503120</b>	50	120	EA	1
<b>EC503240</b>	50	240	EA	1
<b>EC503277</b>	50	277	EA	1
<b>EC60324</b>	60	24	EA	1
<b>EC603120</b>	60	120	EA	1
<b>EC603240</b>	60	240	EA	1
<b>EC603277</b>	60	277	EA	1
<b>EC75324</b>	75	24	EA	1
<b>EC753120</b>	75	120	EA	1
<b>EC753240</b>	75	240	EA	1
<b>EC753277</b>	75	277	EA	1
<b>EC90324</b>	90	24	EA	1
<b>EC903120</b>	90	120	EA	1
<b>EC903240</b>	90	240	EA	1
<b>EC903277</b>	90	277	EA	1

**CONTACTORS** cont'd

**Eaton Definite Purpose Contactors - Three and Four Pole**

These are Eaton's standard line of C25 DP contactors. They feature pressure plates with quick connects for 25A and 30A contactors, and lugs and quick connects for 40A to 90A contactors. They are UL recognized and CSA certified components. These contactors are designed for the HVAC and refrigeration applications.



CATALOG NO.	POLES	FL AMPS	COIL VAC	UOM	ORDER MULTIPLE
DPE253120	3	25	120	EA	1
DPE25324	3	25	24	EA	1
DPE253240	3	25	240	EA	1
DPE303120	3	30	120	EA	1
DPE30324	3	30	24	EA	1
DPE303240	3	30	240	EA	1
DPE303277	3	30	277	EA	1
DPE303480	3	30	480	EA	1
DPE403120	3	40	120	EA	1
DPE40324	3	40	24	EA	1
DPE403240	3	40	240	EA	1
DPE403480	3	40	480	EA	1
DPE503120	3	50	120	EA	1
DPE50324	3	50	24	EA	1
DPE503240	3	50	240	EA	1
DPE603120	3	60	120	EA	1
DPE60324	3	60	24	EA	1
DPE603240	3	60	240	EA	1
DPE753120	3	75	120	EA	1
DPE75324	3	75	24	EA	1
DPE753240	3	75	240	EA	1
DPE903120	3	90	120	EA	1
DPE90324	3	90	24	EA	1
DPE903240	3	90	240	EA	1
DPE304120	4	30	120	EA	1
DPE30424	4	30	24	EA	1
DPE304240	4	30	240	EA	1
DPE304277	4	30	277	EA	1
DPE404120	4	40	120	EA	1
DPE404240	4	40	240	EA	1
DPE404277	4	40	277	EA	1

**Eaton Definite Purpose Contactors - One and Two Pole**

These are single- and two-pole, Type C25 contactors feature a compact, efficient design with a low VA coil and straight-through wiring. Its housing design effectively limits dust and other contaminants from magnet structure—reduces or eliminates noise. They are UL recognized/CSA certified, ampere rated devices are well suited for use in heating/air conditioning, refrigeration, data processing and food service applications.



CATALOG NO.	POLES	FL AMPS	COIL VAC	UOM	ORDER MULTIPLE
DPE301120	1	30	120	EA	1
DPE30124	1	30	24	EA	1
DPE301240	1	30	240	EA	1
DPE401120	1	40	120	EA	1
DPE40124	1	40	24	EA	1
DPE252120	2	25	120	EA	1
DPE25224	2	25	24	EA	1
DPE252240	2	25	240	EA	1
DPE302120	2	30	120	EA	1
DPE30224	2	30	24	EA	1
DPE302240	2	30	240	EA	1
DPE302277	2	30	277	EA	1
DPE402120	2	40	120	EA	1
DPE40224	2	40	24	EA	1
DPE402240	2	40	240	EA	1
DPE402480	2	40	480	EA	1
DPE602120	2	60	120	EA	1

**Eaton Contactor Accessories**

These auxiliary contacts are side mounted contact kits for Eaton's definite purpose contactors with contact rating of 15A to 75A.



CATALOG NO.	DESCRIPTION	UOM	ORDER MULTIPLE
DPEAUX10	15-75A, 1NO	EA	1
DPEAUX11	15-75A, 1NO-1NC	EA	1
DPEAUX11QC	15-75A, 1NO-1NC with Quick Connect	EA	1
DPEAUX20	15-75A, 2NO	EA	1
DPEAUX22	25-75A, 2NO-2NC	EA	1

## TRANSFORMERS

### Transformers – Class 2 1585 UL Recognized

The transformers provide the power source for heating, air conditioning, or refrigeration systems.



CATALOG NO.	VA	PRI	SEC	UOM	ORDER MULTIPLE
T1401	40	120	24	EA	1
T1404	40	120/208/240	24	EA	1

### Transformers – Class 2 1585 UL Recognized

The transformers provide the power source for heating, air conditioning, or refrigeration systems.

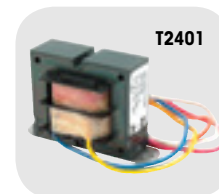

CATALOG NO.	VA	PRI	SEC	UOM	ORDER MULTIPLE
T2401	40	120	24	EA	1
T2403	40	208/240	24	EA	1
T2404	40	120/208/240	24	EA	1

### Transformers – Class 2 1585 UL Recognized

The transformers provide the power source for heating, air conditioning, or refrigeration systems. These are multi mounted with wire connection secondary.



CATALOG NO.	VA	PRI	SEC	UOM	ORDER MULTIPLE
T3401	40	120	24	EA	1
T3403	40	120/208/240	24	EA	1
T3501	50	120/208/240	24	EA	1
T5401	40	120	24	EA	1

### Transformers – Class 2 1585 UL Recognized

Heavy duty with external fuse (T67XX) or circuit breaker (T77XX).



CATALOG NO.	VA	PRI	SEC	UOM	ORDER MULTIPLE
T6752	75	120/208/240	24	EA	1
T6753	75	120/208/240/480	24	EA	1
T7752	75	120/208/240/480	24	EA	1

## RELAYS

### General Purpose Relays – 9400 Series

This product features quick connect terminals with universal mounting with break away tabs.

CATALOG NO.	DESCRIPTION	AMPS RES	FLA/LRA@125V	FLA/LRA@250V	COIL VOLTAGE	UOM	ORDER MULTIPLE
D90-360	SPST-NO	18	12/60	8/48	24 VAC	EA	1
D90-370	SPDT	18	12/60	8/48	24 VAC	EA	1
D90-372	SPDT	18	12/60	8/48	120 VAC	EA	1
D90-380	SPST NO+NC	18	12/60	8/48	24 VAC	EA	1
D90-382	SPST NO+NC	18	12/60	8/48	120 VAC	EA	1
D90-384	SPST NO+NC	18	12/60	8/48	240 VAC	EA	1



### General Purpose Relays – 8400 Series

This product features quick connect terminals with universal mounting with break away tabs.



CATALOG NO.	DESCRIPTION	AMPS RES/IND	COIL VOLTAGE	UOM	ORDER MULTIPLE
D90-290Q	SPST-NO	16/8	24 VAC	EA	1
D90-291Q	SPST-NO	16/8	120 VAC	EA	1
D90-292Q	SPST-NO	16/8	240 VAC	EA	1
D90-293Q	SPDT	8/8	24 VAC	EA	1
D90-294Q	SPDT	8/8	120 VAC	EA	1
D90-295Q	SPDT	8/8	240 VAC	EA	1

### Potential Relays

The Potential Relay has SPST NC configurations and offers a variety of mounting positions.



CATALOG NO.	COIL VOLTAGE	PICK-UP MIN	PICK-UP MAX	DROP-OUT MAX	UOM	ORDER MULTIPLE
DPR063	168	140	153	45	EA	1
DPR064	395	242	272	140	EA	1
DPR066	395	223	252	130	EA	1

### General Purpose Switching Relays

The Switching Relay has quick connect terminals for termination. The base is designed for easy replacement of competitive relays.



CATALOG NO.	COIL VOLTAGE	TERMINALS 1-2-3	TERMINALS 4-5-6	UOM	ORDER MULTIPLE
D-90340	24	POWER	POWER	EA	1
D-90341	110/120	POWER	POWER	EA	1
D-90342	208/240	POWER	POWER	EA	1

**FAN CENTERS**

**Fan Centers**

The fan centers offer low voltage for one and two speed fan motors; auxiliary circuits in heating cooling, or heating/ cooling applications. This has a DPDT Relay and is UL rated. There are color coded pre stripped leads on this center. This product has a 24V coil voltage, power, and duty rated contacts. It mounts directly to a 4in. electrical box.



CATALOG NO.	VOLTAGE	UOM	ORDER MULTIPLE
<b>D-90113</b>	120	EA	1
<b>D-90118</b>	208/240	EA	1

**FUSES**

**Dual Element Fuses – 250V**

Provides time delay for temporary over current conditions and motor running protection for heating and air conditioning equipment. Eliminates unnecessary maintenance from harmless overloads. U.L. Class RK 5, Standard for Safety 198E, Current Limiting Fuses, Interrupting Rating 200,000 Amps. rms. A.C.



CATALOG NO.	DESCRIPTION	UOM	ORDER MULTIPLE
<b>7-CRRR15</b>	15 Amps	EA	10
<b>7-CRRR20</b>	20 Amps	EA	10
<b>7-CRRR25</b>	25 Amps	EA	10
<b>7-CRRR30</b>	30 Amps	EA	10
<b>7-CRRR35</b>	35 Amps	EA	10
<b>7-CRRR40</b>	40 Amps	EA	10
<b>7-CRRR45</b>	45 Amps	EA	10
<b>7-CRRR50</b>	50 Amps	EA	10
<b>7-CRRR60</b>	60 Amps	EA	10
<b>7-CRRR70</b>	70 Amps	EA	5
<b>7-CRRR80</b>	80 Amps	EA	5
<b>7-CRRR90</b>	90 Amps	EA	5
<b>7-CRRR100</b>	100 Amps	EA	5

U.L. Class RK-5, Standard for Safety 198E, Current Limiting Fuses, Interrupting Rating 200,000 Amps. rms. A.C.

**Time Delay Fuses – 600V**

These plugs offer safe protection during momentary overload. No adapter necessary. U.L. Listed., Class RK5



CATALOG NO.	DESCRIPTION	UOM	ORDER MULTIPLE
<b>626-HASR10</b>	10 Amp	EA	10
<b>626-HASR15</b>	15 Amp	EA	10
<b>626-HASR20</b>	20 Amp	EA	10
<b>626-HASR25</b>	25 Amp	EA	10
<b>626-HASR30</b>	30 Amp	EA	10
<b>626-HASR40</b>	40 Amp	EA	10
<b>626-HASR60</b>	60 Amp	EA	10

U.L. Listed.

**One Time Fuses**

Protection to lighting, heating, and other non transient circuits. U.L. Class K5, Standard for Safety 1988, One Time Fuse Interrupting Rating 10,000 Amps. rms. A.C., 250 VAC/VDC



CATALOG NO.	DESCRIPTION	UOM	ORDER MULTIPLE
<b>7-10KOTN30</b>	30 Amps	EA	10
<b>7-10KOTN35</b>	35 Amps	EA	10
<b>7-10KOTN40</b>	40 Amps	EA	10
<b>7-10KOTN45</b>	45 Amps	EA	10
<b>7-10KOTN50</b>	50 Amps	EA	10
<b>7-10KOTN60</b>	60 Amps	EA	10
<b>7-10KOTN70</b>	70 Amps	EA	5
<b>7-10KOTN80</b>	80 Amps	EA	5
<b>7-10KOTN90</b>	90 Amps	EA	5
<b>7-10KOTN100</b>	100 Amps	EA	5

U.L. Class K5, Standard for Safety 1988, One Time Fuse Interrupting Rating 10,000 Amps. rms. A.C.

**Time Delay Plug Fuses**

These plugs offer safe protection during momentary overload. No adapter necessary. U.L. Listed.



CATALOG NO.	DESCRIPTION	UOM	ORDER MULTIPLE
<b>626-10T</b>	Type "T" Plug Fuse – 10 Amp	EA	4
<b>626-15T</b>	Type "T" Plug Fuse – 15 Amp	EA	4
<b>626-20T</b>	Type "T" Plug Fuse – 20 Amp	EA	4
<b>626-25T</b>	Type "T" Plug Fuse – 25 Amp	EA	4
<b>626-30T</b>	Type "T" Plug Fuse – 30 Amp	EA	4

U.L. Listed.

**FUSES** cont'd

**Plug Fuses**

Expels gases caused by the blowing fuse, but doesn't allow flame to escape. Glass top for safety against shock. Positive visual indication of OK condition or blown condition. Distinguishes between overload and dead short conditions. Magnifying center of face. Shapes of face openings identify ratings. Meets Federal Specification WF 791E/Gen. Type 791/1. Base "W" fuses. U.L. Listed.



CATALOG NO.	DESCRIPTION	UOM	ORDER MULTIPLE
<b>626-15</b>	Plug Fuse Type TL – 15 Amp	EA	4
<b>626-20</b>	Plug Fuse Type TL – 20 Amp	EA	4
<b>626-25</b>	Plug Fuse Type TL – 25 Amp	EA	4
<b>626-30</b>	Plug Fuse Type TL – 30 Amp	EA	4

U.L. Listed.

**In-Line Fuse Holder**

For fusing all control circuits up to 30 amp. Features rigid plastic protective covering for each fuse. Used on AC and DC circuits. U.L. Listed.

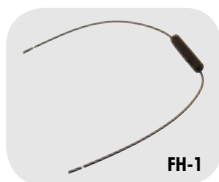

CATALOG NO.	DESCRIPTION	UOM	ORDER MULTIPLE
<b>FH-1</b>	In-Line Fuse Holder, Pack of 10	EA	1

U.L. Listed.

**Fuse Pullers**

Our fuse pullers are used to safely pull fuses.



CATALOG NO.	DESCRIPTION	UOM	ORDER MULTIPLE
<b>626-38071</b>	Fuse Puller – For Fuse Sizes 1/4" to 1/2"	EA	1
<b>626-38073</b>	Fuse Puller – For Fuse Sizes 1" to 1-3/4"	EA	1

**Fuseblocks**

The fuse blocks are designed to allow the fuse to blow or burn out before the component can be damaged.

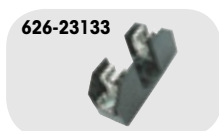

CATALOG NO.	DESCRIPTION	UOM	ORDER MULTIPLE
<b>626-23133</b>	Fuseblock – 1 Pole Screw Class H, 250V	EA	1
<b>626-26311</b>	Fuseblock – 3 Pole Box Lug Class H, 250V	EA	1

**Type "S" Non-Tamper Fuses**

Provides specific overcurrent protection. Time delay element protects against premature blowing from motors in air conditioners or compressors. Visual indication of good or blown condition. U.L. Listed. C.S.A. Approved.



CATALOG NO.	DESCRIPTION	UOM	ORDER MULTIPLE
<b>626-6S</b>	Type "S" Fuse – 6.25 Amp	EA	4
<b>626-10S</b>	Type "S" Fuse – 10 Amp	EA	4
<b>626-15S</b>	Type "S" Fuse – 15 Amp	EA	4
<b>626-20S</b>	Type "S" Fuse – 20 Amp	EA	4
<b>626-30S</b>	Type "S" Fuse – 30 Amp	EA	4

U.L. Listed. C.S.A. Approved.

**Blade (Auto) Fuses**

These fuses are fast acting low voltage supplementary fuses, automotive blade style fuse.



CATALOG NO.	DESCRIPTION	UOM	ORDER MULTIPLE
<b>626-AT0003</b>	Blade Fuse – 3 Amp – Purple, pack of 5	EA	100
<b>626-AT0005</b>	Blade Fuse – 5 Amp – Tan, pack of 5	EA	100

**Fuse Adapters**

Fuse adapters are used to retrofit fuses into existing installations.



CATALOG NO.	DESCRIPTION	UOM	ORDER MULTIPLE
<b>626-38632</b>	Fuse Adapter – 60 to 30 Reducer for Class H, 250V	EA	1
<b>626-38636</b>	Fuse Adapter – 60 to 30 Reducer for Class H, 600V	EA	1

**Box Cover Units**

The maximum amps on this box cover unit are 15 and the maximum AC voltage of 125. These units are designed for use with the Type T plug fuses. U.L. Listed and C.S.A. Certified.



CATALOG NO.	DESCRIPTION	UOM	ORDER MULTIPLE
<b>620-608</b>	Switch/Fuse Combo (ESSU)	EA	1
<b>620-6081</b>	Plug Fuse Base Only (ESOU)	EA	1
<b>620-6082</b>	Receptacle/Fuse Combo (ESRU)	EA	1
<b>620-6083</b>	Switch/Fuse Combo Square (ESSY)	EA	1

U.L. Listed and C.S.A. Certified.

**TIME DELAYS**

**Adjustable Delay on Break Timer**

Adjusts from 6 seconds to 8 minutes. Spin-proof knob. Works with 24, 120 or 240 VAC control circuits. Supports up to 1.0 Amps. Two wire hookup for easy installation. Solid state with quick disconnect terminals. Mounts with one self-tapping screw. Conformal coated circuitry protects against moisture and shock. UR recognized for USA and Canada. Works with anticipator type thermostats.

**HOW IT WORKS:** Immediately upon application of power, the Delay on Break timer enables circuit operation. Once power is interrupted, the circuit opens for the time set on the dial. After the time period elapses, the circuit closes, allowing the protected motor or compressor to start. For typical HVAC applications, the operation of the timer is transparent and will go unnoticed.



**Adjustable Delay on Make Timer**

Ideal for random starting of multiple units. Adjusts from 6 seconds to 8 minutes. Spin proof knob. Works with 24, 120 or 240 VAC control circuits. Supports up to 1.0 Amps. Two wire hookup for easy installation. Solid state with quick-disconnect terminals. Mounts with one self-tapping screw. Conformal coated circuitry protects against moisture and shock. UR recognized for US and Canada. Works with anticipator type thermostats.

**HOW IT WORKS:** These timers delay circuit closure upon application of power. Only after the set time period elapses and power remains ON will the circuit close, allowing the protected motor or compressor to start. For typical HVAC installations, timers are adjusted to random times to prevent power circuit overloads, thus are often called random start timers.



CATALOG NO.	DESCRIPTION	UOM	ORDER MULTIPLE
<b>ADB-1</b>	Adjustable Delay on Break	EA	1
<b>ADB-2</b>	Adjustable Delay on Break w/Wire Leads	EA	1

CATALOG NO.	DESCRIPTION	UOM	ORDER MULTIPLE
<b>ADM-1</b>	Adjustable Delay on Make	EA	1
<b>ADM-2</b>	Adjustable Delay on Make w/Wire Leads	EA	1

**MONITORS**

**Digital Three Phase Line Voltage Monitor**

Offers continuous protection against voltage anomalies which can damage compressors, motors and other sensitive electrically operated devices.

**PROTECTION:** Loss of Phase, Phase Reversal, Voltage Imbalance, Low Voltage, High Voltage

**DISPLAY:** Large custom LCD display indicates all operating conditions at a glance. Three large sets of digits provide easy system troubleshooting.

**VOLTMETER:** Three independent voltmeters read both line and contactor load (backside) voltages.

**MONITORED VOLTAGE:** 160 to 600 Volts 50-60 Hz.

**POWER SUPPLY:** Power for the WPC-500 is automatically derived from any active phase. System operation is not dependent on the control voltage or a specific phase for power.

**CONTROL VOLTAGE:** 19-277 VAC. Anticipator load is provided for operation with 24 volt electronic and mechanical thermostats.

**OPERATING VOLTAGE SET POINT:** 175 to 650 VAC. Digitally adjustable in one volt increments.

**VOLTAGE TRIP POINT:** Adjustable in 1% increments between 6% and 18% of selected operating voltage. Restart voltage set point (hysteresis) fixed at cutout voltage + 3%.

**VOLTAGE SYMMETRY:** Adjustable imbalance trip point from 2% to 25% of selected operating voltage.

**RESPONSE TIMES:**

Phase Loss/Reversal: 100 mS max.

Imbalance: Adjustable Response Timer

Over or Under Voltage: Adjustable Response Timer  
**LOCKOUT DELAY TIMER:** Fully adjustable 0 to 720 Seconds (0 to 12 minutes). Digital display shows re-remaining time and user set points.

**SEQUENTIAL START TIMER:** 0 to 30 seconds in one second increments.

**RESPONSE TIMER:** 0.1 to 20 Seconds. Digital display shows remaining time and user set points.

**MEMORY:** Up to 25 past fault conditions are stored for later retrieval and analysis. The faults may be displayed or cleared by the front panel buttons.



**Digital Single Phase Line Voltage Monitor**

Automatic voltage monitor and control system. Continuously measures incoming line voltage, allowing detection of any voltage outside the tolerances that you set. If these limits are exceeded, the response timer begins counting. You may also set response time – a short time for a quick response or a long time to avoid nuisance tripping. If the voltage remains outside the tolerance after the time has elapsed, the DSP-1 will turn off its output relay and protect your device. While output is off, an additional delay timer activates to avoid rapid restarts.

**FEATURES:**

- Digital voltmeter displays instantaneous line voltage;
- Automatic voltage tester adjusts from 90 to 300 volts;
- Adjustable response timer (0.1 to 10 sec.) prevents nuisance tripping;
- Adjustable delay timer (1 to 720 sec.) prevents rapid restarts;
- Digital display makes for easy viewing and operation

**SPECIFICATIONS:**

- Voltmeter: 70 to 325 Volts
- Voltage Set Point: 90 to 300 Volts
- Tolerance Limits: 6 to 18%
- Response Timer: 0.1 to 10 seconds
- Delay Timer: 1 to 720 seconds
- Output Relay: 10 Amps, 250 VAC resistive, single-pole/double-throw
- Control Input: 18 to 250 VAC with anticipator load for 24 volt thermostats



CATALOG NO.	DESCRIPTION	UOM	ORDER MULTIPLE
<b>DTP-3</b>	Digital 3-Phase Motor Protector	EA	1

CATALOG NO.	DESCRIPTION	UOM	ORDER MULTIPLE
<b>DSP-1</b>	Digital Single Phase Motor Protector	EA	1

## SURGE PROTECTORS

### Surge-Trap Type 1 STXH

The most compact of the STX series offering, the Surge-Trap® Type 1 STXH meets requirements for UL1449 4th Edition and is suitable for any 120/240VAC split phase application. The STXH Series SPD features TPMOV® technology inside making it the safest product available in its category. Its compact size, performance and reliability are especially ideal for HVAC applications and direct mounting to air condition disconnect switches.



CATALOG NO.	DESCRIPTION	UPC	UOM	ORDER MULTIPLE
<b>STXH120P05</b>	STXH Type 1 50kA 120V Single Phase	0782001472511	EA	1
<b>STXH240S05</b>	Fuseblock - 3 Pole Box Lug Class H, 250V	0782001472504	EA	1

### Surge-Trap Type 1 STXR

The most popular range in the STX series offering, the Surge-Trap® Type 1 STXR meets requirements for UL1449 4th Edition and is ideal for the replacement of obsolete surge arrestors. The STXR Series SPDs feature TPMOV® technology inside, making them the safest product available. With a small, compact design and line or load installation flexibility, the STXR series is the perfect fit for branch panel and/or individual equipment protection.



CATALOG NO.	DESCRIPTION	UPC	UOM	ORDER MULTIPLE
<b>STXR208Y05N</b>	STXR Type 1 50kA 208Y/120V N-G	0782001469962	EA	1
<b>STXR480Y05N</b>	STXR Type 1 50kA 480Y/277V N-G	0782001469986	EA	1
<b>STXR240D05</b>	STXR Type 1 50kA 240V 3-Phase DELTA	0782001469900	EA	1
<b>STXR480D05</b>	STXR Type 1 50kA 480V 3-Phase DELTA	0782001469917	EA	1
<b>STXRMBK</b>	STXR Surge Protector Mounting Bracket Kit	0782001470760	EA	1

## ELECTRICAL SUPPLIES

### Electrical Toggle Switches

Side wire design with automatic grounding and large binding head terminal screws for fast wiring. Lubricated cam provides smooth lever action. U.L. Listed. C.S.A. Certified. Verified to Federal Spec. WS896E



CATALOG NO.	DESCRIPTION	UOM	ORDER MULTIPLE
<b>620-600</b>	20A-1 HP 120V, Single Pole, Brown	EA	10
<b>620-601</b>	20A-1 HP 120V, Single Pole, Ivory	EA	10
<b>625-CS120W</b>	20A-1HP 120V Single Pole, White	EA	10
<b>625-1301W</b>	15A-1/2HP 120V Single Pole, White	EA	10
<b>620-604</b>	15A-1/2 HP 120V, Single Pole, Brown	EA	10
<b>620-605</b>	15A-1/2 HP 120V, Single Pole, Ivory	EA	10

U.L. Listed. C.S.A. Certified. Verified to Federal Spec. WS896E.

### Electrical Duplex Receptacles

Automatic grounding for fast installation. Heavy duty mounting strap for additional assembly strength. Copper alloy power/ground contacts for optimum continuity. Side wire design with large binding head terminal screws for fast wiring. U.L. Listed. C.S.A. Certified (NEMA 5 15 Type).



CATALOG NO.	DESCRIPTION	UOM	ORDER MULTIPLE
<b>620-700</b>	15A, 125V, Brown	EA	10
<b>620-701</b>	15A, 125V, Ivory	EA	10
<b>625-CR15W</b>	15A 125V, White	EA	10
<b>620-702</b>	20A, 125V, Brown	EA	10
<b>620-703</b>	20A, 125V, Ivory	EA	10
<b>625-CR20W</b>	20A 125V, White	EA	10
<b>620-704</b>	15A, 125V, Brown - Residential	EA	10
<b>620-705</b>	15A, 125V, Ivory - Residential	EA	10
<b>625-270W</b>	15A 125V, White - Residential	EA	10

U.L. Listed. C.S.A. Certified (NEMA 5-15 Type).

### Electrical Outlet Boxes, Extensions and Covers

We have 4in. steel square boxes, extensions, and covers available. Conforms to Article 370 of NEC. U.L. Listed.



CATALOG NO.	DESCRIPTION	UOM	ORDER MULTIPLE
<b>620-401</b>	2-1/8" Deep, 1/2" and 3/4" K.O.s	EA	25
<b>620-403</b>	1-1/2" Deep, 1/2" K.O.s	EA	50
<b>620-404</b>	1-1/2" Deep, 1/2" and 3/4" K.O.s Extension	EA	50
<b>620-406</b>	Flat Blank Cover	EA	50
<b>620-409</b>	Flat, One Duplex Receptacle Cover	EA	50
<b>620-411</b>	One Switch and One Duplex Receptacle Cover	EA	50

Conforms to Article 370 of NEC. U.L. Listed.

**ELECTRICAL SUPPLIES** cont'd

**Electrical Outlet Boxes, Extensions and Covers**

Standard steel utility (Handy) boxes and covers.



CATALOG NO.	DESCRIPTION	UOM	ORDER MULTIPLE
620-200	1-1/2" Deep, 1/2" K.O.s	EA	50
620-201	1-7/8" Deep, 1/2" K.O.s	EA	50
620-202	2-1/8" Deep, 1/2" K.O.s	EA	50
620-252	Flat, Two Duplex Receptacle Cover	EA	100
620-253	Flat, Toggle Switch Cover	EA	100
620-254	Flat Blank Cover	EA	100
620-255	Flat Cover 1/2" K.O.	EA	100

Conforms to Article 370 of NEC. U.L. Listed.

**Switch Covers**

Our switch covers come with gas, oil, or emergency already printed on them.



CATALOG NO.	SIZE	TYPE	DESCRIPTION	UOM	ORDER MULTIPLE
625-S17	4" X 4"	Gas	4" Square Box	EA	10
625-S16	4-1/4" X 2-3/4"	Gas	Utility/Handy Box	EA	1
625-S15	4-1/2" X 2-1/2"	Gas	Flush Mount	EA	25
625-S14	4" X 4"	Oil	4" Square Box	EA	1
625-S13	4-1/4" x 2-3/4"	Oil	Utility/Handy Box	EA	1
625-S19	4-1/2" X 2-1/2"	Oil	Flush Mount	EA	1
625-S20	4-3/4" X 2-1/2"	Emergency	Switch Plate	EA	1
625-S18	3/4"		Switch Guard (Wall plate/ switch not included)	EA	1

**Eaton Circuit Breakers - Type CH**

Type CH Circuit Breakers are 3/4-inch per pole plug-on circuit breakers designed for Eaton's Type CH Loadcenters. They are 10 kAIC arc fault circuit interrupters rated for 120VAC or 240VAC applications.



CATALOG NO.	DESCRIPTION	UOM	ORDER MULTIPLE
CH115	Single Pole, 15A	EA	10
CH120	Single Pole, 20A	EA	10
CH215	Two Pole, 15A	EA	5
CH220	Two Pole, 20A	EA	5
CH230	Two Pole, 30A	EA	5
CH240	Two Pole, 40A	EA	5
CH250	Two Pole, 50A	EA	5
CH260	Two Pole, 60A	EA	5

**Plastic Wall Plates**

Non flammable thermoplastic, phenolic or urea material. Color matched 1/2in. long steel mounting screws furnished. Smooth surface – no recessed areas to collect dirt, discolor. Easy to clean. Full weight and thickness provide high dielectric strength, minimum moisture absorption, impact resistance. Warp resistant, fit flush to wall. U.L. Listed. C.S.A. Approved.



CATALOG NO.	DESCRIPTION	UOM	ORDER MULTIPLE
625-2132B	Duplex Receptacle Cover – Brown	EA	25
625-2132V	Duplex Receptacle Cover – Ivory	EA	10
625-2132W	Duplex Receptacle Cover – White	EA	10
625-2134V	Single Toggle Cover – Ivory	EA	25
625-2134W	Single Toggle Cover – White	EA	25

U.L. Listed. C.S.A. Approved.

**Switch/Plug Combo**

Use with air handlers and condensate pumps. Touch-A-Matic design, with exclusive spring loaded steel ball mechanism for smooth, positive contact movement. Small neon pilot light ON when switch is ON, is built-in to the switch on switch/receptacle.



CATALOG NO.	DESCRIPTION	UOM	ORDER MULTIPLE
620-274W	White 2P 3W Grounding—15A 120V	EA	10

U.L. Listed. C.S.A. Approved.

**Eaton Circuit Breakers - Type BR**

Type BR Circuit Breakers are 1-inch per pole plug-on circuit breakers designed for Eaton's Type BR Loadcenters. They are 10 kAIC arc fault circuit interrupters rated for 120VAC or 240VAC applications.



CATALOG NO.	DESCRIPTION	UOM	ORDER MULTIPLE
BR115	Single Pole, 15A	EA	10
BR120	Single Pole, 20A	EA	10
BR130	Single Pole, 30A	EA	10
BR215	Two Pole, 15A	EA	5
BR220	Two Pole, 20A	EA	5
BR230	Two Pole, 30A	EA	5
BR240	Two Pole, 40A	EA	5
BR250	Two Pole, 50A	EA	5
BR260	Two Pole, 60A	EA	5
BR2100	Two Pole, 100A	EA	5



### Toggle Switches

These switches are available in single pole double pole. They are UL listed and furnished with screw terminals. The ratings are A:20A 125VAC, 20 250 VAC, 1 HP at 120 240 V and B 15A 125/250 VAC, ¾ HP at 240 V.



CATALOG NO.	DESCRIPTION	RATING	UOM	ORDER MULTIPLE
TS-1	Toggle Switch – SP-ST – ON/OFF	A	EA	1
TS-3	Toggle Switch – SP-DT-CO – ON/OFF/ON	B	EA	1
TS-4	Toggle Switch – DP-ST – ON/OFF	A	EA	1
TS-5	Toggle Switch – DP-DT – ON/OFF	A	EA	1

### Replacement Power Supply Cord

- Extends power cords for refrigerators, microwaves, air conditioners and other appliances
- Stripped at one end and angled male plug at other end
- 3-Prong flat cord
- 125VAC



CATALOG NO.	WIRE GAUGE/CONDUCTORS	AMPS	LENGTH	UOM	ORDER MULTIPLE
89223	14/3	15	6'	EA	50

### Dryer Cords

- Thick vinyl insulation with right angle male plug
- 4 Wire - 10/4 Round SRDT Wire
- NEMA 14-30
- 30 Amp @ 125V/250V



CATALOG NO.	WIRE GAUGE/CONDUCTORS	LENGTH	UOM	ORDER MULTIPLE
89231	10/4	4'	EA	12
89233	10/4	6'	EA	12

### Right Angle Tri-Tap Portable GFCI

- For indoor or temporary outdoor use
- Provides portable protection on tools, appliances, outdoor equipment, etc.
- Great for jobsites, workshops or marinas
- 3 outlet power cord GFCI protection against hazardous shock
- 15 Amp 120 Volt
- Automatic Reset
- Class A GFCI 4-6mA Trip
- 1875 Watt
- Grounded & Open Neutral Protection
- Insulation Volts: 1500 V RMS
- NEMA 5-15P & (3) 5-15R
- 2' 12/3 AWG SSJTW Cord
- Rainproof
- Complies with NEC 305-6
- Operating Temperature: -31°F to 151°F (-35°C to 66°C)



CATALOG NO.	DESCRIPTION	UOM	ORDER MULTIPLE
89000	Right Angle Tri-Tap Portable GFCI	EA	24

### Toggle Switch Cover

Weatherproof body for toggle switches up to 15/16" long.



CATALOG NO.	DESCRIPTION	UOM	ORDER MULTIPLE
625-B1	Toggle Switch Cover	EA	5

### Power Supply Cord (Pigtails)

Stranded bare copper conductors. Grounding conductors. PVC jacket. Right and straight angle male plug. 110 Volt. 16 AWG x 6' long. SPT 2.



CATALOG NO.	DESCRIPTION	UOM	ORDER MULTIPLE
625-16-6	Power Supply Cord – Straight Plug	EA	50
625-16-690	Power Supply Cord – 90 Degree Plug	EA	50

### Generator Power Cord Sets

- 20 Amp & 30 Amp Cord Sets are designed for use with manual transfer switches, transfer panels and power inlet boxes
- One Piece molded Cord Plugs
- L14 Twist Lock Male/Female Receptacles
- 300 Volt SJTOW Rubber Cord
- -30°F (-34°C) Outdoor Use & Oil Resistant
- L14-20P
- L14-20R
- L14-30P
- L14-30R



CATALOG NO.	AMPS	SIZE	LENGTH	NEMA#	MAX GEN INPUT	UOM	ORDER MULTIPLE
89350	30	10/4	20'	L14-30	7.5 KW	EA	6

### Range Cords

- Thick vinyl insulation with right angle male plug
- 4 Wire - 6/2 & 8/2 round SRDT Wire
- NEMA 14-60
- 50A @ 125V/250V



CATALOG NO.	WIRE GAUGE/CONDUCTORS	LENGTH	UOM	ORDER MULTIPLE
89236	6/2+8/2	4'	EA	12
89238	6/2+8/2	6'	EA	12

### Heavy Duty Tri-Tap Extension Cord - 3 Outlets

- Heavy Duty 2 Foot Extension Cord with Prong Plug & Lighted Block Style Receptacles
- 15A 125V 12/3 STW Cord with Molded Plug Receptacle
- Lighted Female End to detect power
- Approved under OSHA Standards for Outdoor and Indoor Use



CATALOG NO.	LENGTH	UOM	ORDER MULTIPLE
89312	2'	EA	20

**ELECTRICAL SUPPLIES** cont'd

**In-Line Tri-Tap Portable GFCI**



- For indoor or temporary outdoor use
- Provides portable protection on tools, appliances, outdoor equipment, etc.
- Great for jobsites, workshops or marinas
- 3 outlet power cord GFCI protection against hazardous shock
- 15 Amp 120 Volt
- Automatic Reset
- Class A GFCI 4-6mA Trip
- 1875 Watt
- Grounded & Open Neutral Protection
- Insulation Volts: 1500 V RMS
- NEMA 5-15P & (3) 5-15R
- 2' 12/3 AWG SSJTW Cord
- Rainproof
- Complies with NEC 305-6
- Operating Temperature: -31°F to 151°F (-35°C to 66°C)

CATALOG NO.	DESCRIPTION	UOM	ORDER MULTIPLE
89006	In-Line Tri-Tap Portable GFCI	EA	24

**Single Portable GFCI Adapter**



- GFCI Protected Plug Only
- Fits any standard 3 wire outlet
- Provides instant GFCI protection
- Immediately detects ground fault from damaged cords or exposure to water and shuts off power to avoid electrocution
- 15 Amp 120 Volt
- Automatic Reset
- Class A GFCI 4-6mA Trip
- 1875 Watt
- Grounded & Open Neutral Protection
- Insulation Volts: 1500 V RMS
- NEMA 5-15P & 5-15R
- 2' 12/3 AWG SSJTW Cord
- Rainproof
- Complies with NEC 305-6
- Operating Temperature: -31°F to 151°F (-35°C to 66°C)

CATALOG NO.	DESCRIPTION	UOM	ORDER MULTIPLE
89002	Single Portable GFCI Adapter	EA	24

**4-Outlet GFCI Power Pack**



- Automatic Reset
- Right Angle GFCI Plug with power 'ON' LED indicator
- (4) NEMA 5-15R Outlets with separate covers for each outlet
- (1) NEMA 5-15P Plug
- 15 Amp 120 Volt
- 6' 12/3 SJTW Cord
- 15A Circuit Breaker
- Automatic Reset
- Class A GFCI 4-6mA Trip
- 1875 Watt
- Grounded & Open Neutral Protection
- Insulation Volts: 1500 V RMS
- Complies with NEC 305-6
- Operating Temperature: -31°F to 151°F (-35°C to 66°C)



CATALOG NO.	DESCRIPTION	UOM	ORDER MULTIPLE
89008	4-Outlet GFCI Power Pack	EA	24

**Right Angle GFCI Plug - Field Wired**



- User Attachable
- Compatible with 15 Amp U-ground outlets and plugs
- Trip Level 4-6 mA
- Automatic Reset
- Rated for indoor and outdoor use
- Class "A" people protection and GFCI
- 15 Amp 120 Volt
- 1875 Watts, 60 Hz
- LED Power 'ON' Indicator
- Open Neutral and Ground Neutral protection
- Operating Temperature: -31°F to 151°F (-35°C to 66°C)
- Impact resistant case



CATALOG NO.	DESCRIPTION	UOM	ORDER MULTIPLE
89003	Right Angle GFCI Plug - Field Wired	EA	63

**5-Outlet GFCI Shock Buster**



- GFCI Protected
- Plug into any 3-prong dual outlet
- Converts electrical outlet into a safety outlet
- Ideal for family TV rooms, dens, dormitory rooms, garage workshops and rec-rooms
- Protects from damaged electrical cords and hazardous electrical leakage levels
- Quick power shut off to avoid electrocution
- Built-in sensing device to detect leakage currents as low as 4mA
- 15 Amp 120 Volt



CATALOG NO.	DESCRIPTION	UOM	ORDER MULTIPLE
89009	5-Outlet GFCI Shock Buster	EA	60

**ELECTRICAL TAPES**

**7 Mil Professional Grade Electrical Tape**

- 3/4" x 66' x 7 Mil
- All Weather Professional Grade Splicing Tape used as primary insulation up to 600V and as a protective outer jacket up to 69KV
- Flame retardant and weather resistant
- Excellent cold weather resistant properties -1°F to 221°F (-18°C to 105°C)
- High dielectric strength, high adhesion and shear
- Highly elastic polymeric vinyl backing - excellent elongation
- Resistant to acids, alkalis, chemicals, oils, moisture and corrosion
- UL 510 and CSA 22.2 approved
- ASTM-D-3005 HH-I-595C
- Lead free



CATALOG NO.	COLOR	SIZE	PACKAGING TYPE	UOM	ORDER MULTIPLE
<b>60110</b>	Black	3/4" x 66'	Plastic Cup	EA	100

**7 Mil Commercial Grade Electrical Tape**

- 3/4" x 66' x 7 Mil
- Used for General Purpose Splicing as primary insulation to 600V and as a protective outer jacket at higher voltages
- Flame retardant and weather resistant
- Cold weather resistant -1°F to 221°F (-18°C to 105°C)
- Good dielectric strength, high adhesion and shear
- Resistant to acids, alkalis, chemicals, oils, moisture and corrosion
- UL 510 and CSA 22.2 approved
- MIL-I-7798A
- Lead free



CATALOG NO.	COLOR	SIZE	PACKAGING TYPE	UOM	ORDER MULTIPLE
<b>60100</b>	Black	3/4" x 66'	Cello	EA	100

**General Purpose Vinyl Electrical Tape**

- 3/4" x 60' x 7 Mil
- Used for protective jacketing & bundling/harnessing
- Resistant to acids, alkalis, chemicals, oils, moisture, sunlight and corrosion
- Flame retardant and weather resistant
- UL 510 and CSA 22.2 approved
- Lead free
- 600V



CATALOG NO.	COLOR	PACKAGE TYPE	SLEEVE QTY	UOM	ORDER MULTIPLE
<b>60000</b>	Black	Cello	10	EA	100
<b>60010</b>	Red	Cello	10	EA	100
<b>60020</b>	White	Cello	10	EA	100
<b>60030</b>	Yellow	Cello	10	EA	100
<b>60040</b>	Green	Cello	10	EA	100
<b>60050</b>	Blue	Cello	10	EA	100
<b>60070</b>	Orange	Cello	10	EA	100

**8.5 Mil Professional Grade Heavy Duty Electrical Tape**

- 3/4" x 66' x 8.5 Mil
- Heavier thickness for added mechanical & electrical protection
- All Weather Professional Grade Splicing Tape used as primary insulation up to 600V and as a protective outer jacket up to 69KV
- Flame retardant and weather resistant
- Excellent cold weather resistant properties -1°F to 221°F (-18°C to 105°C)
- High dielectric strength, high adhesion and shear
- Highly elastic polymeric vinyl backing - excellent elongation
- Resistant to acids, alkalis, chemicals, oils, moisture and corrosion
- UL 510 and CSA 22.2 approved
- ASTM-D-3005 HH-I-595C
- Lead free



CATALOG NO.	COLOR	SIZE	PACKAGING TYPE	UOM	ORDER MULTIPLE
<b>60205</b>	Black	3/4" x 66'	Plastic Cup	EA	100
<b>60206</b>	Black	2" x 66'	Cello	EA	40

**8.5 Mil Commercial Grade Electrical Tape**

- 3/4" x 66' x 8.5 Mil
- Heavier thickness for added mechanical & electrical protection
- Used for General Purpose Splicing as primary insulation to 600V and as a protective outer jacket at higher voltages
- Flame retardant and weather resistant
- Cold weather resistant -1°F to 221°F (-18°C to 105°C)
- Good dielectric strength, high adhesion and shear
- Resistant to acids, alkalis, chemicals, oils, moisture and corrosion
- UL 510 and CSA 22.2 approved
- MIL-I-7798A
- Lead free



CATALOG NO.	COLOR	SIZE	PACKAGING TYPE	UOM	ORDER MULTIPLE
<b>60200</b>	Black	3/4" x 66'	Cello	EA	100
<b>60202</b>	Black	2" x 66'	Cello	EA	40

**Scotch 3M Super 33+ Electrical Tape**

Premium grade, 7 mil thick, all-weather vinyl insulating tape. Performs continuously in a temperature ambient of up to 220°F and as low as 0°F. Resealable plastic case. Made in USA.



ET33

CATALOG NO.	DESCRIPTION	UOM	ORDER MULTIPLE
<b>ET33</b>	Super 33+ Electrical Tape – 3/4" x 66'	EA	10

**Scotch 3M Super 88 Electrical Tape**

Premium grade, 8.5 mil thick, all-weather vinyl insulating tape. Performs continuously in a temperature ambient of up to 220°F and as low as 0°F. Excellent resistance to abrasion, moisture, acids and corrosion. Packaged in a resealable plastic case. Made in the USA.



ET44

CATALOG NO.	DESCRIPTION	UOM	ORDER MULTIPLE
<b>ET44</b>	Super 88 Electrical Tape – 3/4" x 66'	EA	10

**ELECTRICAL TAPES** cont'd

**Scotch 35 Vinyl Electrical Tape**

This 7 mil premium grade electrical vinyl tape stretches to conform to virtually any shape that requires color-coded insulation. Abrasion and weather resistant. Measures 3/4" x 66'.



CATALOG NO.	DESCRIPTION	UOM	ORDER MULTIPLE
<b>ET35N</b>	Vinyl Electrical Tape – Orange	EA	10
<b>ET35G</b>	Vinyl Electrical Tape – Green	EA	10
<b>ET35R</b>	Vinyl Electrical Tape – Red	EA	10
<b>ET35W</b>	Vinyl Electrical Tape – White	EA	10

**Economy Electrical Tape**

This tape is suitable for use up to 175 F (80C) and not more than 600V. The electrical tape is excellent for adhesion and UL listed.



CATALOG NO.	DESCRIPTION	UOM	ORDER MULTIPLE
<b>6-3460</b>	3/4" x 60' Economy Electrical Tape	EA	10

**Glass Cloth, Moisture Sealing, and Economy Electrical Tapes**

This is a woven glass cloth tape designed to operate in 600 volt dry applications, requiring high mechanical strength and resistance to high temperatures. The glass cloth is specially treated and prepared to provide corrosion free protection. It will not shrink, rot, or burn and has a high tensile strength. It contains pressure sensitive thermosetting adhesive which performs as Class B temperature (266 degrees F / 130 degrees C). Provides heat stable insulation for hot spot applications. Highlight: Color White. Width 1/2in. Length 66 ft. Thickness 7 mil. Tensile Strength (2) 150 lb./in. Material Glass Cloth.



CATALOG NO.	DESCRIPTION	UOM	ORDER MULTIPLE
<b>GC275</b>	1/2" x 66' Glass Cloth Electrical Tape by 3M	EA	10
<b>GC277</b>	3/4" x 66' Glass Cloth Electrical Tape by 3M	EA	10
<b>ET130C1</b>	1" x 30' Moisture Sealing Splicing Tape by 3M	EA	24
<b>ET22</b>	3/4" x 66' Hiawatha Electrical Tape by 3M	EA	10
<b>AT-1700</b>	3/4" x 66' TemFlex™ by 3M	EA	10

**TERMINALS, CONNECTORS**

**Compressor Repair Kit**

Finally, a product that simplifies the repair of burned or damaged spade terminals when reconnecting or replacing a compressor. Fits both non burned and burned terminals. Connects to the compressor via precision brass cylinders that fit over the terminals and connect with stainless steel set screws. Wires are permanently attached. Standard factory 600V, 65 strand machine wire. Easy to install and guaranteed for the life of the compressor.



CATALOG NO.	DESCRIPTION	UOM	ORDER MULTIPLE
<b>TLC-3-8</b>	3 Wire, 8 Gauge Connection Kit	EA	1
<b>TLC-3-10</b>	3 Wire, 10 Gauge Connection Kit	EA	1
<b>TLC-3-12</b>	3 Wire, 12 Gauge Connection Kit	EA	1

**Replacement Compressor Leads**

Extreme heat within compressors typically causes failure of wiring insulation. This can cause corrosion to the inner strands of copper within the wire used for compressor hook up. This reduces the power flow to the compressor causing the unit to overheat and can prevent the compressor from starting. A MINIMUM of 12in. of wire must be removed. The DiversiTech Replacement Compressor Leads are ideal for replacing this corroded wiring. 24in. leads also available for replacing wire all the way to the contactor and capacitor.



CATALOG NO.	DESCRIPTION	UOM	ORDER MULTIPLE
<b>CC33</b>	Compressor Leads – 12" with Butt, pack of 3	PK	1
<b>CC33-18</b>	Compressor Leads – 18" with Butt, pack of 3	PK	1
<b>CC33-24</b>	Compressor Leads – 24" with Ring, pack of 3	PK	1

**Transparent Plastic Boxes with Terminal Assortments**

Boxes are made of soft, pliable, durable K resin with 18 compartments containing the most popular terminals, including hi temp and compressor terminals.



CATALOG NO.	DESCRIPTION	UOM	ORDER MULTIPLE
<b>PA10</b>	180 Terminals (10 Each Kind)	EA	1
<b>PA25</b>	360 Terminals (20 Each Kind)	EA	1
<b>PA25AP</b>	Appliance Parts Technician Assortment (mostly Hi-Temp)	EA	1
<b>PA18</b>	"K" Resin Plastic Box Only	EA	1

**Compartmented Storage Boxes**

These boxes can be used to store your compressor terminals, nylon ties and clamps.



CATALOG NO.	DESCRIPTION	UOM	ORDER MULTIPLE
<b>MB21</b>	21 Compartmented Metal Box	EA	1
<b>MB22</b>	21 Compartmented Metal Box w/230 popular items including hi-temp and compressor terminals, nylon ties and clamps	EA	1

## Grommets – Vinyl (By Panel Hole Size)

Grommets safely route cables and wires through sharp edged cutouts.



CATALOG NO.	DESCRIPTION	UOM	ORDER MULTIPLE
GV06*	Grommets – 3/8", pack of 18	PK	1
GV07	Grommets – 7/16", pack of 12	PK	1
GV08*	Grommets – 1/2", pack of 12	PK	1
GV10*	Grommets – 5/8", pack of 7	PK	1
GV12	Grommets – 3/4", pack of 3	PK	1
GV14*	Grommets – 7/8", pack of 4	PK	1
GVA1	Assortment – Small – GV04, GV05, GV06, GV07, GV08, pack of 15	PK	1
GVA2	Assortment – Large – GV08, GV10, GV12, GV14, GV16, pack of 5	PK	1

\*Sizes shown above also available in 100 packs. Replace "\*" with "C" for part number.

## Heat Shrink Tubing – Polyolefin 50% Shrink, Black Commercial Grade

Our shrinking tube is economical and mechanically tough heat shrinkable tubing used for insulating, jacketing and identification.



CATALOG NO.	DESCRIPTION	UOM	ORDER MULTIPLE
HS03	3/16" I.D. Expanded – 4" Long, pack of 8	PK	1*
HS04	1/4" I.D. Expanded – 4" Long, pack of 7	PK	1*
HS06	3/8" I.D. Expanded – 4" Long, pack of 6	PK	1*
HS08	1/2" I.D. Expanded – 4" Long, pack of 5	PK	1*
HSA1	Assorted 3/16", 1/4", 3/8" – 4" Long, pack of 7	PK	1
HSA2	Assorted 1/2", 3/4", 1" – 4" Long, pack of 4	PK	1

Available in lengths up to 250 ft.

\*These items are also available in bulk. To order, enter the catalog number followed by the letter "B". For example, HS03B is the bulk part number for HS03. Bulk items are priced and shipped by the foot.

## 200 Piece Terminal Kit

- High impact re-usable plastic box
- Assortment of ring & spade terminals, butt connectors, male & female disconnects

### TERMINALS IN KIT

DESCRIPTION	QTY
Ring Terminal 22-16 #6	4
Ring Terminal 22-16 #8	4
Ring Terminal 22-16 #10	4
Ring Terminal 16-14 #6	4
Ring Terminal 16-14 #8	4
Ring Terminal 16-14 #10	5
Ring Terminal 12-10 #8	4
Ring Terminal 12-10 #10	6
Ring Terminal 12-10 1/4"	5
Ring Terminal 12-10 5/16"	4
Spade Terminal 22-16 #6	11
Spade Terminal 22-16 #8	13
Spade Terminal 22-16 #10	4
Spade Terminal 16-14 #6	5
Spade Terminal 16-14 #8	4
Spade Terminal 16-14 #10	4
Spade Terminal 12-10 #8	4
Spade Terminal 12-10 #10	16
Spade Terminal 12-10 1/4"	4
Butt connector 22-18	11
Butt connector 16-14	11
Butt connector 12-10	9
Vinyl Male Disconnect 22-16 .250	4
Vinyl Male Disconnect 22-14 .250	4
Vinyl Male Disconnect 22-10 .250	4
Vinyl Female Disconnect 22-18 .250	5
Vinyl Female Disconnect 16-14 .187	4
Vinyl Female Disconnect 16-14 .250	11
Vinyl Female Disconnect 12-10 .250	13
Nyl Full Ins Fem Discon 22-18	4
Nyl Full Ins Fem Discon 16-14	5
Nyl Full Ins Fem Discon 12-10 .250	4
Nyl Full Ins Male Discon 22-18 .250	4
Nyl Full Ins Male Discon 16-14 .250	4



CATALOG NO.	DESCRIPTION	UOM	ORDER MULTIPLE
10816	200 Piece Terminal Kit	EA	5

## THERMAL CONTROLS

### Fusible Links

Fusible Links are temperature sensitive, one time devices. Engineered as safety links, they open the circuit if the designed limit temperature is reached.

CATALOG NO.	FUSIBLE TEMP °F	TYPE	PRONG TYPE	QTY/PACK	UOM	ORDER MULTIPLE
<b>HFL-4257</b>	257°	In-Line		pack of 4	PK	1
<b>HFL-4300</b>	300°	In-Line		pack of 4	PK	1
<b>HFL-4333</b>	333°	In-Line		pack of 4	PK	1
<b>HFL-5257</b>	257°	Face Plate	Straight	pack of 2	PK	1
<b>HFL-5258</b>	257°	Face Plate	Right Angle	pack of 2	PK	1
<b>HFL-5300</b>	300°	Face Plate	Straight	pack of 2	PK	1
<b>HFL-5301</b>	300°	Face Plate	Right Angle	pack of 2	PK	1
<b>HFL-5333</b>	333°	Face Plate	Straight	pack of 2	PK	1



### Replacement Element Kits

Field repair damaged element sections of electric heaters. Each kit contains a specific KW replacement element, two ceramic terminal insulator sets, plated bolts, nuts and washers.

CATALOG NO.	WATTAGE AT		IN PLACE LENGTH (INCHES)		UOM	ORDER MULTIPLE
	240V	208V	MINIMUM	MAXIMUM		
<b>HEK-500</b>	5000	3750	54"	162"	EA	1



### Sequencers

The sequencers are used in electric heat systems to stage blower motors and heating elements. All sequencers are for 24V control.

CATALOG NO.	NO. CIRCUITS	KILWON NO.	SWITCH CONFIGURATION	DELAY ON TIME MIN.-MAX. SECONDS	DELAY OFF TIME MIN.-MAX. SECONDS	UOM	ORDER MULTIPLE
<b>HDR-101</b>	1 Main	60000A0211	SPST-NO	1-24	45-75	EA	1
<b>HDR-102</b>	1 Main	60000A0147	SPST-NO	30-75	1-40	EA	1
<b>HDR-201</b>	2 Main	60000E0110	DPST-NO	1-24	45-75	EA	1
<b>HDR-202</b>	2 Main	60000E0109	DPST-NO	30-70	1-40	EA	1
<b>HDR-211</b>	2 Main Staged	60200A0117	DPST-NO	30-110	1-40	EA	1
<b>HDR-212</b>	2 Main Staged	60200A0127	DPST-NO	1-25	50-110	EA	1
<b>HDR-221</b>	3 Main Staged	51172-131-1	DPST-NO SPST-NO	1-25	50-110	EA	1
<b>HDR-222</b>	4 Main Staged	51172-131-2	2 DPST-NO	1-40	50-110	EA	1

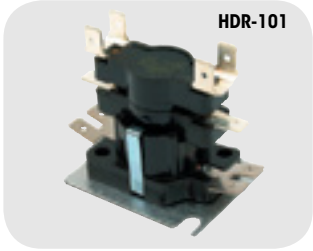

### Manual Reset Fire Stat

This bi metal switch is used as a manual reset. When temperature condition is met, the device opens. The manual reset can only be reset after proper cool down of the switch. The HMR 130 is a popular fire stat in ducted air distribution systems. Should temperatures in the duct exceed 130 degree F, the switch opens, shutting down the whole system so no fire or smoke can be spread by the fan.

CATALOG NO.	DESCRIPTION	UOM	ORDER MULTIPLE
<b>HMR-130</b>	Bi-metal Manual Reset Fire Stat	EA	1



## THERMOSTATS

### LuxPro Thermostats

LuxPro thermostats are designed to be a reliable, simple solution to in home comfort, so that everyone can enjoy the benefits and comforts of advanced temperature control. Diversitech offers a variety of LuxPro models and options to match any installation need.



675-P521U

CATALOG NO.	DESCRIPTION	UOM	ORDER MULTIPLE
675-P521U	5-2 program, 2 H/1 C, Programmable	EA	1
675-P621U	5-1-1 program, 2 H/1 C, Programmable	EA	1
675-P721UT	7 Day, 2 H/1 C, Programmable, Touchscreen	EA	1
675-P722U	7 Day, Programmable, 2 H/2 C for Conventional, 2 H/1 C for Heat Pumps	EA	1
675-PSD010BF	Digital for Heat Only, with Fan Switch	EA	1
675-PSD111	1 H/1 C, Non-Programmable, Vertical/Horizontal	EA	1
675-PSDH121	1 or 2 H/C, Non-Programmable, Vertical/Horizontal	EA	1
675-PSM30SA	Heat Only Mechanical	EA	1
675-PSM40SA	Heating & Cool Mechanical	EA	1
675-PSP722E	3 H/2 C, Programmable for Heat Pumps, 2 H/2 C for Conventional	EA	1

## THERMOSTAT GUARDS

### Plastic Thermostat Guards

Use to prevent tampering with thermostats. The covers are clear, allowing complete viewing of the thermostat and current settings. Furnished complete with ring and/or solid base. Includes vent holes for easy airflow across the thermostat. Lockable with universal key. Internal dimensional clearance/sizing for thermostats as noted.



585-TG1

CATALOG NO.	DESCRIPTION	T-STAT CLEARANCE	UOM	ORDER MULTIPLE
585-TG	Clear Plastic w/Two Bases	8-1/4" x 4-1/2" x 3-1/4"	EA	1
585-TG1	Clear Plastic w/Two Bases	5-3/4" x 3-1/2" x 2-3/4"	EA	1
585-TG2	Clear Plastic w/Two Bases	4-3/4" x 4-1/4" x 2-3/4"	EA	1
585-TG5	Clear Plastic w/Solid Base	3-1/2" x 3-1/4" x 2-1/4"	EA	1
585-TG6	Clear Plastic w/Two Bases	6-1/4" x 3-3/4" x 1-3/4"	EA	1
585-F336	Key for Thermostat Guard		EA	1

### Steel Thermostat Guards

Steel thermostat guards are used to prevent tampering with thermostats. The covers are steel, giving complete tamper protection of the thermostat, and physical impact protection. Great for warehouse and industrial locations. Furnished complete with ring and/or solid base as noted. Includes vent holes for easy airflow across the thermostat. Lockable with universal key. Internal dimensional clearance/sizing for thermostats as noted.



585-TG4

CATALOG NO.	DESCRIPTION	T-STAT CLEARANCE	UOM	ORDER MULTIPLE
585-TG3	Beige Steel w/Solid Base	6" x 4" x 3"	EA	1
585-TG4	Beige Steel w/Ring Base	6" x 4" x 3"	EA	1
585-TG7	Beige Steel w/Solid Base	5-1/2" x 3-1/2" x 2-3/4"	EA	1
585-TG8	Beige Steel w/Ring Base	5" x 3" x 2-3/4"	EA	1
585-TG9	Beige Steel w/Two Bases	6" x 4" x 3"	EA	1

### Cross Reference

DIVERSITECH PART NO.	BEKO PART NO.	BRAMEC PART NO.	MARS PART NO.
585-TG	BTG-UK2	13012	70220
585-TG1	BTG-RK	13016	70210
585-TG2	BTG-K	13008	70205
585-TG5	BTG-EK	13004	70201
585-TG6	BTG-DK	13018	70217
585-TG8	BTG-54VLW	13001	70216

**THERMOSTAT WIRE**

**Thermostat Wire**

Class 2 thermostat wire for indoor wiring needs. Soft drawn bare copper wire, semi rigid PVC insulation and PVC overall jacket. Packaged on aluminum spool.



CATALOG NO.	DESCRIPTION	UOM	ORDER MULTIPLE
620-18-2	18 AWG, 2 Conductors – 500 ft. Spool	EA	4
620-18-3	18 AWG, 3 Conductors – 500 ft. Spool	EA	4
620-18-4	18 AWG, 4 Conductors – 250 ft. Spool	EA	4
620-18-5	18 AWG, 5 Conductors – 250 ft. Spool	EA	4
620-18-6	18 AWG, 6 Conductors – 250 ft. Spool	EA	4
620-18-7	18 AWG, 7 Conductors – 250 ft. Spool	EA	4
620-18-8	18 AWG, 8 Conductors – 250 ft. Spool	EA	4
620-18-10	18 AWG, 10 Conductors – 250 ft. Spool	EA	4
620-20-3	20 AWG, 3 Conductors – 500 ft. Spool	EA	4
620-20-4	20 AWG, 4 Conductors – 250 ft. Spool	EA	4
620-20-5	20 AWG, 5 Conductors – 250 ft. Spool	EA	4
620-20-6	20 AWG, 6 Conductors – 250 ft. Spool	EA	4
620-20-7	20 AWG, 7 Conductors – 250 ft. Spool	EA	4
620-20-8	20 AWG, 8 Conductors – 250 ft. Spool	EA	4
620-20-10	20 AWG, 10 Conductors – 250 ft. Spool	EA	4

U.L. Listed. Meets Subject 13 per Article 725, 1990 NEC.

**Plenum Thermostat Wire**

The Plenum Thermostat Wire is UL Listed type CL2P NEC Article 725 and is designed for use in thermostat control applications.



CATALOG NO.	DESCRIPTION	UOM	ORDER MULTIPLE
620-18-2P	18 AWG, 2 Conductors – 500 ft. Spool	EA	4
620-18-3P	18 AWG, 3 Conductors – 500 ft. Spool	EA	4
620-18-6P	18 AWG, 6 Conductors – 250 ft. Spool	EA	4
620-18-8P	18 AWG, 8 Conductors – 250 ft. Spool	EA	4

**Wire for Mini-Split Installation**

Wire and cabling specific for mini split installation power supply and control circuits.



CATALOG NO.	DESCRIPTION	UOM	ORDER MULTIPLE
230-18-4	Stranded Shielded CL3R, 50' per roll	EA	1
230-16-2	Stranded Shielded CL3R, 50' per roll	EA	1
230-14-4	Stranded Non-Shielded CL3R, 50' per roll	EA	1
230-14-7	Stranded Non-Shielded CL3R, 50' per roll	EA	1
230-14-4S	Stranded Shielded CL3R, 50' per roll	EA	1

**HVAC Mni-Split Wiring Solutions**

Southwire is a market leader with its EZ-In™ Mini-Split cable designed specifically for mini-split installations. EZ-In™ Mini-Split cable, available in both shielded and non-shielded configurations, has brought ease of installation and savings to HVAC mini-split installations by eliminating the use of conduit or cable trays. Now, Southwire has enhanced its offering with connectors and tools specifically designed with mini-split installations in mind.

CATALOG NO.	DESCRIPTION	UOM	ORDER MULTIPLE
59351202	EZ-IN Shielded Mini-Split Cable, 14-4 Stranded, 600V, 250FT Reel	EA	1
59351203	EZ-IN Shielded Mini-Split Cable, 14-4 Stranded, 600V, 50FT Bag	EA	1
64235201	EZ-IN Shielded Mini-Split Cable Liquid Tight Straight Connector, 1/2" Hub Size	EA	25
64275801	EZ-IN Shielded Mini-Split Cable Liquid Tight 90 Degree Connector, 1/2" Hub Size	EA	15
58278040	Wire Strippers and Cutters, Heavy Duty, Stainless Steel, for 18-10AWG Wires	EA	5
58282040	Compact Conduit and Metal Scorer, Jacket Cutter	EA	3
58282240	Rotary Armor Cable Cutter with Rotary Blade	EA	2
58282340	Replacement Rotary Cutter Blades	EA	5
64846401	Point of Purchase Display with Liquid Tight Straight and 90 Degree Connectors, Cutter, Replacement Blades	EA	1





**STRANDED COPPER THHN WIRE**

**Stranded Copper Wire in Clear Dispenser Pack, 194°F**

This copper wire is UL listed and THHN wire. It is 19 strand copper and is 600 V as well as 90°C Stranded.



CATALOG NO.	DESCRIPTION	UOM	ORDER MULTIPLE
W801	08 Gauge, 10 ft., Black	EA	1
W802	08 Gauge, 10 ft., Red	EA	1
W803	08 Gauge, 10 ft., Green	EA	1
W804	08 Gauge, 10 ft., Blue	EA	1
W805	08 Gauge, 10 ft., White	EA	1
W101	10 Gauge, 10 ft., Black	EA	1
W102	10 Gauge, 10 ft., Red	EA	1
W103	10 Gauge, 10 ft., Green	EA	1
W104	10 Gauge, 10 ft., Blue	EA	1
W105	10 Gauge, 10 ft., White	EA	1
W121	12 Gauge, 15 ft., Black	EA	1
W122	12 Gauge, 15 ft., Red	EA	1
W123	12 Gauge, 15 ft., Green	EA	1
W124	12 Gauge, 15 ft., Blue	EA	1
W125	12 Gauge, 15 ft., White	EA	1
W141	14 Gauge, 20 ft., Black	EA	1
W142	14 Gauge, 20 ft., Red	EA	1
W143	14 Gauge, 20 ft., Green	EA	1
W144	14 Gauge, 20 ft., Blue	EA	1
W145	14 Gauge, 20 ft., White	EA	1

**Stranded Copper Wire on Spool**

This copper wire is UL listed and THHN wire. It is 19 strand copper and is 600 V as well as 90°C Stranded. This comes 100 ft. per spool.



CATALOG NO.	DESCRIPTION	UOM	ORDER MULTIPLE
W801-100	08 Gauge, 100 ft. Spool, Black	EA	1
W802-100	08 Gauge, 100 ft. Spool, Red	EA	1
W803-100	08 Gauge, 100 ft. Spool, Green	EA	1
W804-100	08 Gauge, 100 ft. Spool, Blue	EA	1
W805-100	08 Gauge, 100 ft. Spool, White	EA	1
W101-100	10 Gauge, 100 ft. Spool, Black	EA	1
W102-100	10 Gauge, 100 ft. Spool, Red	EA	1
W103-100	10 Gauge, 100 ft. Spool, Green	EA	1
W104-100	10 Gauge, 100 ft. Spool, Blue	EA	1
W105-100	10 Gauge, 100 ft. Spool, White	EA	1
W121-100	12 Gauge, 100 ft. Spool, Black	EA	1
W122-100	12 Gauge, 100 ft. Spool, Red	EA	1
W123-100	12 Gauge, 100 ft. Spool, Green	EA	1
W124-100	12 Gauge, 100 ft. Spool, Blue	EA	1
W125-100	12 Gauge, 100 ft. Spool, White	EA	1
W141-100	14 Gauge, 100 ft. Spool, Black	EA	1
W142-100	14 Gauge, 100 ft. Spool, Red	EA	1
W143-100	14 Gauge, 100 ft. Spool, Green	EA	1
W144-100	14 Gauge, 100 ft. Spool, Blue	EA	1
W145-100	14 Gauge, 100 ft. Spool, White	EA	1

**Stranded Copper Wire on Spool**

This copper wire is UL listed and THHN wire. It is 19 strand copper and is 600 V as well as 90°C Stranded. This comes 50 ft. per spool.



CATALOG NO.	DESCRIPTION	UOM	ORDER MULTIPLE
W801-50	08 Gauge, 50 ft. Spool, Black	EA	1
W802-50	08 Gauge, 50 ft. Spool, Red	EA	1
W803-50	08 Gauge, 50 ft. Spool, Green	EA	1
W804-50	08 Gauge, 50 ft. Spool, Blue	EA	1
W101-50	10 Gauge, 50 ft. Spool, Black	EA	1
W102-50	10 Gauge, 50 ft. Spool, Red	EA	1
W103-50	10 Gauge, 50 ft. Spool, Green	EA	1
W104-50	10 Gauge, 50 ft. Spool, Blue	EA	1
W105-50	10 Gauge, 50 ft. Spool, White	EA	1
W121-50	12 Gauge, 50 ft. Spool, Black	EA	1
W122-50	12 Gauge, 50 ft. Spool, Red	EA	1
W123-50	12 Gauge, 50 ft. Spool, Green	EA	1
W124-50	12 Gauge, 50 ft. Spool, Blue	EA	1
W125-50	12 Gauge, 50 ft. Spool, White	EA	1
W141-50	14 Gauge, 50 ft. Spool, Black	EA	1
W142-50	14 Gauge, 50 ft. Spool, Red	EA	1
W143-50	14 Gauge, 50 ft. Spool, Green	EA	1
W144-50	14 Gauge, 50 ft. Spool, Blue	EA	1
W145-50	14 Gauge, 50 ft. Spool, White	EA	1

**High Temperature Wire, 400°F (204°C), 600 V.**

7 strand tin coated copper wire with silicone rubber insulation protected by a braided fiberglass jacket. Use on the front of all gas furnaces with spark ignition because of flame roll out on start up. Also on all power feeds to electric strip and duct heaters. Also used on all heat producing food preparation equipment.



CATALOG NO.	DESCRIPTION	UOM	ORDER MULTIPLE
WHT20	14 gauge, 10 ft. black, 10 ft. white	EA	1
WHTB14-50	14 gauge, black, 50 ft.	EA	1
WHTR14-50	14 gauge, red, 50 ft.	EA	1
WHTW14-50	14 gauge, white, 50 ft.	EA	1
WHTB12-50	12 gauge, black, 50 ft.	EA	1
WHTB10-50	10 gauge, black, 50 ft.	EA	1

**WIRE CONNECTORS**

**Wire Connectors—Screw On, U.L. Listed, C.S.A Approved**

Color coded connectors make quick, secure connections for positive continuity. High dielectric thermoplastic shell resists chemical action from hydrocarbons, dilute acid or alkaline solutions. Deep skirt design prevents exposure of bare wire.



CATALOG NO.	DESCRIPTION	UOM	ORDER MULTIPLE
<b>623-001</b>	Gray Screw-On – Size 71B, #22 to #16 AWG, 300V Max., pack of 100	PK	1
<b>623-002</b>	Blue Screw-On – Size 72B, #22 to #16 AWG, 300V Max., pack of 100	PK	1
<b>623-003</b>	Orange Screw-On – Size 73B, #22 to #14 AWG, 600V Max., pack of 100	PK	1
<b>623-004</b>	Yellow Screw-On – Size 74B, #18 to #10 AWG, 600V Max., pack of 100	PK	1
<b>623-005</b>	Red Screw-On – Size 76B, #18 to #10 AWG, 600V Max., pack of 100	PK	1

U.L. Listed. CSA Approved.

**Twist-On Wire Connectors Combo Kit**

The 623-MIX Twist-On Wire Connectors Combo Kit is a very handy and convenient wire connector kit. It contains 600 pieces of color-coded, twist-on and winged twist-on wire connectors in 9 commonly used sizes. Its durable and configurable Plano box is great organizer for wire connector refills and storage. A wiring combinations chart for each connector is also included. It is a great truck stock item for contractors.

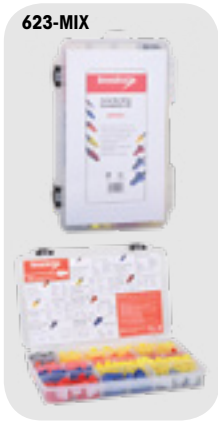

CATALOG NO.	DESCRIPTION	UOM	ORDER MULTIPLE
<b>623-MIX</b>	Twist-On Wire Connectors Combo Kit, Pack of 600	PK	1

U.L. Listed. CSA Approved.

**Wire Connectors—Contractor Packs, U.L. Listed, C.S.A Approved**

These connectors have a high dielectric thermoplastic shell. These are UL listed and CSA approved. This product is great for making quick and secure connections.



CATALOG NO.	DESCRIPTION	UOM	ORDER MULTIPLE
<b>C222</b>	Closed End Connectors 22-14 W, pack of 18	PK	1
<b>C222C</b>	Closed End Connectors 22-14 W, pack of 100	PK	1
<b>C223</b>	Closed End Connectors 18-10 W, pack of 15	PK	1
<b>C223C</b>	Closed End Connectors 18-10 W, pack of 100	PK	1
<b>C241</b>	Blue Wire Connectors 22-16 W, pack of 20	PK	1
<b>C241L</b>	Blue Wire Connectors 22-16 W, pack of 50	PK	1
<b>C243</b>	Orange Wire Connectors 22-14 W, pack of 15	PK	1
<b>C243L</b>	Orange Wire Connectors 22-14 W, pack of 50	PK	1
<b>C245</b>	Yellow Wire Connectors 18-10 W, pack of 13	PK	1
<b>C245L</b>	Yellow Wire Connectors 18-10 W, pack of 50	PK	1
<b>C247</b>	Red Wire Connectors 18-10 W, pack of 10	PK	1
<b>C312</b>	Yellow Winged Wire Connectors, pack of 13	PK	1
<b>C312L</b>	Yellow Winged Wire Connectors, pack of 50	PK	1
<b>C512</b>	Red Winged Wire Connectors, pack of 10	PK	1
<b>C512L</b>	Red Winged Wire Connectors, pack of 50	PK	1

U.L. Listed. CSA Approved.

**Wire Connectors—Winged, U.L. Listed, C.S.A Approved**

Wings give surer grip; offset center design provides great twisting leverage. Expandable square-wire spring instantly adjusts to shape and size to create a strong, vibration-resistant connection. Same tough shell as screw-on type.



CATALOG NO.	DESCRIPTION	UOM	ORDER MULTIPLE
<b>623-000</b>	Lg. Gray Winged – Size 78B, #14 to #8 AWG, 600V Max., pack of 50	PK	1
<b>623-006</b>	Yellow Winged – Size 84, #22 to #10 AWG, 600V Max., pack of 100	PK	1
<b>623-007</b>	Red Winged – Size 86, #18 to #10 AWG, 600V Max., pack of 100	PK	1
<b>623-008</b>	Blue Winged – Size 89, #10 to #6, 600V Max., pack of 50	PK	1

U.L. Listed. C.S.A. Approved.

**Wire Connectors—Screw On, U.L. Listed, C.S.A Approved**

Color coded connectors make quick, secure connections for positive continuity. High dielectric thermoplastic shell resists chemical action from hydrocarbons, dilute acid or alkaline solutions. Deep skirt design prevents exposure of bare wire. New handy carry handle and grip bottle. U.L. Listed. C.S.A. Approved.



CATALOG NO.	DESCRIPTION	UOM	ORDER MULTIPLE
<b>623-012</b>	Blue Screw-On – Size 72B, #22 to #16 AWG, 300V Max., pack of 600	PK	1
<b>623-013</b>	Orange Screw-On – Size 73B, #22 to #14 AWG, 600V Max., pack of 300	PK	1
<b>623-014</b>	Yellow Screw-On – Size 74B, #18 to #10 AWG, 600V Max., pack of 200	PK	1

U.L. Listed. CSA Approved.

**Porcelain Wire Connectors**

Porcelain Wire Connectors are used in high temperature applications such as appliances.



CATALOG NO.	DESCRIPTION	AWG	UOM	ORDER MULTIPLE
<b>CPN1</b>	Porcelain – Small, pack of 15	22-16, 2 Strand Wire	PK	1
<b>CPN1C</b>	Porcelain – Small, pack of 100	22-16, 2 Strand Wire	PK	1
<b>CPN2</b>	Porcelain – Medium, pack of 10	18-14, 2 Strand Wire	PK	1
<b>CPN2C</b>	Porcelain – Medium, pack of 100	18-14, 2 Strand Wire	PK	1
<b>CPN3</b>	Porcelain – Large, pack of 10	18-14, 3 Strand Wire	PK	1
<b>CPN3C</b>	Porcelain – Large, pack of 100	18-14, 3 Strand Wire	PK	1
<b>CPN2M</b>	Porcelain – Medium, pack of 1000	18-14, 2 Strand Wire	PK	1

**WIRE/CABLE TIES, MOUNTS, CLAMPS**

**Cable Tie Assortment Pack**

6.6 nylon, the heavy duty duct straps feature smooth insertion, and a locking mechanism that gives ductwork a firm hold. Accommodates 7 to 15 inch duct. Tensioning tool for 32"+ allows operator to adjust strap to any desired tension.



CATALOG NO.	DESCRIPTION	UOM	ORDER MULTIPLE
7-711	Natural Cable Tie Assortment – 7" and 11", pack of 150	PK	25
7-711-B	Black Cable Tie Assortment – 7" and 11", pack of 150	PK	25
7-5811	Natural Cable Tie Assortment – 5", 8", and 11", pack of 450	PK	30
7-5811-B	Black Cable Tie Assortment – 5", 8", and 11", pack of 450	PK	30

**Heavy Duty Cable Ties**

6.6 nylon, the heavy duty duct straps feature smooth insertion, and a locking mechanism that gives ductwork a firm hold. Accommodates 7 to 15 inch duct. Tensioning tool for 32"+ allows operator to adjust strap to any desired tension.

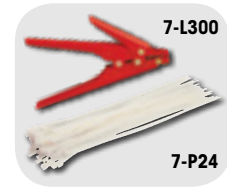

CATALOG NO.	DESCRIPTION	UOM	ORDER MULTIPLE
7-P24	24" Long – Fits up to 6" Duct – 175 lb. Tensile	EA	50
7-P36	36" Long – Fits up to 10" Duct – 175 lb. Tensile	EA	50
7-P36B	36" Long – Black – Fits up to 10" Duct – 175 lb. Tensile	EA	50
7-P48	48" Long – Fits up to 14" Duct – 175 lb. Tensile	EA	50
7-P48B	48" Long – Black – Fits up to 14" Duct – 175 lb. Tensile	EA	25
7-L300	Tensioning Tool for 120-175 lb. Ties	EA	1

**White Nylon Ties with Mounting Hole**

These wire ties are perfect for securing wires. You can choose from an assortment of sizes.



CATALOG NO.	DESCRIPTION	TENSILE STRENGTH	UOM	ORDER MULTIPLE
WTM05	White Wire Ties with Mounting Hole – 5" Nylon, pack of 13	18	PK	1
WTM05C	White Wire Ties with Mounting Hole – 5" Nylon, pack of 100	18	PK	1
WTM07	White Wire Ties with Mounting Hole – 7" Nylon, pack of 11	50	PK	1
WTM07C	White Wire Ties with Mounting Hole – 7" Nylon, pack of 100	50	PK	1
WTM11	White Wire Ties with Mounting Hole – 11" Nylon, pack of 6	50	PK	1
WTM11C	White Wire Ties with Mounting Hole – 11" Nylon, pack of 100	50	PK	1
WTM14C	White Wire Ties with Mounting Hole – 14" Nylon, pack of 100	50	PK	1

**White Nylon Wire Ties**

These wire ties are perfect for securing wires. You can choose from an assortment of sizes.

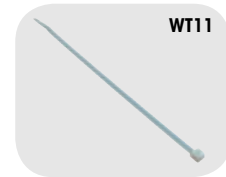

CATALOG NO.	DESCRIPTION	TENSILE STRENGTH	UOM	ORDER MULTIPLE
WT04	White Wire Ties – 4" Nylon, pack of 40	18	PK	1
WT04C	White Wire Ties – 4" Nylon, pack of 100	18	PK	1
WT05	White Wire Ties – 5" Nylon, pack of 35	18	PK	1
WT05C	White Wire Ties – 5" Nylon, pack of 100	18	PK	1
WT07	White Wire Ties – 7" Nylon, pack of 30	50	PK	1
WT07C	White Wire Ties – 7" Nylon, pack of 100	50	PK	1
WT11	White Wire Ties – 11" Nylon, pack of 15	50	PK	1
WT11C	White Wire Ties – 11" Nylon, pack of 100	50	PK	1
WT11L	White Wire Ties – 11" Nylon, pack of 50	50	PK	1
WT15	White Wire Ties – 15" Nylon, pack of 12	50	PK	1
WT15C	White Wire Ties – 15" Nylon, pack of 100	50	PK	1
WTA1	White Wire Ties – Assorted 4", 7", and 11" Nylon, pack of 30		PK	1

**Black Nylon Ties with Mounting Hole**

These wire ties are perfect for securing wires. You can choose from an assortment of sizes.



CATALOG NO.	DESCRIPTION	TENSILE STRENGTH	UOM	ORDER MULTIPLE
WTMB05	Black Wire Ties with Mounting Hole – 5" Nylon, pack of 12	18	PK	1
WTMB05C	Black Wire Ties with Mounting Hole – 5" Nylon, pack of 100	18	PK	1
WTMB07	Black Wire Ties with Mounting Hole – 7" Nylon, pack of 10	50	PK	1
WTMB07C	Black Wire Ties with Mounting Hole – 7" Nylon, pack of 100	50	PK	1
WTMB11	Black Wire Ties with Mounting Hole – 11" Nylon, pack of 6	50	PK	1
WTMB11C	Black Wire Ties with Mounting Hole – 11" Nylon, pack of 100	50	PK	1
WTMB14C	Black Wire Ties with Mounting Hole – 14" Nylon, pack of 100	50	PK	1

**Black Nylon Wire Ties**

These wire ties are perfect for securing wires. You can choose from an assortment of sizes. Ultraviolet resistant for outdoor use.

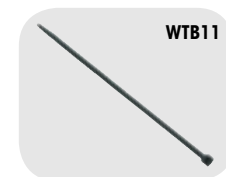

CATALOG NO.	DESCRIPTION	TENSILE STRENGTH	UOM	ORDER MULTIPLE
WTB05	Black Wire Ties – 6" Nylon, pack of 35	18	PK	1
WTB05C	Black Wire Ties – 6" Nylon, pack of 100	18	PK	1
WTB07	Black Wire Ties – 7" Nylon, pack of 30	50	PK	1
WTB07C	Black Wire Ties – 7" Nylon, pack of 100	50	PK	1
WTB07M	Black Wire Ties – 7" Nylon, pack of 1000	50	PK	1
WTB11	Black Wire Ties – 11" Nylon, pack of 15	50	PK	1
WTB11C	Black Wire Ties – 11" Nylon, pack of 100	50	PK	1
WTB11CR	Black Wire Ties, Releasable – 11" Nylon, pack of 100	50	PK	25
WTB11D	Black Wire Ties – 11" Nylon, pack of 500	50	PK	1
WTB11M	Black Wire Ties – 11" Nylon, pack of 1000	50	PK	1
WTB15	Black Wire Ties – 14" Nylon, pack of 12	50	PK	1
WTB15C	Black Wire Ties – 14" Nylon, pack of 100	50	PK	1
WTBA1	Black Wire Ties – Assorted 4", 7", and 11" Nylon, pack of 28	50	PK	1

**WIRE/CABLE TIES, MOUNTS, CLAMPS cont'd**

**Wire and Cable Clamps – Nylon**

These wire ties are perfect for securing wires. You can choose from an assortment of diameter sizes.



CATALOG NO.	DESCRIPTION	UOM	ORDER MULTIPLE
<b>WC02</b>	Wire and Cable Clamps – 1/8" Diameter, pack of 40	PK	1
<b>WC03</b>	Wire and Cable Clamps – 3/16" Diameter, pack of 40	PK	1
<b>WC04</b>	Wire and Cable Clamps – 1/4" Diameter, pack of 35	PK	1
<b>WC05</b>	Wire and Cable Clamps – 5/16" Diameter, pack of 35	PK	1
<b>WC06</b>	Wire and Cable Clamps – 3/8" Diameter, pack of 30	PK	1
<b>WC07</b>	Wire and Cable Clamps – 7/16" Diameter, pack of 30	PK	1
<b>WC08</b>	Wire and Cable Clamps – 1/2" Diameter, pack of 25	PK	1
<b>WC09</b>	Wire and Cable Clamps – 9/16" Diameter, pack of 20	PK	1
<b>WC10</b>	Wire and Cable Clamps – 5/8" Diameter, pack of 20	PK	1
<b>WC12</b>	Wire and Cable Clamps – 3/4" Diameter, pack of 15	PK	1
<b>WC14</b>	Wire and Cable Clamps – 7/8" Diameter, pack of 15	PK	1
<b>WC16</b>	Wire and Cable Clamps – 1" Diameter, pack of 14	PK	1
<b>WCA1</b>	Wire and Cable Clamps Assortment – 1/8" to 1", pack of 26 PK		1

All above sizes are available in 100 packs. Add "C" to the end of the part number.

**Wire Tie Mounts**

These mounts are use for mounting wires in electrical work.

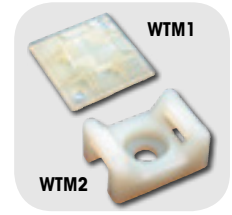

CATALOG NO.	DESCRIPTION	UOM	ORDER MULTIPLE
<b>WTM1</b>	White Wire Tie Mounts – Adhesive Back, pack of 4	PK	1
<b>WTM1C</b>	White Wire Tie Mounts – Adhesive Back, pack of 100	PK	1
<b>WTM2</b>	White Wire Tie Mounts – #8 Screw, pack of 7	PK	1
<b>WTM2C</b>	White Wire Tie Mounts – #8 Screw, pack of 100	PK	1

# TOOLS

Allen Wrenches .....	180
Brushes.....	181-182
Channellock® Products .....	182
Electrical Supplies .....	183
Fin Tools.....	183-184
Flashlights By Rayovac® .....	184
Gauges .....	186
Manometers, Pressure And Test Kits .....	186
Staples and Staple Guns.....	187
Miscellaneous Tools.....	187
Monitors.....	188
Refractometers .....	188
Rehvac Nitrogen Purging Equipment.....	180
Rehvac Refillable Gas Cylinders.....	180
Retrieving Tool .....	188
Saws and Saw Blades.....	189
Screwdrivers, Driver Sets.....	189
Snips, Notchers, Crimpers, Seamers .....	190
Straps, Truck Rope.....	190-191
Test Leads .....	191
Testers .....	192
Thermometers/Probes .....	192
Tube Working Tools .....	193
Welding Torches, Supplies .....	193
Worklights by Cliplight® .....	185-186



**REHVAC NITROGEN PURGING EQUIPMENT**

**Regulators**

Rehvac nitrogen and CO<sub>2</sub> regulators feature a machined brass piston with internal bleed-down safety. This design makes the Rehvac regulator long lasting and reliable.



**CT-475M**

CATALOG NO.	DESCRIPTION	UOM	ORDER MULTIPLE
<b>CA-252C</b>	Rehvac Adjustable Regulator, 0-250psi	EA	1
<b>CT-475M</b>	Regulator, N/CO2 – 0-475 psi	EA	1

**Gauges**

Rehvac replacement gauges are reliable and easy to read.



**GA-06**

CATALOG NO.	DESCRIPTION	UOM	ORDER MULTIPLE
<b>GA-06</b>	Rehvac 600psi Low Pressure Replacement Gauge	EA	1
<b>GA-30</b>	Rehvac 3000psi High Pressure Replacement Gauge	EA	1

**Hoses**

Rehvac hoses are designed specifically for air, nitrogen, or CO<sub>2</sub> service. Featuring a 600psi working pressure and a 2200psi burst pressure, Rehvac hoses are abrasion resistant and long lasting.



**CW-30**

CATALOG NO.	DESCRIPTION	UOM	ORDER MULTIPLE
<b>CW-30</b>	Rehvac 30" Whip Hose	EA	1

**Nitrogen Purge Tool**

The Nitrogen Purge Tool is a quick and easy way to purge copper pipes with nitrogen. Then, with a turn of the dial, quickly switch to a very low flow of nitrogen to properly braze the copper. It has a durable aluminum design so you can just throw it into your tool bag when you are done.



**DP-1**

CATALOG NO.	DESCRIPTION	UOM	ORDER MULTIPLE
<b>DP-1</b>	Nitrogen Purge Tool	EA	1

**REHVAC REFILLABLE GAS CYLINDERS**

**Nitrogen Cylinders**

Rehvac aluminum nitrogen cylinders from DiversiTech are commonly used in the HVAC industry for line cleaning and purging, pressure testing and braze purging. Made in the USA.



**N20-SD**

CATALOG NO.	DESCRIPTION	UOM	ORDER MULTIPLE
<b>N20-SD</b>	Rehvac Nitrogen Cylinder 57 cu ft	EA	1

**CO<sub>2</sub> Cylinders**

Rehvac aluminum CO<sub>2</sub> cylinders from DiversiTech are commonly used in the HVAC industry for condensate line cleaning. Made in the USA.



**C10**

CATALOG NO.	DESCRIPTION	UOM	ORDER MULTIPLE
<b>C10</b>	Rehvac 10# Aluminum Cylinder	EA	1
<b>C1-2-6</b>	Rehvac 1.2# Cylinder	EA	1
<b>C20</b>	Rehvac 20# Aluminum Cylinder	EA	1
<b>C2-5</b>	Rehvac Cylinder, 2.5#	EA	1
<b>C5</b>	Rehvac 5# Aluminum Cylinder	EA	1

**ALLEN WRENCHES**

**Allen Wrenches**

The finest quality wrenches available anywhere.



**AW-8**

CATALOG NO.	DESCRIPTION	UOM	ORDER MULTIPLE
<b>AW-8</b>	3" Handle, 8 Bits, Standard Fold-Ups .050", 1/16", 5/64", 3/32", 7/64", 1/8", 9/64", 5/32"	EA	1
<b>AW-9</b>	4" Handle, 9 Bits, Standard Fold-Ups 5/64", 3/32", 7/64", 1/8", 9/64", 5/32", 3/16", 7/32", 1/4"	EA	1

**BRUSHES**

**Chip Brushes**

100% pure bristle, wood handle. Poly sleeve over bristles. Inexpensive (use once and throw away). Excellent for applying duct adhesive.



CATALOG NO.	DESCRIPTION	UOM	ORDER MULTIPLE
<b>B-501</b>	Chip Brush – 1”	EA	36
<b>B-502</b>	Chip Brush – 1-1/2”	EA	36
<b>B-503</b>	Chip Brush – 2”	EA	24
<b>B-504</b>	Chip Brush – 2-1/2”	EA	12
<b>B-505</b>	Chip Brush – 3”	EA	12

**Welder’s Brush**

Stainless steel bristles used for cleaning all metals. Great for cleaning aluminum prior to soldering.

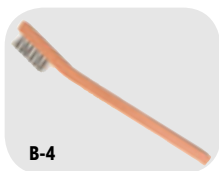

CATALOG NO.	DESCRIPTION	UOM	ORDER MULTIPLE
<b>B-4</b>	Welder’s Brush	EA	12

**Parts Cleaning Brush**

The heavy duty black polypropylene bristles are secured in a strong plastic handle.



CATALOG NO.	DESCRIPTION	UOM	ORDER MULTIPLE
<b>542-25015</b>	Parts Cleaning Brush	EA	12

**2-in-1 Copper Tube Cleaning Brush**

Easy to hold combination tool that really works. One end cleans the fitting. The other cleans the tube.



CATALOG NO.	DESCRIPTION	UOM	ORDER MULTIPLE
<b>B-996</b>	2-in-1 Copper Tube Cleaning Brush – 1/2” ID (5/8” OD)	EA	1
<b>B-998</b>	2-in-1 Copper Tube Cleaning Brush – 3/4” ID (7/8” OD)	EA	1

**Tin Handle Acid Brushes**

Manufactured with electrolyte tin plate and filled with 100% pure stiff horsehair, tied with a steel staple. This combination gives lasting qualities when used with heat and acids or other cleaning agents.

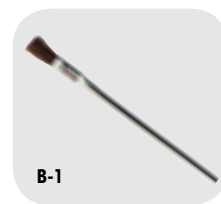

CATALOG NO.	DESCRIPTION	UOM	ORDER MULTIPLE
<b>B-1</b>	Tin Handle Acid Brush 3/8”	EA	144
<b>B-2</b>	Tin Handle Acid Brush 1/2”	EA	144

**Refrigerator Coil Brush**

Clean refrigerator coils, fan blades and areas under and behind appliances. 27-1/2” in length with 11-3/4” brush length. Bristles are 3/4” on the end tapering to 1-1/2” toward the handle.



CATALOG NO.	DESCRIPTION	UOM	ORDER MULTIPLE
<b>B-27</b>	Refrigerator Coil Brush	EA	1

**Duct Cleaning Brush**

These brushes are made of black fiber bristles twisted in wire. They are 1 1/8in. diameter by 7in. brush x 48in. overall length. These are idea for cleaning hard to reach areas in duct work.



CATALOG NO.	DESCRIPTION	UOM	ORDER MULTIPLE
<b>542-76220</b>	Duct Cleaning Brush	EA	1

**BRUSHES cont'd**

**Copper Tube Fitting Brushes**

Highest quality brushes to clean fittings faster, easier and more safely. Made with strong, resilient, rustproof stainless steel bristles secured in a 4-ply wire with easy-to-grip plastic handle. Economy models feature same quality stainless steel, but secured in 2-ply wire.



CATALOG NO.	DESCRIPTION	UOM	ORDER MULTIPLE
<b>B-124</b>	Copper Tube Fitting Brush – Economy 1/4" O.D., 9/32" Brush Dia.	EA	6
<b>B-125</b>	Copper Tube Fitting Brush – Economy 3/8" O.D., 13/32" Brush Dia.	EA	6
<b>B-126</b>	Copper Tube Fitting Brush – Economy 1/2" O.D., 17/32" Brush Dia.	EA	6
<b>B-127</b>	Copper Tube Fitting Brush – Economy 5/8" O.D., 11/16" Brush Dia.	EA	6
<b>B-128</b>	Copper Tube Fitting Brush – Economy 3/4" O.D., 13/16" Brush Dia.	EA	6
<b>B-129</b>	Copper Tube Fitting Brush – Economy 7/8" O.D., 15/16" Brush Dia.	EA	6
<b>B-131</b>	Copper Tube Fitting Brush – Economy 1-1/8" O.D., 1-1/4" Brush Dia.	EA	6
<b>B-132</b>	Copper Tube Fitting Brush – Economy 1-3/8" O.D., 1-1/2" Brush Dia.	EA	6
<b>B-924</b>	Copper Tube Fitting Brush – 1/4" O.D., 9/32" Brush Dia.	EA	1
<b>B-925</b>	Copper Tube Fitting Brush – 3/8" O.D., 13/32" Brush Dia.	EA	1
<b>B-926</b>	Copper Tube Fitting Brush – 1/2" O.D., 17/32" Brush Dia.	EA	1
<b>B-927</b>	Copper Tube Fitting Brush – 5/8" O.D., 11/16" Brush Dia.	EA	1
<b>B-928</b>	Copper Tube Fitting Brush – 3/4" O.D., 13/16" Brush Dia.	EA	1
<b>B-929</b>	Copper Tube Fitting Brush – 7/8" O.D., 15/16" Brush Dia.	EA	1
<b>B-930</b>	Copper Tube Fitting Brush – 1" O.D., 1-1/8" Brush Dia.	EA	1
<b>B-931</b>	Copper Tube Fitting Brush – 1-1/8" O.D., 1-1/4" Brush Dia.	EA	1
<b>B-932</b>	Copper Tube Fitting Brush – 1-3/8" O.D., 1-1/2" Brush Dia.	EA	1
<b>B-934</b>	Copper Tube Fitting Brush – 1-5/8" O.D., 1-3/4" Brush Dia.	EA	1
<b>B-935</b>	Copper Tube Fitting Brush – 2-1/8" O.D., 2-1/4" Brush Dia.	EA	1

**Carbon Steel Curved Handle Scratch Brush**

Carbon Steel Curved Handle Scratch Brushes are used for general purpose cleaning.



CATALOG NO.	DESCRIPTION	UOM	ORDER MULTIPLE
<b>B-10</b>	Carbon Steel Curved Handle Scratch Brush	EA	1

**Fin Whisk**

A plastic handled whisk for cleaning condenser and evaporator fins.



CATALOG NO.	DESCRIPTION	UOM	ORDER MULTIPLE
<b>B-26</b>	Fin Whisk Brush	EA	12

**Condenser/Heat Exchanger Brushes**

Ideal for cleaning mineral deposits from inside metal tubes. Especially recommended for use with power tools, although handle for manual use is available.



CATALOG NO.	DESCRIPTION	UOM	ORDER MULTIPLE
<b>B-622</b>	Condenser/Heat Exchanger Brush – 3/4" Brass 12-24 Female	EA	1

**CHANNELLOCK® PRODUCTS**

**Tongue and Groove Pliers**

These patented design pliers have permalock fasteners and reinforcing edge. The grips are also dipped in plastic for a more comfortable hold.



CATALOG NO.	DESCRIPTION	UOM	ORDER MULTIPLE
<b>545-420</b>	9-1/2" Tongue and Groove Pliers	EA	1
<b>545-422</b>	9-1/2" Curved Jaw Tongue and Groove Pliers	EA	1
<b>545-426</b>	6-1/2" Tongue and Groove Pliers	EA	1

CATALOG NO.	DESCRIPTION	UOM	ORDER MULTIPLE
<b>545-430</b>	10" Tongue and Groove Pliers	EA	1
<b>545-440</b>	12" Tongue and Groove Pliers	EA	1
<b>545-442</b>	12" Curved Jaw Tongue and Groove Pliers	EA	1
<b>545-460</b>	16" Tongue and Groove Pliers	EA	1



**ELECTRICAL SUPPLIES**

**Outdoor Extension Cord**

Heavy duty, round, vinyl extension cord designed for industrial use. Orange vinyl jacket protects against oil, grease, ozone, and gives added flexibility at below freezing temperatures. Vinyl plugs and connectors are molded on and won't break or pull off cord.



CATALOG NO.	DESCRIPTION	UOM	ORDER MULTIPLE
7-ECC12100	100' Extension Cord, 12/3 SJTW-A, 15 AMP	EA	3
7-ECC1225	25' Extension Cord, 12/3 SJTW-A, 15 AMP	EA	10
7-ECC1250	50' Extension Cord, 12/3 SJTW-A, 15 AMP	EA	6
7-ECC16100	100' 13 Amp Extension Cord SJTW-A 16/3	EA	6
7-ECC1625	25' 15 Amp Extension Cord SJTW-A 16/3	EA	24
7-ECC1650	50' 15 Amp Extension Cord SJTW-A 16/3	EA	12
7-ECC50725	25' 15 AMP Extension Cord SJTW-A 14/3	EA	14
7-ECC50730	50' 15 AMP Extension Cord SJTW-A 14/3	EA	10
7-ECC50735	100' 13 AMP Extension Cord SJTW-A 14/3	EA	5

Type: SJTW-A U.L. Listed, meets OSHA Requirements.

**Power Blocks**

Professional design gives contractors and industrial personnel maximum flexibility in arranging portable power needs at the job site. Vinyl connectors are solid molded for high resistance to breakage and abuse.



CATALOG NO.	DESCRIPTION	UOM	ORDER MULTIPLE
7-AD010000	Triple tap power block adapter converts single 15 AMP 125V U-ground outlet to 3 15A, 125V U-ground outlets	EA	10

**Metal Guard Trouble Lights**

Designed for rugged use by contractors and industrial. Tough plastic handles are heat and shock resistant, with switch and 15A, 125V grounding side outlet.



CATALOG NO.	DESCRIPTION	UOM	ORDER MULTIPLE
7-TLC10625	25' Metal Guard Trouble Light	EA	1
7-TLC10630	50' Metal Guard Trouble Light	EA	1

AWG: 16/3 TYPE: SJTW-A U.L. Listed, meets OSHA Requirements.

**Cable Clamp PRO**

The Cable Clamp PRO is the ultimate reusable cable management tool. Featuring a unique push button release and integrally attached carry handle serrated for easy grip. Carry handle also includes built-in lanyard hole allowing for attachment of rope, wire, or hook. Lanyard hole may be used for tethering of Cable Clamp PRO to cords, cable, and other devices. The medium size is for bundles up to 2-inch and the large size is for bundles up to 3-inch.



CATALOG NO.	DESCRIPTION	UOM	ORDER MULTIPLE
CCP-M	Cable Clamp PRO Display Box with 34 Medium	EA	34
CCP-L	Cable Clamp PRO Display Box with 24 Large	EA	25

**FIN TOOLS**

**Multi-Head Fin-Tool**

Conveniently straightens and cleans condenser and evaporator fins. Each nylon head slides into the master handle and tightens in place. Heads are designed to fit units with fin spacing of 4-24 fins per inch. Each head is engraved with its own size and is color coded for fast identification. Heads are angled so that when inserted in the handle, the hand is a safe distance from the sharp fins. Heads may also be reversed in the handle so that combing with an upward stroke (recommended method) may be done easily with proper leverage. The master handle rests comfortably in a man size grip, is rigid and long lasting.

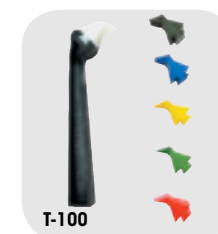

CATALOG NO.	DESCRIPTION	UOM	ORDER MULTIPLE
T-1	Handle Only - Black	EA	1
T-8	Head 8 FPI - Orange, pack of 3	PK	1
T-9	Head 9 FPI - Yellow, pack of 3	PK	1
T-10	Head 10 FPI - Natural, pack of 3	PK	1
T-100	Kit - 1 Handle and 6 Heads: 8, 9, 10, 11, 12, 14	EA	12
T-101	Kit - 1 Handle and 6 Heads: 13, 15, 16, 17, 18, 20	EA	12
T-11	Head 11 FPI - Blue, pack of 3	PK	1
T-12	Head 12 FPI - Green, pack of 3	PK	1
T-13	Head 13 FPI - Pink, pack of 3	PK	1
T-14	Head 14 FPI - Lt. Green, pack of 3	PK	1

CATALOG NO.	DESCRIPTION	UOM	ORDER MULTIPLE
T-16	Head 16 FPI - Brown, pack of 3	PK	1
T-20	Head 20 FPI - Purple, pack of 3	PK	1
T-21	Head 21 & 22 FPI - Rose (for Carrier unit), pack of 3	PK	1

U.S. Patent No. 4,018,076.

**FIN TOOLS cont'd**

**Fin-Tool**

Long lasting metal fin straightener. Straightens and cleans condenser and evaporator fins. One tool for all units. The heavy duty spring wire bristles automatically adjust to ALL fin spacings. An exclusive tension adjustment band is featured to allow maximum rigidity and ease of operation. Straightens most severely damaged fins.



**T-300**

CATALOG NO.	DESCRIPTION	UOM	ORDER MULTIPLE
<b>T-300</b>	Fin-Tool with heavy duty bicycle handle	EA	12

**SuperComb**

Easier to grip, easier to use tool for straightening condenser and evaporator fins. Straightens 50% more fins in one stroke. Keeps hands a safe distance from fins. Easy to grip, strong, durable, heavy duty nylon. Color coded for easy identification. Sold individually or 6 per set. Sales display available.

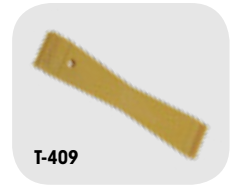

**T-409**

CATALOG NO.	DESCRIPTION	UOM	ORDER MULTIPLE
<b>T-400</b>	Set of 6 – 1 Ea.: T-408, T-409, T-411, T-410, T-417, T-418	EA	1
<b>T-409</b>	9 and 15 FPI – Yellow	EA	1
<b>T-411</b>	11 and 13 FPI – Blue	EA	1
<b>T-412</b>	12 and 14 FPI – Green	EA	1
<b>T-417</b>	16 and 17 FPI – Lime	EA	1
<b>T-418</b>	18 and 20 FPI – Red	EA	1

**FLASHLIGHTS BY RAYOVAC®**

**Rayovac is the Industrial Product Leader!**

Rayovac is the leader in the industrial battery market and has been for years, with an estimated 50% share of the traditional industrial distribution channel. Rayovac introduced the top-selling industrial flashlight to the market, and set the quality standard by which all other industrial flashlights are measured today. Whether your customer is searching for a toolbox-tough flashlight or high-performance batteries, Rayovac offers a broad range of products to meet your needs.

**Rayovac LED Flashlights**

This flashlight is water resistant with a machined aluminum with knurled grip and a bronze finish. There is a full lifetime warranty on this USA made product. A holster is included with this item.



**7-SPHW3AAA-BX**

CATALOG NO.	DESCRIPTION	UOM	ORDER MULTIPLE
<b>7-SPHW3AAA-BX</b>	Sportsman 3AAA 20 Lumen	EA	6

### Clipstrip™/Clipstrip2™

Clipstrip™ is a powerful pocket light with 140 lumens and includes a pivoting magnetic clip. It is available in yellow or camo with three AAA batteries included.



CATALOG NO.	DESCRIPTION	UOM	ORDER MULTIPLE
111112	Clipstrip™ Pocket Light	EA	12
111116	Clipstrip™ Pocket Camo Light	EA	12
111118	Clipstrip 2™ Pocket Light	EA	9

### PIVOT™

The PIVOT™ is a light that has a 360° swivel hook with 240 lumens and magnetic base and back. Three AA batteries included.



CATALOG NO.	DESCRIPTION	UOM	ORDER MULTIPLE
111114	PIVOT™ Pivoting Work Light	EA	9

### PIVOT™ 33

The Pivot™ 33 is a light that has a 360° swivel hook with 160 lumens and magnetic back and pivoting base. Lights on front and top with three AA batteries included. Available in yellow or camo.



CATALOG NO.	DESCRIPTION	UOM	ORDER MULTIPLE
24-458	PIVOT™ 33 Work Light	EA	9
24-460	PIVOT™ 33 Work Light, Camo	EA	9

### Clip-On Zoom Light

The Clip-On Zoom Light provides 150 lumens, 90° pivoting capability coupled with the ability to zoom from broad to narrow. It includes a magnetic base and includes three AAA batteries.



CATALOG NO.	DESCRIPTION	UOM	ORDER MULTIPLE
111128	Clip-On Zoom Worklight	EA	8

### HEMImini™

The HEMImini™ has up to 1000 lumens of power (4 hours - full power) with a 4400 mAh lithium-ion rechargeable battery. It includes a 180 degree swivel hook with an optional magnetic cover.



CATALOG NO.	DESCRIPTION	UOM	ORDER MULTIPLE
114301	HEMImini™ Work Light	EA	1
410239	Magnetic Cover for HEMImini™ Work Light	EA	1

### Clipstrip™ Aqua

Clipstrip™ Aqua is a waterproof light with 180 lumens and includes a magnetic clip and floats. It is available in yellow and comes with a rechargeable 2200 mAh lithium-ion battery. Sold individually.



CATALOG NO.	DESCRIPTION	UOM	ORDER MULTIPLE
111113	Clipstrip™ Aqua Light	EA	1

### PIVOT™ mini

The PIVOT™ mini is a light that has a 360° swivel hook with 120 lumens and magnetic back and base. Lights on front and top with three AAA batteries included. Available in yellow or camo.



CATALOG NO.	DESCRIPTION	UOM	ORDER MULTIPLE
111115	PIVOT™ mini Pivoting Work Light	EA	12
111117	PIVOT™ mini Pivoting Work Light, Camo	EA	12

### PIVOT™ Tough-Light

The PIVOT™ Tough Light has 150 lumens with a hanging hook and magnetic base. It also has 180 degree pivoting capability with three AAA batteries included.



CATALOG NO.	DESCRIPTION	UOM	ORDER MULTIPLE
111123	PIVOT™ Tough-Light Work Light	EA	8

### Cliplight Extends

The Cliplight Extends has 120 lumens at the top and 140 lumens in the front with a pivoting head. The light comes with a telescopic system and magnetic base. Four AAA batteries included.



CATALOG NO.	DESCRIPTION	UOM	ORDER MULTIPLE
111130	Cliplight Extends Worklight	EA	8

### HEMIPLUS™ 2

The HEMIPLUS™ 2 has up to 1200 lumens of power (4 hours - full power) with a 4400 mAh lithium-ion rechargeable battery. It includes a metal hook and removable magnetic cover.



CATALOG NO.	DESCRIPTION	UOM	ORDER MULTIPLE
114302	HEMIPLUS™ 2 Work Light	EA	1

**WORKLIGHTS BY CLIPLIGHT® cont'd**

**Spotlight**

The Spotlight is a cordless work light solution with up to 1200 lumens of power (3 hours - full power) with a 4000 mAh lithium-ion rechargeable battery. It includes two adjustable joints on magnetic stand for different angles. It has three power modes including a dimmer.

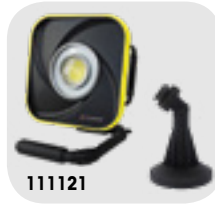

CATALOG NO.	DESCRIPTION	UOM	ORDER MULTIPLE
111121	Spotlight Cordless Work Light	EA	1

**Curve Light**

The Curve Light provides 300 lumens of lighting using chip-on board technology. Designed with a curved shape to protect the lens and rubber bumper for durability. It is rugged yet sleek. A hanging hook, magnetic base and three AA batteries are included.

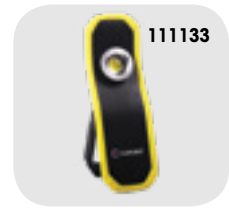

CATALOG NO.	DESCRIPTION	UOM	ORDER MULTIPLE
111133	Curve Heavy Duty Work Light	EA	6

**Flex Light**

The Flex Light provides 120 lumens of lighting for tight spaces with the ability to bend 90 degrees backwards and forwards. Designed with flexibility in mind, this light comes with a magnetic base and three AAA batteries.



CATALOG NO.	DESCRIPTION	UOM	ORDER MULTIPLE
111131	Flex Pocket Work Light	EA	8

**GAUGES**

**Manifold Gauge**

DiversiTech's MG-1 Manifold Gauge provides the technician with a precision diagnostic and monitoring analog gauge set complete with hoses.

The Manifold Gauge and Hose Set includes:

- 2 valve brass manifold
- 5' long high pressure hose set
- For use with the following refrigerants:
  - R-410A
  - R-22
  - R-407C
- Detailed gauge readings in PSI°F

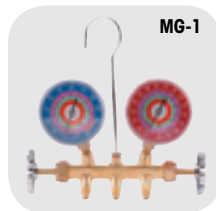

CATALOG NO.	DESCRIPTION	UOM	ORDER MULTIPLE
MG-1	Manifold Gauge and Hose Set	EA	1
MG-RGB	Replacement Gauge – blue	EA	1
MG-RGR	Replacement Gauge – red	EA	1

**MANOMETERS, PRESSURE AND TEST KITS**

**Hydrogauge Manometer**

Economical Pressure measurements.

- Replaces ordinary U-tube manometers
  - Measures gas pressure easily and efficiently
  - Direct reading, no plus or minus readings to add together as in old fashioned U-tubes
  - Fills like a glass of water, no more air bubbles
  - Strong magnet for mounting
  - Heavy-duty construction
  - Made of industrial grade, flexible PVC plastic
  - Lightweight; Easy to use
  - 6-HG15 water column height: 15"
  - Plastic: 30" to 36" of industrial grade flexible plastic
  - Hose fitting: All brass
- Includes: Mounting magnet.

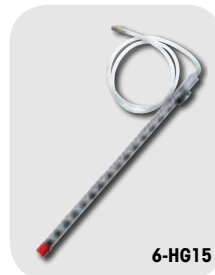

CATALOG NO.	DESCRIPTION	UOM	ORDER MULTIPLE
6-HG15	Hydrogauge Manometer	EA	1

**Gas Pressure Test Kit**

Rugged, Heavy Duty Field Use.

- Measure Natural gas (methane) or LP gas pressure across appliance manifolds.
  - Test gas stoves, furnaces, dryers and other gas appliances. Can also be used for other non-corrosive gases.
  - Large 2" sensitive diaphragm gauge is calibrated in inches of water column, also shows ounces per square inch
  - Magnified lens
  - Easier to use than a manometer
  - Range: 0 to 35 inches of water column (in. H<sub>2</sub>O) 0 to 20 ounces per square inch (oz./in<sup>2</sup>)
- Includes: 2" sensitive diaphragm gauge; 3' of rubber tubing; brass fitting for quick connection to the appliance manifold 3/8" NPT; molded hard case.



CATALOG NO.	DESCRIPTION	UOM	ORDER MULTIPLE
6-GPK035	Gas Pressure Test Kit	EA	1

**STAPLES AND STAPLE GUNS**

**T-50 Series Staples and Staple Guns**

The #1 selling staple gun in the world! Used extensively by building contractors, home do-it-yourselfers and specialty trade applications for tacking insulation, ceiling tile, window screening, cornerite, and 1001 other jobs ranging from light to heavy duty work. The T-50 Outward Clinch Staple Gun is ideal for fiberglass ductwork.

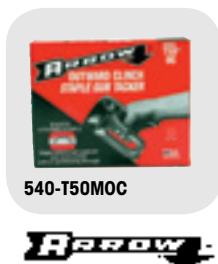

**540-T50MOC**

CATALOG NO.	DESCRIPTION	UOM	ORDER MULTIPLE
<b>540-506</b>	3/8" Leg Staples for T50 Staple Guns (1,250)	EA	4
<b>540-508</b>	1/2" Leg Staples for T50 Staple Guns (1,250)	EA	4
<b>540-509</b>	9/16" Leg Staples for T50 Staple Guns (1,250)	EA	4
<b>540-T50M</b>	T50M Heavy Duty Staple Gun Tacker	EA	1
<b>540-T50MOC</b>	T50MOC Outward Clinch Staple Gun	EA	1

**MISCELLANEOUS TOOLS**

**Compressor TOTE**

Makes light work of a heavy job. Powder coated, strong steel construction. Recommended for use with all compressors up to 5 tons. Compatible with high efficiency compressors. Pick up a compressor from its box. Carry a compressor up a ladder. Now with black protective finish.



**ACT-6**

CATALOG NO.	DESCRIPTION	UOM	ORDER MULTIPLE
<b>ACT-6</b>	Compressor Tote	EA	6

**4-Piece Hook and Pick Set**

For separating wires, removing small fuses, "O" rings, retrieving washers and loose parts too small to pick up with your fingers. Bright-dipped, anodized hex-shaped aluminum handles with powerful magnet on end. Handy screw-in hook, pick, point and scribe. High carbon polished needle steel. All in a compact zip-lock vinyl pouch that fits in your shirt pocket! Set includes four screw-in tips plus handle.



**MHP-4**

CATALOG NO.	DESCRIPTION	UOM	ORDER MULTIPLE
<b>MHP-4</b>	4-Piece Hook and Pick Set	EA	1

**Telescopic Inspection Mirror**

Fast, accurate visual inspection of hidden areas with an almost limitless number of positions. Double ball joint links swivel mirrors for viewing to 360°. Precision engineered links are made from tempered spring steel to withstand the stresses of constant repositioning. Moves freely, holds desired position.



**M-1**

CATALOG NO.	DESCRIPTION	UOM	ORDER MULTIPLE
<b>M-1</b>	Mirror – 1-1/4" Circular – extends 6-1/4" to 18-1/4"	EA	1
<b>M-1R</b>	Replacement Head for M-1	EA	1
<b>M-2</b>	Mirror – 2-1/4" Circular – extends 10" to 14"	EA	1
<b>M-2R</b>	Replacement Head for M-2	EA	1
<b>M-3</b>	Mirror – 2-1/8" x 3-1/2" Rectangular – extends 11-1/4" to 15-1/4"	EA	1
<b>M-3R</b>	Replacement Head for M-3	EA	1
<b>M-5</b>	Mirror – 1" x 2" Oval – extends 8-1/2"	EA	1

**MONITORS**

**007 Control Checker**

A lifetime tool for monitoring and checking safety controls and operating controls. One unit for all voltages 24-460 VAC or DC without switching dials or meters. Compact, 4 oz, reliable. Saves troubleshooting. For normally closed controls, 007 connects in parallel with safety control. When the safety control opens in response to a problem in the system, 007 red LED turns on and remains on until reset manually. With intermittent problem, the LED remains on indicating the control is open. For operating controls, 007 verifies the status of all types indicating if there is power to the holding coil, the NC contact is open or closed, the thermostat contacts are open or closed, there is power to the contactor or starting holding coil, the overloads are open or closed, or there is a bad connection either on control or power side. NOTE: May use with lockout relays. Features battery check and reset switch. Includes 9-volt battery. 007 may be used over and over.



**TC-007**

CATALOG NO.	DESCRIPTION	UOM	ORDER MULTIPLE
<b>TC-007</b>	007 Control Checker	EA	1

U.S. Pat. No. 4,092,625.

**Tattle-Tale Control Monitor**

Identifies open controls in seconds. A single use monitoring device for determining which safety control has opened in response to a malfunction. Saves wasted hours tracing a safety control shutdown, even if intermittent. A quick, inexpensive way to visually spot where the problem is. Simply install in parallel with each safety control. When a control opens, the red indicator flag pops up. You will know immediately which area of the system is experiencing problems. Disposable, safe, simple to use, and pocket sized. Monitors safety controls, fuses, overload relays, motor protectors, freeze controls, limit controls, safety switches, fusible links, or steam control. CAUTION: Not to be used with lockout relays, use TC-007.



**TT-24**

CATALOG NO.	DESCRIPTION	UOM	ORDER MULTIPLE
<b>TT-120</b>	Tattle-Tale Control Monitor – 120 Volt AC or DC, pack of 3	PK	1
<b>TT-24</b>	Tattle-Tale Control Monitor – 24 Volt AC or DC, pack of 3	PK	1
<b>TT-240</b>	Tattle-Tale Control Monitor – 240 Volt AC or DC, pack of 3	PK	1

Tolerance on all voltages shown is ± 20%. U.S. Pat. No. 4,250,480.

**REFRACTOMETERS**

**Refractometer**

The Refractometer can measure the freezing point of coolants, glycol and the Charge Condition of Batteries.



**6-REF401**

CATALOG NO.	DESCRIPTION	UOM	ORDER MULTIPLE
<b>6-REF401</b>	Refractometer	EA	1

**RETRIEVING TOOL**

**Reach-It**

Our Reach-It is made of durable chrome plated brass and retracts to 5in. long. A match can quickly be inserted with the Reach-It.



**R-1**

CATALOG NO.	DESCRIPTION	UOM	ORDER MULTIPLE
<b>R-1</b>	Reach-It – extends to 26-3/4"	EA	12

**SAWS AND SAW BLADES**

**Deluxe Hi-Tension Hacksaw**

Hackframe featuring handle and end pieces made of die cast aluminum. Lightweight yet rigid and highly tensioned (up to 25,000 psi) for cleaner, surer cut. Permanent blade pins feature versatile angling (up to 55°) for flush cutting. Blade can be inserted in handle to be used as compass saw. Frame will fit most standard tool boxes.



CATALOG NO.	DESCRIPTION	UOM	ORDER MULTIPLE
<b>540-278BM0024</b>	Replacement Blades for Hacksaw Frame 12" x 24T	EA	10
<b>540-278HX0002</b>	Hacksaw Frame with Blade	EA	1

**Bi-Metal Reciprocating Saw Blades**

Premium high speed steel with a flexible alloy back. Bi-metal blades fit all reciprocating saws with 1/2" shank.



CATALOG NO.	DESCRIPTION	UOM	ORDER MULTIPLE
<b>540-RBCCRf</b>	Cast Iron-Ceramic Tile Carbide Grit 8" Long	EA	1
<b>540-RB125W</b>	12" x 6T Wood and Nail 3/4" x 12" x .050	EA	5
<b>540-RB414M</b>	4" x 14T Short Metal Cutting 3/4" x 4" x .035	EA	5
<b>540-RB418M</b>	4" x 18T Short Metal Cutting 5/8" x 4" x .035	EA	5
<b>540-RB610HDM</b>	6" x 10T HD Metal Cutting 3/4" x 6" x .035	EA	5
<b>540-RB614HDM</b>	6" x 14T HD Metal Cutting 3/4" x 6" x .035	EA	5
<b>540-RB618HDM</b>	6" x 18T HD Metal Cutting 3/4" x 6" x .035	EA	5
<b>540-RB624HDM</b>	6" x 24T HD Metal Cutting 3/4" x 6" x .035	EA	5
<b>540-RB636DW</b>	Drywall Cutting with V Head 5/8" x 6" x .035	EA	5
<b>540-RB636W</b>	6" x 6T Wood and Nail Slope 3/4" x 6" x .050	EA	5
<b>540-RB656WS</b>	6" x 6T Wood and Nail Scroll 3/4" x 6" x .050	EA	5
<b>540-RB810HDM</b>	8" x 10T HD Metal Cutting 3/4" x 8" x .035	EA	5
<b>540-RB814HDM</b>	8" x 14T HD Metal Cutting 3/4" x 8" x .035	EA	5
<b>540-RB956W</b>	9" x 6T Wood and Nail 3/4" x 9" x .050	EA	5

**SCREWDRIVERS, DRIVER SETS**

**Pocket 4-in-1 Mini Screwdriver**

This screwdriver set is ideal for technicians, hobbyists, and do it yourselfers. There are 2 double-ended vanadium blades. You can change blades instantly and the blades are held in the carrier handled. The dimensions are 1/16 in. and 1/8 in. slotted tips and #1 and #00 cross point. The Mini Screwdriver comes in with a convenient pocket clip and angled ends.

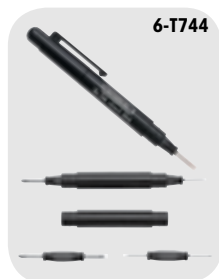

CATALOG NO.	DESCRIPTION	UOM	ORDER MULTIPLE
<b>6-T744</b>	Pocket 4-in-1 Mini Screwdriver – Length: 5-1/8" (130mm)	EA	1

**Combination Screwdrivers**

Multiple bits in one handy screwdriver. No need for a toolbox for those quick jobs. Lifetime guarantee.



CATALOG NO.	DESCRIPTION	UOM	ORDER MULTIPLE
<b>5-41</b>	4-in-1 with #1 and #2 Phillips, 3/16" and 5/16" Slotted	EA	12
<b>5-61</b>	6-in-1 with #1 and #2 Phillips, 3/16" and 5/16" Slotted 1/4" Nut Driver, and 5/16" Nut Driver	EA	12

**SNIPS, NOTCHERS, CRIMPERS, SEAMERS**

**Aviation Snips**

Moly alloy tool steel blade is hot drop-forged and scientifically heat-treated to provide a strong, longer lasting cutting edge. Durable serrated blades are designed to grip the metal for cutting ease. The patent pending spring on these snips is guaranteed to last for the life of the tool. Will cut 18 gauge cold-rolled steel.



CATALOG NO.	DESCRIPTION	UOM	ORDER MULTIPLE
540-6716B	Aviation Snip – Bulldog Notching Snip – Blue Handle	EA	6
540-6716L	Aviation Snip – Cuts Left – Red Handle	EA	6
540-6716R	Aviation Snip – Cuts Right – Green Handle	EA	6
540-6716S	Aviation Snip – Cuts Straight – Yellow Handle	EA	6

**HVAC Tools**

Hot drop-forged carbon steel blades. Compound leverage action handles. Heavy duty plastic grips.



CATALOG NO.	DESCRIPTION	UOM	ORDER MULTIPLE
540-FCTMC5	8" Crimper – 22 Ga. Crimping Capacity	EA	1
540-FCTMN1	8" Notcher – 31° Cutting Angle	EA	1
540-FCTMS1	3" Straight Seamer – 22 Ga. Capacity	EA	1
540-FCTMS2	3" Offset Seamer – 22 Ga. Capacity	EA	1

**STRAPS, TRUCK ROPE**

**Truck Rope**

All-purpose high strength polypropylene truck rope is C.H.P. approved.



CATALOG NO.	DESCRIPTION	UOM	ORDER MULTIPLE
25001	Truck Rope – 3/8" x 50'	EA	1
CR070	Truck Rope – 3/8" x 50' (Yellow)	EA	1

**Offset Snips**

The same high quality construction as the Aviation Snips with an additional advantage – the Offset Snips allow your hand to stay above metal for cutting ease and comfort.



CATALOG NO.	DESCRIPTION	UOM	ORDER MULTIPLE
540-6510L	Offset Snip – Cuts Left – Red Handle	EA	6
540-6510R	Offset Snip – Cuts Right – Green Handle	EA	6

**Upright Snips**

This snip significantly improves sheet metal cutting. The ergonomic design allows for easier cutting in tight places, improved safety by elevating hands above metal working surfaces, and increases wrist range motion.



CATALOG NO.	DESCRIPTION	UOM	ORDER MULTIPLE
540-6900L	Upright Snips – Left-handed Model	EA	6
540-6900R	Upright Snips – Right-handed Model	EA	6

**Lashing Strap**

Quickly lashes and secures refrigerators, air conditioners, washers, driers, etc. Strong nylon webbing rated at 3000 lbs. and end hooks at 1200 lbs. tensile strength. Hand loop for easy tightening. Steel cam lever buckle is easy to adjust and releases quickly. Secures a maximum load of 1000 pounds. 12' long.



CATALOG NO.	DESCRIPTION	UOM	ORDER MULTIPLE
HS-144	Lashing Strap – 144"	EA	6



**STRAPS, TRUCK ROPE cont'd**

**Ratchet Strap**

Easy ratcheting permits tie-down of appliances securely. An innovative latch and a fast release cam reduces socket wear. Cadmium-plated steel buckle has a positive lock that eliminates release due to vibration. When closed, the handle locks the latch into the sprocket to prevent inadvertent release. 16' nylon webbing rated at 3000 PSI tensile. Vinyl coated end hooks rated at 1200 PSI tensile.



HS-192

CATALOG NO.	DESCRIPTION	UOM	ORDER MULTIPLE
HS-192	Ratchet Strap – 16'	EA	3

**Hanging Strap**

Strong, versatile, easy way to secure loose gear safely. Tie down ladders, tubing, cylinders or almost anything in seconds. Cannot snap back. Strong, durable 1" polypropylene webbing. Reinforced grommet lets you hang it up, tie it up, hook it up or attach it permanently. Spring loaded adjustable buckle. Easy to get firm tension with no slipping. Make an endless length by connecting 2 or more together.



HS-30

CATALOG NO.	DESCRIPTION	UOM	ORDER MULTIPLE
HS-30	Hanging Strap – 31"	EA	24
HS-30-2	Hanging Strap – 31", 2 Straps per Card, pack of 12	PK	1
HS-60	Hanging Strap – 60"	EA	24
HS-60-2	Hanging Strap – 60", 2 Straps per Card, pack of 12	PK	1

**Rubber Tie Down Strap**

Can stretch to double its length. Quickly ties down ladders, tubing, cylinders or almost anything. Extra heavy steel "S" hooks on each end. Resists cracking and deterioration.



RS-15

CATALOG NO.	DESCRIPTION	UOM	ORDER MULTIPLE
RS-9	Rubber Tie Down Strap – 10"	EA	10
RS-15	Rubber Tie Down Strap – 15"	EA	10
RS-20	Rubber Tie Down Strap – 20"	EA	10
RS-31	Rubber Tie Down Strap – 31"	EA	10
RS-41	Rubber Tie Down Strap – 41"	EA	10

**Carabiners**

Carabiners come in a 2 piece package and are made of 8 mm anodized aluminum. Great for attaching ropes and clipping to tool belts. For indoor or outdoor use – work or leisure. Various colors.

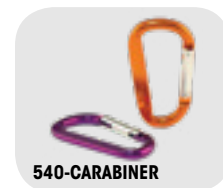

540-CARABINER

CATALOG NO.	DESCRIPTION	UOM	ORDER MULTIPLE
540-CARABINER	Carabiner Clip, pack of 2	PK	1

**TEST LEADS**

**Test Leads**

Alligator clips are covered by pure vinyl boots for flexibility at any temperature without cracking.



FTL3

CATALOG NO.	DESCRIPTION	UOM	ORDER MULTIPLE
ACK4	2 Red and 2 Black Boots w/4 Alligator Clips	EA	1
FTL3	Pair, Red and Black – 36"	EA	1
FTL3D	Pair, Red and Black – Super Heavy Duty – 36"	EA	1

**Multi Color Test Leads**

Easy to use multi-colored test leads. 5 colors (white, red, black, yellow, green) with 2 connections each for easy testing on the job. Wire is 18 gauge, 18" long.



CT800

CATALOG NO.	DESCRIPTION	UOM	ORDER MULTIPLE
CT800	Multi Color Test Leads	EA	1

**Magjumper**

Magjumper from DiversiTech is a magnetic jumper for low voltage troubleshooting. It features a 20" length with magnetic tips that won't pop off like alligator clips sometimes can. It stays flexible even in cold weather and is perfect for recessed terminals. Magjumper is ideal for use on control boards, zone panels, thermostats, hydronics and automation controllers.



MAG-1

CATALOG NO.	DESCRIPTION	UOM	ORDER MULTIPLE
MAG-1	Magjumper Terminal Kit	EA	1

**TESTERS**

**Test Cord (Female)**

Heavy duty red and black boots are on this cord. The cord has large clips, 3 wires, and is 24in. With this cord, you can get power in remote areas without an 110V outlet. The voltage is 3 to 20 V and has 125 AMPs. The wire gauge is 16 and the weight is .36 lb.



CATALOG NO.	DESCRIPTION	UOM	ORDER MULTIPLE
<b>6-CT700F</b>	Test Cord (Female)	EA	1

**Leak Test Gauge**

This Gas gauge test is ideal for teasing all new installations of or leaks and passing inspection code. The special sensitive diaphragm gauges for more accurate low pressure readings.



CATALOG NO.	DESCRIPTION	UOM	ORDER MULTIPLE
<b>TG-05</b>	Leak Test Gauge – 3/4" FPT., 15 psi	EA	1
<b>TG-30-12</b>	Leak Test Gauge – 1/2" FPT. Conn., 30 psi	EA	1
<b>TG-30</b>	Leak Test Gauge – 3/4" FPT. Conn., 30 psi	EA	1
<b>TG-30-1</b>	Leak Test Gauge – 1" FPT. Conn., 30 psi	EA	1

**THERMOMETERS/PROBES**

**Digital Thermometer**

Temperature range from -40°F to 230°F. Packaged on attractive display card.



CATALOG NO.	DESCRIPTION	UOM	ORDER MULTIPLE
<b>541-300</b>	Digital Thermometer	EA	1

**Horizontal Refrigerator/Freezer Analog Thermometer**

With this analog thermometer, you can use it either hanging or free standing. The easy to ready display can be seen with a horizontal reading. Both F and C scales are reflected on the thermometer and the range is -40° to 80°F (-40° to 27°C).



CATALOG NO.	DESCRIPTION	UOM	ORDER MULTIPLE
<b>6-FT80H</b>	Horizontal Refrigerator/Freezer Analog Thermometer	EA	1

**Deluxe Digital Pocket Thermometer**

Deluxe Digital Pocket Thermometers are water and drop resistant and have a rugged construction. There is an auto power off and an F/C Switch. The probe is 2.5 in. and the range is from -40 degrees F to 300 degrees F or -40 degrees C to 150 degrees C. This thermometer comes with a protective cover with clip.



CATALOG NO.	DESCRIPTION	UOM	ORDER MULTIPLE
<b>6-HDT303K</b>	Deluxe Digital Pocket Thermometer	EA	1

**Analog Pocket Thermometer with Magnifying Lens**

- Range 6-320: -40° to 160°F
  - Range 6-321: -0° to 220°F
  - Rugged stainless steel probe
- Includes: Protective sheath with pocket clip.

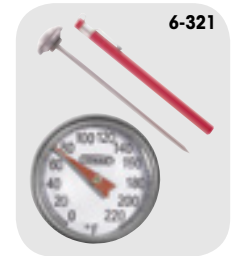

CATALOG NO.	DESCRIPTION	UOM	ORDER MULTIPLE
<b>6-321</b>	Analog Pocket Thermometer: Range -0° to 220°F	EA	1

**Refrigerator/Freezer Analog Thermometer**

This analog thermometer is stainless steel and can be used either hanging or free standing. The easy to read round dial is in F only. There are temperature indicators with a range -20° to 80°F (-29° to 27°C)



CATALOG NO.	DESCRIPTION	UOM	ORDER MULTIPLE
<b>6-FT80R</b>	Refrigerator/Freezer Analog Thermometer	EA	1

## TUBE WORKING TOOLS

### Kut-All Plastic Tube and Hose Cutter

Tough, durable nylon. Blade closes into its own handle for safe handling. Replaceable high carbon, teflon coated steel blades. Ideal for cutting up to 1-1/8" I.D. plastic tubing, reinforced plastic tubing, rigid plastic pipe, and rubber hose.



CATALOG NO.	DESCRIPTION	UOM	ORDER MULTIPLE
<b>PK-2</b>	Kut-All Plastic Tube and Hose Cutter	EA	1

### Swivel Head Deburring Tool

This Swivel head Deburring Tool has the professional quality and the performance of a higher price deburring tool without the price tag. This product has two interchangeable blades.



CATALOG NO.	DESCRIPTION	UOM	ORDER MULTIPLE
<b>6-T482</b>	Handle length: 5-1/8" (130mm)	EA	1

### One-Handed PVC/Hose Cutter

The ratchet system holds the blade in place while you adjust your grip to increase the pressure. The high carbon steel blade maintains sharpness and resists chipping. These cutters can be used for cutting PVC, CPVC, Polyethylene, PEX, and ABS tubing. The cutters have a quick-blade reset and can be used as a one handed operation. With the handle locking strap for safe storage, the easy replacing blade feature, and the ergonomically designed handle, these cutters are a perfect addition to any tool box.



CATALOG NO.	DESCRIPTION	UOM	ORDER MULTIPLE
<b>6-T1191</b>	Capacity: 1/8" to 1-5/8"; Length: 8-1/4" (210mm)	EA	1

## WELDING TORCHES, SUPPLIES

### Heat Resistant Cloth

This flame barrier drop cloth withstands temperatures to 3,000°F. No asbestos. Protects walls, floors, equipment, components and adjacent surfaces from torch flames when soldering, brazing or welding. All cloths have edges taped and sewn with grommets at each corner. Highly resistant to many chemicals and acids.

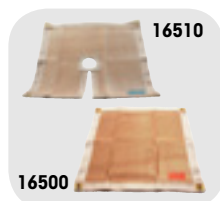

CATALOG NO.	DESCRIPTION	UOM	ORDER MULTIPLE
<b>16500</b>	18" x 18" Plain	EA	1
<b>16510</b>	18" x 18" Keyhole w/cutout for draping over pipes/tubes	EA	1
<b>16520</b>	36" x 36" Plain	EA	1

### Map-Pro and Propane Gas

Map-Pro and Propane Gas are tanks that can be used to weld products.



CATALOG NO.	DESCRIPTION	UOM	ORDER MULTIPLE
<b>525-MT1</b>	Map-Pro Gas – 14 oz.	EA	12
<b>525-PT1</b>	Propane Gas – 14.1 oz.	EA	12

### Portable Hand Torch

Self igniting hand torch eliminates the need for a flint lighter. Lightweight and portable, this flame tool can be operated with Propane or MAP-Pro™ (Propylene). Features trigger lock with instant safety release, full size comfort grip and 360° swivel tip. Operates in any position, even upside down. Includes swirl combustion tip end.



CATALOG NO.	DESCRIPTION	UOM	ORDER MULTIPLE
<b>525-TORCH</b>	Portable Hand Torch	EA	1

# Do **MORE** with **DEVCO**®

*DEVCO products help you do even more for your customers. Offering a broad selection of the parts your contractors need to finish the job, DEVCO helps you provide them all the finishing touches they need for any project. So stock up today and do more with DEVCO.*

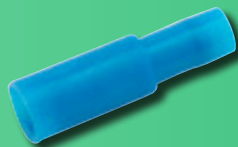

# PLUMBING

CPVC-CTS Pipe and Fittings.....	196
Nylon Fittings .....	196-197
Oatey® Products .....	198
PVC Condensate Pipe .....	200
PVC DWV Fittings .....	200
PVC Primer and Cement .....	199
PVC Schedule 40 Pressure Fittings .....	201-203
Supports .....	204
Tubing, Clamps, and Kits .....	204

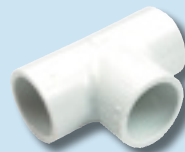

## CPVC-CTS PIPE AND FITTINGS

### CPVC-CTS Pipe by FlowGuard® Gold™

CTS = Copper Tube Size

CATALOG NO.	DESCRIPTION	UOM	ORDER MULTIPLE
4700-12	1/2" x 10' CPVC Pipe, 500'	EA	500'
4700-34	3/4" x 10' CPVC Pipe, 250'	EA	250'



4700-12

### CPVC-CTS Fittings by FlowGuard® Gold™

CTS = Copper Tube Size

CATALOG NO.	DESCRIPTION	UOM	ORDER MULTIPLE
4701-12	1/2" Coupling S x S	EA	20
4704-12	1/2" Adapter M x S	EA	20
4707-12	1/2" 90° Elbow S x S	EA	20
4711-12	1/2" Tee S x S x S	EA	20
47072-12	1/2" 90° Street Ell S x S	EA	10
4718-12	3/4" x 1/2" CPVC Bushing	EA	10
4701-34	3/4" Coupling S x S	EA	20
4703-34	3/4" Adapter F x S	EA	25
4704-34	3/4" Adapter M x S	EA	10
4706-34	3/4" 45° Elbow S x S	EA	20
4707-34	3/4" 90° Elbow S x S	EA	20
4711-34	3/4" Tee S x S x S	EA	20
47072-34	3/4" 90° Street Ell S x S	EA	10



4703-34

## NYLON FITTINGS\*

### Male Adapter (Barb x MIPT)



701-001

CATALOG NO.	DESCRIPTION	UOM	ORDER MULTIPLE
701-001	Adapter – 1/2" Barb x 1/2" MIPT, pack of 2	PK	1
701-002	Adapter – 1/2" Barb x 3/4" MIPT, pack of 2	PK	1
701-003	Adapter – 1/2" Barb x 3/8" MIPT, pack of 2	PK	1
701-007	Adapter – 3/4" Barb x 3/4" MIPT, pack of 2	PK	1
701-012	Adapter – 3/8" Barb x 1/2" MIPT, pack of 2	PK	1
701-013	Adapter – 3/8" Barb x 3/8" MIPT, pack of 2	PK	1
701-014	Adapter – 5/8" Barb x 3/4" MIPT, pack of 2	PK	1
701-043	Adapter – 3/8" Barb x 3/4" MIPT, pack of 2	PK	1

### Female Adapter (Barb x FIPT)



701-006

CATALOG NO.	DESCRIPTION	UOM	ORDER MULTIPLE
701-006	Adapter – 3/4" Barb x 3/4" NPT, pack of 2	PK	1
701-041	Adapter – 1/2" Barb x 1/2" NPT, pack of 2	PK	1

### Bushing (MIPT x FIPT)



701-015

CATALOG NO.	DESCRIPTION	UOM	ORDER MULTIPLE
701-015	Bushing – 1" MIPT x 3/4" FIPT, pack of 2	PK	1
701-017	Bushing – 3/4" MIPT x 1/2" FIPT, pack of 2	PK	1

### Garden Hose Adapters



701-009

CATALOG NO.	DESCRIPTION	UOM	ORDER MULTIPLE
701-009	Adapter – 3/4" MGHT x 3/4" FIPT, pack of 2	PK	1
701-011	Adapter – 3/4" MIPT x 3/4" FGHT, pack of 2	PK	1

\*All fittings packaged with identification. To order nylon fittings in bulk, enter catalog number followed by the letter "B." For example, 701-001B is the bulk part number for 701-001. Bulk sold in packs of 100.

**Elbow (Barb x Barb)**



CATALOG NO.	DESCRIPTION	UOM	ORDER MULTIPLE
<b>701-018</b>	Elbow – 1/2" Barb, pack of 2	PK	1
<b>701-023</b>	Elbow – 3/4" Barb, pack of 2	PK	1
<b>701-040</b>	Elbow – 5/8" Barb, pack of 2	PK	1
<b>701-046</b>	Elbow – 3/8" Barb, pack of 2	PK	1

**Male Adapter Elbow (Barb x MIPT)**



CATALOG NO.	DESCRIPTION	UOM	ORDER MULTIPLE
<b>701-020</b>	Elbow – 1/2" Barb x 3/4" MIPT, pack of 2	PK	1
<b>701-025</b>	Elbow – 3/4" Barb x 3/4" MIPT, pack of 2	PK	1
<b>701-028</b>	Elbow – 5/8" Barb x 3/4" MIPT, pack of 2	PK	1

**Tee (Barb x Barb x Barb)**



CATALOG NO.	DESCRIPTION	UOM	ORDER MULTIPLE
<b>701-034</b>	Tee – 1/2" Barb, pack of 2	PK	1
<b>701-035</b>	Tee – 1/2" x 3/4" x 1/2" Barb, pack of 2	PK	1
<b>701-037</b>	Tee – 3/4" Barb, pack of 2	PK	1
<b>701-038</b>	Tee – 3/8" Barb, pack of 2	PK	1
<b>701-039</b>	Tee – 5/8" Barb, pack of 2	PK	1

**Female Adapter Elbow (Barb x FIPT)**



CATALOG NO.	DESCRIPTION	UOM	ORDER MULTIPLE
<b>701-019</b>	Elbow – 1/2" Barb x 3/4" NPT, pack of 2	PK	1

**Hose Mender (Barb x Barb)**



CATALOG NO.	DESCRIPTION	UOM	ORDER MULTIPLE
<b>701-029</b>	Hose Mender – 1/2" Barb, pack of 2	PK	1
<b>701-030</b>	Hose Mender – 1/4" Barb, pack of 2	PK	1
<b>701-031</b>	Hose Mender – 3/4" Barb, pack of 2	PK	1
<b>701-032</b>	Hose Mender – 3/8" Barb, pack of 2	PK	1
<b>701-033</b>	Hose Mender – 5/8" Barb, pack of 2	PK	1

\*All fittings packaged with identification. To order nylon fittings in bulk, enter catalog number followed by the letter "B." For example, 701-001B is the bulk part number for 701-001. Bulk sold in packs of 100.

**OATEY® PRODUCTS**

**PVC Cement – Clear**

PVC Cement is clear. All cans have brushtop applicator.



CATALOG NO.	DESCRIPTION	UOM	ORDER MULTIPLE
5-14	Oatey #31012 – 1/4 Pint	EA	24
5-12	Oatey #31013 – 1/2 Pint	EA	24
5-10	Oatey #31014 – 1 Pint	EA	24
5-32	Oatey #31015 – 32 oz.	EA	12

**Purple Primer for PVC Pipe and Fittings (Black Label)**

Recommended for all PVC and CPVC installations – all sizes/schedules. Purple tinted primer formulated to remove surface dirt and grease as well as soften the pipe surface to allow for a fast, secure and permanent solvent weld. For use in areas where codes call for primer verification.



CATALOG NO.	DESCRIPTION	UOM	ORDER MULTIPLE
530-30755	Purple Primer – 4 oz.	EA	24
530-30756	Purple Primer – 8 oz.	EA	24
530-30757	Purple Primer – 16 oz.	EA	24

NSF and UPC listed. Exceeds ASTM F-656.

**Heavy Duty PVC Cement**

Heavy bodied clear cement recommended for use on PVC pipe and fittings up to 12" in diameter for Sch. 40 and Sch. 80 potable water pressure pipe, gas, conduit, drain waste and vent pipe. Exceeds ASTM D-2564.



CATALOG NO.	DESCRIPTION	UOM	ORDER MULTIPLE
530-30850	Heavy Duty Cement – 4 oz.	EA	24
530-30863	Heavy Duty Cement – 8 oz.	EA	24
530-30876	Heavy Duty Cement – 16 oz.	EA	24

**Rain-R-Shine Blue Cement**

Medium bodied blue colored cement for PVC pipe and fittings up to 6 inches in diameter. A very fast setting cement formulated for wet conditions and/or when quick pressurization and fast installation is needed. Exceeds ASTM D-2564.



CATALOG NO.	DESCRIPTION	UOM	ORDER MULTIPLE
530-30890	Rain-R-Shine Cement – 4 oz.	EA	24
530-30891	Rain-R-Shine Cement – 8 oz.	EA	24
530-30893	Rain-R-Shine Cement – 16 oz.	EA	24

**Medium Orange CPVC Cement**

Medium Orange CPVC Cement is formulated for use on all schedules and classes of CPVC pipe and fittings up to 6" diameter with interference fit.



CATALOG NO.	DESCRIPTION	UOM	ORDER MULTIPLE
530-11029	Medium Orange CPVC Cement – 4 oz.	EA	24

**PVC Primer – Clear**

Recommended for all PVC and CPVC applications. Can be used on all sizes and schedules. Formulated to remove all surface dirt, grease, and grime as well as soften the pipe in preparation for solvent cement. This primer can be used when you want a cleaner installation. Meets ASTM F-656 and is NSF listed.



CATALOG NO.	DESCRIPTION	UOM	ORDER MULTIPLE
530-30752	PVC Primer – Clear – 16 oz.	EA	24

**All-Purpose Clear Cement for ABS, PVC and CPVC Pipe and Fittings**

Heavy-bodied clear cement recommended for use on ABS, PVC, and CPVC pipe and fittings up to 12" in diameter. Flows freely and provides a thick layer of cement on the pipe. Apply at temperatures 40° to 90°F.

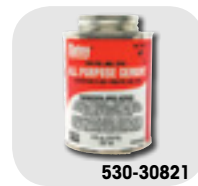

CATALOG NO.	DESCRIPTION	UOM	ORDER MULTIPLE
530-30818	Clear Cement – 4 oz.	EA	24
530-30821	Clear Cement – 8 oz.	EA	24
530-30834	Clear Cement – 16 oz.	EA	24

**PVC Gray Cement for High Efficiency Furnaces, Vent and Make-Up Air**

Medium-bodied gray colored cement for use on Sch. 40 conduit, drain waste, and vent pipe. Flows freely and covers with a thicker layer than regular PVC. Can be applied at temperatures 40° to 100°F.



CATALOG NO.	DESCRIPTION	UOM	ORDER MULTIPLE
530-30884	Gray Cement – 8 oz.	EA	24
530-30885	Gray Cement – 16 oz.	EA	24

NSF and UPC listed. Exceeds ASTM D-2564.

**All Weather PVC Cement**

Medium bodied cement for PVC pipe and fittings up to 6". Formulated for fast initial set-up from -15°F to 100°F. Exceeds ASTM D-2564.



CATALOG NO.	DESCRIPTION	UOM	ORDER MULTIPLE
530-31132	All Weather Cement – 16 oz.	EA	24
530-31133	All Weather Cement – 32 oz.	EA	12

**Clear Cleaner**

Clear Cleaner is a simple and effective cleaner formulated for ABS, PVC and CPVC pipe and fittings that flows freely and evaporates quickly.



CATALOG NO.	DESCRIPTION	UOM	ORDER MULTIPLE
530-10202	Clear Cleaner – 16 oz.	EA	24
530-10203	Clear Cleaner – 8 oz.	EA	24



## PVC PRIMER AND CEMENT

### Pro-Weld™ PVC Cement (Regular Body)

Pro-Weld™ PVC Cement is a clear, regular bodied solvent cement designed to be used on Type I and II PVC pipe and fittings up to and including 4 inch diameter. Pro-Weld™ meets ASTM Standard D-2564.



CATALOG NO.	DESCRIPTION	UOM	ORDER MULTIPLE
<b>PW-4</b>	Pro-Weld™ – 4 oz. Brush-Top Container – Regular Body	EA	24
<b>PW-8</b>	Pro-Weld™ – 8 oz. Brush-Top Container – Regular Body	EA	24
<b>PW-16</b>	Pro-Weld™ – 16 oz. Brush-Top Container – Regular Body	EA	24
<b>PW-32</b>	Pro-Weld™ – 32 oz. Brush-Top Container – Regular Body	EA	12

### Pro-Weld™ PVC Cement (Heavy Body)

Pro-Weld™ Heavy Body is a clear, heavy bodied, very high strength industrial grade PVC cement. It has a medium setting time and works with all rigid schedule 40 and 80 pipe diameters up to 12 inches. Complies with ASTM D2564 and NSF.

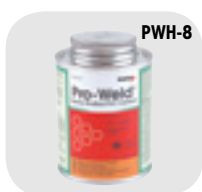

CATALOG NO.	DESCRIPTION	UOM	ORDER MULTIPLE
<b>PWH-4</b>	Pro-Weld™ – 4 oz. Brush-Top Container – Heavy Body	EA	24
<b>PWH-8</b>	Pro-Weld™ – 8 oz. Brush-Top Container – Heavy Body	EA	24
<b>PWH-16</b>	Pro-Weld™ – 16 oz. Brush-Top Container – Heavy Body	EA	24

### Pro-Weld™ PVC Cement (Pool and Turf – Blue)

Pro-Weld™ Blue Pool and Turf is a blue colored, medium bodied, high strength PVC cement for welding rigid or flexible PVC in wet conditions where the system needs to be pressurized quickly. Pro-Weld Blue Pool and Turf sets up very fast and works with all rigid and flexible schedule 40 and 80 pipe diameters up to 6 inches. Complies with ASTM D2564 and NSF.

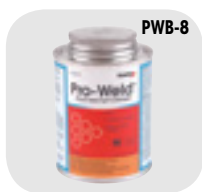

CATALOG NO.	DESCRIPTION	UOM	ORDER MULTIPLE
<b>PWB-4</b>	Pro-Weld™ – 4 oz. Brush-Top Container – Pool and Turf – Blue	EA	24
<b>PWB-8</b>	Pro-Weld™ – 8 oz. Brush-Top Container – Pool and Turf – Blue	EA	24
<b>PWB-16</b>	Pro-Weld™ – 16 oz. Brush-Top Container – Pool and Turf – Blue	EA	24

### Pro-Weld™ PVC Cement (Universal – PVC/ABS/CPVC)

Pro-Weld™ Universal Cement is a clear, medium bodied, high strength cement for use on PVC to PVC, CPVC to CPVC, and ABS to ABS connections. Pro-Weld Universal sets up fast and works with all rigid schedule 40 and 80 piping up to 6 inches in diameter. Complies with ASTM D2564, D2235, and F493.

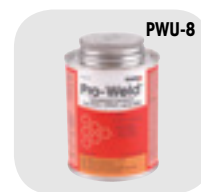

CATALOG NO.	DESCRIPTION	UOM	ORDER MULTIPLE
<b>PWU-4</b>	Pro-Weld™ – 4 oz. Brush-Top Container – Universal – PVC/ABS/CPVC	EA	24
<b>PWU-8</b>	Pro-Weld™ – 8 oz. Brush-Top Container – Universal – PVC/ABS/CPVC	EA	24
<b>PWU-16</b>	Pro-Weld™ – 16 oz. Brush-Top Container – Universal – PVC/ABS/CPVC	EA	24

### Pro-Prime™ PVC Primer (Purple)

A purple-tinted primer formulated to remove dirt and oil from the surface of Type I and II PVC piping, as well as soften the piping in preparation for solvent welding. Pro-Prime™ contains purple pigment which provides verification that the primer has been applied to the pipe surface. Pro-Prime™ meets ASTM Standard F-656.

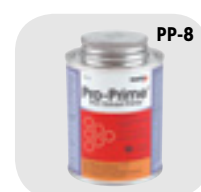

CATALOG NO.	DESCRIPTION	UOM	ORDER MULTIPLE
<b>PP-4</b>	Pro-Prime™ – 4 oz. Brush-Top Container	EA	24
<b>PP-8</b>	Pro-Prime™ – 8 oz. Brush-Top Container	EA	24
<b>PP-16</b>	Pro-Prime™ – 16 oz. Brush-Top Container	EA	24
<b>PP-32</b>	Pro-Prime™ – 32 oz. Can	EA	12

### Pro-Prime™ Clear PVC Primer

Clear primer that removes dirt and oil from the surface of Type I and II PVC piping. Softens the piping to prepare for solvent welding. Pro-Prime Clear primer meets ASTM Standard F-656.



CATALOG NO.	DESCRIPTION	UOM	ORDER MULTIPLE
<b>PPC-4</b>	Pro-Prime™ Clear – 4 oz. Brush-Top Container	EA	24
<b>PPC-8</b>	Pro-Prime™ Clear – 8 oz. Brush-Top Container	EA	24
<b>PPC-16</b>	Pro-Prime™ Clear – 16 oz. Brush-Top Container	EA	24
<b>PPC-32</b>	Pro-Prime™ Clear – 32 oz. Brush-Top Container	EA	24

### Pro-Weld™ Weather-ALL

Pro-Weld™ PVC Cement is a clear, regular bodied solvent cement designed to be used on Type I and II PVC pipe and fittings up to and including 4 inch diameter. Pro-Weld™ meets ASTM Standard D-2564 and is usable in cold weather to -15°F and hot weather to 110°F.

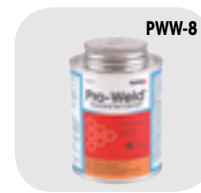

CATALOG NO.	DESCRIPTION	UOM	ORDER MULTIPLE
<b>PWW-4</b>	Pro-Weld™ – 4 oz. Brush-Top Container – All Weather Regular Body	EA	24
<b>PWW-8</b>	Pro-Weld™ – 8 oz. Brush-Top Container – All Weather Regular Body	EA	24
<b>PWW-16</b>	Pro-Weld™ – 16 oz. Brush-Top Container – All Weather Regular Body	EA	24

**PVC CONDENSATE PIPE**

**Polyvinyl Chloride, White PVC 1120**



CATALOG NO.	DESCRIPTION	UOM	ORDER MULTIPLE
5-2001	1/2" PVC – PSI 315 – 10' Straight End	EA	500'
5-2002	3/4" PVC – PSI 200 – 10' Straight End	EA	500'
5-2005	3/4" PVC – PSI 200 – 20' Belled End	EA	500'
5-401	3/4" PVC – Sch. 40 – 10' Straight End	EA	500'
5-407	3/4" PVC – Sch. 40 – 20' Belled End	EA	500'
5-404	2" PVC – Sch. 40/DWW, ASTM 2665 – 10' Straight End	EA	100'
5-405	3" PVC – Sch. 40/DWW, ASTM 2665 – 10' Straight End	EA	50'
5-416	1" PVC – Sch. 40 – 20' Belled End	EA	200'
5-417	1-1/4" PVC – Sch. 40 – 20' Belled End	EA	200'
5-418	1-1/2" PVC – Sch. 40 – 20' Belled End	EA	200'

**PVC DWV FITTINGS**

**Couplings (Hub x Hub)**



CATALOG NO.	DESCRIPTION	UOM	ORDER MULTIPLE
5-100020	2" Couplings (Hub x Hub)	EA	100
5-100030	3" Couplings (Hub x Hub)	EA	60
510-D102338	3" x 2" Couplings (Hub x Hub)	EA	20

**90 Elbow (Hub x Hub)**



CATALOG NO.	DESCRIPTION	UOM	ORDER MULTIPLE
5-300020	2" 90 Elbow (Hub x Hub)	EA	50
5-300030	3" 90 Elbow (Hub x Hub)	EA	25
510-D304020	2" Long Sweep 90 Elbow (Hub x Hub)	EA	25
510-D304030	3" Long Sweep 90 Elbow (Hub x Hub)	EA	10

**45 Elbows**



CATALOG NO.	DESCRIPTION	UOM	ORDER MULTIPLE
5-321020	2" 45 Elbow (Hub x Hub)	EA	50
5-321030	3" 45 Elbow (Hub x Hub)	EA	20
510-D323020	2" 45 Street Elbow (Hub x SPIG)	EA	50
510-D323030	3" 45 Street Elbow (Hub x SPIG)	EA	20

**DWV Bend Fittings**



CATALOG NO.	DESCRIPTION	UOM	ORDER MULTIPLE
510-D309020	2" Long Sweep (Hub x SPIG)	EA	25
510-D309030	3" Long Sweep (Hub x SPIG)	EA	20

**DWV Vent Tee**



CATALOG NO.	DESCRIPTION	UOM	ORDER MULTIPLE
510-D441020	2" Vent Tee	EA	25

**DWV Bushings**



CATALOG NO.	DESCRIPTION	UOM	ORDER MULTIPLE
510-437338	3" x 2" Reducing Bushing (SPIG x SLIP)	EA	10
510-438338	3" x 2" Bushing (SPIG x FIPT)	EA	10

**PVC SCHEDULE 40 PRESSURE FITTINGS**

**Tee (Slip x Slip x Slip)**



CATALOG NO.	DESCRIPTION	UOM	ORDER MULTIPLE
5-401005	1/2" Tee	EA	50
5-401007	3/4" Tee	EA	50
5-401010	1" Tee	EA	50
5-401020	2" Tee	EA	25
5-401030	3" Tee	EA	10

**Tee (Slip x FIPT x Slip)**



CATALOG NO.	DESCRIPTION	UOM	ORDER MULTIPLE
5-402007	3/4" Tee (S x S x FIPT)	EA	50

**90 Ell (Slip x Slip)**



CATALOG NO.	DESCRIPTION	UOM	ORDER MULTIPLE
5-406005	1/2" 90 Ell	EA	50
5-406007	3/4" 90 Ell	EA	50
5-406010	1" 90 Ell	EA	50
5-406020	2" 90 Ell	EA	25
5-406030	3" 90 Ell	EA	10

**Traps**

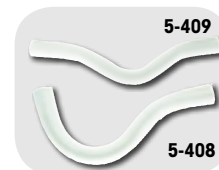

CATALOG NO.	DESCRIPTION	UOM	ORDER MULTIPLE
5-408	3/4" "P" Trap	EA	100
5-409	3/4" Running Trap	EA	100
5-410	3/4" Mini "P" Trap	EA	100
5-411	1" "P" Trap	EA	50
5-412	1/2" "P" Trap	EA	100
5-414	3/4" "J" Trap	EA	100

**90 Ell (Slip x FIPT)**



CATALOG NO.	DESCRIPTION	UOM	ORDER MULTIPLE
5-407005	1/2" 90 Ell	EA	50
5-407007	3/4" 90 Ell	EA	50

**90 Ell Reducing (Slip x FIPT)**



CATALOG NO.	DESCRIPTION	UOM	ORDER MULTIPLE
5-407131	1" x 3/4" 90 Ell Reducing	EA	50
5-407074	1/2" x 3/4" 90 Ell Reducer	EA	50

**90 Street Ell (SPIG x Slip)**



CATALOG NO.	DESCRIPTION	UOM	ORDER MULTIPLE
5-409005	1/2" 90 Street Ell	EA	50
5-409007	3/4" 90 Street Ell	EA	50
5-409010	1" 90 Street Ell	EA	50

**45 Ell (Slip x Slip)**



CATALOG NO.	DESCRIPTION	UOM	ORDER MULTIPLE
5-417005	1/2" 45 Ell	EA	50
5-417007	3/4" 45 Ell	EA	50
5-417010	1" 45 Ell	EA	50
5-417012	1-1/4" 45 Ell	EA	25
5-417020	2" 45 Ell	EA	25
5-417030	3" 45 Ell	EA	10

**PVC SCHEDULE 40 PRESSURE FITTINGS cont'd**

**Plug (Slip)**



CATALOG NO.	DESCRIPTION	UOM	ORDER MULTIPLE
5-449007	3/4" Plug	EA	50
5-449030	3" Plug	EA	10

**90 Street Ell (MIPT x Slip)**



CATALOG NO.	DESCRIPTION	UOM	ORDER MULTIPLE
5-410005	1/2" 90 Street Ell	EA	50
5-410007	3/4" 90 Street Ell	EA	50
5-410010	1" 90 Street Ell	EA	50

**Female Adapter (Slip x FIPT)**



CATALOG NO.	DESCRIPTION	UOM	ORDER MULTIPLE
5-435005	1/2" Female Adapter	EA	100
5-435007	3/4" Female Adapter	EA	50
5-435010	1" Female Adapter	EA	50

**Female Adapter Reducing (Slip x FIPT)**



CATALOG NO.	DESCRIPTION	UOM	ORDER MULTIPLE
5-435101	3/4" x 1/2" Female Adapter Reducing	EA	50
5-435102	3/4" x 1" Female Adapter Reducing	EA	50

**Coupling (Slip x Slip)**



CATALOG NO.	DESCRIPTION	UOM	ORDER MULTIPLE
5-429005	1/2" Coupling	EA	100
5-429007	3/4" Coupling	EA	50
5-429010	1" Coupling	EA	50
5-429015	1-1/2" Coupling	EA	25
5-429020	2" Coupling	EA	25
5-429030	3" Coupling	EA	10

**Cap (Slip)**



CATALOG NO.	DESCRIPTION	UOM	ORDER MULTIPLE
5-447007	3/4" Cap	EA	100
5-447010	1" Cap	EA	100

**Male Adapter (MIPT x Slip)**



CATALOG NO.	DESCRIPTION	UOM	ORDER MULTIPLE
5-436005	1/2" Male Adapter	EA	100
5-436007	3/4" Male Adapter	EA	50
5-436010	1" Male Adapter	EA	50

**Plug (MIPT)**



CATALOG NO.	DESCRIPTION	UOM	ORDER MULTIPLE
5-450007	3/4" Plug	EA	50

**Male Adapter Reducing (MIPT x Slip)**



CATALOG NO.	DESCRIPTION	UOM	ORDER MULTIPLE
<b>5-436074</b>	1/2" x 3/4" Male Adapter Reducing	EA	50
<b>5-436101</b>	3/4" x 1/2" Male Adapter Reducing	EA	50
<b>5-436102</b>	3/4" x 1" Male Adapter Reducing	EA	50
<b>5-436131</b>	1" x 3/4" Male Adapter Reducing	EA	50

**Reducer Bushing (SPIG x Slip)**



CATALOG NO.	DESCRIPTION	UOM	ORDER MULTIPLE
<b>5-437101</b>	3/4" x 1/2" Reducer Bushing	EA	100
<b>5-437130</b>	1" x 1/2" Reducer Bushing	EA	100
<b>5-437131</b>	1" x 3/4" Reducer Bushing	EA	100
<b>5-437210</b>	1-1/2" x 3/4" Reducer Bushing	EA	25

**Reducer Bushing (SPIG X FIPT)**



CATALOG NO.	DESCRIPTION	UOM	ORDER MULTIPLE
<b>5-438101</b>	3/4" x 1/2" Reducer Bushing	EA	100
<b>5-438131</b>	1" x 3/4" Reducer Bushing	EA	100

**Cap (FIPT)**



CATALOG NO.	DESCRIPTION	UOM	ORDER MULTIPLE
<b>5-448007</b>	3/4" Cap	EA	100

**Adapter (Insert x Slip)**



CATALOG NO.	DESCRIPTION	UOM	ORDER MULTIPLE
<b>5-474007</b>	3/4" Adapter (Insert x Slip)	EA	50

**Clean Out Tee**



CATALOG NO.	DESCRIPTION	UOM	ORDER MULTIPLE
<b>510-3400-10</b>	3/4" Clean Out Tee	EA	10
<b>510-3400</b>	3/4" Clean Out Tee	EA	50

**SUPPORTS**

**Plastic DWV J-Hooks**



CATALOG NO.	DESCRIPTION	UOM	ORDER MULTIPLE
<b>515-J2000</b>	2" x 9" DWV Swiveling J-Hook	EA	25
<b>515-J3000</b>	3" x 7-1/2" DWV Swiveling J-Hook	EA	25

**TUBING, CLAMPS, AND KITS**

**Polyethylene Tubing**

F.D.A. approved, flexible, non-toxic tubing. Tasteless and odorless, lightweight, low density. Ideal for drinking water lines, evaporative coolers, and radiant heating.



CATALOG NO.	DESCRIPTION	UOM	ORDER MULTIPLE
<b>PE-104</b>	Polyethylene Tubing - 1 1/64ID, 1/4OD, 100FT	EA	1
<b>PE-012</b>	Polyethylene Tubing - 3/8ID, 1/2OD, 100FT	EA	1
<b>PE-014</b>	Polyethylene Tubing - 1/8ID, 1/4OD, 100FT	EA	1
<b>PE-038</b>	Polyethylene Tubing - 1/4ID, 3/8 OD, 100FT	EA	1
<b>PE-058</b>	Polyethylene Tubing - 1/2ID, 5/8OD, 100FT	EA	1
<b>PE-012</b>	Polyethylene Tubing - 3/8ID, 1/2OD, 100FT	EA	1

**Icemaker Kit**

Supplies water to most refrigerators with automatic icemakers, humidifiers and evaporative coolers. Contains self-tapping valve and all necessary fittings.



CATALOG NO.	DESCRIPTION	UOM	ORDER MULTIPLE
<b>750-401</b>	Icemaker Kit - Poly Tube - 25'	EA	1
<b>750-402</b>	Icemaker Kit - Copper - 25'	EA	1

**Hose Clamps**

Partial stainless, worm drive, adjustable. 300 series stainless steel 1/2" band with plated 5/16" slotted hex head screw and housing, except the B-4H which has a 5/16" band and 1/4" nut. Recommended for most applications. 100% interlock construction features one-piece housing which directly locks into band. Spot weld free design.

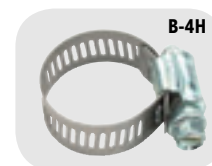

CATALOG NO.	DESCRIPTION	UOM	ORDER MULTIPLE
<b>B-4H</b>	No. 4, 7/32" - 5/8" dia., 3/16" - 5/16" hose I.D.	EA	10
<b>B-6H</b>	No. 6, 3/8" - 7/8" dia., 1/4" - 3/8" hose I.D.	EA	10
<b>B-8H</b>	No. 8, 7/16" - 1" dia., 5/16" - 1/2" hose I.D.	EA	10
<b>B-10H</b>	No. 10, 9/16" - 1-1/16" dia., 3/8" - 5/8" hose I.D.	EA	10
<b>B-12H</b>	No. 12, 9/16" - 1-1/4" dia., 5/8" - 3/4" hose I.D.	EA	10
<b>B-16H</b>	No. 16, 1 1/16" - 1-1/2" dia., 3/4" - 1" hose I.D.	EA	10
<b>B-20H</b>	No. 20, 3/4" - 1-3/4" dia., 1" - 1-1/4" hose I.D.	EA	10
<b>B-24H</b>	No. 24, 1-1/16" - 2" dia., 1-1/4" - 1-1/2" hose I.D.	EA	10
<b>B-28H</b>	No. 28, 1-5/16" - 2-1/4" dia., 1-1/4" - 1-3/4" hose I.D.	EA	10
<b>B-32H</b>	No. 32, 1-9/16" - 2-1/2" dia., 1-1/2" - 2" hose I.D.	EA	10
<b>B-36H</b>	No. 36, 1-13/16" - 2-3/4" dia., 1-3/4" - 2-1/4" hose I.D.	EA	10

**Self Tapping Water Valve**

Installs on all copper tube lines from 3/8" O.D. to 1-1/8" O.D. without shutting off water. No drilling required. Features 1/4" compression fitting. Stainless steel piercing needle. Special molded gasket seals on both tubing and valve. Will not slip or turn on tubing.



CATALOG NO.	DESCRIPTION	UOM	ORDER MULTIPLE
<b>QAV-2</b>	Self Tapping Water Tap Valve	EA	1

# DUCTLESS SYSTEMS

SpeediChannel™ Line Set Cover System ..... 211  
Fittings..... 211-214

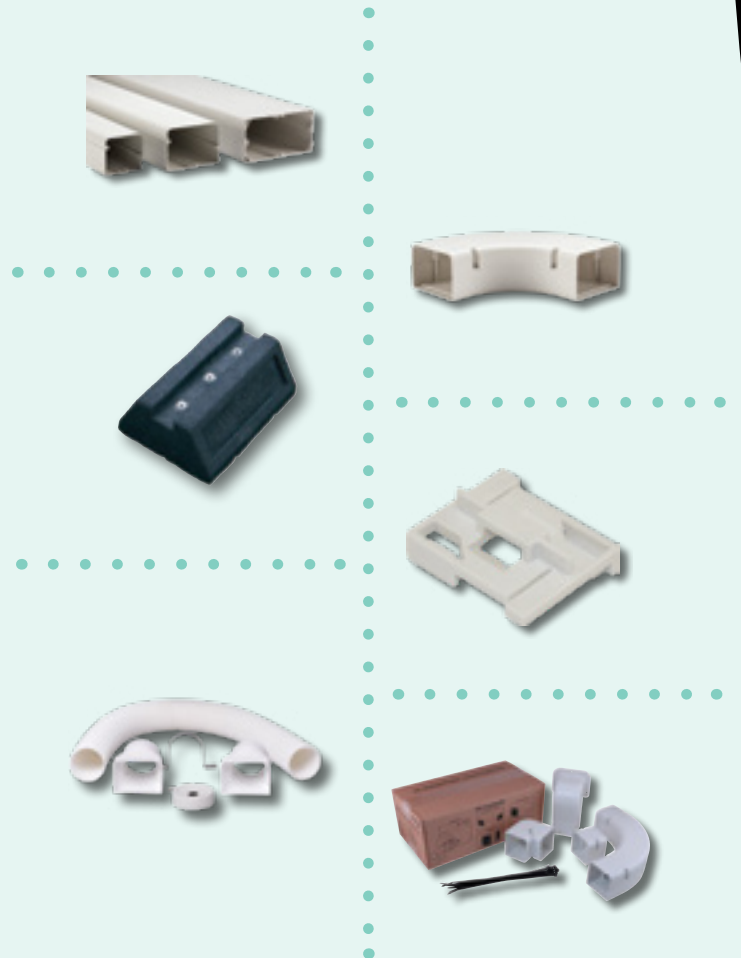

# SpeediChannel™ Line Set Cover System

DiversiTech SpeediChannel™ is an innovative channel system used to cover air conditioning line sets. The two part system has a base and a cover. The base is fastened to a wall or ceiling, then a clever little plastic clip (SpeediClip™) snaps into a channel already molded into the base. Then, using standard cable ties, the line set, cables, control wires, and/or condensate drain line are fastened in place. The cover then snaps simply on top of the base.

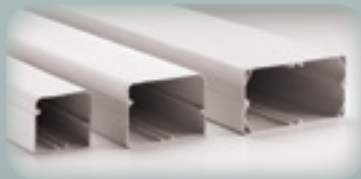

The SpeediChannel™ system is available in three widths – 3", 4", and 6". Each piece of Speedi-Channel™ is 6-1/2 feet long. A complete line of couplings, elbows, and tees are available for the SpeediChannel™ system.

Manufactured from rigid PVC, the SpeediChannel™ system comes in two popular colors. A Natural color that matches most mini-split condensing units or can be painted as desired to match any wall color. Use paint made for plastic only. A brown Terrastone color is also available which is popular with homeowners. The PVC used in the SpeediChannel system is resistant to UV light and is UL rated.



DiversiTech recommends attaching the base to the wall or ceiling and the line sets to the system every 15" to allow for the system to carry the full weight of the line sets.

*The SpeediChannel™ can also be used inside.*



**Now available in White, Brown & Natural**





*Cut your installation time!  
SpeediClip™— fastest  
SpeediChannel™  
installation.*

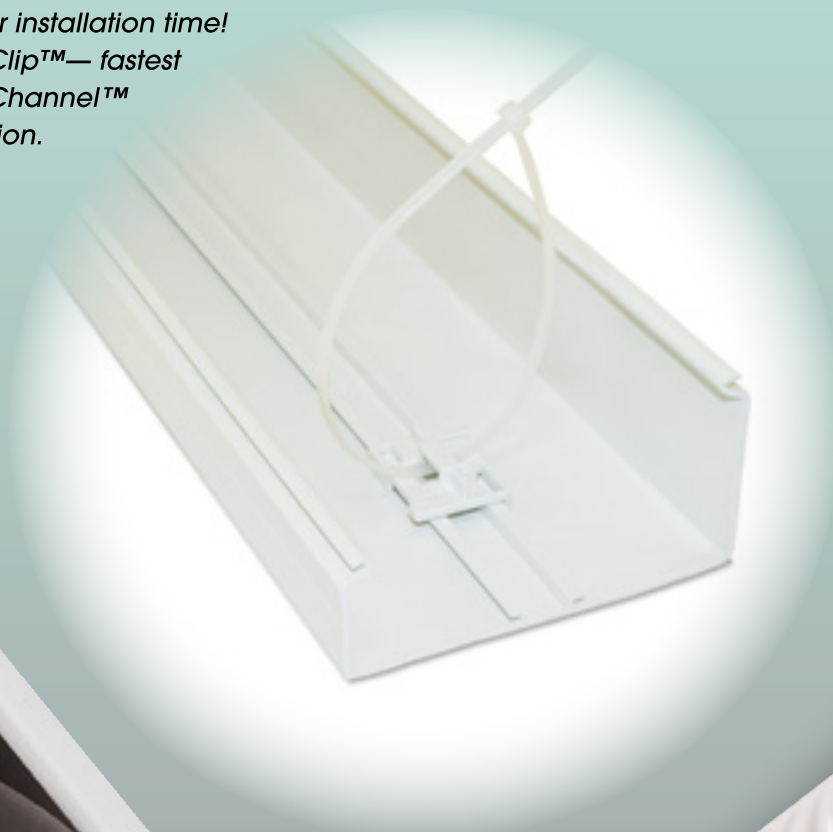

# DiversiTech SpeediChannel™ System

## SIZING CHART AND SELECTION INFORMATION

Maximum Line Set, Drain Pipe, and Cable Capacity using 3/8" Insulation

Model	230-D3	230-D4	230-D6
Dimensions	3" x 2-1/2"	4" x 2-3/4"	6" x 3"
Length	78"	78"	78"

Mini-Split Systems – Liquid and Suction Line with 3/8" Insulation

Liquid Line	3/8"	2 x 1/4"	1 x 1/4" + 2 x 3/8"
Suction Line	5/8"	2 x 3/8"	1 x 1/2" + 2 x 5/8"
Drain Hose	3/4" OD	2 x 3/4" OD	3 x 3/4" OD
Power Cable	1 x UF 14-3	2 x 1/2" SealTite	3 x 1/2" SealTite
Control Cable	1 Pair 18 AWG	2 Pairs 18 AWG	3 Pairs 18 AWG
Nominal Tonnage	1–3 Tons	1x3 Ton or 2x1 Ton	1x3 Ton or 2x2 Ton

Conventional Split Systems – Liquid Line Plain, Suction Line with 3/8" Insulation

Liquid Line	3/8"	3/8"	3/8"
Suction Line	3/4" or 7/8"	1-1/8"	1-1/8"
Drain Hose	3/4" PVC	3/4" PVC	3/4" PVC
Power Cable	1 x UF 14-2	1 x 1/2" SealTite	1 x 1/2" SealTite
Control Cable	1 Pair 18 AWG	1 Pair 18 AWG	1 Pair 18 AWG
Nominal Tonnage	Up to 3.5 Tons	4–5 Tons	7.5 Tons and up

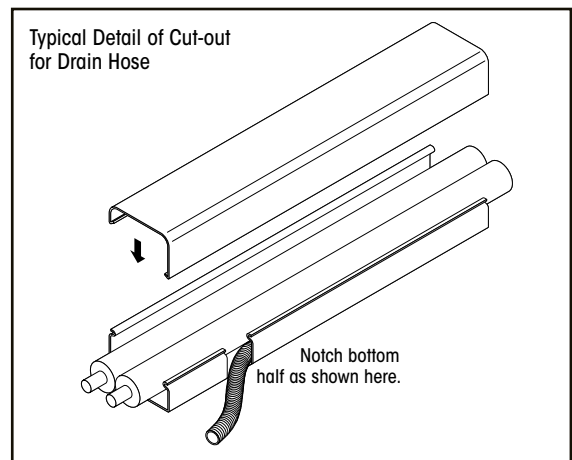
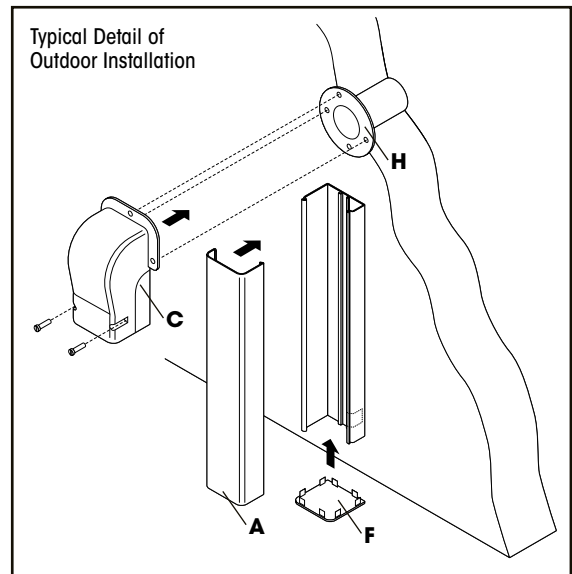
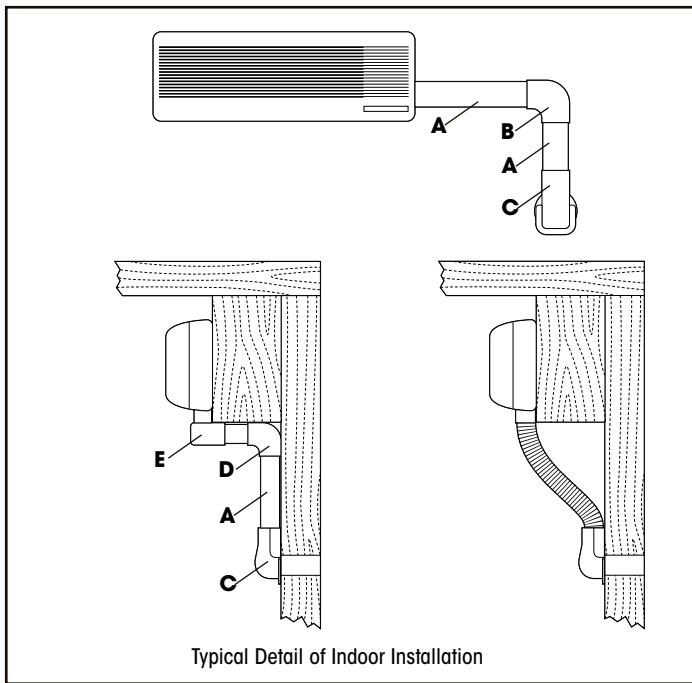

Typical Detail of Flex Joint Application

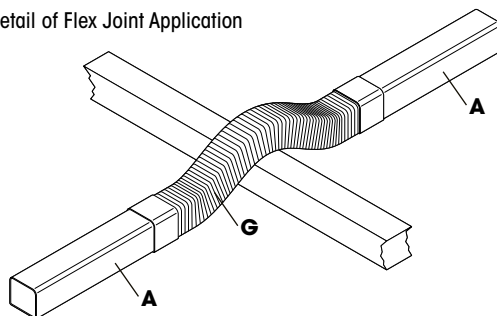

- A - 230-D
- B - 230-FB
- C - 230-WC
- D - 230-EB
- E - 230-EIN
- F - 230-DC
- G - 230-FJ
- H - 230-WS2

NOTE:  
Suffix parts A-G  
with the duct  
size needed  
(3,4, or 6)

# DiversiTech SpeediChannel™ System

## TECHNICAL SPECIFICATIONS

Color	Natural, Brown or White in select 3" & 4" sizes			
Size	230-D3: 3" x 2-1/2" OD	230-D4: 4" x 2-3/4" OD	230-D6: 6" x 3-1/8" OD	Standard Length: 78"
Material	Weather Resistant PVC, UV Stabilized and Fire Resistant			
Fire Rating	Meets UL 94V-0			
Temperature Range	-4°F TO 140°F			
Weather Resistance	Tested to over 2,000 hours			
Fixing Screws	Stainless Steel			

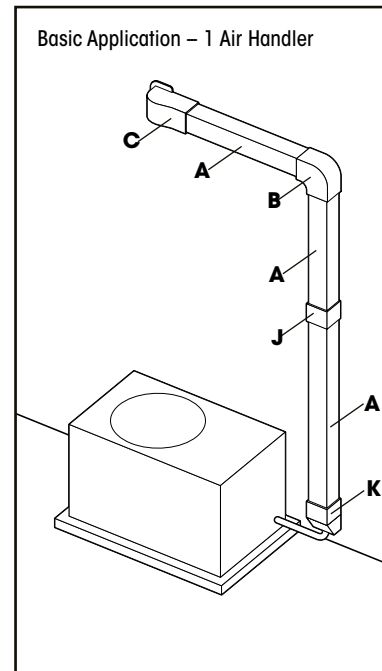
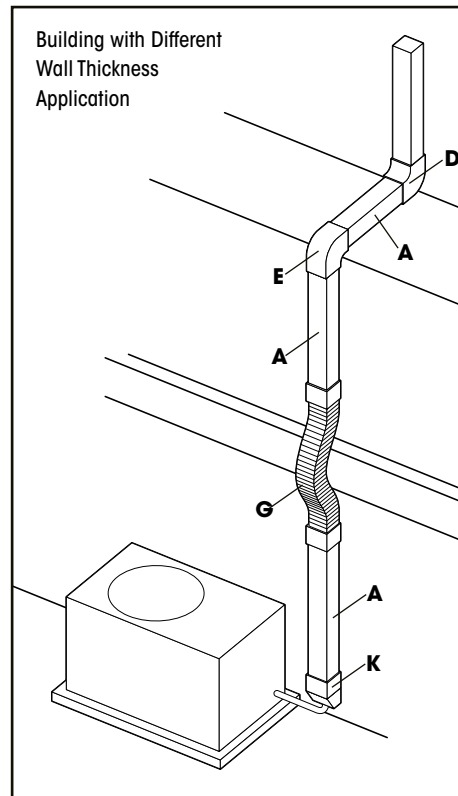
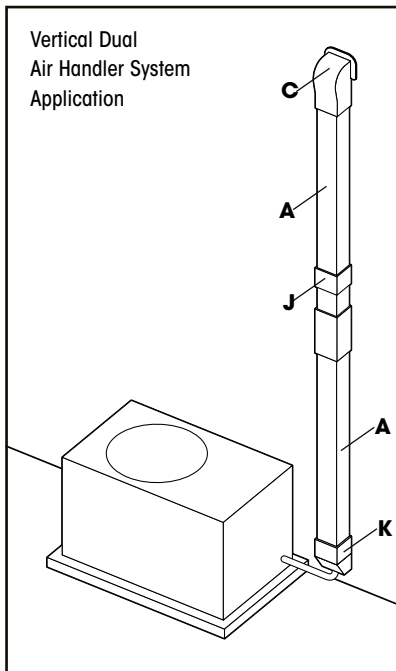
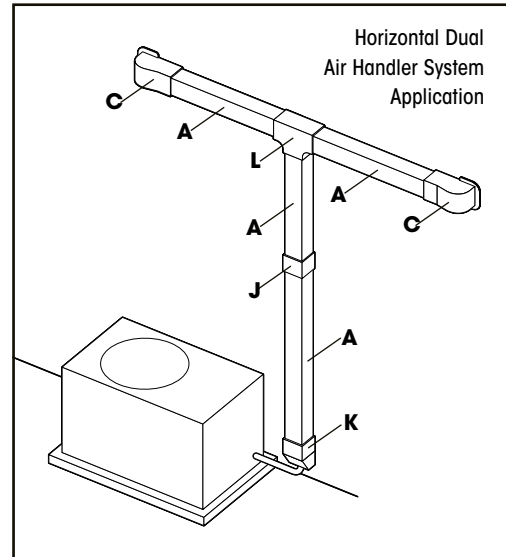
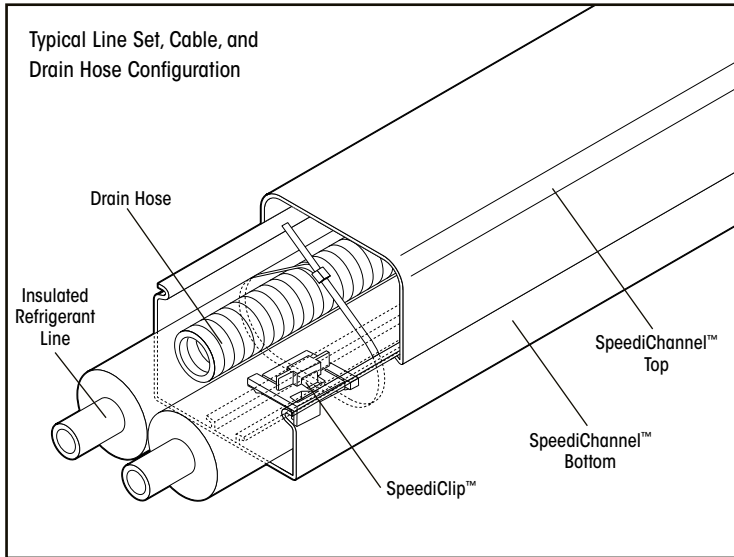

- A - 230-D
- B - 230-FB
- C - 230-WC
- D - 230-EB
- E - 230-EIN
- F - 230-DC
- G - 230-FJ
- H - 230-WS2
- J - 230-CP
- K - 230-DE
- L - 230-TC

NOTE:  
Suffix parts A-G  
with the duct  
size needed  
(3, 4, or 6)

# SpeediChannel™ System Installation

## Step 1

Attach the SpeediChannel™ base to the wall about every 15 inches with screws suitable for the wall construction (siding, stucco, brick, etc.). Screw through the center of the molded rail. Slide the connecting piece (elbow, union, tee, etc.) under the SpeediChannel™ before attaching the end of the channel to the wall. When cutting lengths of SpeediChannel™, allow 1/8" gap between the end of the SpeediChannel™ and the stop inside the fitting to allow for thermal expansion.



## Step 2

Attach one SpeediClip™ with cable tie about every 20 inches along the inside sliding rail.



## Step 3

Install the line set, drain line, and wires inside the SpeediChannel™. Test the equipment installation prior to tightening the cable ties. Tighten the cable ties snug, but not so tight they damage the tubing insulation or kink the drain line. Trim excess length from the cable tie.



## Step 4

Attach the SpeediChannel™ to the base.



## Step 5

Attach the fitting covers with the screws provided.



## Step 6

When complete, paint the SpeediChannel™ to match surface of installation (if desired).

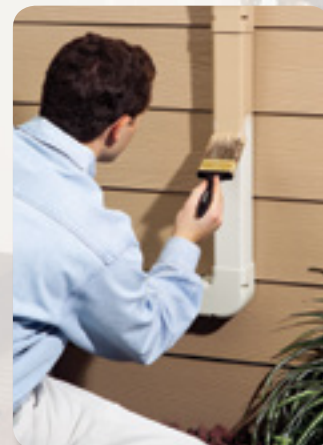

## SPEEDICHANNEL™ LINE SET COVER SYSTEM

### SpeediChannel™

The DiversiTech SpeediChannel™ is available in three widths, all in 6-1/2 feet lengths. Includes pack of SpeediClips™.



CATALOG NO.	DESCRIPTION	UOM	ORDER MULTIPLE
<b>230-D3</b>	3" SpeediChannel™	EA	6
<b>230-D3B</b>	3" SpeediChannel™, Brown	EA	6
<b>230-D3W</b>	3" SpeediChannel™, White	EA	6
<b>230-D4</b>	4" SpeediChannel™	EA	6
<b>230-D4B</b>	4" SpeediChannel™, Brown	EA	6
<b>230-D4W</b>	4" SpeediChannel™, White	EA	6
<b>230-D6</b>	6" SpeediChannel™	EA	5
<b>230-D6W</b>	6" SpeediChannel™, White	EA	5

Channel must ship LTL.

## FITTINGS

### Adjustable Flat Bend

Adjustable flat bends flex from 45 to 90 degrees and make it easy to route the SpeediChannel™ around an obstacle. Each adjustable bend is individually packed and includes stainless steel screws.



CATALOG NO.	DESCRIPTION	ORDER UOM	ORDER MULTIPLE
<b>230-AFB3</b>	3in. Adjustable Flat Bend	EA	10
<b>230-AFB3W</b>	3in. Adjustable Flat Bend, White	EA	10
<b>230-AFB4</b>	4in. Adjustable Flat Bend	EA	10
<b>230-AFB4W</b>	4in. Adjustable Flat Bend, White	EA	10

### Wall Penetration

Wall sleeves and penetration covers are used to transition from the SpeediChannel™ system to a through wall penetration. The wall sleeve creates a neat hole through the wall, and the line set is covered by the wall cover. DiversiTech's wall covers are designed to allow for easy installation - even after the line set has been installed. A unique hooking and fastening arrangement allows for quick and easy installation. Each wall cover is individually packed, and is furnished complete with stainless steel screws to attach the wall cover to the base. Three screws (supplied by others) are needed to fasten the wall cover to whatever type of wall construction the system is being installed on.



CATALOG NO.	DESCRIPTION	UOM	ORDER MULTIPLE
<b>230-WC3</b>	3" Wall Penetration Cover	EA	10
<b>230-WC3B</b>	3" Wall Penetration Cover, Brown	EA	10
<b>230-WC3W</b>	3" Wall Penetration Cover, White	EA	10
<b>230-WC4</b>	4" Wall Penetration Cover	EA	10
<b>230-WC4B</b>	4" Wall Penetration Cover, Brown	EA	10
<b>230-WC4W</b>	4" Wall Penetration Cover, White	EA	10
<b>230-WC6</b>	6" Wall Penetration Cover	EA	10
<b>230-WC6W</b>	6" Wall Penetration Cover, White	EA	10
<b>230-WS2</b>	2-1/2" Wall Sleeve	EA	10
<b>230-WS2W</b>	2-1/2" Wall Sleeve, White	EA	10

### Soffit Fittings

Ideal for outdoor applications where the SpeediChannel™ runs up an exterior wall and enters the house vertically through the soffit. Its large flat surface area easily covers the rough opening cut in the soffit. Furnished in two parts, the Soffit Fitting easily snaps onto the SpeediChannel™ for a clean installation.



CATALOG NO.	DESCRIPTION	ORDER UOM	ORDER MULTIPLE
<b>230-SF3</b>	3" Soffit Fitting	EA	10
<b>230-SF3W</b>	3" Soffit Fitting, White	EA	10
<b>230-SF4</b>	4" Soffit Fitting	EA	10
<b>230-SF4W</b>	4" Soffit Fitting, White	EA	10

### 90° Flat Bend

90° flat bends are used to route the SpeediChannel™ around an obstacle. Each bend is individually packed, and is furnished complete with stainless steel screws.



CATALOG NO.	DESCRIPTION	UOM	ORDER MULTIPLE
<b>230-FB3</b>	3" 90 degree Flat Bend	EA	10
<b>230-FB3B</b>	3" 90 degree Flat Bend, Brown	EA	10
<b>230-FB3W</b>	3" 90 degree Flat Bend, White	EA	10
<b>230-FB4</b>	4" 90 degree Flat Bend	EA	10
<b>230-FB4B</b>	4" 90 degree Flat Bend, Brown	EA	10
<b>230-FB4W</b>	4" 90 degree Flat Bend, White	EA	10
<b>230-FB6</b>	6" 90 degree Flat Bend	EA	10
<b>230-FB6W</b>	6" 90 degree Flat Bend, White	EA	10

**FITTINGS cont'd**

**90° Long Radius Bend**

90° long radius flat bends are used to route the SpeediChannel™ around an obstacle. The long radius of the elbow allows a gentle bending radius on the copper line set. Each elbow is individually packed, and is furnished complete with stainless steel screws.



**230-LFB4**

CATALOG NO.	DESCRIPTION	UOM	ORDER MULTIPLE
<b>230-LFB3</b>	3" 90 degree Long Radius Bend	EA	10
<b>230-LFB3B</b>	3" 90 degree Long Radius Bend, Brown	EA	10
<b>230-LFB3W</b>	3" 90 degree Long Radius Bend, White	EA	10
<b>230-LFB4</b>	4" 90 degree Long Radius Bend	EA	10
<b>230-LFB4B</b>	4" 90 degree Long Radius Bend, Brown	EA	10
<b>230-LFB4W</b>	4" 90 degree Long Radius Bend, White	EA	10
<b>230-LFB6</b>	6" 90 degree Long Radius Bend	EA	10
<b>230-LFB6W</b>	6" 90 degree Long Radius Bend, White	EA	10

**90° Inside Elbow**

90° inside elbows are used to route the SpeediChannel™ around an inside corner. Each elbow is individually packed, and is furnished complete with stainless steel screws.



**230-EB3**



CATALOG NO.	DESCRIPTION	UOM	ORDER MULTIPLE
<b>230-EB3</b>	3" 90 degree Inside Elbow	EA	10
<b>230-EB3B</b>	3" 90 degree Inside Elbow, Brown	EA	10
<b>230-EB3W</b>	3" 90 degree Inside Elbow, White	EA	10
<b>230-EB4</b>	4" 90 degree Inside Elbow	EA	10
<b>230-EB4B</b>	4" 90 degree Inside Elbow, Brown	EA	10
<b>230-EB4W</b>	4" 90 degree Inside Elbow, White	EA	10
<b>230-EB6</b>	6" 90 degree Inside Elbow	EA	10
<b>230-EB6W</b>	6" 90 degree Inside Elbow, White	EA	10

**Union Coupling**

Used for joining two pieces of SpeediChannel™ — each cover being the same size. Each coupling is individually packed, and is furnished complete with stainless steel screws.



**230-CP3**



CATALOG NO.	DESCRIPTION	UOM	ORDER MULTIPLE
<b>230-CP3</b>	3" Union Coupling	EA	10
<b>230-CP3B</b>	3" Union Coupling, Brown	EA	10
<b>230-CP3W</b>	3" Union Coupling, White	EA	10
<b>230-CP4</b>	4" Union Coupling	EA	10
<b>230-CP4B</b>	4" Union Coupling, Brown	EA	10
<b>230-CP4W</b>	4" Union Coupling, White	EA	10
<b>230-CP6</b>	6" Union Coupling	EA	10
<b>230-CP6W</b>	6" Union Coupling, White	EA	10

**45° Flat Bend**

45° flat bends are used to route the SpeediChannel™ around an obstacle. Each bend is individually packed, and is furnished complete with stainless steel screws.



**230-FB453**

CATALOG NO.	DESCRIPTION	UOM	ORDER MULTIPLE
<b>230-FB453</b>	3" 45 degree Flat Bend	EA	10
<b>230-FB453B</b>	3" 45 degree Flat Bend, Brown	EA	10
<b>230-FB453W</b>	3" 45 degree Flat Bend, White	EA	10
<b>230-FB454</b>	4" 45 degree Flat Bend	EA	10
<b>230-FB454B</b>	4" 45 degree Flat Bend, Brown	EA	10
<b>230-FB454W</b>	4" 45 degree Flat Bend, White	EA	10
<b>230-FB456</b>	6" 45 degree Flat Bend	EA	10
<b>230-FB456W</b>	6" 45 degree Flat Bend, White	EA	10

**90° Outside Elbow**

90° outside elbows are used to route the SpeediChannel™ around an outside corner. Each elbow is individually packed, and is furnished complete with stainless steel screws.



**230-EIN3**



CATALOG NO.	DESCRIPTION	UOM	ORDER MULTIPLE
<b>230-EIN3</b>	3" 90 degree Outside Elbow	EA	10
<b>230-EIN3B</b>	3" 90 degree Outside Elbow, Brown	EA	10
<b>230-EIN3W</b>	3" 90 degree Outside Elbow, White	EA	10
<b>230-EIN4</b>	4" 90 degree Outside Elbow	EA	10
<b>230-EIN4B</b>	4" 90 degree Outside Elbow, Brown	EA	10
<b>230-EIN4W</b>	4" 90 degree Outside Elbow, White	EA	10
<b>230-EIN6</b>	6" 90 degree Outside Elbow	EA	10
<b>230-EIN6W</b>	6" 90 degree Outside Elbow, White	EA	10

**T-Joint**

Used for creating a tee connection between three pieces of SpeediChannel™ — all covers being the same size. The tee can be combined with the reducing coupling to join SpeediChannel™s of different sizes. Each tee is individually packed, and is furnished complete with stainless steel screws.



**230-TJ4**



CATALOG NO.	DESCRIPTION	UOM	ORDER MULTIPLE
<b>230-TJ4</b>	4" T-Joint	EA	10
<b>230-TJ4B</b>	4" T-Joint, Brown	EA	10
<b>230-TJ4W</b>	4" T-Joint, White	EA	10
<b>230-TJ6</b>	6" T-Joint	EA	10
<b>230-TJ6W</b>	6" T-Joint, White	EA	10

**FITTINGS cont'd**

**Flex Joint**

An accordion style piece of SpeediChannel™, the flex joint can be extremely flexible routing a SpeediChannel™ system around virtually any type of obstacle. Each joint is 20" long and can be combined together for longer flex runs. Unlike competitor systems, the DiversiTech flex joint does NOT require the use of a union coupling. The DiversiTech flex joint slides tightly inside the SpeediChannel™ system.



**230-FJ3**

CATALOG NO.	DESCRIPTION	UOM	ORDER MULTIPLE
<b>230-FJ3</b>	3" Flex Joint	EA	10
<b>230-FJ3W</b>	3" Flex Joint, White	EA	10
<b>230-FJ4</b>	4" Flex Joint	EA	10
<b>230-FJ4W</b>	4" Flex Joint, White	EA	10

**Duct End**

The duct end is used to terminate a run of SpeediChannel™ to a small opening – just large enough for the line set and condensate drain line to pass through. Gives a neat/clean installation.



**230-DE3 230-DE4**

CATALOG NO.	DESCRIPTION	UOM	ORDER MULTIPLE
<b>230-DE3</b>	3" Duct End	EA	10
<b>230-DE3B</b>	3" Duct End, Brown	EA	10
<b>230-DE3W</b>	3" Duct End, White	EA	10
<b>230-DE4</b>	4" Duct End	EA	10
<b>230-DE4B</b>	4" Duct End, Brown	EA	10
<b>230-DE4W</b>	4" Duct End, White	EA	10
<b>230-DE6</b>	6" Duct End	EA	10
<b>230-DE6W</b>	6" Duct End, White	EA	10

**Flat Wall Escutcheon**

Typically used to cover a rough opening in a soffit, wall, or ceiling penetration. One side of the escutcheon is flat to allow for a SpeediChannel™ run going along a wall, and penetrating through an adjacent wall or ceiling. This is the most common type of wall penetration. Furnished in two parts, the escutcheon easily snaps onto the SpeediChannel™.



**230-FR3**

CATALOG NO.	DESCRIPTION	UOM	ORDER MULTIPLE
<b>230-FR3</b>	3" Flat Wall Escutcheon	EA	10
<b>230-FR3W</b>	3" Flat Wall Escutcheon, White	EA	10
<b>230-FR4</b>	4" Flat Wall Escutcheon	EA	10
<b>230-FR4W</b>	4" Flat Wall Escutcheon, White	EA	10
<b>230-FR6</b>	6" Flat Wall Escutcheon	EA	10
<b>230-FR6W</b>	6" Flat Wall Escutcheon, White	EA	10

**Reducer Coupling**

Used for joining two pieces of SpeediChannel™ — each cover being a different size. Each coupling is individually packed, and is furnished complete with stainless steel screws.



**230-TC34**

CATALOG NO.	DESCRIPTION	UOM	ORDER MULTIPLE
<b>230-TC34</b>	3" x 4" Reducer Coupling	EA	10
<b>230-TC34W</b>	3" x 4" Reducer Coupling, White	EA	10
<b>230-TC46</b>	4" x 6" Reducer Coupling	EA	10
<b>230-TC46W</b>	4" x 6" Reducer Coupling, White	EA	10

**Cap**

Used to cap the end of a SpeediChannel™ run. Easily snaps into the end of the SpeediChannel™.



**230-DC3**

CATALOG NO.	DESCRIPTION	UOM	ORDER MULTIPLE
<b>230-DC3</b>	3" Cap	EA	10
<b>230-DC3W</b>	3" Cap, White	EA	10
<b>230-DC4</b>	4" Cap	EA	10
<b>230-DC4W</b>	4" Cap, White	EA	10
<b>230-DC6</b>	6" Cap	EA	10
<b>230-DC6W</b>	6" Cap, White	EA	10

**Wall Escutcheon**

Typically used to cover a rough opening in a wall or ceiling penetration. The hole in the escutcheon is centered to allow for a free standing SpeediChannel™ to penetrate through a wall or ceiling. This is the fairly un-common type of wall or ceiling penetration. Check carefully, as you may need the Flat Wall Escutcheon. Furnished in two parts, the escutcheon easily snaps onto the SpeediChannel™.



**230-WR3**

CATALOG NO.	DESCRIPTION	UOM	ORDER MULTIPLE
<b>230-WR3</b>	3" Wall Escutcheon	EA	10
<b>230-WR3W</b>	3" Wall Escutcheon, White	EA	10
<b>230-WR4</b>	4" Wall Escutcheon	EA	10
<b>230-WR4W</b>	4" Wall Escutcheon, White	EA	10
<b>230-WR6</b>	6" Wall Escutcheon	EA	10
<b>230-WR6W</b>	6" Wall Escutcheon, White	EA	10

**FITTINGS** cont'd

**SpeediChannel™ Accessories**

A variety of accessories that are complementary or required for installing DiversiTech's SpeediChannel™ system.

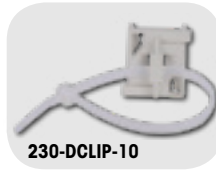

CATALOG NO.	DESCRIPTION	UOM	ORDER MULTIPLE
<b>230-DCLIP-10</b>	SpeediClip™ and 11" Cable Ties, pack of 10	PK	1
<b>230-DCLIP</b>	*SpeediClip™, pack of 50	PK	1
<b>230-DSCREW</b>	SpeediChannel™ screws, pack of 100	PK	1
<b>WTB11C</b>	Black Wire Ties – 11", pack of 100	PK	1

**Universal Pump Elbow**

The Universal Pump Elbow lets an installer use any mini pump of their choice and install it with SpeediChannel. Includes pump elbow and reservoir mounting brackets to fit most mini-split pumps.



CATALOG NO.	DESCRIPTION	UOM	ORDER MULTIPLE
<b>230-PFB3</b>	Universal Pump Elbow	EA	1

**SpeediChannel™ Flex Hose Kits**

A flexible hose kit of SpeediChannel that protects the line set from the condensing unit to the wall. Also provides a quick easy connection between two lengths of channel over or around obstacles. The kit comes with everything needed for a clean professional installation.



CATALOG NO.	DESCRIPTION	UOM	ORDER MULTIPLE
<b>230-FH3-KIT</b>	3" Flex Hose Kit	EA	1
<b>230-FH3W-KIT</b>	3" Flex Hose Kit, White	EA	1
<b>230-FH4-KIT</b>	4" Flex Hose Kit	EA	1
<b>230-FH4-KITW</b>	4" Flex Hose Kit, White	EA	1

**SpeediChannel™ Kits**

The SpeediChannel™ Fitting Kit provides a simple mix of the basic fittings used in a typical SpeediChannel™ installation job. Included are one coupling, one wall penetration, one inside elbow, one long radius flat bend, and one pack of ten SpeediClips and 11" cable ties. The 230-IKC3 and 230-IKC4 Installation Kits include three 48" pieces of channel and selected fittings.



CATALOG NO.	DESCRIPTION	UOM	ORDER MULTIPLE
<b>230-IK3</b>	3" SpeediChannel™ Fitting Kit	EA	1
<b>230-IK3W</b>	3" SpeediChannel™ Fitting Kit, White	EA	1
<b>230-IK4</b>	4" SpeediChannel™ Fitting Kit	EA	1
<b>230-IK4W</b>	4" SpeediChannel™ Fitting Kit, White	EA	1
<b>230-IKC3</b>	3" SpeediChannel™ Installation Kit	EA	1
<b>230-IKC3W</b>	3" SpeediChannel™ Installation Kit, White	EA	1
<b>230-IKC4</b>	4" SpeediChannel™ Installation Kit	EA	1
<b>230-IKC4W</b>	4" SpeediChannel™ Installation Kit, White	EA	1



# MAINTENANCE CHEMICALS

Accessories ..... 234-235  
 Additives ..... 243  
 Coil Cleaners ..... 233-234  
 Coil Cleaning Aerosols ..... 235  
 Flushing Products ..... 236  
 Glycols ..... 235-236  
 Hoses, Sprayers ..... 237  
 Ice Machine Products ..... 238  
 Leak Detectors and Accessories ..... 238-239  
 Leak Sealants ..... 239-240  
 Maintenance Chemical Quick Reference  
 Guide ..... 230-231  
 Odor Neutralizers ..... 240  
 Pan Treatments/Disinfectants ..... 241  
 Refrigeration Oils ..... 242  
 System Cleaners ..... 242  
 Test Kits ..... 242  
 Thread Sealants ..... 243  
 Vacuum Pump Oil ..... 243



# Triple-D® Universal Coil Cleaner

*Triple-D is a Universal Coil Cleaner suitable for use on condenser and evaporator coils. It is metal safe and does not attack aluminum or copper coil components, extending equipment life and diminishing potential for refrigerant leaks. Triple-D is a more versatile product than conventional acid or non-acid coil cleaners. One product does it all — truly a Universal Coil Cleaner.*

## FEATURES

## BENEFITS

**Universal Coil Cleaner** One product for multiple applications reduces inventory and eliminates potential product mis-application.

**Metal Compatible** Conventional foaming acid coil cleaners actually attack and chemically react with the aluminum coil components. This reaction is exhibited by a foaming action. Conventional foaming non-acid coil cleaners are so strong (because they lack the unique inhibitor in Triple-D) they also attack the aluminum coil components. The attack/reaction dissolves the aluminum, destroying the heat-transfer ability of the coil, and creates the potential for refrigerant leaks. Over time, the reduction in heat transfer ability for the coil increases energy consumption significantly.

**Super Concentrated** Lower cost per mixed gallon. Triple-D is a 6:1 dilution ratio, making 7 gallons of usable product per gallon of concentrate.

**Multiple Packages/Forms** Available as a concentrated liquid, pre-diluted liquid, aerosol, or Granular Coil Cleaner. Same product — different packages.

**NSF Registered** Assurance that Triple-D is an ideal cleaner for restaurants, hospitals, government institutions, and any food preparation area. Rinse thoroughly after use.

**Safe for Rubber Roofs** Does not damage engineered polymeric or rubber roofing.

**Corrosion Inhibited** Conventional foaming acid and non-acid coil cleaners actually attack and chemically react with the aluminum (and sometimes copper) coil components. This reaction is exhibited by a foaming action. The reaction dissolves the aluminum, destroying the heat-transfer ability of the coil, creating the potential for refrigerant leaks.

**Biodegradable** Triple-D is manufactured from chemicals that break down naturally in the environment. When a coil is cleaned, the rinse water is typically washed away.

**Non-Foaming** Foaming of coil cleaners is exhibited when the cleaner chemically reacts with the aluminum (and sometimes the copper) coil components. This reaction is exhibited by a foaming action. The reaction dissolves the aluminum, destroying the heat-transfer ability of the coil, and creates the potential for refrigerant leaks. Additionally, foaming action on foaming coil cleaners is an exothermic (heat generating) chemical reaction. This heat is extreme and can damage coils.

**Non-Toxic** Triple-D is manufactured from chemicals that break down naturally in the environment. When a coil is cleaned, the rinse water is typically washed away. Conventional acid coil cleaners contain dangerous hydrofluoric acid that is extremely toxic to humans and animals.

**Inhibited Non-Acid Formulation** Triple-D contains a unique inhibitor that allows for a very strong alkaline (non-acid) formulation that effectively cleans coils. Other non-acid coil cleaners are either too weak to effectively clean a coil, or are so strong (and hence foaming) that they attack the aluminum coil.

## Aluminum Loss of Foaming Coil Cleaners vs. Triple-D®

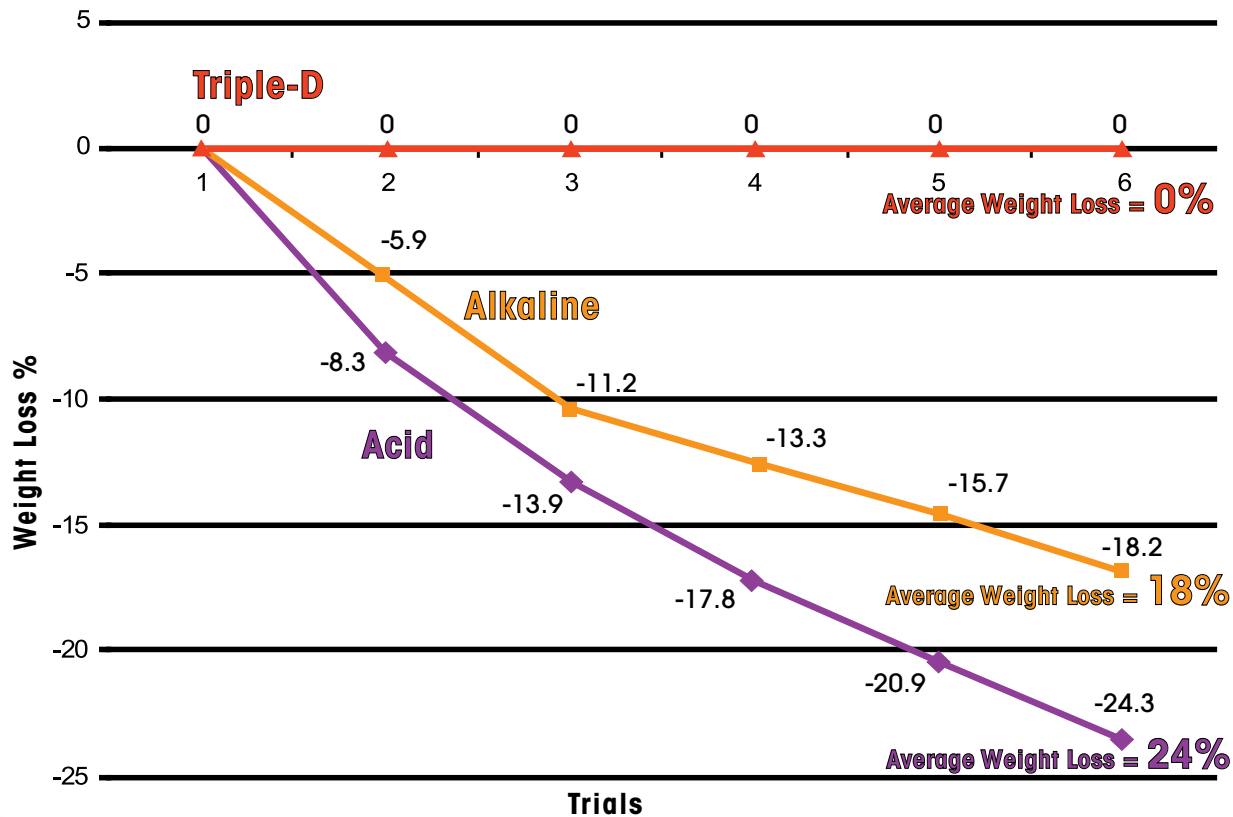

As shown above, conventional foaming acid coil cleaners and foaming non-acid coil cleaners actually attack and chemically react with the aluminum coil components. This reaction is exhibited by a foaming action. The attack/reaction dissolves the aluminum, destroying the heat-transfer ability of the coil creating the potential for refrigerant leaks.



# FLEX INJECT® SEALANT

**ADVANCED | TOTAL**

PERMANENTLY STOPS LEAKS

**FASTEST - EASIEST - PROVEN**

Flex Inject® Sealant Advanced, the fastest and easiest refrigerant leak sealant solution is now available in **TOTAL** which includes all the great characteristics of the original formula with UV dye.

**ADVANCED | TOTAL**



### 3X SEALING POWER

Patent pending Flex Inject® triple power sealant is the fastest, most effective proven way to permanently seal and prevent air conditioning and refrigeration (HVAC/R) leaks.



### NO TOOLS REQUIRED

Flex Inject® installs in seconds - no tools or manifold gauges required. The Flex Inject sealant goes to work immediately traveling through the system with both the oil and refrigerant stopping leaks dead in their tracks.



### COMPATIBLE WITH ALL OILS & REFRIGERANTS

Works with all compressors, heat pumps, condensers, recovery units, and other system components. Will not plug up manifold gauges, TXVs, pistons or cap tubes. Compatible with all oils and refrigerants including R-410A requiring no pump down or recovery.

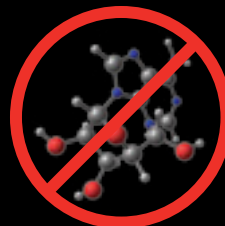

### POLYMER FREE

The polymer free formula has unique metal bonding properties that create a permanent protective barrier to keep the refrigerant from escaping and is microchannel friendly.

[www.diversitech.com/flexinject](http://www.diversitech.com/flexinject)  
800.995.2222



**TOTAL**

Part# 995  
Patent Pending



UV DYE INCLUDED

**TOTAL** comes with UV dye included giving contractors peace of mind that the leak is fixed.

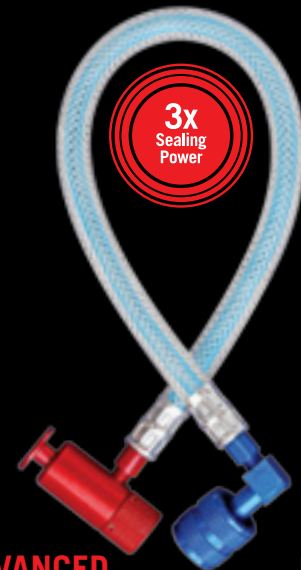

**ADVANCED**

Part# 985  
Patent Pending

**ALL SYSTEMS | UP TO 20KW**

**UP TO 6 TONS**



# FLEX INJECT® SEALANT



**No manifold gauges  
or hoses needed  
Just Connect HI & LOW -  
PUSH TO GO!**

## QUICK & EASY INSTALLATION: INSTALL INTO FULLY-CHARGED SYSTEM

1. Ensure system is running.
2. Connect the red push button valve to the high side service port.\*
3. Connect the blue low loss fitting to the low side service port.
4. Remove puck and press red button for 3 to 5 seconds to inject sealant.
5. Once sealant is dispensed, disconnect red push button valve from system.
6. Remove blue low loss fitting from system.

**NO SYSTEM RUN TIME REQUIRED AFTER INJECTION  
ALL PARTS ARE RECYCLABLE**

\*IF NO HIGHSIDE PORT IS AVAILABLE - ATTACH RED PUSH BUTTON VALVE TO A REFRIGERANT CYLINDER & FOLLOW STEPS 3-6.

## FLEX INJECT SEALANT TOTAL



## WHY FLEX INJECT® SEALANT AND TOTAL IS THE OBVIOUS CHOICE

Feature	DiversiTech Flex Inject® Sealant	Nu-Calgon EasySeal Direct Inject
Sealant Power	Triple	Single
Hose	Flexible	Rigid
Equipment Required	None	Manifold Gauge and Hoses
Sealant-Refrigerant Integration	No Runtime Required	60 Minutes with System Running
Valve Protection	Push Button Valve Allows for a Controlled Refrigerant Flow with Automatic Shut Off	One Way Check Valve
Compressor Protection	Misting Orifice Prevents Liquid Slugging	None

## REFRIGERANT LEAK SEALANT SOLUTION PART NUMBER CONVERSION TABLE

DiversiTech		Nu-Calgon	
PRODUCT	PART#	PRODUCT	PART#
Flex Inject® Sealant Advanced with Integrated Hose - Up to 6 tons	985	EasySeal-SS Direct Inject – Fractional to 1.5 tons	4050-05
		EasySeal Direct Inject – 6 pc. BULK – 1.5 to 5 tons	4050-07
		EasySeal Direct Inject – 1.5 to 5 tons	4050-08
Flex Inject® Sealant Total with Integrated Hose - Up to 6 tons	995	EasySeal Direct Inject – UV Dye – 1.5 to 5 tons	4050-11
		EasySeal Direct Inject – UV Dye – 6 pc. BULK – 1.5 to 5 tons	4050-12

# Pro-Flush® HVAC Flushing Solvent

***Pro-Flush® answers your need for a professional quality flushing solvent with the components to match.***

- Formulated for R-410A retrofits, refrigerant conversions and compressor burnouts
- Lower cost solution than competitive pre-charged kits
- Solvents are non-VOC, conform to EPA SNAP standards, and are non-HAZMAT
- Low toxicity and residue free
- Flash Point: No flash point to boiling (41°C/106°F) - TAG Closed Cup (per ASTM D-56)
- Kit includes reusable tank with a pressure relief valve for added safety, a hose, and an injector trigger nozzle
- Better delivery system

M  
A  
I  
N  
T  
E  
N  
A  
N  
C  
E  
  
C  
H  
E  
M  
I  
C  
A  
L  
S



## FREQUENTLY ASKED QUESTIONS

**Q: What refrigerants is Pro-Flush® compatible with?**

**A:** Pro-Flush® is compatible with CFC and HFC refrigerants and compressor oils.

**Q: Is Pro-Flush® safe to use?**

**A:** Pro-Flush® is safe, nontoxic, and residue free. In addition, Pro-Flush® conforms to EPA's Significant New Alternatives Program (SNAP) standards.

**Q: Is Pro-Flush® HAZMAT?**

**A:** Pro-Flush® is not HAZMAT for storage or ground transportation.

**Q: What is the advantage of the reusable injector tank?**

**A:**

1. The reusable tank lowers cost since you only need to buy the Pro-Flush® refill cans.
2. Pre-charged cans include refrigerant propellants which are more expensive to use than nitrogen.
3. The trigger assembly allows for infinite control of dosage insuring more economical use of the solvent.
4. Using nitrogen as the propellant is less expensive and more environmentally friendly than using HFC-134A. HFC-134A is a powerful greenhouse gas. One kilogram of HFC-134A has the same global warming impact as 1,430 kilograms of carbon dioxide (<http://www.epa.gov/cpd/mac/service>).

**Q: Can the injector tank be over pressurized during nitrogen pressurization?**

**A:** Over pressurization is highly unlikely but possible. The injector valve has a reseating pressure relief safety valve set at 200 psi. This helps prevent potential bursting and resultant injury.

**Q: What if I don't require the entire can of Pro-Flush® Solvent to clean a system or line set?**

**A:** The injection nozzle allows you to control the dose rate and any left over solvent can be stored in the injector for future use.

**Q: How does the dose rate for Pro-Flush® for burnouts and retrofits compare with the competitors?**

**A:** For R22 to 410A conversions, we recommend 3-second bursts of solvent. An 8 oz. can of Pro-Flush™ will treat up to 250 feet of liquid line. For burnouts, we recommend 2-3 oz. per ton. Pro-Flush™ uses less solvent per application than Nu-Calgon. Treatment results will vary depending on the application and conditions of the line set when serviced.

**Q: Why do you recommend only charging the injector tank to 50psi, then injecting in 3 second bursts?**

**A:** Tests are conclusive that injecting the solvent at lower pressure assures longer solvent to oil contact time. In addition, the smaller volume delivered in short bursts assists in completely dissolving contaminants. In this case, less is better.

**Q: Is nitrogen necessary for use with Pro-Flush®?**

**A:** Nitrogen is used as the propellant for Pro-Flush®. Nitrogen is required with all flushing systems to purge any residual solvent and contaminants through the system.

**Q: Do pre-charged canister systems dispense 100% of the flushing solvent?**

**A:** In many cases pre-charged canister systems will not fully dispense the flushing solvent depending on temperature. At lower temperatures, the R-134a propellant provides less pressure and may leave solvent in the canister. The Pro-Flush® system allows contractors to add additional nitrogen if there is still solvent left, regardless of temperature.



# FLASH™ DETECT INJECT

## FINDS LEAKS FAST

M  
A  
I  
N  
T  
E  
N  
A  
N  
C  
E  
  
C  
H  
E  
M  
I  
C  
A  
L  
S



Flash™ Detect Inject is an integrated UV dye solution that injects just like Flex Inject® Sealant Advanced and Total without the use of tools or manifold gauges. As soon as it enters the system, the green dye quickly exposes leaks with the use of a UV light (the Cliplight by DiversiTech 89DC is recommended). Flash™ Detect Inject is ideal in locations where leaks are not easily spotted with conventional methods. The highly soluble fluid exposes all leaks, making them easy to find. You can then use either DiversiTech's Super Seal Sealant Advanced (can version) or Flex Inject® Sealant Advanced (flexible hose version) to fix the leak.

### Flash™ Detect Inject finds leaks fast with:

- Instant distribution
- Green dye that escapes when leaks are present
- All oils and refrigerants

Watch video at  
[www.diversitech.com/flashdetect](http://www.diversitech.com/flashdetect)



**89DC**

Order 89DC UV light when ordering Flash™ Detect and Flash™ Detect Inject



**990**  
6 pack merchandiser



**999KIT**  
4 each of 985, 990, 995



# SUPER CHANGE™ SOLUTIONS

**FAST & EASY R22 RETROFIT IN CANS OR FLEXIBLE INSTALLATION HOSES**

Super Change™ in a can and Super Change™ Inject allows professional HVAC/R contractors a fast and easy way to convert a system from non-POE based oils and refrigerants such as R22 to newer HFC refrigerants including POE-based R407C and R410A without the need to flush the system (excluding compressor burnouts). By adding Super Change with the new refrigerant and oil, a chemical link is created between the old and new oil, thus avoiding a full flush and saving contractors significant time on a system changeout.



**Part# 991**  
Super Change™ Inject

**Super Change™ benefits include:**

- No changeout of the oil, O-rings or gaskets required
- Replaces lineset flushes
- Boosts oil return efficiency and extends compressor life
- Reduces oil logging which is critical in systems with long lineset runs and rises
- No tools or manifold gauges required
- Compatible with all oils and refrigerants
- Available in two injection methods

Watch video at [www.diversitech.com/superchange](http://www.diversitech.com/superchange)

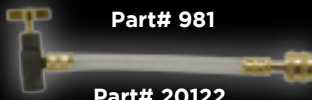

**Part# 981**  
**Part# 20122**  
Reusable hose sold separately as individuals



**981**  
6 pack merchandiser



**991**  
4 pack merchandiser

## APPLICATION GUIDE

SYSTEM TONNAGE	Up to 3 Tons	3.5 - 6 Tons	6+ Tons
SYSTEM OIL CHARGE	Up to 32 oz	Up to 64 oz	128+ oz
Conversion not requiring oil change out	1 can	1 can	2 cans/gallon
Conversion requiring oil change out	1 can	2 cans	4 cans/gallon
Conversion to R410A	1 can	1 can	2 cans/gallon
R22 line set conversion flush	1 can	1 can	2 cans/gallon
For oil logging or long line set runs and rises	1 can	1 can	2 cans/gallon

It will take approximately 24 hours of operation for the full effect to be achieved.

# Condensate Pan Treatments – SIMPLIFIED

## THE NEED

Environmental debris, slime, rust, etc. accumulate in condensate drain pans resulting in:

- Indoor Air Quality problems including musty odors and Dirty Sock Syndrome
- Pan overflows caused by plugged drain lines
- Equipment malfunction

## THE SOLUTION

Use pan treatment products as part of a regular preventive maintenance program to:

- Eliminate one of the causes of Sick Building Syndrome
- Stop costly overflow problems that damage floors, ceilings, and furniture
- Reduce unscheduled service calls

## THE PRODUCTS

### EXTENDED RELEASE TREATMENTS

- Several manufacturers produce various time release products
- Highest value — most active ingredient per dollar
- Easiest maintenance program — dose only once every three months or longer
- Only effective solution for equipment larger than six tons

### RAPID RELEASE TREATMENTS

- Lowest cost per tablet
- Shortest time between dosing



## Flow Plus® Condensate Pan Treatment

- A true water activated, time release treatment
- Water soluble polymer leaves no residue or carrier to be removed
- Adheres to drain pans — eliminates product floating and blocking the drain line
- No corrosive vapors — safe for computer rooms
- Recommended dosage — choose size according to equipment tonnage. Each size is designed to last a minimum of three months.

FLOW-PLUS-25	— 1/2 to 3 tons
FLOW-PLUS-200	— 1/2 to 3 tons
FLOW-PLUS-6	— 3 to 5 tons
FLOW-PLUS-10	— 5 to 20 tons
FLOW-PLUS-125	— 20 to 50 tons

**STACKABLE!**  
This unique feature increases the time between maintenance visits.

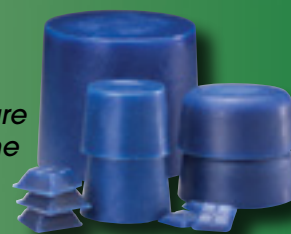

## Pro-Treat®-151 Premium Condensate Drain Pan Treatment

- EPA Registered
- Kills algae and eliminates odors
- Fast acting
- Residual effect of the clean pan lasts for a month
- No corrosive vapors — safe for computer rooms
- Recommended dosage: 1 tablet for every 3 tons each month

## Pro-Treat® 161 Condensate Drain Pan Treatment

- More active ingredient than the economy version
- Fast acting
- Residual effect of the clean pan lasts for about a month
- No corrosive vapors — safe for computer rooms
- Recommended dosage: 2 tablets for every 3 tons each month

## Pro-Treat® 200 Condensate Drain Pan Treatment

- Lowest cost product per tablet
- Sufficient active ingredient to treat the pan
- No corrosive vapors — safe for computer rooms
- Recommended dosage: 3 tablets for every 3 tons each month

# 3-STEP PROCESS for Solving IAQ Problems

M  
A  
I  
N  
T  
E  
N  
A  
N  
C  
E  
  
C  
H  
E  
M  
I  
C  
A  
L  
S

1



## STEP 2: DISINFECT

### SANI C-N-D™ Coil and Drain Pan Disinfectant

Disinfect and deodorize the evaporator coil and drain pan with SANI C-N-D™, an EPA registered biocide, fungicide, viricide, and mildewstat. The broad spectrum biocide in SANI C-N-D™ assures control of many airborne pathogens that can be spread via contaminated air handling equipment.

2

## STEP 1: CLEAN

### TRIPLE-D® Degreaser • Detergent • Deodorant

Clean the evaporator coil and condensate pan with TRIPLE-D®, a USDA authorized non-foaming alkaline coil cleaner. Cleaning the dirt from the coil and pan not only improves equipment efficiency, but also removes an important source of contamination that can create slime and sludge in the drain pan and cause pan overflow.



*The American Lung Association states that most people spend 90% of their time indoors<sup>1</sup>. DiversiTech offers the 3-STEP PROCESS to help control IAQ problems caused by the micro-organisms in the atmosphere in which we live and work.*

<sup>1</sup>[www.lungusa.org](http://www.lungusa.org)

## STEP 3: MAINTAIN

### FLOW PLUS® Condensate Pan Treatment

Place FLOW PLUS® in the condensate pan (choose size according to equipment tonnage below). FLOW PLUS® is a totally soluble long-term polymer treatment that keeps the drain pan and condensate lines clean for a minimum of three months. This prevents pan overflow problems.

PRODUCT NO.	EQUIPMENT TONNAGE
FLOW-PLUS-25	1/2 to 3 tons
FLOW-PLUS-200	1/2 to 3 tons
FLOW-PLUS-6	3 to 5 tons
FLOW-PLUS-10	5 to 20 tons
FLOW-PLUS-125	20 to 50 tons

3



### Why clean coils?

#### CONDENSER COIL

Cleaning the condenser coil does one thing — improves the heat transfer efficiency between the refrigerant inside the coil and the ambient air outside. The more efficient this heat transfer, the more efficiently the cooling system operates.

With efficient heat transfer and an efficiently operating condensing unit, the system consumes less energy because it draws less current. By lowering current consumed in the unit, the life of the equipment is extended.

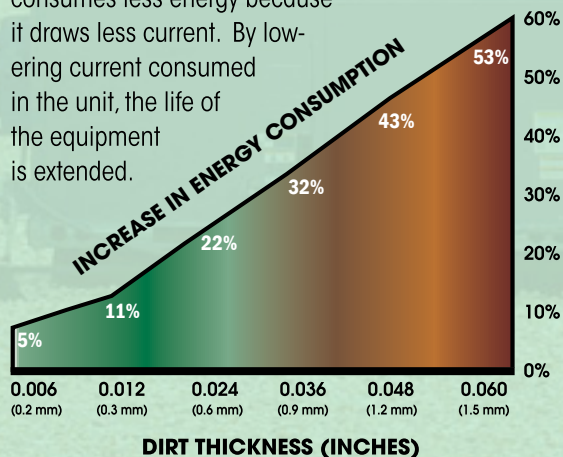

#### EVAPORATOR COIL

Cleaning the evaporator coil improves indoor air quality. It addresses building related illness and sick building syndrome.

### How frequently should coils be cleaned?

We recommend a minimum of twice per year, more frequently if there is dirty ambient air.



# Maintenance Chemical Solution Quick Reference Guide

EQUIPMENT TYPE	PRODUCT TYPE			
	TRIPLE-D®	ECO-COIL™	PRO-BROWN™	PRO-BLUE™
Condenser Units	X	X	X	X
(No-Rinse)		X		
Evaporator Units	X	X		
(No-Rinse)	X	X		
Rubber Roof Tops	X			
Fan Blades, Grilles, Etc.	X	X		
Electronic Air Filters	X	X		
Permanent Filters	X	X		
Microchannel Coils	X	X		
Small Condenser Coils	X	X	X	X
Small Evaporator Coils	X	X		
Mini-Splits	X	X		
<b>APPLICATION SOLUTION</b>				
Brightener			X	X
Condensate "Gunk"	X	X	X	X
Degreasing	X	X	X	X
Deodorizer	X	X		
Dirt and Grime	X	X	X	X
Disinfectant	USE SANI C-N-D COIL AND DRAIN DISINFECTANT			
Heresite Coated Coils		X		
Oxide Deposits			X	X
Remove Minerals				
<b>CHEMICAL TYPE</b>				
Alkaline	X	X	X	X
Acidic				
<b>DILUTION (PRODUCT: H2O)</b>				
Condensers	1:6	1:3	1:3	1:3
Evaporators	1:10	1:6		
Evaporators (No-Rinse)	1:20	1:6		
<b>PACKAGING AVAILABLE</b>				
19 Ounce Aerosol	TRIPLE-D-AER	ECO-COIL-AER	PRO-BROWN-AER	PRO-BLUE-AER
1 Quart Trigger Sprayer	TRIPLE-D-RTU			
32 Oz. Bottle	TRIPLE-D-32	ECO-COIL-32	PRO-BROWN-32	PRO-BLUE-32
1 Gallon	TRIPLE-D	ECO-COIL	PRO-BROWN	PRO-BLUE
5 Gallon	TRIPLE-D-5	ECO-COIL-5	PRO-BROWN-5	PRO-BLUE-5
55 Gallon Drum	TRIPLE-D-55	ECO-COIL-55	PRO-BROWN-55	PRO-BLUE-55
1 LB Granular	TRIPLE-D-GRAN			
<b>ENVIRONMENTAL</b>				
Biodegradable	X	X	X	X
Meets EPA's Design for the Environment Alternative Program as Green		X		
<b>FOOD COMPLIANCE</b>				
USDA Approved	X	X		X
NSF Registered	X	X		X

EQUIPMENT TYPE	PRODUCT TYPE			
	PRO-GREEN™	PRO-RED PLUS™	PRO-YELLOW™	PRO-KLEEN™
Condenser Units	X	X	X	X
(No-Rinse)	X			
Evaporator Units	X			
(No-Rinse)	X			
Rubber Roof Tops				
Fan Blades, Grilles, Etc.	X			
Electronic Air Filters	X			
Permanent Filters	X			
Microchannel Coils	X			
Small Condenser Coils	X	X	X	X
Small Evaporator Coils	X			
Mini-Splits	X			
<b>APPLICATION SOLUTION</b>				
Brightener		X	X	X
Condensate "Gunk"	X	X	X	X
Degreasing		X	X	X
Deodorizer				
Dirt and Grime	X	X	X	X
Disinfectant	USE SANI C-N-D™ COIL AND DRAIN DISINFECTANT			
Heresite Coated Coils				
Oxide Deposits		X	X	X
Remove Minerals				X
<b>CHEMICAL TYPE</b>				
Alkaline	X	X	X	
Acidic				X
<b>DILUTION (PRODUCT: H2O)</b>				
Condensers	1:3	1:3	1:2	1:3
Evaporators	1:3			
Evaporators (No-Rinse)	1:3			
<b>PACKAGING AVAILABLE</b>				
19 Ounce Aerosol	PRO-GREEN-AER	PRO-RED+AER	PRO-YELLOW-AER	
1 Quart Trigger Sprayer				
32 Oz. Bottle	PRO-GREEN-32	PRO-RED+32	PRO-YELLOW-32	
1 Gallon	PRO-GREEN	PRO-RED+	PRO-YELLOW	PRO-KLEEN
5 Gallon	PRO-GREEN-5	PRO-RED+5	PRO-YELLOW-5	PRO-KLEEN-5
55 Gallon Drum	PRO-GREEN-55	PRO-RED+55	PRO-YELLOW-55	PRO-KLEEN-55
1 LB Granular				
<b>ENVIRONMENTAL</b>				
Biodegradable	X	X	X	X
Meets EPA's Design for the Environment Alternative Program as Green				
<b>FOOD COMPLIANCE</b>				
USDA Approved	X			
NSF Registered	X			



## Maximize System Performance

for outside and inside coils using two-step microchannel and mini-split cleaning solution



### STEP 1: Clean OUTSIDE coils with Triple-D®

- Triple-D®:**
- Does not degrade aluminum microchannel, spindle or mini-split coils
  - Does not foam
  - Degreases and deodorizes while detergent cleans
  - Is not caustic



Shown above: An example of coil cleaning a microchannel with Triple-D®

Shown below: Table 1 - Weight loss trials

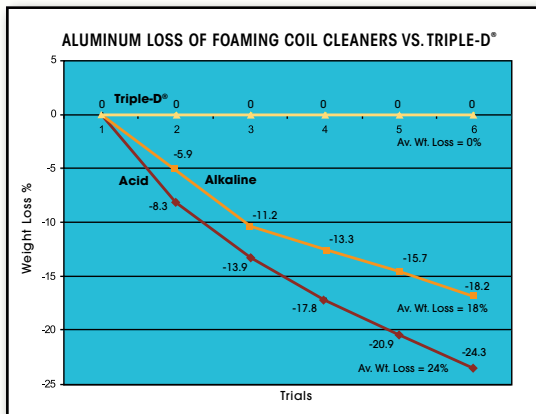

TRIPLE-D®

**Aluminum Microchannel & Mini-Split Friendly**

Studies show that **Triple-D®** does not degrade any type of coils. Weight loss in six trials (Table 1) using:

- Alkaline cleaners is 18%
- Acidic cleaners is 24%
- Triple-D® is 0%**

### STEP 2: Clean and lubricate INSIDE coils with Boost Juice®



Part #: 992  
Boost Juice® Inject

- Boost Juice®:**
- Boosts efficiency
  - Dissolves blockages
  - Eliminates up to 20 drops of water
  - Frees up TXVs



Part #: 993KIT  
Boost Juice®

#### HVAC CUSTOMER TESTIMONIAL

"Last month I installed Boost Juice in my heat pump at home and the results have been spectacular. Within the first week, I recorded an average 1.5 amp decrease in compressor amps and an average 2.5 increase in air temperature drop across my evaporator coil. On my Megger, before installing Boost Juice, I read 20 megaohms and after adding it, my resistance increased to above 100 megaohms and then 700 megaohms a month later. I recently received my electric bill and it is significantly lower compared to the same time last year."

Kenneth Long, 40 year HVAC/R Professional, Claysburg, PA



# MAXIMIZE SYSTEM PERFORMANCE WITH:

## Triple-D® is The Gold Standard

for treating condensers, evaporators, mini-splits, and aluminum microchannels

### POPULAR TRIPLE-D® COIL CLEANING MAINTENANCE SOLUTION GUIDE

PRODUCT	PART NUMBER	PRODUCT TYPE	SYSTEMS
<b>Triple-D® (Gallon)</b>	TRIPLE-D	Concentrated Coil Cleaner	HVAC/R Universal
<b>Triple-D® (Aerosol)</b>	TRIPLE-D-AER	Ready-to-use coil cleaner in aerosol can	HVAC/R Universal
<b>Triple-D® (32 oz. Container)</b>	TRIPLE-D-RTU	Ready-to-use coil cleaner - pre-diluted	HVAC/R Universal



Part #: TRIPLE-D



TRIPLE-D



TRIPLE-D-AER



TRIPLE-D-RTU

## PREFERRED SOLUTION FOR CLEANING MICROCHANNELS AND MINI-SPLITS

## Boost Juice® Performance Additive

### BOOST JUICE® SOLUTION GUIDE

PRODUCT	PART NUMBER	PRODUCT TYPE	SYSTEMS
<b>Boost Juice®</b>	993KIT	System Performance Additive (Hose Included)	Up to 6 Tons
<b>Boost Juice® Inject</b>	992	System Performance Additive in Hose	Up to 6 Tons



Part #: 993KIT



Part #: 992



993KIT



992  
(Orange)



PN# 992, 993KIT

# BOOST JUICE® SOLUTIONS

**HVAC/R PERFORMANCE ENHANCER ADDITIVE IN CANS OR FLEXIBLE INSTALLATION HOSES**



**Part# 992**  
**Boost Juice® Inject**

Boost Juice® is an HVAC/R system performance improvement additive that lowers energy costs by reducing the amperage draw up to 22% (testing average of 13%) on a system when running. It does this by lubricating the components, removing moisture and oxygen, and dissolving particle debris to a molecular level. This debris is captured in the liquid line drier reducing drag and friction for the refrigerant and oil.

By using Boost Juice®, customers can expect to see noticeable improvements in system performance typically within 24 to 72 hours (depending on the state of the system - new versus old) with consistent future performance. Noise levels will also be reduced once Boost Juice® is installed providing a long-term benefit to customers.

**Additional features and benefits for owners:**

- Enhances system performance, saving money on electric bills
- Reduces compressor noise
- Reduces energy consumption lowering starting and running amps
- Rejuvenates older systems
- Cleans interior linesets and system components removing loose deposits
- Improves oil lubricity through reduced friction and drag while blending with system oil and refrigerant
- Eliminates up to 20 drops of internal moisture prolonging system life
- Prevents acid formation



**Part# 993KIT**  
The Boost Juice® Kit comes with one 2 ounce can and non-reusable hose



**993KIT**  
Available in 6 unit cases



**992**  
Available in 4 unit cases

**COIL CLEANERS**

**Triple-D® Universal Coil Cleaner**

Triple-D® is the ultimate universal coil cleaner that can be used on condensers, evaporators, microchannels, roof-top units, and mini-split applications. The triple active synergistic highly effective solution is formulated to remove a broad range of soils while degreasing and deodorizing. It is ideal for cleaning most metals including aluminum and copper while extending equipment life and diminishing the potential for refrigerant leaks. Using 75% less than comparable products, it reduces the amount of solution needed to clean. Triple-D® is biodegradable, NSF approved and available in seven different packaging configurations.

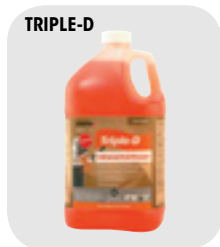

CATALOG NO.	DESCRIPTION	UOM	ORDER MULTIPLE
<b>TRIPLE-D</b>	Triple-D® – 1 gallon concentrate	EA	4
<b>TRIPLE-D-5</b>	Triple-D® – 5 gallon concentrate	EA	1
<b>TRIPLE-D-AER</b>	Triple-D® – 19 oz. Aerosol	EA	12
<b>TRIPLE-D-AER-6</b>	Triple-D® – 19 oz. Aerosol	EA	6
<b>TRIPLE-D-GRAN</b>	Triple-D® – 1 lb. Granular	EA	12
<b>TRIPLE-D-32</b>	Triple-D® – 32 oz. bottle – concentrate	EA	12
<b>TRIPLE-D-RTU</b>	Triple-D® – 1 quart trigger sprayer – pre-diluted	EA	12
<b>TRIPLE-D-55</b>	Triple-D® – 55 gallon drum	EA	1

**Eco-Coil™ Environmentally Friendly Coil Cleaner**

Eco-Coil™ is an environmentally friendly no rinse non-corrosive cleaner ideal for evaporator and condenser coils, electronic and permanent filters, fan blades, grilles, mini-split and microchannel applications. Eco-coil quickly cleans away dirt, dust, and deposits while deodorizing with no harmful risks to animal, aquatic or plant life. Tested to provide the highest level of performance, Eco-Coil not only reduces the number of products required to clean but also has different water mixture ratios to maximize solution usage. Furthermore, it brightens, biodegradable, NSF approved, and meets the EPA's Design for the Environment Alternative Program as a "green" product.



CATALOG NO.	DESCRIPTION	UOM	ORDER MULTIPLE
<b>ECO-COIL-32</b>	Eco-Coil™ Environmentally Friendly Coil Cleaner – 32 oz. bottle	EA	12
<b>ECO-COIL</b>	Eco-Coil™ Environmentally Friendly Coil Cleaner – 1 gallon container	EA	4
<b>ECO-COIL-5</b>	Eco-Coil™ Environmentally Friendly Coil Cleaner – 5 gallon pail	EA	1
<b>ECO-COIL-55</b>	Eco-Coil™ Environmentally Friendly Coil Cleaner – 55 gallon drum	EA	1
<b>ECO-COIL-AER</b>	Eco-Coil™ – 19 oz. Aerosol	EA	1

**Pro-Brown™**

Pro-Brown™ is a heavy duty alkaline cleaner that pulls out deeply embedded dirt removing greasy soils and oxidation while brightening and cleaning coils. Ideal for air-cooled condensers and mini-splits thanks to its dual action foaming capabilities. It is biodegradable and NSF approved.



CATALOG NO.	DESCRIPTION	UOM	ORDER MULTIPLE
<b>PRO-BROWN-32</b>	Pro-Brown™ Foaming Coil Cleaner – 32 oz. bottle	EA	12
<b>PRO-BROWN</b>	Pro-Brown™ Foaming Coil Cleaner – 1 gallon container	EA	4
<b>PRO-BROWN-5</b>	Pro-Brown™ Foaming Coil Cleaner – 5 gallon pail	EA	1
<b>PRO-BROWN-55</b>	Pro-Brown™ Foaming Coil Cleaner – 55 gallon drum	EA	1
<b>PRO-BROWN-AER</b>	Pro-Brown™ – 19 oz. Aerosol	EA	6

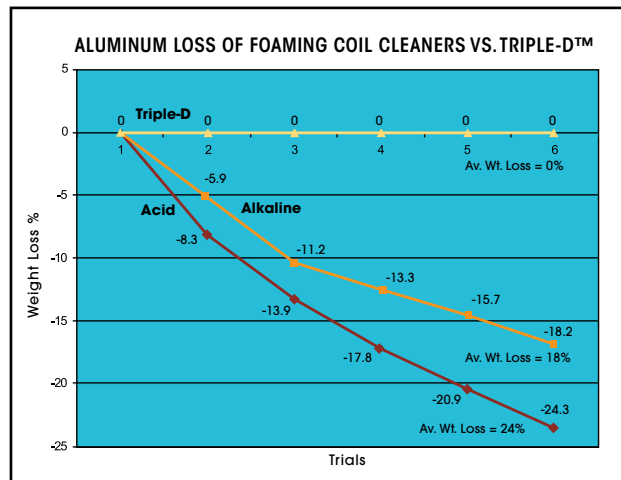

Conventional foaming acid and non-acid coil cleaners attack and chemically react with the aluminum coil components. This reaction is exhibited by a foaming action. The attack/reaction dissolves the aluminum, destroying the heat-transfer ability of the coil and creating the potential for refrigerant leaks.

**Pro-Blue™**

Pro-Blue™ is a heavy foaming alkaline-based solution designed for condensers and mini-splits that penetrates dirt and grease removing deposits resulting in clean and brightened coils. Pro-Blue is biodegradable, NSF approved, and available in numerous packaging configurations.

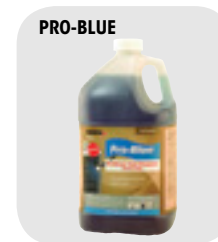

CATALOG NO.	DESCRIPTION	UOM	ORDER MULTIPLE
<b>PRO-BLUE-32</b>	Pro-Blue™ Foaming Concentrate (non-acid) – 32 oz. bottle	EA	12
<b>PRO-BLUE</b>	Pro-Blue™ Foaming Concentrate (non-acid) – 1 gallon container	EA	4
<b>PRO-BLUE-5</b>	Pro-Blue™ Foaming Concentrate (non-acid) – 5 gallon pail	EA	1
<b>PRO-BLUE-55</b>	Pro-Blue™ Foaming Concentrate (non-acid) – 55 gallon drum	EA	1
<b>PRO-BLUE-AER</b>	Pro-Blue™ – 19 oz. Aerosol	EA	6

**Pro-Green™**

Pro-Green™ is a no rinse, mild alkaline coil cleaner that can be used on air-cooled condensers, evaporators, electronic and permanent filters, fan blades, grilles, mini-split and microchannel applications. Pro-Green cleans deposits on coils and rids condensate pans of slime. It is NSF approved for use in federally inspected plants and available in numerous packaging configurations.

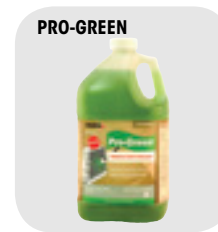

CATALOG NO.	DESCRIPTION	UOM	ORDER MULTIPLE
<b>PRO-GREEN-32</b>	Pro-Green™ No Rinse (non-toxic) – 32 oz. bottle	EA	12
<b>PRO-GREEN</b>	Pro-Green™ No Rinse (non-toxic) – 1 gallon container	EA	4
<b>PRO-GREEN-5</b>	Pro-Green™ No Rinse (non-toxic) – 5 gallon pail	EA	1
<b>PRO-GREEN-55</b>	Pro-Green™ No Rinse (non-toxic) – 55 gallon drum	EA	1
<b>PRO-GREEN-AER</b>	Pro-Green™ – 19 oz. Aerosol	EA	6

**COIL CLEANERS cont'd**

**Pro-Red Plus™**

Pro-Red Plus™ is a fast acting cleaning solution for condensers, microchannels, and mini-splits that foams and lifts away stubborn deposits including tarnish and corrosion. Its non-acid formula is as effective as conventional acid cleaners without the use of hydrofluoric acid. The vigorous foaming action eliminates the need for prolonged soaking, steam cleaning or scrubbing coils and without emitting corrosive fumes or rusting ferrous metals. Pro-Red Plus™ is biodegradable, NSF approved, and available in a number of convenient packaging solutions.



CATALOG NO.	DESCRIPTION	UOM	ORDER MULTIPLE
<b>PRO-RED+32</b>	Pro-Red Plus™ Cleaner and Brightener (non-acid) – 32 oz. bottle	EA	12
<b>PRO-RED+</b>	Pro-Red Plus™ Cleaner and Brightener (non-acid) – 1 gallon container	EA	4
<b>PRO-RED+5</b>	Pro-Red Plus™ Cleaner and Brightener (non-acid) – 5 gallon pail	EA	1
<b>PRO-RED+55</b>	Pro-Red Plus™ Cleaner and Brightener (non-acid) – 55 gallon drum	EA	1
<b>PRO-RED+AER</b>	Pro-Red Plus™ – 19 oz. Aerosol	EA	6

**Aerosol Starter Kit**

DiversiTech has created a 12 pack of aerosol cans consisting of two each of PRO-BLUE-AER, PRO-RED+AER, PRO-GREEN-AER, PRO-BROWN-AER, PRO-YELLOW-AER, and ECO-COIL-AER. This starter kit allows wholesalers the opportunity to stock a limited quantity of these new cans.



CATALOG NO.	DESCRIPTION	UOM	ORDER MULTIPLE
<b>AEROSOL-STARTER-KIT</b>	Aerosol Starter Kit – 2 each, 12 cans total	PK	1

**ACCESSORIES**

**Coil Guard™**

Ideally used in coastal areas, where salt air accelerates rust and decay. Highly recommended for use in all geographical areas to prolong the life of a unit. When applied properly, Coil Guard™ dries quickly and immediately resists salt spray, alcohol, acids, and soap solutions. Weather will not blacken it. Coil Guard™ has high dielectric properties and has no effect on heat transfer. Our blue tinted product is used to ensure complete coverage of coating.



CATALOG NO.	DESCRIPTION	UOM	ORDER MULTIPLE
<b>CG-AER</b>	Clear Coil Guard™ – 20 oz. Aerosol	EA	12
<b>CGB-AER</b>	Blue Coil Guard™ – 20 oz. Aerosol	EA	12

**Pro-Yellow™**

Pro-Yellow™ is a powerful cleaner ideal for condensers, microchannels, and mini-splits that targets large concentrations of dirt and grime. With its heavy foaming alkaline-based solution, debris will be removed from the coil while providing excellent brightening. Pro-Yellow is biodegradable, NSF approved and available in a number of packaging solutions.



CATALOG NO.	DESCRIPTION	UOM	ORDER MULTIPLE
<b>PRO-YELLOW-32</b>	Pro-Yellow™ (non-toxic) – 32 oz. bottle	EA	12
<b>PRO-YELLOW</b>	Pro-Yellow™ (non-toxic) – 1 gallon container	EA	4
<b>PRO-YELLOW-5</b>	Pro-Yellow™ (non-toxic) – 5 gallon pail	EA	1
<b>PRO-YELLOW-55</b>	Pro-Yellow™ (non-toxic) – 55 gallon drum	EA	1
<b>PRO-YELLOW-AER</b>	Pro-Yellow™ – 19 oz. Aerosol	EA	6

**Pro-Kleen™**

A unique foaming acid coil cleaner designed to replace hazardous hydrofluoric acid coil cleaners. It contains a synergistic combination of mineral acids, corrosion inhibitors, biodegradable surfactants, penetrants, and degreasers that emulsify, solubilize and neutralize soils leaving a clean, bright, efficient coil surface.



CATALOG NO.	DESCRIPTION	UOM	ORDER MULTIPLE
<b>PRO-KLEEN</b>	Pro-Kleen™ Outdoor Coil Cleaner – 1 gallon container	EA	4
<b>PRO-KLEEN-5</b>	Pro-Kleen™ Outdoor Coil Cleaner – 5 gallon pail	EA	1
<b>PRO-KLEEN-55</b>	Pro-Kleen™ Outdoor Coil Cleaner – 55 gallon drum	EA	1

**Cool-Weld™ Heat Barrier Spray**

Spray on thick gel formula that protects surfaces from heat and damage. Odorless, non-toxic gel coats rubber, plastic, and painted surfaces to shield them during welding or soldering.



CATALOG NO.	DESCRIPTION	UOM	ORDER MULTIPLE
<b>COOLWELD-32</b>	Cool-Weld™ Heat Barrier Spray – 32 oz. Container	EA	12

**ACCESSORIES cont'd**

**Pan-Patch™**

Pan-Patch™ is a two part epoxy coating with anti-microbial additives designed for HVAC applications. It is a self leveling formula that is ideal in a damp or wet environment. Pan-Patch™ resists corrosion and stops pan leaks without replacing the pan. Light gray in color, one gallon covers about 160 square feet with 10 mil thickness.



CATALOG NO.	DESCRIPTION	COVERAGE	UOM	ORDER MULTIPLE
<b>PANPATCH-BAG</b>	Pan-Patch™ Pan Sealant – Bag, pack of 10	8 sq. ft.	EA	10
<b>PANPATCH</b>	Pan-Patch™ Pan Sealant – 1 Gallon	160 sq. ft.	EA	4

**COIL CLEANING AEROSOLS**

**Saf-N-Kleen™ Aerosol Solvent Coil Cleaner**

High-solvency formula quickly and easily dissolves dirt, grease, oil or other residue while the blasting nozzle separates the materials from the surface. Non-flammable, non-conductive formula is safe to use on live equipment. Not for use in California.



CATALOG NO.	DESCRIPTION	UOM	ORDER MULTIPLE
<b>357-20</b>	Saf-N-Kleen™ Solvent Coil Cleaner – 18 oz. Aerosol	EA	12

**Foam-Plus™ Aerosol Foaming Coil Cleaner**

Heavy-duty foaming detergent coil cleaner in an aerosol can. Non-flammable and water-based with no chlorinated solvents. Blasting foam stream reaches into tight areas for maximum cleaning. The foaming alkaline detergent quickly liquifies dirt, grease, oil or other residue and is completely self-rinsing on condensate producing coils.



CATALOG NO.	DESCRIPTION	UOM	ORDER MULTIPLE
<b>358-20</b>	Foam-Plus™ Foaming Coil Cleaner – 19 oz.	EA	12

**DRAIN PAN DISINFECTANT**

**Sani C-N-D™ Coil and Drain Pan Disinfectant**

Sani C-N-D™ is an EPA registered disinfectant, fungicide, mildewstat and viricide. It is ready-to-use and assures consistent, effective results. Sani C-N-D™ destroys "dirty sock," mildew and other malodors.



CATALOG NO.	DESCRIPTION	UOM	ORDER MULTIPLE
<b>SANI-CND-32</b>	Sani C-N-D™ Disinfectant – 32 oz. Container	EA	12
<b>SANI-CND</b>	Sani C-N-D™ Disinfectant – 1 Gal. Container	EA	4
<b>SANI-CND-5</b>	Sani C-N-D™ Disinfectant – 5 Gallon Pail	EA	1
<b>SANI-CND-55</b>	Sani C-N-D™ Disinfectant – 55 Gallon Drum	EA	1

**Pan-Kote Heavy Duty Drain Pan Patch**

A super-durable rubberized coating used to fill-in and patch HVAC drain pans. Seals out rust and corrosion. Stays flexible in variable weather conditions.



CATALOG NO.	DESCRIPTION	UOM	ORDER MULTIPLE
<b>641-14</b>	Pan-Kote Drain Pan Patch – 14 oz. Aerosol	EA	12

**GLYCOLS**

DiversiTech produces the most complete line of industrial coolant and heat transfer products in the HVAC/R Industry. Our product line includes ProTek PG propylene glycol products formulated with food-grade corrosion inhibitors and ProTek EG ethylene glycol products for industrial applications. Both product groups are designed to provide freeze and burst protection and are formulated with inhibitors and antifoam agents to provide long-term stability against system corrosion and fouling.

**ProTek EG™**

An inhibited ethylene glycol based heat transfer fluid designed for use in hydronic, chilled and closed water.

CATALOG NO.	DESCRIPTION	GLYCOL/WATER RATIO	UOM	ORDER MULTIPLE
<b>EG</b>	ProTek EG™ – 1 Gallon Jug	95/5	EA	4
<b>EG-5</b>	ProTek EG™ – 5 Gallon Pail	95/5	EA	1
<b>EG-55</b>	ProTek EG™ – 55 Gallon Drum	95/5	EA	1



**GLYCOLS cont'd**

**ProTek™ Closed Loop Heat Transfer Fluid**

ProTek™ for closed loop water recirculation systems is a blue liquid. Available in three concentrations: original ProTek-100™, ProTek-50™, and ProTek-Plus™. Each concentration may be further diluted to alter freeze and burst temperatures. Refer to the technical data sheet for specific information.



CATALOG NO.	DESCRIPTION	GLYCOL/WATER RATIO	UOM	ORDER MULTIPLE
<b>PG-50</b>	ProTek-50™ – 1 Gallon Jug	35/65	EA	4
<b>PG-50-5</b>	ProTek-50™ – 5 Gallon Pail	35/65	EA	1
<b>PG-50-55</b>	ProTek-50™ – 55 Gallon Drum	35/65	EA	1

**ProTek PG Plus™**

ProTek PG PLUS™ is an inhibited propylene glycol based industrial heat transfer fluid and anti freeze that contains food grade corrosion inhibitors. It is suitable for use in potable water systems. ProTek PG PLUS™ is designed to provide freeze and burst protection, excellent thermal conductance, protection against corrosion and fouling and long term stability in closed recirculating water loops. ProTek PG PLUS™ must be mixed with water to provide freeze and burst protection. Freeze points and burst points are controlled by the propylene glycol to water ratio.



CATALOG NO.	DESCRIPTION	GLYCOL/WATER RATIO	UOM	ORDER MULTIPLE
<b>PG-PLUS</b>	ProTek-Plus™ – 1 Gallon Jug	95/5	EA	4
<b>PG-PLUS-5</b>	ProTek-Plus™ – 5 Gallon Pail	95/5	EA	1
<b>PG-PLUS-55</b>	ProTek-Plus™ – 55 Gallon Drum	95/5	EA	1

**ProTek PG 100™**

ProTek 100™ is an inhibited propylene glycol based industrial heat transfer fluid and antifreeze that contains food grade corrosion inhibitors. It is suitable for use in potable water systems. ProTek 100™ is designed to provide freeze and burst protection, excellent thermal conductance, protection against corrosion and fouling and long term stability in closed recirculating water loops. ProTek 100™ provides burst protection to 100°F. Freeze points and burst points are controlled by the propylene glycol to water ratio.



CATALOG NO.	DESCRIPTION	GLYCOL/WATER RATIO	UOM	ORDER MULTIPLE
<b>PG-100</b>	ProTek-100™ – 1 Gallon Jug	70/30	EA	4
<b>PG-100-5</b>	ProTek-100™ – 5 Gallon Pail	70/30	EA	1
<b>PG-100-55</b>	ProTek-100™ – 55 Gallon Drum	70/30	EA	1

**ProTek BG™ for Cast Iron Water Boilers**

A red liquid boiler grade product formulated specifically with corrosion inhibitors necessary for use in water boilers.



CATALOG NO.	DESCRIPTION	GLYCOL/WATER RATIO	UOM	ORDER MULTIPLE
<b>PG-BG</b>	ProTek-BG™ – 1 Gallon Jug	70/30	EA	4
<b>PG-BG-5</b>	ProTek-BG™ – 5 Gallon Pail	70/30	EA	1
<b>PG-BG-55</b>	ProTek-BG™ – 55 Gallon Drum	70/30	EA	1

**FLUSHING PRODUCTS**

**Pro-Flush® HVAC Flushing Solvent**

A flushing solvent for A/C and refrigeration systems formulated for R410A retrofits, refrigerant conversions and compressor burnouts. Compatible with all refrigerants and compressor oils. All solvents in Pro-Flush® are non VOC and conform to EPA SNAP standards: low toxicity and residue free. Available as a kit or in an 8 or 16 oz. solvent refill. The kit makes servicing quick, easy, and safe, as well as assuring you get to the job site with all necessary hardware in hand for 1 stop servicing. The kit includes: 8 oz. container of Pro-Flush® solvent, refillable Pro-Flush® injector tool pressure tank, pressure relief valve for added safety, large rubber adapter that flushes up to 1-1/4" line sets, service hose.



CATALOG NO.	DESCRIPTION	UOM	ORDER MULTIPLE
<b>PF-KIT</b>	Pro-Flush® Kit – injector, 8 oz. refill, nozzle adapter and hose	EA	3
<b>PF-08</b>	Pro-Flush® HVAC Flushing Solvent – 8 oz. Refill	EA	6
<b>PF-16</b>	Pro-Flush® HVAC Flushing Solvent – 16 oz. Refill	EA	6
<b>PF-ADAPTER</b>	Pro-Flush® Line Set Adapter	EA	1
<b>PF-IGUN</b>	Replacement Injector Tool	EA	1
<b>PF-IHOSE</b>	2' Replacement Hose	EA	1

**Super Change™**

Super Change eliminates oil change outs replacing R22 line set conversion flushes. Ideal for dry charged units, retrofits, and drop-in refrigerants, Super Change maximizes oil return and heat transfer including POE charged compressors. Reusable hose (20122) sold separately. Also available in flexible injectable hose (991).



CATALOG NO.	DESCRIPTION	UOM	ORDER MULTIPLE
<b>981</b>	Super Change™ - Up to 6 Tons	EA	6
<b>20122</b>	Reusable Charging Hose for Super Change™	EA	1
<b>991</b>	Super Change™ Inject	EA	4

**HOSES, SPRAYERS**

**Power Sprayer**

DiversiTech's Power Sprayer makes coil cleaning easier and faster! Designed as a backpack sprayer, it holds up to 4 gallons of coil cleaning solution. The battery powered unit will spray continuously for 10 hours on a single charge. Included are three different nozzles to give you the right spray for any situation. It also features: padded backpack straps for a comfortable fit, plug-in charger for fast recharging, a convenient center mount handle, an extra long spray wand with curved tip for accurate application, and a large on/off valve which can lock in position for easier spraying of big jobs. The large tank opening also makes it easy to add coil cleaner and mix to the correct ratio. The Power Sprayer is compatible with all DiversiTech coil cleaners.



**PS-1**

CATALOG NO.	DESCRIPTION	UOM	ORDER MULTIPLE
<b>PS-1</b>	Battery powered/rechargeable backpack sprayer for coil cleaning	EA	1

**Dial-a-Mix Sprayer**

Save time and money by dialing in the exact mix ratio to properly clean the coil. This sprayer features 5 mix ratios, a 1/2 gallon capacity bottle and a quick disconnect for fast and easy rinsing.



**540-GUN**

CATALOG NO.	DESCRIPTION	UOM	ORDER MULTIPLE
<b>540-GUN</b>	Dial-a-Mix Sprayer	EA	6

**Garden Hose**

High quality product priced for high volume sales. Soft-Flex formulation makes the 5 ply Hose easy to handle. Withstands 500 psi water pressure. Heavy duty solid brass couplings and collar. Full Lifetime Guarantee!

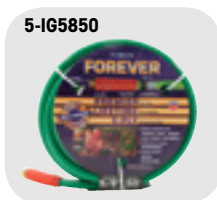

**5-IG5850**

CATALOG NO.	DESCRIPTION	UOM	ORDER MULTIPLE
<b>5-IG5850</b>	Green Flexon 5-Ply Forever Garden Hose	EA	5

**All Purpose Sprayers**

Lightweight, versatile gallon size bottle has a 28" flexible hose and easy-to-carry handle. Best for big jobs in hard- to-reach places. Adjustable nozzle will atomize any low viscosity liquid. Adjusts from a mist to a 12' jet stream or anything in between. One pint container has a measured ounce guide. Ideal for water treatment chemicals.



**BS-32**

CATALOG NO.	DESCRIPTION	UOM	ORDER MULTIPLE
<b>BS-32</b>	Quart Size Sprayer	EA	12

**Compression Sprayers**

Acid impervious poly design with a 36" (91cm) reinforced hose, shut-off with lock-on feature for continuous spraying, a 2-piece nozzle that's detachable for easy clean up and fits directly to the shut-off or extension wand. The Hand-Held Sprayer has a 48 oz. (1.4 l) capacity, perfect for small areas. All sprayers have a full 5 year warranty.



**1002**

**2601**

CATALOG NO.	DESCRIPTION	UOM	ORDER MULTIPLE
<b>1002</b>	Hand Held Sprayer	EA	1
<b>2601</b>	1 Gallon Wand Sprayer	EA	1
<b>2602</b>	2 Gallon Wand Sprayer	EA	1
<b>2603</b>	3 Gallon Wand Sprayer	EA	1

**Hot Water Hose**

High burst strength. 500 PSI. Withstands hot water up to 160°F. EPDM tube. Heavy duty solid brass couplings.

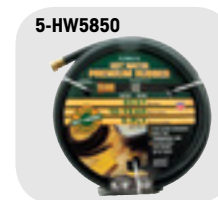

**5-HW5850**

CATALOG NO.	DESCRIPTION	UOM	ORDER MULTIPLE
<b>5-HW5850</b>	5/8" x 50' Hot Water Hose	EA	5

**Pistol Grips & Water Nozzle**

Pistol Grip – 540-572 Insulated: For spraying hot or cold water. Heavy-duty, self adjusting "duck" packing for lifetime proof seal. Water Nozzle – 540-573 Un-insulated: Heavy-duty and holds open clip for continuous spraying. Self-adjusting "duck" for leak proof seal.



**540-572**

**540-573**

CATALOG NO.	DESCRIPTION	UOM	ORDER MULTIPLE
<b>540-572</b>	Insulated Pistol Grip	EA	12
<b>540-573</b>	Uninsulated Water Nozzle	EA	12

**ICE MACHINE PRODUCTS**

**Super-Kool™ Nickel-Safe and Metal-Safe Ice Machine Cleaner**

An economical, fast-acting, non-foaming acid sequesterant formula that quickly removes soil and mineral buildup. This safe, highly-concentrated, inhibited formula will not attack nickel or other metal components. USDA AUTHORIZED



CATALOG NO.	DESCRIPTION	UOM	ORDER MULTIPLE
<b>SUPER-KOOL-16</b>	Super-Kool™ Ice Machine Cleaner – 16 oz. Bottle	EA	12
<b>SUPER-KOOL</b>	Super-Kool™ Ice Machine Cleaner – 1 Gallon Container	EA	4

**LEAK DETECTORS AND ACCESSORIES**

**Bubble-N-Trouble™ Freeze Protected Spray-On Leak Detector**

Non-corrosive, non-toxic, and biodegradable. Does not attack metal or interfere with brazing or soldering. Spray-on application allows easy access for hard to reach places. Tacking agent holds solution on test surface making Bubble-N-Trouble™ very economical. USDA AUTHORIZED



CATALOG NO.	DESCRIPTION	UOM	ORDER MULTIPLE
<b>BNT-32</b>	Bubble-N-Trouble™ Freeze Protected Leak Detector – 32 oz. Spray	EA	12
<b>BNT-1</b>	Bubble-N-Trouble™ Freeze Protected Leak Detector – 1 Gallon Container	EA	4

**Radiant Leak Finder™**

Radiant color and viscous clinging formula exposes the smallest leaks. Freeze-protected – remains effective down to 0° F.



CATALOG NO.	DESCRIPTION	UOM	ORDER MULTIPLE
<b>RLF-8</b>	Radiant Leak Finder™ – 8 oz. Container	EA	12

**Flash™ Detect UV Leak Detection Kit**

Flash™ Detect UV leak detection kit include 3 cans of Flash dye, a reusable clear hose, heavy-duty storage case, and choice of UV light.



CATALOG NO.	DESCRIPTION	UOM	ORDER MULTIPLE
<b>98084KIT</b>	Flash™ Detect with 3 cans, hose, and SEEKERmini™ Worklight	EA	1
<b>98087KIT</b>	Flash™ Detect with 3 cans, hose, and SEEKERmini™ Worklight	EA	1

**Pro-Bubble™ Leak Detector**

Easy-to-use, high-bubbling, viscoelastic blue leak detector. New improved formula.



CATALOG NO.	DESCRIPTION	UOM	ORDER MULTIPLE
<b>PRO-BUBBLE-32</b>	Pro-Bubble™ Leak Detector – 32 oz. Bottle with Spray Top	EA	12

**Flash™ Detect UV Dye**

Flash™ Detect Inject (990) is an integrated UV dye solution that injects like Flex Inject™ Sealant without the use of tools or manifold gauges. Flash™ Detect (980) will not react with moisture and travels with the speed of the refrigerant once installed finding leaks within minutes. Using a patented misting orifice. Flash™ Detect Inject uses the refrigerant as the propellant ensuring a no-mess injection every time (20122 reusable hose sold separately for 980).



CATALOG NO.	DESCRIPTION	UOM	ORDER MULTIPLE
<b>980</b>	Flash™ Detect Universal UV Dye - Up to 5 Tons	EA	12
<b>20122</b>	Reusable Hose, Clear for 980	EA	1
<b>990</b>	Flash™ Detect Inject - Up to 6 Tons	EA	6

**SEEKERmini™**

High powered UV light with 3 AAA batteries included with no UV enhancing glasses required.



CATALOG NO.	DESCRIPTION	UOM	ORDER MULTIPLE
<b>84DCPLUS</b>	SEEKERmini™ UV LED Worklight	EA	1



**LEAK DETECTORS AND ACCESSORIES cont'd**

**SEEKERmax™**

High powered UV light with rechargeable 2200 mAh lithium-ion battery with no UV enhancing glasses required.



CATALOG NO.	DESCRIPTION	UOM	ORDER MULTIPLE
<b>87DCPLUS</b>	SEEKERmax™ UV LED Worklight	EA	1

**UV Pocket Light**

UV Pocket Light with 3 AAA batteries included. A great light to pair with 995 Flex Inject® Sealant and 990 Flash™ Detect Inject.



CATALOG NO.	DESCRIPTION	UOM	ORDER MULTIPLE
<b>89DC</b>	UV Pocket Light	EA	12

**Patriot Pocket Worklight**

A three light integrated rechargeable system that includes a red top light (30 lumens), 250 lumen front light, and a 390-400nm wavelength UV light. Patriot charger sold separately (111110A).

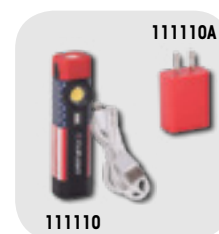

CATALOG NO.	DESCRIPTION	UOM	ORDER MULTIPLE
<b>111110</b>	Patriot Worklight	EA	6
<b>111110A</b>	Patriot Worklight Charger	EA	6

**LEAK SEALANTS**

**Flex Inject® Sealant Advanced & Total**

Flex Inject® Sealant Advanced is the fastest, most effective proven way to permanently seal and prevent minor air conditioning and refrigeration (AC/R) leaks. With no tools or gauges required, the Flex Inject® Sealant Advanced works by travelling through the system with the oil and refrigerant fixing leaks immediately (up to 300 microns). Flex Inject® Sealant Advanced works with all compressors, heat pumps, condensers, and other system components and it will not plug up manifold gauges, metering devices, thermostatic expansion valves (TXVs), pistons or cause cap tube blockages. It meets the ASHRAE ARI 700 refrigerant standard and is compatible with any refrigerant including R-410A with no pump downs or recoveries required. Flex Inject® Sealant Advanced is suitable for use in aluminum and copper coils and is microchannel friendly. Flex Inject® Sealant Total has all the benefits of Advanced but includes UV dye.



CATALOG NO.	DESCRIPTION	UOM	ORDER MULTIPLE
<b>985</b>	Flex Inject® Sealant Advanced	EA	6
<b>995</b>	Flex Inject® Sealant Total	EA	6
<b>999KIT</b>	Flex Inject® and Flash™ Detect Merchandiser Kit Four each of 985, 990, 995 (Case of 12)	EA	1

**Super Seal™ Sealant Advanced**

Super Seal™ Sealant Advanced includes a stop leak sealant and Dry R™. Provides for a fast install with no pump down or recovery even for R410A. Compatible with all oils and refrigerants. Hose included.



CATALOG NO.	DESCRIPTION	UOM	ORDER MULTIPLE
<b>947KIT</b>	Super Seal™ Sealant Advanced - Up to 1.5 Tons	EA	12
<b>944KIT</b>	Super Seal™ Sealant Advanced - 1.5 to 5 Tons	EA	12
<b>948KIT</b>	Super Seal™ Sealant Advanced - 5+ Tons	EA	1

**Super Seal™ Sealant Total**

Super Seal™ Sealant Total includes a stop leak sealant, Dry R™, and Flash™ with all the benefits of Super Seal™ Sealant Advanced plus UV dye. Hose included.

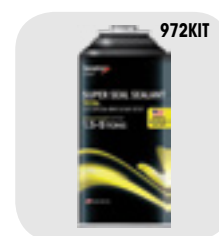

CATALOG NO.	DESCRIPTION	UOM	ORDER MULTIPLE
<b>971KIT</b>	Super Seal™ Sealant Total - Up to 1.5 Tons	EA	12
<b>972KIT</b>	Super Seal™ Sealant Total - 1.5 Tons to 5 Tons	EA	12

**Seal-N-Go® Self-Sealing Refrigerant**

Seal-N-Go® is an excellent solution for taking R410A refrigerant on job sites and includes Super Seal™ Sealant Advanced. It allows technicians to fill and stop and prevent leaks simultaneously. With a reusable charging hose (sold separately), the 25.7 ounce lightweight cannister is great for topping off multiple systems and perfect for mini-split installs. Reusable charging hose (20133) sold separately.



CATALOG NO.	DESCRIPTION	UOM	ORDER MULTIPLE
<b>9410SSR</b>	Seal-N-Go® 25.7 R410 Refrigerant plus Super Seal™ Sealant Advanced	EA	6
<b>20133</b>	Reusable Charging Hose with Gauge	EA	1

**LEAK SEALANTS cont'd**

**Super Seal™ Sealant Sure Shot**

Super Seal™ Sealant Sure Shot includes a stop leak sealant and Eco Boost. Hose and cartridge included.



CATALOG NO.	DESCRIPTION	UOM	ORDER MULTIPLE
<b>983KIT</b>	Super Seal™ Sealant Sure Shot - Up to 6 Tons	EA	12
<b>984</b>	Super Seal™ Sealant Sure Shot - Up to 6 Tons Replacement Cartridge	EA	12
<b>940</b>	Super Seal™ Sealant Sure Shot, 1/4 in. SAE Reusable Hose	EA	1

**ODOR NEUTRALIZERS**

**Duct-Fresh™ Gel**

A non-toxic, super-effective odor neutralizer for HVAC ducts, proficient at destroying stubborn odors including pet, smoke, and musty smells in residential, industrial and commercial applications. Effective for up to 6 months.



CATALOG NO.	DESCRIPTION	UOM	ORDER MULTIPLE
<b>DUCT-FRESH-8</b>	Duct-Fresh™ Gel – 8 oz.	EA	12
<b>DUCT-FRESH-16</b>	Duct-Fresh™ Gel – 16 oz.	EA	8

**The Purifier™**

The Purifier™ is an electric device that removes stubborn odors like tobacco smoke. It eliminates mold, mildew and bacteria from HVAC systems. The Purifier™ completes most jobs in just 20 minutes. Includes programmable timer with LCD display.



CATALOG NO.	DESCRIPTION	UOM	ORDER MULTIPLE
<b>170AIR</b>	The Purifier™ Fresh Air Ozone Machine	EA	1
<b>170AIRFAN</b>	Replacement Fan	EA	1
<b>170AIRPCB</b>	Replacement Circuit Board	EA	1
<b>UVEC-07G</b>	12V Charger for Cigarette Lighter	EA	1
<b>410211</b>	Replacement AC Adapter	EA	1
<b>410212</b>	Replacement UV Bulb	EA	1

**Duct-Fresh™ Spray**

A non-toxic, instantaneous, super-effective odor neutralizer for HVAC ducts. Destroys stubborn pet odors, smoke, and musty smells in residential, industrial and commercial applications. Great for spot-treating malodor problem areas.



CATALOG NO.	DESCRIPTION	UOM	ORDER MULTIPLE
<b>DUCT-FRESH-32</b>	Duct-Fresh™ Spray – 1 Quart	EA	12

**Odor-Aid™**

Disinfects and deodorizes with an easy pump spray. Eliminates bacteria, germs and microorganisms that cause offensive odors.



CATALOG NO.	DESCRIPTION	UOM	ORDER MULTIPLE
<b>171AIR</b>	Odor-Aid™ – 7 oz. Bottle with Spray Top	EA	12

**PAN TREATMENTS/DISINFECTANTS**

**Flow Plus® Condensate Pan Treatment**

A unique polymer formula that maintains condensate flow and prevents drain pan overflow. 100% active. No residue—no waste—nonclogging. Effective, long-term condensate activated release. Environmentally safe, non-toxic, and non-corrosive. Also economical with sizes to meet all tonnage requirements.



CATALOG NO.	EQUIPMENT TONNAGE
<b>FLOW-PLUS-25</b>	1/2 to 3 tons
<b>FLOW-PLUS-200</b>	1/2 to 3 tons
<b>FLOW-PLUS-6</b>	3 to 5 tons
<b>FLOW-PLUS-10</b>	5 to 20 tons
<b>FLOW-PLUS-125</b>	20 to 50 tons

CATALOG NO.	DESCRIPTION	UOM	ORDER MULTIPLE
<b>FLOW-PLUS-25</b>	Flow-Plus® Condensate Pan Treatment – 25 Tabs/Jar	EA	12
<b>FLOW-PLUS-200</b>	Flow-Plus® Condensate Pan Treatment – 200 Tabs/Jar	EA	4
<b>FLOW-PLUS-6</b>	Flow-Plus® Condensate Pan Treatment – 6 - 1 oz. Blocks	EA	12
<b>FLOW-PLUS-10</b>	Flow-Plus® Condensate Pan Treatment – 10 oz. Tubs	EA	18
<b>FLOW-PLUS-125</b>	Flow-Plus® Condensate Pan Treatment – 1.25 lb. Tubs	EA	8

**Pro-Treat®-151 Premium Condensate Drain Pan Treatment**

Pro-Treat®-151 premium tablets penetrate and help remove sludge that can plug drain pans and drain lines and foul humidifier pans. Kills odors associated with slime and sludge, minimizing maintenance problems from overflow and water damage caused by fouled pans, plugged traps, or drain lines. Tablets are 100% soluble, easy-to-use, and do not form any deposits in the pan or drain line. Approved for computer rooms. Dosage: 1 tablet per 3 tons each month. PRO-TREAT-151 is EPA registered.



CATALOG NO.	DESCRIPTION	UOM	ORDER MULTIPLE
<b>PROTREAT-151</b>	Pro-Treat®-151 Premium Drain Pan Treatment – 100 Tablets/Jar	EA	12

**Pro-Treat® 161 Condensate Drain Pan Treatment**

Controls odors and eliminates condensate drain pan overflows and the resulting water damage. 100% soluble, easy-to-use, non-corrosive, and non-toxic. Use regularly to assure season-long, trouble-free condensate drain pan performance. Approved for computer rooms. Dosage: 2 tablets per 3 tons each month.



CATALOG NO.	DESCRIPTION	UOM	ORDER MULTIPLE
<b>PROTREAT-161</b>	Pro-Treat® 161 Drain Pan Treatment – 100 Tablets/Jar	EA	12

**Pro-Treat® 217 Economy Condensate Drain Pan Treatment**

Economical with 200 tablets per jar. Safe, non corrosive, odor free and 100% soluble. Approved for computer rooms. Convenient, easy to use tablet form provides prolonged cleaning action. Dosage 3 tablets per 3 tons per month.



CATALOG NO.	DESCRIPTION	UOM	ORDER MULTIPLE
<b>PROTREAT-217</b>	Pro-Treat® 217 Economy Drain Pan Treatment – 200 Tablets/Jar	EA	12

**Pro-Treat® 350 Condensate Drain Pan Treatment**

Place a Pro-Treat® 350 tablet in a condensate drain pan and condensed moisture will slowly dissolve the tablet, thinly coating the pan surface to give prolonged cleaning action on sludge. Dosage: one or two tablets are recommended in each pan per month. For industrial use only!



CATALOG NO.	DESCRIPTION	UOM	ORDER MULTIPLE
<b>PROTREAT-350</b>	Pro-Treat® 350 Condensate Pan Treatment – EA 100 Tablets per Jar	EA	24

**Pro-Treat®152 King-Size Premium Condensate Drain Pan Treatment**

Economical, safe, effective king-size tablets last three times longer. Safe, non-corrosive, odor-free and 100% soluble. Computer room approved. Keeps drain pans and condensate lines clean and free flowing. Dosage: 1 tablet per 3 tons per 3 months.



CATALOG NO.	DESCRIPTION	UOM	ORDER MULTIPLE
<b>PROTREAT-152</b>	Pro-Treat® 152 King-Size Premium Drain Pan Treatment – 12 Tablets/Jar	EA	6

**Pro-Treat® 200 Economy Condensate Drain Pan Treatment**

Economical with 200 tablets per jar. Safe, non-corrosive, odor-free and 100% soluble. Approved for computer rooms. Convenient, easy-to-use tablet form provides prolonged cleaning action. Dosage: 3 tablets per 3 tons per month.



CATALOG NO.	DESCRIPTION	UOM	ORDER MULTIPLE
<b>PROTREAT-200</b>	Pro-Treat® 200 Economy Drain Pan Treatment – 200 Tablets/Jar	EA	12

**Pro-Treat® Pan Strips**

Pro-Treat® Pan Strips kill odor causing bacteria and last up to 6 months. Use in the primary drain pan of cooling units such as air conditioners and refrigerators. Pro-Treat® Pan Strips control foul-smelling odors caused by mildew, fungi, bacteria, algae, and slime. For use in hotels, schools, colleges, hospitals, nursing homes, airports, and many other locations.



CATALOG NO.	DESCRIPTION	STRIPS/PACK	UOM	ORDER MULTIPLE
<b>PS-075</b>	Pro-Treat® Pan Strips – for up to 3/4 Ton	10	EA	12
<b>PS-01</b>	Pro-Treat® Pan Strips – for 1 to 2 Ton	10	EA	12
<b>PS-03</b>	Pro-Treat® Pan Strips – for 3 to 5 Ton	6	EA	24
<b>PS-07</b>	Pro-Treat® Pan Strips – for 7 to 12 Ton	2	EA	24
<b>PS-20</b>	Pro-Treat® Pan Strips – for 20 to 25 Ton	1	EA	24
<b>PS-40</b>	Pro-Treat® Pan Strips – for 40 to 50 Ton	1	EA	12

EPA Registration #6836-254-69966

## REFRIGERATION OILS

### Pro-Lube™ Mineral Oil

Specialty Chemical mineral oil (by Calumet) is a superior mineral naphthenic refrigeration oil designed to meet the operating requirements of modern residential and commercial air conditioning and refrigeration compressors. These oils have a low pour point, low wax floc temperature and are chemically and thermally stable in the presence of refrigerants. OEM approved by Copeland, Carlyle, Trane, and other major compressor manufacturers. Always follow compressor manufacturer's oil viscosity recommendations. Mineral oil is specially recommended for lubrication of compressors containing ammonia, R-11, 12, 13, 22, 113, 114, 123, 500 and 502 refrigerants in residential, industrial and commercial service. **DO NOT USE WITH HFC REFRIGERANTS SUCH AS R-134A.**



CATALOG NO.	DESCRIPTION	UOM	ORDER MULTIPLE
<b>3WF-01</b>	SUS150 ISO32 Pro-Lube™ Mineral Oil – 1 Gallon Jug	EA	4
<b>4WF-01</b>	SUS300 ISO68 Pro-Lube™ Mineral Oil – 1 Gallon Jug	EA	4

### Pro-Lube-POE™ Polyolester

Specialty Chemical POE is custom formulated for use in refrigeration compressors. This series contains no ozone depleting substances and is compatible with new HFC refrigerants as well as existing CFC and HCFC refrigerants. POE is also compatible with traditional mineral oil lubricants.



CATALOG NO.	DESCRIPTION	UOM	ORDER MULTIPLE
<b>POE32-32</b>	SUS150 ISO32 Pro-Lube-POE™ Polyolester – 1 Quart Can	EA	12
<b>POE32-01</b>	SUS150 ISO32 Pro-Lube-POE™ Polyolester – 1 Gallon Can	EA	6
<b>POE68-32</b>	SUS300 ISO68 Pro-Lube-POE™ Polyolester – 1 Quart Can	EA	12
<b>POE68-01</b>	SUS300 ISO68 Pro-Lube-POE™ Polyolester – 1 Gallon Can	EA	6
<b>POE100-32</b>	SUS500 ISO100 Pro-Lube-POE™ Polyolester – 1 Quart Can	EA	12
<b>POE100-01</b>	SUS500 ISO100 Pro-Lube-POE™ Polyolester – 1 Gallon Can	EA	6

## SYSTEM CLEANERS

### D'Scale™ Acid Scale Remover for Cooling Towers

D'Scale™ will not create corrosive acidic foam. D'Scale™ has pH indicating dye. The color changes to yellow when acid has been consumed. Each gallon dissolves 3 pounds of scale.



CATALOG NO.	DESCRIPTION	UOM	ORDER MULTIPLE
<b>D-SCALE</b>	D'Scale™ Acid Scale Remover – 1 Gallon Container	EA	4

## TEST KITS

### Acid Test Kit™

Detects acid in refrigeration oil. Convenient, one-step test means no chemicals to mix. Easy to evaluate. Color change indicates acidity; color intensity reveals the amount of acid present in the oil sample.



CATALOG NO.	DESCRIPTION	UOM	ORDER MULTIPLE
<b>ATK-4</b>	Acid Test Kit™, pack of 4	EA	4
<b>ATK-1</b>	Acid Test Kit™	EA	1
<b>ATK-1P</b>	Acid Test Kit™ for POE Oil	EA	1

## THREAD SEALANTS

### PRO-TITE™ Resin Based Thread Sealant

Resin based thread sealant that adheres to internal surfaces, fills voids while forming a flexible fluid tight seal. Specifically formulated for use on metals and plastics subject to extreme vibration. Serviceable at temperatures from 100°F (73°C) to 400°F (204°C) and from full vacuum to 10,000 PSI. Pro-Tite™ is impervious to most chemicals including refrigerants, petroleum products, gases, steam, etc. Alcohol based.



CATALOG NO.	DESCRIPTION	UOM	ORDER MULTIPLE
<b>CLL-1</b>	Pro-Tite™ Thread Sealant – 1-1/3 oz. Squeeze Tube	EA	12
<b>CLL-4</b>	Pro-Tite™ Thread Sealant – 4 oz. Brush Top	EA	12

## VACUUM PUMP OIL

### Pro-Lube-VAC™ Vacuum Pump Oil

VP-68 Premium Vacuum Pump Oil is now based on a highly refined paraffinic based stock. This new improved formulation is lighter in color and provides better viscosity and oxidation stability than the previous formulation. VP-68 provides excellent cold start performance; formulated to meet minimum moisture content specifications.



CATALOG NO.	DESCRIPTION	UOM	ORDER MULTIPLE
<b>VP68-32</b>	Pro-Lube-VAC™ Vacuum Pump Oil – 1 Quart Jug	EA	12
<b>VP68-01</b>	Pro-Lube-VAC™ Vacuum Pump Oil – 1 Gallon Jug	EA	4
<b>VP68-05</b>	Pro-Lube-VAC™ Vacuum Pump Oil – 5 Gallon Pail	EA	1

## ADDITIVES

### Acid Eliminator

Keeps acid away; compatible with all refrigerants and oils. Chemically neutralizes and prevents acids that are formed in air conditioning and refrigeration systems due to refrigerant and refrigeration oil break-down, moisture, and compressor burnout. Easy-to-use, no complicated charts. Works fast, circulates quickly, and leaves no solids or solid residuals. Will not harm system components. Can prevent system breakdown.



CATALOG NO.	DESCRIPTION	UOM	ORDER MULTIPLE
<b>ACID-ELIM</b>	Acid Eliminator – 4 oz. Plastic Bottle	EA	12

### Pro-Thaw™ Liquid Dryer for Refrigerants

Chemically dries all refrigerants (R-12, R-22, R-134a, etc.), methyl chloride and methylene chloride. Frees up systems frozen due to moisture contamination in 5 minutes and prevents refreezing. Does not contain any dissolved solids, leaves no residue and works with or without solid dryers.



CATALOG NO.	DESCRIPTION	UOM	ORDER MULTIPLE
<b>PRO-THAW-1</b>	Pro-Thaw™ – 1 oz. Plastic Bottle	EA	24
<b>PRO-THAW</b>	Pro-Thaw™ – 4 oz. Plastic Bottle	EA	12

### Dry R™

DRY R™ enhances the function of driers and metering devices by removing non-condensables, eliminating ice crystals, and breaking down blockages by removing scale and sludge on moving parts such as TXVs.



CATALOG NO.	DESCRIPTION	UOM	ORDER MULTIPLE
<b>973KIT</b>	Dry R™ Moisture Eliminator - Up to 5 tons	EA	12

### Boost Juice® & Boost Juice® Inject

Boost Juice® is an HVAC/R system performance improvement additive that lowers energy costs by reducing the amperage draw up to 22% (testing average of 13%) on a system when running.



CATALOG NO.	DESCRIPTION	UOM	ORDER MULTIPLE
<b>992</b>	Boost Juice® Inject - Up to 6 Tons	EA	4
<b>993KIT</b>	Boost Juice® Kit - Up to 6 Tons	EA	6

# A partner you can **TRUST**

## Trust - It's what we're all about

You can trust DiversiTech products to make your jobs easier and simplify your work. For 50 years DiversiTech has been producing quality HVAC/R products that contractors rely on to get the job done right the first time.



**CP-22**



**DrainGun™**

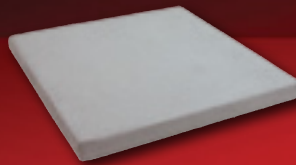

**UltraLite® Pads**



**E Lite® Pads**



**The Hurricane Pad™  
Attachment Bracket**



**Whips**



**Drain Pans**



**Disconnects**

**and More!**



**Simplify your Work.™**

# INLINE COMPONENTS

Sentry™ Refrigerant Locking Caps .....	247
Access Fittings .....	251
Line Piercing Valves and Tools .....	252
Brass Fittings.....	253-255
Copper Fittings .....	248-250
Cushion Clamps .....	255
Driers, Sight Glasses .....	256-257
Refrigerant Charging.....	257
Refrigerant Tubing .....	258-259
Refrigerant Labels.....	259
Refrigerant Recovery Products .....	260
Tubing Insulation .....	260





# REFRIGERANT LOCKING CAPS

**Sentry™ Refrigerant Locking Caps** meet the International Residential Code (IRC) and International Mechanical Code (IMC) requirement that all outdoor access ports on A/C and refrigerant equipment must be tamper resistant. Sentry™ Locking Caps safeguard against refrigerant theft and inhalant abuse. These locking caps are anodized in industry color codes for easy identification and prevent accidental mixing of refrigerant gases.

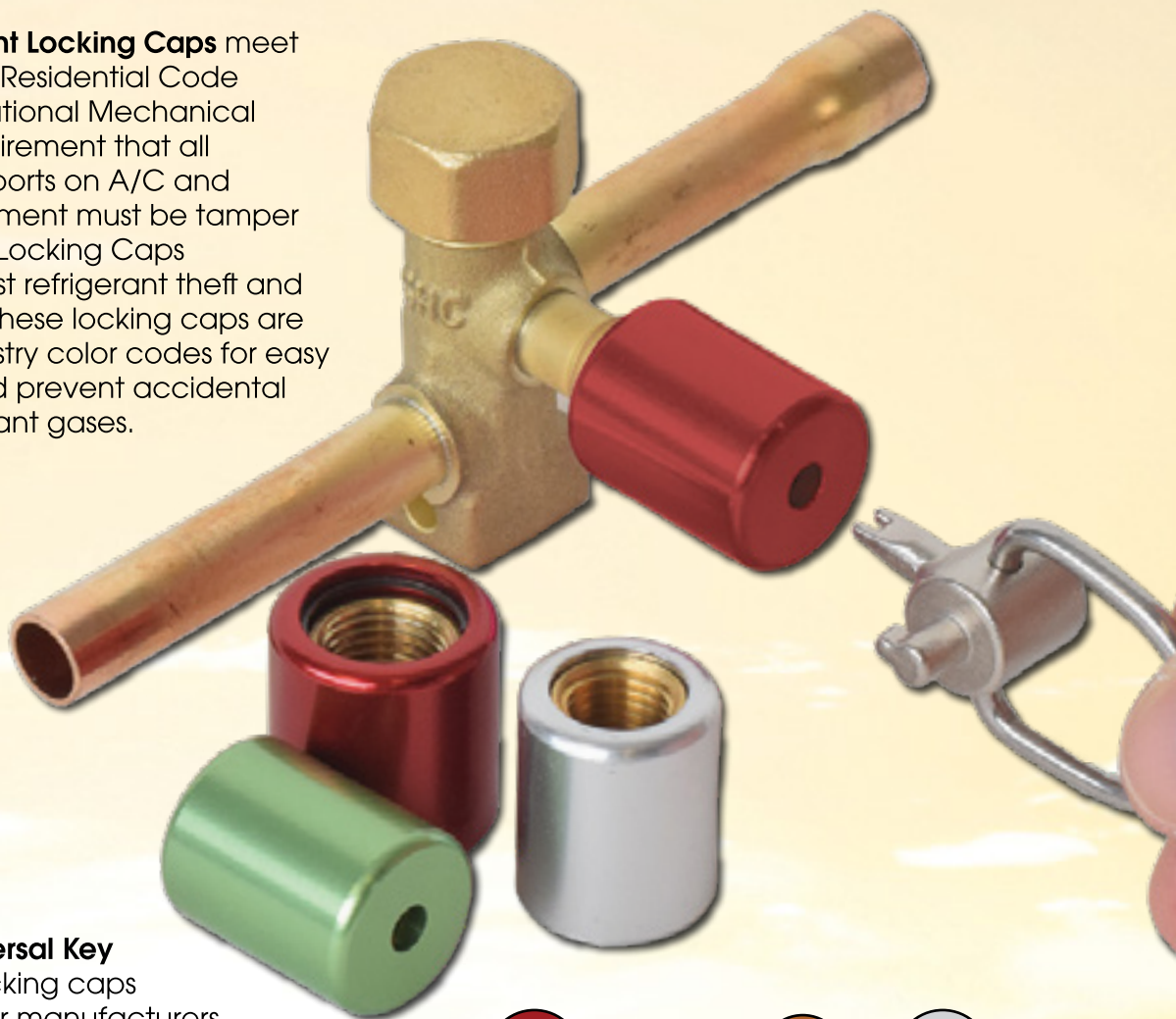

The **Sentry™ Universal Key** fits refrigerant locking caps from all the major manufacturers. It saves time hunting for the right key at the job site. It fits locking caps with these key holes:

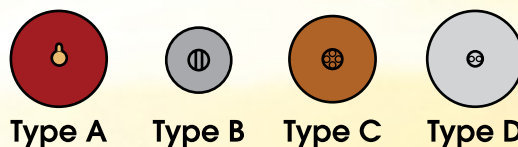

### Code Compliant

Meets the IMC & IRC code requirement.



### Deters Refrigerant Theft

Tamper resistant cap design.

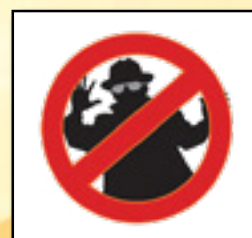

### Weather Proof

Anodized aluminum casing with threaded brass insert.

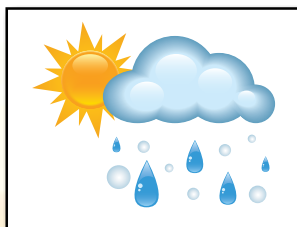

### Universal Key Included

Fits refrigerant locking caps from all major manufacturers.





### Sentry™ Refrigerant Locking Caps - R-410, Red, 1/4"

The Sentry™ Refrigerant Locking Caps are quick and easy way to comply with the IRC and IMC codes requirement that all outdoor access ports on A/C and refrigerant equipment have to be tamper resistant. This cap is anodized in red color for easy identification of R-410 refrigerant. It is designed for 1/4" access ports. An O-ring seal is also pre-installed to prevent leaks.



RSC-RED-02

CATALOG NO.	DESCRIPTION	UOM	ORDER MULTIPLE
RSC-RED-02	Sentry™ Refrigerant Locking Caps - 1/4", Red, 2 pcs Pack	PK	1
RSC-RED-04K	Sentry™ Refrigerant Locking Caps - 1/4", Red, 4 pcs Pack w/1 Universal Key	PK	1
RSC-RED-10	Sentry™ Refrigerant Locking Caps - 1/4", Red, 10 pcs Pack	PK	1
RSC-RED-50K	Sentry™ Refrigerant Locking Caps - 1/4", Red, 50 pcs Pack w/2 Universal Keys	PK	1
RSC-RED-500	Sentry™ Refrigerant Locking Caps - 1/4", Red, 50 pcs Pack w/5 Driver Bits	PK	1

### Sentry™ Refrigerant Locking Caps - R-410, Red, 5/16"

The Sentry™ Refrigerant Locking Caps are quick and easy way to comply with the IRC and IMC codes requirement that all outdoor access ports on A/C and refrigerant equipment have to be tamper resistant. This cap is anodized in red color for easy identification of R-410 refrigerant. It is designed for 5/16" access ports typically used on mini-splits and European styles of A/C systems. An O-ring seal is also pre-installed to prevent leaks.



RSC-RED-02-E

CATALOG NO.	DESCRIPTION	UOM	ORDER MULTIPLE
RSC-RED-02-E	Sentry™ Refrigerant Locking Caps - 5/16", Red, 2 pcs Pack w/ Universal Key	PK	1
RSC-RED-04K-E	Sentry™ Refrigerant Locking Caps - 5/16", Red, 4 pcs Pack w/1 Universal Key	PK	1
RSC-RED-10-E	Sentry™ Refrigerant Locking Caps - 5/16", Red, 10 pcs Pack	PK	1
RSC-RED-50K-E	Sentry™ Refrigerant Locking Caps - 5/16", Red, 50 pcs Pack w/2 Universal Keys	PK	1

### Sentry™ Universal Key for Refrigerant Locking Caps

This Universal Key is not only for DiversiTech's Sentry™ Refrigerant Locking Caps. It has three different keys that is fit to lock and unlock most of the refrigerant locking caps in the market. It is compact and easy to carry. This is the key contractors needed to get the job done!



RSC-TOOL

CATALOG NO.	DESCRIPTION	UOM	ORDER MULTIPLE
RSC-TOOL	Universal Key for Refrigerant Locking Caps	EA	1

### Sentry™ Refrigerant Locking Caps - R-22, Green, 1/4"

The Sentry™ Refrigerant Locking Caps are quick and easy way to comply with the IRC and IMC codes requirement that all outdoor access ports on A/C and refrigerant equipment have to be tamper resistant. This cap is anodized in green color for easy identification of R-22 refrigerant. It is designed for 1/4" access ports. An O-ring seal is also pre-installed to prevent leaks.



RSC-GRN-02

CATALOG NO.	DESCRIPTION	UOM	ORDER MULTIPLE
RSC-GRN-02	Sentry™ Refrigerant Locking Caps - 1/4", Green, 2 pcs Pack	PK	1
RSC-GRN-04K	Sentry™ Refrigerant Locking Caps - 1/4", Green, 4 pcs Pack w/1 Universal Key	PK	1
RSC-GRN-10	Sentry™ Refrigerant Locking Caps - 1/4", Green, 10 pcs Pack	PK	1
RSC-GRN-50K	Sentry™ Refrigerant Locking Caps - 1/4", Green, 50 pcs Pack w/2 Universal Keys	PK	1

### Sentry™ Refrigerant Locking Caps - Universal, Silver, 1/4"

The Sentry™ Refrigerant Locking Caps are quick and easy way to comply with the IRC and IMC codes requirement that all outdoor access ports on A/C and refrigerant equipment have to be tamper resistant. This cap is anodized in silver color and could be used on different types of refrigerants. It is designed for 1/4" access ports. An O-ring seal is also pre-installed to prevent leaks.



RSC-SLV-02

CATALOG NO.	DESCRIPTION	UOM	ORDER MULTIPLE
RSC-SLV-02	Sentry™ Refrigerant Locking Caps - 1/4", Silver, 2 pcs Pack	PK	1
RSC-SLV-04K	Sentry™ Refrigerant Locking Caps - 1/4", Silver, 4 pcs Pack w/1 Universal Key	PK	1
RSC-SLV-10	Sentry™ Refrigerant Locking Caps - 1/4", Silver, 10 pcs Pack	PK	1
RSC-SLV-50K	Sentry™ Refrigerant Locking Caps - 1/4", Silver, 50 pcs Pack w/2 Universal Keys	PK	1
RSC-SLV-500	Sentry™ Refrigerant Locking Caps - 1/4", Silver, 500 pcs Pack w/5 Driver Bits	PK	1



**COPPER FITTINGS**

**Male Adapter C x M**



CATALOG NO.	O.D. SIZE	I.D. SIZE	UOM	ORDER MULTIPLE
<b>C101-0050</b>	5/8" x 1/2"	1/2" x 1/2"	EA	25
<b>C101-0100</b>	7/8" x 3/4"	3/4" x 3/4"	EA	25
<b>C101-0150</b>	1-1/8" x 1"	1" x 1"	EA	10

**Female Adapter C x F**



CATALOG NO.	O.D. SIZE	I.D. SIZE	UOM	ORDER MULTIPLE
<b>C105-0057</b>	5/8" x 3/4"	1/2" x 3/4"	EA	25
<b>C105-0100</b>	7/8" x 3/4"	3/4" x 3/4"	EA	25
<b>C105-0150</b>	1-1/8" x 1"	1" x 1"	EA	10
<b>C105-0215</b>	1-3/8" x 1-1/4"	1-1/4" x 1-1/4"	EA	10

**90 Degree Ell C x C**



CATALOG NO.	O.D. SIZE	I.D. SIZE	UOM	ORDER MULTIPLE
<b>C235-0002</b>	3/8"	1/4"	EA	25
<b>C235-0025</b>	1/2"	3/8"	EA	25
<b>C235-0050</b>	5/8"	1/2"	EA	25
<b>C235-0090</b>	3/4"	5/8"	EA	25
<b>C235-0100</b>	7/8"	3/4"	EA	25
<b>C235-0150</b>	1-1/8"	1"	EA	10
<b>C235-0215</b>	1-3/8"	1-1/4"	EA	10

**90 Degree Long Turn Street Ell Ftg. x C**



CATALOG NO.	O.D. SIZE	I.D. SIZE	UOM	ORDER MULTIPLE
<b>C272-0002</b>	3/8"	1/4"	EA	25
<b>C272-0025</b>	1/2"	3/8"	EA	25
<b>C272-0050</b>	5/8"	1/2"	EA	25
<b>C272-0090</b>	3/4"	5/8"	EA	25
<b>C272-0100</b>	7/8"	3/4"	EA	10
<b>C272-0150</b>	1-1/8"	1"	EA	10
<b>C272-0215</b>	1-3/8"	1-1/4"	EA	10

**90 Degree Street Ell Ftg. x C**



CATALOG NO.	O.D. SIZE	I.D. SIZE	UOM	ORDER MULTIPLE
<b>C254-0002</b>	3/8"	1/4"	EA	25
<b>C254-0100</b>	7/8"	3/4"	EA	25
<b>C254-0150</b>	1-1/8"	1"	EA	10

**45 Degree Ell C x C**



CATALOG NO.	O.D. SIZE	I.D. SIZE	UOM	ORDER MULTIPLE
<b>C290-0002</b>	3/8"	1/4"	EA	25
<b>C290-0025</b>	1/2"	3/8"	EA	25
<b>C290-0050</b>	5/8"	1/2"	EA	25
<b>C290-0090</b>	3/4"	5/8"	EA	25
<b>C290-0100</b>	7/8"	3/4"	EA	25
<b>C290-0150</b>	1-1/8"	1"	EA	10
<b>C290-0215</b>	1-3/8"	1-1/4"	EA	60

90 Degree Long Turn Ell C x C



CATALOG NO.	O.D. SIZE	I.D. SIZE	UOM	ORDER MULTIPLE
C242-0001	1/4"	1/8"	EA	25
C242-0002	3/8"	1/4"	EA	25
C242-0025	1/2"	3/8"	EA	25
C242-0050	5/8"	1/2"	EA	25
C242-0090	3/4"	5/8"	EA	25
C242-0100	7/8"	3/4"	EA	10
C242-0150	1-1/8"	1"	EA	10
C242-0215	1-3/8"	1-1/4"	EA	35
C242-0295	1-5/8"	1-1/2"	EA	25
C242-0390	2-1/8"	2"	EA	12

Coupling (Socket) with Rolled Tube Stop C x C



CATALOG NO.	O.D. SIZE	I.D. SIZE	UOM	ORDER MULTIPLE
C165-0001	1/4"	1/8"	EA	25
C165-0002	3/8"	1/4"	EA	25
C165-0025	1/2"	3/8"	EA	25
C165-0050	5/8"	1/2"	EA	25
C165-0090	3/4"	5/8"	EA	25
C165-0100	7/8"	3/4"	EA	25
C165-0150	1-1/8"	1"	EA	10
C165-0215	1-3/8"	1-1/4"	EA	10
C165-0295	1-5/8"	1-1/2"	EA	60
C165-0390	2-1/8"	2"	EA	40

Reducer Coupling w/Stop C x C



CATALOG NO.	O.D. SIZE	I.D. SIZE	UOM	ORDER MULTIPLE
C165-0007	3/8" x 1/4"	1/4" x 1/8"	EA	25
C165-0032	1/2" x 3/8"	3/8" x 1/4"	EA	25
C165-0058	5/8" x 1/2"	1/2" x 3/8"	EA	25
C165-0093	3/4" x 5/8"	5/8" x 1/2"	EA	25
C165-0094	3/4" x 1/2"	5/8" x 3/8"	EA	25
C165-0107	7/8" x 5/8"	3/4" x 1/2"	EA	25
C165-0149	7/8" x 3/4"	3/4" x 5/8"	EA	25
C165-0159	1-1/8" x 7/8"	1" x 3/4"	EA	10
C165-1498	1-1/8" x 3/4"	1" x 5/8"	EA	10
C165-0222	1-3/8" x 1-1/8"	1-1/4" x 1"	EA	10
C165-0223	1-3/8" x 7/8"	1-1/4" x 3/4"	EA	10
C165-0304	1-5/8" x 1-1/8"	1-1/2" x 1"	EA	10

45 Degree Street Ell Ftg. x C



CATALOG NO.	O.D. SIZE	I.D. SIZE	UOM	ORDER MULTIPLE
C295-0002	3/8"	1/4"	EA	25
C295-0090	3/4"	5/8"	EA	25
C295-0100	7/8"	3/4"	EA	25
C295-0150	1-1/8"	1"	EA	10

Fitting Reducer Coupling Ftg. x C



CATALOG NO.	O.D. SIZE	I.D. SIZE	UOM	ORDER MULTIPLE
C410-0032	1/2" x 3/8"	3/8" x 1/4"	EA	25
C410-0058	5/8" x 1/2"	1/2" x 3/8"	EA	25
C410-0093	3/4" x 5/8"	5/8" x 1/2"	EA	25
C410-0107	7/8" x 5/8"	3/4" x 1/2"	EA	25
C410-0149	7/8" x 3/4"	3/4" x 5/8"	EA	25
C410-0159	1-1/8" x 7/8"	1" x 3/4"	EA	10
C410-0222	1-3/8" x 1-1/8"	1-1/4" x 1"	EA	10

Cap



CATALOG NO.	O.D. SIZE	I.D. SIZE	UOM	ORDER MULTIPLE
C154-0100	7/8"	3/4"	EA	25

**COPPER FITTINGS cont'd**

**U-Type Strap**



CATALOG NO.	O.D. SIZE	I.D. SIZE	UOM	ORDER MULTIPLE
<b>C947-0025</b>	1/2"	3/8"	EA	25
<b>C947-0050</b>	5/8"	1/2"	EA	25
<b>C947-0100</b>	7/8"	3/4"	EA	25
<b>C947-0150</b>	1-1/8"	1"	EA	25
<b>C947-0215</b>	1-3/8"	1-1/4"	EA	100
<b>C947-0295</b>	1-5/8"	1-1/2"	EA	100
<b>C947-0390</b>	2-1/8"	2"	EA	50

**Copper Coupling with No Stop**

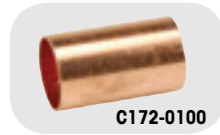

CATALOG NO.	O.D. SIZE	I.D. SIZE	UOM	ORDER MULTIPLE
<b>C172-0090</b>	3/4"	5/8"	EA	25
<b>C172-0100</b>	7/8"	3/4"	EA	25
<b>C172-0150</b>	1-1/8"	1"	EA	10
<b>C172-0215</b>	1-3/8"	1-1/4"	EA	10

**P-Traps**



CATALOG NO.	O.D. SIZE	I.D. SIZE	UOM	ORDER MULTIPLE
<b>C533-0050</b>	5/8	1/2	EA	5
<b>C533-0150</b>	1-1/8	1	EA	3

**Copper Coupling w/Dimple Stop**



CATALOG NO.	O.D. SIZE	I.D. SIZE	UOM	ORDER MULTIPLE
<b>C170-0003</b>	5/16	1/4	EA	25

**Tee C x C x C**



CATALOG NO.	O.D. SIZE	I.D. SIZE	UOM	ORDER MULTIPLE
<b>C460-0002</b>	3/8"	1/4"	EA	25
<b>C460-0025</b>	1/2"	3/8"	EA	25
<b>C460-0050</b>	5/8"	1/2"	EA	25
<b>C460-0090</b>	3/4"	5/8"	EA	25
<b>C460-0100</b>	7/8"	3/4"	EA	10
<b>C460-0150</b>	1-1/8"	1"	EA	10

## ACCESS FITTINGS

A convenient low-cost port for refrigeration servicing. May be installed in any position on either high or low side for charging, purging, quick testing or pressure checking. DiversiTech's access fittings have 1/4" SAE male flare access ports and include a quick seal cap and a stainless and brass special refrigerant valve core.

CATALOG NO.	DESCRIPTION	CONNECTION	QTY PER PACK	UOM	ORDER MULT.
VA-3-346	3 Way Solder Type, pack of 6	For 3/16" O.D. tube or 1/4" and 3/8" solder fitting	6	PK	1
VA-34	Straight Solder Type, pack of 6	3/16" O.D.S. x 1/4" O.D.F.	6	PK	1
VA-46	Straight Solder Type, pack of 6	1/4" O.D.S. x 3/8" O.D.F.	6	PK	1
VA-68	Straight Solder Type, pack of 6	3/8" O.D.S. x 1/2" O.D.F.	6	PK	1
VAU-24	Half Union, pack of 6	1/8" MPT	6	PK	1
VAU-45	Half Union, pack of 6	1/4" MPT	6	PK	1
VAX-2	Extended Copper Tube	1/8" O.D. tube	6	PK	1
VAX-3	Extended Copper Tube	3/16" O.D. x 1/8" I.D.	6	PK	1
VAX-4	Extended Copper Tube	1/4" O.D. x 3/16" I.D.	6	PK	1
VAX-5	Extended Copper Tube	5/16" O.D. x 1/4" I.D.	3	PK	1
VAX-6	Extended Copper Tube	3/8" O.D. x 5/16" I.D.	3	PK	1
VAX-8	Extended Copper Tube	1/2" O.D.	3	PK	1
VS-4	Swivel Nut w/Depressor, pack of 6	1/4" female flare forged swivel nut	6	PK	1
VST-4	Swivel Tee w/Permanent Depressor, pack of 3	1/4" Access on run x 1/4" female flare w/depressor on female swivel branch end	3	PK	1
VST-44	Swivel Tee w/Perm. Depressor, pack of 3	1/4" Access on run x 1/4" access on "T" - female swivel on run	3	PK	1
VTR-24	Threaded Tee, pack of 3	1/8" MPT x 1/4" male flare on run x access on branch	3	PK	1
VTS-10	Solder Tee Type	5/8" O.D. tube	1	EA	1
VTS-12	Solder Tee Type	3/4" O.D. tube	1	EA	1
VTS-14	Solder Tee Type	7/8" O.D. tube	1	EA	1
VTS-46	Solder Tee Type, pack of 3	1/4" O.D.S. x 5/16" O.D.F.	3	PK	1
VTS-56	Solder Tee Type, pack of 3	5/16" O.D.S. x 3/8" O.D.F.	3	PK	1
VTS-68	Solder Tee Type, pack of 3	3/8" O.D.S.	3	PK	1
VTS-810	Solder Tee Type, pack of 3	1/2" O.D.S.	3	PK	1
VC-4	Flare Cap, pack of 12	1/4"	12	PK	1
VC-4R	Flare Cap w/Core Remover, pack of 12	1/4"	12	PK	1
VVC-1	Valve Core, pack of 6		6	PK	1



## Brass Adapters

The MSA-45 is used on the new R410 Mini Split systems that have the larger unique fitting on the service valve. The description of that fitting is 1/2" acme Male-20 UN. This adapter will screw onto the 1/2" Acme Male-20 UN fitting and allow you to connect a standard 1/4" service hose to it.



CATALOG NO.	DESCRIPTION	UOM	ORDER MULTIPLE
MSA-45	1/4" Male flare x 1/2" - 20 UNF Female	EA	1

## Cop-Cap™ Locking Valve Cover

An effective way to discourage and prevent the removal of refrigerant. COP-CAP™ fits this standard service valve on all central AC units and mini-splits. It helps prevent access by unauthorized persons and can only be removed with the included special tool. Simply thread COP-CAP™ assembly onto existing 1/4" flare connection on system and lock set screw in place with hex wrench provided.



- Seals service valve to prevent leaks
- Prevents illegal venting or theft of refrigerant
- Stops unauthorized access in unsecured areas

CATALOG NO.	DESCRIPTION	UOM	ORDER MULTIPLE
VCC-4	Cop-Cap™, Pack of 2	PK	1
VCC-4B	Cop-Cap™ bulk, 100 per case	EA	100

**LINE PIERCING VALVES AND TOOLS**

**Quick-Tap**

Features a valve core in the 1/4" male port. Simply pierce the line and back seat the needle. Flow starts when depressor type charging hose is connected. Flow shuts off automatically when hose is removed. If valve core is not desired, it may be removed. Connect hose, pierce line and back seat needle. This method offers full unrestricted flow. Valve core can be removed or changed at any time without loss of refrigerant if needle is front seated.

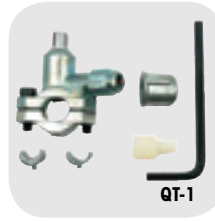

CATALOG NO.	DESCRIPTION	UOM	ORDER MULTIPLE
QT-1	Quick-Tap – 1/4", 5/16", 3/8" O.D. Tube Size	EA	1
QT-2	Quick-Tap – 1/2", 5/8" O.D. Tube Size	EA	1

**Quick-Tap-2**

Identical to Quick-Tap except that a nylon handle replaces the hex wrench. Phillips-head screws are used.



CATALOG NO.	DESCRIPTION	UOM	ORDER MULTIPLE
QTH-1	Quick-Tap-2 – 1/4", 5/16", 3/8" O.D. Tube Size	EA	1
QTH-2	Quick-Tap-2 – 1/2", 5/8" O.D. Tube Size	EA	1

**MAC—The Ultimate in Line Piercing Valves**

Install valve. Connect charging hose. Service. That's all there is to it! MAC features uniport: 1 connection for piercing and servicing. Sealed with refrigerant resistant "O" rings. Needle automatically back seats after servicing, leaving line free of restriction. Connect to tubing with 2 socket-head screws. (Hex wrench is included with each valve.) Needle depressor is inserted into head of needle. Wing cap is turned down easily by hand until line is pierced. Wing cap is removed and system may be serviced with any charging hose with built-in depressor. When hose is removed, spring loaded needle back-seats forming a leak proof seal. Needle depressor is discarded and wing cap forms extra precautionary seal.



CATALOG NO.	DESCRIPTION	UOM	ORDER MULTIPLE
QTM-1	MAC Line Piercing Valve – 1/4", 5/16", 3/8" O.D. Tube Size	EA	36
QTM-2	MAC Line Piercing Valve – 1/2", 5/8" O.D. Tube Size	EA	36

**Insta-Tap Refrigerant Recovery Tool**

The fastest, easiest way to evacuate refrigerant before disposal of a unit. Snaps onto refrigerant line for full and immediate flow. Punctures super large hole for maximum full flow discharge to recovery unit. One tool fits all sizes from 3/16" to 7/8" O.D. hard tubing. Replaceable needle.



CATALOG NO.	DESCRIPTION	UOM	ORDER MULTIPLE
QT-100	Quick-Tap-2 – 1/4", 5/16", 3/8" O.D. Tube Size	EA	1
QT-100N	Replaceable Hardened Steel Needle and Gasket	EA	1
QT-100G	Replacement Gasket Only	EA	3

**Core Storer**

All steel valve core remover and storage container. Completely knurled for easier grip, eliminating slippage when using with oily or greasy hands. Core Storer features a compartment for storing extra valve cores. Four replacement cores are included with each tool.



CATALOG NO.	DESCRIPTION	UOM	ORDER MULTIPLE
VCR-1	Core Remover and Storer	EA	1

**Copper Saddle Valve**

For copper-to-copper brazing. Penetrates line in one easy operation with no holes to drill. Steel pin with valve core pierces line and is locked into valve body by tightening cap. Teflon ring assures positive seal. Available in sizes from 1/4" to 1-1/8".



CATALOG NO.	DESCRIPTION	UOM	ORDER MULTIPLE
VLC-4	Copper Saddle Valve – 1/4" O.D. Tube Size, pack of 6	PK	1
VLC-5	Copper Saddle Valve – 5/16" O.D. Tube Size, pack of 6	PK	1
VLC-6	Copper Saddle Valve – 3/8" O.D. Tube Size, pack of 6	PK	1
VLC-8	Copper Saddle Valve – 1/2" O.D. Tube Size, pack of 4	PK	1
VLC-10	Copper Saddle Valve – 5/8" O.D. Tube Size, pack of 3	PK	1
VLC-12	Copper Saddle Valve – 3/4" O.D. Tube Size, pack of 2	PK	1
VLC-18	Copper Saddle Valve – 1-1/8" O.D. Tube Size, pack of 2	PK	1
VLC-25	Additional Teflon Rings, pack of 25	PK	1

**Core Removal Tool**

Designed to remove and replace valve cores without losing the refrigerant charge. Connects to any 1/4" male flare fitting. Saves time, saves refrigerant.



CATALOG NO.	DESCRIPTION	UOM	ORDER MULTIPLE
VCR-1	Core Removal Tool	EA	1

## BRASS FITTINGS

### Compression Sleeve



D60A-4

CATALOG NO.	DESCRIPTION	UOM	ORDER MULTIPLE
D60A-4	1/4" Compression Sleeve	EA	100
D60A-8	1/2" Compression Sleeve	EA	100
D60A-10	5/8" Compression Sleeve	EA	100

### Compression Connector



D68A-4B

CATALOG NO.	DESCRIPTION	UOM	ORDER MULTIPLE
D68A-4B	1/4" x 1/4" Compression Connector	EA	10
D68A-6C	3/8" x 3/8" Compression Connector	EA	10

### Compression Nut



D61A-8

CATALOG NO.	DESCRIPTION	UOM	ORDER MULTIPLE
D61A-4	1/4" Compression Nut	EA	10
D61A-8	1/2" Compression Nut	EA	10

### Compression Elbow



D69A-8D

CATALOG NO.	DESCRIPTION	UOM	ORDER MULTIPLE
D69A-4A	1/4" x 1/8" Compression Elbow	EA	10
D69A-8D	1/2" x 1/2" Compression Elbow	EA	10

### Compression Union



D62A-66

CATALOG NO.	DESCRIPTION	UOM	ORDER MULTIPLE
D62A-44	1/4" Compression Union	EA	10
D62A-66	3/8" Compression Union	EA	10
D62A-88	1/2" Compression Union	EA	10
D62A-1010	5/8" Compression Union	EA	10

### Compression Tee



D64A-88

CATALOG NO.	DESCRIPTION	UOM	ORDER MULTIPLE
D64A-44	1/4" Compression Tee	EA	10
D64A-66	3/8" Compression Tee	EA	10
D64A-88	1/2" Compression Tee	EA	10
D64A-1010	5/8" Compression Tee	EA	10

### Flare x MIP Elbow



DE1-6C

CATALOG NO.	DESCRIPTION	UOM	ORDER MULTIPLE
DE1-4B	1/4" Flare x 1/4" MIP Elbow	EA	10
DE1-6C	3/8" Flare x 3/8" MIP Elbow	EA	10
DE1-8D	1/2" Flare x 1/2" MIP Elbow	EA	10

### Flare x MIP Reducing Elbow



DE1-6B

CATALOG NO.	DESCRIPTION	UOM	ORDER MULTIPLE
DE1-6B	3/8" Flare x 1/4" MIP Reducing Elbow	EA	10
DE1-6D	3/8" Flare x 1/2" MIP Reducing Elbow	EA	10
DE1-8E	1/2" Flare x 3/4" MIP Reducing Elbow	EA	10
DE1-10D	5/8" Flare x 1/2" MIP Reducing Elbow	EA	10

**BRASS FITTINGS cont'd**

**Short Nut**



CATALOG NO.	DESCRIPTION	UOM	ORDER MULTIPLE
<b>DN1-3</b>	3/16" Short Nut	EA	10
<b>DN1-4</b>	1/4" Short Nut	EA	10
<b>DN1-6</b>	3/8" Short Nut	EA	10
<b>DN1-10</b>	5/8" Short Nut	EA	10

**Flare Tee**



CATALOG NO.	DESCRIPTION	UOM	ORDER MULTIPLE
<b>DT2-4</b>	1/4" Flare Tee	EA	10
<b>DT2-6</b>	3/8" Flare Tee	EA	10
<b>DT2-8</b>	1/2" Flare Tee	EA	10
<b>DT2-10</b>	5/8" Flare Tee	EA	5

**Cap**



CATALOG NO.	DESCRIPTION	UOM	ORDER MULTIPLE
<b>DN5-4</b>	1/4" Cap	EA	10
<b>DN5-6</b>	3/8" Cap	EA	10

**Flare x MIP Union**

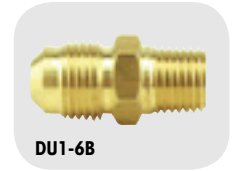

CATALOG NO.	DESCRIPTION	UOM	ORDER MULTIPLE
<b>DU1-4B</b>	1/4" Flare x 1/4" MIP Union	EA	10
<b>DU1-6B</b>	3/8" Flare x 1/4" MIP Union	EA	10
<b>DU1-6C</b>	3/8" Flare x 3/8" MIP Union	EA	10
<b>DU1-6D</b>	3/8" Flare x 1/2" MIP Union	EA	10
<b>DU1-6E</b>	3/8" Flare x 3/4" MIP Union	EA	10
<b>DU1-8B</b>	1/2" Flare x 1/4" MIP Union	EA	10
<b>DU1-8D</b>	1/2" Flare x 1/2" MIP Union	EA	10
<b>DU1-8E</b>	1/2" Flare x 3/4" MIP Union	EA	10
<b>DU1-10D</b>	5/8" Flare x 1/2" MIP Union	EA	10
<b>DU1-10E</b>	5/8" Flare x 3/4" MIP Union	EA	10
<b>DU1-12D</b>	3/4" Flare x 1/2" MIP Union	EA	10

**Short Forged Flare Nut**



CATALOG NO.	DESCRIPTION	UOM	ORDER MULTIPLE
<b>DNS4-4</b>	1/4" Short Forged Flare Nut	EA	10
<b>DNS4-6</b>	3/8" Short Forged Flare Nut	EA	10
<b>DNS4-8</b>	1/2" Short Forged Flare Nut	EA	10
<b>DNS4-10</b>	5/8" Short Forged Flare Nut	EA	10
<b>DNS4-12</b>	3/4" Short Forged Flare Nut	EA	10
<b>DNS4-14</b>	7/8" Short Forged Flare Nut	EA	5

**Flare Union**

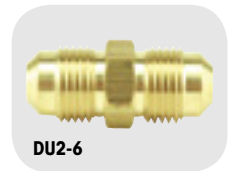

CATALOG NO.	DESCRIPTION	UOM	ORDER MULTIPLE
<b>DU2-4</b>	1/4" Flare Union	EA	10
<b>DU2-6</b>	3/8" Flare Union	EA	10
<b>DU2-8</b>	1/2" Flare Union	EA	10
<b>DU2-10</b>	5/8" Flare Union	EA	10
<b>DU2-12</b>	3/4" Flare Union	EA	10

**Plug**



CATALOG NO.	DESCRIPTION	UOM	ORDER MULTIPLE
<b>DP2-4</b>	1/4" Plug	EA	10
<b>DP2-6</b>	3/8" Plug	EA	10
<b>DP2-8</b>	1/2" Plug	EA	10
<b>DP2-10</b>	5/8" Plug	EA	10



**Flare x FIP Union**



CATALOG NO.	DESCRIPTION	UOM	ORDER MULTIPLE
<b>DU3-6D</b>	3/8" x 1/2" Flare x FIP Union	EA	10
<b>DU3-10E</b>	5/8" x 3/4" Flare x FIP Union	EA	10

**Flare x Flare Swivel Union**

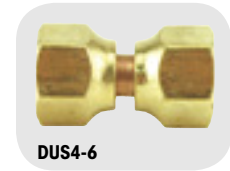

CATALOG NO.	DESCRIPTION	UOM	ORDER MULTIPLE
<b>DUS4-4</b>	1/4" Flare x 1/4" Flare Swivel Union	EA	10
<b>DUS4-6</b>	3/8" Flare x 3/8" Flare Swivel Union	EA	10

**CUSHION CLAMPS**

**Cushion Clamps**

An industry standard universal clamp that mounts to standard strut. Steel with electro-dichromate finish to resist corrosion. The lock nut has a nylon insert for a positive lock. The polymeric grommet withstands temperatures from -25°C to 125°C and resists the effects of most oils, chemicals, and industrial cleaning compounds.



CATALOG NO.	DESCRIPTION	UOM	ORDER MULTIPLE
<b>538-1/4</b>	Cushion Clamp – 1/4"	EA	25
<b>538-3/8</b>	Cushion Clamp – 3/8"	EA	25
<b>538-1/2</b>	Cushion Clamp – 1/2"	EA	25
<b>538-5/8</b>	Cushion Clamp – 5/8"	EA	25
<b>538-3/4</b>	Cushion Clamp – 3/4"	EA	25
<b>538-7/8</b>	Cushion Clamp – 7/8"	EA	25
<b>538-1-1/8</b>	Cushion Clamp – 1-1/8"	EA	10
<b>538-1-3/8</b>	Cushion Clamp – 1-3/8"	EA	10
<b>538-1-5/8</b>	Cushion Clamp – 1-5/8"	EA	10
<b>538-2-1/8</b>	Cushion Clamp – 2-1/8"	EA	10
<b>538-2-5/8</b>	Cushion Clamp – 2-5/8"	EA	10
<b>538-3-1/8</b>	Cushion Clamp – 3-1/8"	EA	10
<b>538-4-1/8</b>	Cushion Clamp – 4-1/8"	EA	10

**DRIERS, SIGHT GLASSES**

**Liquid Line Driers**

High moisture and acid capacity. Maximum filtration capacity. Exceptional compatibility with new polyester oils. Compatible with all existing and new refrigerants and blends including 134a, 401A/B, 402A/B, 404A, 407A/B/C, 410A, 502, 507A. Spring loaded, molecular sieve XH-9 desiccant. Solid copper sweat fittings. Powder paint exterior coating surpasses 500 hour ASTM salt spray test and resists corrosion. Eliminates concern of additive stripping.



**DAD052**

CATALOG NO.	VIRGINIA KMP	CONNECTION	CUBIC INCH	UOM	ORDER MULTIPLE
<b>DAD032</b>	WLD-032 FLARE	1/4	3	EA	1
<b>DAD032S</b>	WLD-032 SWEAT	1/4	3	EA	1
<b>DAD052</b>	WLD-052 FLARE	1/4	5	EA	1
<b>DAD052S</b>	WLD-052 SWEAT	1/4	5	EA	1
<b>DAD053S</b>	WLD-053 SWEAT	3/8	5	EA	1
<b>DAD082</b>	WLD-082 FLARE	1/4	8	EA	1
<b>DAD082S</b>	WLD-082 SWEAT	1/4	8	EA	1
<b>DAD083S</b>	WLD-083 SWEAT	3/8	8	EA	1
<b>DAD084S</b>	WLD-084 SWEAT	1/2	8	EA	1
<b>DAD163</b>	WLD-163 FLARE	3/8	16	EA	1
<b>DAD163S</b>	WLD-163 SWEAT	3/8	16	EA	1
<b>DAD164S</b>	WLD-164 SWEAT	1/2	16	EA	1
<b>DAD303</b>	WLD303 FLARE	3/8	30	EA	1
<b>DAD303S</b>	WLD-303 SWEAT	3/8	30	EA	1
<b>DAD304S</b>	WLD-304 SWEAT	1/2	30	EA	1
<b>DAD305</b>	WLD-305 FLARE	5/8	30	EA	1

**Suction Line Driers**

The solid-core clean-up dryer was developed for use in a system suction line. The compact design incorporates a large outside diameter shell, which results in a shorter lay-in length, and a larger core, which provides a greater filtration area for maximum operating efficiency. The core material has controlled porosity which effectively removes and holds a maximum amount of contaminants with a minimum of pressure drop. It collects and holds inorganic acids and other harmful contaminants from a motor burnout. This binding process protects the core from acid decomposition. Access valves on both the inlet and outlet sides make it easy to measure pressure accurately. Occasionally, enough contaminant matter may collect in the filter core to cause a slight pressure drop. The access valves on the SLD make it easy to determine if a pressure drop exists and to measure the amount of the drop. The original DSLD, solid core, XH-9 molecular sieve desiccant suction line filter dryer. High acid capacity. Low pressure drop – exceptionally high flow rates. Designed for system clean-up. 500 hours salt spray protection. Shortest system cut-out lengths allow installation in tight areas. Two access valves simplify pressure drop measurement. Flare or solid copper sweat fittings.



**DSL13-5SVHH**

CATALOG NO.	VIRGINIA KMP	CONNECTION	CUBIC INCH	UOM	ORDER MULTIPLE
<b>DSL13-5SVHH</b>	AL-24-55C Sweat	5/8	13	EA	1
<b>DSL13-6SVHH</b>	AL-30-6SC Sweat	3/4	13	EA	1
<b>DSL27-7SVHH</b>	AL-30-7SC Sweat	7/8	27	EA	1
<b>DSL27-9SVHH</b>	AL-44-9SC Sweat	1-1/8	27	EA	1
<b>DSL54-11SVHH</b>	AL-75-11SC Sweat	1-3/8	54	EA	1

**Universal Spun Copper Driers**

Manufactured with the latest generation molecular sieves compatible with more than 20 different types of refrigerants, including R-134A. They can be used in all hermetic and open refrigeration systems using CFC, HCFC and HFC gases and mixes such as commercial and domestic refrigerators, freezers and air conditioners ranging from 1/8 to 2.0 HP. Hermetically sealed with extended ends.

CATALOG NO.	OUTLET	INLET	DIAMETER	LENGTH GRAMS	DESSICANT R12	RECOMM. R22	TONNAGE QUANTITY	UOM	ORDER MULTIPLE
<b>DX-3</b>	1/4"	1/4"	3/4"	7-11/16"	10	1/3	1/2	EA	24
<b>DX-4</b>	Multiple	1/4"	1"	9"	18	3/4	1-1/2	EA	1
<b>DXA-5</b>	1/4"	1/4"	1"	9-1/4"	20	3/4	1-1/2	EA	1



**Bi Flow Driers**

The "DBF" Series is designed specifically for heat pump or reverse cycle application. External check valves are not required since they are incorporated within the filter dryer shell. The core design filters out contaminant particles down to 25 microns. 100% copper sweat or nickel plated flare fittings. Desiccant core provides reliable and effective, removal of solid contaminants, acid and moisture. Provides three times the filtration as the standard bi-flow. Core is cushioned in fiber gaskets to protect core and to insure trouble-free performance. Powder paint exterior coating surpasses 500 hour ASTM salt spray test and resists corrosion.



CATALOG NO.	VIRGINIA KMP	CONNECTION	CUBIC INCH	UOM	ORDER MULTIPLE
<b>DBF083S</b>	V2A-083 Sweat	3/8	8	EA	1
<b>DBF084S</b>	V2A-084 Sweat	1/2	8	EA	1
<b>DBF163</b>	V2A-163 Flare	3/8	16	EA	1
<b>DBF163S</b>	V2A-163 Sweat	3/8	16	EA	1
<b>DBF164S</b>	V2A-164 Sweat	1/2	16	EA	1
<b>DBF165S</b>	V2A-165S Sweat	5/8	16	EA	1

**Sight Glasses**

Sight Glass and Moisture Indicator provides a quick visual diagnosis of refrigerant and moisture levels within a system. The sight glass indicates if the system has the proper refrigerant level, a restricted dryer or excessive pressure-drop. The moisture indicator recognizes moisture within the system. Provides early warning that a potential failure exists resulting in corrosion, chemical damage, restricted flow, or even compressor failure. Etch-resistant glass with a simple color comparison provides easy viewing and quick diagnostics. Flare models feature forged brass body and fittings for corrosion resistance. Sweat models feature copper fittings to permit solder installation without disassembly. Leak-proof design is compact and short in length to easily fit within a unit and provide accuracy in performance.



CATALOG NO.	VIRGINIA KMP	DESCRIPTION	CONNECTION	UOM	ORDER MULTIPLE
<b>DPSG-3MF</b>	LDE-3-MF	MALE/FEMALE	3/8	EA	1
<b>DPSG-4MF</b>	LDE-4-MF	MALE/FEMALE	1/2	EA	1
<b>DPSG-2S</b>	LDE-2-S	SWEAT	1/4	EA	1
<b>DPSG-3S</b>	LDE-3-S	SWEAT	3/8	EA	1

**REFRIGERANT CHARGING**

**Insta-Charge**

Faster, safer and more economical method for charging LIQUID refrigerant through the low pressure side of an air conditioning or refrigeration system, without damaging the compressor. Insta-Charge's unique internal restrictor reduces liquid flow to a level below the capacity of the compressor. Converts liquid refrigerant to a saturated vapor for fast entry. Insta-Charge connects directly to the refrigerant can or cylinder valve. Adds liquid tracing dye faster. Eliminates heating of refrigerant cylinder. Made of light weight aluminum. Sold at a fraction of the cost of other fast charging devices.



CATALOG NO.	DESCRIPTION	UOM	ORDER MULTIPLE
<b>RC-1</b>	Insta-Charge	EA	1

**REFRIGERANT TUBING**

**DiversiTech Line Sets**

DiversiTech Line Sets are individually packaged in sturdy corrugated cardboard, designed and tested for individual parcel shipment.

Line Sets are designed for air conditioning and refrigeration systems. The copper tube is refrigeration grade tubing to ASTM B280. The suction line is pre-insulated with Armaflex AP pipe insulation. This insulation is a black flexible elastomeric thermal insulation. The expanded closed-cell structure makes it an efficient insulation. It is manufactured without the use of CFC's, HFC's or HCFC's. AP Armaflex contains Microban® antimicrobial product protection for added defense against mold on the

insulation. DiversiTech Min-Split Line Sets are similar to Standard Line Sets but come with additional insulation on the liquid line and flared line ends. Copper tubing complies with ASTM B280 for Seamless Copper Tube for ACR.

AP Armaflex insulation meets ASTM C534, Type I – Tubular Grade 1, ASTM E84, NFPA 255, UL723, CAN/ULC S102, UL94 5V-5A, V-0 (E55798), NFPA 90A/90B, UL181, ASTM G21/C1338, ASTM G22, ASTM D1056 2B1, MIL-P-15280J form T, MIL-C-3133C grade SBE3, MEA 96-85-M, and City of LA RR7642.



**D40680250B3B6**

**STANDARD LINE SETS**

CATALOG NO.	LENGTH (FT)	INSULATION WALL	SUCTION LINE	LIQUID LINE	UOM	ORDER MULTIPLE
D61220250	25	1/2	3/4	3/8	EA	1
D61220300	30	1/2	3/4	3/8	EA	1
D61220350	35	1/2	3/4	3/8	EA	1
D61220400	40	1/2	3/4	3/8	EA	1
D61220500	50	1/2	3/4	3/8	EA	1
D61230250	25	3/4	3/4	3/8	EA	1
D61230400	40	3/4	3/4	3/8	EA	1
D61230500	50	3/4	3/4	3/8	EA	1
D61280250	25	3/8	3/4	3/8	EA	1
D61280300	30	3/8	3/4	3/8	EA	1
D61280350	35	3/8	3/4	3/8	EA	1
D61280400	40	3/8	3/4	3/8	EA	1
D61280500	50	3/8	3/4	3/8	EA	1
D61420250	25	1/2	7/8	3/8	EA	1
D61420300	30	1/2	7/8	3/8	EA	1
D61420350	35	1/2	7/8	3/8	EA	1
D61420400	40	1/2	7/8	3/8	EA	1
D61420500	50	1/2	7/8	3/8	EA	1
D61430300	30	3/4	7/8	3/8	EA	1
D61430350	35	3/4	7/8	3/8	EA	1
D61430400	40	3/4	7/8	3/8	EA	1
D61430500	50	3/4	7/8	3/8	EA	1
D61480250	25	3/8	7/8	3/8	EA	1
D61480300	30	3/8	7/8	3/8	EA	1
D61480350	35	3/8	7/8	3/8	EA	1
D61480400	40	3/8	7/8	3/8	EA	1
D61480500	50	3/8	7/8	3/8	EA	1
D61820250	25	3/8	1-1/8	1/2	EA	1
D61820500	50	3/8	1-1/8	1/2	EA	1
D61830250	25	3/4	1-1/8	3/8	EA	1
D61830300	30	3/4	1-1/8	3/8	EA	1
D61830350	35	3/4	1-1/8	3/8	EA	1
D61830400	40	3/4	1-1/8	3/8	EA	1
D61880250	25	3/8	1-1/8	3/8	EA	1
D61880300	30	3/8	1-1/8	3/8	EA	1
D61880400	40	3/8	1-1/8	3/8	EA	1
D61880500	50	3/8	1-1/8	3/8	EA	1

**MINI-SPLIT LINE SETS**

CATALOG NO.	LENGTH (FT)	INSULATION WALL	SUCTION LINE	LIQUID LINE	UOM	ORDER MULTIPLE
D40680250B3B6	25	3/8	3/8	1/4	EA	1
D40680350B3B6	35	3/8	3/8	1/4	EA	1
D40680500B3B6	50	3/8	3/8	1/4	EA	1
D40880250B3B6	25	3/8	1/2	1/4	EA	1
D40880350B3B6	35	3/8	1/2	1/4	EA	1
D40880500B3B6	50	3/8	1/2	1/4	EA	1
D41080250B3B6	25	3/8	5/8	1/4	EA	1
D41080350B3B6	35	3/8	5/8	1/4	EA	1
D41080500B3B6	50	3/8	5/8	1/4	EA	1
D61080250B3B6	25	3/8	5/8	3/8	EA	1
D61080350B3B6	35	3/8	5/8	3/8	EA	1
D61080500B3B6	50	3/8	5/8	3/8	EA	1
D40620250B3B6	25	1/2	3/8	1/4	EA	1
D40620350B3B6	35	1/2	3/8	1/4	EA	1
D40620500B3B6	50	1/2	3/8	1/4	EA	1
D40820250B3B6	25	1/2	1/2	1/4	EA	1
D40820350B3B6	35	1/2	1/2	1/4	EA	1
D40820500B3B6	50	1/2	1/2	1/4	EA	1
D41020250B3B6	25	1/2	5/8	1/4	EA	1
D41020350B3B6	35	1/2	5/8	1/4	EA	1
D41020500B3B6	50	1/2	5/8	1/4	EA	1
D61020250B3B6	25	1/2	5/8	3/8	EA	1
D61020350B3B6	35	1/2	5/8	3/8	EA	1
D61020500B3B6	50	1/2	5/8	3/8	EA	1

*If ordering by pallet, 15 line sets are packed per pallet.*

**LineSet Box™**

The NEW LINESET BOX™ is a rough-in box for new construction line set protection for all types of HVAC installations. The architecturally pleasing and professional looking LINESET BOX is easy to install and provides superior protection of refrigerant line sets and condensate drain lines. Provides a clean termination point for new construction projects and reserves the bay for the HVAC system installation. The LINESET BOX also protects the lineset from damage during construction. It helps to eliminate damage such as kinks that can drastically increase HVAC installation time.



**LSB10-W**

CATALOG NO.	DESCRIPTION	UOM	ORDER MULTIPLE
LSB10-W	LINESET BOX™ - White	EA	1
LSB10-BL	LINESET BOX™ - Black	EA	1

### White Pipe™

White Pipe pre-insulated refrigerant line is ideal for a variety of installation jobs and works for every air conditioning application including ductless mini-split, heat pump and centralized air ducted units. Available in a variety of sizes and lengths.



CATALOG NO.	DESCRIPTION	UOM	ORDER MULTIPLE
<b>WP1214-50</b>	White Pipe, 1/4 x 1/2 in x 50 ft	EA	13
<b>WP1238-50</b>	White Pipe, 3/8 x 1/2 in x 50 ft	EA	11
<b>WP1212-50</b>	White Pipe, 1/2 x 1/2 in x 50 ft	EA	10
<b>WP1258-50</b>	White Pipe, 5/8 x 1/2 in x 50 ft	EA	7
<b>WP1234-50</b>	White Pipe, 3/4 x 1/2 in x 50 ft	EA	5
<b>WP1278-50</b>	White Pipe, 7/8 x 1/2 in x 50 ft	EA	5
<b>WP1214-164</b>	White Pipe, 1/4 x 1/2 in x 164 ft	EA	5
<b>WP1238-164</b>	White Pipe, 3/8 x 1/2 in x 164 ft	EA	4
<b>WP1212-164</b>	White Pipe, 1/2 x 1/2 in x 164 ft	EA	4
<b>WP1258-164</b>	White Pipe, 5/8 x 1/2 in x 164 ft	EA	3
<b>WP1234-82</b>	White Pipe, 3/4 x 1/2 in x 82 ft	EA	3
<b>WP1278-82</b>	White Pipe, 7/8 x 1/2 in x 82 ft	EA	3

### Flexible Refrigerant Line

Flexible Refrigerant Line, with installed flare nut, allows a kink-free connection from the mini-split wall unit to the lineset for easier and faster installation.



CATALOG NO.	DESCRIPTION	UOM	ORDER MULTIPLE
<b>FRL14-F</b>	Flexible Refrigerant Line – 1/4 in. x 36"	EA	15
<b>FRL38-F</b>	Flexible Refrigerant Line – 3/8 in. x 36"	EA	14
<b>FRL12-F</b>	Flexible Refrigerant Line – 1/2 in. x 36"	EA	11
<b>FRL58-F</b>	Flexible Refrigerant Line – 5/8 in. x 36"	EA	10

### REFRIGERANT LABELS

#### DiversiTech Refrigerant ID Labels

These 3" x 4" self-adhesive vinyl labels use a high-tack acrylic adhesive and UV cured screen printing. Color coded to conform to refrigerant labeling convention. Each label indicates the type of refrigerant (eg. R-11), the chemical name (eg. Trichloromonofluoromethane) and the UN No. (eg. UN 1078). Avoid costly mistakes by properly identifying the type of refrigerant contained in recovery cylinders and air conditioning and refrigeration equipment.

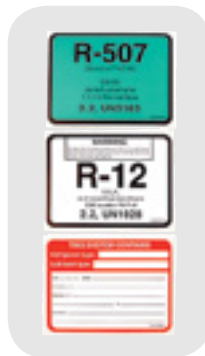

CATALOG NO.	DESCRIPTION	UOM	ORDER MULTIPLE
<b>REFRIGERANT IDENTIFICATION LABELS (3" x 4")</b>			
<b>04022</b>	R-22 Refrigerant ID Labels, pack of 10	PK	1
<b>04134</b>	R-134a Refrigerant ID Labels, pack of 10	PK	1
<b>04404</b>	R-404A (HP62/FX70) Refrigerant ID Labels, pack of 10	PK	1
<b>04407</b>	R-407C (SUVA 9000/KLEA 66) Refrigerant ID Labels, pack of 10	PK	1
<b>04410</b>	R-410A (AZ20) Refrigerant ID Labels, pack of 10	PK	1
<b>SYSTEM REFRIGERANT/OIL LABELS (3" x 4")</b>			
<b>04850</b>	Refrigerant Removed Labels, pack of 10	PK	1

**REFRIGERANT RECOVERY PRODUCTS**

**Refrigerant Recovery Cylinders**

DOT Classified for recovery, recycling, service and reclaim. Liquid and vapor valves ("Y" valve or separate valve configurations) are installed in all cylinders. Painted yellow/gray per ARI guidelines. Float switches have 3-pin Brad Harrison connectors.

CATALOG NO.	DESCRIPTION	DOT CLASS	3/4" NPT PLUG	FLOAT SWITCH	WATER CAP.	TARE WT.	UOM	ORDER MULTIPLE
<b>02033</b>	30 lb.	4BA400	YES	NO	26.2 lbs.	17 lbs.	EA	1
<b>02053</b>	50 lb.	4BA400	YES	NO	47.7 lbs.	28 lbs.	EA	1
<b>02100</b>	100 lb.	4BW400	NO	NO	123 lbs.	48 lbs.	EA	1
<b>02255</b>	250 lb.	4BW260	YES	NO	239 lbs.	85 lbs.	EA	1



**Caution:** Never overfill cylinders. Maximum refrigerant capacity is limited to 80% of the water capacity of the cylinder in lbs. (see table above). DOT requires cylinders to be retested every five years. Some recovery equipment uses weight scales to cut off refrigerant fill at 80% of capacity. Be sure cylinder tare weight is correct for this type of equipment.

**DOT Classification Example:** 4BA400: 400 psi working pressure; 800 psi test pressure (double the working pressure); 1,600 psi minimum burst pressure (double the test pressure). Pressure relief/safety valve is set to release at between 75-100% of the test pressure. For example, in the 4BA400 tanks which have a 800 psi test pressure, the relief valve opens at between 600 psi and 800 psi.

**TUBING INSULATION**

**Tubeing Insulation**

Highest quality tubing insulation by Armacell. AC Accoflex® tubing insulation is a flexible rubber product from the inventors of elastomeric foam insulation. It is designed exclusively for HVAC, with a tough surface and excellent resistance to ultraviolet damage, condensation and mold.



**3/8" WALL**

CATALOG NO.	DESCRIPTION	TOTAL FEET	UOM	ORDER MULTIPLE
<b>7-3838</b>	3/8" ID x 3/8" Wall, pack of 100,	600'	PK	1
<b>7-3812</b>	1/2" ID x 3/8" Wall, pack of 80	480'	PK	1
<b>7-3858</b>	5/8" ID x 3/8" Wall, pack of 65	390'	PK	1
<b>7-3834</b>	3/4" ID x 3/8" Wall, pack of 55	330'	PK	1
<b>7-3878</b>	7/8" ID x 3/8" Wall, pack of 45	270'	PK	1
<b>7-381-18</b>	1-1/8" ID x 3/8" Wall, pack of 35	210'	PK	1
<b>7-381-38</b>	1-3/8" ID x 3/8" Wall, pack of 30	180'	PK	1
<b>7-381-58</b>	1-5/8" ID x 3/8" Wall, pack of 20	120'	PK	1
<b>7-382-18</b>	2-1/8" ID x 3/8" Wall, pack of 16	96'	PK	1
<b>7-382-58</b>	2-5/8" ID x 3/8" Wall, pack of 12	72'	PK	1

**3/4" WALL**

CATALOG NO.	DESCRIPTION	TOTAL FEET	UOM	ORDER MULTIPLE
<b>7-3438</b>	3/8" ID x 3/4" Wall, pack of 40	240'	PK	1
<b>7-3412</b>	1/2" ID x 3/4" Wall, pack of 35	210'	PK	1
<b>7-3458</b>	5/8" ID x 3/4" Wall, pack of 24	144'	PK	1
<b>7-3434</b>	3/4" ID x 3/4" Wall, pack of 23	138'	PK	1
<b>7-3478</b>	7/8" ID x 3/4" Wall, pack of 20	120'	PK	1
<b>7-341-18</b>	1-1/8" ID x 3/4" Wall, pack of 15	90'	PK	1
<b>7-341-58</b>	1-5/8" ID x 3/4" Wall, pack of 10	60'	PK	1
<b>7-342-18</b>	2-1/8" ID x 3/4" Wall, pack of 9	54'	PK	1
<b>7-342-58</b>	2-5/8" ID x 3/4" Wall, pack of 8	48'	PK	1

**1/2" WALL**

CATALOG NO.	DESCRIPTION	TOTAL FEET	UOM	ORDER MULTIPLE
<b>7-1238</b>	3/8" ID x 1/2" Wall, pack of 75	450'	PK	1
<b>7-1212</b>	1/2" ID x 1/2" Wall, pack of 66	396'	PK	1
<b>7-1258</b>	5/8" ID x 1/2" Wall, pack of 50	300'	PK	1
<b>7-1234</b>	3/4" ID x 1/2" Wall, pack of 40	240'	PK	1
<b>7-1278</b>	7/8" ID x 1/2" Wall, pack of 35	210'	PK	1
<b>7-121-18</b>	1-1/8" ID x 1/2" Wall, pack of 25	150'	PK	1
<b>7-121-38</b>	1-3/8" ID x 1/2" Wall, pack of 20	120'	PK	1
<b>7-121-58</b>	1-5/8" ID x 1/2" Wall, pack of 15	90'	PK	1
<b>7-122-18</b>	2-1/8" ID x 1/2" Wall, pack of 10	60'	PK	1
<b>7-122-58</b>	2-5/8" ID x 1/2" Wall, pack of 10	60'	PK	1
<b>7-123-18</b>	3-1/8" ID x 1/2" Wall, pack of 7	42'	PK	1

**1" WALL**

CATALOG NO.	DESCRIPTION	TOTAL FEET	UOM	ORDER MULTIPLE
<b>7-1058</b>	5/8" ID x 1" Wall, pack of 20	120'	PK	1
<b>7-1078</b>	7/8" ID x 1" Wall, pack of 15	90'	PK	1



# RAPID POSITIONING CLIPS

The RPC line of mounting clips are very cost effective and time saving solutions for refrigeration, A/C tubing, PEX piping, conduits and cabling support. Their unique, simple and effective one-piece design requires no tools and they are 20 times faster to install when comparing to the traditional mounting clamps.



I  
N  
L  
I  
N  
E  
  
C  
O  
M  
P  
O  
N  
E  
N  
T  
S

All RPC clips are made from durable polyamide material and have a wide working temperature range from -40°F to 284°F (-40°C to 140°C). They meet the UL2043 requirement for plenum rating and have the UL94 HB flame rating, suitable for use in air handling spaces.



# Triple-D<sup>®</sup>



DIVERSITECH<sup>®</sup>

## Universal Coil Cleaner

Triple-D<sup>®</sup> is a Universal Coil Cleaner suitable for use on condenser and evaporator coils. It is metal safe and does not attack aluminum or copper coil components, extending equipment life and diminishing potential for refrigerant leaks. Triple-D<sup>®</sup> is a safer, more versatile product than conventional acid or non-acid coil cleaners.

All of the organic materials in this product are readily biodegradable

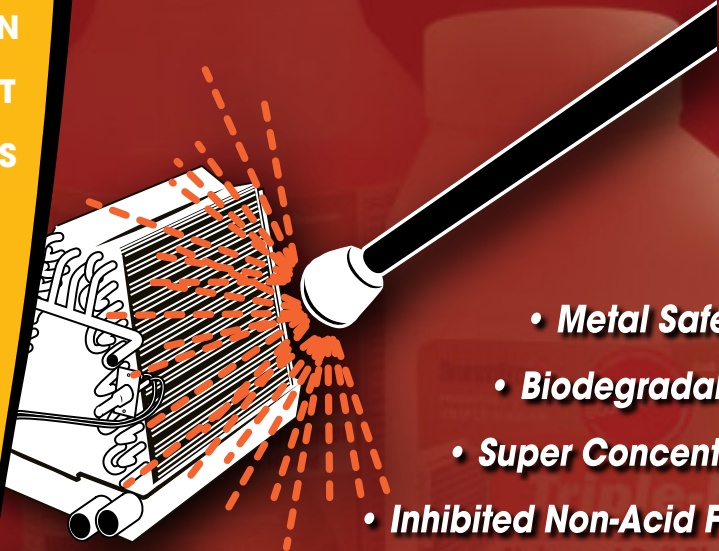
**BIODEGRADABLE**

- 
- 
- 
- Metal Safe
  - Biodegradable
  - Super Concentrated
  - Inhibited Non-Acid Formulation
  - Available in Multiple Packages/Forms
  - Non-Foaming/Non-Toxic
  - Safe for Rubber Roofs
  - Corrosion Inhibited
  - NSF Registered

**One product does it all - truly a Universal Coil Cleaner**



# DISTRIBUTOR SUPPORT



## LITERATURE

### Catalogs

CATALOG NO.	DESCRIPTION	STANDARD PACK
LIT-CAT-HVAC	Issue 23 Catalog	10
LIT-CAT-SEAL	Cliplight® Catalog	10
LIT-CAT-QS	Quick-Sling® Catalog	10

### Tri-Folds

Each DiversiTech tri-fold brochure has a specific product focus. The tri-folds can be used as counter handouts, or mailed to a contractor. Brochure holders are also available. Most tri-folds are 8-1/2" high by 3-5/8" wide.

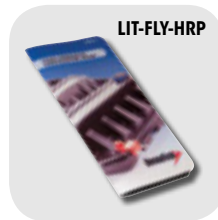

CATALOG NO.	DESCRIPTION	STANDARD PACK
LIT-FLY-3D	Triple-D™ Brochure	25
LIT-FLY-3D-S	Triple-D™ Brochure (Spanish)	25
LIT-FLY-BPPPOOL	The Black Pad® Brochure	25
LIT-FLY-CDLC	Condensate Drain Line Cleaners Brochure	25
LIT-FLY-CLAD	CladLite® Pad Brochure	25
LIT-FLY-CLRVUE	ClearVue™ Pump Brochure	25
LIT-FLY-COIL	Coil Cleaning Solution Guide	25
LIT-FLY-COIL-S	Coil Cleaner Solution Guide (Spanish)	25
LIT-FLY-COND	Condensate Monitoring Switches Brochure	25
LIT-FLY-CS1200	CS1200 A/C Shutoff Brochure	25
LIT-FLY-CVMINI	ClearVue™ Mini Pump Brochure	25
LIT-FLY-CVMINI-S	ClearVue™ Mini Pump Brochure (Spanish)	25
LIT-FLY-DISC	Fusible Disconnect Brochure	25
LIT-FLY-DST10	Hard Start Kit Brochure	25
LIT-FLY-DTP3	Three Phase Motor Protector Brochure	25
LIT-FLY-DTP3ES	Three Phase Motor Protector Brochure (Spanish)	25
LIT-FLY-ELITE	E Lite® Pad Brochure	25
LIT-FLY-ET	A/C Easy Tee® Brochure	25
LIT-FLY-FLEX	Flex Inject® Brochure	25
LIT-FLY-FLXHOSEKIT	SpeediChannel™ Flex Hose Kit Flyer	25
LIT-FLY-FLOW	Flow Plus™ Brochure	25
LIT-FLY-FOOT	Hef-T-Foot™ Brochure	25
LIT-FLY-GG	DrainGun® Brochure	25
LIT-FLY-HEAT	Heat Pump Pad™ Brochure	25
LIT-FLY-HEF	Hef-T-Pad Brochure	25
LIT-FLY-HPAD	Hurricane Pad Brochure	25
LIT-FLY-HRP	High Rise Pan™ Brochure	25
LIT-FLY-HSI	Universal Hot Surface Igniter Brochure	25
LIT-FLY-MDP	Metal Drain Pan Brochure	25
LIT-FLY-MOTORS	Motor Brochure	25
LIT-FLY-PF	Pro-Flush Brochure	25
LIT-FLY-PF-S	Pro-Flush Brochure (Spanish)	25
LIT-FLY-PUMP	Condensate Pump Line Brochure	25
LIT-FLY-QS	Quick-Sling® Brochure	25
LIT-FLY-RPC	Rapid Positioning Clips Brochure	25
LIT-FLY-RPC-S	Rapid Positioning Clips Brochure (Spanish)	25
LIT-FLY-RSC	Sentry™ Refrigerant Locking Caps Brochure	25
LIT-FLY-SEAL	Cliplight® Brochure	25
LIT-FLY-SPCH18	SpeediChannel™ Brochure and Poster	25
LIT-FLY-SPRAYER	Power Sprayer Brochure	25
LIT-FLY-SPRAYER-S	Power Sprayer Brochure (Spanish)	25
LIT-FLY-SPTEAROFF	SpeediChannel™ Tearpad	25
LIT-FLY-SWITCH	Condensate Switch Brochure	25
LIT-FLY-TRIPBOOST	Triple-D®/Boost Juice® Brochure	25

### Literature Holders

CATALOG NO.	DESCRIPTION	STANDARD PACK
MKT-POP-BROCH	Brochure Holder w/DiversiTech Logo Imprinted	1
MKT-POP-BROCH4	4-Pocket Brochure Holder	1
MKT-POP-EASEL	Acrylic Tri-Fold Brochure Holder	1

CATALOG NO.	DESCRIPTION	STANDARD PACK
LIT-FLY-UC	UltraLite® Pad Brochure	25
LIT-FLY-UCSTRAP	UltraLite® Earthquake Pad Brochure	25
LIT-FLY-UV	Pure-Beam™ UV Light Brochure	25
LIT-FLY-VENTS	Vent Termination Kits Brochure	25
LIT-FLY-WS	Wet Switch® Brochure	25

### Samples/Demos



CATALOG NO.	DESCRIPTION	STANDARD PACK
6-HK2748-SAM	High Rise Pan – 27" x 48"	1
6-M3030-SAM	Metal Drain Pan – 30" x 30"	1
6-P3030L-SAM	Molded Drain Pan – 30" x 30" w/hole	1
MKT-POP-DUCTSAM	SpeediChannel™ Rep Sample Kit (Duct & Flat Elbow)	1
MKT-POP-WSDEMO	Wet Switch Demo Kit	1
MKT-SAM-ELEC	Sample Packet for Electrical	1
MKT-SAM-HSI	Sample Kit for TrueStart Hot Surface Igniters	1

## MERCHANDISING

### Posters

CATALOG NO.	DESCRIPTION	STANDARD PACK
MKT-POSTER-CHT24E	Chemical Maintenance Solution Quick Reference Guide - 24" x 36"	1
MKT-POSTER-CHT24S	Chemical Maintenance Solution Quick Reference Guide - 24" x 36" (Spanish)	1
MKT-POSTER-CHT36E	Chemical Maintenance Solution Quick Reference Guide - 36" x 48"	1
MKT-POSTER-CLRVUE	ClearVue™ Pump Poster	1
MKT-POSTER-HPAD	The Hurricane Pad™ poster	1
MKT-POSTER-MSPLIT	SpeediChannel™ Parts Poster	1
MKT-BANNER	DiversiTech® Vinyl Banner 2' x 5'	1

### P.O.P. Merchandisers/Displays

CATALOG NO.	DESCRIPTION	STANDARD PACK
MKT-MAT-COILTAB	Chemical Maintenance Solution Quick Reference Guide - Mat	1
MKT-MERCH-USACAPS	Merchandising Kit for USA Capacitors	1
MKT-MERCH-CHEM	Chemical Display for Gondola	1
MKT-MERCH-DPWIRE	DP-1 Wire Rack	1
MKT-MERCH-FLEX	Flex-Inject® Counter Display	1
MKT-MERCH-RSC	Sentry™ Wall Display	1
MKT-MERCH-SEAL12	Super Seal™ Display	12
MKT-MERCH-SEAL30	Super Seal™ Display	30
MKT-MERCH-SENTRY	Sentryman Display	1
MKT-MERCH-SWITCHWIRE	Wire Display Rack	1
MKT-POP-CDLC	Condensate Drain Line Cleaner Display	1
MKT-POP-CHEM	DiversiTech® Chemical Display 26" base x 73" height	1
MKT-POP-CLRGOND	ClearVue™ Pump Display for Gondola	1
MKT-POP-CLRSHELF	ClearVue™ Pump Shelf Talker	1
MKT-POP-CLRSTAND	ClearVue™ Pump Banner Stand	1
MKT-POP-CVTUBE	ClearVue™ Tube Display	1
MKT-POP-DEVBACKS	DEVCO® Background Graphics for pegboard	Set of 2
MKT-POP-DEVBACKSSLAT	DEVCO® Background Graphics for Slatwall	
MKT-POP-DEVCOMBO	DEVCO® Display Rack – Combo	1
MKT-POP-DEVELEC	DEVCO® Display Rack – Electrical	1
MKT-POP-DEVEZC	DEVCO® Display Rack – EZC	1
MKT-POP-DTBACKS	DiversiTech® Background Graphics for pegboard	Set of 2
MKT-POP-DTBACKSSLAT	DiversiTech® Background Graphics for Slatwall	1
MKT-POP-DUCT	SpeediChannel™ Merchandising Display	1
MKT-POP-ET	A/C Easy Tee® Merchandiser	1
MKT-POP-HSI	Merchandiser Display for TrueStart® Hot Surface Igniters	1
MKT-POP-PF	Pro-Flush® Display	1
MKT-POP-QSBACK	Quick-Sling® Display Background	1
MKT-POP-QSMSBOX	Mini-Split Outside Unit Box	1
MKT-POP-QSWIBOX	Unit Heater Box	1
MKT-POP-SWITCHBACK	Background Display for Condensate Switches	1
MKT-POP-WS	Wet Switch® Counter Display	1



MKT-POP-CHEM

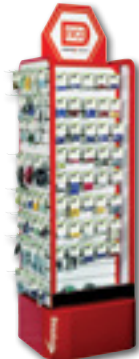

MKT-POP-DEVCOMBO



MKT-POP-DEVELEC



MKT-POP-DEVEZC

MKT-POP-QSWIBOX



MKT-MERCH-DPWIRE



MKT-POP-HSI



MKT-POP-PF



MKT-POP-CDLC



MKT-POP-ET



**U.S. GENERAL TERMS AND CONDITIONS****General Policy****WE ARE COMMITTED TO DO WHAT IT TAKES TO DELIVER WORLD CLASS SERVICE AND PRODUCTS.**

All items not ordered in multiples of standard package quantities will automatically be increased to the next standard package quantity. All purchase orders submitted by our customers are assumed as accepting our general terms and conditions as stated herein, any conflicting terms stated on the purchase order cannot supersede our terms.

**Order Discrepancies:**

All order discrepancies must be reported to us within 5 working days from the date of delivery. Any discrepancies reported after this period cannot be honored.

**Terms:**

1% 15 days. Net 30 days. Late charges of 1-1/2% per month will be charged following the due date of the invoice. Prices subject to change without notice.

**Minimum Order:**

\$100.00 minimum order on all original orders. \$15.00 Broken Pallet Charge will be added for each pad size less than the standard pallet quantities.

**Freight Policy**

CONTINENTAL U.S.: All orders in excess of \$2,000 will ship prepaid. This policy applies to any combination of DiversiTech, Wagner, Specialty Chemical, and Devco products.

**Pick Up Allowance**

3% of net invoice, 24-hour notice requested. Order must qualify for prepaid freight to receive pick up allowance.

**Lost or Damaged Freight**

Although we take special care to insure the safe arrival of your merchandise, our responsibility for damages cease when the customer accepts the shipment. To protect your interest, we suggest that you thoroughly inspect all items before accepting delivery. If your order was damaged in shipment or contains a shortage, report the loss or damage AT ONCE to DiversiTech. Any claims for lost or damaged freight must be noted on the Bill of Lading at the time of delivery. If damage is present, you MUST hold the original carton and merchandise for credit by your Sales Representative – otherwise, no claim can be honored.

**Returns:**

No merchandise will be accepted for return without prior authorization. Call our Customer Service Department to request permission to return goods. Instructions on method of return will be given to you at that time. All returns are subject to a 25% restocking charge.

**Warranty Disclaimer**

DiversiTech has made a diligent effort to illustrate and describe the products in this catalog accurately; however, such illustrations and descriptions are for the sole purpose of identification, and do not express or imply a warranty that the products are merchantable or fit for a particular purpose, or that the products will necessarily conform to the illustrations or descriptions. DiversiTech assumes no liability for typographical or photographic errors.

DiversiTech reserves the right to make changes in design, material or finish in an effort to improve our products without special notification. If necessary, DiversiTech reserves the right to replace any product shown in catalog with another comparable product without special notification. All DiversiTech products include a 1 year standard limited warranty unless otherwise noted.

**DiversiTech's ULTRALITE®, CLADLITE®, and E LITE® Limited Lifetime Warranty**

To the original owner of the ULTRALITE®, CLADLITE®, or E LITE® equipment base, DiversiTech warrants the base to be free of defects in materials and workmanship for the life of the equipment under which it is installed so long as the installing homeowner lives there. All defective merchandise must be returned to the factory, transportation prepaid, and if the same is found to be defective, it will be repaired or replaced free of charge, F.O.B. factory. This warranty does not cover replacement labor cost, or any cost claim incident to the defect, replacement, or reinstallation, nor field repair expenses. This warranty gives you specific legal rights and you may also have other rights which vary from state to state. Some states do not allow the exclusion or limitation of incidental or consequential damages, so the above limitation of exclusion may not apply to you.

**Exclusions and Limitations**

DiversiTech's ULTRALITE®, CLADLITE®, and E LITE® equipment pads are designed and manufactured to be used as bases for light, ground supported equipment such as air conditioning condensers, swimming pool filters and heat pumps. Use of ULTRALITE®, CLADLITE®, and E LITE® pads for purposes other than those listed above or improper installation of ULTRALITE®, CLADLITE®, and E LITE® pads may result in pad failure. DiversiTech Corporation disclaims any liability due to such misuse or improper installation. If you have questions concerning the proper installation or use of DiversiTech's ULTRALITE®, CLADLITE®, and E LITE® equipment pads, you should contact our Customer Service Department at (800)995-2222.

**Made in the U.S.A.**

All item numbers in RED indicate Made in the U.S.A. This information was accurate at time of catalog printing. Visit [www.diversitech.com](http://www.diversitech.com) to verify country of origin for any DiversiTech product.

**DOMESTIC CREDIT APPLICATION**

For internal use only

**COMPANY NAME:** \_\_\_\_\_

CUSTOMER #: \_\_\_\_\_

SHIP TO \_\_\_\_\_ PHONE # \_\_\_\_\_

ADDRESS \_\_\_\_\_ FAX # \_\_\_\_\_

CITY/STATE \_\_\_\_\_ ZIP CODE \_\_\_\_\_

E-MAIL \_\_\_\_\_

BILL TO \_\_\_\_\_

NAME \_\_\_\_\_ PHONE # \_\_\_\_\_

ADDRESS \_\_\_\_\_ FAX # \_\_\_\_\_

CITY/STATE \_\_\_\_\_ ZIP CODE \_\_\_\_\_

E-MAIL \_\_\_\_\_

PRINCIPALS \_\_\_\_\_

BUYING GROUP MEMBER \_\_\_\_\_

BUSINESS STRUCTURE\*: CORPORATION \_\_\_\_\_ PARTNERSHIP \_\_\_\_\_ INDIVIDUAL \_\_\_\_\_ \*Please check one

CREDIT LIMIT REQUESTED \_\_\_\_\_ DUNS # \_\_\_\_\_

ESTIMATED SALES VOLUME \_\_\_\_\_ FEDERAL TAX ID # \_\_\_\_\_

YEARS IN BUSINESS \_\_\_\_\_

**BANK REFERENCE**

NAME \_\_\_\_\_ PHONE # \_\_\_\_\_

ADDRESS \_\_\_\_\_ OFFICER \_\_\_\_\_

CITY/STATE \_\_\_\_\_ ZIP CODE \_\_\_\_\_

ACCOUNT # \_\_\_\_\_

**THREE MAJOR TRADE REFERENCES (U.S. based are preferred)**

NAME \_\_\_\_\_ TITLE \_\_\_\_\_

CONTACT \_\_\_\_\_ PHONE # \_\_\_\_\_

CITY/STATE/ZIP \_\_\_\_\_ FAX # \_\_\_\_\_

E-MAIL \_\_\_\_\_ ACCOUNT NUMBER \_\_\_\_\_

NAME \_\_\_\_\_ TITLE \_\_\_\_\_

CONTACT \_\_\_\_\_ PHONE # \_\_\_\_\_

CITY/STATE/ZIP \_\_\_\_\_ FAX # \_\_\_\_\_

E-MAIL \_\_\_\_\_ ACCOUNT NUMBER \_\_\_\_\_

NAME \_\_\_\_\_ TITLE \_\_\_\_\_

CONTACT \_\_\_\_\_ PHONE # \_\_\_\_\_

CITY/STATE/ZIP \_\_\_\_\_ FAX # \_\_\_\_\_

E-MAIL \_\_\_\_\_ ACCOUNT NUMBER \_\_\_\_\_

## CATEGORY INDEX

007 Control Checker.....	188	Acid Eliminator™ .....	243	Black Nylon Ties with Mounting	
1 Hole EMT Pipe Straps.....	43	Acid Test Kits .....	242	Hole.....	177
1 Hole Rigid Pipe Straps .....	43	Acrylic Latex Painter's Caulk .	101	Black Steel Welded Nipples....	60
2 Hole PVC Pipe Straps.....	42	Adapter (Insert x Slip) .....	203	Blade Auto Fuses .....	127
2 Hole Rigid Pipe Straps .....	43	Additives .....	243	Blind Rivet Tools.....	122
2-in-1 Copper Tube Cleaning		Adjustable Delay on Break Time ..		Boiler Bracket .....	31
Brush .....	181	.....	164	Boiler Pump .....	84
3-36 Multi-Purpose Lubricant .	96	Adjustable Delay on Make		Boost Juice® .....	243
45 Degree Ell .....	60	Timer .....	164	Box Cover Units .....	163
45 Degree Ell C x C .....	248	Adjustable Equipment Risers..	30	Box Stabilizer Support.....	42
45 Degree Flat Bend.....	212	Adjustable Flat Bend.....	211	Box T Bar Fastener .....	42
45 Degree Street Ell Ftg. x C.	249	Aerosol Starter Kit .....	234	Braided Vinyl Tubing.....	89
45 Elbows .....	200	Aerosols.....	92	Brass Adapters.....	251
45 Ell (Slip x Slip).....	201	Air Handler Base - Heavy Duty		Bridle Rings.....	42
4-Piece Hook and Pick Set ...	187	Adjustable .....	33	Bubble-N-Trouble™ Leak Detector .	
6180 Series Terminal Blocks	130	Air Handler Blocks .....	30	.....	238
6190 Series Terminal Blocks	131	All Purpose Cleaning Pads .....	92	Bug Spray .....	102
90 Degree Ell .....	60	All Purpose Enamel .....	96	Bushing .....	61
90 Degree Ell C x C .....	248	All Purpose Lubricant.....	96	Bushing (MIPT x FIPT) .....	196
90 Degree Flat Bend.....	211	All Purpose Sprayers.....	237	Bushings and Locknuts .....	122
90 Degree Inside Elbow.....	212	All Weather PVC Cement.....	198	Butt Connector Assortment	
90 Degree Long Radius Bend	212	Allen Wrenches .....	180	Kit.....	113
90 Degree Long Turn Ell C x C.	249	All-Purpose Clear Cement ...	198	Butt Connectors – Insulated .	112
90 Degree Long Turn Street Ell Ftg.		Aluminum Armored MC Cable .....	155	BX 1 Hole Strap .....	42
x C.....	248	.....	155	BX and Greenfield Connectors ...	
90 Degree Outside Elbow ....	212	Aluminum Dryer Vent Hoods, Kits,		.....	120
90 Degree Street Ell .....	61	and Fittings .....	48	BX Set Screw Connectors .....	155
90 Degree Street Ell Ftg. x C.	248	Aluminum Foil Tape .....	50	C x C.....	249
90 Elbow (Hub x Hub) .....	200	Aluminum Solderless Lugs...	132	Cable Markers .....	132
90 Ell (Slip x FIPT) .....	201	Anchor Kit .....	101	Cable Staples.....	155
90 Ell (Slip x Slip).....	201	Angle Iron Brackets.....	32	Cable Tie Assortment Pack ...	177
90 Ell Reducing (Slip x FIPT)	201	Anti-Vibration Pads .....	24	Cable Tie Channel Clips .....	38
90 Ell Reducing (Slip x Slip).	201	Armored Connector .....	129	Cable Tie Mounts.....	121
90 Street Ell (MIPT x Slip).....	201	Armored Plug .....	128	Cable Ties and Accessories ..	120
90 Street Ell (SPIG x Slip).....	201	Aviation Snips.....	190	Canvas Drop Cloths .....	94
A/C Brackets .....	32	Batteries.....	93	Cap (FIPT) .....	203
A/C Easy Tee.....	87	Beam Clamps.....	40	Cap (Slip) .....	202
A/C Riser Blocks .....	30	Bi Flow Driers .....	257	Capacitors.....	156
A/C Secondary Condensate Drain		Bi-Metal Reciprocating Saw		Carabiners .....	191
Pans .....	87	Blades.....	189	Carbon Monoxide & Smoke	
Abrasive Cloths.....	92	Black Jack Roof Cement .....	101	Alarms .....	59
Access Fittings .....	251	Black Nylon Cable Tie Assortment		Carbon Steel Curved Handle	
Accessories .....	234	.....	121	Scratch Brush.....	182

Carton Sealing Tape.....	93	Compression Nut.....	253	CPVC-CTS Pipe by FlowGuard®	
Carton Tape Dispenser .....	93	Compression Sleeve .....	253	Gold™ .....	196
Catalogs .....	264	Compression Sprayers .....	237	Cross (Slip x Slip x Slip x Slip)	202
Caulk Gun.....	100	Compression Tee .....	253	CS-1,2,3 .....	85
Caulking Sealant .....	100	Compression Union .....	253	CS1200 AC Shutoff Switch .....	85
CBC II Contact Cleaner .....	92	Compressor Lead Kit.....	111	Curve Light.....	186
Channel Nuts .....	40	Compressor Repair Kit .....	170	Cushion Clamps.....	39
Channel Post Base .....	40	Compressor TOTE.....	187	Cushion Clamps.....	255
Channellock Products® .....	182	Concentric Vents .....	57	Cutting Oil.....	96
Channels .....	211	Condensate Cop™.....	85	Cylinder Valves .....	180
Chemicals.....	233	Condensate Drain Line Switches .		D'Scale Acid Scale Remover	242
Chip Brushes.....	181	.....	85	Definite Purpose Contactors.	159
Chlor-Free Degreaser® .....	94	Condensate Drain Pans .....	87	Degreasers.....	94
Circuit Breakers .....	166	Condensate Pumps .....	84	Deluxe Hi-Tension Hacksaw..	189
Citrus Degreaser.....	94	Condensate Switches .....	85	Devco® Crimpers.....	122
CladLite® Pads.....	20	Condenser Equipment Mounting .		Devco® Plastic Anchor Kits ...	117
Clean Out Tee.....	203	.....	32	Device Rings .....	118
Clear Cleaner .....	198	Condenser Fan Motors.....	144	Dial-a-Mix Sprayer .....	237
Clear Vinyl Tubing .....	89	Condenser/Heat Exchanger		Digital Single Phase Line Voltage	
ClearVue™ Mini .....	84	Brushes.....	182	Monitor .....	164
ClearVue™ Pump.....	84	Conduit Nipples.....	121	Digital Thermometer .....	192
ClearVue™ Tube & Traps.....	86	Connection Plates .....	40	Digital Three Phase Line Voltage	
ClearVue™ Traps.....	86	Contacto Accessories.....	160	Monitor .....	164
Cliplights.....	185	Contactors .....	159	Direct Drive Furnace Blower	
Clip-On Zoom Light.....	185	Cool Weld Heat Barrier Spray	234	Motors .....	145
Clips .....	127	Cop Cap™ Locking Valve Cover	251	Direct Replacement Igniters ...	56
Clipstrip™/Clipstrip 2™ .....	185	Copper Coupling with Dimple		Disconnect Switches.....	153
Clipstrip™ Aqua .....	185	Stop.....	250	Disconnects - Metal Case ...	153
Cloth Duct Tape .....	50	Copper Coupling with No		Disconnects - Non Metallic Case.	
CO <sub>2</sub> Cylinders .....	180	Stop.....	250	.....	153
CO <sub>2</sub> Detectors.....	59	Copper Saddle Valve.....	252	DiversiGum Sealing Compound ..	
Coil Cleaning Aerosols.....	234	Copper Tube Fitting Brushes.	182	.....	100
Coil Guard.....	234	Core Removal Tool .....	252	DiversiWhips .....	152
Combination CO & Smoke Alarms		Core Storer.....	252	DiversiWhips for the Swimming	
.....	59	Cork Insulation Tape .....	90	Pool Industry .....	153
Combination Packs.....	111	Cotter Pins .....	125	DiversiWhips Pallet Packs.....	152
Combination Screwdrivers ...	189	Coupling .....	61	DiversiWhips with Extended	
Combo Head Sheet Metal		Coupling (Slip x Slip).....	202	Length Wires .....	153
Screws .....	124	Couplings (Hub x Hub) .....	200	Dormont 20 Series .....	59
Compartmented Storage Boxes ...		CP-16 Economy Pump.....	84	Dormont 20 Series with Valve	59
.....	170	CP-22 Low Profile Pumps.....	84	Dormont 30 Series .....	59
Compression Connector .....	253	CP-22 Pumps .....	84	Drain Line, Tubing .....	89
Compression Elbow .....	253	CPVC-CTS Pipe and Fittings..	196	Drain Pan Disinfectant .....	235

**CATEGORY INDEX cont'd**

Drain Pans .....	87	EcoPad™ .....	23	Finished Hex Nuts.....	123
Drain Trap Kits .....	86	Egg Crate Louvers - Air Return	47	Firestop Products for Class A	Buildings.....
DrainDawg™ .....	86	Elbow (Barb x Barb).....	197	First Aid Kits.....	98
DrainDawg™ and DrainKat™ Fittings	.....	Electrical Duplex Receptacles	165	Fitting Reducer Coupling Ftg. x C	.....
.....	87	Electrical Outlet Boxes, Extensions	and Covers.....	.....	249
DrainGun™ .....	86	Electrical Staples .....	122	Flag Disconnects.....	111
DrainGun™ and Cartridges.....	86	Electrical Tapes.....	169	Flag Female Compressor Terminal	Kit.....
DrainKat™ .....	86	Electrical Toggle Switches ...	165	.....	111
Drive Fasteners.....	116	Electrolytic Copper Solderless	Lugs.....	Flag Female Compressor	Terminals .....
Drop Cloths.....	94	.....	132	.....	111
Drop-In Expansion Anchor Setting	Tool.....	EMT (Thinwall) Fittings.....	155	Flange Mount Conduit Assembly	.....
.....	116	EMT Strut Clamp.....	39	.....	41
Drop-In Expansion Anchors ..	116	Epoxy Coated Gas Connectors	58	Flare Tee.....	254
Dry R™ .....	243	Equipment Stands .....	33	Flare Union .....	254
Dryer Cords .....	167	EVA Anti-Vibration Pad .....	24	Flare x FIP Union.....	255
Dryer Hose Clamps .....	48	Evergreen CM ECM Motors...	146	Flare x Flare Swivel Union ...	255
Dryer Vent Hose.....	48	Evergreen EM ECM Motors...	146	Flare x MIP Elbow .....	253
Dual Element Fuses .....	127	Evergreen IM ECM Motors ...	146	Flare x MIP Reducing Elbow .	253
Dual Element Fuses .....	162	Evergreen InTune Motors.....	147	Flare x MIP Union .....	254
Duct End.....	213	Evergreen OM ECM Motors...	146	Flash UV Dye.....	238
Duct Fans.....	47	Evergreen OM ECM Motors...	147	Flat Wall Escutcheon .....	213
Duct Strap - Metallic - Roll ....	49	Evergreen PF ECM Motors ...	147	Flat Washers .....	123
Duct Tape .....	50	Extension Cords.....	183	Flex Duct Tape .....	50
Duct-Fresh Gel .....	240	Extension Rings .....	118	Flex Hose Kit.....	214
Duct-Fresh Spray .....	240	Fan Centers.....	162	Flex Inject® Sealant Advanced &	Total.....
Dust Masks .....	98	Fasco® 3.3 in. Walk-In Cooler/	Freezer Refrigeration Motors	.....	239
DWV Bend Fittings.....	200	.....	151	Flex Joint .....	213
DWV Bushings.....	200	Fasco® OEM Replacement Draft	Inducers.....	Flex Light.....	186
DWV Vent Tee .....	200	.....	149	Flexible Conduit.....	154
E Lite® Pads .....	19	Fast Cure Epoxy.....	99	Flexible Refrigerant Line.....	259
EasyFlex Kits.....	58	Fast Orange Hand Cleaner.....	94	Flexi-Patch™ .....	99
Eaton Circuit Breakers, Type BR	166	Felt Tip Markers .....	97	Flow Plus® .....	241
Eaton Circuit Breakers, Type CH	166	Female Adapter (Barb x FIPT)	196	Flowmeters .....	180
Eaton Contactor Accessories	160	Female Adapter (Slip x FIPT)	202	Flue Caps.....	47
Eaton Definite Purpose Contactors	- One and Two Pole.....	Female Adapter C x F.....	248	Flushing Products.....	236
.....	160	Female Adapter Elbow (Barb x	FIPT) .....	Foam Insulation Tape.....	90
Eaton Definite Purpose Contactors	- Three and Four Pole.....	.....	197	Foam Sealant - One Component.	99
.....	160	Female Adapter Reducing (Slip x	FIPT) .....	Foam Sealant - Two Component..	.....
Eaton Electrical Disconnects	154	.....	202	.....	100
Eaton Switch A/C Disconnect	154	Fender Washers .....	124	Foam-Plus™ Aerosol Foaming Coil	Cleaner .....
Eaton Three Phase Disconnects	154	Fin Tools.....	183	.....	235
Eco-Coil™ .....	233	Fin Whisk .....	182	Foil Scrim Kraft Tape .....	50
Economy Electrical Tape .....	169				



Fully Insulated Dead End Connectors .....	112	Grease Fittings .....	126	High Temperature Butt Connectors..	114
Fully Insulated Female Slip-On	110	Grip-Cut™ .....	92	High Temperature Female Slip-Ons.....	114
Fully Insulated Flag Female Slip-Ons.....	111	Grommets - Vinyl .....	171	High Temperature Flag Female Slip-Ons .....	114
Fully Insulated Male Slip-Ons	110	Ground Adapter .....	129	High Temperature Male Slip-Ons..	114
Fully Insulated Receptacles..	111	Ground Fitting Clamp.....	132	High Temperature Rings .....	114
Furnace Mounting Blocks.....	30	Grounding Rubber Handle Plug .....	128	High Temperature Solderless Terminals .....	114
Furnace Pans .....	88	Hand Cleaners .....	94	High Temperature Spades ....	114
Furnace Pump.....	84	Hanging Brackets .....	35	High Temperature Wire.....	175
Fuse Adapters.....	163	Hanging Strap .....	191	Hooks, Springs, Fixture Support	42
Fuse Holders .....	130	Hanging Wire .....	49	Horizontal Refrigerator/Freezer Analog Therm. ....	192
Fuse Holders .....	163	Hard Start Kits .....	159	Horizontal Vent Term Kits .....	57
Fuse Pullers .....	163	Heat Pump Pad .....	23	Hose Clamps.....	125
Fuseblocks .....	163	Heat Pump Risers .....	30	Hose Mender (Barb x Barb)..	197
Fusible Links .....	172	Heat Pump Stand .....	33	Hoses .....	180
Garden Hose .....	237	Heat Resistant Cloth .....	193	Hoses, Sprayers .....	237
Garden Hose Adapters .....	196	Heat Shrink Tubing - 50% Polyolefin .....	171	Hot Surface Igniters .....	56
Gas.....	193	Heat Shrink Tubing Assortments... ..	131	Hot Water Hose .....	237
Gas Connectors.....	58	Heavy Duty Bracket.....	31	Hurricane Pad .....	21
Gas Pressure Test Kit .....	186	Heavy Duty Degreaser .....	94	Hurricane Pad Attachment Bracket.....	21
Gauges .....	186	Heavy Duty High Rise Pans ....	88	HVAC Tools .....	190
General Purpose Pumps .....	84	Heavy Duty Nylon Cable Ties	120	Hydroguage Manometer .....	186
General Purpose Relays.....	161	Heavy Duty PVC Cement.....	198	Ice Machine Products .....	238
General Purpose Spray Paint..	97	Heavy Duty Silicone Mold Release.....	96	Icemaker Kit .....	204
General Purpose Switching Relays.....	161	Heavy Duty Tri-Tap Extension Cord.....	167	Igniters.....	56
Generator Power Cord Sets ..	167	Heavy Duty Work Gloves .....	98	Indicator Lights.....™	131
Genteq® Direct Drive Furnace Blower Motors .....	148	Hef-T-Block™ .....	30	Industrial Enamel .....	97
Genteq® High Temperature Condenser Fan Motors.....	148	Hef-T-Brackets™ .....	31	Industrial Towels .....	95
Genteq® Multiple Horsepower Condenser Fan Motors.....	147	Hef-T-Foot™ .....	31	In-Line Fuse Holder.....	163
Genteq® Multiple Horsepower Furnace Blower Motors .....	148	Hef-T-Pad™ .....	22	Insta-Charge.....	257
Genteq Single Speed Condenser Fan Motors.....	147	HEMImini™ .....	185	Insta-Tap Refrigerant Recovery Tool.....	252
Geocel Caulking Sealant .....	100	HEMIPLUS™2 .....	185	Insulated Butt Connectors....	112
GFCI.....	168	Hex Head Cap Screws.....	123	Insulated Female Slip-Ons ...	110
Glass Cleaner.....	92	HF™ Contact Cleaner .....	93	Insulated Flange Spades.....	113
Gloves.....	98	High Heat Spray Paint .....	97	Insulated Hooks.....	112
Gorilla Tube™ Clear Vinyl Tubing .	89	High Rise Pans .....	88	Insulated Male Slip-Ons .....	110
		High Temp Red Silicone Sealant ..	100		
		High Temperature Assortment	114		

## CATEGORY INDEX cont'd

Insulated Plugs.....	111	Male Adapter Ftg. x M .....	248	Multi-Color Test Leads .....	191
Insulated Rings.....	113	Male Adapter Reducing (MIPT x Slip).....	203	Multi-Head Fin-Tool .....	183
Insulated Spades.....	113	Malleable Black Iron Pipe Fittings.....	60	Multiple Horsepower Motors..	145
Insulated Spring Spades .....	113	Manifold Gauges .....	186	Nitrile Gloves.....	98
InsulClips .....	38	Manometers, Pressure .....	186	Nitrogen Cylinders .....	180
Iso-Cube Economy Anti-Vibration Pad.....	24	Manual Reset Fire Stat.....	172	Nitrogen Purge Tool .....	180
J Hooks.....	42	Map-Pro and Propane Gas...	193	Non-Insulated Female Slip-Ons .....	110
J-B Weld .....	99	Markers.....	97	Non-Insulated Flag Female Slip Ons.....	110
Kimberly-Clark Waterless Hand Wipes .....	94	Masonry Bit .....	101	Non-Insulated Male Slip-Ons	110
Kimtex® Towels .....	95	Masonry Screw.....	101	Non-Insulated Rings .....	113
Knock'er Loose® Penetrating Solvent.....	95	Medium Orange CPVC Cement ...	198	Non-Insulated Spades.....	113
Knockout Seals and Hole Plug	121	Medium Split Lock Washers .	123	Non-Metallic Sheathed Cable	155
Kut-All Hose Cutter .....	193	Merchandising .....	265	Nylon Cable Clamps .....	125
Lashing Strap .....	190	Metal Bat Handle Toggle Switches .....	130	Nylon Cable Ties.....	121
Latex Gloves.....	98	Metal Drain Pan.....	88	Nylon Cable Ties with Mounting Hole.....	120
Leak Test Gauge .....	192	Metal Drive Anchors.....	116	Oatey® Products .....	198
Leather Work Gloves .....	98	Metal Guard Trouble Lights...	183	Odor Neutralizers .....	240
Line Piercing Valves and Tools..	252	Metal Guard Trouble Lights...	183	Odor-Aid™ .....	240
Line Set Box .....	258	Metal Parts Boxes .....	126	Offset Snips.....	190
Line Sets .....	258	Metallic Duct - 5 Ply .....	48	One Time Fuses.....	162
Liquid Line Driers.....	256	Mini Split Line Sets .....	258	Outdoor Extension Cord .....	183
Liquid Tite Connectors.....	120	Mini-Split Condensate Drain Line .....	89	P.O.P. Merchandisers / Displays	265
Liquid Tite Connectors.....	154	Mini-Split Drain Adapters.....	89	Pads .....	18
Literature.....	264	Mini-Split Pumps .....	85	Paints and Primers .....	97
Literature Holders .....	264	Mini-Split Stands .....	32	Pan-Kote Heavy Duty Drain Pan Patch .....	235
Louvered Dryer Vent Hood.....	48	Mini-Split Super Stand .....	33	Pan-Patch.....	235
Low Profile Disconnects - Metal Case.....	153	Mini-Split Wiring Solutions ...	174	Periscope Connection Kit .....	49
Low Profile Pumps .....	84	Molded Case Switch Disconnect .....	153	Pigtails.....	132
LuxPro Thermostats .....	173	Motor Brackets .....	152	Pipe Hanging Strap.....	125
Machine Screw Hex Nuts .....	123	Motor Mount - Flex Bracket...	152	Pipe Mounted Switches .....	85
MAC-The Ultimate in Line Piercing Valves .....	252	Motor Run Capacitors - 370VAC ..	156	Pistol Grips & Water Nozzle..	237
Magjumper .....	191	Motor Run Capacitors - 440VAC ..	157	Pivot™ .....	185
Magnetic Hex Chucks .....	122	Motor Run Capacitors - 440VAC ..	157	Pivot™ 33.....	185
Male Adapter (Barb x MIPT)..	196	Motor Shaft Key Assortments	125	Pivot™ Mini .....	185
Male Adapter (MIPT x Slip) ...	202	Motor Start Capacitors .....	158	Pivot™ Tough-Light.....	185
Male Adapter C x M .....	248	Motors .....	144	Plastic DWV J-Hooks.....	204
Male Adapter Elbow (Barb x MIPT) .....	197	Mounting Straps .....	42	Plastic Hanger Strap .....	50
				Plastic Thermostat Guards....	173
				Plastic Wall Plates .....	166

Plastic White End Clamps .....	40	ProTek BG™ for Cast Iron Water Boilers .....	236	QD® Contact Cleaner.....	93
Plastic Wide Mouth Dryer Vent Head.....	48	ProTek™ Closed Loop Heat Transfer Fluid .....	236	Quick Stand .....	33
Plated Steel Utility Covers ....	118	ProTek EG™ .....	235	Quick Swivel "U" Mount.....	35
Plenum Thermostat Wire .....	174	ProTek PG 100™ .....	236	Quick Swivel Flush Mount w/"H" Bracket.....	35
Plug (MIPT) .....	202	ProTek PG Plus™ .....	236	Quick Swivel Flush Mount w/"I" Bracket.....	35
Plug (Slip).....	202	Pro-Thaw™ Liquid Dryer for Refrigerants.....	243	Quick-Sling®.....	35
Plug Fuses .....	163	PRO-TITE™ Resin Based Thread Sealant .....	243	Quick-Sling® Accessories .....	35
Pocket 4-in-1 Mini Screwdriver	189	Pro-Treat® 151 .....	241	Quick-Tap.....	252
Polyethylene Tubing .....	204	Pro-Treat® 152 .....	241	Quick-Tap-2 .....	252
Polypropylene Parts Boxes....	126	Pro-Treat® 161 .....	241	Radiant Leak Finder™ .....	238
Porcelain Outlet Box		Pro-Treat® 200 .....	241	Rain-R-Shine Blue Cement ...	198
Lampholders .....	130	Pro-Treat® 217 .....	241	Rapid Positioning Clips .....	38
Porcelain Wire Connectors ...	132	Pro-Treat® 350 Condensate Drain Pan Treatment .....	241	Ratchet Strap .....	191
Porcelain Wire Connectors ...	176	Pro-Treat® Pan Strips.....	241	Rayovac® Industrial Max Alkaline Batteries.....	93
Portable Hand Torch.....	193	Pro-Weld™ PVC Cement (Heavy Body).....	199	Rayovac® Lantern Batteries ....	93
Posters.....	265	Pro-Weld™ PVC Cement (Pool and Turf - Blue) .....	199	Rayovac® LED Flashlights.....	184
Potential Relays.....	161	Pro-Weld™ PVC Cement (Regular Body).....	199	Reach-It .....	188
Power Blocks .....	183	Pro-Weld™ PVC Cement (Universal) .....	199	Receptacles .....	129
Power Cords and Work Lights	124	Pro-Weld™ Weather - ALL .....	199	Reducer Bushing (SPIG X FIPT)....	203
Power Sprayer .....	237	Pro-Yellow™ .....	234	.....	203
Power Supply Cords (Pigtails)	167	PTFE Tape.....	90	Reducer Bushing (SPIG x Slip)	203
Power Supply Replacement Cords.....	129	P-Traps.....	250	Reducer Coupling.....	213
Pro-Air Duct Sealant UL 181 .	101	Pull-A-Spout Oiler .....	96	Reducer Coupling w/Stop C x C... ..	249
Pro-Air Industrial Grade Spray Adhesive .....	101	Pump Parts & Accessories ....	84	Reducing Coupling .....	61
Pro-Blue™ .....	233	Pumps .....	84	Reducing Tee.....	61
Pro-Brown™ .....	233	Pure-Beam™ Ultraviolet Light ..	48	Reducing Washers.....	121
Pro-Bubble™ Leak Detector ...	238	Purple Primer for PVC Pipe and Fittings.....	198	Refractometer.....	188
Pro-Flush® Accessories .....	236	PVC Cement - Clear.....	198	Refrigerant Charging.....	257
Pro-Flush® HVAC Flushing Solvent .....	236	PVC Condensate Pipe .....	200	Refrigerant Labels.....	259
Pro-Green™ .....	233	PVC DWV Fittings.....	200	Refrigerant Recovery Cylinders	260
Pro-Kleen™ .....	234	PVC Gray Cement .....	198	Refrigerant Recovery Products .	260
Pro-Lube™ Mineral Oil.....	241	PVC Primer - Clear.....	198	Refrigerant Safety Caps.....	247
Pro-Lube-ALK™ Alkylbenzene .	241	PVC Primer and Cement .....	199	Refrigerator Coil Brush.....	181
Pro-Lube-POE™ Polyolester....	242			Refrigerator/Freezer Analog Thermometer.....	192
Pro-Lube-VAC™ Vacuum Pump Oil .....	243			Regulators.....	180
Pro-Prime™ Clear PVC Primer	199			Rehvac Nitrogen Purging Equipment .....	180
Pro-Prime™ PVC Primer (Purple)	199				
Pro-Red Plus™ .....	234				

## CATEGORY INDEX cont'd

Rehvac Refillable Gas Cylinders .....	180	Scotch® Electrical Tapes.....	169	SpeediChannel™ Accessories	214
Relays.....	161	Screwdrivers, Driver Sets .....	189	SpeediChannel™ Kits.....	214
Replacement Compressor Leads .....	170	Screwloose® Industrial Penetrating Oil.....	95	Split Bolt Connectors .....	132
Replacement Element Kits ...	172	Sealant, Epoxy, Glue .....	99	Spotlight .....	186
Right Angle Plug .....	129	Sealants.....	239	Sprayers.....	237
Right Angle Tri-Tap Portable GFCI.....	167	Seal-N-Go® Self-Sealing Refrigerant .....	239	Spring Fittings & Beam Clamps.	40
Rigid Conduit Bodies .....	119	SeekerMax™ .....	239	Spring Steel Cable Clip .....	41
Rigid Strut Clamp .....	39	SeekerMini™ .....	238	Standard Line Sets.....	258
Romex Connectors - Metallic	155	Self Tapping Water Valve .....	204	Standard Wire Connectors ...	132
Roof Flashing .....	47	Self-Drilling Gypsum Wallboard Anchors .....	116	Staples.....	155
Roof Louver .....	47	Self-Drilling Screw Repair Kit	124	Sta-Plex™ Premium Red Grease	96
Rope.....	190	Self-Drilling Screws.....	124	Steel 1900 Boxes .....	118
Rotom® 3.3 Diameter Refrigeration Motors.....	151	Semi-Rigid Aluminum Duct ...	48	Steel 1900 Covers.....	119
Rotom® 51 Frame Refrigeration Motors .....	150	Sentry Refrigerant Locking Caps.....	247	Steel Octagon Box.....	118
Rotom® 51 Frame Unit Bearing Motors .....	150	Sequencers .....	172	Steel Thermostat Guards.....	173
Rotom® EMC Unit Bearing Motor	152	Set Screws .....	125	Steel Utility Boxes .....	118
Round Extension Cords.....	124	Sheet Metal Screw Assortments ..	124	Stick-E-Tape.....	50
Rubber / Cork Anti-Vibration Pad..	24	Sheet Metal Screws Drill Point.	102	Sting Less Wasp & Hornet Killer ..	102
Rubber Anti-Vibration Pad .....	24	Sheet Metal Screws Taper Point...	102	Storage Containers.....	126
Rubber Connector .....	129	Shoe Covers.....	98	Stove Bolts .....	123
Rubber Tie Down Strap.....	191	Shop Towels .....	95	Stranded Copper Wire on Spool ..	175
Safety Plates .....	119	Short Forged Flare Nut.....	254	Stranded Copper Wire, 194° F	175
Safety Supplies, Devices .....	98	Short Nut .....	254	Stranded High Temperature Wire .	128
Saf-N-Kleen Aerosol Solvent Coil Cleaner.....	235	Short Nut .....	254	Strapping Hanger Iron.....	49
Samples/Demos .....	264	Sight Glasses .....	257	Straps .....	121
Sani C-N-D™ Coil and Drain Pan Disinfectant.....	235	Silicone Sealant .....	100	Strut Channel .....	39
Satchel Style Case.....	126	Single Piece Liquid Tite Fittings.....	154	Strut Clips & Clamps .....	38
Saws and Saw Blades.....	189	SJTO Service Cord .....	128	Strut to Beam Clamps.....	40
Scotch® 35 Vinyl Electrical Tape ..	170	Smoke Detectors .....	59	Strut, Threaded Rod & Accessories.....	39
Scotch® 3M Super 33+ Electrical Tape.....	169	Smokeys .....	47	Studded Clips.....	38
Scotch® 3M Super 88 Electrical Tape.....	169	Snips .....	190	Suction Line Driers .....	256
		Soffit Fitting .....	211	Super Change™ .....	236
		SP-400™ Corrosion Inhibitor ...	96	Super Glue.....	99
		Spade Terminals .....	113	Super Seal™ Sealant Advanced	239
		Specialty Fasteners.....	125	Super Seal™ Sealant Sure Shot	240
		Specialty Fittings .....	126	Super Seal™ Sealant Total.....	239
		SpeediChannel™ .....	211	Super Stands.....	34
				SuperComb.....	184

Super-Kool™ Ice Machine Cleaner .....	238	Test Kits, Strips, and Prevent .	242	Transformers - Class 2 .....	161
Supports .....	204	Test Leads .....	127	Transparent Plastic Boxes with	
Sure-Stick Heavy Duty Adhesive... ..	92	Test Leads .....	191	Terminal Asst .....	170
Surge-Trap Type 1 STXH.....	165	Testers, Leads, Clips, Fuses... ..	127	Traps .....	201
Surge-Trap Type 1 STXR.....	165	TFFN Stranded Hook-Up Wire	127	Tri-Fold Brochures .....	264
Sweat-Free Pipe Insulation Spray .....	92	The Black Pad® .....	22	Triple Outlets .....	129
Switch Covers.....	166	The Hurricane Pad™ .....	21	Triple-D® Universal Coil Cleaner	233
Switch/Plug Combo .....	166	The Hurricane Pad™ Bracket ...	21	Trouble Lights.....	124
Switches .....	85	The Hurricane Pad™ MD .....	21	Truck Rope .....	190
Swivel Head Deburring Tool..	193	The Hurricane T-Class Pad™ ...	21	TrueStart® Flame Sensors.....	57
System Cleaners.....	242	The Purifier™ .....	241	Tubing Insulation .....	260
T-50 Series Staples and Staple		Thermometers .....	192	Tubing, Clamps, and Kits .....	204
Guns.....	187	Thermometers/Probes.....	192	Twist-On Wire Connectors ...	176
Tab Adapters - Male Tabs.....	112	Thermoplastic Handle Plug ..	128	Two Pole Definite Purpose	
Tab Adapters - Piggy Back Slip-		Thermostat Guards .....	173	Contactors .....	159
Ons.....	112	Thermostat Wire .....	174	Type "S" Non-Tamper Fuses..	163
Tab Adapters - Quick Disconnect		Thermostats .....	173	UL Listed Foil Tape .....	50
with Screw .....	112	THHN Stranded Hook-Up Wire	127	Ultra Lite 3-36® Lubricant.....	96
Tab Adapters - Single Fem Dbl		Thinwall E.M.T. Connectors... ..	120	UltraLite® Earthquake Pads.....	18
Male Tabs.....	112	Thread Sealant with PTFE.....	99	UltraLite® Wedge Pads .....	18
Tandem Grounding Rubber		Thread Sealants .....	243	UltraViolet Light .....	48
Handle .....	128	Threaded Rod.....	39	Union.....	61
Tankless Water Heater Connection		Threaded Rod.....	39	Union C x Brass .....	249
Kits .....	58	Three Phase Disconnects.....	154	Union Coupling .....	212
Tap Connectors .....	112	Three Pole Definite Purpose		Universal Alarm .....	85
Tape.....	169	Contactors .....	159	Universal Carbide Igniters .....	56
Tattle-Tale Control Monitor....	188	Three Pole Definite Purpose		Universal Pump Elbow .....	214
T-Bar Scissor Clips .....	42	Contactors .....	160	Universal Spun Copper Driers	256
Tee.....	61	Time Delay Fuses .....	162	Universal Strut Clamp .....	39
Tee (Barb x Barb x Barb) .....	197	Time Delay Plug Fuses.....	162	Upright Snips.....	190
Tee (Slip x FIPT x Slip).....	201	Time Delays .....	164	Utility Covers .....	118
Tee (Slip x Slip x Slip) .....	201	Tin Handle Acid Brushes .....	181	Utility Fuse Outlets.....	130
Tee C x C x C.....	250	T-Joint.....	212	Utility Plates .....	118
Teflon Tape .....	126	Toggle Bolts.....	123	U-Type Strap.....	250
Telescopic Inspection Mirror.	187	Toggle Switch and Receptacle		Vacuum Pump Oil .....	243
Teri® Towels .....	95	Combo Device.....	129	Valve Action Marker .....	97
Terminal Kits.....	115	Toggle Switch Cover .....	167	Valve Action Paint Marker.....	97
Terminals, Connectors.....	171	Toggle Switch Neon Pilot Light		Vent Termination Kits.....	57
Terry Towels .....	95	Combo Device.....	130	Ventilation Products.....	47
Test Cord (Female) .....	192	Toggle Switches.....	167	Versa Cap® Flue and Hot Stack	47
		Tongue and Groove Pliers ...	182	Vinyl Grommet Assortment Packs	
		Torches .....	193	.....	131
		Torque Plus - Hard Start Kits .	159	Wagner® Adhesive Sealant .....	99
		Transformers .....	161		

**CATEGORY INDEX** cont'd

Wagner® Direct Drive Furnace Blower Motors .....	145	Z Purlin Hanger .....	41
Wagner® High Temperature Condenser Fan Motors.....	144	Zinc Plated DC Steel Romex Connectors .....	119
Wagner® Multiple Horsepower Condenser Fan Motors.....	144	Zinc-It® Instant Cold Galvanize™	96
Wagner® Multiple Horsepower Furnace Blower Motors .....	145		
Wagner® Single Speed Condenser Fan Motors.....	144		
Wall Escutcheon.....	213		
Wall Penetration .....	211		
Wasp, Hornet, and Yellow Jacket Killers.....	102		
Water Heater Pans.....	88		
Waterless Hand Wipes .....	94		
Waterproof Box with Lever Switch Cover .....	119		
Waterproof Covers .....	119		
WD-40® .....	96		
Weatherproof Boxes .....	119		
Welder's Brush .....	181		
Welding Torches, Supplies....	193		
Wellington® ECM Refrigeration Motors .....	152		
Wet Switch® Flood Detector ...	85		
Whips .....	152		
White Lithium Grease .....	96		
White Nylon Ties with Mounting Hole.....	177		
White Nylon Wire Ties .....	177		
White Pipe .....	259		
Winged Wire Connectors .....	131		
Wire and Cable Clamps - Nylon	178		
Wire Connectors.....	176		
Wire for Mini-Split Installation	174		
Wire Tie Mounts.....	178		
Wolverine® Universal Hot Surface Igniter .....	56		
Workhorse® Manufactured Rags	95		
Worklights by Cliplight® .....	185		
WypAll Plus .....	95		
WypAll ShopPro X80 Towels ...	95		

**PART NUMBER INDEX**

01714 ..... 99	14175 ..... 47	17535 ..... 39	18232 ..... 41	20-3135-18 ..... 59
01724 ..... 99	14250 ..... 47	17536 ..... 39	18240 ..... 41	20-3135-24 ..... 59
02033 ..... 260	1428646 ..... 177	17537 ..... 39	18370 ..... 42	20-3135-36 ..... 59
02053 ..... 260	14340 ..... 47	17542 ..... 39	18387 ..... 42	20-3135-48 ..... 59
02100 ..... 260	145-175 ..... 158	17543 ..... 39	18421 ..... 42	21367 ..... 89
02255 ..... 260	145-175220 ... 158	17544 ..... 39	18422 ..... 42	216-259 ..... 158
04022 ..... 259	145-175330 ... 158	17545 ..... 39	18425 ..... 42	216-259220 ... 158
04044 ..... 259	15097 ..... 189	17546 ..... 39	18426 ..... 42	216-259330 ... 158
04134 ..... 259	161-193 ..... 158	17547 ..... 39	18427 ..... 42	22098 ..... 30
04407 ..... 259	161-193220 ... 158	17616 ..... 40	189-227 ..... 158	22402 ..... 189
04410 ..... 259	161-193330 ... 158	17618 ..... 40	189-227220 ... 158	23010 ..... 98
04850 ..... 259	1636-3 ..... 20	17626 ..... 40	189-227330 ... 158	230-14-4 ..... 174
1000-1200 .... 158	16491 ..... 100	17628 ..... 40	1895762 ..... 47	230-14-4S ..... 174
10012 ..... 100	16500 ..... 193	17630 ..... 40	19400 ..... 43	230-14-7 ..... 174
1002 ..... 237	16510 ..... 193	17632 ..... 40	19401 ..... 43	230-16-2 ..... 174
108-130 ..... 158	16520 ..... 193	17633 ..... 40	19402 ..... 43	230-18-4 ..... 174
108-130220 ... 158	170AIR ..... 240	17634 ..... 40	19426 ..... 43	230-AFB3 ..... 211
108-130330 ... 158	170AIRFAN ..... 240	17636 ..... 40	19438 ..... 43	230-AFB3W ..... 211
10816 ..... 171	170AIRPCB ..... 240	17638 ..... 40	19439 ..... 43	230-AFB4 ..... 211
111110 ..... 239	1714 ..... 99	17682 ..... 40	19440 ..... 43	230-AFB4W ..... 211
111110A ..... 239	171AIR ..... 240	17684 ..... 40	19441 ..... 43	230-B2L ..... 31
111112 ..... 185	1724 ..... 99	18001 ..... 100	19443 ..... 43	230-B2M ..... 31
111113 ..... 185	17412 ..... 40	18002 ..... 100	19444 ..... 43	230-BP17W ..... 30
111114 ..... 185	17420 ..... 40	18003 ..... 100	19445 ..... 43	230-CP3 ..... 212
111115 ..... 185	17430 ..... 40	18018 ..... 40	19446 ..... 43	230-CP3B ..... 212
111116 ..... 185	17438 ..... 40	18026 ..... 41	19463 ..... 42	230-CP3W ..... 212
111117 ..... 185	17442 ..... 40	18050 ..... 41	19490 ..... 42	230-CP4 ..... 212
111118 ..... 185	17450 ..... 40	18052 ..... 42	19492 ..... 42	230-CP4B ..... 212
111121 ..... 186	17452 ..... 40	18054 ..... 42	19494 ..... 42	230-CP4W ..... 212
111128 ..... 185	17454 ..... 40	18056 ..... 42	19496 ..... 42	230-CP6 ..... 212
111130 ..... 185	17462 ..... 40	18058 ..... 42	19498 ..... 42	230-CP6W ..... 212
111131 ..... 186	17464 ..... 40	18060 ..... 42	19500 ..... 42	230-D3 ..... 211
111133 ..... 186	17515 ..... 39	18106 ..... 40	19501 ..... 42	230-D3B ..... 211
114301 ..... 185	17516 ..... 39	18123 ..... 40	19502 ..... 42	230-D3W ..... 211
114302 ..... 185	17518 ..... 39	18124 ..... 40	19503 ..... 42	230-D4 ..... 211
1157972 ..... 47	17519 ..... 39	18130 ..... 41	200-240 ..... 158	230-D4B ..... 211
11810 ..... 198	17520 ..... 39	18140 ..... 41	20122 ..... 236	230-D4W ..... 211
124-156 ..... 158	17521 ..... 39	18160 ..... 41	20122 ..... 238	230-D6 ..... 211
124-156220 ... 158	17522 ..... 39	18161 ..... 41	20133 ..... 239	230-D6W ..... 211
124-156330 ... 158	17523 ..... 39	18180 ..... 41	20-3132-18 ..... 59	230-DC3 ..... 213
12601 ..... 89	17532 ..... 39	18200 ..... 41	20-3132-24 ..... 59	230-DC3W ..... 213
14062 ..... 89	17533 ..... 39	18202 ..... 41	20-3132-36 ..... 59	230-DC4 ..... 213
14145 ..... 47	17534 ..... 39	18231 ..... 41	20-3132-48 ..... 59	230-DC4W ..... 213

## PART NUMBER INDEX cont'd

230-DC6.....213	230-FB453.....212	230-MB17W.....30	2448-3.....20	3434-2.....20
230-DC6W.....213	230-FB453B....212	230-MB36W.....30	25001.....190	3458.....147
230-DCLIP.....214	230-FB453W...212	230-MBCW.....30	2597392.....47	3458HS.....148
230-DCLIP-10..214	230-FB454.....212	230-PFB3.....214	2601.....237	3459.....147
230-DE3.....213	230-FB454B....212	230-SF3.....211	2602.....237	3459HS.....148
230-DE3B.....213	230-FB454W...212	230-SF3W.....211	2603.....237	3463.....148
230-DE3W.....213	230-FB456.....212	230-SF4.....211	270-324.....158	3464.....148
230-DE4.....213	230-FB456W...212	230-SF4W.....211	270-324220...158	3465.....147
230-DE4B.....213	230-FB4B.....211	230-TC34.....213	270-324330...158	3465HS.....148
230-DE4W.....213	230-FB4W.....211	230-TC34W.....213	2855619.....90	3466.....148
230-DE6.....213	230-FB6.....211	230-TC46.....213	28672.....89	3467.....148
230-DE6W.....213	230-FB6W.....211	230-TC46W....213	3030-2.....20	3468.....147
230-DL16.....89	230-FH3-KIT...214	230-TJ4.....212	3030-3.....20	3468HS.....148
230-DL16-20...89	230-FH3W-KIT.214	230-TJ4B.....212	30-3131-24....59	3469.....147
230-DLF16.....89	230-FH4-KIT...214	230-TJ4W.....212	30-3131-36....59	3469HS.....148
230-DLF18.....89	230-FH4-KITW.214	230-TJ6.....212	30-3131-48....59	357-20.....235
230-DLF20.....89	230-FJ3.....213	230-TJ6W.....212	30-3132-12....59	358-20.....235
230-DLF25.....89	230-FJ3W.....213	230-WC3.....211	30-3132-18....59	3583.....148
230-DLF32.....89	230-FJ4.....213	230-WC3B.....211	30-3132-24....59	3584.....148
230-DLFY.....89	230-FJ4W.....213	230-WC3W.....211	30-3132-30....59	3585.....148
230-DPPL.....89	230-FR3.....213	230-WC4.....211	30-3132-36....59	3586.....148
230-DPPM.....89	230-FR3W.....213	230-WC4B.....211	30-3132-48....59	3587.....148
230-DSCREW...214	230-FR4.....213	230-WC4W.....211	30-3132-60....59	3588.....148
230-EB3.....212	230-FR4W.....213	230-WC6.....211	30-3132-72....59	3589.....148
230-EB3B.....212	230-FR6.....213	230-WC6W.....211	3036-2.....20	3590.....148
230-EB3W.....212	230-FR6W.....213	230-WR3.....213	3036-3.....20	3595.....148
230-EB4.....212	230-IK3.....214	230-WR3W.....213	3040-2.....20	3596.....148
230-EB4B.....212	230-IK3W.....214	230-WR4.....213	3040-3.....20	362-16.....92
230-EB4W.....212	230-IK4.....214	230-WR4W.....213	3143-2.....20	3636-2.....20
230-EB6.....212	230-IK4W.....214	230-WR6.....213	315-20.....92	3636-3.....20
230-EB6W.....212	230-IKC3.....214	230-WR6W.....213	3202.....147	3640-2.....20
230-EIN3.....212	230-IKC3W.....214	230-WS2.....211	3203.....147	3640-3.....20
230-EIN3B.....212	230-IKC4.....214	230-WS2W.....211	3203HS.....148	3648-2.....20
230-EIN3W.....212	230-IKC4W.....214	233-292.....158	3204HS.....148	3648-3.....20
230-EIN4.....212	230-LFB3.....212	233-292220...158	3205.....147	3660-3.....20
230-EIN4B.....212	230-LFB3B.....212	23559.....30	3205HS.....148	37012.....200
230-EIN4W.....212	230-LFB3W.....212	2424-2.....20	32-3.....20	37030H.....156
230-EIN6.....212	230-LFB4.....212	2424-3.....20	3232-2.....20	37040H.....156
230-EIN6W.....212	230-LFB4B.....212	2436-2.....20	3232-3.....20	37050H.....156
230-FB3.....211	230-LFB4W.....212	2436-3.....20	3237-3.....20	37050HB.....156
230-FB3B.....211	230-LFB6.....212	2442-2.....20	324-388.....158	37050R.....156
230-FB3W.....211	230-LFB6W.....212	24-458.....185	325-12.....92	37060H.....156
230-FB4.....211	230-MB14W.....30	24-460.....185	340-408.....158	37075H.....156



**PART NUMBER INDEX cont'd**

37075HB ..... 156	37550R ..... 156	3GR0570 ..... 156	4293CX ..... 132	45300H ..... 157
37075R ..... 156	37600H ..... 156	3GR0580 ..... 156	4294 ..... 132	45300HU ..... 158
37100H ..... 156	37600R ..... 156	3GR1035 ..... 156	4294CX ..... 132	45300R ..... 157
37100HB ..... 156	37700H ..... 156	3GR1080 ..... 156	4296 ..... 132	45350H ..... 157
37125H ..... 156	37800H ..... 156	3GR7530 ..... 156	4296CX ..... 132	45350HU ..... 158
37125R ..... 156	37800R ..... 156	3GR7540 ..... 156	43230 ..... 198	45350R ..... 157
37150H ..... 156	378-440 ..... 158	3GR7555 ..... 156	43232 ..... 198	45400H ..... 157
37150R ..... 156	38150 ..... 152	3GR7560 ..... 156	43234 ..... 198	45400HU ..... 158
37175H ..... 156	3842-3 ..... 20	3GR7580 ..... 156	43252 ..... 88	45400R ..... 157
37175R ..... 156	38473 ..... 200	3WF-01 ..... 242	43253 ..... 88	45450H ..... 157
37200H ..... 156	38880 ..... 152	400-480 ..... 158	43254 ..... 88	45450HU ..... 158
37200R ..... 156	3GJ0330 ..... 156	4042-3 ..... 20	43256 ..... 88	45450R ..... 157
37250H ..... 156	3GJ0515 ..... 156	410211 ..... 240	43291 ..... 89	45500H ..... 157
37250R ..... 156	3GJ0520 ..... 156	410212 ..... 240	43293 ..... 89	45500HU ..... 158
3726HS ..... 148	3GJ0525 ..... 156	410239 ..... 185	43295 ..... 89	45500R ..... 157
3727 ..... 147	3GJ0530 ..... 156	4147-2 ..... 20	43-53220 ..... 158	4550-3 ..... 20
3728 ..... 147	3GJ0535 ..... 156	4200AX ..... 114	436-20 ..... 102	45550H ..... 157
3729 ..... 147	3GJ0540 ..... 156	420182 ..... 47	45020H ..... 157	45550R ..... 157
3730 ..... 147	3GJ0545 ..... 156	4204 ..... 114	45030H ..... 157	4558-3 ..... 20
37300H ..... 156	3GJ0555 ..... 156	4204CX ..... 114	45040H ..... 157	45600H ..... 157
37300R ..... 156	3GJ1025 ..... 156	4205CX ..... 114	45050H ..... 157	45600HU ..... 158
37300R-SWP... 156	3GJ1060 ..... 156	4213 ..... 114	45050HU ..... 158	45600R ..... 157
3731 ..... 147	3GJ1520 ..... 156	4213CX ..... 114	45050R ..... 157	45700H ..... 157
3732HS ..... 148	3GJ7530 ..... 156	4214 ..... 114	45060H ..... 157	45700HU ..... 158
3733HS ..... 148	3GJ7535 ..... 156	4214CX ..... 114	45075H ..... 157	45700R ..... 157
3734HS ..... 148	3GJ7545 ..... 156	4215 ..... 114	45075HU ..... 158	45800H ..... 157
37350H ..... 156	3GJ7555 ..... 156	4215CX ..... 114	45075R ..... 157	45800HU ..... 158
37350R ..... 156	3GR0325 ..... 156	4220 ..... 114	45100H ..... 157	45800R ..... 157
37350R-SWP... 156	3GR0330 ..... 156	4220CX ..... 114	45100HU ..... 158	460-552 ..... 158
3735HS ..... 148	3GR0335 ..... 156	4221 ..... 114	45100R ..... 157	4700-12 ..... 196
3736HS ..... 148	3GR0340 ..... 156	4221CX ..... 114	45125H ..... 157	4700-34 ..... 196
37377 ..... 200	3GR0425 ..... 156	4224 ..... 114	45125HU ..... 158	4701-12 ..... 196
3737HS ..... 148	3GR0435 ..... 156	4224CX ..... 114	45125R ..... 157	4701-34 ..... 196
3738HS ..... 148	3GR0515 ..... 156	4224NX ..... 114	45150H ..... 157	4703-34 ..... 196
3739HS ..... 148	3GR0520 ..... 156	4226 ..... 114	45150HU ..... 158	4704-12 ..... 196
37400H ..... 156	3GR0525 ..... 156	4226CX ..... 114	45150R ..... 157	4704-34 ..... 196
37400R ..... 156	3GR0530 ..... 156	4231 ..... 114	45175H ..... 157	4706-34 ..... 196
37450H ..... 156	3GR0535 ..... 156	4252 ..... 114	45200H ..... 157	4707-12 ..... 196
37450R ..... 156	3GR0540 ..... 156	4252CX ..... 114	45200HU ..... 158	47072-12 ..... 196
3746 ..... 147	3GR0545 ..... 156	4253 ..... 114	45200R ..... 157	47072-34 ..... 196
3747HS ..... 148	3GR0550 ..... 156	4253CX ..... 114	45250H ..... 157	4707-34 ..... 196
37500H ..... 156	3GR0555 ..... 156	4254CX ..... 114	45250HU ..... 158	4711-12 ..... 196
37500R ..... 156	3GR0560 ..... 156	4293 ..... 132	45250R ..... 157	4711-34 ..... 196

## PART NUMBER INDEX cont'd

4718-12 ..... 196	4JR7540 ..... 157	5-11879 ..... 47	538-1/2 ..... 255	5-404 ..... 200
4766-3 ..... 20	4JR7540U ..... 158	515-J2000 ..... 204	538-1/4 ..... 39	5-405 ..... 200
4848-3 ..... 20	4JR7545 ..... 157	515-J3000 ..... 204	538-1/4 ..... 255	540-506 ..... 187
4JJ0525 ..... 157	4JR7545U ..... 158	5200 ..... 124	538-1-1/8 ..... 39	540-508 ..... 187
4JJ0530 ..... 157	4JR7550 ..... 157	5201 ..... 124	538-1-1/8 ..... 255	540-509 ..... 187
4JJ0535 ..... 157	4JR7550U ..... 158	5223 ..... 129	538-1-3/8 ..... 39	540-572 ..... 237
4JJ0540 ..... 157	4JR7555 ..... 157	5230 ..... 124	538-1-3/8 ..... 255	540-573 ..... 237
4JJ0545 ..... 157	4JR7555U ..... 158	5240 ..... 129	538-1-5/8 ..... 39	5-406005 ..... 201
4JJ0555 ..... 157	4JR7560 ..... 157	5242 ..... 129	538-1-5/8 ..... 255	5-406007 ..... 201
4JJ0560 ..... 157	4JR7560U ..... 158	5246 ..... 126	5382 ..... 125	5-406010 ..... 201
4JJ1055 ..... 157	4JR7570 ..... 157	5255 ..... 126	538-2-1/8 ..... 39	5-406020 ..... 201
4JJ7535 ..... 157	4JR7580 ..... 157	525-MT1 ..... 193	538-2-1/8 ..... 255	5-406030 ..... 201
4JJ7540 ..... 157	4WF-01 ..... 242	525-PT1 ..... 193	538-2-5/8 ..... 39	540-648 ..... 158
4JJ7545 ..... 157	5002 ..... 122	525-TORCH ..... 193	538-2-5/8 ..... 255	540-6510L ..... 190
4JR0440 ..... 157	50302 ..... 50	5-300020 ..... 200	5383 ..... 125	540-6510R ..... 190
4JR0520 ..... 157	5031 ..... 127	5-300030 ..... 200	538-3/4 ..... 39	540-6716B ..... 190
4JR0525 ..... 157	5033 ..... 127	530-10202 ..... 198	538-3/4 ..... 255	540-6716L ..... 190
4JR0525U ..... 158	5035 ..... 127	530-10203 ..... 198	538-3/8 ..... 39	540-6716R ..... 190
4JR0530 ..... 157	5036 ..... 127	530-11029 ..... 198	538-3/8 ..... 255	540-6716S ..... 190
4JR0530U ..... 158	5041 ..... 127	530-30752 ..... 198	538-3-1/8 ..... 39	540-6900L ..... 190
4JR0535 ..... 157	5042 ..... 127	530-30755 ..... 198	538-3-1/8 ..... 255	540-6900R ..... 190
4JR0535U ..... 158	5046 ..... 127	530-30756 ..... 198	5384 ..... 125	5-407 ..... 200
4JR0540 ..... 157	5053-3 ..... 20	530-30757 ..... 198	538-4-1/8 ..... 39	5-407005 ..... 201
4JR0540U ..... 158	5-05790 ..... 95	530-30818 ..... 198	538-4-1/8 ..... 255	5-407007 ..... 201
4JR0545 ..... 157	5-100020 ..... 200	530-30821 ..... 198	5385 ..... 125	5-407074 ..... 201
4JR0545U ..... 158	5-100030 ..... 200	530-30834 ..... 198	538-5/8 ..... 39	5-407131 ..... 201
4JR0550 ..... 157	510-3400 ..... 203	530-30850 ..... 198	538-5/8 ..... 255	540-799 ..... 97
4JR0550U ..... 158	510-3400-10 .. 203	530-30863 ..... 198	538-7/8 ..... 39	5-408 ..... 201
4JR0555 ..... 157	510-437338 ... 200	530-30876 ..... 198	538-7/8 ..... 255	540-800 ..... 97
4JR0555U ..... 158	510-438338 ... 200	530-30884 ..... 198	5-401 ..... 200	540-805 ..... 97
4JR0560 ..... 157	5107 ..... 122	530-30885 ..... 198	5-401005 ..... 201	540-806 ..... 97
4JR0560U ..... 158	510-D102338 . 200	530-30890 ..... 198	540-1005L ..... 98	540-807 ..... 97
4JR0570 ..... 157	510-D304020 . 200	530-30891 ..... 198	5-401007 ..... 201	540-808 ..... 97
4JR0580 ..... 157	510-D304030 . 200	530-30893 ..... 198	5-401010 ..... 201	540-811B ..... 97
4JR0580U ..... 158	510-D309020 . 200	530-31132 ..... 198	5-401020 ..... 201	5-409 ..... 201
4JR1055 ..... 157	510-D309030 . 200	530-31133 ..... 198	5-401030 ..... 201	5-409005 ..... 201
4JR1060 ..... 157	510-D323020 . 200	5-321020 ..... 200	5-402007 ..... 201	5-409007 ..... 201
4JR1080 ..... 157	510-D323030 . 200	5-321030 ..... 200	540-2110C ..... 93	5-409010 ..... 201
4JR7525 ..... 157	510-D441020 . 200	5-33570 ..... 95	540-2114 ..... 98	540-AK100 ..... 101
4JR7530 ..... 157	5-11830 ..... 47	5-34790 ..... 95	540-278BM0024... ..... 189	540-BH1L ..... 98
4JR7530U ..... 158	5-11840 ..... 47	5380AX ..... 125	540-278HX0002 ... ..... 189	540-CARABINER 191
4JR7535 ..... 157	5-11853 ..... 47	5381 ..... 125		540-DB6 ..... 101
4JR7535U ..... 158	5-11866 ..... 47	538-1/2 ..... 39		540-DISP ..... 93

**PART NUMBER INDEX cont'd**

540-FCTMC5 ... 190	5-42272 ..... 94	561926 ..... 260	5-SCR103-4BULK... 60020 ..... 169
540-FCTMN1 ... 190	542-76220 ..... 181	56-72 ..... 158	..... 102 60030 ..... 169
540-FCTMS1 ... 190	5-429005 ..... 202	56-72220 ..... 158	5-SCR103-4DP 102 60040 ..... 169
540-FCTMS2 ... 190	5-429007 ..... 202	569231 ..... 260	5-SCR103-4DP100 6005 ..... 146
540-GUN..... 237	5-429010 ..... 202	569932 ..... 170	..... 102 60050 ..... 169
540-HU1L..... 98	5-429015 ..... 202	576536 ..... 260	5-SCR103-4DPBULK 60070 ..... 169
540-R8CCRF... 189	5-429020 ..... 202	58278040 ..... 174	..... 102 6010 ..... 146
540-RB125W .. 189	5-429030 ..... 202	58282040 ..... 174	5-SCR61-2DP .. 102 60100 ..... 169
540-RB414M... 189	5-435005 ..... 202	58282240 ..... 174	5-SCR61-2DPBULK. 6011 ..... 125
540-RB418M... 189	5-435007 ..... 202	58282340 ..... 174	..... 102 60110 ..... 169
540-RB610HDM. 189	5-435010 ..... 202	585-F336..... 173	5-SCR63-8 ..... 102 60200 ..... 169
540-RB614HDM. 189	5-435101 ..... 202	585-TG ..... 173	5-SCR63-8BULK 102 60202 ..... 169
540-RB618HDM. 189	5-435102 ..... 202	585-TG1 ..... 173	5-SCR71-2 ..... 102 60205 ..... 169
540-RB624HDM. 189	5-436005 ..... 202	585-TG2 ..... 173	5-SCR71-2BULK 102 60206 ..... 169
540-RB636DW 189	5-436007 ..... 202	585-TG3 ..... 173	5-SCR81 ..... 102 60210 ..... 112
540-RB636W .. 189	5-436010 ..... 202	585-TG4 ..... 173	5-SCR81-12 .... 102 60210CX ..... 112
540-RB656WS 189	5-436074 ..... 203	585-TG5 ..... 173	5-SCR81-12-100 102 60210LX ..... 112
540-RB810HDM. 189	5-436101 ..... 203	585-TG6 ..... 173	5-SCR81-12BULK... 60219 ..... 110
540-RB814HDM. 189	5-436102 ..... 203	585-TG7 ..... 173	..... 102 60220 ..... 110
540-RB956W .. 189	5-436131 ..... 203	585-TG8 ..... 173	5-SCR81-12W .. 102 60220LX ..... 110
540-T50M ..... 187	5-437101 ..... 203	585-TG9 ..... 173	5-SCR81-2 ..... 102 60247 ..... 113
540-T50MOC .. 187	5-437130 ..... 203	590-708 ..... 158	5-SCR81-25M.. 102 60251 ..... 110
5-410 ..... 201	5-437131 ..... 203	59351202 ..... 174	5-SCR81-2BULK 102 60251CX ..... 110
5-410005 ..... 202	5-437210 ..... 203	59351203 ..... 174	5-SCR81-2DP .. 102 60252CX ..... 113
5-410007 ..... 202	5-438101 ..... 203	5-HW5850 ..... 237	5-SCR81-2DPBULK. 60254 ..... 113
5-410010 ..... 202	5-438131 ..... 203	5-IG5850 ..... 237	..... 102 60254CX ..... 113
5-41041 ..... 95	5-447007 ..... 202	5K006..... 147	5-SCR81BULK.. 102 60254LX ..... 113
5-411 ..... 201	5-447010 ..... 202	5-SCR101 ..... 102	5-SCR81DP ..... 102 60256CX ..... 113
5-412 ..... 201	5-448007 ..... 203	5-SCR101-12DP. 102	5-SCR81DPBULK 102 60259HX ..... 111
541-300 ..... 192	5-449007 ..... 202	5-SCR101-12DPBULK	5-SCR82 ..... 102 60263BCX..... 120
5-414 ..... 201	5-449030 ..... 202	..... 102	5-SCR82-100 .. 102 60263BLX ..... 120
5-41411 ..... 95	5-450007 ..... 202	5-SCR101-2 .... 102	5-SCR82BULK.. 102 60263CX ..... 120
5-41455 ..... 95	545-420 ..... 182	5-SCR101-2DP 102	5-SCR82W ..... 102 60264BCX..... 120
5-416 ..... 200	545-422 ..... 182	5-SCR101-2DPBULK	5-SCR83-4 ..... 102 60264CX ..... 120
5-417 ..... 200	545-426 ..... 182	..... 102	5-SCR83-4BULK 102 60265BLX ..... 121
5-417005 ..... 201	545-430 ..... 182	5-SCR101BULK 102	5-SCR83-4DP .. 102 60265LX ..... 121
5-417007 ..... 201	545-440 ..... 182	5-SCR101DP ... 102	5-SCR83-4DPBULK. 60331B ..... 127
5-417010 ..... 201	545-442 ..... 182	5-SCR101DPBULK..	..... 102 60331BE..... 127
5-417012 ..... 201	545-460 ..... 182	..... 102	5-SCRMS..... 101 60331R ..... 127
5-417020 ..... 201	5-474007 ..... 203	5-SCR102DP ... 102	6000 ..... 125 6101 ..... 125
5-417030 ..... 201	5-500 ..... 98	5-SCR102DPBULK..	60000 ..... 169 6102 ..... 125
5-418 ..... 200	552430 ..... 260	..... 102	6001 ..... 125 6103E..... 146
542-25015 ..... 181	560465 ..... 260	5-SCR103-4 .... 102	60010 ..... 169 6105E..... 146

## PART NUMBER INDEX cont'd

6107E..... 146	620-18-2P ..... 174	620-6-2 ..... 155	6226CX ..... 113	6242 ..... 112
6110E..... 146	620-18-3 ..... 174	620-700 ..... 165	6227 ..... 113	6-2424L..... 87
6-1200 ..... 47	620-18-3P ..... 174	620-701 ..... 165	6227LX ..... 113	6242LX ..... 112
61202 ..... 113	620-18-4 ..... 174	620-702 ..... 165	6228 ..... 113	6244 ..... 112
61214 ..... 113	620-18-5 ..... 174	620-703 ..... 165	6228LX ..... 113	6244LX ..... 112
61220 ..... 110	620-18-6 ..... 174	620-704 ..... 165	6229 ..... 110	6251 ..... 110
61221CX ..... 110	620-18-6P ..... 174	620-705 ..... 165	6229LX ..... 110	625-1301W .... 165
61221LX ..... 110	620-18-7 ..... 174	6207E..... 146	6230 ..... 112	625-16-6 ..... 167
61223LX ..... 110	620-18-8 ..... 174	6208 ..... 112	623-000 ..... 176	625-16-690 .... 167
61233LX ..... 111	620-18-8P ..... 174	620-8-2 ..... 155	623-001 ..... 176	625-183 ..... 155
61234LX ..... 110	620-200 ..... 166	6208LX ..... 112	623-002 ..... 176	6251CX ..... 110
61235LX ..... 110	620-201 ..... 166	6209 ..... 112	623-003 ..... 176	6251LX ..... 110
6-12-4NM ..... 152	620-20-10 ..... 174	6209LX ..... 112	623-004 ..... 176	6252 ..... 113
6-12-4NMSP ... 153	620-202 ..... 166	6210 ..... 112	623-005 ..... 176	625-2132B .... 166
6-12-4NMSWP 153	620-20-3 ..... 174	6210E..... 146	623-006 ..... 176	625-2132V .... 166
61252NX ..... 113	620-20-4 ..... 174	6211 ..... 112	623-007 ..... 176	625-2132W .... 166
61256LX ..... 113	620-20-5 ..... 174	6211CX ..... 112	623-008 ..... 176	625-2134V .... 166
6-12-6NM ..... 152	620-20-6 ..... 174	6212 ..... 112	623-012 ..... 176	625-2134W .... 166
6-12-6NMP .... 153	620-20-7 ..... 174	6212CX ..... 112	623-013 ..... 176	625-270W ..... 165
6-12-6NMR .... 153	620-20-8 ..... 174	6213 ..... 110	623-014 ..... 176	6252LX ..... 113
6-12-6NMS .... 152	6-202-1 ..... 100	6213CX ..... 110	6230CX ..... 112	625-304 ..... 155
6-12-6NMSP ... 153	6-202-2 ..... 100	6214 ..... 110	6231 ..... 112	625-305 ..... 155
6-12-6NMSWP 153	620-252 ..... 166	6214CX ..... 110	6231CX ..... 112	6253CX ..... 113
6-12-8NMSWP 153	620-253 ..... 166	6215 ..... 113	6231LX ..... 112	6253LX ..... 113
6182 ..... 130	620-254 ..... 166	6216 ..... 113	6232 ..... 112	6255 ..... 113
6183 ..... 130	620-255 ..... 166	6216CX ..... 113	6232CX ..... 112	6255CX ..... 113
6-1838L..... 87	620-274W ..... 166	6216LX ..... 113	6232LX ..... 112	6255LX ..... 113
6-1838S ..... 87	6203E..... 146	6217 ..... 112	6233 ..... 110	6257 ..... 113
6184 ..... 130	620-401 ..... 165	6217CX ..... 112	6233LX ..... 110	6257NX ..... 113
6185 ..... 130	620-403 ..... 165	6217LX ..... 112	6234 ..... 110	6258 ..... 111
6186 ..... 130	620-404 ..... 165	6218 ..... 110	6234LX ..... 110	625-800 ..... 155
6187 ..... 130	620-406 ..... 165	6218CX ..... 110	6235 ..... 110	625-801 ..... 155
6193 ..... 131	620-409 ..... 165	6218LX ..... 110	6235CX ..... 110	625-810 ..... 155
6194 ..... 131	620-411 ..... 165	6219 ..... 110	6235LX ..... 110	625-811 ..... 155
6195X..... 131	6205E..... 146	6219LX ..... 110	6236LX ..... 113	6258CX ..... 111
62000AX..... 121	620-600 ..... 165	6220 ..... 110	6237 ..... 113	6259 ..... 111
6200BSX..... 113	620-601 ..... 165	6220CX ..... 110	6237LX ..... 113	6259CX ..... 111
6200HX ..... 111	620-604 ..... 165	6222 ..... 112	6238 ..... 113	625-AF10..... 47
620-10-2 ..... 155	620-605 ..... 165	6222LX ..... 112	6238LX ..... 113	625-AF12..... 47
620-12-2 ..... 155	620-608 ..... 163	6223 ..... 112	6239 ..... 113	625-AF14..... 47
620-14-2 ..... 155	620-6081 ..... 163	6223LX ..... 112	6239LX ..... 113	625-AF6..... 47
620-18-10 ..... 174	620-6082 ..... 163	6224 ..... 110	623-MIX ..... 176	625-AF8..... 47
620-18-2 ..... 174	620-6083 ..... 163	6224CX ..... 110	6241 ..... 112	625-B1 ..... 167

## PART NUMBER INDEX cont'd

625-CR15W .... 165	6263CX ..... 121	6285LX ..... 111	6332R ..... 127	6364W ..... 128
625-CR20W .... 165	6263DX ..... 121	6286 ..... 111	6332W ..... 127	6365R ..... 128
625-CS120W .. 165	6263LX ..... 121	6287CX ..... 112	6333B ..... 127	6-3660L ..... 87
625-IS5 ..... 155	6264BCX ..... 120	6287XX ..... 112	6333G ..... 127	6-3660S ..... 87
625-S13 ..... 166	6264CX ..... 120	6288 ..... 111	6333R ..... 127	6370 ..... 131
625-S14 ..... 166	6264LX ..... 120	6288LX ..... 111	6333W ..... 127	6371 ..... 131
625-S15 ..... 166	6265BCX ..... 120	6289 ..... 111	6334B ..... 127	6383-325 ..... 128
625-S16 ..... 166	6265BLX ..... 120	6289LX ..... 111	6334G ..... 127	6383-35 ..... 128
625-S17 ..... 166	6266BLX ..... 120	6291 ..... 132	6334R ..... 127	6384-325 ..... 128
625-S18 ..... 166	626-6S ..... 163	6291CX ..... 132	6334W ..... 127	6384-35 ..... 128
625-S19 ..... 166	6267MX ..... 121	6292 ..... 132	6335B ..... 127	6401 ..... 123
625-S20 ..... 166	6268BMX ..... 121	6292CX ..... 132	6335G ..... 127	640-122 ..... 155
626-10S ..... 163	6269 ..... 121	6293 ..... 132	6335R ..... 127	640-142 ..... 155
626-10T ..... 162	6269LX ..... 121	6293CX ..... 132	6335W ..... 127	6402 ..... 123
626-15 ..... 163	6269MX ..... 121	6294 ..... 132	6336 ..... 128	6403 ..... 123
626-15S ..... 163	626-AT0003 ... 163	6294CX ..... 132	6337 ..... 128	6404 ..... 123
626-15T ..... 162	626-AT0005 ... 163	6295X ..... 132	6338 ..... 128	6405CM ..... 146
6261BCX ..... 121	626-HASR10 ... 162	6296 ..... 132	6339XL ..... 128	6407CM ..... 146
6261CX ..... 121	626-HASR15 ... 162	6296CX ..... 132	6340 ..... 128	640-845 ..... 155
626-20 ..... 163	626-HASR20 ... 162	6298 ..... 132	6341 ..... 128	640-AF2 ..... 50
626-20S ..... 163	626-HASR25 ... 162	6298LX ..... 132	6342 ..... 128	640-AF25 ..... 50
626-20T ..... 162	626-HASR30 ... 162	6301 ..... 146	6343 ..... 128	640-AF3 ..... 50
626-23133 .... 163	626-HASR40 ... 162	6303 ..... 146	6-34-4 ..... 152	640-FD2B ..... 50
626-25 ..... 163	626-HASR60 ... 162	6-3030L ..... 87	6-34-4NM ..... 152	640-FD2S ..... 50
626-25T ..... 162	6270 ..... 111	6-3050L ..... 87	6-34-4NMSP ... 153	640-FD3S ..... 50
626-26311 .... 163	6270LX ..... 111	6-3060L ..... 87	6-34-6 ..... 152	640-FSK2 ..... 50
6-2626L ..... 87	6272 ..... 113	6-3060L-100 .... 87	6-34-6NM ..... 152	640-FSK3 ..... 50
6262BCX ..... 121	6-2739L ..... 87	6-3060S ..... 87	6-34-6NMR ..... 153	640-UL25 ..... 50
6262BLX ..... 121	6274 ..... 113	63070 ..... 131	6-34-6NMS ..... 152	640-UL3 ..... 50
6262BMX ..... 121	6-2748L ..... 87	6310X ..... 126	6-34-6NMSP ... 153	6410CM ..... 146
6262CX ..... 121	6-2748L-100 .... 87	6311 ..... 126	6-34-8 ..... 152	6411 ..... 123
6262LX ..... 121	6274LX ..... 113	6312 ..... 126	6-34-8NM ..... 152	641-14 ..... 235
6262MX ..... 121	6276 ..... 113	6321 ..... 126	6360B ..... 127	6412 ..... 123
626-30 ..... 163	6-2763L ..... 87	6-321 ..... 192	6360R ..... 127	6413 ..... 123
626-30S ..... 163	6276LX ..... 113	6322 ..... 126	6360W ..... 127	6414 ..... 123
626-30T ..... 162	6277 ..... 111	6-3263L ..... 87	6361B ..... 128	6415 ..... 123
626-38071 .... 163	6277NX ..... 111	6-3263S ..... 87	6361R ..... 128	6416 ..... 123
626-38073 .... 163	6281 ..... 110	6-330 ..... 90	6362B ..... 128	64235201 ..... 174
626-38632 .... 163	6281LX ..... 110	6330-4 ..... 128	6362R ..... 128	64275801 ..... 174
626-38636 .... 163	6282 ..... 110	6330-6 ..... 128	6362W ..... 128	64846401 ..... 174
6263BCX ..... 121	6282LX ..... 110	6331 ..... 128	6363W ..... 128	650-001 ..... 48
6263BDX ..... 121	6283LX ..... 111	6332B ..... 127	6364B ..... 128	650-002 ..... 48
6263BLX ..... 121	6285 ..... 111	6332G ..... 127	6364R ..... 128	650-003 ..... 48

## PART NUMBER INDEX cont'd

650-005 ..... 48	6702 ..... 123	6903 ..... 146	6-R50A..... 47	708-850 ..... 158
650-006 ..... 48	6703 ..... 123	6905 ..... 146	6-REF401 ..... 188	7-100 ..... 100
650-008 ..... 49	6703CM..... 146	6907 ..... 146	6-T1191 ..... 193	710-001 ..... 49
650-010 ..... 49	6704 ..... 123	6943CX ..... 124	6-T482 ..... 193	710-002 ..... 49
650-011 ..... 48	6704-2X..... 123	6945CX ..... 124	6-T744 ..... 189	710-003 ..... 49
650-012 ..... 48	6705CM..... 146	6946CX ..... 124	701-001 ..... 196	710-004 ..... 49
650-013 ..... 48	6706 ..... 123	6953CX ..... 124	701-002 ..... 196	710-005 ..... 49
650-014 ..... 48	6706-2X..... 123	6955CX ..... 124	701-003 ..... 196	710-100 ..... 50
650-016 ..... 48	6707CM..... 146	6956CX ..... 124	701-006 ..... 196	710-101 ..... 50
650-017 ..... 48	6710CM..... 146	698527 ..... 260	701-007 ..... 196	710-102 ..... 50
650-020 ..... 49	6722 ..... 124	6-CT700F ..... 192	701-009 ..... 196	710-103 ..... 50
650-021 ..... 48	6722-2X..... 124	6-FT80H ..... 192	701-011 ..... 196	710-104 ..... 50
650-023 ..... 48	6724 ..... 124	6-FT80R ..... 192	701-012 ..... 196	710-105 ..... 50
650-031 ..... 48	6724-2X..... 124	6-GPK035 ..... 186	701-013 ..... 196	710-106 ..... 50
650-036 ..... 48	6730 ..... 123	6-HAB-BG ..... 33	701-014 ..... 196	710-182G ..... 49
650-038 ..... 48	6731 ..... 123	6-HDT303K..... 192	701-015 ..... 196	710-185G ..... 49
650-074 ..... 48	6732 ..... 123	6-HG15 ..... 186	701-017 ..... 196	7101CX ..... 117
6500A ..... 123	6733 ..... 123	6-HK2748 ..... 88	701-018 ..... 197	7101HCX ..... 117
6501 ..... 123	6-733 ..... 90	6-HK2748-1 ..... 88	701-019 ..... 197	7102CX ..... 117
650-100 ..... 47	6-734 ..... 90	6-HK2748-SAM 264	701-020 ..... 197	7102HCX ..... 117
6501CX ..... 123	6735 ..... 123	6-HK2766 ..... 88	701-023 ..... 197	7103CX ..... 117
6502 ..... 123	6-735 ..... 90	6-HK2766-1 ..... 88	701-025 ..... 197	7-1058 ..... 260
650-200 ..... 47	6-736 ..... 90	6-HK3050 ..... 88	701-028 ..... 197	7105LX ..... 117
6503 ..... 123	675-P521U ..... 173	6-HK3050-1 ..... 88	701-029 ..... 197	7106CX ..... 117
650-300 ..... 47	675-P621U ..... 173	6-HK3050HD ..... 88	701-030 ..... 197	7-1078 ..... 260
6503CX ..... 123	675-P721UT... 173	6-HK3060 ..... 88	701-031 ..... 197	710-A16100 ..... 49
6505 ..... 123	675-P722U ..... 173	6-HK3060-1 ..... 88	701-032 ..... 197	710-A1650 ..... 49
6505LX ..... 123	675-PSD010BF 173	6-HK3060HD ..... 88	701-033 ..... 197	710-A1710 ..... 49
6526 ..... 123	675-PSD111 ... 173	6-HK3070HD ..... 88	701-034 ..... 197	7-10KOTN100 . 162
6528 ..... 123	675-PSDH121 . 173	6-HK3364FUR... 88	701-035 ..... 197	7-10KOTN30... 162
6601 ..... 123	675-PSM30SA. 173	6-HK3378FUR... 88	701-037 ..... 197	7-10KOTN35... 162
6602 ..... 123	675-PSM40SA. 173	6-M22 ..... 88	701-038 ..... 197	7-10KOTN40... 162
6603 ..... 123	675-PSP722E.. 173	6-M24 ..... 88	701-039 ..... 197	7-10KOTN45... 162
6622 ..... 123	68000HX ..... 124	6-M26 ..... 88	701-040 ..... 197	7-10KOTN50... 162
6623 ..... 123	6803 ..... 147	6-M2748 ..... 88	701-041 ..... 196	7-10KOTN60... 162
6641 ..... 123	6853 ..... 124	6-M2763 ..... 88	701-043 ..... 196	7-10KOTN70... 162
6642 ..... 123	6855 ..... 124	6-M30 ..... 88	701-046 ..... 197	7-10KOTN80... 162
6643 ..... 123	6858 ..... 124	6-M3030 ..... 88	7033 ..... 123	7-10KOTN90... 162
6644 ..... 123	6859 ..... 124	6-M3030-SAM . 264	7034 ..... 123	7-10P..... 89
6645 ..... 123	6865 ..... 124	6-M3050 ..... 88	7036X ..... 123	710-P100 ..... 50
6685 ..... 123	6866 ..... 124	6-M3060 ..... 88	706562 ..... 260	7111CX ..... 117
6700AX ..... 123	6876 ..... 124	6-M3263 ..... 88	7066X ..... 123	7111X ..... 117
6701 ..... 123	6900AX ..... 124	6-P3030L-SAM 264	708023 ..... 260	7-121-18 ..... 260

**PART NUMBER INDEX** cont'd

7-1212 .....260	7-34B50 .....89	750-NMLT90100 154	7-806 .....93	7-ECC12100 ...183
7-121-38 .....260	7-34P.....89	750-NMLT90125 154	7-80632 .....99	7-ECC1225 .....183
7-121-58 .....260	7-381-38 .....260	750-NMLT9050 154	7-80633 .....99	7-ECC1250 .....183
7-122-18 .....260	7-381-58 .....260	750-NMLT9075 154	799-001 .....97	7-ECC16100 ...183
7-122-58 .....260	7-382-18 .....260	750-P60NF.....153	799-002 .....97	7-ECC1625 .....183
7-123-18 .....260	7-382-58 .....260	750-RC841 .....155	799-003 .....97	7-ECC1650 .....183
7-1234 .....260	7-387-18 .....260	750-RC842 .....155	799-004 .....97	7-ECC50725 ...183
7-1238 .....260	7-38B .....89	750-SLTC50 ....154	799-005 .....97	7-ECC50730 ...183
7-1258 .....260	7-38B50 .....89	750-SLTC75 ....154	799-006 .....97	7-ECC50735 ...183
7-1278 .....260	7-38P.....89	750-SLTC9050 154	799-010 .....97	7-L300.....49
7-12B .....89	741-001 .....96	750-SLTC9075 154	799-011 .....97	7-L300.....177
7-12B50 .....89	741-002 .....96	750-TZNMLT100 154	799-012 .....97	7-P24.....49
7-12P.....89	741-003 .....96	750-TZNMLT125 154	799-021 .....97	7-P24.....177
7142 .....116	750-10100 ....154	750-TZNMLT150 154	799-022 .....97	7-P36.....49
7142LX.....116	750-10500 ....154	750-TZNMLT200 154	799-024 .....97	7-P36.....177
7146 .....116	750-12100 ....154	750-TZNMLT38 154	799-025 .....97	7-P36B.....49
7-14B .....89	750-121000 ...154	750-TZNMLT50 154	799-040 .....97	7-P36B.....177
7-14B50 .....89	750-125100 ..154	750-TZNMLT75 154	799-041 .....97	7-P48.....49
7-14P.....89	750-1550 .....154	750-TZNMLT90100	7-AD010000 ...183	7-P48.....177
715328 .....260	750-2050 .....154	.....154	7-AL9V .....93	7-P48B.....49
7-200 .....100	750-34100 ....154	750-TZNMLT90125	7-AL9V-12 .....93	7-P48B.....177
722633 .....260	750-34800 ....154	.....154	7-ALAA .....93	7-SPHW3AAA-BX 184
7233RLX .....116	750-38100 ....154	750-TZNMLT90150	7-ALAA-24 .....93	7-TLC10625 ....183
7234RLX .....116	750-401 .....204	.....154	7-ALAAA .....93	7-TLC10630 ....183
7235RLX .....116	750-402 .....204	750-TZNMLT90200	7-ALAAA-18 .....93	800-008 .....101
7236RLX .....116	750-500 .....154	.....154	7-ALC.....93	800-009 .....101
72-88220 .....158	750-600 .....154	750-TZNMLT9038..	7-ALC-12.....93	803717 .....100
72-88330 .....158	750-MLT50.....154	.....154	7-ALD.....93	804082 .....100
7301 .....116	750-MLT75.....154	750-TZNMLT9050..	7-ALD-12.....93	8200M.....126
7302 .....116	750-MLT9050..154	.....154	7-CRNR100 .....162	8201C .....126
7303 .....116	750-MLT9075..154	750-TZNMLT9075..	7-CRNR15 .....162	8203C .....126
7311L.....116	750-NMLT100 .154	.....154	7-CRNR20 .....162	8220M.....126
7-316 .....89	750-NMLT125 .154	7-5811-B .....177	7-CRNR25 .....162	8233 .....126
7316L.....116	750-NMLT150 .154	7-58B .....89	7-CRNR30 .....162	8282LX.....131
7316X.....116	750-NMLT4550.154	7-58B50 .....89	7-CRNR35 .....162	8284 .....131
7317L.....116	750-NMLT4575.154	7-58P.....89	7-CRNR40 .....162	8284CX-B.....131
7317X.....116	750-NMLT50 ...154	767193 .....100	7-CRNR45 .....162	8286 .....131
7321X.....116	750-NMLT5090-F...	767558 .....100	7-CRNR50 .....162	8286CX-B.....131
7-341-18 .....260	.....154	770-15 .....92	7-CRNR60 .....162	829-995 .....158
7-341-58 .....260	750-NMLT75 ...154	7-711 .....177	7-CRNR70 .....162	840241 .....100
7-342-18 .....260	750-NMLT7590-F...	7-711-B .....177	7-CRNR80 .....162	84DCPLUS.....238
7-342-58 .....260	.....154	7-78P.....89	7-CRNR90 .....162	876765 .....100
7-34B .....89		7-80045 .....100	7-CVMINITUBE ...89	87DCPLUS.....239

## PART NUMBER INDEX cont'd

88-108 .....	158	985 .....	239	ACP36483 .....	22	B-501 .....	181	BPF-12 .....	61
88-108220 .....	158	990 .....	238	ACP38422 .....	22	B-502 .....	181	BPF-13 .....	61
88-108330 .....	158	991 .....	236	ACT-6 .....	187	B-503 .....	181	BPF-14 .....	61
89000 .....	167	992 .....	243	ADB-1 .....	164	B-504 .....	181	BPF-16 .....	61
89002 .....	168	993KIT .....	243	ADB-2 .....	164	B-505 .....	181	BPF-17 .....	61
89003 .....	168	995 .....	239	ADM-1 .....	164	B6-12-4 .....	152	BPF-18 .....	61
89006 .....	168	999KIT .....	239	ADM-2 .....	164	B6-12-4NM .....	152	BPF-20 .....	61
89008 .....	168	A051 .....	149	AER-8 .....	30	B6-12-6 .....	152	BPF-21 .....	61
89009 .....	168	A066 .....	149	AER-8BL .....	30	B6-12-6NM .....	152	BPF-22 .....	61
89223 .....	167	A067 .....	149	AEROSOL-STARTER- KIT .....	234	B-622 .....	182	BPF-23 .....	61
89231 .....	167	A079 .....	149	AG-25 .....	100	B6-34-4NM .....	152	BPF-25 .....	61
89233 .....	167	A0811 .....	149	AG-DD .....	87	B6-34-6 .....	152	BPF-26 .....	61
89236 .....	167	A129 .....	149	AP-DD .....	87	B6-34-6NM .....	152	BPF-27 .....	61
89238 .....	167	A134 .....	149	AP-DK .....	87	B-6H .....	204	BPF-28 .....	61
89312 .....	167	A140 .....	149	AT-1700 .....	170	B-8H .....	204	BPF-29 .....	61
89350 .....	167	A155 .....	149	ATK-1 .....	242	B-924 .....	182	BPF-31 .....	61
89DC .....	239	A157 .....	149	ATK-1P .....	242	B-925 .....	182	BPF-32 .....	61
8-FWH16 .....	102	A163 .....	149	ATK-4 .....	242	B-926 .....	182	BPF-33 .....	61
8-WH16 .....	102	A169 .....	149	AW-8 .....	180	B-927 .....	182	BPF-34 .....	61
900-3 .....	57	A170 .....	149	AW-9 .....	180	B-928 .....	182	BPN-1 .....	60
900-5 .....	57	A171 .....	149	B-1 .....	181	B-929 .....	182	BPN-10 .....	60
900-6 .....	57	A172 .....	149	B-10 .....	182	B-930 .....	182	BPN-11 .....	60
91-2032 .....	59	A173 .....	149	B-10H .....	204	B-931 .....	182	BPN-12 .....	60
91-3042 .....	59	A182 .....	149	B-124 .....	182	B-932 .....	182	BPN-13 .....	60
913290 .....	101	A200 .....	149	B-125 .....	182	B-934 .....	182	BPN-14 .....	60
92-3232 .....	59	A202 .....	149	B-126 .....	182	B-935 .....	182	BPN-15 .....	60
92-4242 .....	59	A213 .....	149	B-127 .....	182	B-996 .....	181	BPN-16 .....	60
940 .....	240	ACB-30 .....	32	B-128 .....	182	B-998 .....	181	BPN-17 .....	60
9410SSR .....	239	ACB-36 .....	32	B-129 .....	182	BNT-1 .....	238	BPN-18 .....	60
944KIT .....	239	ACB-42 .....	32	B-12H .....	204	BNT-32 .....	238	BPN-19 .....	60
947KIT .....	239	ACB-48 .....	32	B-131 .....	182	BP-46 .....	84	BPN-2 .....	60
948KIT .....	239	ACID-ELIM .....	243	B-132 .....	182	BP-46-230 .....	84	BPN-20 .....	60
949814 .....	101	ACK4 .....	191	B-16H .....	204	BPF-01 .....	60	BPN-21 .....	60
971KIT .....	239	ACP-10 .....	92	B-2 .....	181	BPF-02 .....	60	BPN-22 .....	60
9721 .....	151	ACP24242 .....	22	B-20H .....	204	BPF-03 .....	60	BPN-23 .....	60
972KIT .....	239	ACP24243 .....	22	B-24H .....	204	BPF-04 .....	60	BPN-24 .....	60
973KIT .....	243	ACP24362 .....	22	B-26 .....	182	BPF-05 .....	60	BPN-25 .....	60
980 .....	238	ACP30302 .....	22	B-27 .....	181	BPF-06 .....	60	BPN-26 .....	60
98084KIT .....	238	ACP30303 .....	22	B-28H .....	204	BPF-07 .....	61	BPN-28 .....	60
98087KIT .....	238	ACP32322 .....	22	B-32H .....	204	BPF-08 .....	61	BPN-3 .....	60
981 .....	236	ACP32323 .....	22	B-36H .....	204	BPF-09 .....	61	BPN-30 .....	60
983KIT .....	240	ACP36362 .....	22	B-4 .....	181	BPF-10 .....	61	BPN-32 .....	60
984 .....	240	ACP36363 .....	22	B-4H .....	204	BPF-11 .....	61	BPN-34 .....	60



BPN-35 ..... 60	C154-0100 ..... 249	C242-0002 ..... 249	C410-0159 ..... 249	CM-1000 ..... 59
BPN-37 ..... 60	C165-0001 ..... 249	C242-0025 ..... 249	C410-0222 ..... 249	CO-1 ..... 96
BPN-38 ..... 60	C165-0002 ..... 249	C242-0050 ..... 249	C460-0002 ..... 250	COOLWELD-32 234
BPN-39 ..... 60	C165-0007 ..... 249	C242-0090 ..... 249	C460-0025 ..... 250	CP-16 ..... 84
BPN-4 ..... 60	C165-0025 ..... 249	C242-0100 ..... 249	C460-0050 ..... 250	CP-16-230 ..... 84
BPN-40 ..... 60	C165-0032 ..... 249	C242-0150 ..... 249	C460-0090 ..... 250	CP-22 ..... 84
BPN-41 ..... 60	C165-0050 ..... 249	C242-0215 ..... 249	C460-0100 ..... 250	CP-22-230 ..... 84
BPN-43 ..... 60	C165-0058 ..... 249	C242-0295 ..... 249	C460-0150 ..... 250	CP-22-230T ..... 84
BPN-44 ..... 60	C165-0090 ..... 249	C242-0390 ..... 249	C5 ..... 180	CP-22LP ..... 84
BPN-45 ..... 60	C165-0093 ..... 249	C243 ..... 176	C512 ..... 176	CP-22LP-230 ..... 84
BPN-47 ..... 60	C165-0094 ..... 249	C243L ..... 176	C512L ..... 176	CP-22T ..... 84
BPN-5 ..... 60	C165-0100 ..... 249	C245 ..... 176	C533-0050 ..... 250	CP-CV ..... 84
BPN-51 ..... 60	C165-0107 ..... 249	C245L ..... 176	C533-0150 ..... 250	CP-M115 ..... 85
BPN-52 ..... 60	C165-0149 ..... 249	C247 ..... 176	C947-0025 ..... 250	CP-M230 ..... 85
BPN-53 ..... 60	C165-0150 ..... 249	C2-5 ..... 180	C947-0050 ..... 250	CPN1 ..... 176
BPN-54 ..... 60	C165-0159 ..... 249	C254-0002 ..... 248	C947-0100 ..... 250	CPN1C ..... 176
BPN-6 ..... 60	C165-0215 ..... 249	C254-0100 ..... 248	C947-0150 ..... 250	CPN2 ..... 176
BPN-7 ..... 60	C165-0222 ..... 249	C254-0150 ..... 248	C947-0215 ..... 250	CPN2C ..... 176
BPN-8 ..... 60	C165-0223 ..... 249	C272-0002 ..... 248	C947-0295 ..... 250	CPN2M ..... 176
BPN-9 ..... 60	C165-0295 ..... 249	C272-0025 ..... 248	C947-0390 ..... 250	CPN3 ..... 176
BPN-A12 ..... 60	C165-0304 ..... 249	C272-0050 ..... 248	CA-252C ..... 180	CPN3C ..... 176
BPN-A34 ..... 60	C165-0390 ..... 249	C272-0090 ..... 248	CAS-2712 ..... 99	CRO70 ..... 190
BR115 ..... 166	C165-1498 ..... 249	C272-0100 ..... 248	CB-03 ..... 87	CR-1 ..... 96
BR120 ..... 166	C170-0003 ..... 250	C272-0150 ..... 248	CB-2 ..... 86	CRC-1 ..... 96
BR130 ..... 166	C172-0090 ..... 250	C272-0215 ..... 248	CC-1 ..... 85	CRC-13 ..... 96
BR2100 ..... 166	C172-0100 ..... 250	C290-0002 ..... 248	CC33 ..... 170	CRC-1KB ..... 95
BR215 ..... 166	C172-0150 ..... 250	C290-0025 ..... 248	CC33-18 ..... 170	CRC-2 ..... 96
BR220 ..... 166	C172-0215 ..... 250	C290-0050 ..... 248	CC33-24 ..... 170	CRC-3 ..... 96
BR230 ..... 166	C20 ..... 180	C290-0090 ..... 248	CCP-L ..... 183	CRC-4-140 ..... 93
BR240 ..... 166	C222 ..... 176	C290-0100 ..... 248	CCP-M ..... 183	CRC-4CF ..... 93
BR250 ..... 166	C222C ..... 176	C290-0150 ..... 248	CG-AER ..... 234	CRC-4NU ..... 94
BR260 ..... 166	C223 ..... 176	C290-0215 ..... 248	CGB-AER ..... 234	CRC-5 ..... 96
BS-25 ..... 87	C223C ..... 176	C295-0002 ..... 249	CH115 ..... 166	CRC-6 ..... 96
BS-32 ..... 237	C235-0002 ..... 248	C295-0090 ..... 249	CH120 ..... 166	CRC-7-140 ..... 94
C10 ..... 180	C235-0025 ..... 248	C295-0100 ..... 249	CH215 ..... 166	CRC-7PS ..... 94
C101-0050 ..... 248	C235-0050 ..... 248	C295-0150 ..... 249	CH220 ..... 166	CRC-7X ..... 94
C101-0100 ..... 248	C235-0090 ..... 248	C312 ..... 176	CH230 ..... 166	CRC-7Z ..... 94
C101-0150 ..... 248	C235-0100 ..... 248	C312L ..... 176	CH240 ..... 166	CRC-8 ..... 95
C105-0057 ..... 248	C235-0150 ..... 248	C410-0032 ..... 249	CH250 ..... 166	CRC-9 ..... 96
C105-0100 ..... 248	C235-0215 ..... 248	C410-0058 ..... 249	CH260 ..... 166	CRC-CF2 ..... 96
C105-0150 ..... 248	C241 ..... 176	C410-0093 ..... 249	CK-141 ..... 87	CS-1 ..... 85
C105-0215 ..... 248	C241L ..... 176	C410-0107 ..... 249	CLL-1 ..... 243	CS1200 ..... 85
C1-2-6 ..... 180	C242-0001 ..... 249	C410-0149 ..... 249	CLL-4 ..... 243	CS-2 ..... 85

**PART NUMBER INDEX** cont'd

CS-3 ..... 85	D40680500B3B6 ..	D61220350 .... 258	D64A-66 ..... 253	DBF164S..... 257
CT-475M ..... 180	..... 258	D61220400 .... 258	D64A-88 ..... 253	DBF165S..... 257
CT800..... 191	D40820250B3B6 ..	D61220500 .... 258	D68A-4B ..... 253	DC30-3131-18.. 58
CTC-050..... 38	..... 258	D61230250 .... 258	D68A-6C ..... 253	DC30-3131-48.. 58
CTC-065..... 38	D40820350B3B6 ..	D61230400 .... 258	D69A-4A ..... 253	DC30-3131-48.. 58
CTC-080..... 38	..... 258	D61230500 .... 258	D69A-8D ..... 253	DC30-3131-48.. 58
CVENT-2..... 57	D40820500B3B6 ..	D61280250 .... 258	D-90113 ..... 162	DC30-3132-18.. 58
CVENT-2AB ..... 57	..... 258	D61280300 .... 258	D-90118 ..... 162	DC30-3132-24.. 58
CVENT-3..... 57	D40880250B3B6 ..	D61280350 .... 258	D90-290Q..... 161	DC30-3132-36.. 58
CVENT-4..... 57	..... 258	D61280400 .... 258	D90-291Q..... 161	DC30-3132-48.. 58
CVENTCAP2..... 57	D40880350B3B6 ..	D61280500 .... 258	D90-292Q..... 161	DC-4128 ..... 94
CVENTCAP3..... 57	..... 258	D61420250 .... 258	D90-293Q..... 161	DC-9128 ..... 94
CVENTCAP4..... 57	D40880500B3B6 ..	D61420300 .... 258	D90-294Q..... 161	DDS-30 ..... 153
CVMINI..... 84	..... 258	D61420350 .... 258	D90-295Q..... 161	DDS-60 ..... 153
CV-PTRAP ..... 86	D41020250B3B6 ..	D61420400 .... 258	D-90340 ..... 161	DDS-60SW ..... 153
CV-RTRAP ..... 86	..... 258	D61420500 .... 258	D-90341 ..... 161	DDS-60U ..... 153
CVS-2 ..... 57	D41020350B3B6 ..	D61430300 .... 258	D-90342 ..... 161	DE1-10D ..... 253
CVS-3 ..... 57	..... 258	D61430350 .... 258	D90-360 ..... 161	DE13 ..... 122
CV-TUBE..... 86	D41020500B3B6 ..	D61430400 .... 258	D90-370 ..... 161	DE14 ..... 122
CV-UTRAP ..... 86	..... 258	D61430500 .... 258	D90-372 ..... 161	DE1-4B ..... 253
CW-15 ..... 87	D41080250B3B6 ..	D61480250 .... 258	D90-380 ..... 161	DE15 ..... 122
CW-30 ..... 180	..... 258	D61480300 .... 258	D90-382 ..... 161	DE1-6B ..... 253
D20-3132-18 .... 58	D41080350B3B6 ..	D61480350 .... 258	D90-384 ..... 161	DE1-6C ..... 253
D20-3132-24 .... 58	..... 258	D61480400 .... 258	DAD032 ..... 256	DE1-6D ..... 253
D20-3132-36 .... 58	D41080500B3B6 ..	D61480500 .... 258	DAD032S ..... 256	DE1-8D ..... 253
D20-3132-48 .... 58	..... 258	D61820250 .... 258	DAD052 ..... 256	DE1-8E..... 253
D30-3131-24 .... 58	D60A-10 ..... 253	D61820500 .... 258	DAD052S ..... 256	DE23 ..... 122
D30-3131-36 .... 58	D60A-4 ..... 253	D61830250 .... 258	DAD053S ..... 256	DE24 ..... 122
D30-3131-48 .... 58	D60A-8 ..... 253	D61830300 .... 258	DAD082 ..... 256	DE33 ..... 122
D30-3132-18 .... 58	D61020250B3B6 ..	D61830350 .... 258	DAD082S ..... 256	DEP052 ..... 99
D30-3132-24 .... 58	..... 258	D61830400 .... 258	DAD083S ..... 256	DEP8001 ..... 99
D30-3132-36 .... 58	D61020350B3B6 ..	D61880250 .... 258	DAD084S ..... 256	DEP8002 ..... 99
D30-3132-48 .... 58	..... 258	D61880300 .... 258	DAD163 ..... 256	DF-75..... 87
D40620250B3B6 ..	D61020500B3B6 ..	D61880400 .... 258	DAD163S ..... 256	DG321NRB..... 154
..... 258	..... 258	D61880500 .... 258	DAD164S ..... 256	DG322NRB..... 154
D40620350B3B6 ..	D61080250B3B6 ..	D61A-4 ..... 253	DAD303 ..... 256	DG322URB..... 154
..... 258	..... 258	D61A-8 ..... 253	DAD303S ..... 256	DMB-1..... 152
D40620500B3B6 ..	D61080350B3B6 ..	D62A-1010 .... 253	DAD304S ..... 256	DMB-2..... 152
..... 258	..... 258	D62A-44 ..... 253	DAD305 ..... 256	DMB-3..... 152
D40680250B3B6 ..	D61080500B3B6 ..	D62A-66 ..... 253	DBF083S..... 257	DN1-10..... 254
..... 258	..... 258	D62A-88 ..... 253	DBF084S..... 257	DN1-3..... 254
D40680350B3B6 ..	D61220250 .... 258	D64A-1010 .... 253	DBF163..... 257	DN1-4..... 254
..... 258	D61220300 .... 258	D64A-44 ..... 253	DBF163S..... 257	DN1-6..... 254

**PART NUMBER INDEX cont'd**

DN5-4.....254	DPE40324 .....160	DT2-6.....254	EC302240 .....159	ED1711 .....128
DN5-6.....254	DPE403240 ....160	DT2-8.....254	EC303120 .....159	ED179 .....128
DN5-10.....254	DPE403480 ....160	DTK113.....86	EC30324 .....159	ED1876 .....129
DN5-12.....254	DPE404120 ....160	DTK113B.....86	EC303240 .....159	ED1876-I .....129
DN5-14.....254	DPE404240 ....160	DTK205.....86	EC303277 .....159	ED1877 .....129
DN5-4.....254	DPE404277 ....160	DTK207.....86	EC402120 .....159	ED252 .....129
DN5-6.....254	DPE503120 ....160	DTK210.....86	EC40224 .....159	ED270 .....129
DN5-8.....254	DPE50324 .....160	DTP-3.....164	EC402240 .....159	ED270-I.....129
DP-1 .....180	DPE503240 ....160	DTT-10 .....95	EC403120 .....159	ED273 .....122
DP2-10 .....254	DPE602120 ....160	DTT-24 .....95	EC40324 .....159	ED273CX .....122
DP2-4 .....254	DPE603120 ....160	DU1-10D.....254	EC403240 .....159	ED277 .....130
DP2-6 .....254	DPE60324 .....160	DU1-10E .....254	EC403277 .....159	ED2867 .....128
DP2-8 .....254	DPE603240 ....160	DU1-12D.....254	EC503120 .....159	ED2887 .....129
DPB222R .....154	DPE753120 ....160	DU1-4B .....254	EC50324 .....159	ED320 .....131
DPE252120 ....160	DPE75324 .....160	DU1-6B .....254	EC503240 .....159	ED406 .....121
DPE25224 .....160	DPE753240 ....160	DU1-6C.....254	EC503277 .....159	ED419 .....129
DPE252240 ....160	DPE903120 ....160	DU1-6D.....254	EC603120 .....159	ED4409 .....129
DPE253120 ....160	DPE90324 .....160	DU1-6E .....254	EC60324 .....159	ED447 .....130
DPE25324 .....160	DPE903240 ....160	DU1-8B .....254	EC603240 .....159	ED448B .....130
DPE253240 ....160	DPEAUX10.....160	DU1-8D.....254	EC603277 .....159	ED4509 .....129
DPE301120 ....160	DPEAUX11 .....160	DU1-8E .....254	EC753120 .....159	ED453 .....130
DPE30124 .....160	DPEAUX11QC..160	DU2-10.....254	EC75324 .....159	ED454 .....130
DPE301240 ....160	DPEAUX20.....160	DU2-12 .....254	EC753240 .....159	ED455 .....130
DPE302120 ....160	DPEAUX22.....160	DU2-4 .....254	EC753277 .....159	ED468 .....130
DPE30224 .....160	DPRO63 .....161	DU2-6 .....254	EC903120 .....159	ED4867 .....129
DPE302240 ....160	DPRO64 .....161	DU2-8 .....254	EC90324 .....159	ED494 .....130
DPE302277 ....160	DPRO66 .....161	DU3-10E .....255	EC903240 .....159	ED5225 .....129
DPE303120 ....160	DPSG-2S .....257	DU3-6D.....255	EC903277 .....159	ED600 .....131
DPE30324 .....160	DPSG-3MF.....257	DUCT-FRESH-16 240	ECO-COIL .....233	ED601 .....131
DPE303240 ....160	DPSG-3S .....257	DUCT-FRESH-32 240	ECO-COIL-32 ...233	ED602 .....131
DPE303277 ....160	DPSG-4MF.....257	DUCT-FRESH-8 240	ECO-COIL-5 .....233	ED603 .....131
DPE303480 ....160	D-SCALE .....242	DUS4-4 .....255	ECO-COIL-55 ...233	ED610 .....131
DPE304120 ....160	DSL13-5SVHH256	DUS4-6 .....255	ECO-COIL-AER .233	ED611 .....131
DPE30424 .....160	DSL13-6SVHH256	DX-3 .....256	ECR01-12W ....152	ED612 .....131
DPE304240 ....160	DSL13-7SVHH256	DX-4 .....256	ECR01-9W .....152	ED613 .....131
DPE304277 ....160	DSL13-9SVHH256	DXA-5.....256	ED1232 .....130	ED620 .....131
DPE401120 ....160	DSL154-11SVHH ...	EC-1 .....47	ED1238 .....130	ED621 .....131
DPE40124 .....160	.....256	EC252120 .....159	ED1240-2 .....130	ED710 .....131
DPE402120 ....160	DSP-1 .....164	EC25224 .....159	ED1262-2 .....130	ED877 .....129
DPE40224 .....160	DST-5.....159	EC252240 .....159	ED1262-2I .....130	ED9726 .....130
DPE402240 ....160	DST-6.....159	EC252277 .....159	ED1301 .....130	ED-AT3 .....127
DPE402480 ....160	DT2-10.....254	EC302120 .....159	ED1301-I .....130	ED-AT5 .....127
DPE403120 ....160	DT2-4.....254	EC30224 .....159	ED1709 .....128	ED-CR15 .....127

**PART NUMBER INDEX** cont'd

ED-CR20 ..... 127	EL3648-2 ..... 19	EP5252-3..... 23	GC275..... 170	HC5416X ..... 125
ED-CR25 ..... 127	EL3648-3 ..... 19	EP5658-3..... 23	GC277 ..... 170	HC5420 ..... 125
ED-CR30 ..... 127	EL3842-2 ..... 19	ET130C1 ..... 170	GG-1 ..... 86	HC5424 ..... 125
ED-CR35 ..... 127	EL3842-3 ..... 19	ET22 ..... 170	GG-1A..... 86	HC5436 ..... 125
ED-CR40 ..... 127	EL3870-3 ..... 19	ET33 ..... 169	GG-1BOR ..... 86	HC6202 ..... 125
ED-CR45 ..... 127	EL4040-3 ..... 19	ET35G..... 170	GG-1H..... 86	HC6203 ..... 125
ED-CR50 ..... 127	EL4558-3 ..... 19	ET35N..... 170	GG-1TF ..... 86	HCO-128..... 94
ED-CR60 ..... 127	EL4848-3 ..... 19	ET35R ..... 170	GGC-12..... 86	HCO-15..... 94
EDS-12-6NM ... 153	EL5042-3 ..... 19	ET35W ..... 170	GGC-6..... 86	HCO-7 ..... 94
EDS-60U ..... 153	EL5060-3 ..... 19	ET44 ..... 169	GN-23H..... 101	HCP-15 ..... 94
EE-5311 ..... 150	EL5070-3 ..... 19	ET75 ..... 87	GP1-40BL..... 101	HCP-7 ..... 94
EE-5411 ..... 150	EL5252-3 ..... 19	ET75-KIT..... 87	GV06 ..... 171	HDR-101 ..... 172
EE-5611 ..... 150	EL5658-3 ..... 19	FA-01 ..... 87	GV07 ..... 171	HDR-102 ..... 172
EE-5811 ..... 150	EM480 ..... 130	FA-02 ..... 87	GV08 ..... 171	HDR-201 ..... 172
EFHC-0118-3Y0118	EM484 ..... 130	FA-03 ..... 87	GV10 ..... 171	HDR-202 ..... 172
..... 58	EP1838-3..... 23	FAK-10 ..... 98	GV12 ..... 171	HDR-211 ..... 172
EFHC-0124-3Y0124	EP2424-2..... 23	FAK-25 ..... 98	GV14 ..... 171	HDR-212 ..... 172
..... 58	EP2424-3..... 23	FB-1 ..... 30	GVA1 ..... 171	HDR-221 ..... 172
EFLF-ISV-HCTP ... 58	EP2436-2..... 23	FF-1000-S ..... 31	GVA2 ..... 171	HDR-222 ..... 172
EG ..... 235	EP2436-3..... 23	FF-250-S ..... 31	H1840-4 ..... 21	HEK-500..... 172
EG-5 ..... 235	EP2448-3..... 23	FF-250-UNI..... 31	H2424-4 ..... 21	HFL-4257 ..... 172
EG-55 ..... 235	EP2626-2..... 23	FF-400-S ..... 31	H2436-4 ..... 21	HFL-4300 ..... 172
EL1838-3 ..... 19	EP3030-2..... 23	FF-600-S ..... 31	H3030-4 ..... 21	HFL-4333 ..... 172
EL2424-2 ..... 19	EP3030-3..... 23	FH-1 ..... 163	H3232-4 ..... 21	HFL-5257 ..... 172
EL2424-3 ..... 19	EP3036-2..... 23	FLOW-PLUS-10. 241	H3636-4 ..... 21	HFL-5258 ..... 172
EL2430-2 ..... 19	EP3232-2..... 23	FLOW-PLUS-125. 241	H3642-4 ..... 21	HFL-5300 ..... 172
EL2436-2 ..... 19	EP3232-3..... 23	FLOW-PLUS-200. 241	H3648-4 ..... 21	HFL-5301 ..... 172
EL2436-3 ..... 19	EP3434-2..... 23	FLOW-PLUS-25. 241	H3652-4 ..... 21	HFL-5333 ..... 172
EL2448-3 ..... 19	EP3434-3..... 23	FLOW-PLUS-6... 241	H3654-4 ..... 21	HMD1840-4 ..... 21
EL2626-2 ..... 19	EP3636-2..... 23	FMO450 ..... 49	H3656-4 ..... 21	HMD3030-4 ..... 21
EL3030-2 ..... 19	EP3636-3..... 23	FP-22 ..... 84	H3672-4 ..... 21	HMD3636-4 ..... 21
EL3030-3 ..... 19	EP3640-3..... 23	FP-22-230..... 84	H3852-4 ..... 21	HMD3648-4 ..... 21
EL3036-2 ..... 19	EP3648-2..... 23	FP-36 ..... 99	H3865-4 ..... 21	HMD4040-4 ..... 21
EL3040-2 ..... 19	EP3648-3..... 23	FRL12-F..... 259	H3872-4 ..... 21	HMR-130..... 172
EL3232-2 ..... 19	EP3842-2..... 23	FRL14-F..... 259	H4040-4 ..... 21	HP3232-8 ..... 23
EL3232-3 ..... 19	EP3842-3..... 23	FRL38-F..... 259	H4242-4 ..... 21	HP3636-8 ..... 23
EL3244-3 ..... 19	EP3870-3..... 23	FRL58-F..... 259	H4558-4 ..... 21	HPR-12 ..... 30
EL3434-2 ..... 19	EP4040-3..... 23	FTL3..... 191	H5557-4 ..... 21	HPR-3..... 30
EL3434-3 ..... 19	EP4558-3..... 23	FTL3D ..... 191	HC-1 ..... 21	HPR-3-2P..... 30
EL3636-2 ..... 19	EP4848-3..... 23	FUL0425 ..... 48	HC-1-100 ..... 21	HPR-3-2PG ..... 30
EL3636-3 ..... 19	EP5042-3..... 23	FUL0625 ..... 48	HC5410 ..... 125	HPR-3BL ..... 30
EL3640-2 ..... 19	EP5060-3..... 23	GA-06 ..... 180	HC5410X ..... 125	HPR-6..... 30
EL3640-3 ..... 19	EP5070-3..... 23	GA-30 ..... 180	HC5416 ..... 125	HPR-6-2P..... 30

HPR-6-2PG ..... 30	IGN-401 ..... 56	LIT-FLY-HEAT ..... 264	MG-RGB ..... 186	MKT-POP-DEVELEC .....
HPR-6BL ..... 30	IGN-402 ..... 56	LIT-FLY-HEF ..... 264	MG-RGR ..... 186	..... 265
HPR-EXT ..... 30	IGN-403 ..... 56	LIT-FLY-HPAD ..... 264	MHP-4 ..... 187	MKT-POP-DEVEZC ..
HS03 ..... 171	IGN-405 ..... 56	LIT-FLY-HRP ..... 264	MKT-BANNER ... 265	..... 265
HS04 ..... 171	IGN-406 ..... 56	LIT-FLY-HSI ..... 264	MKT-MAT-COILTAB ...	MKT-POP-DTBACKS ..
HS06 ..... 171	IGN-407 ..... 56	LIT-FLY-MDP ..... 264	..... 265	..... 265
HS08 ..... 171	IGN-408 ..... 56	LIT-FLY-MOTORS 264	MKT-MERCH-CHEM ..	M K T - P O P -
HS-144 ..... 190	IGN-409 ..... 56	LIT-FLY-PF ..... 264	..... 265	DTBACKSSLAT .. 265
HS-192 ..... 191	IGN-410 ..... 56	LIT-FLY-PF-S ..... 264	MKT-MERCH-DPWIRE	MKT-POP-DUCT 265
HS-30 ..... 191	IGN-412 ..... 56	LIT-FLY-PUMP ... 264	..... 265	MKT-POP-DUCTSAM
HS-30-2 ..... 191	IQP-120 ..... 84	LIT-FLY-QS ..... 264	MKT-MERCH-FLEX ...	..... 264
HS-60 ..... 191	IQP-120T ..... 84	LIT-FLY-RPC ..... 264	..... 265	MKT-POP-EASEL 264
HS-60-2 ..... 191	ISO-18 ..... 24	LIT-FLY-RPC-S ... 264	MKT-MERCH-RSC 265	MKT-POP-ET ..... 265
HSA1 ..... 171	ISO-2 ..... 24	LIT-FLY-RSC ..... 264	MKT-MERCH-SEAL12	MKT-POP-HSI ..... 265
HSA2 ..... 171	ISO-4 ..... 24	LIT-FLY-SEAL ..... 264	..... 265	MKT-POP-PF ..... 265
HSK1 ..... 159	JB8265 ..... 99	LIT-FLY-SPCH18 264	MKT-MERCH-SEAL30	MKT-POP-QSBACK ..
HSK5 ..... 159	LIT-CAT-HVAC ... 264	LIT-FLY-SPRAYER 264	..... 265	..... 265
HT1840-4 ..... 21	LIT-CAT-QS ..... 264	LIT-FLY-SPRAYER-S ..	MKT-MERCH-SENTRY	MKT-POP-QSMSBOX
HT2436-4 ..... 21	LIT-CAT-SEAL ... 264	..... 264	..... 265	..... 265
HT3030-4 ..... 21	LIT-FLY-3D ..... 264	LIT-FLY-SPTEAROFF .	M K T - M E R C H -	MKT-POP-QSWIBOX
HT3232-4 ..... 21	LIT-FLY-3D-S ..... 264	..... 264	SWITCHWIRE ... 265	..... 265
HT3636-4 ..... 21	LIT-FLY-BPPOOL 264	LIT-FLY-TRIPBOOST ..	M K T - M E R C H -	M K T - P O P -
HT3648-4 ..... 21	LIT-FLY-CDLC ... 264	..... 264	USACAPS ..... 265	SWITCHBACK ... 265
HT3842-4 ..... 21	LIT-FLY-CLAD ... 264	LIT-FLY-UC ..... 264	MKT-POP-BROCH 264	MKT-POP-WS ... 265
HT4040-4 ..... 21	LIT-FLY-CLRVUE . 264	LIT-FLY-UCSTRAP 264	MKT-POP-BROCH4 ..	MKT-POP-WSDEMO
HT4242-4 ..... 21	LIT-FLY-COIL ..... 264	LIT-FLY-UV ..... 264	..... 264	..... 264
HT4558-4 ..... 21	LIT-FLY-COIL-S .. 264	LIT-FLY-VENTS... 264	MKT-POP-CDLC 265	MKT-POSTER-CHT24E
HVENT-2 ..... 57	LIT-FLY-COND ... 264	LIT-FLY-WS ..... 264	MKT-POP-CHEM 265	..... 265
HVENT-3 ..... 57	LIT-FLY-CS1200 264	LSB10-BL ..... 258	MKT-POP-CLRGOND	MKT-POSTER-CHT24S
IC00-15 ..... 38	LIT-FLY-CVMINI . 264	LSB10-W ..... 258	..... 265	..... 265
IC00-20 ..... 38	LIT-FLY-CVMINI-S 264	M-1 ..... 187	MKT-POP-CLRSHELF	M K T - P O S T E R -
IC00-22 ..... 38	LIT-FLY-DISC ..... 264	M-1R ..... 187	..... 265	CHT36E ..... 265
IC00-25 ..... 38	LIT-FLY-DST10 .. 264	M-2 ..... 187	MKT-POP-CLRSTAND	M K T - P O S T E R -
IC00-28 ..... 38	LIT-FLY-DTP3 ... 264	M-2R ..... 187	..... 265	CLRVUE ..... 265
IC00-32 ..... 38	LIT-FLY-DTP3ES . 264	M-3 ..... 187	MKT-POP-CVTUBE ...	MKT-POSTER-HPAD .
IC00-35 ..... 38	LIT-FLY-ELITE ..... 264	M-3R ..... 187	..... 265	..... 265
IC00-40 ..... 38	LIT-FLY-ET ..... 264	M-5 ..... 187	MKT-POP-DEVBACKS	MKT-POSTER-MSPLIT
IC00-42 ..... 38	LIT-FLY-FLEX ..... 264	MAG-1 ..... 191	..... 265	..... 265
IC00-50 ..... 38	LIT-FLY-FLOW ... 264	MB21 ..... 170	M K T - P O P -	MKT-SAM-ELEC . 264
IC00-54 ..... 38	LIT-FLY-FLXHOSEKIT .	MB22 ..... 170	DEVBACKSSLAT 265	MKT-SAM-HSI ... 264
IGN-001 ..... 56	..... 264	MBK-6 ..... 86	MKT-POP-DEVCOMBO	MP-12 ..... 24
IGN-2 ..... 56	LIT-FLY-FOOT ... 264	MDSCN111 ..... 59	..... 265	MP-12C ..... 24
IGN-2-6P ..... 56	LIT-FLY-GG ..... 264	MG-1 ..... 186		MP-12E ..... 24

**PART NUMBER INDEX** cont'd

MP-18.....24	PC-609-B ..... 50	PI307..... 121	PI377..... 119	PPC-16 ..... 199
MP-18C.....24	PC-609-S ..... 50	PI307CX..... 121	PI378..... 119	PPC-32 ..... 199
MP-18E.....24	PC-622-B ..... 50	PI309..... 122	PI379..... 119	PPC-4..... 199
MP-2.....24	PC-622-S ..... 50	PI310..... 121	PI381..... 130	PPC-8..... 199
MP-2C.....24	PC-857 ..... 50	PI310LX ..... 121	PI382..... 119	PRO-BLUE..... 233
MP-2E.....24	PE-012..... 204	PI311..... 120	PI383..... 118	PRO-BLUE-32... 233
MP-3.....24	PE-012..... 204	PI312..... 120	PI384..... 119	PRO-BLUE-5.... 233
MP-3C.....24	PE-014..... 204	PI315..... 120	PI385..... 119	PRO-BLUE-55... 233
MP-3E.....24	PE-038..... 204	PI316..... 121	PI385-34..... 119	PRO-BLUE-AER .233
MP-4.....24	PE-058..... 204	PI317..... 121	PI386..... 119	PRO-BROWN.... 233
MP-4C.....24	PE-104..... 204	PI318..... 120	PI387..... 118	PRO-BROWN-32 .233
MP-4E.....24	PF-08 ..... 236	PI319..... 119	PI389..... 119	PRO-BROWN-5 .233
MP-6.....24	PF-16 ..... 236	PI319CX..... 119	PI389-GFI..... 119	PRO-BROWN-55 .233
MP-6C.....24	PF-ADAPTER.... 236	PI320..... 119	PI390..... 118	PRO-BROWN-AER ...
MP-6E.....24	PF-IGUN ..... 236	PI321..... 119	PI391..... 118	..... 233
MP-8.....24	PF-IHOSE..... 236	PI322..... 120	PI393..... 118	PRO-BUBBLE-32 . 238
MP-8C.....24	PF-KIT..... 236	PI326..... 132	PI394..... 118	PRO-GREEN ..... 233
MSA-45..... 251	PG-100 ..... 236	PI327..... 132	PI411..... 120	PRO-GREEN-32 233
N20-SD..... 180	PG-100-5 ..... 236	PI328..... 132	PI412..... 120	PRO-GREEN-5.. 233
O4-R2511 ..... 150	PG-100-55 ..... 236	PI330..... 122	PI416..... 120	PRO-GREEN-55 233
O4-R2512 ..... 150	PG-50 ..... 236	PI331..... 122	PI419..... 120	PRO-GREEN-AER. 233
O4-R3511 ..... 150	PG-50-5 ..... 236	PI332..... 122	PI426..... 120	PRO-KLEEN..... 234
O4-R3512 ..... 150	PG-50-55 ..... 236	PI335..... 125	PI458..... 119	PRO-KLEEN-5... 234
O4-R5011 ..... 150	PG-BG..... 236	PI337-3..... 132	PI459..... 119	PRO-KLEEN-55. 234
O4-R5012 ..... 150	PG-BG-5..... 236	PI340..... 120	PI908..... 121	PRO-RED+ ..... 234
O4-R5112 ..... 150	PG-BG-55..... 236	PI341..... 120	PI908CX..... 121	PRO-RED+32 ... 234
O4-R5122 ..... 150	PG-PLUS..... 236	PI350..... 120	PI909LX ..... 121	PRO-RED+5 .... 234
O4-R5311 ..... 150	PG-PLUS-5..... 236	PI351..... 120	PI912..... 121	PRO-RED+55 ... 234
O4-R5411 ..... 150	PG-PLUS-55.... 236	PI352..... 120	PI912LX ..... 121	PRO-RED+AER . 234
O4-R5412 ..... 150	PI203..... 121	PI353..... 120	PI913..... 121	PRO-THAW..... 243
O4-R5421 ..... 150	PI206..... 121	PI360..... 118	PI914..... 121	PRO-THAW-1.... 243
O4-R5611 ..... 150	PI221..... 132	PI361..... 118	PI929..... 132	PROTREAT-151 .241
O4-R5811 ..... 150	PI222..... 132	PI362..... 118	PK-2..... 193	PROTREAT-152 .241
O4-R5821 ..... 150	PI227..... 132	PI363..... 118	POE100-01 ..... 242	PROTREAT-161 .241
O4-R6711 ..... 152	PI228..... 132	PI364..... 118	POE100-32 ..... 242	PROTREAT-200 .241
PA10..... 170	PI232CX..... 119	PI365..... 118	POE32-01 ..... 242	PROTREAT-217 .241
PA18..... 170	PI237..... 132	PI366..... 118	POE32-32 ..... 242	PROTREAT-350 .241
PA25..... 170	PI301..... 122	PI367..... 118	POE68-01 ..... 242	PRO-YELLOW ... 234
PA25AP ..... 170	PI303..... 122	PI368..... 119	POE68-32 ..... 242	PRO-YELLOW-32 .234
PANPATCH ..... 235	PI304..... 121	PI370..... 119	PP-16..... 199	PRO-YELLOW-5 234
PANPATCH-BAG 235	PI305..... 121	PI371..... 119	PP-32..... 199	PRO-YELLOW-55 .234
PC-600-B ..... 50	PI306..... 121	PI374..... 118	PP-4..... 199	PRO-YELLOW-AER...
PC-600-S ..... 50	PI306CX..... 121	PI375..... 118	PP-8..... 199	..... 234

PS-01.....241	QSMS1802 .....32	QSSS1011-24 ...34	QSSS1026-12 ...34	QSWI3000 .....35
PS-03.....241	QSMS2400 .....32	QSSS1012-12 ...34	QSSS1026-18 ...34	QSWI3001 .....35
PS-07.....241	QSMS2401 .....32	QSSS1012-18 ...34	QSSS1026-24 ...34	QSWI3002 .....35
PS-075.....241	QSMS2401SS...32	QSSS1012-24 ...34	QSSS1027-12 ...34	QSWI4000 .....35
PS-1.....237	QSMS2402 .....32	QSSS1013-12 ...34	QSSS1027-18 ...34	QSWI5000 .....35
PS-20.....241	QSMS3001-12 ..33	QSSS1013-18 ...34	QSSS1027-24 ...34	QSWI6000 .....35
PS-40.....241	QSMS3001-12 ..33	QSSS1013-24 ...34	QSSS1028-12 ...34	QT-1 .....252
PW-16.....199	QSMS3001-12EXT.	QSSS1014-12 ...34	QSSS1028-18 ...34	QT-100.....252
PW-32.....199	.....33	QSSS1014-18 ...34	QSSS1028-24 ...34	QT-100G .....252
PW-4.....199	QSMS3001-18 ..33	QSSS1014-24 ...34	QSSS1029-12 ...34	QT-100N .....252
PW-8.....199	QSMS3001-18EXT.	QSSS1015-12 ...34	QSSS1029-18 ...34	QT-2.....252
PWB-16.....199	.....33	QSSS1015-18 ...34	QSSS1029-24 ...34	QTH-1 .....252
PWB-4.....199	QSMS3001-24 ..33	QSSS1015-24 ...34	QSSS1030-12 ...34	QTH-2 .....252
PWB-8.....199	QSMS3001-24EXT.	QSSS1016-12 ...34	QSSS1030-18 ...34	QTM-1 .....252
PWH-16 .....199	.....33	QSSS1016-18 ...34	QSSS1030-24 ...34	QTM-2.....252
PWH-4 .....199	QSSS100-12 ....34	QSSS1016-24 ...34	QSSS1031-12 ...34	R-1.....188
PWH-8 .....199	QSSS100-12 ....34	QSSS1017-12 ...34	QSSS1031-18 ...34	R3-R1053 .....151
PWU-16 .....199	QSSS1003-12 ...34	QSSS1017-18 ...34	QSSS1031-24 ...34	R3-R313 .....151
PWU-4 .....199	QSSS1003-18 ...34	QSSS1017-24 ...34	QSSS36 .....34	R3-R314 .....151
PWU-8 .....199	QSSS1003-24 ...34	QSSS1018-12 ...34	QSSS48 .....34	R3-R356 .....151
PWW-16.....199	QSSS1004-12 ...34	QSSS1018-18 ...34	QSSS55 .....34	R3-R357 .....151
PWW-4.....199	QSSS1004-18 ...34	QSSS1018-24 ...34	QSSS70 .....34	R3-R358 .....151
PWW-8.....199	QSSS1004-24 ...34	QSSS1019-12 ...34	QSTD1000 .....33	R3-R359 .....151
QAV-2 .....204	QSSS1005-12 ...34	QSSS1019-18 ...34	QSTD2000 .....33	R3-R360 .....151
QN-S3.....87	QSSS1005-18 ...34	QSSS1019-24 ...34	QSTD3000 .....33	R3-R368 .....151
QSAC1000 .....35	QSSS1005-24 ...34	QSSS1020-12 ...34	QSTD3000 .....33	R3-R369 .....151
QSAC1100 .....35	QSSS1006-12 ...34	QSSS1020-18 ...34	QSTD4000 .....33	R3-R370 .....151
QSAC2000 .....35	QSSS1006-18 ...34	QSSS1020-24 ...34	QSTD4001 .....33	R3-R371 .....151
QSAC2100 .....35	QSSS1006-24 ...34	QSSS1021-12 ...34	QSTD4002 .....33	RC-1 .....257
QSBB1000 .....31	QSSS1007-12 ...34	QSSS1021-18 ...34	QSTD5000 .....33	RLF-8 .....238
QSBB2000 .....31	QSSS1007-18 ...34	QSSS1021-24 ...34	QSTD5001 .....33	RM-10.....101
QSCH1000 .....32	QSSS1007-24 ...34	QSSS1022-12 ...34	QSTD5002 .....33	RM-1G .....101
QSCH2000 .....32	QSSS1008-12 ...34	QSSS1022-18 ...34	QSTD6000 .....33	RPC-0012 .....38
QSLG1000 .....35	QSSS1008-18 ...34	QSSS1022-24 ...34	QSTD6001 .....33	RPC-0014 .....38
QSLG2000 .....35	QSSS1008-24 ...34	QSSS1023-12 ...34	QSTD6002 .....33	RPC-0034 .....38
QSMS1200 .....32	QSSS1009-12 ...34	QSSS1023-18 ...34	QSWB1000 .....31	RPC-0038 .....38
QSMS1201 .....32	QSSS1009-18 ...34	QSSS1023-24 ...34	QSWB2000 .....32	RPC-0058 .....38
QSMS1201SS...32	QSSS1009-24 ...34	QSSS1024-12 ...34	QSWB2000SS ...32	RPC-0078 .....38
QSMS1202 .....32	QSSS1010-12 ...34	QSSS1024-18 ...34	QSWB3000 .....32	RPC-0118 .....38
QSMS1203 .....32	QSSS1010-18 ...34	QSSS1024-24 ...34	QSWB4000 .....32	RPC-0138 .....38
QSMS1800 .....32	QSSS1010-24 ...34	QSSS1025-12 ...34	QSWB4000SS ...32	RPC-0158 .....38
QSMS1801 .....32	QSSS1011-12 ...34	QSSS1025-18 ...34	QSWI1000 .....35	RS-15.....191
QSMS1801SS...32	QSSS1011-18 ...34	QSSS1025-24 ...34	QSWI2000 .....35	RS-20.....191

## PART NUMBER INDEX cont'd

RS-31.....	191	SC10-28 .....	38	T3401 .....	161	TT-120 .....	188	UC3036-3CA .....	19
RS-41.....	191	SC10-32 .....	38	T3403.....	161	TT-24.....	188	UC3040-3 .....	18
RS-9.....	191	SC10-35 .....	38	T3501 .....	161	TT-240 .....	188	UC3132-3L.....	19
RSC-GRN-02....	247	SC10-40 .....	38	T-400 .....	184	U3353-3 .....	18	UC3232-2 .....	18
RSC-GRN-04K..	247	SC10-42 .....	38	T-409 .....	184	U3650-3 .....	18	UC3232-3 .....	18
RSC-GRN-10....	247	SC10-50 .....	38	T-410, .....	184	U3654-3 .....	18	UC3232-3CA .....	19
RSC-GRN-50K..	247	SC10-54 .....	38	T-411 .....	184	U3660-3 .....	18	UC3237-3 .....	18
RSC-RED-02 ....	247	SC-1SHU .....	98	T-412 .....	184	U3865-3 .....	18	UC3434-3 .....	18
RSC-RED-02-E .	247	SC-1WP .....	98	T-417 .....	184	U3870-3 .....	18	UC3445-3 .....	18
RSC-RED-04K...247		SC-25 .....	92	T-418 .....	184	U4054-3 .....	18	UC3539-3L.....	19
RSC-RED-04K-E 247		SCM-10.....	92	T5401.....	161	U4550-3 .....	18	UC3636-2 .....	18
RSC-RED-10 ....	247	SCM-25.....	92	T6752.....	161	U4558-3 .....	18	UC3636-3 .....	18
RSC-RED-10-E .	247	SCM-5.....	92	T6753.....	161	U4848-3 .....	18	UC3636-3CA .....	19
RSC-RED-500 ..	247	ST-10 .....	95	T7752.....	161	U4854-3 .....	18	UC3640-2 .....	18
RSC-RED-50K...247		ST15810.....	39	T-8 .....	183	U4866-3 .....	18	UC3642-3 .....	18
RSC-RED-50K-E. 247		ST-24 .....	95	T-9 .....	183	U5053-3 .....	18	UC3642-3CA .....	19
RSC-SLV-02 .....	247	ST-4 .....	95	TC-007.....	188	U5056-3 .....	18	UC3648-2 .....	18
RSC-SLV-04K...247		ST75.....	87	TC-25.....	87	U5252-3 .....	18	UC3648-3 .....	18
RSC-SLV-10 .....	247	STXH120P05...165		TG-05 .....	192	U5557-3 .....	18	UC3648-3CA .....	19
RSC-SLV-500 ...	247	STXH240S05...165		TG-10 .....	87	UA-1 .....	85	UC3842-3 .....	18
RSC-SLV-50K...247		STXR208Y05N.165		TG-30 .....	192	UC1636-2 .....	18	UC4040-2 .....	18
RSC-TOOL.....	247	STXR240D05...165		TG-30-1 .....	192	UC1636-3 .....	18	UC4040-3 .....	18
SANI-CND.....	235	STXR480D05...165		TG-30-12 .....	192	UC1838-3 .....	18	UC4040-3CA .....	19
SANI-CND-32...235		STXR480Y05N.165		TG-87A.....	87	UC1838-3CA .....	19	UC4042-3 .....	18
SANI-CND-5.....	235	STXRMBK.....	165	TI401 .....	161	UC2424-2 .....	18	UC4044-3L.....	19
SANI-CND-55...235		SUPER-KOOL....	238	TI404 .....	161	UC2424-3 .....	18	US-R90575 .....	151
SC08-15 .....	38	SUPER-KOOL-16	238	TLC-3-10 .....	170	UC2424-3CA .....	19	US-R90671 .....	151
SC08-20 .....	38	SWB1100.....	31	TLC-3-12 .....	170	UC2430-2 .....	18	US-R90672 .....	151
SC08-22 .....	38	T-1 .....	183	TLC-3-8 .....	170	UC2436-2 .....	18	US-R91189 .....	151
SC08-25 .....	38	T-10 .....	183	TR3806.....	39	UC2436-3 .....	18	UV-1.....	48
SC08-28 .....	38	T-100.....	183	TR3810.....	39	UC2436-3CA .....	19	UV-BULB .....	48
SC08-32 .....	38	T-101 .....	183	TRIPLE-D.....	233	UC2442-3 .....	18	UVEC-07G .....	240
SC08-35 .....	38	T-11 .....	183	TRIPLE-D-32....	233	UC2448-2 .....	18	VA-3-346.....	251
SC08-40 .....	38	T-12 .....	183	TRIPLE-D-5.....	233	UC2448-3 .....	18	VA-34.....	251
SC08-42 .....	38	T-13 .....	183	TRIPLE-D-55....	233	UC2448-3CA .....	19	VA-46.....	251
SC08-50 .....	38	T-14 .....	183	TRIPLE-D-AER...233		UC2448-3CA .....	19	VA-68.....	251
SC08-54 .....	38	T-16 .....	183	TRIPLE-D-AER-6	233	UC2626-2 .....	18	VAU-24.....	251
SC-1 .....	98	T-20 .....	183	TRIPLE-D-GRAN	233	UC2626-3 .....	18	VAU-45.....	251
SC-10 .....	92	T-21 .....	183	TRIPLE-D-RTU...233		UC2628-2 .....	18	VAU-45.....	251
SC10-15 .....	38	T2401 .....	161	TS-1 .....	167	UC2636-3CA .....	19	VAX-2 .....	251
SC10-20 .....	38	T2403.....	161	TS-3.....	167	UC3030-2 .....	18	VAX-3 .....	251
SC10-22 .....	38	T2404.....	161	TS-4 .....	167	UC3030-3 .....	18	VAX-4 .....	251
SC10-25 .....	38	T-300.....	184	TS-5.....	167	UC3030-3CA .....	19	VAX-5 .....	251
						UC3036-2 .....	18	VAX-6 .....	251



**PART NUMBER INDEX** cont'd

VAX-8.....251	W105-100 ..... 175	W804-50 ..... 175	WG840590..... 145	WT04..... 177
VC-4 .....251	W105-50 ..... 175	W805 ..... 175	WG840595..... 145	WT04C..... 177
VC-4R .....251	W121 ..... 175	W805-100 ..... 175	WG840596..... 145	WT05..... 177
VCC-4 .....251	W121-100 ..... 175	WC02 ..... 178	WG840727 ..... 144	WT05C..... 177
VCC-4B .....251	W121-50 ..... 175	WC03 ..... 178	WG840727HT .144	WT07..... 177
VCR-1 .....252	W122 ..... 175	WC04 ..... 178	WG840728..... 144	WT07C..... 177
VCRT-1 .....252	W122-100 ..... 175	WC05 ..... 178	WG840728HT .144	WT11..... 177
VLC-10.....252	W122-50 ..... 175	WC06 ..... 178	WG840729 ..... 144	WT11C..... 177
VLC-12.....252	W123 ..... 175	WC07 ..... 178	WG840729HT .144	WT11L..... 177
VLC-18.....252	W123-100 ..... 175	WC08 ..... 178	WG840730..... 144	WT15..... 177
VLC-25.....252	W123-50 ..... 175	WC09 ..... 178	WG840730HT .144	WT15C..... 177
VLC-4.....252	W124 ..... 175	WC10 ..... 178	WG840731 ..... 144	WTA1 ..... 177
VLC-5.....252	W124-100 ..... 175	WC12 ..... 178	WG840731HT .144	WTB05..... 177
VLC-6.....252	W124-50 ..... 175	WC14 ..... 178	WG840736HT .144	WTB05C..... 177
VLC-8.....252	W125 ..... 175	WC16 ..... 178	WG840737HT .144	WTB07..... 177
VP68-01.....243	W125-100 ..... 175	WCA1 ..... 178	WG840738HT .144	WTB07C..... 177
VP68-05.....243	W125-50 ..... 175	WG840203..... 144	WG840739HT .144	WTB07M ..... 177
VP68-32.....243	W141 ..... 175	WG840203HT .145	WG840746..... 144	WTB11..... 177
VS-4.....251	W141-100 ..... 175	WG840204..... 144	WG840746HT .144	WTB11C..... 177
VST-4 .....251	W141-50 ..... 175	WG840204HT .144	WG840884HT .144	WTB11C..... 214
VST-44 .....251	W142 ..... 175	WG840205..... 144	WHT20..... 175	WTB11CR..... 177
VTR-24 .....251	W142-100 ..... 175	WG840205HT .144	WHTB10-50..... 175	WTB11D..... 177
VTS-10.....251	W142-50 ..... 175	WG840458..... 144	WHTB12-50..... 175	WTB11M ..... 177
VTS-12.....251	W143 ..... 175	WG840458HT .144	WHTB14-50..... 175	WTB15..... 177
VTS-14 .....251	W143-100 ..... 175	WG840459..... 144	WHTR14-50..... 175	WTB15C..... 177
VTS-46 .....251	W143-50 ..... 175	WG840459HT .145	WHTW14-50.... 175	WTBA1 ..... 177
VTS-56.....251	W144 ..... 175	WG840463..... 145	WM1002..... 132	WTM05..... 177
VTS-68.....251	W144-100 ..... 175	WG840464..... 145	WM1003..... 132	WTM05C..... 177
VTS-810.....251	W144-50 ..... 175	WG840465..... 145	WM1009..... 132	WTM07..... 177
VVC-1 .....251	W145 ..... 175	WG840465HT .145	WM1014..... 132	WTM07C..... 177
W101 ..... 175	W145-100 ..... 175	WG840466..... 145	WP1212-164 ..259	WTM1 ..... 178
W101-100 ..... 175	W145-50 ..... 175	WG840467..... 145	WP1212-50 ....259	WTM11 ..... 177
W101-50 ..... 175	W801 ..... 175	WG840468..... 145	WP1214-164 ..259	WTM11C..... 177
W102 ..... 175	W801-100 ..... 175	WG840468HT .145	WP1214-50 ....259	WTM14C..... 177
W102-100 ..... 175	W801-50 ..... 175	WG840469..... 145	WP1234-50 ....259	WTM1C..... 178
W102-50 ..... 175	W802 ..... 175	WG840469HT .145	WP1234-82 ....259	WTM2 ..... 178
W103 ..... 175	W802-100 ..... 175	WG840583..... 145	WP1238-164 ..259	WTM2C..... 178
W103-100 ..... 175	W802-50 ..... 175	WG840584..... 145	WP1238-50 ....259	WTMB05..... 177
W103-50 ..... 175	W803 ..... 175	WG840585..... 145	WP1258-164 ..259	WTMB05C..... 177
W104 ..... 175	W803-100 ..... 175	WG840586..... 145	WP1258-50 ....259	WTMB07..... 177
W104-100 ..... 175	W803-50 ..... 175	WG840587..... 145	WP1278-50 ....259	WTMB07C..... 177
W104-50 ..... 175	W804 ..... 175	WG840588..... 145	WP1278-82 ....259	WTMB11 ..... 177
W105 ..... 175	W804-100 ..... 175	WG840589..... 145	WS-1..... 85	WTMB11C..... 177

**PART NUMBER INDEX** cont'd

WTMB14C.....	177
X2424211.....	22
X2424311.....	22
X2430211.....	22
X2436211.....	22
X3030211.....	22
X3030311.....	22
X3232211.....	22
X3232311.....	22
X3244211.....	22
X3636211.....	22
X3636311.....	22
X3836211.....	22
X3842211.....	22
X3848311.....	22

**PADS**

**MOUNTING SYSTEMS**

**AIR MOVEMENT**

**HEATING PRODUCTS**

**CONDENSATE MANAGEMENT**

**GENERAL INDUSTRIAL**

**DEVCO**

**ELECTRICAL**

**TOOLS**

**PLUMBING**

**DUCTLESS SYSTEMS**

**MAINTENANCE CHEMICALS**

**INLINE COMPONENTS**

## **ABOUT DIVERSITECH**

Founded in 1971, DiversiTech® Corporation is North America's largest manufacturer of equipment pads and a leading manufacturer and supplier of components and related products for the heating, ventilating, air conditioning, and refrigeration (HVAC/R) industry. Headquartered in the Atlanta, Ga., metropolitan area, DiversiTech's mission for its wholesaler partners is to simplify their work. The Company is focused on growth through internal product development, external partnerships and acquisition. Manufacturing a suite of products, which includes a wide range of mechanical, electrical, chemical and structural parts for HVACR systems, DiversiTech brings unparalleled scaling capabilities and supplier expertise. The Company holds numerous patents and operates an advanced R&D materials division dedicated to bringing more value to its customers. The Company maintains over 1 million square feet of manufacturing and distribution space in key U.S., Canadian and European locations. DiversiTech has enjoyed a continued history of successful growth and has acquired industry recognized brand names including Wagner® Manufacturing, Specialty Chemical, EcoPad®, The Black Pad®, Quick-Sling® and Super Seal™. More information is available at [www.diversitech.com](http://www.diversitech.com).

**E LITE**  
EQUIPMENT  
DIVERSITECH  
10000 Sugarloaf Parkway  
Duluth, GA 30097

**HEF-T-PAD**  
EQUIPMENT  
DIVERSITECH  
10000 Sugarloaf Parkway  
Duluth, GA 30097

**THE BLACK PAD**  
EQUIPMENT  
DIVERSITECH  
10000 Sugarloaf Parkway  
Duluth, GA 30097

**ULTRALITE**  
EQUIPMENT  
DIVERSITECH  
10000 Sugarloaf Parkway  
Duluth, GA 30097

**GLADLITE**  
EQUIPMENT  
DIVERSITECH  
10000 Sugarloaf Parkway  
Duluth, GA 30097

LIT-CAT-HVAC  
6650 Sugarloaf Parkway  
Suite 100  
Duluth, GA 30097  
678.542.3600  
800.995.2222  
678.542.3700 Fax  
www.diversitech.com  
©2019 DiversiTech Corporation

DOWNLOAD [http://media.  
diversitech.com/doc/  
DOC32509.pdf](http://media.diversitech.com/doc/DOC32509.pdf)

CORRECTIONS/COMMENTS  
[feedback@diversitech.com](mailto:feedback@diversitech.com)

**DIVERSITECH**®