

Box 172 • 930 Roberts Road • Sparta, Wisconsin 54656-0172  
Phone: Toll Free 1-800-533-0551  
FAX: (608) 269-8129  
E-Mail: [info@ken-way.com](mailto:info@ken-way.com)  
Website: [www.ken-way.com](http://www.ken-way.com)



# 2018 PARTS CATALOG

EFFECTIVE SEPTEMBER 1, 2018

**KEN-WAY CORPORATION**

**Sparta, Wisconsin**

**MANUFACTURERS OF KEN-WAY DRAIN CLEANING EQUIPMENT**

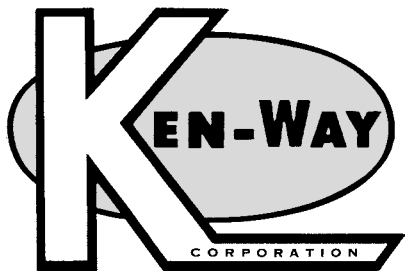

# KEN-WAY CORPORATION

Box 172 • 930 Roberts Road  
Sparta, Wisconsin 54656

Phone: Toll Free 1-800-533-0551

FAX: (608) 269-8129

E-Mail: info@ken-way.com

Website: www.ken-way.com

**Parts Catalog 2018** *Effective*  
*September 1, 2018*

## Equipment & Parts

	Page No.
<b>Electric Sewer &amp; Drain Cleaners</b>	
Ken-Way Jr. Electric Drain Cleaner .....	2
Ken-Way '400' Sewer Rodder .....	3
<b>Premium Music Wire Cables</b>	
A. 1/4", 5/16", 3/8", 13/32", 1/2" .....	4
B. Jr. Scraping Blades	
C. 3/8", 13/32" Repair Heads	
<b>Couplings</b> .....	5
<b>Sewer Cables</b>	
A. 3/4" Sewer Cables .....	6
B. 11/16" Sewer Cables	
C. 5/8" Sewer Cables	
<b>Ken-Way Cable Couplings</b>	
A. Rev-Lok Locking Couplings & 3/8" SAE Thread Non-Lock .....	7
<b>Accessory Tools for Model HD-53B, '300' &amp; '400'</b>	
Flexible Cable Leaders and Retriever Tools .....	8
<b>Blade Holders &amp; Blades</b>	
A. For ALL Ken-Way Machines & other manufacturers. ....	9
Closet Augers .....	10
Hand Spinners .....	11

*Visa, Mastercard, Discover, American Express Accepted*

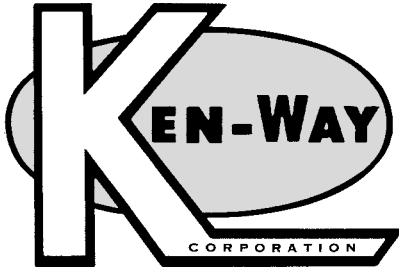

## KEN-WAY JR.

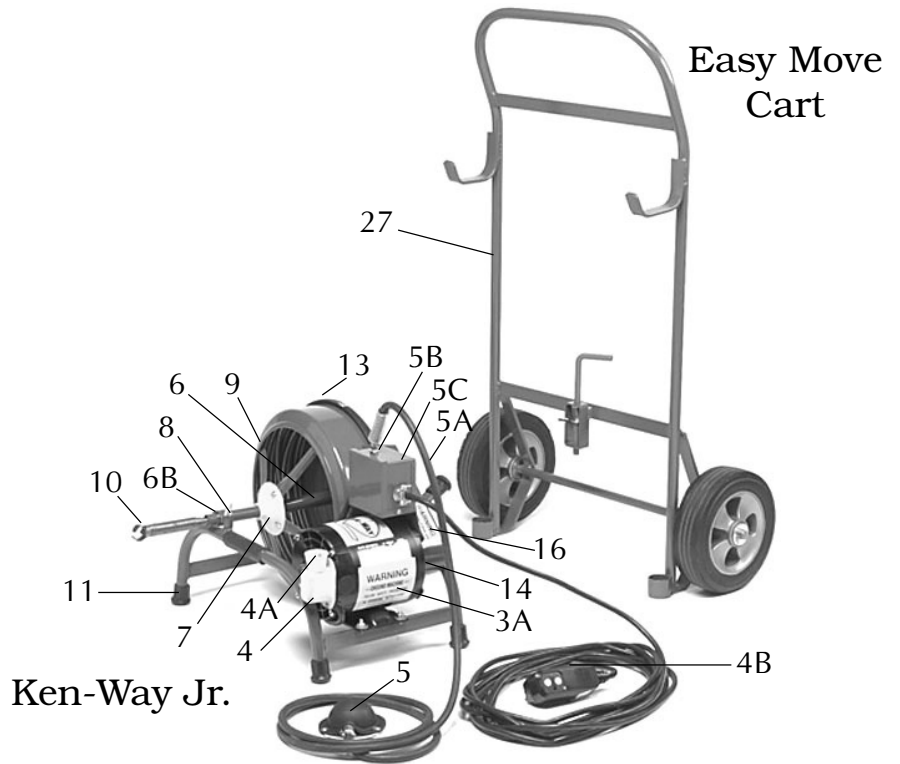

### PARTS LIST FOR KEN-WAY JR.

Part Name	Item #	Price
1. Jr. Regular Drum Only .....	J001	\$149.50
2. Jr. Large Drum Only .....	J002	\$152.70
2B. Jr. Little Drum ONLY .....	J003	\$160.75
3A. Jr. Motor 1/4 H.P. Reversible Complete w/25' Cord & GFCI (All Machines prior June 13, 1984) .....	J004	\$299.95
3B. Jr. Motor 1/4 H.P. Complete wire for Air F.S. w/25' Cord & GFCI (All Machines since June 14, 1984) .....	J005	\$290.95
4. Jr. Motor Reversing Switch Complete w/Terminal Box & Wiring .....	J006	\$29.65
4A. Jr. Motor Reversing Switch Only .....	J007	\$26.00
4B. Electric Power Cord - 25' w/ GFCI .....	J012	\$61.50
5A. Jr. Air Foot-Pedal w/Pedal & Hose (All Machines June 14, 1984 and on.) .....	J008	\$29.65
5B. Air Switch Internal .....	J010	\$18.75
5C. Air Switch Junction Box Only .....	J011	\$13.25
5. Air Pedal Only .....	J013	\$15.90
6. Jr. Crank-Arm Only w/Snap Washers (For Regular & Large Jr. Drums) .....	J014	\$34.59
6A. Jr. Crank-Arm Assembly Complete w/2 Bearings (For Regular & Large Jr. Drums) .....	J015	\$51.95
6B. Jr. Crank-Arm Bearings Only .....	J016	\$11.50
7. Jr. Name Plate Only .....	J019	\$8.40
8. Jr. Frame Wing Nuts Each .....	J020	.95
9. Jr. Drum Cable Anchors w/Nut & Bolt .....	J021	\$2.35
10. Jr. Blade Holder Plugs for 3/8" Cable .....	J022	\$7.80
11. Jr. Rubber Frame Tips .....	J023	\$1.05
12. Jr. Blade Holder Plugs for 1/2" Cable .....	J024	\$10.55
13. Jr. V-Belt .....	J025	\$11.55
14. Jr. Motor Pulley .....	J026	\$9.55
15. Bearing Retaining Snap Rings for Jr. Drums .....	J027	\$1.00
16. Jr. Belt Guard .....	J028	\$14.05
17. Jr. Complete Frame Only .....	J029	\$154.25
18. Reversing Switch Box .....	J030	\$2.70
19. Switch Guard .....	J033	.90
20. Ugly Gloves .....	F041	\$8.20
21. Jr. Air Hose Only .....	J032	\$9.00
22. Jr. Crank-Arm Only (For Jr. Little Drums) .....	J052	\$51.95
23. Jr. Crank-Arm Assembly Complete w/ Bearings (For Jr. Little Drum) .....	J089	\$49.30
24. Jr. Drop Head Plug For 3/8" & 13/32" (To Take Drop Heads) .....	J071	\$9.80
25. Air Hose Clamps .....	J034	\$.90
26. Snake Oil Quart .....	J328	\$8.75
27. Jr. Easy Move Cart (Frame Models Since April 15, 2005) .....	J385	\$149.50
28. Jr. Easy Move Cart (Frame Models Before April 15, 2005) .....	J386	\$158.95

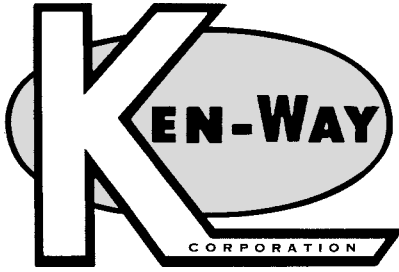

## '400' SEWER RODDER

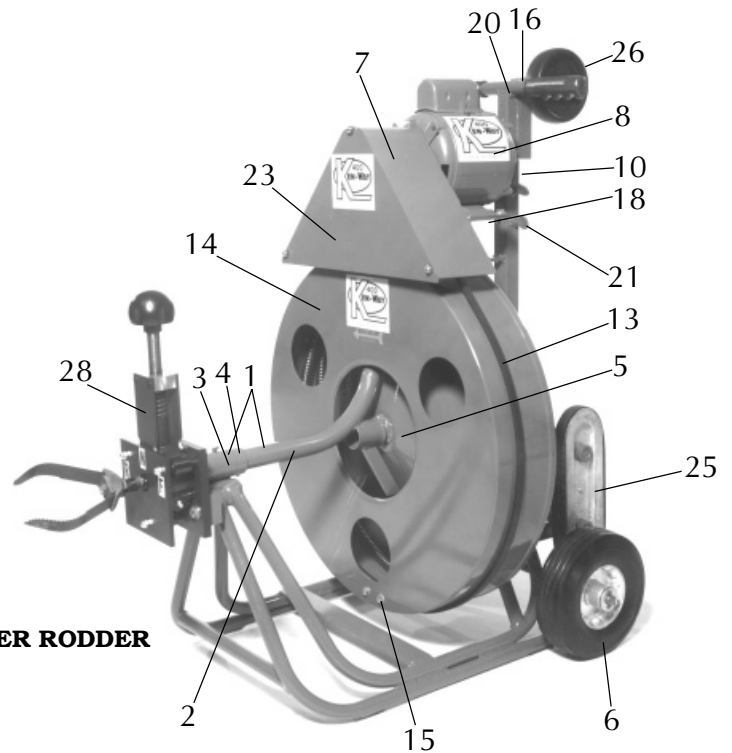

**'400' SEWER RODDER**

### PARTS LIST FOR KEN-WAY '400'

Part Name	Item #	Price
1. Ken-Way Crank-Arm Assembly Complete .....	F008	\$105.95
2. Ken-Way Crank-Arm Only .....	F009	\$88.10
3. Crank-Bearing & Housing Only .....	F010	\$22.95
4. Crank-Arm Collars for above (set of two) .....	F011	\$11.90
5. '400' Drum Bearing (2 Piece) .....	F012	\$21.25
6. Rubber Wheels 8" Each .....	F013	\$21.95
7. 3-Speed Motor Pulley .....	F014	\$12.55
8. Motor 1/2 H.P. Capacitor W. Rev. Switch, 25' Power Cord & GFCI & Pulley .....	F015	\$475.95
9. Air Foot Pedal w/8' Air Hose & Quick Disconnect Coupling .....	F016	\$39.95
9B. Air Switch Internal w/ Quick Disconnect .....	F018	\$20.95
9C. Air Switch Junction Box Only .....	F019	\$13.60
9D. Air Pedal Only .....	F021	\$15.85
9E. Female Quick Disconnect Coupling For Air Switch .....	F022	\$10.25
9F. Male Quick Disconnect Barb For Air Switch .....	F023	\$5.10
10. Motor Reversing Switch Complete w/Terminal Box .....	F024	\$29.70
11. Motor Reversing Switch Unit Only .....	F026	\$20.65
13. V-Belt Only .....	F027	\$17.85
14. '400' Drum Only (Less Cable) .....	F004	\$480.70
15. Drum Cable Anchor Only .....	F029	\$7.50
16. Truck Loader .....	F031	\$18.30
17. Tool Box Only .....	F211	\$31.70
18. Motor Support Assembly .....	F032	\$25.10
19. Rubber Handle Grips .....	F005	\$2.85
20. Handle Rod Assembly w/Grips .....	F030	\$21.40
21. Thumb Screws for Motor Assembly & Dolly Handle .....	F017	\$1.40
22. Tool Box Complete w/Air Foot-Switch, Flex. Leader, Retriever, 6-Blades, Couplings .....	F036	\$238.85
23. '400' Belt Guard .....	F037	\$38.10
24. Drain Plug for '400' Drum .....	F038	.50
25. Step Climbers Each .....	F039	\$44.45
26. 5" Wheel for Truck Loader .....	F040	\$8.95
27. Cable Drive Mounting Plate .....	F042	\$33.75
28. Ken-Way Cable Drive (Automatic Power Feed Unit) Model # 100 .....	F043	\$423.30
29. Heavy Duty Work Gloves .....	F044	\$48.65
30. Air Hose w/ Quick Disconnect and Clamps .....	F041	\$20.20
31. 25' Electric Power Cord w/ GFCI .....	F052	\$61.50
32. Air Hose Clamps .....	F053	.80
33. '400' Frame Only .....	F054	\$548.95
34. Snake Oil Quart .....	F077	\$9.00
35. Cable Drive Bearing .....	D004	\$8.95

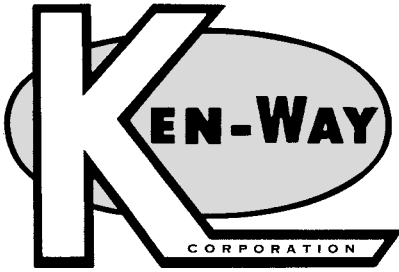

# MUSIC WIRE CABLES

Premium Grade Wire - Heat Treated For Stress Relief  
**"THE VERY BEST ALWAYS"**  
Left Hand Wound



#8 Plug Attach Blades, Extractor Hook or Drop Head



#6 Attach Blades or Extractor Hook

**NO CORE CABLES W/ BLADE HOLDERS**

(5/16" & 3/8" Can Be Furnished w/ Drop Head Plug - Please Specify)

Part Name	Item #	Price
5/16" x 25' w/ Blade Holder #8 .....	J197	\$45.15
5/16" x 50' w/ Blade Holder #8 .....	J060	\$74.95
5/16" x 75' w/ Blade Holder #8 .....	J139	\$106.95
3/8" x 50' w/ Blade Holder #6 or #8 .....	J061	\$85.50
3/8" x 75' w/ Blade Holder #6 .....	J062	\$115.80
1/2" x 50' w/ Blade Holder #6 .....	J063	\$109.85
1/2" x 75' w/ Blade Holder #6 .....	J064	\$132.50
1/2" x 100' w/ Blade Holder #6 .....	J285	\$189.50

**INNER CORE CABLES W/ BLADE HOLDERS**

Part Name	Item #	Price
5/16" x 50' Inner Core w/ Blade Holder #8 .....	J161	\$80.10
5/16" x 75' Inner Core w/ Blade Holder #8 .....	J162	\$119.95
3/8" x 50' Inner Core w/ Blade Holder #6 or #8 ...	J306	\$98.95
3/8" x 75' Inner Core w/ Blade Holder #6 or #8 ...	J304	\$134.50
13/32" x 50' Inner Core w/ Blade Holder #6 or #8 J065	J065	\$114.70
13/32" x 75' Inner Core w/ Blade Holder #6 or #8 J066	J066	\$145.50
1/2" x 50' Inner Core w/ Blade Holder #6 .....	J067	\$142.95
1/2" x 75' Inner Core w/ Blade Holder #6 .....	J068	\$195.25
1/2" x 100' Inner Core w/ Blade Holder #6 .....	J227	\$238.50



Part Name	Item #	Price
Drop Head for 3/8" & 13/32" Cable .....	J069	\$24.55
Drop Head for 5/16" Cable .....	J070	\$21.70
Drop Head Cable Plug for 5/16", 3/8" & 13/32" ..	J071	\$9.25
Punch for Drop Head Pins .....	J140	\$5.65
Expansion Pin for Drop Head .....	J141	.30

(Cables Need Spec. Plug for Drop Heads)  
 (See #24 Jr. Parts)

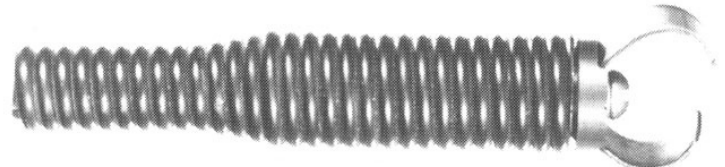

Part Name	Item #	Price
3/8" & 13/32" Repair Bulb-End .....	J072	\$8.25
3/8" & 13/32" Repair Blade-End (Specify Which) ...	J073	\$17.00
Extractor Hook for 3/8" & 13/32" w/ Blade Holder ...	J074	\$7.10

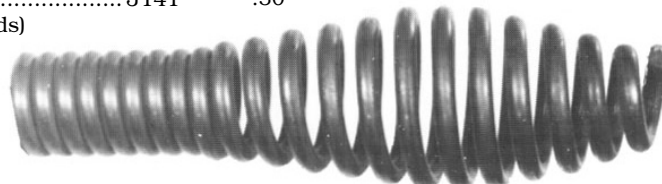

**CABLES W/ BULB-ENDS**

Part Name	Item #	Price
3/8" x 25' w/ Bulb-End .....	J078	\$46.70
3/8" x 50' w/ Bulb-End .....	J076	\$83.95
3/8" x 75' w/ Bulb-End .....	J075	\$113.95
5/16" x 25' w/ Bulb-End .....	J088	\$45.25
5/16" x 50' w/ Bulb-End .....	J077	\$66.10
5/16" x 75' w/ Bulb-End .....	J142	\$98.95

Part Name	Item #	Price
1/4" x 15' w/ Bulb-End .....	J170	\$20.75
1/4" x 25' w/ Bulb-End .....	J080	\$29.55
1/4" x 50' w/ Bulb-End .....	J143	\$44.85

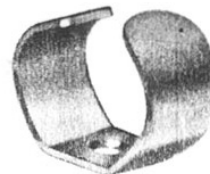

**SCRAPING BLADES FOR 5/16", 3/8", 13/32" & 1/2"**

Part Name	Item #	Price
1" Jr. Blade for 3/8" Cable .....	J081	\$2.40
1-1/4" Jr. Blade for 3/8" Cable .....	J082	\$2.50
1-1/2" Blade for 3/8" Cable .....	J083	\$2.60
2" Blade for 3/8" Cable .....	J195	\$2.70
3/4" Blade for 5/16" Cable .....	J144	\$2.35
1" Blade for 5/16" Cable .....	J145	\$2.45

Part Name	Item #	Price
1-1/2" Blade for 1/2" Cable .....	J171	\$3.45
1-3/4" Blade for 1/2" Cable .....	J172	\$3.65
2" Blade for 1/2" Cable .....	J084	\$3.75
3" Blade for 1/2" Cable .....	J085	\$4.20
Blade Retaining Screw & Washer .....	J086	.50
Blade Retaining Screw for Drop Head Plugs .....	J087	.55

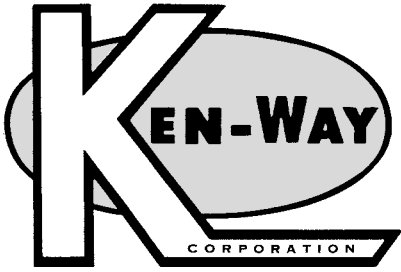

# COUPLINGS

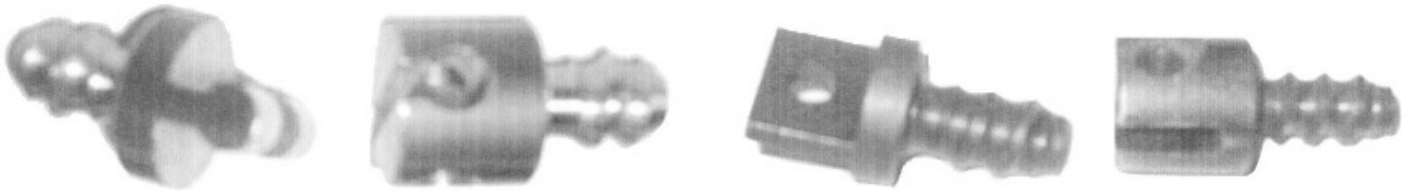

### PIN LOCK

(Pin Lock for 5/8", 11/16" and 3/4" Cable)

Part Name	Item #	Price
Pin Lock Male .....	F401	\$6.40
Pin Lock Female .....	F402	\$6.40

### SLOTTED

(Slotted for 5/8", 3/4" and 11/16" Cable)

Part Name	Item #	Price
Slotted Male .....	F404	\$6.40
Slotted Female .....	F405	\$6.40



(For 5/8", 11/16" and 3/4" Cable)

Part Name	Item #	Price
Threaded Male .....	F412	\$6.40
Slip Joint Female .....	F211	\$6.65

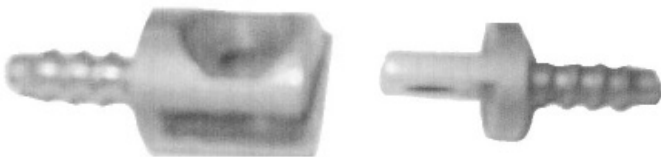

(3/8", 13/32" and 1/2" Cable)

Part Name	Item #	Price
Slotted Female .....	J404	\$5.30
Slotted Male .....	J405	\$5.30

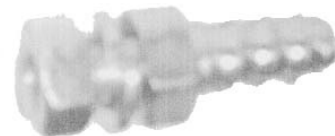

(For 3/8", 13/32" and 1/2" Cable)

Part Name	Item #	Price
Threaded Male .....	J407	\$5.00

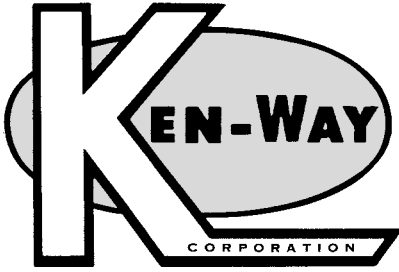

# MUSIC WIRE SEWER CABLES



Heat Treated - Finest Quality Music Wire, Greater Strength - With More Flexibility -  
Easily Spliced - More For Your Money. Guaranteed. Left Hand Wound.

## PRICES WITH CONNECTIONS

### 3/4" CABLES W/COUPLINGS

#### NO CORE SEWER CABLES

Part Name	Item #	Price
3/4" x 10' Anchor Cable ..... (*400' Machine Comes w/ 10' Anchor)	F047	\$27.40
3/4" x 25' Sewer Cable w/ Couplings .....	F046	\$63.95
3/4" x 50' Sewer Cable w/ Couplings .....	F048	\$121.95
3/4" x 90' Sewer Cable w/ Couplings .....	F049	\$209.95
3/4" x 100' Sewer Cable w/ Couplings .....	F050	\$239.95
3/4" x 110' Sewer Cable w/ Couplings .....	F173	\$263.90
3/4" x 130' Sewer Cable w/ Couplings .....	F174	\$309.95

#### INNER CORE SEWER CABLES

Part Name	Item #	Price
3/4" x 10' w/ Inner Core & Couplings .....	F175	\$38.10
3/4" x 25' w/ Inner Core & Couplings .....	F176	\$90.95
3/4" x 50' w/ Inner Core & Couplings .....	F177	\$171.95
3/4" x 90' w/ Inner Core & Couplings .....	F041	\$275.95
3/4" x 100' w/ Inner Core & Couplings .....	F179	\$308.95
3/4" x 110' w/ Inner Core & Couplings .....	F180	\$368.50
3/4" x 130' w/ Inner Core & Couplings .....	F166	\$399.95

(With Aircraft Wire — or — Plastic)

### 11/16" CABLES W/ COUPLINGS

#### NO CORE

Part Name	Item #	Price
11/16" x 50' .....	F045	\$129.25
11/16" x 100' .....	F205	\$250.10
11/16" x 120' .....	F206	\$285.10
11/16" x 150' .....	F202	\$339.95

#### INNER CORE

Part Name	Item #	Price
11/16" x 50' .....	F221	\$161.50
11/16" x 100' .....	F317	\$289.95
11/16" x 120' .....	F320	\$316.95
11/16" x 150' .....	F207	\$398.50

(With Aircraft Wire — or — Plastic)

### 5/8" CABLES W/ COUPLINGS

#### NO CORE CABLES

Part Name	Item #	Price
5/8" x 5' Anchor Cable .....	F083	\$25.10
5/8" x 50' Cable .....	F079	\$111.50
5/8" x 75' Cable .....	F081	\$151.95
5/8" x 100' Cable .....	F082	\$188.95

#### INNER CORE CABLES

Part Name	Item #	Price
5/8" x 25' w/ Inner Core .....	F074	\$79.95
5/8" x 50' w/ Inner Core .....	F080	\$144.95
5/8" x 75' w/ Inner Core .....	F084	\$199.95
5/8" x 100' w/ Inner Core .....	F183	\$251.95

(With Aircraft Wire — or — Plastic)

PLEASE NOTE: If you wish couplings installed in cables, please specify TYPE and MALE or FEMALES.  
We can furnish with most manufacturers' types.

### STRAIGHT CABLES W/ NO FLARES

Part Name	Item #	Price
3/8" x 65' Cable w/ Threaded Male .....	CC062	\$89.75
3/8" x 90' Cable w/ Threaded Male .....	CC057	\$124.95
1/2" x 50' w/ Threaded Male .....	CC173	\$106.25
1/2" x 75' w/ Threaded Male .....	CC172	\$128.50

PLEASE NOTE: Special sizes and lengths of cables are available.  
We make our own cable and can furnish additional sizes and lengths. Give us a call - (800) 533-0551.

Part Name	Item #	Price
CABLE UNCOUPLING STAND .....	S048	\$17.80

Use: Supports and holds cable in place when uncoupling



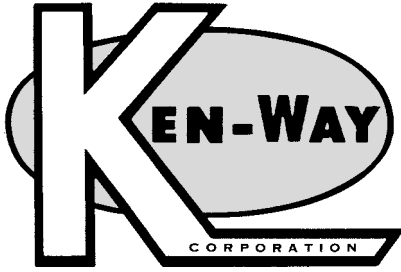

# 3/4" Sewer Cable Couplings

## KEN-WAY Rev-Lok Locking Couplings & Easy-Start Non-Locking Couplings

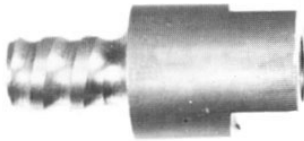

Non-lock Female Coupling  
3/8" S.A.E. Thread  
Item # F061 - \$7.75 Each



Non-lock Male Coupling  
3/8" S.A.E. Thread  
Item # F062 - \$6.85 Each

### Easy-Start Non-Locking Cable Couplings

The Ken-Way Non-lock Couplings of Round Stock with wide flat surface for positive Blade Holder attachment. Makes for easy coupling installation on the job. Developed over the past thirty (30) years, you can depend on them being the very best.

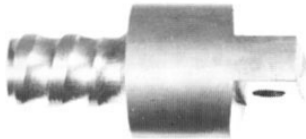

Rev-Lok Locking Male Coupling  
Item # F063 - \$7.15 Each



Coupling Screws Item  
# F065 - \$.35 Each

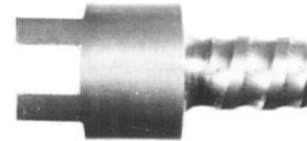

Rev-Lok Locking Female Coupling  
Threaded to take 3/8" S.A.E.  
Blade Holder Bolt  
Item # F064 - \$8.20 Each

### Rev-Lok Locking Cable Couplings

The Ken-Way Rev-Lok Locking Cable Couplings are designed for use on all Reversing Type 3/4" Sewer Cables. Slip Male and Female Coupling together, insert threaded bolt and tighten with a screwdriver. Coupling guaranteed to hold even when running high speed in reverse for extended periods. When uncoupling, all you need is a screwdriver, no punch or pins needed, gives longer trouble free service.



**Cable Splicer for 3/4" Cable**  
Item # F066 - \$7.15 Each

### Cable Splicer

For splicing all 3/4" sewer cable. Can be done quickly on the job to repair a broken or kinked piece of cable. Once cable is spliced it is meant to last and operate through the normal life of the sewer cable.

When ordering '400' or '300' Sewer Rodders, or all used machines, please specify which type of coupling you desire.



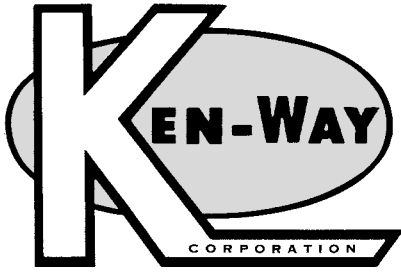

# ACCESSORY TOOLS

**FOR 3/4" AND 5/8" CABLE**  
**MODEL '400', '300', OHD, HD-53 & HD-53B SEWER MACHINES**  
**(IF OTHER TYPE COUPLINGS PLEASE SPECIFY)**



**NO TENSION FLEXIBLE CABLE LEADER**  
**Item # F067 - 3/4" \$31.50**

**NO TENSION FLEXIBLE CABLE LEADER**  
**Item # F184 - 5/8" \$30.25**

(Shown With Rev-Lok Locking Coupling)

Flexible Cable Leader - Gives Extra Flexibility for rodding through  
"P" Traps, Etc. Please specify either 3/8" S.A.E. Thread, or Rev-Locking Coupling

## **RETRIEVER TOOL**

Will retrieve roots, rags, etc. from lateral and mainline sewers.  
For use only with 3/4" Cable.  
Please specify Coupling type.

(Shown With Rev-Lok Locking Coupling)

Item # F068 - \$22.95

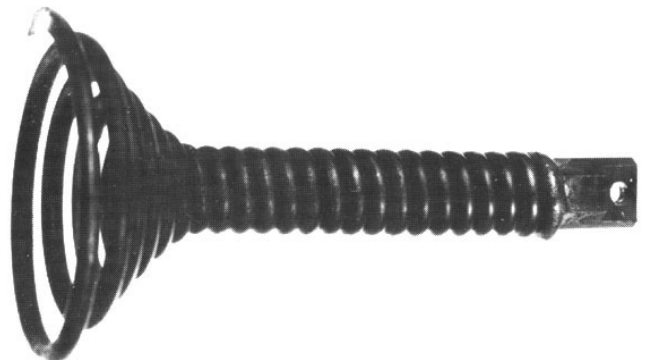



# BLADE HOLDERS AND BLADES

FOR MODELS '400', '300' OHD, HD-53 & 53B  
Sewer Machines - 3/4" Cable

## STANDARD 'U' TYPE BLADES

Part Name	Item #	Price
2" U Blades .....	F055	\$5.90
3" U Blades .....	F056	\$6.25
4" U Blades .....	F057	\$6.80
6" U Blades .....	F058	\$8.60

## Cutting Blades

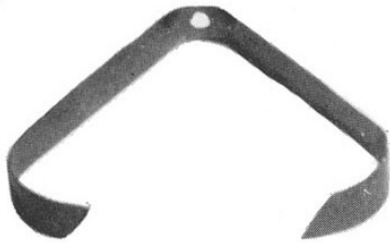

## P-TRAP BLADES

Part Name	Item #	Price
2" P-Trap Blade .....	F069	\$4.45
2 1/2" P-Trap Blade .....	F070	\$4.65
3" P-Trap Blade .....	F071	\$5.05
3 1/2" P-Trap Blade .....	F072	\$5.45

## 3-PRONG BLADES

Part Name	Item #	Price
2" 3 Prong Blades (Each) .....	MC115	\$3.25
3" 3 Prong Blades (Each) .....	MC109	\$3.90
4" 3 Prong Blades (Each) .....	MC131	\$4.70
6" 3 Prong Blades (Each) .....	MC135	\$5.25

SPEAR BLADES  
Item # F307 - \$15.50

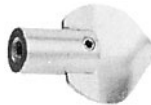

## GREASE BLADES

Part Name	Item #	Price
2" Grease Blade .....	F345	\$8.65
3" Grease Blade .....	F316	\$8.90
4" Grease Blade .....	F328	\$9.25

BORING TOOL  
Item # F332 - \$17.50

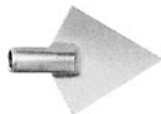

BLADE HOLDERS, NON-LOCK 3/8" S.A.E.  
Item # F059 - \$11.50  
(FOR 5/8", 3/4" & 11/16" CABLE)

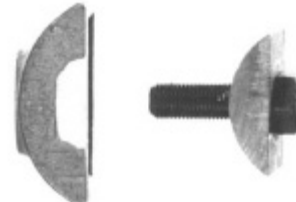

3-BLADE HOLDER  
Item # F356 - \$21.50  
Uses: Holds 2" to 6" Tri-Blade Cutters



BLADE HOLDERS (SMALL)  
Item # F210 - \$7.30  
(FOR P-TRAP BLADES) 5/8", 3/4" & 11/16"



SAW BLADES  
Item # F353 - \$21.95  
Line Use 4" - 6"



BLADE HOLDER, LOCK-ON 3/8" S.A.E.  
Item # F060 - \$10.15  
(FOR 5/8", 3/4" & 11/16" CABLE)



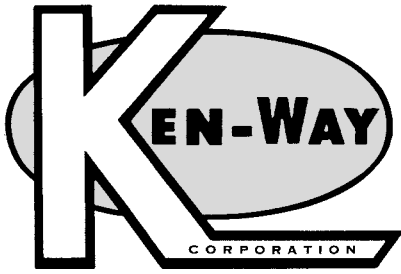

# CLOSET AUGERS

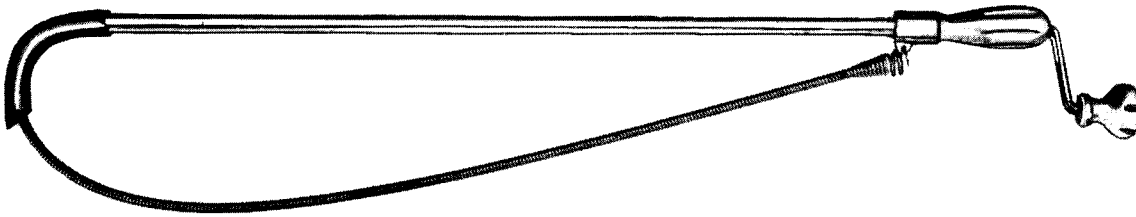

## HEAVY DUTY CLOSET AUGER

3/4" Steel Tube cadmium plated to prevent rust. Cast aluminum grip handle.

Extra heavy steel crank with cast aluminum turning knob. Rubber bowl guard.

One piece heat-tempered music wire spring with open hook end.

Wire will not pull out top of tube.

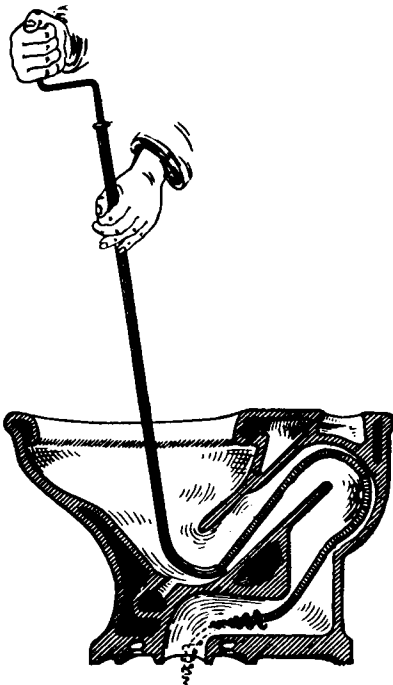

**HEAVY DUTY CLOSET AUGER.** Flexible Coil made of a special prepared SWEDISH SPRING STEEL MUSIC WIRE. No. 12 gauge, 1/2" size, with removable corkscrew and cone wire. A very flexible and most durable spring made. Assembled with steelhandle and heavy steel tube, cadmium plated, non-rusting. Perfect construction; lasts indefinitely.

Part Name	Item #	Price
Heavy Duty Closet Auger 6' w/ Drop-Head .....	J207	\$63.70
Refill Wire 6' w/ Drop-Head .....	J330	\$41.55
Heavy Duty Closet Auger 6' w/ Bulb-End .....	J208	\$56.60
Refill Wire 6' w/ Bulb-End .....	J315	\$34.35

We Hope You Will File This Catalog,  
And Use It To Full Advantage  
On Future Orders.

### PHONE

TOLL  
FREE

1-800-533-0551  
(608) 269-3752

Fax (608) 269-8129

For Your Convenience  
And To Avoid Delays,  
Use The Enclosed Order Blank.

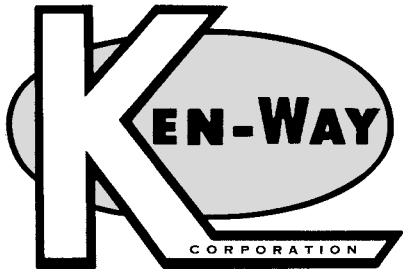

# HAND SPINNER

Highest Quality - Hand Tighten Chuck - No Trap or Cross Bar Removal -  
Light Weight - Easy to Use, 1" to 1-1/2" Drain Lines.

Part Name	Item #	Price
Ken-Way Hand Spinner - with 1/4" x 15' Open End Cable - Complete.....	J338	\$67.55
Ken-Way Hand Spinner - with 1/4" x 25' Open End Cable - Complete.....	J342	\$76.30

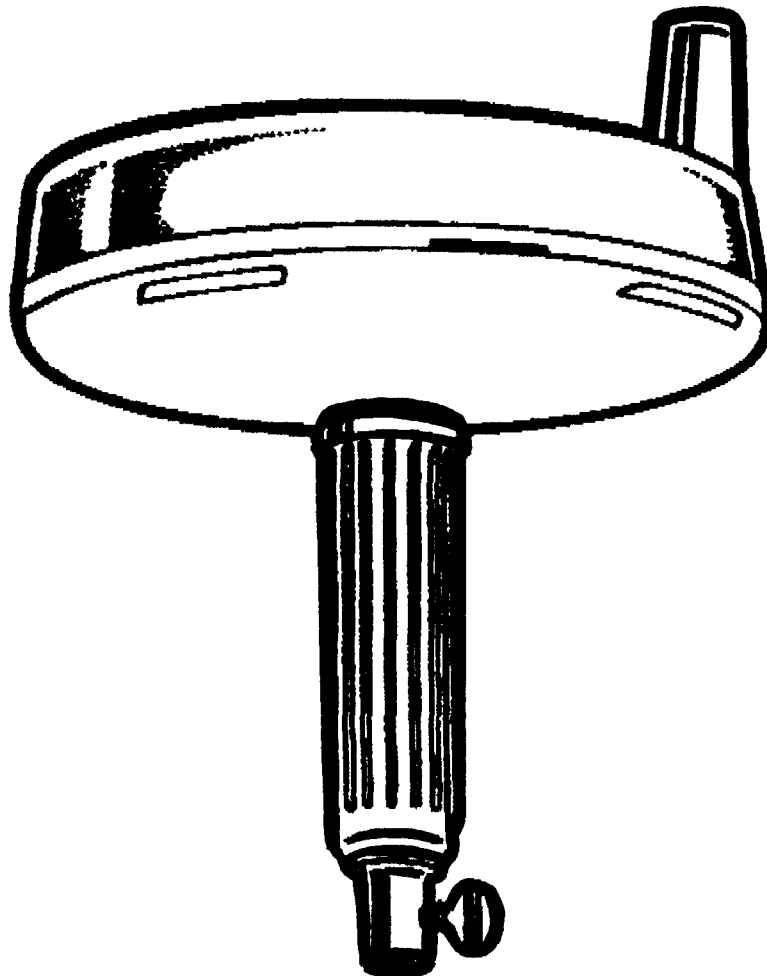

# NOTES