

Sewerooter T-3™

Operating Instructions

**For 1-1/4" through 3" and Most 4" lines
(30mm—100mm)**



Your Sewerooter T-3 is designed to give you years of trouble-free, profitable service. However, no machine is better than its operator.

Read, understand and follow all safety warnings and instructions provided with the product. Failure to follow the warnings and instructions may result in electric shock and/or serious injury. Save all warnings and instructions for future reference.

SAVE THESE INSTRUCTIONS!

General
PIPE CLEANERS



WARNING
 Read and understand operator's manual before using this machine. Failure to follow operating instructions could result in death or serious injury.

WARNING! Read and understand all instructions. Failure to follow all instructions listed below may result in electric shock, fire and/or serious personal injury. Replacement manuals are available upon request at no charge, or may be downloaded from our website, www.drainbrain.com. Instructional videos are available for download on our website, and may be ordered. If you have any questions or problems, please call General's customer service department at 412-771-6300.

SAVE THESE INSTRUCTIONS!

These instructions are intended to familiarize all personnel with the safe operation and maintenance procedures for the Sewerooter T-3.

SAFETY SYMBOLS



This is the safety alert symbol. It is used to alert you to potential personal injury hazards. Obey all safety messages that follow this symbol to avoid possible injury or death.

DANGER

DANGER indicates a hazard with a high level of risk which, if not avoided, will result in death or serious injury.

WARNING

WARNING indicates a hazard with a medium level of risk which, if not avoided, could result in death or serious injury.

CAUTION

CAUTION indicates a hazard with a low level of risk which, if not avoided, will result in minor or moderate injury.

WARNING



Electric shock resulting in death can occur if you plug this machine into an improperly wired outlet. If the ground wire is electrified, you can be electrocuted by just touching the machine, even when the power switch is off. A ground fault circuit interrupter will not protect you in this situation. Use a UL approved tester to determine if the outlet is safe.

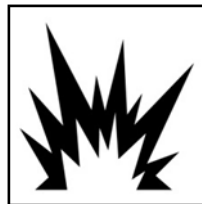

Do not operate power tools in explosive atmospheres, such as in the presence of flammable liquids, gases, or dust. Power tools create sparks which may ignite the dust or fumes.



Only wear leather gloves. Never use any other type of glove, such as cloth, rubber, or coated gloves. Never grasp a rotating cable with a rag. These items could become wrapped around the cable and cause serious injury.

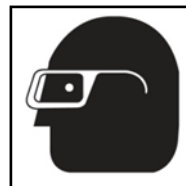

Always wear safety glasses and rubber soled, non-slip shoes. Use of this safety equipment may prevent serious injury.



Never operate machine with belt guard removed. Fingers can get caught between belt and pulley.

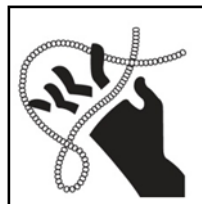

Do not overstress cables. Overstressing cables may cause twisting, kinking, or breaking of the cable and may result in serious injury.

GENERAL SAFETY RULES

WARNING

Read and understand all instructions. Failure to follow all instructions listed below may result in electric shock, fire, and/or serious injury.

SAVE THESE INSTRUCTIONS!

Work Area

1. **Keep work area clean and well lit.** Cluttered benches and dark areas invite accidents.
2. **Do not operate power tools in explosive atmospheres, such as in the presence of flammable liquids, gases, or dust.** Power tools create sparks which may ignite the dust or fumes.
3. **Keep bystanders, children, and visitors away while operating a power tool.** Distractions can cause you to lose control.

Electrical Safety

1. **Grounded tools must be plugged into an outlet, properly installed and grounded in accordance with all codes and ordinances. Never remove the grounding prong or modify the plug in any way. Do not use any adapter plugs. Check with a qualified electrician if you are in doubt as to whether the outlet is properly grounded.** If the tool should electrically malfunction or break down, grounding provides a low resistance path to carry electricity away from the user.
2. **Avoid body contact with grounded surfaces such as pipes, radiators, ranges and refrigerators.** There is an increased risk of electric shock if your body is grounded.
3. **Do not expose power tools to rain or wet conditions.** Water entering a power tool will increase the risk of electric shock.
4. **Do not abuse the cord.** Never use the cord to carry the tools or pull the plug from an outlet. Keep cord away from heat, oil, sharp edges or moving parts. Replace damaged cords immediately. Damaged cords increase the risk of electric shock.
5. **When operating a power tool outside use an outdoor extension cord marked "W-A" or "W".** These cords are rated for outdoor use and reduce the risk of electric shock.
6. **Test the Ground Fault Circuit Interrupter (GFCI) provided with the power cord to insure it is operating correctly before operating machine.** Machine must have a properly functioning ground fault circuit interrupter on the power cord. GFCI reduces the risk of electric shock.
7. **Extension cords are not recommended unless they are plugged into a Ground Fault Circuit Interrupter (GFCI) found in circuit boxes or outlet receptacles.** The GFCI on the machine power cord will not prevent electric shock from the extension cords.
8. **Only use proper three-wire extension cords in good condition which have three-prong grounding plugs and three-pole receptacles which accept the tool's plug.** Use of damaged, inferior, or other extension cords will not ground the tool. Increases the risk of electric shock and bodily injury or death.
9. **Keep all electric connections dry and off the ground.** Reduces the risk of electric shock.
10. **DO NOT touch plugs or tools with wet hands.** Reduces the risk of electric shock.

Personal Safety

1. **Stay alert, watch what you are doing and use common sense when operating a power tool. Do not use tool while tired or under the influence of drugs, alcohol, or medication.** A moment of inattention while operating power tools may result in serious personal injury.
2. **Dress properly. Do not wear loose clothing or jewelry. Contain long hair. Keep your hair, clothing, and gloves away from moving parts.** Loose clothes, jewelry, or long hair can be caught in moving parts.
3. **Avoid accidental starting. Be sure switch is off before plugging in.** Carrying tools with your finger on the switch or plugging in tools that have the switch on invites accidents.
4. **Remove adjusting keys or wrenches before turning the tool on.** A wrench or key that is left attached to a rotating part of the tool may result in personal injury.
5. **Do not overreach. Keep proper footing and balance at all times.** Proper footing and balance enables better control of the tool in unexpected situations.
6. **Use safety equipment. Always eye protection.** Dust mask, non-skid safety shoes, hard hat, or hearing protection must be used for appropriate conditions.

Tool Use and Care

1. **Use clamps or other practical way to secure and support the workpiece to a stable platform.** Holding the work by hand or against your body is unstable and may lead to loss of control.
2. **Do not force tool. Use the correct tool for your application.** The correct tool will do the job better and safer at the rate for which it is designed.
3. **Do not use tool if switch does not turn it on or off.** Any tool that cannot be controlled with the switch is dangerous and must be repaired.
4. **Disconnect the plug from the power source before making any adjustments, changing accessories, or storing the tool.** Such preventative safety measures reduce the risk of starting the tool accidentally.
5. **Store idle tools out of reach of children and other untrained persons.** Tools are dangerous in the hands of untrained users.
6. **Maintain tools with care. Keep cutting tools sharp and clean.** Properly maintained tools, with sharp cutting edges are less likely to bind and are easier to control.
7. **Check for misalignment or binding of moving parts, breakage of parts, and any other condition that may affect the tool's operation. If damaged, have the tool serviced before using.** Many accidents are caused by poorly maintained tools.
8. **Only use accessories that are recommended by the manufacturer for your model.** Accessories that may be suitable for one tool may become hazardous when used on another tool.

Service

1. **Tool service must be performed only by qualified repair personnel.** Service or maintenance performed by unqualified repair personnel could result in a risk of injury.
2. **When servicing a tool, use only identical replacement parts. Follow instructions in the Maintenance section of this manual.** Use of unauthorized parts or failure to follow Maintenance Instructions may create a risk of electric shock or injury.

SPECIFIC SAFETY RULES



This is the safety alert symbol. It is used to alert you to potential personal injury hazards. Obey all safety messages that follow this symbol to avoid possible injury or death.



Electric shock resulting in death can occur if you plug this machine into an improperly wired outlet. If the ground wire is electrified, you can be electrocuted by just touching the machine, even when the power switch is off. A ground fault circuit interrupter will not protect you in this situation. Use a UL approved tester to determine if the outlet is safe.



Do not overstress cables. Overstressing cables may cause twisting, kinking, or breaking of the cable and may result in serious injury.

1. **Only wear leather gloves.** Never use any other type of glove, such as cloth, rubber, or coated gloves. Never grasp a rotating cable with a rag. These items could become wrapped around the cable and cause serious injury.
2. **Never operate machine with belt guard removed.** Fingers can get caught between belt and pulley.
3. **Do not overstress cables.** Keep leather-gloved hand on the guide tube for control when machine is running. Overstressing cables because of an obstruction may cause twisting, kinking, or breaking of the cable and may result in serious injury.
4. **Place the machine at a distance not greater than two feet from the opening.** Greater distances can result in cable twisting or kinking.
5. **Machine is designed for ONE-PERSON operation.** Operator must control foot switch and cable.
6. **Do not operate machine in reverse (REV).** Operating machine in reverse can result in cable damage and is used only to back cutting tool out of an obstruction.
7. **Keep hands away from rotating drum.** Do not reach into drum unless machine is unplugged. Hand may be caught in the moving parts resulting in serious injury.
8. **Be careful when cleaning drains where cleaning chemicals have been used.** Avoid direct contact with skin and eyes. Drain cleaning chemicals can cause serious burns as well as damage the cable.
9. **Do not operate machine if operator or machine is standing in water.** Will increase risk of electrical shock.
10. **Wear safety glasses and rubber soled, non-slip shoes.** Use of this safety equipment may prevent serious injury.
11. **Before starting each job, check that the cable in the drum is not broken or kinked, by pulling the cable out and checking for wear or breakage.** Always replace worn out (kinked or broken) cables with genuine GENERAL replacement cables.
12. **Only use this tool in the application for which it was designed. Follow the instructions on the proper use of the machine.** Other uses or modifying the drain cleaner for other applications may increase risk of injury.

Ground Fault Circuit Interrupter (GFCI)

Your machine is equipped with a ground fault circuit interrupter, which protects you against shock if a short circuit should occur. Check that receptacle is properly grounded. Test the GFCI before each use.

1. Plug into 120-volt receptacle.
2. Push test button. Indicator light will go out and power to machine should cut off.
3. If light does not go out when test button is pushed, **DO NOT USE THE MACHINE** until proper repairs can be made.
4. To restore power after test, push reset button. With the reset button depressed, if the machine doesn't start, stops while running, or if the operator experiences a mild shock, **DO NOT USE THE MACHINE!** Tag the machine out of service and take it to a motor repair center or return it to the factory for repairs.



THE SECTION OF CORD BETWEEN THE WALL PLUG AND THE GFCI IS NOT IN THE PROTECTED CIRCUIT.

FEATURES

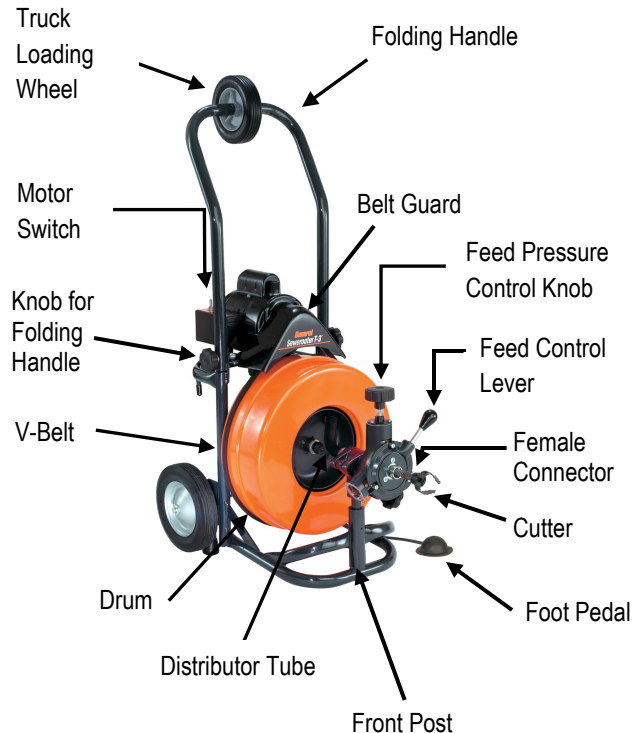

NOTE: Do not operate machine if warning labels on the switch box and power cord are missing or illegible.











Sewerooter T-3 shown with Guide Tube (Cat. #T3-GT)

Cable Application Chart (Table 1)

Cable Size	Pipe Size	Typical Applications
1/2"	3" to 4"	Roof Stacks and Small Floor Drains (No roots)
3/8"	2" to 3"	Roof Stacks, Laundry Lines and Small Drains (No roots)

Cutter Application Chart (Table 2)

Cutter	Cat. #	Typical Applications
Arrow Head 	AH	Starting tool, ideal for cutting and scraping.
1-1/2" U-Cutter 	1-1/2UC	Starting tool, works well in grease stoppages.
2" Side Cutter Blade 	2SCB	Finishing tool, for scraping inside edges of pipe.
3" Side Cutter Blade 	3SCB	Finishing tool, for scraping inside edges of pipe.
4" Side Cutter Blade 	4SCB	Finishing tool, for scraping inside edges of pipe.
3" Rotary Saw Blade 	3RSB	Finishing tool, for cutting and scraping.
Retrieving Tool 	RTR-1	To remove or retrieve loose objects.
Flexible Leader 	LE-1	Tool for negotiating around difficult bends.

Note: There are no fixed rules for what cutter to use. If one tool doesn't take care of a stoppage, simply try another.

OPERATION

SET-UP



MAKE SURE THE MOTOR SWITCH IS IN THE 'OFF' POSITION!

- Be sure the motor switch is in the **off** position.
- Place machine at a distance of not greater than two feet of drain opening. If you can't place the machine this close to the drain opening, run the cable through a pipe or a metal guide tube to prevent cable whipping. The Sewerooter T-3 Guide Tube (T3-GT) is ideal for this. Guide Tube Extensions (GTE) are also available.
- Position the air foot pedal for easy accessibility. The machine is designed for one-person operation. Be sure you can quickly remove your foot from the pedal in an emergency.

- Select the proper cutting tool (See Cutter Application Chart—Table 2). A good tool to start with is the Arrow Head or 1-1/2" U-Cutter. After the line is opened, follow with larger blades, which scrape the inside edges of the pipe, assuring a real cleaning job. If you're having difficulty getting around a P-trap or close bend, attach the Flexible Leader (for 1/2" cable only).
- Insert the cutter into the female connector at the end of the cable and tighten the connecting screw and lock washer *firmly* in place.

OPERATION

- Begin by pulling the cable from the drum and sliding it into the drain as far as it will go.
- Tighten the knob at the top of the Power Cable Feed so that the feed roller presses against the cable. Be sure not to over tighten since this could cause excess cable wear. Note: The Power Cable Feed is designed for use with 3/8" and 1/2" cables only.
- The feed lever controls the feeding rate and direction of the cable. Move the lever down to feed the cable out of the drum. The further the lever is moved downward, the faster the cable will feed out. Move the lever up to retract the cable into the drum. When the lever is in the middle (neutral) position, the cable will spin in place.

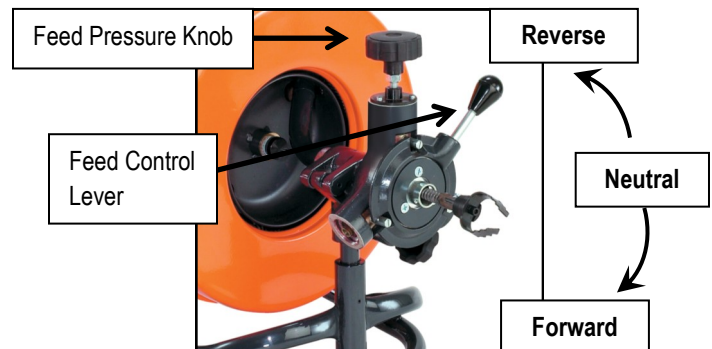

- Move the motor switch to the **forward** position. Then with a gloved hand on the guide tube, depress the air foot pedal to start machine.
- Feed the cable into the line and against the obstruction with a firm, even pressure. Adjust the feeding rate to the resistance met. Do not force the cable – let the cutter do the work. The job won't get done any faster and you could damage the cable.

**DO NOT USE TOO MUCH FORCE –
LET THE CUTTER DO THE WORK.**

- Don't leave too much slack in the cable since this will cause whipping. If the cable starts to bend or build up too much twist, release pressure on the foot pedal and rotate the drum in the opposite direction to relieve the twist on the cable. Push any excess cable back into the drum and then continue.



DO NOT ALLOW TOO MUCH SLACK IN THE CABLE BETWEEN MACHINE AND DRAIN OPENING SINCE THIS CAN CAUSE CABLE WHIPPING.

7. If you're having trouble getting around tight bends, try putting the machine in reverse while applying steady pressure. (If using Power Cable Feed, putting motor in reverse will cause the feed control lever to operate opposite of normal.)

MOTOR SWITCH

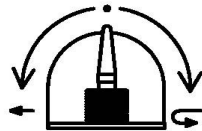

FORWARD - OFF - REVERSE

Don't run motor in reverse for more than a few seconds at a time as this could cause tangling in the drum or kinking.

8. If you still can't get around the bend, you're probably using too large a cable. Switch to a 3/8" diameter cable, or even a smaller machine if necessary. (See Cable Application Chart—Table 1)
9. When the cable reaches the stoppage, put feed in neutral. Then allow the cable to progress forward slowly, chewing into the stoppage as it goes. This slow forward movement will reduce stress on the cable while doing a more thorough cleaning job. A back and forth action often works best.

Hint: It's often helpful to have a small stream of water running in the line to wash the cuttings away while the machine is in operation and after.

10. Be careful not to let the cutter get caught in the stoppage as you work through it. This can cause kinking and breaking of the cable. When you feel the cable starting to twist in your hands, stop the machine and pull back on the cable. This will free the cutter from the obstruction. Then allow the cable to move forward slowly into the stoppage.
11. After the line has been opened, retract the cable by moving the feed lever up. Make sure the motor switch is in the **forward** position. This is important to prevent the cable from tangling in the drum or in the line.



DO NOT USE REVERSE TO PULL THE CABLE OUT OF THE DRAIN. RUNNING MACHINE IN REVERSE CAN CAUSE THE CABLE TO TANGLE IN THE DRUM.

12. When the cutter is near the drain opening, take your foot off the pedal to stop drum rotation. Never retract the cutter from drain while cable is rotating. The cable could whip and cause serious injury.

SPECIAL OPERATIONS

IF CABLE GETS CAUGHT IN LINE

The motor can be reversed to free cable if it gets caught in the line. (Note: if using Power Cable Feed, putting motor in reverse will cause the feed control lever to operate opposite of normal.) Use the following procedure:

1. Move motor switch to reverse position.
2. Wearing leather gloves, retract cable while the drum is turning in reverse.
3. When the cable is freed, slide excess cable back into drum.

4. Move the motor switch to the forward position again, and continue at Step 3 of the Operating Instructions.



DO NOT RUN MOTOR IN REVERSE FOR MORE THAN A FEW SECONDS AT A TIME SINCE THIS COULD CAUSE THE CABLE TO KINK OR TANGLE IN THE DRUM.

IF CABLE TANGLES IN DRUM

This is caused by using too much pressure when feeding the cable or by feeding the cable while running the machine in reverse. To untangle cable, rotate drum in opposite direction. This will usually get the cable to lie in the drum properly.

If cable has become severely tangled, which shouldn't occur if used properly, it can be straightened out by removing the distributor tube from the drum. To do this:



DISCONNECT MACHINE FROM POWER SOURCE BEFORE UNTANGLING CABLES

1. Turn the drum until the distributor tube is pointing down.
2. While holding the tube firmly, loosen the knob on the front post.
3. Swing the hinged cap out of the way and lift out the tube. This should free the cable. If not, continue to Step 4.
4. Reach into the center of the drum and unscrew the knob at the center of the inner drum. Then, pull the inner drum forward off the shaft and out of the drum.
5. After the cable has been untangled, reverse the above procedure and reload the cable into the drum.

HOW TO REMOVE DRUM



DISCONNECT MACHINE FROM POWER SOURCE BEFORE EXCHANGING DRUMS!

1. Remove V-Belt. You can relieve the tension on the belt by pressing down on the motor, which is spring-loaded.
2. Hold distributor tube and loosen knob on front post. Then, open hinged cap and lift out tube.
3. Reach behind the drum and locate the drum retaining latch. While pulling the latch, pull the drum forward off of the machine.
4. To install the drum, simply reverse this procedure.

HOW TO INSTALL POWER CABLE FEED (PO-JR)

The Power Cable Feed gives you a "power-assist" when feeding cables in or pulling them out. When feeding, do not use too much force – let the cutter do the work.



DISCONNECT MACHINE FROM POWER SOURCE BEFORE INSTALLING POWER CABLE FEED!

1. Slide the Power Cable Feed onto the mounting stud located on the front post.
2. Align the mounting knob on the Feed body with the flat spot on the stud.
3. Tighten knob firmly.



HOW TO INSTALL CABLES IN DRUM



DISCONNECT MACHINE FROM POWER SOURCE BEFORE INSTALLING CABLES IN DRUM!

1. Attach male connector of cable to the drum connecting cable permanently connected to the drum. Be sure to tighten screw and lock washer firmly.
2. Slip V-Belt off of drum. If using Power Cable Feed, loosen pressure knob on top.
3. Push the cable into the drum. As you load, turn the drum so that the distributor tube is always pointed in the same direction. This enables the cable to lie more evenly in the drum.
4. Be sure cable is going in proper direction. To check, position distributor tube so that it's pointing straight down. The cable should be bending to the left as it comes out of the back of the distributor tube.

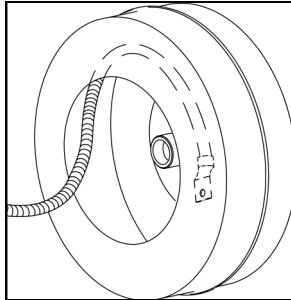

NOTE: The cable must lay in the drum in the correct direction or it will tangle in the drum.

MAINTENANCE



DISCONNECT MACHINE FROM POWER SOURCE BEFORE PERFORMING MAINTENANCE!

To keep your machine operating smoothly, it is essential that all bearings and distributor tube bushings be lubricated. Oiling moving parts is particularly important where machine comes in contact with sand, grit and other abrasive material.

CABLE MAINTENANCE

To get maximum service from your cables, be sure that they are clean and well oiled. This not only provides running lubrication but greatly extends the life of the cables as well. Some users periodically pour oil directly into the drum. Then, as the drum turns, the cables get complete lubrication. Our SNAKE OIL is ideally suited for this purpose, since it not only lubricates the cables, it deodorizes them as well.



FEED MAINTENANCE

Keep feed free of excessive soil and grit. It is recommended that the feed be flushed with fresh water followed by a light oiling of the moving parts. No disassembly is normally required. Failure to feed can usually be traced to the following possibilities:

DIRT ACCUMULATION

Over time, dirt can harden enough to stop roller rotation. Flushing with water followed by liberal oiling can usually restore function. If disassembly is required, proceed as follows:

1. Remove the feed pressure knob, cover screws, top cover, spring, ball bearing and ball bearing holder. Note the positioning of these parts to ease re-assembly. Remove the swing pin from the carrier. The top roller assembly can now be removed.
2. Remove the snap rings and thrust washers from the bottom housing cylinders. Remove swing pins from carriers. The bottom roller assemblies can now be removed.
3. Re-assembly is done in reverse order.

DAMAGED ROLLER

Excessive use may wear a roller to the point of failure. It is recommended that all three rollers be replaced at the same time (Cat # PO-JR-703). The replacement roller is an assembly consisting of one Feed Roller, two Feed Roller Bearings, and two Bearing Spacers.

Note: The Bearing Spacers must be installed between the Carrier and each Feed Roller Bearing (as illustrated below) in order to ensure proper operation and to obtain maximum Feed Roller life.

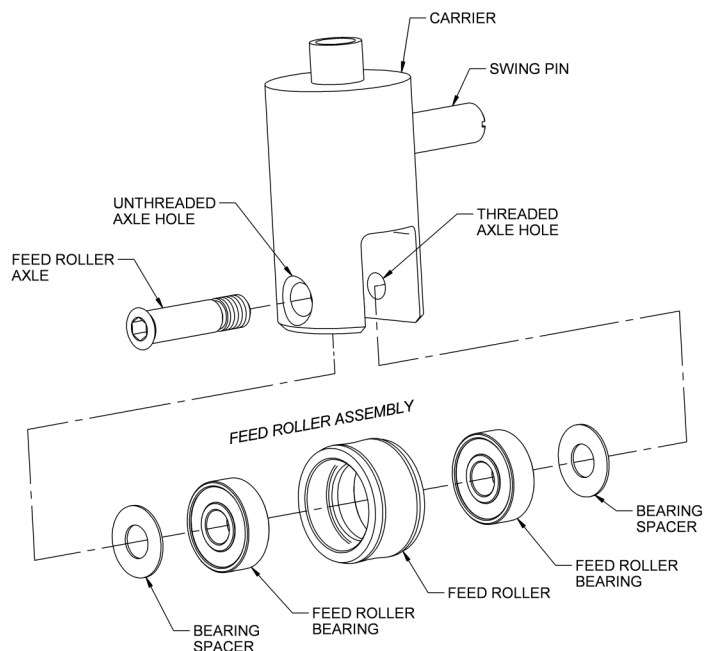

To Replace the Feed Roller Assembly:

1. Remove the Feed Roller Assembly by unscrewing and removing the Feed Roller Axle.
2. For convenience, the components are assembled and wired together at the factory. Before attempting to install the assembly, hold the assembly together and remove the wire.
3. While still holding the Feed Roller Assembly together, insert it into the slot opening of the Carrier.
4. In order to help align the Spacers and Bearings, insert a pencil point or similar object through the **un-threaded** end of the Axle hole in the Carrier. After removing the pencil point, continue to maintain the alignment of the components.
5. The Feed Roller Axle should then be inserted through the same un-threaded Axle hole and should continue to be guided through the Spacers and Bearings to the threaded Axle hole on the other side of the Carrier.
6. Securely tighten the Axle to the Carrier with a 3/16" allen wrench.

TANGLED CABLE

If a cable loops over itself in the drum, it will not feed properly. Remove and reload the cable to restore function. If the cable kinks, it is evidence of abuse and results from the use of too much pressure or use of the wrong size cable for the line. Do not force the cable — let the cutter do the work.

TROUBLE SHOOTING GUIDE (Table 3)		
Problem	Probable Cause	Solution
Cable kinks or breaks.	Operator forcing the cable.	Do not force the cable. Let the cutter do the work.
	Too much slack between machine and drain.	Allow no more than two feet between machine and drain.
	Cable used in wrong size drain line.	A cable that is too large or too small in diameter for a line is more likely to kink. (Consult Table 1—Cable Applications.)
	Cable exposed to acid.	Clean and oil cables regularly.
Cable tangles in drum.	Operator forcing the cable.	Do not force the cable. Let the cutter do the work.
	Machine running in reverse.	Do not run the machine in reverse to retract the cable from the drain.
	Distributor tube frozen.	Lubricate distributor tube bushings.
Drum stops while foot pedal depressed.	Hole in pedal or hose.	Replace as required.
	Hole in diaphragm switch.	If no hole found in pedal or hose, replace diaphragm switch.
	Thermal overload activated.	Allow motor to cool. Press reset button.
Drum turns in one direction but not other.	Reverse switch failure.	Replace reverse switch.
Ground fault circuit interrupter trips and will not reset.	Damaged power cord or extension cord.	Replace cords.
	Short circuit in motor.	Take motor to authorized repair center.
	Faulty ground fault circuit interrupter.	Replace ground fault circuit interrupter.
Failure to feed.	Cable tangled in drum.	Do not run machine in reverse. Use proper cable size. (Consult Cable Application Chart—Table 1).
	Feed misadjusted.	If feed tension knob is too loose the cable will slip. If it is too tight the feed rollers will wear prematurely.
	Feed roller frozen.	Clean and lubricate feed rollers regularly. Replace worn rollers.
	Worn cable.	When cable coils wear flat, cable should be replaced.

SEWEROOTER T-3 PARTS LIST

CAT. NO.	DESCRIPTION	CAT. NO.	DESCRIPTION
T3-100-3	Frame Complete (Passive Brake) 10" Wheel	T3-401	Drum Complete*
T3-101-3	Frame Only (for 10" Wheel w/Passive Brake)	T3-401-2	Drum Complete^
T3-101-A	Rubber Cord Wrap Tips (2)	T3-402	Drum Shell
T3-102	Distributor Tube Support Post & Clamp	T3-404	Drum Hub w/Bushings
T3-102-A	Post Locking Knob	T3-404-A	Hub Bushings (2)
T3-102-B	3/8" Set Screws (3)	T3-405	Hub Bolts, Nuts & Washers (5)
T3-102-C	Roll Pin	T3-409	Inner Drum Cage
T3-103	Spring	T3-409-A	Cage Bushing
T3-104	Shaft Retaining Pin	T3-410	Drum Connecting Cable
T3-105	Collar w/Set Screw	T3-410-A	Connecting Cable Bolt, Nut & Washer
T3-106	Handle Locking Knobs (2)	T3-415	Inner Drum Cage Retaining Knob w/Washer*
T3-107	Plated Handles	T3-415-2	Inner Drum Cage Retaining Knob w/Washers^
T3-107-A	Left Handle	T3-415-A	Washers^
T3-107-B	Right Handle	T3-420	Drum Retaining Knob w/Beveled Collar*
T3-107-C	Handle Wheel	T3-420-A	Rear Beveled Collar*
T3-107-D	Axle for Handle Wheel	T3-432	Drum Shaft*
T3-107-E	Bushings (2)	T3-432-2	Drum Shaft^
T3-107-F	Felt Washers (2)	T3-432-A	Shaft Retaining Ring*
T3-107-G	Set Screws (2)	T3-432-A-1	Shaft Retaining Ring (for Passive Brake Frame)
T3-110	8" Wheel w/Cap	T3-440	Front Beveled Collar w/Set Screw*
T3-110-1	10" Wheel w/Cap	T3-440-1	Spacer Collar w/Set Screw^
T3-111	Wheel Retainer Cap	T3-441	Wear Washer
T3-112	Wheel Retaining Spacer (for Brake Rod Frame) (3)	T3-600	Motor w/Foot Switch, Reverse Switch & GFCI
T3-112-1	Wheel Spacer (for Passive Brake Frame) (2)	T3-601	V-Belt 53" *
T3-113	Rubber Leg Tips (2)	T3-601-1	V-Belt 52" ^
T3-115	Axle	T3-602	V-Belt Pulley
T3-118	Motor Support w/Bolts, Nuts & Washers*	GFI-20	20' Power Cord w/GFCI
T3-118-1	Motor Support w/Bolts, Nuts & Washers^	T3-605	Belt Guard Knob
T3-118-2	Motor Support w/Bolts, Nuts & Washers (One Stem)^	T3-610	Foot Switch & Reverse Switch Assembly
T3-118-A	Motor Support Bolts, Nuts & Washers (4)	T3-610-A	Box Only w/Cover & Screws
T3-118-1-B	Bolt & Nut (for Two Stem Motor Support)	T3-610-B	Foot Pedal & Hose
T3-118-1-C	Bolt & Washer (for Two Stem Motor Support)	T3-610-C	Hose Clamp
T3-118-D	Guide Screws (2)^	T3-610-D	Foot Pedal Only
T3-119	Motor Support Spring	T3-610-E	Power Switch Diaphragm
T3-201	Distributor Tube Assembly	T3-610-F	Air Hose Only
T3-202	Distributor Tube Only	T3-610-G	Reverse Switch (3-Way)
T3-203	Front Collar w/Set Screw	T3-610-K	Switch Guard
T3-205	Rear Collar w/Set Screw	T3-610-N	Strain Relief Nut
T3-207	Thrust Bearing Race	T3-615-1	Belt Guard w/Slot for Stud
T3-210	Distributor Tube Bushings (2)	T3-GTE	Guide Tube Extension
		PO-JR	Junior Power Cable Feed
		T3-DECAL	Set of Safety Decals

* For T3-401 Style Drum

^For T3-401-2 Style Drum

JUNIOR POWER CABLE FEED PARTS LIST
for Sewerooter Junior & Sewerooter T-3

CAT. NO.	DESCRIPTION
PO-JR-GT	JR Power Feed & Guide Tube
PO-JR-101	Feed Body
PO-JR-101-A	Spout
PO-JR-101-B	Guide Clip
PO-JR-102	Knob
PO-JR-102-A	Limiting Nut
PO-JR-200	Top Roller Assembly
PO-JR-210	Top Carrier Only
PO-JR-220	Swing Pin
PO-JR-225	Feed roller Shaft
PO-JR-250	Feed Roller w/Bearing
PO-JR-301	Feed Pressure Knob
PO-JR-301-A	Limiting Nut
PO-JR-315	Pressure Spring
PO-JR-330	Ball Bearing
PO-JR-331	Ball Bearing Holder
PO-JR-340	Top Cover
PO-JR-341	Cover Screws (3)
PO-JR-400	Bottom Roller Assembly
PO-JR-410	Bottom Carrier Only
PO-JR-420	Swing Pin
PO-JR-425	Bottom Roller Shaft
PO-JR-450	Bottom Roller w/Bearing
PO-JR-510	Retaining Ring
PO-JR-530	Thrust Bearing & Races
PO-JR-601	Feed Control Disc w/Lever & Knob
PO-JR-601-A	Lever & Knob
PO-JR-601-B	Lifting Spring & Screw
PO-JR-635	Wave Washer
PO-JR-640	Feed Control Retaining Cover
PO-JR-641	Retaining Cover Screws (3)
PO-JR-703	Set of Rollers (3)
PO-JR-DECAL	Set of Safety Decals
JR-GT	Guide Tube for JR

POWER CABLE FEED JUNIOR SCHEMATIC DIAGRAM

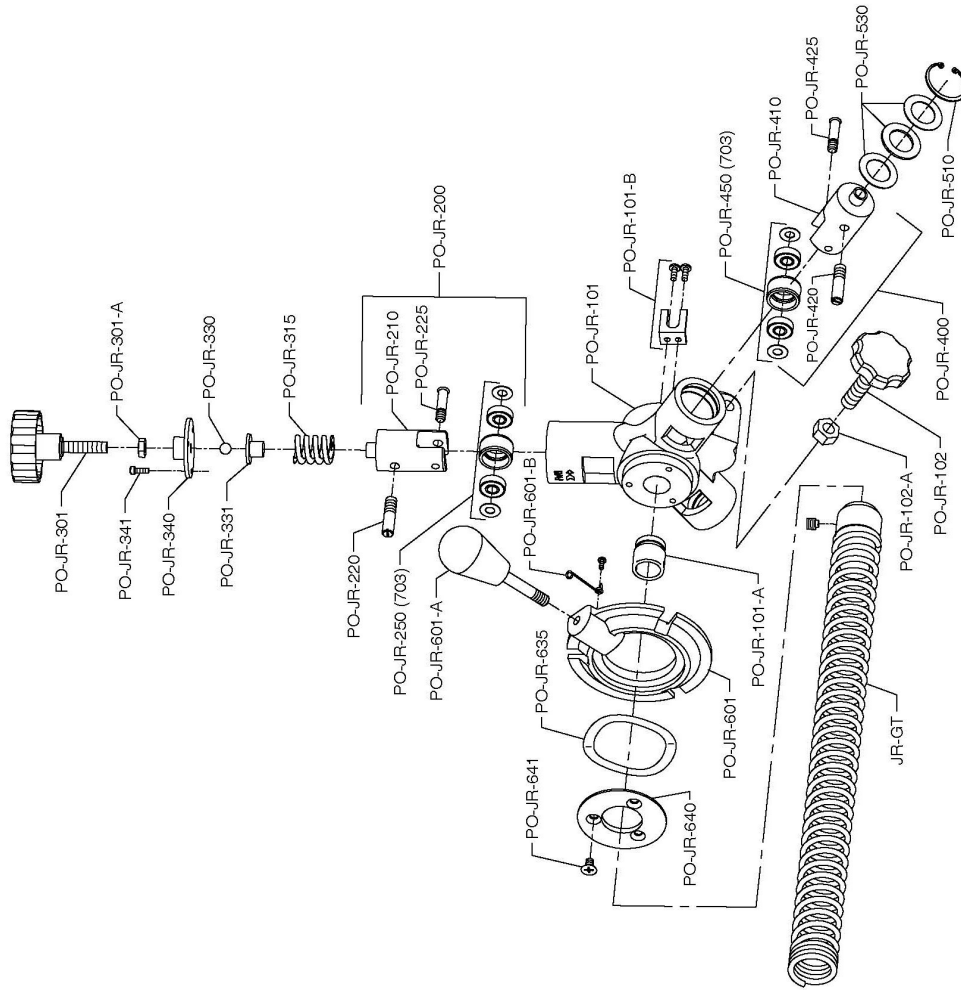

IMPORTANT: When ordering, give Serial Number of Machine.

General Wire Spring Co,
1101 Thompson Avenue
McKees Rocks, PA 15136
412-771-6300 www.drainbrain.com