

# KOHLER® Faucets 10" rainhead with Katalyst® air-induction technology, 2.5 gpm K-13696

## Features

- Single-function rain showerhead.
- MasterClean™ sprayface features an easy-to-clean surface that withstands mineral buildup.
- Katalyst® spray technology with air-induction ball joint.
- Optimized sprayface for maximum performance.
- 2.5 gpm (9.5 lpm) maximum flow rate.
- 1/2" - 14 NPT connection.

## Material

- Solid brass construction for durability and reliability.

## Recommended Products/Accessories

K-23723 Faucet cleaner



## Codes/Standards

ASME A112.18.1/CSA B125.1







DOE - Energy Policy Act 1992

## KOHLER® Faucet Lifetime Limited Warranty

See website for detailed warranty information.

## Available Colors/Finishes

*Color tiles intended for reference only.*

Color	Code	Description
	CP	Polished Chrome
	SN	Vibrant® Polished Nickel
	BGD	Vibrant® Moderne Brushed Gold
	BN	Vibrant® Brushed Nickel
	BV	Vibrant® Brushed Bronze
	2MB	Vibrant® Brushed Moderne Brass
	TT	Vibrant Titanium

1-800-4KOHLER (1-800-456-4537)

Kohler Co. reserves the right to make revisions without notice to product specifications.

For the most current Specification Sheet, go to [www.kohler.com](http://www.kohler.com).

10-28-2020 03:55 - US/CA/MX

THE BOLD LOOK  
OF **KOHLER®**

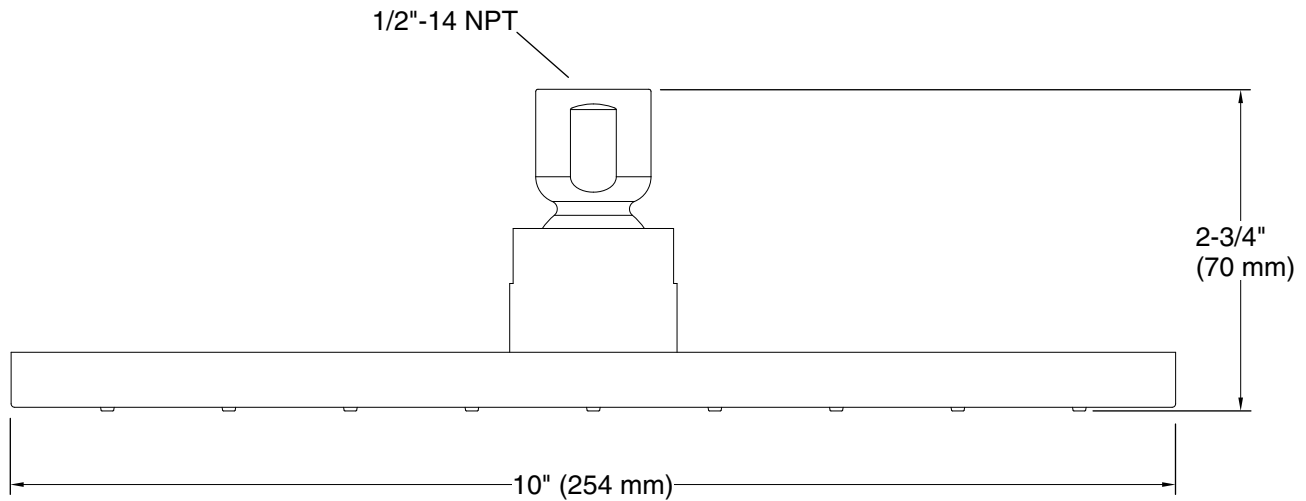

**Technical Information**

All product dimensions are nominal.

**Faucet:**

Flow rate: 2.5 gal/min (9.5 l/min)

**Notes**

Install this product in accordance with the installation instructions.