

**G-FIRE #577 Global and Domestic – Rigid Coupling  
with Grade “A” EPDM Fire Protection Pre-Lubricated Gasket**

Nom. Size	Painted			Galvanized		
	Global Part Number	Domestic Part Number	List Price	Global Part Number	Domestic Part Number	List Price
1"	–	57701ASC	\$53.50	–	57701AGSC	\$67.50
1 1/4"	57713ACP	57713ASC	\$40.00	57713AGCP	57713AGSC	\$48.00
1 1/2"	57715ACP	57715ASC	\$41.00	57715AGCP	57715AGSC	\$49.00
2"	57720ACP	57720ASC	\$46.00	57720AGCP	57720AGSC	\$54.50
2 1/2"	57725ACP	57725ASC	\$53.50	57725AGCP	57725AGSC	\$64.00
3"	57730ACP	57730ASC	\$60.50	57730AGCP	57730AGSC	\$75.00
4"	57740ACP	57740ASC	\$85.50	57740AGCP	57740AGSC	\$102.50
5"	57750ACP	57750ASC	\$113.50	57750AGCP	57750AGSC	\$143.00
6"	57760ACP	57760ASC	\$136.00	57760AGCP	57760AGSC	\$165.00
8"	57780ACP	57780ASC	\$227.50	57780AGCP	57780AGSC	\$276.50
10"	57710ACP	57710ASC	\$489.00	57710AGCP	57710AGSC	\$653.00
12"	57712ACP	57712ASC	\$546.50	57712AGCP	57712AGSC	\$732.00

Technical Data Sheet: TFP1854

Section 16  
Specialty Items

Section 18  
Grooved Products

Section 19  
CPVC Pipe & Fittings

Section 20  
Miscellaneous

Section 21  
Electrical

Section C  
Valves & Hose Equipment

Section D  
Backflow

Section F  
Pipe & Accessories

Section H  
Hangers

Section J  
Lubricants

Section K  
Misc.

**G-FIRE #577 Global – Rigid Tri-Seal Coupling  
with Grade “E” EPDM Tri-Seal Gasket Recommended for  
Dry Pipe Systems and Freezer Applications – Use Silicone Lubricant**

Nom. Size	Painted		Galvanized	
	Global Part Number	List Price	Global Part Number	List Price
1"	57701E3S	\$76.00	57701E3GS	\$90.50
1 1/4"	57713E3S	\$40.00	57713E3GS	\$48.00
1 1/2"	57715E3S	\$41.00	57715E3GS	\$49.00
2"	57720E3S	\$46.00	57720E3GS	\$54.50
2 1/2"	57725E3S	\$53.50	57725E3GS	\$64.00
3"	57730E3S	\$60.50	57730E3GS	\$75.00
4"	57740E3S	\$85.50	57740E3GS	\$102.50
5"	57750E3S	\$195.50	57750E3GS	\$225.00
6"	57760E3S	\$215.50	57760E3GS	\$252.00
8"	57780E3S	\$349.00	57780E3GS	\$404.50
10"	57710E3S	\$588.00	57710E3GS	\$747.50
12"	57712E3S	\$669.00	57712E3GS	\$860.50

Technical Data Sheet: TFP1854

**#705 Global and Domestic – Flexible Coupling  
with Grade “A” EPDM Fire Protection Pre-Lubricated Gasket**

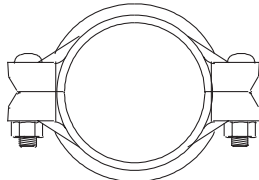
	Nom. Size	Painted			Galvanized		
		Global Part Number	Domestic Part Number	List Price	Global Part Number	Domestic Part Number	List Price
		1 1/4"	70513ACP	70513ASC	\$40.50	70513AGCP	70513AGSC
1 1/2"	70515ACP	70515ASC	\$49.50	70515AGCP	70515AGSC	\$61.50	
2"	70520ACP	70520ASC	\$60.00	70520AGCP	70520AGSC	\$79.50	
2 1/2"	70525ACP	70525ASC	\$70.00	70525AGCP	70525AGSC	\$98.00	
3"	70530ACP	70530ASC	\$78.00	70530AGCP	70530AGSC	\$108.00	
4"	70540ACP	70540ASC	\$112.00	70540AGCP	70540AGSC	\$158.50	
5"	–	70550ESC	\$170.00	–	70550EGSC	\$244.50	
6"	70560ACP	70560ASC	\$201.00	70560AGCP	70560AGSC	\$288.50	
8"	70580ACP	70580ASC	\$327.00	70580AGCP	70580AGSC	\$486.00	
10"	–	70510ESC	\$532.50	–	70510EGSC	\$763.50	
12"	–	70512ESC	\$605.50	–	70512EGSC	\$867.00	

Orders for items in shaded areas **cannot** be cancelled or returned.

**Technical Data Sheet: TFP1820**

**#705 Domestic – Flexible Tri-Seal Coupling  
with Grade “E” EPDM Tri-Seal Gasket Recommended for  
Dry Pipe Systems and Freezer Applications – Use Silicone Lubricant**

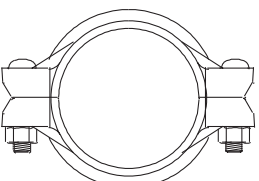
	Nom. Size	Painted		Galvanized	
		Domestic Part Number	List Price	Domestic Part Number	List Price
		1 1/4"	70513E3S	\$66.00	70513E3GS
1 1/2"	70515E3S	\$72.50	70515E3GS	\$86.50	
2"	70520E3S	\$74.00	70520E3GS	\$89.00	
2 1/2"	70525E3S	\$89.00	70525E3GS	\$104.50	
3"	70530E3S	\$94.00	70530E3GS	\$113.00	
4"	70540E3S	\$134.00	70540E3GS	\$164.00	
5"	70550E3S	\$228.50	70550E3GS	\$272.50	
6"	70560E3S	\$252.50	70560E3GS	\$306.50	
8"	70580E3S	\$420.00	70580E3GS	\$503.50	
10"	70510E3S	\$632.00	70510E3GS	\$849.50	
12"	70512E3S	\$742.00	70512E3GS	\$977.00	

Orders for items in shaded areas **cannot** be cancelled or returned.

**Technical Data Sheet: TFP1820**

**#707 Domestic Heavy-Duty Flexible Coupling  
with Grade "E" EPDM Gasket**

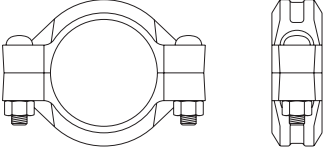
	Nominal Size	Painted		Galvanized	
		Domestic Part Number	List Price	Domestic Part Number	List Price
	1"	70701ES	\$39.00	70701EGS	\$52.50
	1 1/2"	70715ES	\$56.00	70715EGS	\$73.00
	2"	70720ES	\$60.00	70720EGS	\$79.50
	2 1/2"	70725ES	\$70.00	70725EGS	\$98.00
	3"	70730ES	\$78.00	70730EGS	\$108.00
	4"	70740ES	\$112.00	70740EGS	\$158.50
	5"	70750ES	\$170.00	70750EGS	\$244.50
	6"	70760ES	\$201.00	70760EGS	\$288.50
	8"	70780ES	\$327.00	70780EGS	\$486.00
	10"	70710ES	\$532.50	70710EGS	\$763.50
	12"	70712ES	\$605.50	70712EGS	\$867.00

Technical Data Sheet: TFP1840

**#707 Domestic Heavy-Duty Flexible Coupling  
with Grade "E" EPDM Tri-Seal Gasket Recommended for  
Dry Pipe Systems and Freezer Applications – Use Silicone Lubricant**

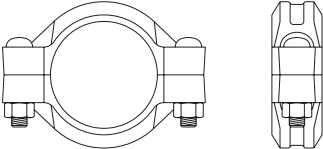
	Nominal Size	Painted		Galvanized	
		Domestic Part Number	List Price	Domestic Part Number	List Price
	1 1/2"	70715E3S	\$79.00	70715E3GS	\$98.00
	2"	70720E3S	\$82.50	70720E3GS	\$103.50
	2 1/2"	70725E3S	\$100.50	70725E3GS	\$128.00
	3"	70730E3S	\$104.00	70730E3GS	\$135.00
	4"	70740E3S	\$150.50	70740E3GS	\$197.00
	5"	70750E3S	\$263.00	70750E3GS	\$341.50
	6"	70760E3S	\$291.50	70760E3GS	\$382.50
	8"	70780E3S	\$393.50	70780E3GS	\$539.50
	10"	70710E3S	\$632.00	70710E3GS	\$849.50
	12"	70712E3S	\$742.00	70712E3GS	\$977.00

Orders for items in shaded areas **cannot** be cancelled or returned.

Technical Data Sheet: TFP1840

Section 16  
Specialty Items

Section 18  
Grooved Product

Section 19  
CPVC Pipe & Fittings

Section 20  
Miscellaneous

Section 21  
Electrical

Section C  
Valves & Hose Equipment

Section D  
Backflow

Section F  
Pipe & Accessories

Section H  
Hangers

Section J  
Lubricants

Section K  
Misc.

**#716 Domestic – Reducing Coupling  
with Grade “E” EPDM Non-Lubricated Gasket**

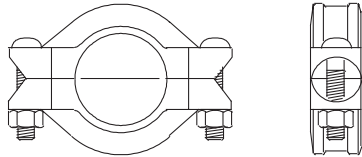

Nom. Size	Painted		Galvanized	
	Domestic Part Number	List Price	Domestic Part Number	List Price
2" x 1 1/2"	7162015ES	\$80.00	7162015EGS	\$96.50
2 1/2" x 2"	7162520ES	\$103.50	7162520EGS	\$129.50
3" x 2"	7163020ES	\$118.00	7163020EGS	\$148.50
3" x 2 1/2"	7163025ES	\$102.00	7163025EGS	\$129.50
4" x 2"	7164020ES	\$186.00	7164020EGS	\$234.50
4" x 2 1/2"	7164025ES	\$167.00	7164025EGS	\$219.50
4" x 3"	7164030ES	\$156.50	7164030EGS	\$202.00
5" x 4"	7165040ES	\$210.00	7165040EGS	\$275.50
6" x 4"	7166040ES	\$316.50	7166040EGS	\$399.00
6" x 5"	7166050ES	\$277.50	7166050EGS	\$359.50
8" x 6"	7168060ES	\$473.50	7168060EGS	\$599.00

Technical Data Sheet: TFP1830

**#716 Reducing Coupling Plate**

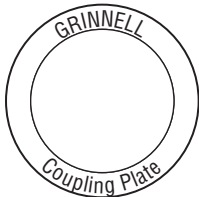

Nom. Size	Plate Part No.	List Price
2" x 1 1/2"	7162015W	POA
2 1/2" x 2"	7162520W	POA
3" x 2"	7163020W	POA
3" x 2 1/2"	7163025W	POA
4" x 2"	7164020W	POA
4" x 2 1/2"	7164025W	POA
4" x 3"	7164030W	POA
5" x 4"	7165040W	POA
6" x 4"	7166040W	POA
6" x 5"	7166050W	POA
8" x 6"	7168060W	POA

Orders for items in shaded areas **cannot** be cancelled or returned.

**Replacement Gaskets, Grade “E” EPDM Gasket for #716 Reducing Coupling**

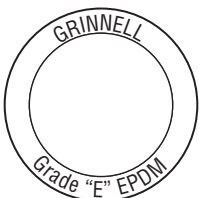

Nom. Size	Plate Part No.	List Price
2" x 1 1/2"	2015EPDME	\$30.00
2 1/2" x 2"	2520EPDME	\$39.00
3" x 2"	3020EPDME	\$44.50
3" x 2 1/2"	3025EPDME	\$44.50
4" x 2"	4020EPDME	\$51.50
4" x 2 1/2"	4025EPDME	\$52.00
4" x 3"	4030EPDME	\$54.00
5" x 4"	5040EPDME	\$63.00
6" x 4"	6040EPDME	\$71.50
6" x 5"	6050EPDME	\$78.00
8" x 6"	8060EPDME	\$86.50

Orders for items in shaded areas **cannot** be cancelled or returned.

See latest catalog or technical data sheets for specific approvals, listings, and design parameters.  
POA = Price on availability. Prices subject to change without notice.

**#71 Domestic – Grooved Flange Adapter  
with Grade “E” EPDM Non-Lubricated Gasket**

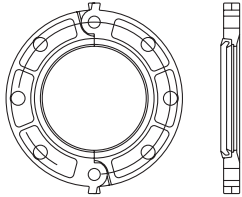
	Nom. Size	Painted		Galvanized	
		Domestic Part Number	List Price	Domestic Part Number	List Price
			2"	7120S	\$176.50
	2½"	7125S	\$205.50	7125GS	\$244.50
	3"	7130S	\$231.50	7130GS	\$277.50
	4"	7140S	\$301.00	7140GS	\$367.00
	5"	7150S	\$361.50	7150GS	\$440.50
	6"	7160S	\$394.00	7160GS	\$480.00
	8"	7180S	\$495.00	7180GS	\$619.00
	10"	7110S	\$951.50	7110GS	\$1,209.50
	12"	7112S	\$1,245.00	7112GS	\$1,599.50

Orders for items in shaded areas **cannot** be cancelled or returned.

Technical Data Sheet: TFP1880

**#71 Flange Adapter – Metal Washer**

	Nom. Size	Washer Part No.	List Price
	2"	7120FWC	\$83.00
	2½"	7125FWC	\$87.50
	3"	7130FWC	\$102.50
	4"	7140FWC	\$118.50
	5"	7150FWC	\$144.50
	6"	7160FWC	\$164.50
	8"	7180FWC	\$208.00
	10"	7110FWC	\$288.00
	12"	7112FWC	\$421.00

Orders for items in shaded areas **cannot** be cancelled or returned.

**#71 Flange Adapter – Gaskets or Nut, Bolt, & Gasket Kit**

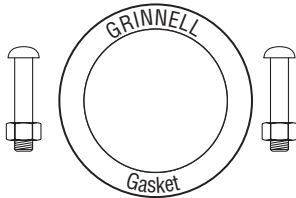
	Nom. Size	Gaskets		Nut, Bolt and Gasket Kit	
		Part Number	List Price	Part Number	List Price
	2"	7120EPDME	\$26.00	50240	POA
	2½"	7125EPDME	\$30.50	50241	POA
	3"	7130EPDME	\$33.00	50242	POA
	4"	7140EPDME	\$43.00	50243	POA
	5"	7150EPDME	\$51.50	50248	POA
	6"	7160EPDME	\$58.50	50244	POA
	8"	7180EPDME	\$78.00	50245	POA
	10"	7110EPDME	\$99.00	50246	POA
	12"	7112EPDME	\$115.50	50247	POA

Orders for items in shaded areas **cannot** be cancelled or returned.

**#702 Global – Outlet Coupling Grade “E” Gasket, Female Threaded End, Painted\***

Nominal Size	Coupling		Gasket Only	
	Global Part Number	List Price	Part Number	List Price
1½" x ½"	7021505FES	\$105.50	7021505EPDME	\$50.50
1½" x ¾"	7021575FES	\$105.50	7021575EPDME	\$50.50
1½" x 1"	7021501FES	\$105.50	7021501EPDME	\$50.50
2" x ½"	7022005FES	\$108.00	7022005EPDME	\$51.00
2" x ¾"	7022075FES	\$108.00	7022075EPDME	\$51.00
2" x 1"	7022001FES	\$108.00	7022001EPDME	\$51.00
2½" x ½"	7022505FES	\$166.00	7022505EPDME	\$104.50
2½" x ¾"	7022575FES	\$166.00	7022575EPDME	\$104.50
2½" x 1"	7022501FES	\$166.00	7022501EPDME	\$104.50
3" x ¾"	7023075FES	\$160.00	7023075EPDME	\$85.00
3" x 1"	7023001FES	\$211.50	7023001EPDME	\$120.50
4" x ¾"	7024075FES	\$234.50	7024075EPDME	\$120.50
4" x 1"	7024001FES	\$234.50	7024001EPDME	\$120.50
4" x 1½"	7024015FES	\$333.00	7024015EPDME	\$188.00
6" x 1"	7026001FES	\$470.00	7026001EPDME	\$245.50
6" x 1½"	7026015FES	\$470.00	7026015EPDME	\$245.50

Orders for items in shaded areas **cannot** be cancelled or returned.  
\* Galvanized available upon request.

**#702 Global – Outlet Coupling Grade “E” Gasket, Male Threaded End, Painted\***

Nominal Size	Coupling		Gasket Only	
	Global Part Number	List Price	Part Number	List Price
2" x 1"	7022001MES	\$108.00	7022001EPDME	\$51.00
2½" x 1¼"	7022513MES	\$187.00	7022513EPDME	\$117.50
2½" x 1½"	7022515MES	\$211.50	7022515EPDME	\$117.00
3" x 1"	7023001MES	\$211.50	7023001EPDME	\$120.50
3" x 1½"	7023015MES	\$242.50	7023015EPDME	\$120.50
4" x 1½"	7024015MES	\$333.00	7024015EPDME	\$188.00
4" x 2"	7024020MES	\$333.00	7024020EPDME	\$188.00
6" x 1½"	7026015MES	\$470.00	7026015EPDME	\$245.50
6" x 2"	7026020MES	\$470.00	7026020EPDME	\$245.50

Orders for items in shaded areas **cannot** be cancelled or returned.  
\* Galvanized available upon request.

**#702 Global – Outlet Coupling Grade “E” Gasket, Grooved End, Painted\***

Nominal Size	Coupling		Gasket Only	
	Global Part Number	List Price	Part Number	List Price
2" x 1"	7022001GRVES	\$108.00	7022001EPDME	\$51.00
2½" x 1¼"	7022513GRVES	\$187.00	7022513EPDME	\$117.50
2½" x 1½"	7022515GRVES	\$211.50	7022515EPDME	\$117.00
3" x 1"	7023001GRVES	\$211.50	7023001EPDME	\$120.50
3" x 1½"	7023015GRVES	\$242.50	7023015EPDME	\$120.50
4" x 1½"	7024015GRVES	\$333.00	7024015EPDME	\$188.00
4" x 2"	7024020GRVES	\$333.00	7024020EPDME	\$188.00
6" x 1½"	7026015GRVES	\$470.00	7026015EPDME	\$245.50
6" x 2"	7026020GRVES	\$470.00	7026020EPDME	\$245.50

Orders for items in shaded areas **cannot** be cancelled or returned.  
\* Galvanized available upon request.

See latest catalog or technical data sheets for specific approvals, listings, and design parameters.  
POA = Price on availability. Prices subject to change without notice.

**Replacement Gaskets**

Nominal Size	Grade "A" Pre-Lube Fire Protection Gasket (for #577, #705, )		Tri-Seal Grade "E" EPDM Gasket (for #577, #705)		Grade "E" EPDM Gasket (for #71)	
1"	01EPDMAC	\$28.50	01EPDME3	\$54.00	—	—
1 1/4"	13EPDMAC	\$37.50	13EPDME3	\$57.00	—	—
1 1/2"	15EPDMAC	\$40.50	15EPDME3	\$58.00	—	—
2"	20EPDMAC	\$43.50	20EPDME3	\$59.00	7120EPDME	\$26.00
2 1/2"	25EPDMAC	\$47.00	25EPDME3	\$72.50	7125EPDME	\$30.50
3"	30EPDMAC	\$54.00	30EPDME3	\$72.50	7130EPDME	\$33.00
4"	40EPDMAC	\$72.00	40EPDME3	\$97.00	7140EPDME	\$43.00
5"	50EPDMAC	\$72.50	50EPDME3	\$171.00	7150EPDME	\$51.50
6"	60EPDMAC	\$80.00	60EPDME3	\$175.00	7160EPDME	\$58.50
8"	80EPDMAC	\$114.50	80EPDME3	\$181.50	7180EPDME	\$78.00
10"	10EPDMAC	\$121.50	10EPDME3	\$233.50	7110EPDME	\$99.00
12"	12EPDMAC	\$141.50	12EPDME3	\$278.00	7112EPDME	\$115.50

Orders for items in shaded areas **cannot** be cancelled or returned.

Technical Data Sheet: TFP1895

**Coupling Nut and Bolt Kit**

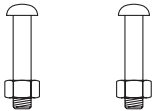
	Nominal Size	Qty/Kit	Part No.	List Price
	3/8" x 2 1/4"	2	NB37225	\$14.50
	1/2" x 3"	2	NB50300	\$15.00
	5/8" x 3 1/4"	2	NB62325	\$18.00
	5/8" x 4 3/4"	2	NB62475	\$30.00
	3/4" x 4 3/4"	2	NB75475	\$28.00
	7/8" x 6 1/2"	2	NB87650	\$46.50
	1" x 5 1/2"	3	NB10550	\$46.50
	1" x 6 1/2"	2	NB10650	\$49.50
	1 1/8" x 5 3/4"	4	NB12575	\$63.50

Orders for items in shaded areas **cannot** be cancelled or returned.

All standard couplings can be provided with stainless steel nuts and bolts upon request.

**GRINNELL Gasket Lubricant**

Size	Part Number	List Price
1 Quart	32005	\$34.00
<b>GRINNELL Silicone Gasket Lubricant</b>		
Recommended for use with Tri-Seal Gaskets. Dow Corning #DC No. 7. *		
Size	Part Number	List Price
5.30 oz. Tube	32037	\$112.00
8 lb. Can	32038	\$2,036.00

Orders for items in shaded areas **cannot** be cancelled or returned.

Silicone gasket lubricant is for use with Dry Pipe & Freezing Applications.

**Pipe Tape Chrome Plated with GRINNELL Logo**

Size	Part Number	List Price
1 Roll	PT1000	\$58.50

\* Dow Corning is a trademark of Dow Corning Corporation.

See latest catalog or technical data sheets for specific approvals, listings, and design parameters.

POA = Price on availability. Prices subject to change without notice.

**G-FIRE #510S Global and Domestic – Fire Protection Short Pattern Grooved 90° Elbow**

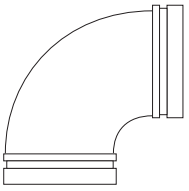
	Nom. Size	Painted			Galvanized		
		Global Part Number	Domestic Part Number	List Price	Global Part Number	Domestic Part Number	List Price
		2"	510S20P	510S20S	\$35.50	510S20GP	510S20GS
2 1/2"	510S25P	510S25S	\$47.00	510S25GP	510S25GS	\$64.00	
3"	510S30P	510S30S	\$62.00	510S30GP	510S30GS	\$82.50	
4"	510S40P	510S40S	\$89.00	510S40GP	510S40GS	\$123.50	
6"	510S60P	510S60S	\$247.00	510S60GP	510S60GS	\$340.00	
8"	510S80P	510S80S	\$482.50	510S80GP	510S80GS	\$688.00	

All elbows are cast fittings.

**Technical Data Sheet: TFP1810**

**G-FIRE #519S Global and Domestic – Fire Protection Short Pattern Grooved Tee**

	Nom. Size	Painted			Galvanized		
		Global Part Number	Domestic Part Number	List Price	Global Part Number	Domestic Part Number	List Price
		2"	519S20P	519S20S	\$54.00	519S20GP	519S20GS
2 1/2"	519S25P	519S25S	\$71.00	519S25GP	519S25GS	\$91.00	
3"	519S30P	519S30S	\$99.00	519S30GP	519S30GS	\$127.00	
4"	519S40P	519S40S	\$149.50	519S40GP	519S40GS	\$195.00	
6"	519S60P	519S60S	\$399.00	519S60GP	519S60GS	\$520.50	
8"	519S80P	519S80S	\$848.00	519S80GP	519S80GS	\$1,120.00	

All tees are cast fittings.

**Technical Data Sheet: TFP1810**

**G-FIRE #501 Global and Domestic – Fire Protection Standard Pattern Grooved 45° Elbow**

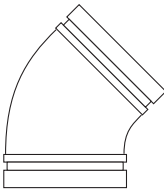
	Nom. Size	Painted			Galvanized		
		Global Part Number	Domestic Part Number	List Price	Global Part Number	Domestic Part Number	List Price
		1 1/4"	50113P	50113S	\$71.00	50113GP	50113GS
1 1/2"	50115P	50115S	\$71.00	50115GP	50115GS	\$89.50	
2"	50120P	50120S	\$35.50	50120GP	50120GS	\$45.50	
2 1/2"	50125P	50125S	\$47.00	50125GP	50125GS	\$59.00	
3"	50130P	50130S	\$62.00	50130GP	50130GS	\$78.50	
4"	50140P	50140S	\$89.00	50140GP	50140GS	\$118.50	
5"	–	20150S	\$325.50	–	20150GS	\$403.00	
6"	50160P	50160S	\$247.00	50160GP	50160GS	\$311.50	
8"	50180P	50180S	\$482.50	50180GP	50180GS	\$664.00	
10"	50110P	20110S	\$1,392.50	50110GP	20110GS	\$1,519.00	
12"	50112P	20112S	\$2,229.00	50112GP	20112GS	\$2,597.50	

All elbows are cast fittings.

Orders for items in shaded areas **cannot** be cancelled or returned.

**Technical Data Sheet: TFP1810**

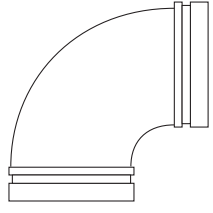

**G-FIRE #510 Global and Domestic – Fire Protection Standard Pattern Grooved 90° Elbow**

	Nom. Size	Painted			Galvanized		
		Global Part Number	Domestic Part Number	List Price	Global Part Number	Domestic Part Number	List Price
		1 1/4"	51013P	51013S	\$71.00	51013GP	51013GS
1 1/2"	51015P	51015S	\$71.00	51015GP	51015GS	\$94.00	
2"	51020P	51020S	\$71.00	51020GP	51020GS	\$94.00	
2 1/2"	51025P	51025S	\$71.00	51025GP	51025GS	\$94.00	
3"	51030P	51030S	\$125.50	51030GP	51030GS	\$156.50	
4"	51040P	51040S	\$136.50	51040GP	51040GS	\$191.00	
5"	–	21050S	\$325.50	–	21050GS	\$420.50	
6"	51060P	51060S	\$382.00	51060GP	51060GS	\$506.00	
8"	51080P	51080S	\$795.50	51080GP	51080GS	\$1,048.50	
10"	51010P	21010S	\$1,392.50	51010GP	21010GS	\$1,803.00	
12"	51012P	21012S	\$2,229.00	51012GP	21012GS	\$2,876.00	

All elbows are cast fittings.

Technical Data Sheet: TFP1810

**G-FIRE #510DE Domestic – 90° Elbow with 1" Outlet**

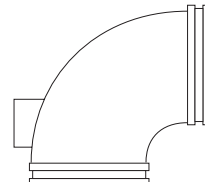
	Nom. Size	Painted		Galvanized	
		Domestic Part Number	List Price	Domestic Part Number	List Price
		2"	51020DS	\$166.00	51020DGS
2 1/2" *	51025DS	\$166.00	51025DGS	\$213.50	
3" *	51030DS	\$212.00	51030DGS	\$253.50	
4" *	51040DS	\$215.50	51040DGS	\$292.50	
6" *	51060DS	\$378.00	51060DGS	\$538.00	
8" *	51080DS	\$639.00	51080DGS	\$908.50	

Elbow is segmentally welded except where a \* indicates it is available as a cast fitting.

Orders for items in shaded areas **cannot** be cancelled or returned.

Technical Data Sheet: TFP1810

**G-FIRE #519 Global and Domestic – Fire Protection Standard Pattern Grooved Tee**

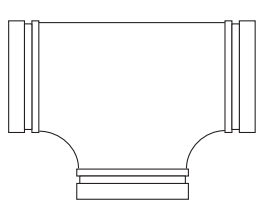
	Nom. Size	Painted			Galvanized		
		Global Part Number	Domestic Part Number	List Price	Global Part Number	Domestic Part Number	List Price
		1 1/4"	51913P	51913S	\$110.00	51913GP	51913GS
1 1/2"	51915P	51915S	\$110.00	51915GP	51915GS	\$144.00	
2"	51920P	51920S	\$110.00	51920GP	51920GS	\$144.00	
2 1/2"	51925P	51925S	\$110.00	51925GP	51925GS	\$144.00	
3"	51930P	51930S	\$151.00	51930GP	51930GS	\$206.50	
4"	51940P	51940S	\$229.50	51940GP	51940GS	\$312.00	
5"	–	21950S	\$536.00	–	21950GS	\$680.00	
6"	51960P	51960S	\$618.50	51960GP	51960GS	\$844.50	
8"	51980P	51980S	\$1,355.50	51980GP	51980GS	\$1,779.00	
10"	51910P	21910S	\$2,710.00	51910GP	21910GS	\$3,508.50	
12"	51912P	21912S	\$3,777.00	51912GP	21912GS	\$4,824.50	

All tees are cast fittings.

Orders for items in shaded areas **cannot** be cancelled or returned.

Technical Data Sheet: TFP1810

Section 16  
Specialty Items

Section 18  
Grooved Products

Section 19  
CPVC Pipe & Fittings

Section 20  
Miscellaneous

Section 21  
Electrical

Section C  
Valves & Hose Equipment

Section D  
Backflow

Section F  
Pipe & Accessories

Section H  
Hangers

Section J  
Lubricants

Section K  
Misc.

**#260 Domestic and Global – Grooved Cap**

Nom. Size	Painted			Galvanized		
	Global Part Number	Domestic Part Number	List Price	Global Part Number	Domestic Part Number	List Price
1"	–	26001S	\$60.00	–	26001GS	\$72.00
1 1/4"	26013P	26013S	\$18.50	26013GP	26013GS	\$29.00
1 1/2"	26015P	26015S	\$19.50	26015GP	26015GS	\$29.00
2"	26020P	26020S	\$23.50	26020GP	26020GS	\$32.50
2 1/2"	26025P	26025S	\$27.50	26025GP	26025GS	\$35.50
3"	26030P	26030S	\$33.00	26030GP	26030GS	\$43.00
4"	26040P	26040S	\$48.50	26040GP	26040GS	\$66.50
5"	26050P	26050S	\$151.00	26050GP	26050GS	\$202.00
6"	26060P	26060S	\$110.00	26060GP	26060GS	\$152.50
8"	26080P	26080S	\$209.50	26080GP	26080GS	\$287.00
10"	26010P	26010S	\$582.50	26010GP	26010GS	\$759.00
12"	26012P	26012S	\$953.00	26012GP	26012GS	\$1,213.00

All caps are cast fittings.

Orders for items in shaded areas **cannot** be cancelled or returned.

**Technical Data Sheet: TFP1810**

**#260 Domestic and Global – Grooved Cap with 1/2" Tap**

Nom. Size	Painted		
	Global Part Number	Domestic Part Number	List Price
2"	26020TP	26020TS	\$310.50
2 1/2"	26025TP	26025TS	\$314.00
3"	26030TP	26030TS	\$314.00
4"	26040TP	26040TS	\$319.50
5"	–	26050TS	POA
6"	26060TP	26060TS	\$439.50
8"	26080TP	26080TS	\$648.00

All caps are cast fittings.

**Technical Data Sheet: TFP1810**

**#260 Domestic and Global – Grooved Cap with 1" Tap**

Nom. Size	Painted		
	Global Part Number	Domestic Part Number	List Price
2"	26020T1P	26020T1S	\$310.50
2 1/2"	26025T1P	26025T1S	\$314.00
3"	26030T1P	26030T1S	\$414.50
4"	26040T1P	26040T1S	\$399.50
5"	–	26050T1S	POA
6"	26060T1P	26060T1S	\$439.50
8"	26080T1P	26080T1S	\$525.50

All caps are cast fittings.

**Technical Data Sheet: TFP1810**

See latest catalog or technical data sheets for specific approvals, listings, and design parameters.  
POA = Price on availability. Prices subject to change without notice.

**#40-5 Domestic – Strap**

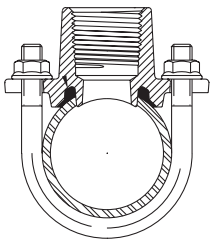
	Nom. Size	Domestic Part Number with "E" Gasket	List Price
	1 1/4" x 1/2"	STP1305ES	\$19.00
	1 1/4" x 3/4"	STP13075ES	\$19.00
	1 1/4" x 1"	STP1310ES	\$20.50
	1 1/2" x 1/2"	STP1505ES	\$20.50
	1 1/2" x 3/4"	STP15075ES	\$20.50
	1 1/2" x 1"	STP1510ES	\$20.50
	2" x 1/2"	STP2005ES	\$21.50
	2" x 3/4"	STP20075ES	\$21.50
	2" x 1"	STP2010ES	\$21.50
2 1/2" x 1/2"	STP2505ES	\$24.25	
2 1/2" x 3/4"	STP25075ES	\$24.25	
2 1/2" x 1"	STP2510ES	\$24.50	

**ADACAP #750 Domestic**

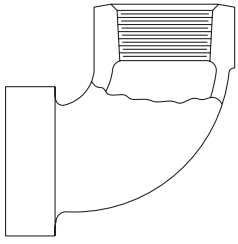
	Nom. Size	Domestic Part Number	List Price
	1 1/2" x 1/2"	7501505S	\$66.00
	1 1/2" x 3/4"	75015075S	\$66.00
	1 1/2" x 1"	7501510S	\$66.00
	2" x 1/2"	7502005S	\$71.00
	2" x 3/4"	75020075S	\$71.00
	2" x 1"	7502010S	\$71.00
	2 1/2" x 1/2"	7502505S	\$84.50
	2 1/2" x 3/4"	75025075S	\$84.50
	2 1/2" x 1"	7502510S	\$84.50

Technical Data Sheet: TFP1810

Section 16  
Specialty Items

Section 18  
Grooved Products

Section 19  
CPVC Pipe & Fittings

Section 20  
Miscellaneous

Section 21  
Electrical

Section C  
Valves & Hose Equipment

Section D  
Backflow

Section F  
Pipe & Accessories

Section H  
Hangers

Section J  
Lubricants

Section K  
Misc.

Section 16  
Specialty Items

Section 18  
Grooved Product

Section 19  
CPVC Pipe & Fittings

Section 20  
Miscellaneous

Section 21  
Electrical

Section C  
Valves & Hose Equipment

Section D  
Backflow

Section F  
Pipe & Accessories

Section H  
Hangers

Section J  
Lubricants

Section K  
Misc.

**#512 Domestic – Grooved 22<sup>1</sup>/<sub>2</sub>° Elbow**

Nom. Size	Painted		Galvanized	
	Domestic Part Number	List Price	Domestic Part Number	List Price
1 <sup>1</sup> / <sub>4</sub> "	51213S	\$77.50	51213GS	\$98.00
1 <sup>1</sup> / <sub>2</sub> "	51215S	\$77.50	51215GS	\$98.00
2"	51220S	\$77.50	51220GS	\$98.00
2 <sup>1</sup> / <sub>2</sub> "	51225S	\$77.50	51225GS	\$98.00
3"	51230S	\$111.00	51230GS	\$139.50
4"	51240S	\$147.00	51240GS	\$191.00
5"	51250S	\$451.00	51250GS	\$544.00
6"	51260S	\$412.50	51260GS	\$525.50
8"	51280S	\$860.00	51280GS	\$1,068.00
10" *	75559	\$1,134.50	75579	\$1,473.00
12" *	75560	\$1,533.00	75580	\$1,901.00

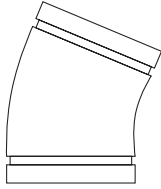

Elbow is Cast except where a \* indicates it is segmentally welded.  
Orders for items in shaded areas **cannot** be cancelled or returned.

**Technical Data Sheet: TFP1810**

**#511 Domestic – Grooved 11<sup>1</sup>/<sub>4</sub>° Elbow**

Nom. Size	Painted		Galvanized	
	Domestic Part Number	List Price	Domestic Part Number	List Price
1 <sup>1</sup> / <sub>4</sub> "	51113S	\$77.50	51113GS	\$98.00
1 <sup>1</sup> / <sub>2</sub> "	51115S	\$77.50	51115GS	\$98.00
2"	51120S	\$178.50	51120GS	\$208.50
2 <sup>1</sup> / <sub>2</sub> "	51125S	\$178.50	51125GS	\$208.50
3"	51130S	\$111.00	51130GS	\$138.50
4"	51140S	\$136.50	51140GS	\$181.00
5"	51150S	\$451.00	51150GS	\$530.50
6"	51160S	\$412.50	51160GS	\$498.50
8"	51180S	\$734.50	51180GS	\$873.00
10" *	75309	\$1,059.00	75315	\$1,264.00
12" *	75310	\$1,533.00	75323	\$1,856.50

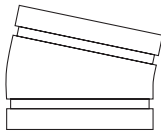

Elbow is Cast except where a \* indicates it is segmentally welded.  
Orders for items in shaded areas **cannot** be cancelled or returned.

**Technical Data Sheet: TFP1810**

See latest catalog or technical data sheets for specific approvals, listings, and design parameters.  
POA = Price on availability. Prices subject to change without notice.

#321 Domestic – Grooved Reducing Tee

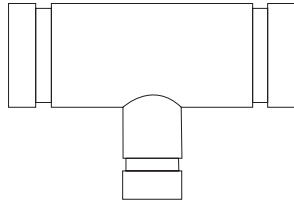

Nom. Size	Painted		Galvanized	
	Domestic Part Number	List Price	Domestic Part Number	List Price
2" x 1"	75410	\$232.50	75470	\$272.50
2" x 1 1/2"	75411	\$232.50	75471	\$276.50
2 1/2" x 1"	75412	\$232.50	3212510GS	\$272.50
2 1/2" x 1 1/4"	75413	\$350.00	73590	\$412.50
2 1/2" x 1 1/2"	75414	\$232.50	73591	\$276.50
2 1/2" x 2"	75415	\$232.50	75472	\$276.50
3" x 1"	75416	\$205.00	-	\$262.00
3" x 1 1/2"	75417	\$205.00	73592	\$264.50
3" x 2"	75418	\$205.00	75473	\$264.50
3" x 2 1/2"	75419	\$205.00	75474	\$264.50
4" x 1"	75420	\$276.50	3214010GS	\$345.50
4" x 1 1/2"	75421	\$276.50	73594	\$345.50
4" x 2"	75422	\$276.50	75475	\$363.00
4" x 2 1/2"	75423	\$276.50	75476	\$363.00
4" x 3"	75424	\$276.50	75477	\$363.00
5" x 2"	75425	\$670.50	73595	\$828.00
5" x 2 1/2"	75426	\$546.00	73596	\$687.50
5" x 3"	75427	\$546.00	75489	\$687.50
5" x 4"	75428	\$591.00	73597	\$746.50
6" x 2"	75429	\$650.50	75478	\$854.50
6" x 2 1/2"	75430	\$650.50	75479	\$854.50
6" x 3"	75431	\$650.50	75480	\$854.50
6" x 4"	75432	\$650.50	75481	\$854.50
6" x 5"	75433	\$650.50	3216050GS	\$860.00
8" x 3"	75435	\$1,010.00	75482	\$1,207.50
8" x 4"	75436	\$1,355.50	75483	\$1,751.50
8" x 5"	75437	\$1,355.50	75484	\$1,763.50
8" x 6"	75438	\$1,355.50	75485	\$1,771.00
10" x 3"	75439	\$1,572.50	73621	\$2,502.00
10" x 4"	75440	\$1,644.00	73622	\$2,101.00
10" x 5"	75441	\$1,680.50	73623	\$2,145.00
10" x 6"	75442	\$1,680.50	73624	\$2,728.00
10" x 8"	75443	\$1,711.00	73625	\$2,741.50
12" x 6"	75444	\$2,427.00	73629	\$3,560.00
12" x 8"	75445	\$2,494.00	73630	\$3,772.00
12" x 10"	75446	\$2,610.50	73631	\$4,059.50

Tee is segmentally welded except where a \* indicates it is available as a cast fitting.

Orders for items in shaded areas **cannot** be cancelled or returned.

Technical Data Sheet: TFP1810

Section 16  
Specialty Items

Section 18  
Grooved Products

Section 19  
CPVC Pipe & Fittings

Section 20  
Miscellaneous

Section 21  
Electrical

Section C  
Valves & Hose Equipment

Section D  
Backflow

Section F  
Pipe & Accessories

Section H  
Hangers

Section J  
Lubricants

Section K  
Misc.

Section 16  
Specialty Items

Section 18  
Grooved Product

Section 19  
CPVC Pipe & Fittings

Section 20  
Miscellaneous

Section 21  
Electrical

Section C  
Valves & Hose Equipment

Section D  
Backflow

Section F  
Pipe & Accessories

Section H  
Hangers

Section J  
Lubricants

Section K  
Misc.

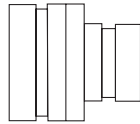

<b>#550 and #350 Domestic – Concentric Reducer</b>					
Nom. Size	Painted		Galvanized		
	Domestic Part Number	List Price	Domestic Part Number	List Price	
1 1/2" x 1"	74328	\$83.00	73400	\$97.50	
1 1/2" x 1 1/4"	5501513S *	\$83.00	5501513GS *	\$97.50	
2" x 1/2"	72850	POA	73392	POA	
2" x 3/4"	72851	\$83.00	73401	\$97.50	
2" x 1"	72852	\$83.00	73402	\$97.50	
2" x 1 1/4"	72853	\$90.50	73403	\$106.50	
2" x 1 1/2"	72854	\$83.00	73404	\$97.50	
2 1/2" x 1"	72855	\$112.50	73393	\$130.00	
2 1/2" x 1 1/4"	5502513S *	\$83.00	5502513GS *	\$97.50	
2 1/2" x 1 1/2"	5502515S *	\$83.00	5502515GS *	\$97.50	
2 1/2" x 2"	5502520S *	\$83.00	5502520GS *	\$97.50	
3" x 1"	72860	\$90.50	73406	\$110.50	
3" x 1 1/4"	72861	\$145.50	73396	\$167.50	
3" x 1 1/2"	5503015S *	\$100.00	5503015GS *	\$121.50	
3" x 2"	5503020S *	\$73.00	5503020GS *	\$89.50	
3" x 2 1/2"	5503025S *	\$100.00	5503025GS *	\$120.50	
4" x 1"	72867	\$110.00	73409	\$135.00	
4" x 1 1/4"	72868	\$843.00	73756	\$944.50	
4" x 1 1/2"	72869	\$152.00	73410	\$200.50	
4" x 2"	5504020S *	\$97.50	5504020GS *	\$119.50	
4" x 2 1/2"	5504025S *	\$120.50	5504025GS *	\$146.50	
4" x 3"	5504030S *	\$120.50	5504030GS *	\$146.50	
4" x 3 1/2"	72875	\$120.50	73398	\$146.50	
5" x 2"	72876	\$1,186.00	73399	\$1,309.50	
5" x 2 1/2"	72877	\$245.50	73758	\$299.50	
5" x 3"	5505030S *	\$139.50	5505030GS *	\$173.00	
5" x 4"	5505040S *	\$166.50	5505040GS *	\$208.50	
6" x 2"	5506020S *	\$220.50	5506020GS *	\$275.00	
6" x 2 1/2"	5506025S *	\$245.50	5506025GS *	\$301.50	
6" x 3"	5506030S *	\$220.50	5506030GS *	\$275.00	
6" x 4"	5506040S *	\$193.00	5506040GS *	\$249.50	
6" x 5"	5506050S *	\$284.50	5506050GS *	\$353.50	
8" x 3"	5508030S *	\$393.00	5508030GS *	\$489.50	
8" x 4"	5508040S *	\$393.00	5508040GS *	\$492.00	
8" x 5"	5508050S *	\$393.00	5508050GS *	\$495.50	
8" x 6"	5508060S *	\$499.00	5508060GS *	\$625.00	
10" x 4"	72889	\$895.50	73764	\$1,102.50	
10" x 6"	5501060S *	\$979.50	73425	\$1,221.00	
10" x 8"	72891	\$979.50	73422	\$1,242.00	
12" x 4"	5501240S *	\$4,288.50	73766	\$5,104.00	
12" x 6"	5501260S *	\$1,168.00	73767	\$1,444.00	
12" x 8"	5501280S *	\$1,752.50	73423	\$2,069.50	
12" x 10"	5501210S *	\$1,752.50	73424	\$2,169.50	

Reducer is segmentally welded except where a \* indicates it is available as a cast fitting.

Orders for items in shaded areas **cannot** be cancelled or returned.

**Technical Data Sheet: TFP1810**

**#341 Domestic – Grooved x Flanged Adapter 150 Lbs. – Schedule 40**

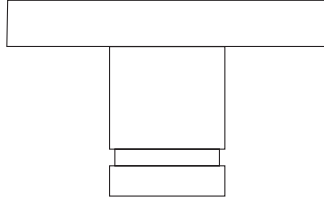
	Nom. Size	Painted		Galvanized	
		Domestic Part Number	List Price	Domestic Part Number	List Price
		2"	<b>73230</b>	\$300.00	<b>73250</b>
2 1/2"	<b>73231</b>	\$599.00	<b>73251</b>	\$705.50	
3"	<b>73232</b>	\$613.00	<b>73252</b>	\$728.50	
4"	<b>73233</b>	\$699.00	<b>73253</b>	\$1,018.50	
5"	<b>73234</b>	\$967.50	<b>73254</b>	\$1,340.00	
6"	<b>73235</b>	\$984.50	<b>73255</b>	\$1,358.50	
8"	<b>73236</b>	\$1,218.50	<b>73256</b>	\$1,814.50	
10"	<b>73237</b>	\$1,841.00	<b>74265</b>	\$2,760.00	
12"	<b>73238</b>	\$2,520.50	<b>74254</b>	\$3,639.00	

All adapters are segmentally welded.

Orders for items in shaded areas **cannot** be cancelled or returned.

**Technical Data Sheet: TFP1810**

**#342 Domestic – Grooved x Flanged Adapter 300 Lbs. – Schedule 40**

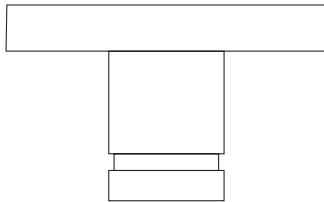
	Nom. Size	Painted		Galvanized	
		Domestic Part Number	List Price	Domestic Part Number	List Price
		4"	<b>73260</b>	\$962.00	<b>73263</b>
5"	<b>73261</b>	\$984.50	<b>73264</b>	POA	
6"	<b>73262</b>	\$984.50	<b>74283</b>	\$1,487.00	

All adapters are segmentally welded.

Orders for items in shaded areas **cannot** be cancelled or returned.

**#320 Domestic – Grooved x Male Thread Tee, Painted**

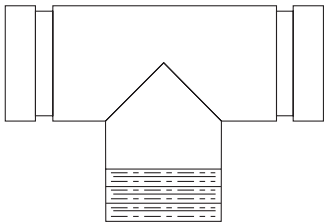
	Nom. Size	Painted		Galvanized	
		Domestic Part Number	List Price	Domestic Part Number	List Price
		1 1/2"	<b>75490</b>	\$359.50	<b>73553</b>
2"	<b>75491</b>	\$230.50	<b>73554</b>	\$271.00	
2 1/2"	<b>75492</b>	POA	<b>73555</b>	POA	
3"	<b>75493</b>	POA	<b>32030GS</b>	POA	
4"	<b>75465</b>	\$477.00	<b>73557</b>	\$656.00	
6"	<b>75466</b>	\$1,224.50	<b>73559</b>	\$1,441.00	

Adapter is segmentally welded.

Orders for items in shaded areas **cannot** be cancelled or returned.

**Standpipe Domestic – Tee**

Nom. Size	Painted		Galvanized	
	Domestic Part Number	List Price	Domestic Part Number	List Price
4" x 4" x 2 1/2"	76768	POA	76755	POA
6" x 6" x 2 1/2"	76769	POA	76771	POA

Orders for items in shaded areas **cannot** be cancelled or returned.

**#507/#50L Domestic – Bullhead Tee**

Nom. Size	Painted		Galvanized	
	Domestic Part Number	List Price	Domestic Part Number	List Price
5" x 5" x 8"	76772	POA	76774	POA
6" x 6" x 8"	76773	POA	76775	POA

Orders for items in shaded areas **cannot** be cancelled or returned.

**#323 Domestic – Reducing Tee with Threaded Branch**

Nom. Size	Painted		Galvanized	
	Domestic Part Number	List Price	Domestic Part Number	List Price
2" x 1"	75500	\$245.50	75520	\$288.00
2" x 1 1/2"	75501	\$245.50	75522	\$291.50
2 1/2" x 1 1/4"	75502	\$536.50	73608	\$551.50
2 1/2" x 1 1/2"	75503	\$245.50	73609	\$291.50
2 1/2" x 2"	75504	\$245.50	73610	\$294.00
3" x 1"	75505	\$245.50	75521	\$307.00
3" x 1 1/2"	75506	\$245.50	75546	\$309.00
3" x 2"	75507	\$245.50	75523	\$309.00
3" x 2 1/2"	75508	\$591.50	73611	\$640.50
4" x 1"	75509	\$307.00	75524	\$378.00
4" x 2"	75510	\$307.00	75525	\$384.50
4" x 2 1/2"	75511	\$307.00	73691	\$395.50
4" x 3"	75512	\$307.00	75526	\$397.00
5" x 2"	75513	\$656.50	75534	\$715.50
6" x 2"	75514	\$766.00	75527	\$954.50
6" x 2 1/2"	75590	\$766.00	75528	\$954.50
6" x 3"	75515	\$766.00	75529	\$954.50
6" x 4"	75516	\$968.50	73694	\$1,041.50
6" x 5"	75517	\$766.00	73695	\$954.50
8" x 2"	75518	\$937.50	73696	\$1,293.50
8" x 3"	75519	\$1,293.50	73697	\$1,677.50

All tees are segmentally welded.

Orders for items in shaded areas **cannot** be cancelled or returned.

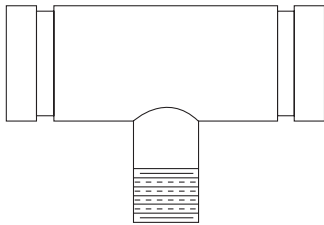

See latest catalog or technical data sheets for specific approvals, listings, and design parameters.  
POA = Price on availability. Prices subject to change without notice.

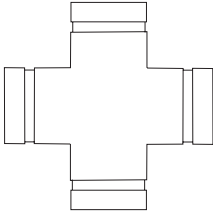

**#327 Domestic – Grooved Cross**

	Nom. Size	Painted		Galvanized	
		Domestic Part Number	List Price	Domestic Part Number	List Price
	2"	<b>75840</b>	\$196.50	<b>75849</b>	\$234.00
	2 1/2"	<b>75841</b>	\$196.50	<b>75850</b>	\$234.00
	3"	<b>75842</b>	\$349.50	<b>75851</b>	\$428.00
	4"	<b>75843</b>	\$580.00	<b>75852</b>	\$713.50
	6"	<b>75845</b>	\$1,517.50	<b>75853</b>	\$1,842.00
	8"	<b>75846</b>	\$1,999.50	<b>76757</b>	\$2,473.00
	10"	<b>75847</b>	\$3,280.00	<b>76758</b>	\$4,057.00
	12"	<b>75848</b>	\$4,733.00	<b>76759</b>	\$5,896.50

Orders for items in shaded areas **cannot** be cancelled or returned.

Technical Data Sheet: TFP1810

**#372 Domestic – Reducer Small End Threaded (Male)**

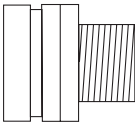
	Nom. Size	Painted		Galvanized	
		Domestic Part Number	List Price	Domestic Part Number	List Price
	1 1/2" x 1"	<b>76800</b>	\$86.50	<b>76825</b>	\$106.00
	2" x 3/4"	<b>76801</b>	\$86.50	<b>76826</b>	\$106.00
	2" x 1"	<b>76802</b>	\$86.50	<b>76827</b>	\$106.00
	2" x 1 1/4"	<b>76815</b>	\$86.50	<b>73794</b>	\$106.00
	2" x 1 1/2"	<b>76803</b>	\$86.50	<b>76828</b>	\$106.00
	2 1/2" x 1 1/4"	<b>76816</b>	\$122.50	<b>73795</b>	\$151.00
	2 1/2" x 1 1/2"	<b>76817</b>	\$128.00	<b>73796</b>	\$151.00
	2 1/2" x 2"	<b>76804</b>	\$86.50	<b>76829</b>	\$106.00
	3" x 1"	<b>76805</b>	\$94.00	<b>76830</b>	\$113.00
	3" x 1 1/4"	<b>76818</b>	\$296.50	<b>3723013GS</b>	\$329.50
	3" x 1 1/2"	<b>76819</b>	\$106.00	<b>73797</b>	\$127.00
	3" x 2"	<b>76806</b>	\$106.00	<b>76831</b>	\$127.00
	3" x 2 1/2"	<b>76807</b>	\$128.00	<b>76832</b>	\$151.00
	4" x 1"	<b>76808</b>	\$121.00	<b>76833</b>	\$146.50
	4" x 1 1/4"	<b>76820</b>	POA	<b>3724013GS</b>	POA
	4" x 1 1/2"	<b>76821</b>	\$283.50	<b>73799</b>	\$371.00
	4" x 2"	<b>76809</b>	\$129.00	<b>76834</b>	\$154.50
	4" x 2 1/2"	<b>76810</b>	\$129.50	<b>76835</b>	\$159.00
	4" x 3"	<b>76811</b>	\$158.50	<b>76836</b>	\$187.50
	6" x 1"	<b>76812</b>	\$245.50	<b>76837</b>	\$301.50
6" x 2"	<b>76813</b>	\$245.50	<b>76838</b>	\$301.50	
6" x 3"	<b>76814</b>	\$245.50	<b>76839</b>	\$301.50	

All reducers are segmentally welded.

Orders for items in shaded areas **cannot** be cancelled or returned.

**#391 Domestic – Groove x Male Thread Adapter Nipple**

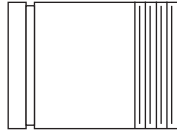

Nom. Size	Painted		Galvanized	
	Domestic Part Number	List Price	Domestic Part Number	List Price
1 1/4" x 4"	75121	\$43.00	74292	POA
1 1/2" x 4"	75122	\$43.00	74293	POA
2" x 4"	75123	\$43.00	74294	\$85.00
2 1/2" x 4"	75124	\$49.50	74295	\$145.50
3" x 4"	75125	\$60.00	74296	\$121.00
3" x 6"	74335	\$97.50	3913060GS	\$171.00
4" x 6"	75126	\$98.50	74297	\$239.00
5" x 6"	75129	\$203.50	74298	POA
6" x 6"	75130	\$261.00	74299	\$465.50
8" x 6"	75131	\$292.50	74336	POA
10" x 8"	75132	\$409.50	74337	POA
12" x 8"	75133	\$513.50	74338	POA

All adapter nipples are segmentally welded.

Orders for items in shaded areas **cannot** be cancelled or returned.

**Technical Data Sheet: TFP1810**

**#392 Domestic – Groove x Groove Adapter Nipple**

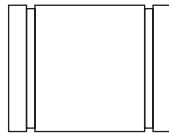

Nom. Size	Painted		Galvanized	
	Domestic Part Number	List Price	Domestic Part Number	List Price
1 1/4" x 4"	75098	\$43.00	74339	POA
1 1/2" x 4"	75099	\$43.00	74405	POA
2" x 4"	75100	\$43.00	74406	POA
2 1/2" x 4"	75101	\$49.50	74407	POA
3" x 4"	75102	\$60.00	74408	POA
4" x 6"	75103	\$98.50	74309	POA
5" x 6"	75104	\$203.50	74310	POA
6" x 6"	75105	\$261.00	74311	POA
8" x 6"	75106	\$292.50	74312	POA
10" x 8"	75107	\$409.50	74313	POA
12" x 8"	75108	\$513.50	74314	POA

All adapter nipples are segmentally welded.

Orders for items in shaded areas **cannot** be cancelled or returned.

**Technical Data Sheet: TFP1810**

**#393 Domestic – Groove x Plain Adapter Nipple**

Nom. Size	Painted		Galvanized	
	Domestic Part Number	List Price	Domestic Part Number	List Price
1 1/4" x 4"	75148	\$43.00	74316	POA
1 1/2" x 4"	74315	\$43.00	74317	POA
2" x 4"	75150	\$43.00	74318	POA
2 1/2" x 4"	75151	\$49.50	74319	POA
3" x 4"	75152	\$60.00	74330	POA
4" x 6"	75153	\$98.50	74331	POA
5" x 6"	75158	\$203.50	74322	POA
6" x 6"	75154	\$261.00	74323	POA
8" x 6"	75155	\$292.50	74324	POA
10" x 8"	75156	\$409.50	74325	POA
12" x 8"	75157	\$513.50	74326	POA

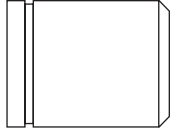

All adapter nipples are segmentally welded.

Orders for items in shaded areas **cannot** be cancelled or returned.

**Technical Data Sheet: TFP1810**

Section 16  
Specialty Items

Section 18  
Grooved Products

Section 19  
CPVC Pipe & Fittings

Section 20  
Miscellaneous

Section 21  
Electrical

Section C  
Valves & Hose Equipment

Section D  
Backflow

Section F  
Pipe & Accessories

Section H  
Hangers

Section J  
Lubricants

Section K  
Misc.

**#730 Domestic – Female Threaded Mechanical Tee  
with Grade “E” EPDM Gasket Threaded Outlet**

Nom. Size	Painted		Galvanized		Gasket Only	
	Domestic Part Number	List Price	Domestic Part Number	List Price	Domestic Part Number	List Price
2" x 1/2"	7302005ES	\$66.00	7302005EGS	\$83.50	730EGS-1	\$13.50
2" x 3/4"	73020075ES	\$66.00	73020075EGS	\$83.50	730EGS-1	\$13.50
2" x 1"	7302010ES	\$66.00	7302010EGS	\$83.50	730EGS-1	\$13.50
2" x 1 1/4"	7302013ES	\$76.50	7302013EGS	\$95.50	730EGS-2	\$15.50
2" x 1 1/2"	7302015ES	\$76.50	7302015EGS	\$95.50	730EGS-2	\$15.50
2 1/2" x 1/2"	7302505ES	\$66.00	7302505EGS	\$83.50	730EGS-1	\$13.50
2 1/2" x 3/4"	73025075ES	\$66.00	73025075EGS	\$83.50	730EGS-1	\$13.50
2 1/2" x 1"	7302510ES	\$66.00	7302510EGS	\$83.50	730EGS-1	\$13.50
2 1/2" x 1 1/4"	7302513ES	\$93.50	7302513EGS	\$114.00	730EGS-3	\$15.50
2 1/2" x 1 1/2"	7302515ES	\$93.50	7302515EGS	\$114.00	730EGS-3	\$15.50
2 1/2" x 2"	7302520EP *	\$93.50	7302520EGP *	POA	730EGS-4	\$15.50
3" x 1/2"	7303005ES	\$76.50	7303005EGS	\$93.50	730EGS-1	\$13.50
3" x 3/4"	73030075ES	\$76.50	73030075EGS	\$93.50	730EGS-1	\$13.50
3" x 1"	7303010ES	\$76.50	7303010EGS	\$93.50	730EGS-1	\$13.50
3" x 1 1/4"	7303013ES	\$97.00	7303013EGS	\$121.50	730EGS-2	\$15.50
3" x 1 1/2"	7303015ES	\$97.00	7303015EGS	\$121.50	730EGS-3	\$15.50
3" x 2"	7303020ES	\$111.50	7303020EGS	\$139.00	730EGS-4	\$15.50
4" x 1/2"	7304005ES	\$96.50	7304005EGS	\$115.50	730EGS-1	\$13.50
4" x 3/4"	73040075ES	\$96.50	73040075EGS	\$115.50	730EGS-1	\$13.50
4" x 1"	7304010ES	\$96.50	7304010EGS	\$115.50	730EGS-1	\$13.50
4" x 1 1/4"	7304013ES	\$113.00	7304013EGS	\$133.50	730EGS-2	\$15.50
4" x 1 1/2"	7304015ES	\$118.00	7304015EGS	\$148.00	730EGS-3	\$15.50
4" x 2"	7304020ES	\$118.00	7304020EGS	\$149.50	730EGS-4	\$15.50
4" x 2 1/2"	7304025ES	\$123.00	7304025EGS	\$159.50	730EGS-5	\$18.00
4" x 3"	7304030ES	\$131.00	7304030EGS	\$168.00	730EGS-7	\$19.50
5" x 1 1/2"	7305015EP *	\$144.00	7305015EGP *	\$182.00	730EGS-3	\$15.50
5" x 2"	7305020ES	\$144.00	7305020EGS	\$182.00	730EGS-4	\$15.50
5" x 2 1/2"	7305025ES	\$152.00	7305025EGS	\$193.50	730EGS-5	\$18.00
5" x 3"	7305030EP *	\$161.50	7305030EGP *	\$208.00	730EGS-7	\$19.50
6" x 1 1/4"	7306013EP *	POA	7306013EGP *	POA	730EGS-2	\$15.50
6" x 1 1/2"	7306015ES	\$147.50	7306015EGS	\$189.00	730EGS-3	\$15.50
6" x 2"	7306020ES	\$147.50	7306020EGS	\$189.00	730EGS-4	\$15.50
6" x 2 1/2"	7306025ES	\$159.00	7306025EGS	\$205.50	730EGS-6	\$18.50
6" x 3"	7306030ES	\$168.50	7306030EGS	\$217.50	730EGS-8	\$19.50
6" x 4"	7306040ES	\$187.00	7306040EGS	\$244.00	730EGS-9	\$26.50
8" x 2 1/2"	7308025ES	\$258.00	7308025EGS	\$326.00	730EGS-6	\$18.50
8" x 3"	7308030ES	\$272.50	7308030EGS	\$345.50	730EGS-8	\$19.50
8" x 4"	7308040ES	\$280.50	7308040EGS	\$362.50	730EGS-9	\$26.50

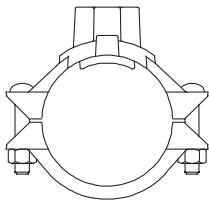

\* Only available as Global.

Orders for items in shaded areas **cannot** be cancelled or returned.

**Technical Data Sheet: TFP1860**

**#730 Domestic – Grooved Mechanical Tee  
with Grade “E” EPDM Gasket Grooved Outlet**

Nom. Size	Painted		Galvanized		Gasket Only	
	Domestic Part Number	List Price	Domestic Part Number	List Price	Domestic Part Number	List Price
2" x 1 1/4"	7302013ERS	\$76.50	7302013EGRS	\$95.50	730EGS-2	\$15.50
2" x 1 1/2"	7302015ERS	\$76.50	7302015EGRS	\$95.50	730EGS-2	\$15.50
2 1/2" x 1 1/4"	7302513ERS	\$93.50	7302513EGRS	\$114.00	730EGS-3	\$15.50
2 1/2" x 1 1/2"	7302515ERS	\$93.50	7302515EGRS	\$114.00	730EGS-3	\$15.50
2 1/2" x 2"	7302520ERP *	POA	7302520EGRP *	POA	730EGS-4	\$15.50
3" x 1 1/4"	7303013ERS	\$97.00	7303013EGRS	\$121.50	730EGS-2	\$15.50
3" x 1 1/2"	7303015ERS	\$97.00	7303015EGRS	\$121.50	730EGS-3	\$15.50
3" x 2"	7303020ERS	\$111.50	7303020EGRS	\$139.00	730EGS-4	\$15.50
4" x 1 1/4"	7304013ERS	\$113.00	7304013EGRS	\$133.50	730EGS-2	\$15.50
4" x 1 1/2"	7304015ERS	\$118.00	7304015EGRS	\$148.00	730EGS-3	\$15.50
4" x 2"	7304020ERS	\$118.00	7304020EGRS	\$149.50	730EGS-4	\$15.50
4" x 2 1/2"	7304025ERS	\$123.00	7304025EGRS	\$159.50	730EGS-5	\$18.00
4" x 3"	7304030ERS	\$131.00	7304030EGRS	\$168.00	730EGS-7	\$19.50
5" x 1 1/2"	7305015ERP *	\$144.00	7305015EGRP *	\$182.00	730EGS-3	\$15.50
5" x 2"	7305020ERS	\$144.00	7305020EGRS	\$182.00	730EGS-4	\$15.50
5" x 2 1/2"	7305025ERS	\$152.00	7305025EGRS	\$193.50	730EGS-5	\$18.00
5" x 3"	7305030ERP *	\$161.50	7305030EGRP *	\$208.00	730EGS-7	\$19.50
6" x 1 1/4"	7306013ERP *	\$147.50	7306013EGRP *	\$189.00	730EGS-2	\$15.50
6" x 1 1/2"	7306015ERS	\$147.50	7306015EGRS	\$189.00	730EGS-3	\$15.50
6" x 2"	7306020ERS	\$147.50	7306020EGRS	\$189.00	730EGS-4	\$15.50
6" x 2 1/2"	7306025ERS	\$161.50	7306025EGRS	\$205.50	730EGS-6	\$18.50
6" x 3"	7306030ERS	\$168.50	7306030EGRS	\$217.50	730EGS-8	\$19.50
6" x 4"	7306040ERS	\$187.00	7306040EGRS	\$244.00	730EGS-9	\$26.50
8" x 2 1/2"	7308025ERS	\$258.00	7308025EGRS	\$326.00	730EGS-6	\$18.50
8" x 3"	7308030ERS	\$272.50	7308030EGRS	\$345.50	730EGS-8	\$19.50
8" x 4"	7308040ERS	\$280.50	7308040EGRS	\$362.50	730EGS-9	\$26.50

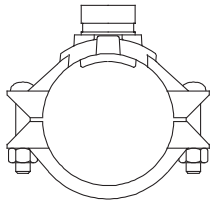

\* Only available as Global.

Orders for items in shaded areas **cannot** be cancelled or returned.

Technical Data Sheet: TFP1860

Section 16  
Specialty Items

Section 18  
Grooved Products

Section 19  
CPVC Pipe & Fittings

Section 20  
Miscellaneous

Section 21  
Electrical

Section C  
Valves & Hose Equipment

Section D  
Backflow

Section F  
Pipe & Accessories

Section H  
Hangers

Section J  
Lubricants

Section K  
Misc.

**#730 Domestic – Female Threaded Mechanical Cross  
with Grade “E” EPDM Gasket Threaded Outlet**

Nom. Size	Painted		Galvanized		Gasket Only (2 required for Cross)	
	Domestic Part Number	List Price	Domestic Part Number	List Price	Domestic Part Number	List Price
2" x 1 1/4"	7302013ECS	\$120.00	7302013EGCS	\$154.50	730EGS-2	\$15.50
2" x 1 1/2"	7302015ECS	\$120.00	7302015EGCS	\$154.50	730EGS-2	\$15.50
2 1/2" x 1 1/4"	7302513ECS	\$144.50	7302513EGCS	\$186.50	730EGS-3	\$15.50
2 1/2" x 1 1/2"	7302515ECS	\$144.50	7302515EGCS	\$199.50	730EGS-3	\$15.50
3" x 1 1/4"	7303013ECS	\$144.50	7303013EGCS	\$180.50	730EGS-2	\$15.50
3" x 1 1/2"	7303015ECS	\$144.50	7303015EGCS	\$180.50	730EGS-3	\$15.50
3" x 2"	7303020ECS	\$167.00	7303020EGCS	\$207.00	730EGS-4	\$15.50
4" x 1 1/4"	7304013ECS	\$175.00	7304013EGCS	\$220.00	730EGS-2	\$15.50
4" x 1 1/2"	7304015ECS	\$175.00	7304015EGCS	\$220.00	730EGS-3	\$15.50
4" x 2"	7304020ECS	\$187.50	7304020EGCS	\$221.50	730EGS-4	\$15.50
4" x 2 1/2"	7304025ECS	\$187.50	7304025EGCS	\$238.50	730EGS-5	\$18.00
4" x 3"	7304030ECS	\$195.50	7304030EGCS	\$253.00	730EGS-7	\$19.50
5" x 2"	7305020ECS	\$214.50	7305020EGCS	\$272.50	730EGS-4	\$15.50
5" x 2 1/2"	7305025ECS	\$226.00	7305025EGCS	\$288.50	730EGS-5	\$18.00
6" x 1 1/2"	7306015ECS	\$219.50	7306015EGCS	\$282.50	730EGS-3	\$15.50
6" x 2"	7306020ECS	\$229.00	7306020EGCS	\$305.50	730EGS-4	\$15.50
6" x 2 1/2"	7306025ECS	\$236.00	7306025EGCS	\$305.50	730EGS-6	\$18.50
6" x 3"	7306030ECS	\$252.00	7306030EGCS	\$323.50	730EGS-8	\$19.50
6" x 4"	7306040ECS	\$279.00	7306040EGCS	\$362.50	730EGS-9	\$26.50
8" x 2 1/2"	7308025ECS	\$386.00	7308025EGCS	\$487.50	730EGS-6	\$18.50
8" x 3"	7308030ECS	\$406.50	7308030EGCS	\$517.00	730EGS-8	\$19.50
8" x 4"	7308040ECS	\$420.00	7308040EGCS	\$543.00	730EGS-9	\$26.50

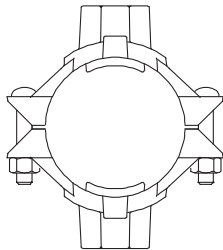

Orders for items in shaded areas **cannot** be cancelled or returned.

**Technical Data Sheet: TFP1860**

See latest catalog or technical data sheets for specific approvals, listings, and design parameters.  
POA = Price on availability. Prices subject to change without notice.

#730 Domestic – Grooved Mechanical Cross  
with Grade “E” EPDM Gasket Grooved Outlet

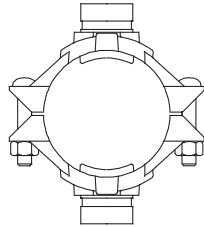

Nom. Size	Painted		Galvanized		Gasket Only (2 required for Cross)	
	Domestic Part Number	List Price	Domestic Part Number	List Price	Domestic Part Number	List Price
2" x 1 1/4"	7302013ERCS	\$120.00	7302013EGRCS	\$154.50	730EGS-2	\$15.50
2" x 1 1/2"	7302015ERCS	\$120.00	7302015EGRCS	\$154.50	730EGS-2	\$15.50
2 1/2" x 1 1/4"	7302513ERCS	\$144.50	7302513EGRCS	\$186.50	730EGS-3	\$15.50
2 1/2" x 1 1/2"	7302515ERCS	\$144.50	7302515EGRCS	\$199.50	730EGS-3	\$15.50
3" x 1 1/4"	7303013ERCS	\$144.50	7303013EGRCS	\$180.50	730EGS-2	\$15.50
3" x 1 1/2"	7303015ERCS	\$144.50	7303015EGRCS	\$180.50	730EGS-3	\$15.50
3" x 2"	7303020ERCS	\$167.00	7303020EGRCS	\$207.00	730EGS-4	\$15.50
4" x 1 1/4"	7304013ERCS	\$175.00	7304013EGRCS	\$220.00	730EGS-2	\$15.50
4" x 1 1/2"	7304015ERCS	\$175.00	7304015EGRCS	\$220.00	730EGS-3	\$15.50
4" x 2"	7304020ERCS	\$187.50	7304020EGRCS	\$221.50	730EGS-4	\$15.50
4" x 2 1/2"	7304025ERCS	\$187.50	7304025EGRCS	\$238.50	730EGS-5	\$18.00
4" x 3"	7304030ERCS	\$195.50	7304030EGRCS	\$253.00	730EGS-7	\$19.50
5" x 2"	7305020ERCS	\$214.50	7305020EGRCS	\$272.50	730EGS-4	\$15.50
5" x 2 1/2"	7305025ERCS	\$226.00	7305025EGRCS	\$288.50	730EGS-5	\$18.00
6" x 1 1/2"	7306015ERCS	\$219.50	7306015EGRCS	\$282.50	730EGS-3	\$15.50
6" x 2"	7306020ERCS	\$229.00	7306020EGRCS	\$305.50	730EGS-4	\$15.50
6" x 2 1/2"	7306025ERCS	\$236.00	7306025EGRCS	\$305.50	730EGS-6	\$18.50
6" x 3"	7306030ERCS	\$252.00	7306030EGRCS	\$323.50	730EGS-8	\$19.50
6" x 4"	7306040ERCS	\$279.00	7306040EGRCS	\$362.50	730EGS-9	\$26.50
8" x 2 1/2"	7308025ERCS	\$386.00	7308025EGRCS	\$487.50	730EGS-6	\$18.50
8" x 3"	7308030ERCS	\$406.50	7308030EGRCS	\$517.00	730EGS-8	\$19.50
8" x 4"	7308040ERCS	\$420.00	7308040EGRCS	\$543.00	730EGS-9	\$26.50

Orders for items in shaded areas **cannot** be cancelled or returned.

Technical Data Sheet: TFP1860

Section 16  
Specialty Items

Section 18  
Grooved Products

Section 19  
CPVC Pipe & Fittings

Section 20  
Miscellaneous

Section 21  
Electrical

Section C  
Valves & Hose Equipment

Section D  
Backflow

Section F  
Pipe & Accessories

Section H  
Hangers

Section J  
Lubricants

Section K  
Misc.

**G-FIRE #BFV-N Domestic – Grooved Butterfly Valves Fire Protection**

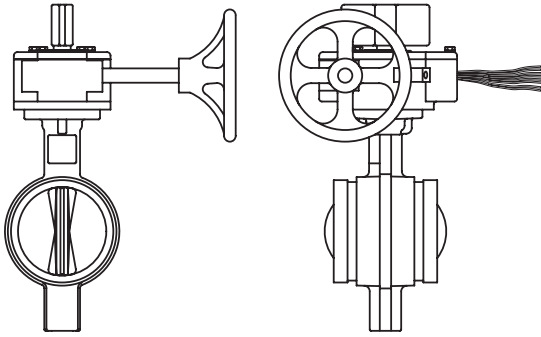

**Model BFV-N Grv x Grv, Gear Operated  
with Tamper Switches – 300psi**

<i>Nom. Size</i>	<i>Domestic Part Number - UL, FM &amp; ULC</i>	<i>List Price</i>
2 1/2"	59-300-F-025N	\$609.00
3"	59-300-F-030N	\$658.50
4"	59-300-F-040N	\$690.50
5"	59-300-F-050N	\$1,034.50
6"	59-300-F-060N	\$981.00
8"	59-300-F-080N	\$1,503.00
10"	59-300-F-100N	\$3,639.50

Orders for items in shaded areas **cannot** be cancelled or returned.

**Technical Data Sheet: TFP1510**

**G-FIRE #CV-1F Global – Grooved Check Valve**

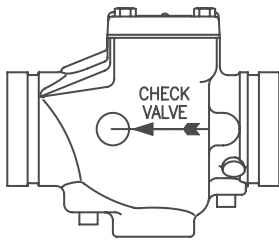

<i>Nom. Size</i>	<i>Global Part Number</i>	<i>List Price</i>
2"	59-590-0-020	\$330.50
2 1/2"	59-590-0-025	\$349.00
3"	59-590-0-030	\$349.00
4"	59-590-0-040	\$363.00
5"	59-590-0-050	\$883.00
6"	59-590-0-060	\$904.50
8"	59-590-0-080	\$1,571.00
10"	59-590-0-100	\$2,993.50

**Technical Data Sheet: TFP1550**

Section 16 Specialty Items  
Section 18 Grooved Product  
Section 19 CPVC Pipe & Fittings  
Section 20 Miscellaneous  
Section 21 Electrical  
Section C Valves & Hose Equipment  
Section D Backflow  
Section F Pipe & Accessories  
Section H Hangers  
Section J Lubricants  
Section K Misc.



**Roll Grooving Machine Selection Chart**

Machine Type	Pace Model	Size Range				Drive	Rolls Supplied			Part No.	List Price **
		Sch. 40	Sch. 10	Std. Wall	Copper		Size	Steel	Copper		
Portable with Electric Motor	1112	1" - 12"	-	-	2" - 8"	1½ HP, 110V	1" - 12"	■		41048	\$6,943.00
	1023	1¼" - 12"	-	12" - 24"	2" - 8"	1½ HP, 110V	1¼" - 12"	■		41029	\$10,268.00
							2" - 12"	■		41250	\$9,772.00
							1¼" - 24"	■		41251	\$11,439.00
							2" - 24"	■		41252	\$10,939.00
Portable for Ridgid® 300	1012	1" - 12"	-	-	2" - 8"	Ridgid® 300	1" - 12"	■		41041	\$3,853.00
	1022	1¼" - 12"	-	12" - 16"	2" - 8"	Ridgid® 300	1¼" - 16"	■		41027	\$8,674.00
	1041	1" - 6"	1" - 12"	-	2" - 8"	Ridgid® 300	1" - 12"	■		41018	\$2,699.00
Mini-Mites	1039-66	1¼" - 6"	-	-	2" - 8"	Ridgid® 300, Hand Crank	2" - 8" CTS		■	41047	\$767.00
	1039	1¼" - 6"	-	-	2" - 8"	Ridgid® 300, Hand Crank	1¼" - 6" IPS	■		41017	\$767.00
	1034	1¼" - 6"	-	-	-	Ridgid® 300	1¼" - 6" IPS	■		41015	\$571.00
	1066	-	-	-	2" - 8"	Ridgid® 300	2" - 8" CTS		■	41014	\$571.00
Automated	2021	1¼" - 12"	-	12" - 24"	2" - 8"	3 HP, 220V	1¼" - 12"	■		41257	\$18,046.00
							2" - 12"	■		41258	\$17,550.00
							1¼" - 24"	■		41032	\$18,671.00
							2" - 24"	■		41259	\$18,671.00
	2050	4" - 12"	4" - 30"	12" - 30"	-	5 HP, 220V	4" - 6"	■		41033	\$34,044.00
2112	1" - 12"	-	-	2" - 8"	½ HP, 110V	1" - 12"	■		41210	POA	
Portable Cut Groover	1000	2" - 8"	-	-	-	1 HP, 115V	2" - 8"			41260	\$8,083.00
		2" - 12"					2" - 12"			41261	\$8,843.00

\*\* Accessories not included, refer to Accessory Table Below.

**Accessories**

Item	Pace Model	Size Range	Capacity	Part No.	List Price	
Pipe Stands	4031	1" - 4"	600 Lbs.	41037	\$412.00	
	4000	2" - 8"	900 Lbs.	41038	\$509.00	
	4033	2" - 14"	1,200 Lbs.	41039	\$638.00	
	4040	12" - 24"	4,000 Lbs.	41040	\$1,618.00	
Nipple Bracket	4037	Fits Model 1021 / 22 / 23 / 2021		-	41035	\$515.00
	4045	4" - 12" Fits Model 1012 / 1112		-	41512	\$428.00
Mounting Feet	4039	Fits Portable Roll Groovers and Model 1000		-	41034	\$130.00
	4046	PA Mounting Feet		-	41013	\$130.00
Porta-Bore	3013	Up to 4¼" Holes in Pipe 1¼" - 12"		-	41049	\$2,066.00

Section 16  
Specialty Items

Section 18  
Grooved Products

Section 19  
CPVC Pipe & Fittings

Section 20  
Miscellaneous

Section 21  
Electrical

Section C  
Valves & Hose Equipment

Section D  
Backflow

Section F  
Pipe & Accessories

Section H  
Hangers

Section J  
Lubricants

Section K  
Misc.

Section 16  
Specialty Items

Section 18  
Grooved Product

Section 19  
CPVC Pipe & Fittings

Section 20  
Miscellaneous

Section 21  
Electrical

Section C  
Valves & Hose Equipment

Section D  
Backflow

Section F  
Pipe & Accessories

Section H  
Hangers

Section J  
Lubricants

Section K  
Misc.

Roll Selection Chart										
Machine	Pipe	Size	Top		Size	Bottom		Parts	Part Number	List Price
			Part No.	List Price		Part No.	List Price			
1021, 1023, 2021	Sch. 40	1 1/4" - 1 1/2"	41262	\$288.00	1 1/4" - 1 1/2"	41281	\$209.00			
		2" - 3 1/2"	41263	\$251.00	2" - 3 1/2"	41282	\$194.00			
		4" - 6"	41264	\$224.00	4" - 6"	41283	\$294.00			
		8" - 12"	41265	\$224.00	8" - 12"	41284	\$350.00			
	Std. Wall	14" - 16"	41266	\$210.00	14" - 16"	41285	\$385.00			
		18" - 24"	41267	\$210.00	18" - 24"	41286	\$385.00			
	Copper Tube	2" - 8"	41268	\$251.00	2" - 8"	41287	\$194.00	Depth Gauge 4043	41509	\$28.75
1010, 2010	Sch. 10, Sch. 40	1 1/2" - 6"	41269	\$210.00	1 1/2"	41288	\$194.00			
			-		2" - 3 1/2"	41289	\$194.00			
			-		4" - 6"	41290	\$282.00			
	Sch. 10	8" - 12"	41270	\$210.00	8" - 12"	41291	\$282.00			
1040, 2040	Sch. 40	1" - 1 1/2"	41271	\$172.00	1" - 1 1/2"	41292	\$172.00			
		1" - 6"	41272	\$152.00	1" - 6"	41293	\$144.00			
		2" - 6"	41273	\$172.00	-	-				
	Sch. 10	8" - 12"	41274	\$152.00	8" - 12"	41294	\$238.00			
	Copper Tube	2" - 8"	41275	\$153.00	2" - 8"	41295	\$147.00	Depth Gauge 4021	41510	\$28.75
1012, 1112, 2112	Sch. 40	1" - 1 1/2"	41276	\$172.00	1" - 1 1/2"	41296	\$172.00			
		2" - 6"	41277	\$172.00	2" - 6"	41297	\$144.00			
		8" - 12"	41278	\$172.00	8" - 12"	41298	\$240.00			
	Copper Tube	2" - 8"	41506	\$172.00	2" - 8"	41507	\$147.00	Depth Gauge 4021	41510	\$28.75
1021, 1022, 1023, 2021	SS 10 Ga.				2" - 3 1/2"	41299	\$212.00			
					4" - 6"	41500	\$323.00			
					8" - 12"	41501	\$385.00			
					14" - 16"	41504	\$423.00			
					18" - 24"	41505	\$423.00			
1040, 1041, 1112, 2112	SS 10 Ga.				2" - 6"	41502	\$160.00			
					8" - 12"	41503	\$285.00			
1034, 1039	Sch. 40	1 1/4" - 6", w/ brg.	41279	\$39.00				1034 Drive Shaft 1 1/4" - 6"	41511	POA
								1039 Drive Shaft 1 1/4" - 6"	41513	POA
								Depth Gauge 4021	41510	\$28.75
1039	Copper Tube	2" - 8", w/ brg.	41280	\$52.00			Depth Gauge 4021	41510	\$28.75	
1066	Copper Tube	2" - 8", w/ brg.	41508	\$52.00				Drive Shaft 2" - 8"	41514	POA
								Depth Gauge 4021	41510	\$28.75

See latest catalog or technical data sheets for specific approvals, listings, and design parameters.  
POA = Price on availability. Prices subject to change without notice.

**Domestic Grooved Couplings – Packaging Quantity**  
(Including Std. and Pre-Lubricated Gaskets)

Nom. Size	#577 Painted		#577 Galvanized & #577 Tri-Seal		#705 Painted		#705 Galvanized & Tri-Seal		#71 Flange Adapter		Size Range	#716 Reducing Coupling	
	Pieces / Carton	Pieces / Crate	Pieces / Carton	Pieces / Crate	Pieces / Carton	Pieces / Crate	Pieces / Carton	Pieces / Crate	Pieces / Carton	Pieces / Crate		Pieces / Carton	Pieces / Crate
1 1/4"	32	384	32	–	32	–	32	–	–	–	2" x 1 1/2"	20	–
1 1/2"	32	384	32	–	32	–	32	–	–	–	2 1/2" x 2"	36	–
2"	–	385	24	–	–	480	28	–	–	210	3" x 2"	12	–
2 1/2"	–	350	20	–	–	350	20	–	–	210	3" x 2 1/2"	9	–
3"	–	240	28	–	–	270	35	–	–	124	4" x 2"	6	–
4"	–	150	20	–	–	175	20	–	–	124	4" x 2 1/2"	6	–
5"	–	120	–	–	–	96	–	96	–	30	4" x 3"	6	–
6"	–	100	–	80	–	80	–	80	–	30	5" x 4"	–	80
8"	–	48	–	48	–	48	–	48	–	30	6" x 4"	–	64
10"	–	24	–	24	–	24	–	24	–	24	6" x 5"	–	64
12"	–	24	–	24	–	20	–	20	–	24	8" x 6"	–	36

**Domestic Grooved Fittings – Packaging Quantity**

Nom. Size	#510 90° Elbow		#501 45° Elbow		#519 Tee		#260 Cap		Nom. Size Range	ADACAP		#40-5 Strap	
	Pieces / Carton	Pieces / Crate	Pieces / Carton	Pieces / Crate	Pieces / Carton	Pieces / Crate	Pieces / Carton	Pieces / Crate		Pieces / Carton	Pieces / Crate	Pieces / Carton	Pieces / Crate
1 1/4"	40	–	45	–	28	–	287	–	1 1/4" x 1 1/2"	–	–	45	–
1 1/2"	27	–	39	–	28	–	210	–	1 1/4" x 3/4"	–	–	45	–
2"	18	–	24	–	24	–	140	–	1 1/4" x 1"	–	–	45	–
2 1/2"	8	–	15	–	10	–	84	–	1 1/2" x 1 1/2"	50	–	45	–
3"	12	–	18	–	12	–	56	–	1 1/2" x 3/4"	50	–	45	–
4"	–	168	–	96	–	46	30	–	1 1/2" x 1"	50	–	45	–
5"	–	105	–	140	–	75	–	392	2" x 1 1/2"	50	–	45	–
6"	–	63	–	90	–	48	–	288	2" x 3/4"	50	–	45	–
8"	–	28	–	48	–	24	–	160	2" x 1"	50	–	45	–
10"	–	15	–	–	–	–	–	96	2 1/2" x 1 1/2"	40	–	40	–
12"	–	8	–	–	–	–	–	63	2 1/2" x 3/4"	40	–	40	–
–	–	–	–	–	–	–	–	–	2 1/2" x 1"	40	–	40	–

Section 16  
Specialty Items

Section 18  
Grooved Products

Section 19  
CPVC Pipe & Fittings

Section 20  
Miscellaneous

Section 21  
Electrical

Section C  
Valves & Hose Equipment

Section D  
Backflow

Section F  
Pipe & Accessories

Section H  
Hangers

Section J  
Lubricants

Section K  
Misc.

Section 16  
Specialty Items

Section 18  
Grooved Product

Section 19  
CPVC Pipe & Fittings

Section 20  
Miscellaneous

Section 21  
Electrical

Section C  
Valves & Hose Equipment

Section D  
Backflow

Section F  
Pipe & Accessories

Section H  
Hangers

Section J  
Lubricants

Section K  
Misc.

Domestic Grooved Fittings – Packaging Quantity				
Nom. Size	#510S Short Pattern 90° Elbow	#519S Short Pattern Tee	Nom. Size Range	#550 Concentric Reducer
	Pieces/Carton	Pieces/Crate		Pieces/Carton
2"	18	30	2 1/2" x 1 1/4"	36
2 1/2"	8	20	2 1/2" x 1 1/2"	36
3"	12	12	2 1/2" x 2"	36
4"	210	46	3" x 1 1/2"	45
6"	78	48	3" x 2"	60
8"	28	24	3" x 2 1/2"	30
-	-	-	4" x 2"	243
-	-	-	4" x 2 1/2"	243
-	-	-	4" x 3"	243
-	-	-	5" x 3"	147
-	-	-	5" x 4"	147
-	-	-	6" x 2"	72
-	-	-	6" x 2 1/2"	72
-	-	-	6" x 3"	72
-	-	-	6" x 4"	216
-	-	-	6" x 5"	216
-	-	-	8" x 3"	80
-	-	-	8" x 4"	80
-	-	-	8" x 5"	1
-	-	-	8" x 6"	1

Grooved Fittings – Pieces Per Carton/Case			
Nom Size	#730 Mechanical Tee	Nom Size	#730 Mechanical Tee (cont.)
2" x 1/2"	15	4" x 1/2"	12
2" x 3/4"	15	4" x 3/4"	12
2" x 1"	15	4" x 1 1/2"	12
2" x 1 1/4"	26	4" x 1 1/4"	12
2" x 1 1/2"	12	4" x 1 1/2"	12
2 1/2" x 1 1/2"	14	4" x 2"	10
2 1/2" x 3/4"	14	4" x 2 1/2"	10
2 1/2" x 1"	14	4" x 3"	8
2 1/2" x 1 1/4"	32	5" x 2"	8
2 1/2" x 1 1/2"	20	5" x 2 1/2"	8
3" x 1/2"	16	6" x 1 1/2"	8
3" x 3/4"	16	6" x 2"	7
3" x 1"	16	6" x 2 1/2"	7
3" x 1 1/4"	18	6" x 3"	6
3" x 1 1/2"	16	6" x 4"	6
3" x 2"	12	8" x 2 1/2"	4
-	-	8" x 3"	4
-	-	8" x 4"	4

See latest catalog or technical data sheets for specific approvals, listings, and design parameters.  
POA = Price on availability. Prices subject to change without notice.

**Global Grooved Couplings – Packaging Quantity**

Nom. Size	#577				#705			
	Pieces / Carton	Cartons / Pallet	Pieces / Pallet	Crate Qty	Pieces / Carton	Pieces / Crate	Pieces / Carton	Pieces / Crate
1 1/4"	26	48	1,248	–	24	48	1,152	–
1 1/2"	32	12	–	384	20	48	960	–
2"	20	48	960	–	16	48	768	–
2 1/2"	16	48	768	–	12	48	576	–
3"	–	–	–	819	–	–	–	520
4"	–	–	–	546	–	–	–	324
5"	–	–	–	120	–	–	–	–
6"	–	–	–	100	–	–	–	165
8"	–	–	–	108	–	–	–	80
10"	–	–	–	24	–	–	–	–
12"	–	–	–	24	–	–	–	–

**Global Grooved Fittings – Packaging Quantity**

Nom. Size	#510 90° Elbow				#501 45° Elbow				#519 Tee				#260 Cap			
	Pieces / Carton	Cartons / Pallet	Pieces / Pallet	Crate Qty	Pieces / Carton	Cartons / Pallet	Pieces / Pallet	Crate Qty	Pieces / Carton	Cartons / Pallet	Pieces / Pallet	Crate Qty	Pieces / Carton	Cartons / Pallet	Pieces / Pallet	Crate Qty
1 1/4"	28	48	1,344	–	54	48	2,592	–	22	48	1,056	–	132	48	6,336	–
1 1/2"	24	48	1,152	–	40	48	1,920	–	18	48	864	–	100	48	4,800	–
2"	13	48	624	–	18	48	864	–	12	48	576	–	64	48	3,072	–
2 1/2"	6	48	288	–	12	48	576	–	4	48	192	–	42	48	2,016	–
3"	4	48	192	–	8	48	384	–	3	48	144	–	24	48	1,152	–
4"	–	–	–	195	–	–	–	315	–	–	–	120	12	48	576	–
6"	–	–	–	68	–	–	–	100	–	–	–	42	3	48	144	–
8"	–	–	–	32	–	–	–	44	–	–	–	18	3	48	144	–
10"	–	–	–	16	–	–	–	18	–	–	–	10	–	–	–	–
12"	–	–	–	8	–	–	–	15	–	–	–	–	–	–	–	–

**Global Grooved Fittings – Packaging Quantity**

Nom. Size	#510S Short Pattern 90° Elbow				#501 45° Elbow				#519S Short Pattern Tee			
	Pieces / Carton	Cartons / Pallet	Pieces / Pallet	Crate Qty	Pieces / Carton	Cartons / Pallet	Pieces / Pallet	Crate Qty	Pieces / Carton	Cartons / Pallet	Pieces / Pallet	Crate Qty
2"	15	48	720	–	12	48	576	–	33	48	1,584	–
2 1/2"	10	48	480	–	6	48	288	–	30	48	1,440	–
3"	8	48	288	–	4	48	192	–	24	48	1,152	–
4"	–	–	–	234	–	–	–	150	10	48	480	–
6"	–	–	–	72	–	–	–	56	3	48	144	–
8"	–	–	–	33	–	–	–	21	2	48	96	–

Section 16  
Specialty Items

Section 18  
Grooved Products

Section 19  
CPVC Pipe & Fittings

Section 20  
Miscellaneous

Section 21  
Electrical

Section C  
Valves & Hose Equipment

Section D  
Backflow

Section F  
Pipe & Accessories

Section H  
Hangers

Section J  
Lubricants

Section K  
Misc.

Section 16 Specialty Items
Section 18 Grooved Product
Section 19 CPVC Pipe & Fittings
Section 20 Miscellaneous
Section 21 Electrical
Section C Valves & Hose Equipment
Section D Backflow
Section F Pipe & Accessories
Section H Hangers
Section J Lubricants
Section K Misc.

See latest catalog or technical data sheets for specific approvals, listings, and design parameters.  
POA = Price on availability. Prices subject to change without notice.

**Customer Service: (800) 558-5236**  
**[www.tyco-fire.com](http://www.tyco-fire.com) & [www.grinnell.com](http://www.grinnell.com)**