

### Features

- Vitreous china.
- Two-piece toilet.
- Comfort Height® Elongated bowl.
- AquaPiston® flushing system.
- Includes left-hand polished chrome trip lever.
- 1.6 gpf (6.0 lpf).
- 2-1/8" (54 mm) fully glazed trapway.
- 12" (305 mm) rough-in.
- Less seat and supply.
- 11" (279 mm) x 8-3/4" (222 mm) water area.
- 30" (762 mm) x 16-3/4" (425 mm) x 30-1/2" (775 mm).
- Floor mount / Floor outlet.

### Recommended Accessories

K- 7637 Angle Supply with Stop (single)

### Optional Accessories

K- 4650 Toilet Seat

K- 9385 Left-hand Trip Lever

### Components

Product includes:

K- 4306 Toilet Bowl

K- 4474 Toilet Tank

Additional included component/s: Tank cover, Trip lever, Bolt cap accessory pack, and Tank accessory pack.



ADA

### Codes/Standards

ASME A112.19.7/CSA B45.10

DOE - Energy Policy Act 1992

ADA







ICC/ANSI A117.1

### KOHLER® One-Year Limited Warranty

See website for detailed warranty information.

### Available Color/Finishes

*Color tiles intended for reference only.*

Color	Code	Description
	0	White
	96	Biscuit
	47	Almond
	NY	Dune
	95	Ice™ Grey
	G9	Sandbar
	7	Black Black™

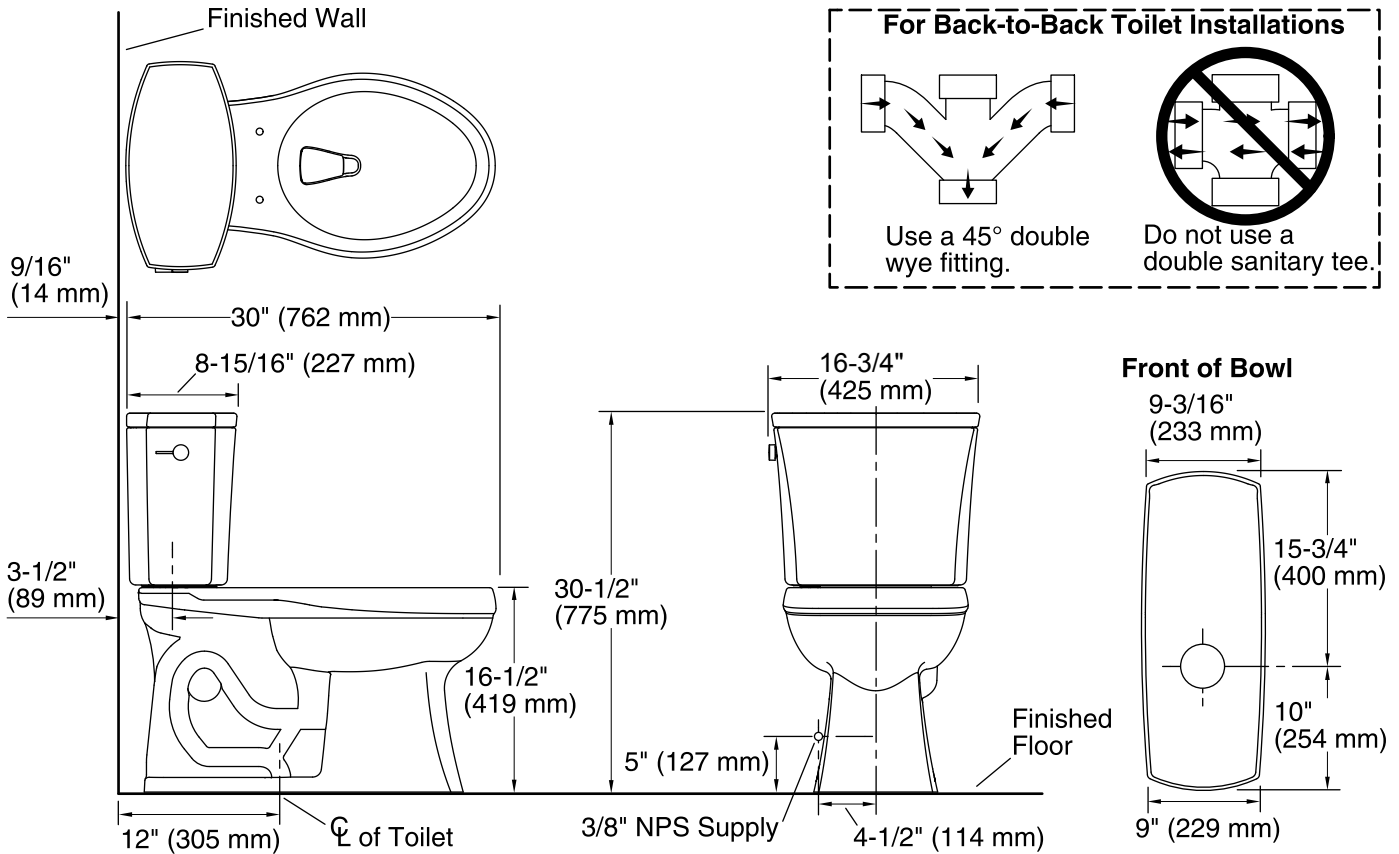

## Technical Information

All product dimensions are nominal.

Toilet type:	Two-piece
Bowl shape:	Elongated front
Flush type:	AquaPiston
Trap passageway:	2-1/8" (54 mm)
Water Consumption	
Full:	1.6 gpf (6 lpf)
Water surface size:	11" x 8-3/4" (279 mm x 222 mm)
Rim to water surface:	6" (152 mm)
Rough-in:	12" (305 mm)
Seat-mounting holes:	5-1/2" (140 mm)

## Notes

Install this product according to the installation guide.

For back-to-back toilet installations: Use only a 45° double wye fitting.

The model is acceptable for left-hand Accessible compartment installations only.

ADA compliant when installed to the specific requirements of these regulations.

The Model Plumbing Codes require the installation of elongated open-front toilet seats on public bathrooms.