

▲ Warning: This water heater is not suitable for use in manufactured (mobile) homes!

Use & Care Manual

With Installation Instructions for the Installer

Residential Gas - FVIR Certified

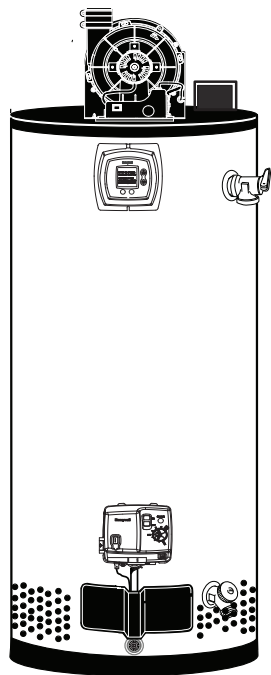

Model shown with factory installed optional digital display.

PowerVent® Water Heaters

Residential 40 and 50 Gallon

The purpose of this manual is twofold: one, to provide the installer with the basic directions and recommendations for the proper installation and adjustment of the water heater; and two, for the owner-operator, to explain the features, operation, safety precautions, maintenance and troubleshooting of the water heater. This manual also includes a parts list.

It is very important that all persons who are expected to install, operate or adjust this water heater read the instructions carefully so they may understand how to perform these operations. If you do not understand these instructions or any terms within it, seek professional assistance.

Any questions regarding the operation, maintenance, service or warranty of this water heater should be directed to the seller from whom it was purchased. If additional information is required, refer to the section on "If you need service."

Do not destroy this manual. Please read carefully and keep in a safe place for future reference.



Recognize this symbol as an indication of Important Safety Information!



WARNING: If the information in these instructions is not followed exactly, a fire or explosion may result causing property damage, personal injury or death.

▲ FOR YOUR SAFETY!

— **Do not store or use gasoline or other flammable vapours or liquids or other combustible materials in the vicinity of this or any other appliance. To do so may result in an explosion or fire.**

— WHAT TO DO IF YOU SMELL GAS

- Do not try to light any appliance.
- Do not touch any electrical switch; do not use any phone in your building.
- Immediately call your gas supplier from a neighbour's phone. Follow the gas supplier's instructions.

- If you cannot reach your gas supplier, call the fire department.
- Do not return to your home until authorized by the gas supplier or fire department.
- Improper installation, adjustment, alteration, service or maintenance can cause property damage, personal injury, or death. Refer to this manual. Installation and service must be performed by a qualified installer, service agency or the gas supplier.



Safety Information

Safety Precautions 3-6
LP Gas Models 5

Installation Instructions

Location 7
Water Supply Connections . . 9
Gas Supply 11
Venting 12-19
Wiring Diagram 20-21
Pipe Insulation 22
Install User Display 23-24
User Display Operation . . 25-26
Heat Traps 28
Installation Checklist 29
Potable/Space Heating 30

Operating Instructions

Lighting Instructions 31
Water Temperature 32-33

Care and Cleaning

Draining 35
Maintenance 35
Vent System Inspection . . . 36
Burner Inspection 36
Extended Shut-Down 37

Troubleshooting Tips

Before You Call
For Service 38-39

Customer Service

Parts List 41
If You Need Service 44



FOR YOUR RECORDS

Write the model and serial numbers here:

You can find them on a label on the appliance.

Staple sales slip or cancelled check here.

Proof of the original purchase date is needed to obtain service under the warranty.



READ THIS MANUAL

Inside you will find many helpful hints on how to use and maintain your water heater properly. A little preventive care on your part can save you time and money over the life of your water heater.

You'll find many answers to common problems in the Troubleshooting Guide. If you review the chart of Troubleshooting Tips first, you may not need to call for service.



READ THE SAFETY INFORMATION

Your safety and the safety of others are very important. There are many important safety messages in this manual and on your appliance. Always read and obey all safety messages.



This is the safety alert symbol. Recognize this symbol as an indication of Important Safety Information! This symbol alerts you to potential hazards that can kill or hurt you and others.

All safety messages will follow the safety alert symbol and either the word "DANGER", "WARNING", "CAUTION" or "NOTICE".

These words mean:

▲ DANGER

An imminently hazardous situation that will result in death or serious injury.

▲ WARNING

A potentially hazardous situation that could result in death or serious injury and/or damage to property.

▲ CAUTION

A potentially hazardous situation that may result in minor or moderate injury.

Notice:

Attention is called to observe a specified procedure or maintain a specific condition.

IMPORTANT SAFETY INFORMATION. READ ALL INSTRUCTIONS BEFORE USING.

Be sure to read and understand the entire Use and Care Manual before attempting to install or operate this water heater. It may save you time and money. Pay particular attention to the Safety Instructions. Failure to follow these warnings could result in serious bodily injury or death. Should you have problems understanding the instructions in this manual, or have any questions, STOP, and get help from a qualified service technician, or the local gas utility.

NOTICE: This water heater is equipped with a flammable vapour sensor that will automatically shut down the water heater in the presence of gasoline vapours and some other flammable vapours. If the flammable vapour sensor shuts down the water heater, contact a qualified service technician. Clear any hazardous materials and ventilate the area around the water heater. **DO NOT** turn off the appliance or adjust the ON/OFF switch in any way. **DO NOT** tamper with the flammable vapour sensor. **DO NOT** submerge the flammable vapour sensor in water. **DO NOT** allow the flammable vapour sensor to come into contact with any substances such as bleach or cleaners. See the “Gas Valve LED Error Code” Section of this manual for a list of error codes.

⚠ DANGER!

INSTALL THE BLOWER ASSEMBLY AND PROPERLY VENT THE WATER HEATER



Failure to install the blower assembly and properly vent the water heater to the outdoors as outlined in the Venting Section of the Installation Instructions in this manual can result in unsafe operation of the water heater. To avoid the risk of fire, explosion, or asphyxiation from carbon monoxide, never operate this water heater unless it is properly vented and has an adequate air supply for proper operation. Be sure to inspect the vent system for proper installation at initial start-up; and at least annually thereafter. Refer to the Care and Cleaning section of this manual for more information regarding vent system inspection.



⚠ WARNING!

Gasoline, as well as other flammable materials and liquids (which include but are not limited to adhesives, solvents, paint thinners etc.), and the vapours they produce are extremely dangerous. **DO NOT** handle, use or store gasoline or other flammable or combustible materials anywhere near or in the vicinity of a water heater or any other appliance. Be sure to read and follow the warning label pictured below and other labels on the water heater, as well as the warnings printed in this manual. Failure to do so can result in property damage, bodily injury or death.

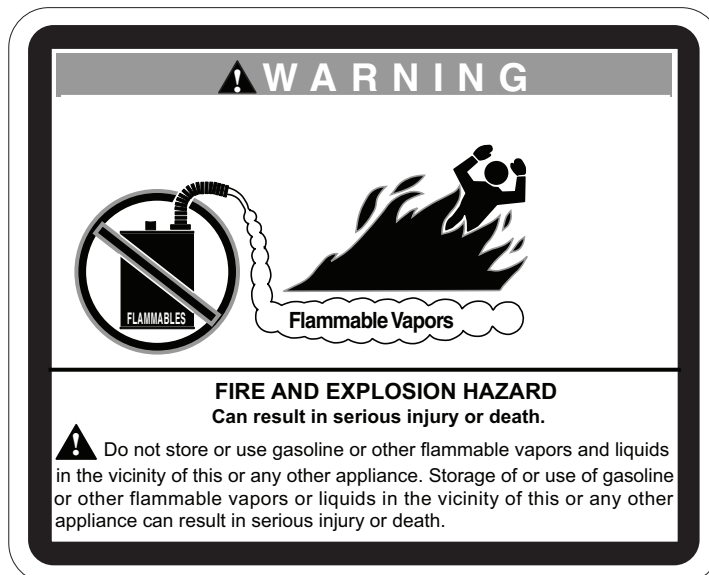

IMPORTANT SAFETY INFORMATION. READ ALL INSTRUCTIONS BEFORE USING.



⚠ DANGER! WATER TEMPERATURE SETTING

Safety and energy conservation are factors to be considered when selecting the water temperature setting of a water heater's gas control. Water temperatures above 125°F (52°C) can cause severe burns or death from scalding. Be sure to read and follow the warnings outlined on the label pictured below. This label is also located on the water heater.

DANGER

Water temperature over 125° F can cause severe burns instantly or death from scalds.

Children, disabled and elderly are at highest risk of being scalded.

See instruction manual before setting temperature at water heater.

Feel water before bathing or showering.

Temperature limiting valves are available, see manual.

Notice: Mixing valves are recommended for reducing point of use water temperature by mixing hot and cold water in branch water lines. It is recommended that a mixing valve complying with the Standard for Temperature Actuated Mixing Valves for Hot Water Distribution Systems, ASSE 1017 be installed. See pages 32 & 33 for more details and contact a licensed plumber or the local plumbing authority for further information.

Time/Temperature Relationship in Scalds

Water Temperature	Time To Produce a Serious Burn
120°F (49°C)	More than 5 minutes
125°F (52°C)	1½ to 2 minutes
130°F (54°C)	About 30 seconds
135°F (57°C)	About 10 seconds
140°F (60°C)	Less than 5 seconds
145°F (63°C)	Less than 3 seconds
150°F (66°C)	About 1½ seconds
155°F (68°C)	About 1 second

Table courtesy of Shriners Burn Institute

The chart shown above may be used as a guide in determining the proper water temperature for your home.

⚠ DANGER: Households with small children, disabled, or elderly persons may require a 120°F (49°C) or lower gas control (thermostat) setting to prevent contact with “HOT” water.

Maximum water temperatures occur just after the burner has shut off. To find water temperature being delivered, turn on a hot water faucet and place a thermometer in the water stream and read the thermometer. (See page 32 and 33 for more details.)

The temperature of the water in the heater can be regulated by rotating the dial on the front of the gas control (thermostat). To comply with safety regulations the gas control (thermostat) was set at its lowest setting before the water heater was shipped from the factory.

The illustration below details the approximate water temperature for each mark on the Gas Control (Thermostat) Temperature Dial.

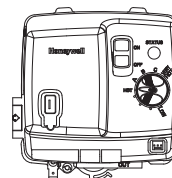

⚠ DANGER: Hotter water increases the potential for Hot Water SCALDS.

Valve Set Point	Estimated Temperature	Burns on Adult Skin
LOW	90°F (32°C)	-----
•	98°F (37°C)	-----
•	105°F (40°C)	-----
•	113°F (45°C)	-----
HOT	120°F (49°C)	More than 5 minutes
A	130°F (54°C)	About 30 seconds
B	140°F (60°C)	Less than 5 seconds
C	150°F (66°C)	About 1-1/2 seconds
VERY HOT	160°F (71°C)	About 1/2 second



! DANGER!

LIQUEFIED PETROLEUM (LP - PROPANE - BUTANE) AND NATURAL GAS MODELS

LP and Natural gas have an odorant added to aid in detecting a gas leak. Some people may not physically be able to smell or recognize this odorant. If you are unsure or unfamiliar with the smell of LP or natural gas, ask the gas supplier. Other conditions, such as “odorant fade”, which causes the odorant to diminish in intensity, can also hide or camouflage a gas leak.

- Water heaters utilizing LP gas are different from natural gas models. A natural gas water heater will not function safely on LP gas and vice versa.
 - No attempt should ever be made to convert the water heater from natural gas to LP gas. To avoid possible equipment damage, personal injury or fire, do not connect the water heater to a fuel type not in accordance with the unit data plate. LP for LP units. Natural gas for natural gas units. These units are not certified for any other fuel type.
 - LP appliances should not be installed below grade (for example, in a basement) if such installation is prohibited by federal, state and/or local laws, rules, regulations or customs.
 - LP gas must be used with great caution. It is heavier than air and will collect first in lower areas making it hard to detect at nose level.
 - Before attempting to light the water heater, make sure to look and smell for gas leaks. Use a soapy solution to check all gas fittings and connections. Bubbling at a connection indicates a leak that must be corrected. When smelling to detect a gas leak, be sure to sniff near the floor also.
 - Gas detectors are recommended in LP & natural gas applications and their installation should be in accordance with the detector manufacturer’s recommendations and/or local laws, rules, regulations or customs.
 - It is recommended that more than one method, such as soapy solution, gas detectors, etc., be used to detect leaks in gas applications.
- ! DANGER:** If a gas leak is present or suspected:
- **DO NOT** attempt to find the cause yourself.
 - **DO NOT** try to light any appliance.
 - **DO NOT** touch any electrical switch.
 - **DO NOT** use any phone in your building.
 - Leave the house immediately and make sure your family and pets leave also.
 - Leave the doors open for ventilation and contact the gas supplier, a qualified service agency or the fire department.
 - Stay away from the house (or building) until the service call has been made, the leak is corrected and a qualified agency has determined the area to be safe.

IMPORTANT SAFETY INFORMATION. READ ALL INSTRUCTIONS BEFORE USING.

WARNING!

For your safety, the information in this manual must be followed to minimize the risk of fire or explosion, electric shock, or to prevent property damage, personal injury, or loss of life.



SAFETY PRECAUTIONS

Have the installer show you the location of the gas shut-off valve and how to shut it off if necessary. Turn off the manual shut-off valve if the water heater has been subjected to overheating, fire, flood, physical damage or if the gas supply fails to shut off.

- Read this manual entirely before installing or operating the water heater.
- Use this appliance only for its intended purpose as described in this Use and Care Manual.
- Be sure your appliance is properly installed in accordance with local codes and the provided installation instructions.
- **DO NOT** attempt to repair or replace any part of your water heater unless it is specifically recommended in this manual. All other servicing should be referred to a qualified technician.



READ AND FOLLOW THIS SAFETY INFORMATION
CAREFULLY.

SAVE THESE INSTRUCTIONS

Installing the water heater

This water heater must be installed in accordance with these instructions, local codes, utility company requirements, and/or in the absence of local codes, use the latest edition of CAN/CSA B149 - Natural Gas and Propane Installation Code. A copy can be purchased from the Canadian Standards Association, 5060 Spectrum Way, Mississauga, Ontario L4W 5N6.

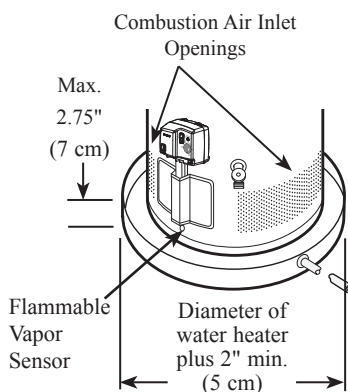

The auxiliary catch pan installation **MUST** conform to local codes.

Notice: DO NOT allow the catch pan to obstruct the flammable vapor sensor.

Notice: DO NOT allow the flammable vapour sensor to become submerged in water. Make sure the catch pan is properly drained.

▲ WARNING: Combustible construction refers to adjacent walls and ceilings and should not be confused with combustible or flammable products and materials. Combustible and/or flammable products and materials should never be stored in the vicinity of this or any gas appliance.

Location

The water heater should not be located in an area where leakage from the tank or connections will result in damage to the area adjacent to the heater or to lower floors of the structure.

When such areas cannot be avoided it is recommended that a suitable catch pan, adequately drained, must be installed under the water heater.

The water heater must be centered in the catch pan.

The pan must not restrict air flow to the combustion air inlet openings (perforation openings) located around the lower perimeter of the water heater.

Catch pan kits are available from the store where the water heater was purchased, or any water heater distributor.

Make certain the floor underneath the water heater is strong enough to sufficiently support the weight of the water heater once it is filled with water.

A gas fired water heater or any other appliance should not be installed in a space where liquids which give off flammable vapors are to be used or stored. Such liquids include gasoline, LP gas (butane or propane), paint or adhesives and their thinners, solvents or removers.

DO NOT block or obstruct any of the combustion air inlet openings located around the perimeter of the water heater. A minimum of 1"(2.5 cm) is required between these combustion air inlet openings and any obstruction.

DO NOT obstruct or block the Flammable Vapour Sensor.

Because of natural air movement in a room or other enclosed space, flammable vapours can be carried some distance from where liquids which give off flammable vapours are to be used or stored. The open flame of the water heater's pilot or main burner can ignite these vapours.

FVIR certified gas water heaters must be installed in accordance with the CAN/CSA B149.1 - Natural Gas and Propane Installation Code, for installation in

Residential Garages, unless otherwise directed by Province and Local code requirements. The water heater must be located so it is not subject to physical damage, for example, by moving vehicles, area flooding, etc.

IMPORTANT: DO NOT install the water heater in a location where it may be subjected to ambient temperatures exceeding 125°F (52°C).

- The water heater should be installed so as to minimize the length of plastic vent pipe and the number of vent connection fittings required. (Refer to the "INSTALLATION" Section of this manual.)
- Long hot water lines should be insulated to conserve water and energy.
- The water heater and water lines should be protected from exposure to freezing temperatures.
- **DO NOT** install the water heater in bathrooms, bedrooms, any occupied rooms normally kept closed, or in unprotected outdoor areas.
- Minimum clearance from combustible construction:

Front	Sides	Rear	Top
3" (7.6 cm)	1" (2.5 cm)	0" (0 cm)	12" (30.5 cm)

If the clearances stated on the Instruction/Warning Label, located on the front of the heater differ, install the water heater according to the clearances stated on the label.

- If the water heater is installed in an alcove or closet, the entire floor must be covered by a wood or metal panel. A minimum of 24" (61 cm) clearance from the front and top should be available for adequate inspection and servicing.
- The water heater may be installed on combustible floors, but not directly on carpeting. If the water heater must be installed on carpeting, place a metal or wood panel beneath the water heater, extending beyond its full width and depth at least 3"(7.6 cm) in all directions.

Installing the water heater

Inspect Shipment

Inspect the water heater for possible damage. Check the markings on the rating plate of the water heater to be certain the type of gas supplied corresponds to the water heater requirements.

Combustion and Ventilation Air

Proper operation of the water heater requires air for combustion and ventilation. Provisions for combustion and ventilation air must comply with referenced codes and standards.

DO NOT block or obstruct any of the combustion air inlet openings located around the perimeter of the water heater. A minimum of 1" (2.5 cm) is required between these combustion air inlet openings and any obstruction.

NOTICE: If the water heater is installed in an unconfined space within a building of conventional frame, masonry or metal construction, infiltration air is normally adequate for proper combustion and ventilation. If the water heater is installed in a confined space, provisions for combustion and ventilation air must be made.

DO NOT obstruct or block the Flammable Vapour Sensor.

A confined space is one having a volume of less than 50 cubic feet per 1000 Btuh (4.8m³/kW) of the aggregate input of all appliances within that space.

The air must be supplied through two permanent openings of equal area. One is to be located not more than 18" (46 cm) or less than 6" above floor level and the other is to be located within 12" (30.5 cm) from the ceiling.

The minimum net free area of each opening must not be less than one square inch (6.5 sq. cm) per 1000 Btuh of the total input rating of all the appliances in the enclosure (but not less than 100 square

inches (650 sq. cm)), if each opening communicates with other unconfined areas inside the building.

Buildings of unusually tight construction shall have the combustion and ventilation air supplied from outdoors, or a freely ventilated attic or crawl space.

If air is supplied from outdoors, directly or through vertical ducts, there must be two openings located as specified above and each must have a minimum net free area of not less than one square inch (6.5 sq. cm) per 4000 Btuh of the total input rating of all the appliances in the enclosure.

If horizontal ducts are used to communicate with the outdoors, each opening must have a minimum net free area of not less than one square inch (6.5 sq cm) per 2000 Btuh of the total input rating of all the appliances in the enclosure. If ducts are used, the minimum dimensions of rectangular air ducts shall not be less than 3" (7.62 cm).

NOTICE: If the duct openings which supply combustion and ventilation air are to be covered with a protective screen or grill, the net free area (openings in the material) of the covering material must be used in determining the size of the openings. Protective screening for the openings MUST NOT be smaller than 1/4" (0.64 cm) mesh to prevent clogging by lint or other debris.

NOTICE: DO NOT install the water heater in attics where the temperature may exceed 100°F (38°C). This water heater is equipped with a temperature sensing device that will shut off the water heater if the maximum allowable vent pipe temperature is exceeded.

NOTICE: The water heater should not be installed near an air supply containing halogenated hydrocarbons.

Corrosive Atmospheres

The air in beauty shops, dry cleaning establishments, photo processing labs, and storage areas for liquid and powdered bleaches or swimming pool chemicals often contain such halogenated hydrocarbons.

An air supply containing halogenated hydrocarbons may be safe to breathe, but when it passes through a gas flame corrosive elements are released that

will shorten the life of any gas burning appliance.

Propellants from common spray cans or gas leaks from A/C and refrigeration equipment are highly corrosive after passing through a flame.

The water heater warranty is voided when failure of the heater is due to operation in a corrosive atmosphere.

Thermal Expansion

Determine if a check valve exists in the inlet water line. Check with your local water utility company. It may have been installed in the cold water line as a separate back flow preventer, or it may be part of a pressure reducing valve, water meter or water softener. A check valve located in the cold water inlet line can cause what is referred to as a “**closed water system**”. A cold water inlet line with no check valve or back flow prevention device is referred to as an “**open**” water system.

As water is heated, it expands in volume and creates an increase in the pressure within the water system. This action is referred to as “**thermal expansion**”. In an “**open**” water system, expanding water which exceeds the capacity of the water heater flows back into the city main where the pressure is easily dissipated.

A “**closed water system**”, however, prevents the expanding water from flowing back into the main supply line, and the result of “**thermal expansion**” can create a rapid and dangerous

pressure increase in the water heater and system piping. This rapid pressure increase can quickly reach the safety setting of the relief valve, causing it to operate during each heating cycle. Thermal expansion, and the resulting rapid, and repeated expansion and contraction of components in the water heater and piping system can cause premature failure of the relief valve, and possibly the heater itself. Replacing the relief valve **will not** correct the problem!

The suggested method of controlling thermal expansion is to install an expansion tank in the cold water line between the water heater and the check valve (see illustration below). The expansion tank is designed with an air cushion built in that compresses as the system pressure increases, thereby relieving the over pressure condition and eliminating the repeated operation of the relief valve. Other methods of controlling thermal expansion are also available. Contact your installing contractor, water supplier or plumbing inspector for additional information regarding this subject.

IMPORTANT: DO NOT apply heat to the HOT or COLD water connections. If sweat connections are used, sweat tubing to adapter before fitting adapter to the cold water connections on heater. Any heat applied to the cold water supply fittings will permanently damage the dip tube and heat traps.

NOTICE: The Canadian Standards Association mandates a manual gas shut off valve: See CSA B149- Installation Code for complete instructions. Local codes or plumbing authority requirements may vary from the instructions or diagrams provided and take precedent over these instructions.

Water Supply Connections

Refer to the illustration below for suggested typical installation. The installation of unions or flexible copper connectors is recommended on the hot and cold water connections so that the water heater may be easily disconnected

for servicing if necessary. The HOT and COLD water connections are clearly marked and are 3/4” NPT on all models. Install a shut-off valve in the cold water line near the water heater.

Typical Installation

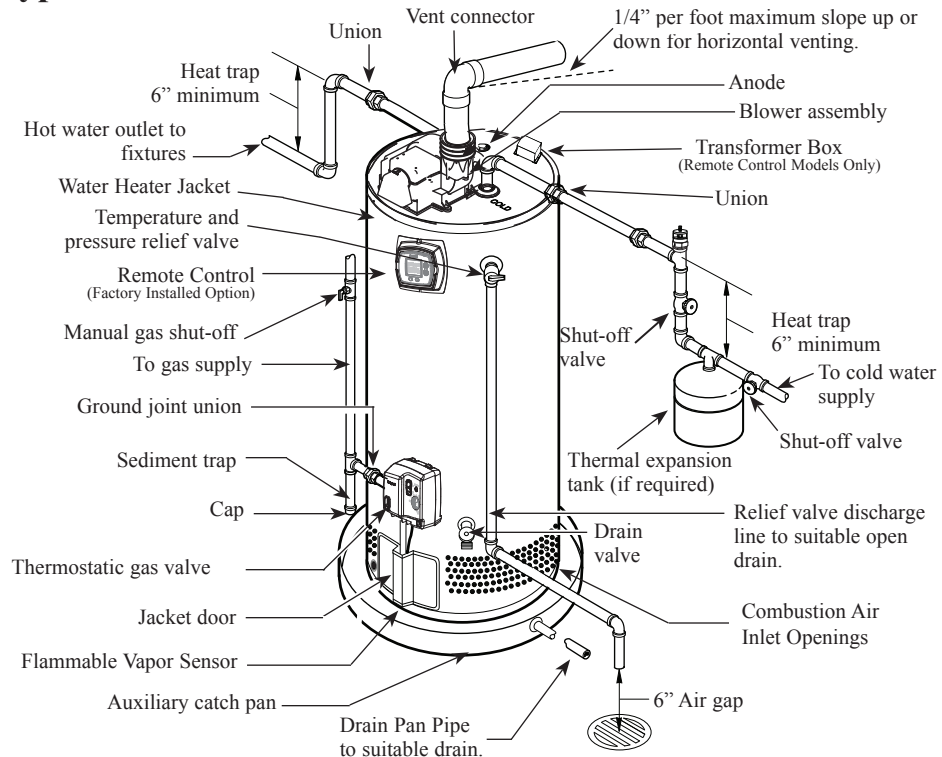

Installing the water heater

A new combination temperature and pressure relief valve, complying with the Standard for Relief Valves and Automatic Gas Shut-Off Devices for Hot Water Supply Systems, ANSI Z21.22, is supplied and must remain in the opening provided and marked for the purpose on the water heater. No valve of any type should be installed between the relief valve and the tank. Local codes shall govern the installation of relief valves.

Relief Valve

The pressure rating of the relief valve must not exceed 150 PSI(1034 kPa), the maximum working pressure of the water heater as marked on the rating plate.

The Btuh rating of the relief valve must equal or exceed the Btuh input of the water heater as marked on its rating plate.

Position the outlet of the relief valve above a suitable open drain to eliminate potential water damage. Piping used should be of a type approved for hot water distribution.

The discharge line must be no smaller than the outlet of the valve and must pitch downward from the valve to allow complete drainage (by gravity) of the relief valve and discharge line.

The end of the discharge line should not be threaded or concealed and should be protected from freezing. No valve of any type, restriction, or reducer coupling should be installed in the discharge line.

▲WARNING: The tank must be full of water before heater is turned on. The water heater warranty does not cover damage or failure resulting from operation with an empty or partially empty tank.

To Fill the Water Heater

Make certain that the drain valve is closed, then open the shut-off valve in the cold water supply line.

Open each hot water faucet slowly to allow the air to vent from the water heater and piping.

A steady flow of water from the hot water faucet(s) indicates a full water heater.

DO NOT allow the flammable vapour sensor to become submerged in water.

Condensation

Condensation can form on the tank when it is first filled with water. Condensation might also occur with a heavy water draw and very cold inlet water temperatures.

Drops of water falling on the burner can produce a sizzling or pinging sound.

This condition is not unusual, and will disappear after the water becomes heated. If, however, the condensation continues, examine the piping and fittings for possible leaks.

▲WARNING: DO NOT attempt to convert this water heater for use with a different type of gas other than the type shown on the rating plate. Such conversion could result in hazardous operating conditions.

Gas Supply

The branch gas supply line to the water heater should be clean 1/2" black steel pipe or other approved gas piping material.

A ground joint union or ANSI design certified semi-rigid or flexible gas appliance connector should be installed in the gas line close to the water heater. The Canadian Standards Association mandates a manual gas shut off valve: See CSA B149- Installation Code for complete instructions.

If flexible connectors are used, the maximum length shall not exceed 36"(91.4 cm) and must meet the requirements in ANSI Z21.24 - Connectors for Gas Appliances.

If lever type gas shut-offs are used, they shall be T-Handle type.

Compound used on the threaded joints of the gas piping must be of the type resistant to the action of LP gas. Use compound sparingly on male threads only.

Where a sediment trap is not incorporated

as part of the appliance, a sediment trap shall be installed downstream of the equipment shutoff valve as close to the inlet of the appliance as practical at the time of the appliance installation. The sediment trap shall be either a tee fitting with a capped nipple in the bottom outlet or other device recognized as an effective sediment trap.

DO NOT use excessive force (over 31.5 ft lbs.) (42.70 Nm) in tightening the pipe joint at the gas control (thermostat) inlet, particularly if teflon pipe compound is used, as the valve body may be damaged.

The inlet gas pressure to the water heater must not exceed 10.5" w.c.(2.6 kPa) for natural gas, or 14" w.c.(3.5 kPa) for LP gas.

For purposes of input adjustment, the minimum inlet gas pressure (with main burner on) is shown on the water heater rating plate. If high or low gas pressures are present, contact your gas supplier for correction.

▲WARNING: Never use an open flame to test for gas leaks, as property damage, personal injury, or death could result.

Leak Testing

The water heater and its gas connections must be leak tested at normal operating pressures before it is placed in operation.

- 1 Turn on the manual gas shut-off valve near the water heater.
- 2 Use a soapy water solution to test for leaks at all connections and fittings.

Bubbles indicate a gas leak that must be corrected.

The factory connections to the gas control (thermostat) should also be leak tested after the water heater is placed in operation.

Pressure Testing the Gas Supply System

The appliance and its individual shutoff valve must be disconnected from the gas supply piping system during any pressure testing of that system at test pressures in excess of 1/2 psi (3.5 kPa).

The appliance must be isolated from the gas supply piping system by closing its individual manual shutoff valve during any pressure testing of the gas supply piping system at test pressures equal to or less than 1/2 psi (3.5 kPa).

▲WARNING: Failure to install a water heater suitable for the altitude at the location it is intended to serve, can result in improper operation of the appliance resulting in property damage and/or producing carbon monoxide gas, which could result in personal injury, or death.

High Altitude

Input rating of this water heater is based on sea level operation. At higher elevations the actual input rate may be lower than the value listed on the rating label due to the derating of natural gas and LP gas. This water heater can be installed at elevation up to the elevation listed on the rating plate attached to the water heater without any change or modification.

Refer to the Venting Information tables on page 13 for minimum and maximum vent length.

Contact the local gas supplier for more information.

Installing the water heater

The water heater must be installed with the factory supplied blower assembly in place.

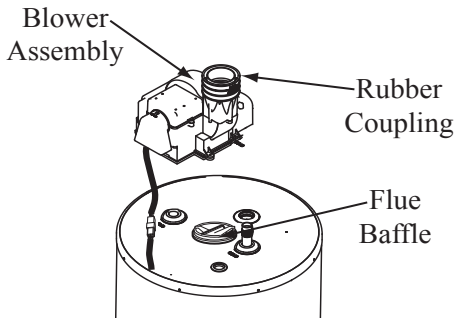

Blower Assembly Installation

Connect blower assembly with the electrical connector. Attach Blower Assembly to top pan using the six (6) screws provided (See diagram to the left). **DO NOT overtighten screws to ensure plastic does not crack.** Install rubber coupling (supplied in the box with water heater) on blower housing and secure it.

NOTICE: The Blower Assembly is model specific and only the blower assembly supplied should be used on this water heater.

⚠ DANGER: Failure to install the blower assembly and properly vent the water heater to the outdoors as outlined in the Venting section of this manual will result in unsafe operation of the water heater causing bodily injury, explosion, fire or death.

To avoid the risk of fire, explosion, or asphyxiation from carbon monoxide, NEVER operate the water heater unless it is properly vented and has adequate air supply for proper operation as outlined in the Venting section of this manual.

The vent pipe must overlap a minimum of ½" on each connection. It is important that the vent pipe engages fully into any pipe fitting and be kept in that position until the adhesive has fully cured. **DO NOT** drill or punch holes in the plastic pipe or fittings.

NOTICE: The vent piping must be connected to the blower assembly using the rubber coupling and supplied clamps. The vent pipe connections at the blower assembly must be leak tested with soap and water solution upon initial startup. Repair any leaks before allowing the water heater to operate.

NOTICE: This unit is equipped with a Flammable Vapour Sensor. **DO NOT** apply power until enough time has passed to allow the vapours from the primer and cement to dissipate.

Venting

The water heater must be vented to the outdoors as described in these instructions. **DO NOT** connect this water heater to an existing vent or chimney - it must be vented separately from all other appliances.

This water heater must be vented to the outdoors with a venting system that is certified to the Underwriter's Laboratories of Canada Standard, ULC-S636 (Current Edition).

The vent system must be installed in accordance with the vent system manufacturer's installation instructions.

The first 3 ft. (900 mm) from the appliance flue outlet must be readily accessible for visible inspection.

"It is not acceptable to interchange components of this system with another certified vent system or unlisted plastic pipe and fittings."

NOTICE: This unit must be vented using only 2" or 3" diameter PVC or CPVC pipe and fittings that are certified to ULC-S636.

The unit may be vented horizontally through a wall or vertically through the roof.

Vent pipe runs must be adequately supported along both vertical and horizontal lengths.

Maximum unsupported length is recommended to be no more than 6 feet (1.8 m).

It is imperative that the first hanger be located on the horizontal length immediately adjacent to the first 90-degree elbow from the vertical rise of vent pipe connected to the water heater.

The support method used should isolate the vent pipe from floor joists or other structural members to help prevent the transmission of noise and vibration.

DO NOT support, pin or otherwise secure the venting system in a way that restricts the normal thermal expansion and contraction of the chosen venting material.

If the water heater is being installed as a replacement for an existing power vented water heater, a thorough inspection of the existing venting system must be performed prior to any installation work.

- 1 Verify that the correct materials as detailed above have been used, and that the minimum or maximum vent length and terminal locations as detailed in this manual have been met.
- 2 Carefully inspect the entire venting system for any signs of cracks or fractures, particularly at the joints between elbows or other fittings and the straight length of vent pipe.
- 3 Check the system for signs of sagging or other stresses in the joints as a result of misalignment of any components in the system.
- 4 If any of these conditions are found, they must be corrected in accordance with the venting instructions in this manual before completing the installation and putting the water heater into service.

Vent Pipe Materials

NOTICE: This unit can be vented using only the following recommended pipe material.

2 inch: PVC (Schedule 40, ASTM D1785)

3 inch: PVC (Schedule 40, ASTM D1785)
or PVC (Schedule 40, Cellular Core, ASTM F891)

2 or 3 inch diameter pipe

CPVC (Schedule 40, ASTM F441)

The fittings, other than the TERMINATION, should be equivalent to the following:

PVC (Schedule 40 DWV, ASTM D2665)

CPVC (Schedule 40, ASTM F438)

Note: It is acceptable to interchange PVC and CPVC pipe and fittings.

NOTE: This water heater may be installed in attics provided ambient temperatures **DO NOT exceed 125°F (52°C)** and CPVC pipe and fittings are used for the entire vent system.

Vent pipe materials must be chosen based upon the ambient temperature where the water heater is installed and the location within the vent system. See chart below for material requirements.

	Ambient Installation Temperatures and Vent System Material Specifications		
	Below 100°F (38°C)	100°F (38°C) to 125°F (52°C)	
Models	0 to Max. ft. (0 to Max. m) Equivalent Vent System Length	0 to 10 ft. (0 to 3 m) Equivalent Vent System Length	10 ft. to Max. (0 m to Max.) Equivalent Vent System Length
40 and 50 Gallon	PVC or CPVC	CPVC	PVC or CPVC

Installing the water heater

Condensate Management and Vent Risers

There is no condensate collection and disposal required for Rheem water heaters under most conditions. Installations where the vent run is short or it runs through conditioned space in the home, such as basements or interior walls, do not typically cause condensation and will not require any condensation disposal methods regardless of vent pipe slope. Figure 1 shows the recommended vent pipe slope of no less than 1/8 inch per foot away from the water heater. Any condensation in the venting system will drain toward the vent termination. The blower pipe coupling features a capped drain port which is not needed in this case.

NOTICE: Vent riser fittings and pipe must be included in the total vent length calculation as described in the manual.

CAUTION: Make sure drain port cap is securely in place.

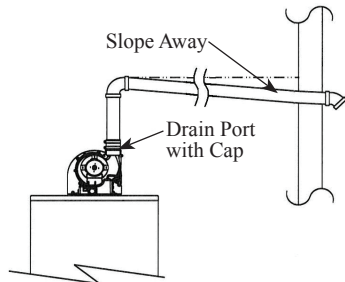

Figure 1

There are vent piping configurations, when combined with certain environmental conditions that can produce enough condensate to require collection and disposal. When a slope away from the water heater cannot be achieved and condensate handling is required in a horizontal vent system, the vent pipe should be sloped toward the water heater as shown in Figure 2.

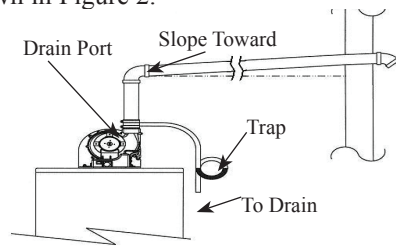

Figure 2

NOTICE: Some models are not supplied with a drainable coupling. If condensation is required, please contact the service department listed on the back of this manual.

- Remove drain port cap.
- Connect flexible condensate drain tube to the blower drain port.
- Loop the drain tube so that it has a circular trap. See Figure 3.
- Secure the top and bottom of the loop with wire ties or plastic zip ties as shown.
- **DO NOT** restrict any portion of the circular drain tube.
- Loop must be smooth and not collapse the tube.
- Fill circular drain tube with water to make sure combustion gases cannot vent into the room.

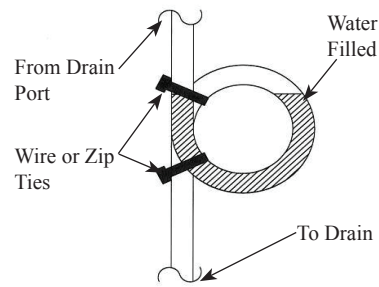

Figure 3

- Condensate collected must be discharged per local codes.
- **DO NOT** drain over public way or walkway.
- Refer to local codes for any condensate requirements.

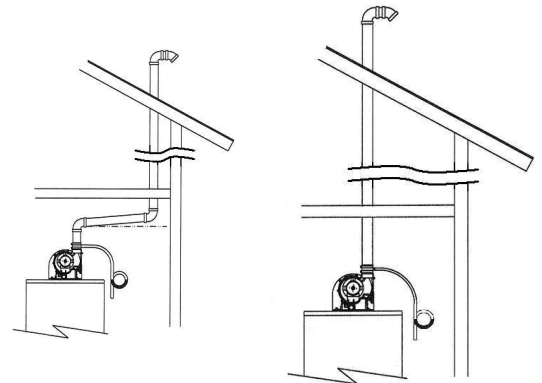

Figure 4

Figure 5

If the venting system is vertical and condensation handling is required, then the blower coupling drain port and tube must be used as described previously. Any horizontal portion of the vent pipe must slope toward the water heater at a minimum of 1/8 inch per foot so a water trap is not created. See Figures 4 & 5 as examples of a vertical installations with condensation removal tube and trap.

A vent riser is used when the vent termination cannot be located above grade or snow lines. Power vented water heaters installed with a vent riser should have a slope toward the water heater if the venting is long and passes through unconditioned spaces. It is recommended that these installations have the condensate collection and disposal method defined previously. Figure 6 shows a condition where a vent riser is necessary to meet the minimum clearance. Note that the vent pipe must slope back to the water heater so that a water trap is not created at the outside 90 degree elbow.

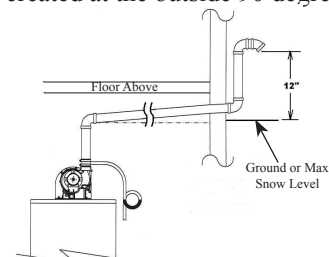

Figure 6

Maximum and Minimum Vent Lengths for Residential 40 & 50 Gallon Power Vents ONLY

Minimum vent length for 2" vent pipe is one (1) foot (30.4 cm) of vertical pipe, one (1) 90° elbow, and three (3) feet (0.91 m) of horizontal pipe.

Maximum Venting information for 2" Vents*

Number of 90° elbows with Vent	Number of 45° Elbows	Maximum Vent Pipe Length in Feet (ft) 0' - 2,000' (0 m -609 m)	Maximum Vent Pipe Length in Feet (ft) 2,001' (610 m) and above.
One (1)	None	44' (13 m)	24' (7.3 m)
One (1)	One (1)	41' (12.5 m)	21' (6.4 m)
Two (2)	None	38' (11.5 m)	18' (5.5 m)
Two (2)	One (1)	35' (10.7 m)	15' (4.5 m)
Three (3)	None	32' (9.8 m)	12' (3.6 m)

* For the 2" vent, one 90° elbow is approximately equal to 6 feet (1.8 m) of vent pipe. One 45° elbow is approximately equal to 3 feet (0.91 m) of vent pipe.

NOTICE: The mixing of 2" and 3" vent pipe is not recommended. If 3" pipe is used, a 2" to 3" reducer fitting is recommended at the rubber coupling.

A 2" (5 cm) or 3" (7.6 cm) Schedule 40 PVC 45° vent terminal must be used. Screens for both 2" and 3" vent terminals have been included.

Minimum vent length for 3" vent pipe is one (1) foot (30.4 cm) of vertical pipe, one (1) 90° elbow, and four (4) feet (1.21 m) of horizontal pipe.

Maximum Venting information for 3" Vents**

Number of 90° elbows with Vent	Number of 45° Elbows	Maximum Vent Pipe Length in Feet (ft) 0' - 2,000' (0 m -609 m)	Maximum Vent Pipe Length in Feet (ft) 2,001' (610 m) and above.
One (1)	None	95' (29 m)	75' (22.8 m)
One (1)	One (1)	92.5' (28 m)	72.5' (22.1 m)
Two (2)	None	90' (27.4 m)	70' (21.3 m)
Two (2)	One (1)	87.5' (26.7 m)	67.5' (20.5 m)
Three (3)	None	85' (26 m)	65' (19.8 m)
Three (3)	One (1)	82.5' (25 m)	62.5' (19 m)
Four (4)	None	80' (24.4 m)	60' (18.3 m)
Four (4)	One (1)	77.5' (24 m)	57.5' (17.5 m)
Five (5)	None	75' (22.8 m)	55' (16.7 m)

** For the 3" vent, one 90° elbow is approximately equal to 5 feet (1.52 m) of vent pipe. One 45° elbow is approximately equal to 2.5 feet (0.76 m) of vent pipe.

Installing the water heater

Additional Venting Requirements

Installations requiring less than one (1) foot of vertical pipe before the first elbow, subtract six (6) feet from the maximum vent length.

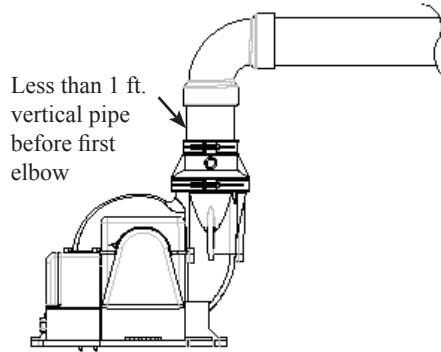

Minimum Vent Restrictor

Install the vent restrictor only at the minimum vent lengths listed on page 15.

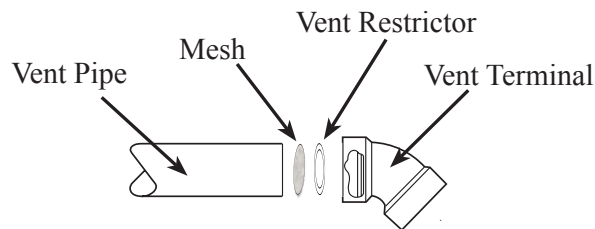

DO NOT use the vent restrictor for any other vent lengths.

Additional PVC Fittings Considerations

DO NOT Use

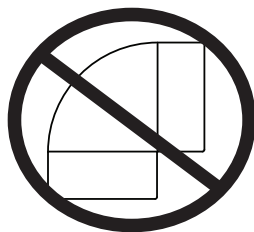

Short Sweep 90° Elbow

Good

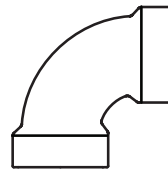

Standard 90° Elbow

Best

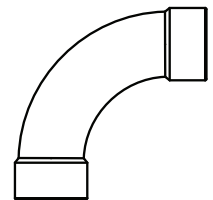

Long Sweep 90° Elbow

Vent Terminal Clearances

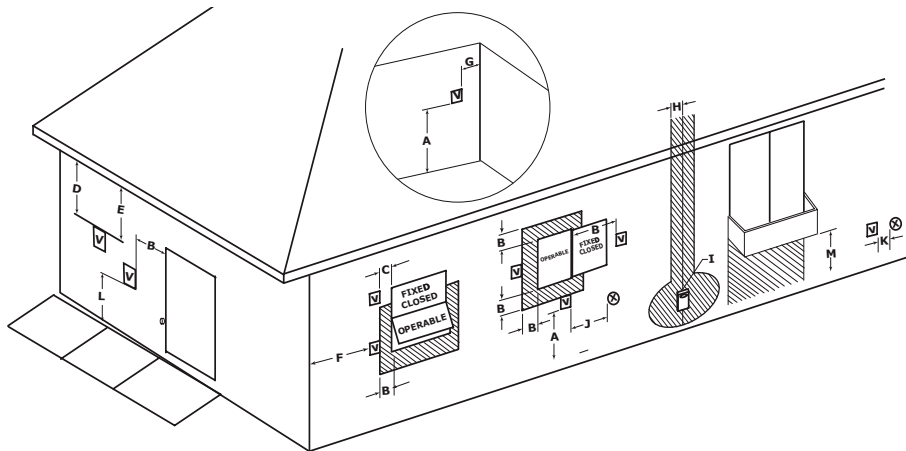

V = Vent Terminal X = Air Supply Inlet Area Where Terminal Is Not Permitted	
Canada Installations ²	
A - Clearance above grade, veranda, porch, deck or balcony	12 in. (30 cm)
B - Clearance to window or door that may be opened	6 in. (15 cm) for appliances ≤ 10,000 Btuh (3 kW), 12 in (30 cm) for 10,000 Btuh (3 kW) and ≤ 100,000 Btuh (30 kW), 36 in (91 cm) for appliances > 100,000 Btuh (30 kW)
C - Clearance to permanently closed window	*
D - Vertical clearance to ventilated soffit located above the terminal within a horizontal distance of 2 feet (61 cm) from the center line of the terminal	*
E - Clearance to unventilated soffit	*
F - Clearance to outside corner	*
G - Clearance to inside corner	*
H - Clearance to each side of centerline extended above meter/regulator assembly	3 ft (91 cm) within a height of 15 ft above the meter/regulator assembly
I - Clearance to service regulator vent outlet	3ft. (91cm)
J - Clearance to non mechanical air supply inlet to building or the combustion air inlet to any other appliance	6 in. (15 cm) for appliances ≤ 10,000 Btuh (3 kW), 12 in (30 cm) for appliances > 10,000 Btuh (3 kW) and ≤ 100,000 Btuh (30 kW), 36 in (91 cm) for appliances > 100,000 Btuh (30 kW)
K - Clearance to a mechanical air supply inlet	6 ft. (1.83 m)
L - Clearance above paved sidewalk or paved driveway located on public property	7 ft 92.13 M)†
M - Clearance under veranda, porch, deck, or balcony	12 in (30 CM)‡
<small> 1 In accordance with the current CSA B149.1 Natural Gas and Propane Installation Code. †A vent shall not terminate directly above a sidewalk or paved driveway that is located between two single family dwellings and serves both dwellings. ‡ Permitted only if veranda, porch, deck or balcony is fully open on a minimum of two sides beneath the floor. * For clearances not specified in ANSI Z223.1/NFPA or CSA-B149.1, one of the following shall be indicated: a) A minimum clearance value determined by testing in accordance with section 2.20, or b) A reference to the following footnote: "Clearance in accordance with local installation codes and the requirements of the gas supplier." </small>	

Installing the water heater

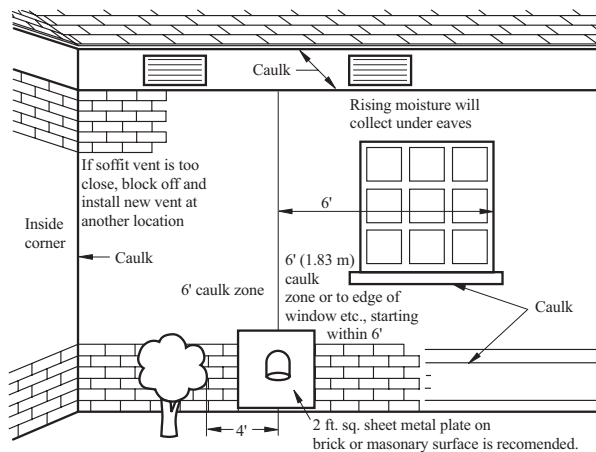

⚠ WARNING: Moisture in the flue gas will condense as it leaves the vent terminal. In cold weather this condensate can freeze on the exterior wall, under the eaves and on surrounding objects. Some discoloration to the exterior of the building is to be expected. However, improper location or installation can result in severe damage to the structure or exterior finish of the building.

Additional Considerations

- 1 **DO NOT** install vent terminal under any patio or deck.
- 2 To help prevent moisture from freezing on walls and under eaves, do not locate vent terminal on the side of a building with prevailing winter winds.
- 3 When terminating the vent pipe through brick or masonry surfaces, a rust-resistant sheet metal backing plate behind the vent termination is recommended. (See illustration.)
- 4 **DO NOT** locate vent terminal too close to shrubbery, as flue gasses may damage them.
- 5 Caulk all cracks, seams and joints within six (6) feet (1.83 m) of vent terminal.
- 6 All painted surfaces should be primed to lessen the chance of physical damage. Painted surfaces will require maintenance.
- 7 Insulate vent pipe exposed to cold conditions (attics, crawl spaces, etc.) with inflammable material to help prevent moisture from accumulating in vent pipe.
- 8 **DO NOT** extend exposed vent pipe outside of building.
- 9 If other vent terminal configurations are required, See "If You Need Service" section.

NOTICE: Follow the CAN/CSA B149.1 and vent system manufacturer's installation instructions for proper installation of the vent system.

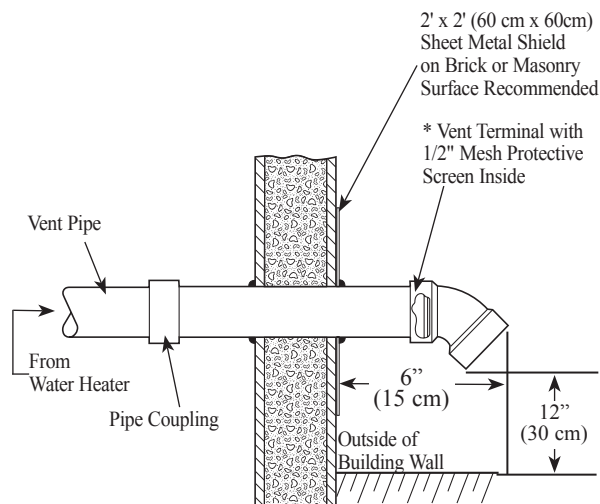

Horizontal Vent Installation

Once the vent terminal location has been determined, make a hole through the exterior wall to accommodate the vent pipe. Vent pipe must exit exterior wall horizontally only.

Insert a small length of vent pipe through the wall and connect the coupling as shown to the left.

Place the 1/2" mesh metal screen inside the terminal fitting and connect it as shown to the vent pipe on the exterior of the building.

Complete the rest of the vent pipe installation to the water heater's vent connector fitting on the blower outlet.

If necessary support horizontal run as previously mentioned.

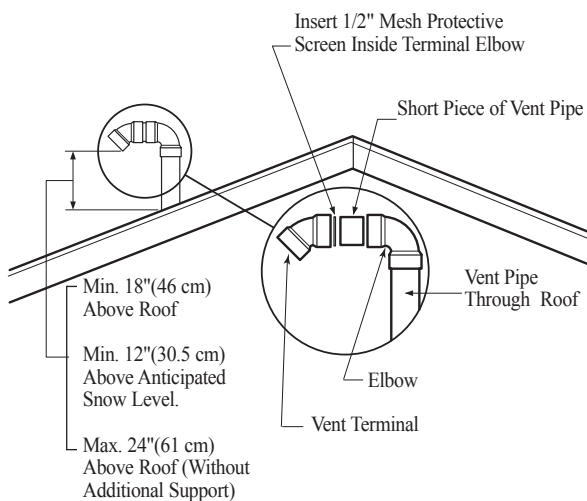

Vertical Vent Termination Location

The location of the vent terminal depends on the following minimum clearances and considerations (see illustration):

- 1** Minimum eighteen (18) inches (46 cm) above roof.
- 2** Minimum twelve (12) inches (30.5 cm) above anticipated snow level.
- 3** Maximum twenty-four (24) inches (61 cm) above roof level without additional support for vent.
- 4** Four (4) feet (1.2 m) from any gable, dormer or other roof structure with building interior access (i.e., vent, window, etc.).
- 5** Within (6) feet (1.8 m) of a mechanical air supply inlet.

Vertical Vent Installation

Once the vent terminal location has been determined, make a hole through the roof and interior ceiling to accommodate the vent pipe.

Complete the vent pipe installation to the water heater's vent connector fitting on the blower outlet.

Support vertical or horizontal lengths as previously mentioned.

Install adequate flashing where the vent pipe passes through the roof.

Determine the vent terminal height and cut vent pipe accordingly. Refer to the above section for proper vent terminal height.

Connect vent elbow onto vertical pipe through roof.

Connect short piece of vent pipe (approximately 3" (7.6 cm) long) to elbow, then insert 1/2" mesh metal screen into terminal elbow and join it to the short piece of vent pipe.

Installing the water heater

Wiring

If local codes permit, the water heater may be connected to electric service with the power cord provided (**DO NOT** use an extension cord). A grounding receptacle is required.

If local codes do not permit the use of cord connections, a 120 V, 50/60 Hz power supply, with suitable disconnecting means, must be connected to the black and white leads in the heater control enclosure.

A knock-out hole is provided to permit use of conduit or metal-clad cable connectors.

The maximum current draw is approximately 5.0 amps.

The water heater must be electrically grounded in accordance with local codes, or, in the absence of local codes, in accordance with latest edition of the Canadian Electrical Code CSA C22.1. Refer to Figure below for water heater internal wiring.

NOTE: It is not recommended that this unit be installed on a GFCI circuit.

Diagram Without Optional Electronic Display

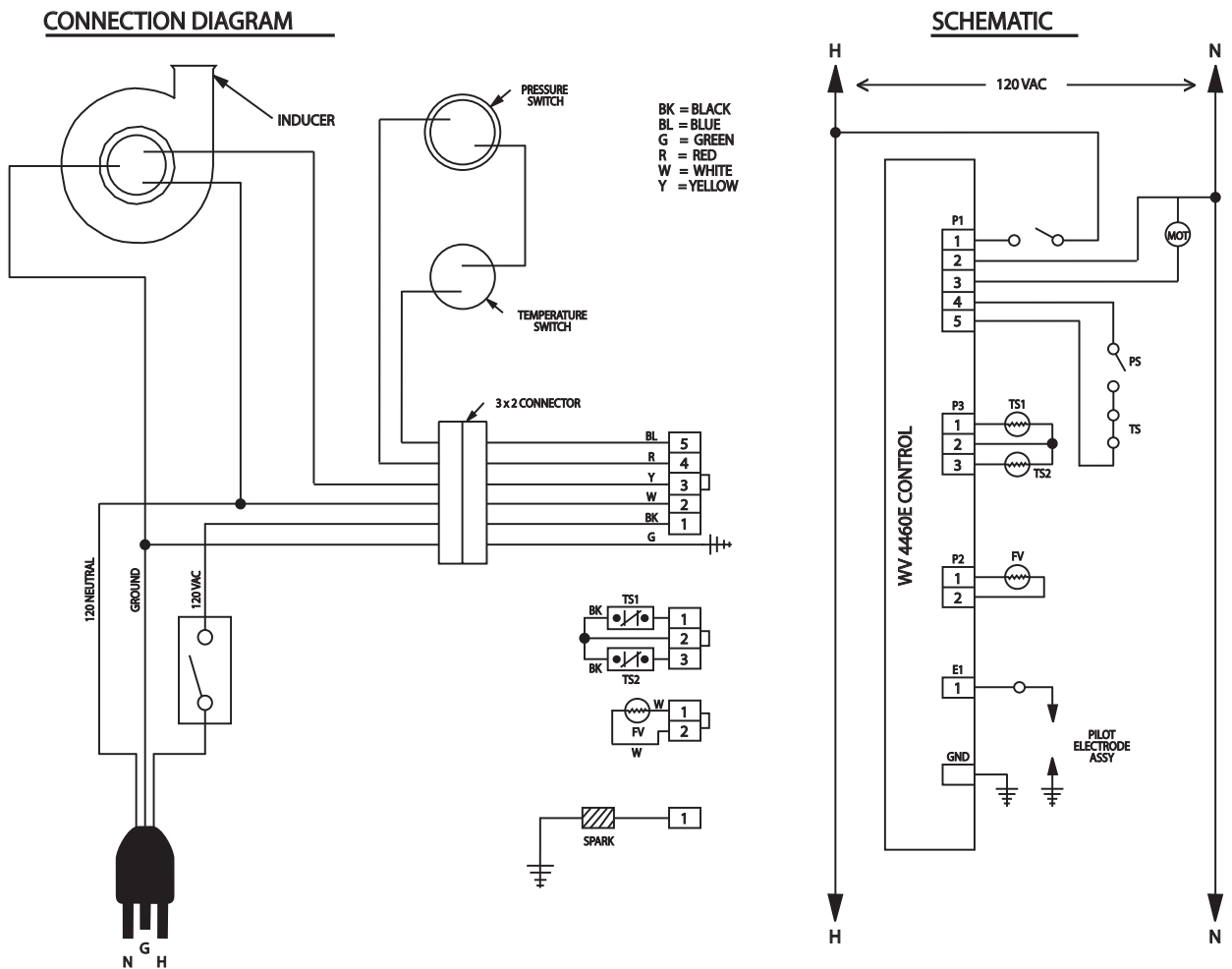

⚠ CAUTION! Label all wires prior to disconnection when servicing controls. Wiring errors can cause improper and dangerous operation. VERIFY PROPER OPERATION AFTER SERVICING!

Diagram With Optional Electronic Display

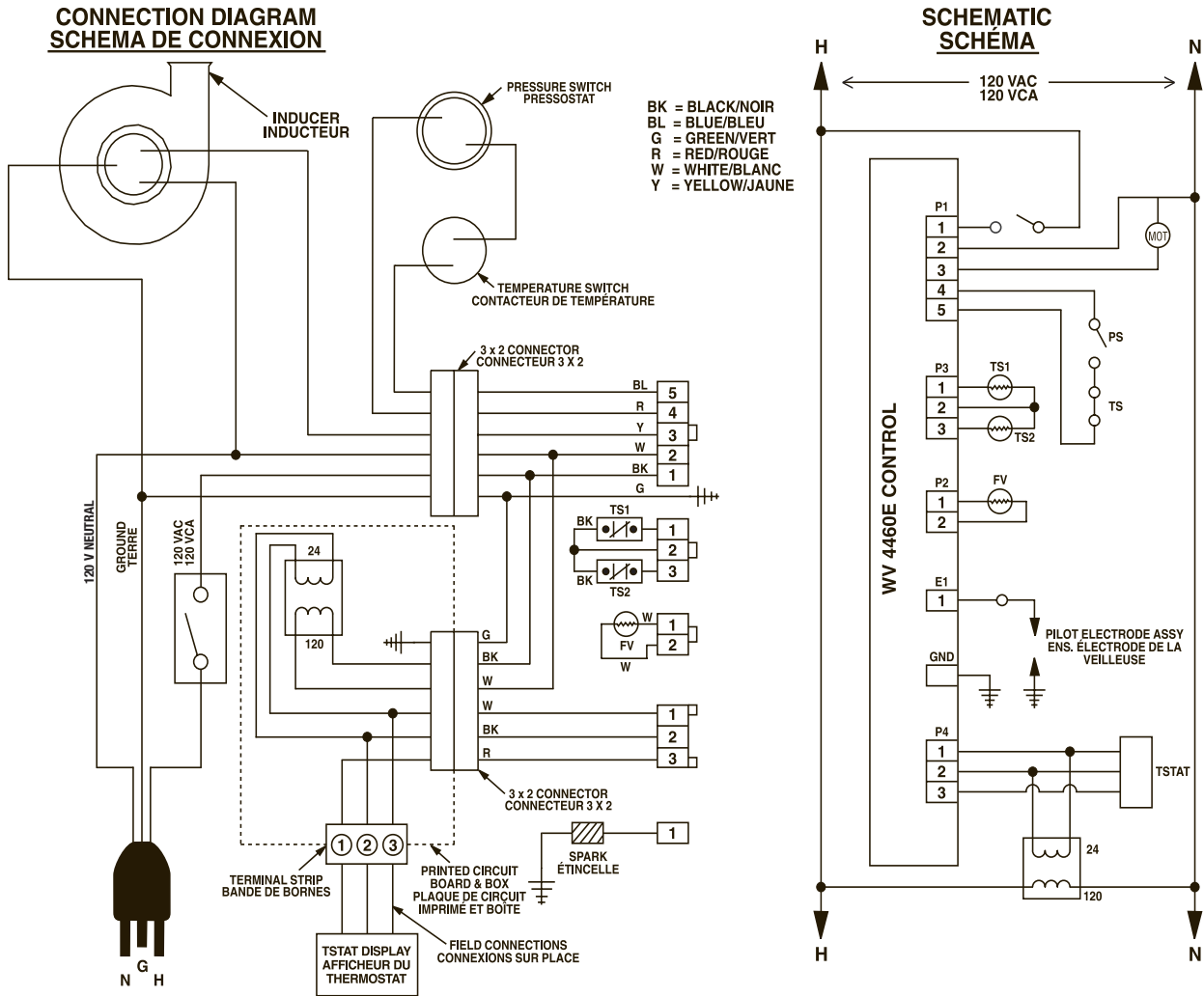

⚠ CAUTION! Label all wires prior to disconnection when servicing controls. Wiring errors can cause improper and dangerous operation. **VERIFY PROPER OPERATION AFTER SERVICING!**

Installing the water heater

⚠ WARNING: If local codes require external application of insulation blanket kits the manufacturer's instructions included with the kit must be carefully followed.

Insulation Blankets

Insulation blankets, available to the general public, for external use on gas water heaters are not necessary. The purpose of an insulation blanket is to reduce the standby heat loss encountered with storage tank heaters. This water heater meets or exceeds the National Appliance Energy Conservation Act standards with respect to insulation and standby loss requirements making an insulation blanket unnecessary.

The manufacturer's warranty does not cover any damage or defect caused by installation, attachment or use of any type of energy saving or other unapproved devices (other than those authorized by the manufacturer) into, onto or in conjunction with the water heater. The use of unauthorized energy saving devices may shorten the life of the water heater and may endanger life and property.

The manufacturer disclaims any responsibility for such loss or injury resulting from the use of such unauthorized devices.

⚠ CAUTION: If local codes require the application of an external insulation blanket to this water heater, pay careful attention to the following so as not to restrict the proper function and operation of the water heater:

- **DO NOT** cover the operating or warning labels attached to the water heater or attempt to relocate them on the exterior of insulation blanket.
- **DO NOT** apply insulation to the top of the water heater. This will interfere with the safe operation of the blower assembly.
- **DO NOT** cover the burner access door, jacket door, gas control (thermostat)/gas valve or pressure and temperature relief valve.
- **DO NOT** apply insulation to the bottom of the water heater or the area where the combustion air inlet openings and Flammable Vapour Sensor are located. This area must be unobstructed so as not to restrict combustion air flow to the burner or operation of the sensor.
- Inspect the insulation blanket frequently making certain it has not sagged and it is not restricting the air flow to the combustion air inlet openings (perforation holes) or the Flammable Vapour sensor located around the lower perimeter of the water heater jacket. This could result in an unsafe operating condition.

Hot and Cold Pipe Insulation Installation

NOTICE: If pipe insulation is used, ensure that the thickness does not exceed ½" (1.3 cm). Insulation thicker than ½" (1.3 cm) can interfere with the Blower Assembly Dilution Air Holes.

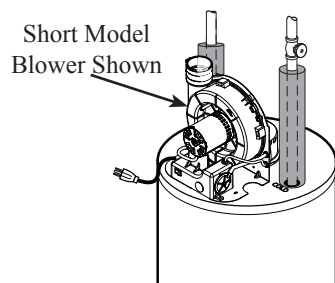

Typical vertical piping arrangement

For increased energy efficiency, some water heaters have been supplied with two 24" (61 cm) sections of pipe insulation.

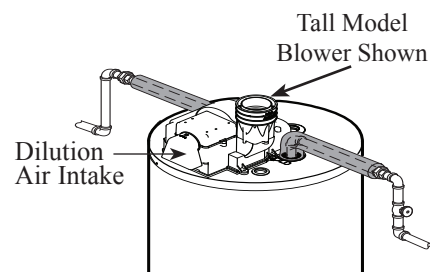

Typical horizontal piping arrangement

Please install the insulation, according to the illustrations above, that best meets your requirements.

Installing the User Display

The following instructions apply only to water heater models factory supplied with the electronic display option.

IMPORTANT NOTICE: This electronic display cannot be added to a water heater not supplied from the factory with an electronic display.

Components supplied with user display models:

- Optional Water Heater Mounting Bracket – AP14752
- 12 feet, 18 AWG Thermostat Wire – AP14820
- Optional Mounting Tape – AP14819
- Transformer Enclosure – AP14875
- Screw, #8 x ½" Self Drilling Qty 2 AP5925GS
- User Display – AP14697

Installation Instructions:

⚠ CAUTION: Turn the switch on the blower to the "off" position and disconnect power to the water heater before proceeding!

1. Locate the electrical connection for the Transformer Enclosure on the top of the water heater. This electrical connection features a white 6-pin plug and white heat shrink.

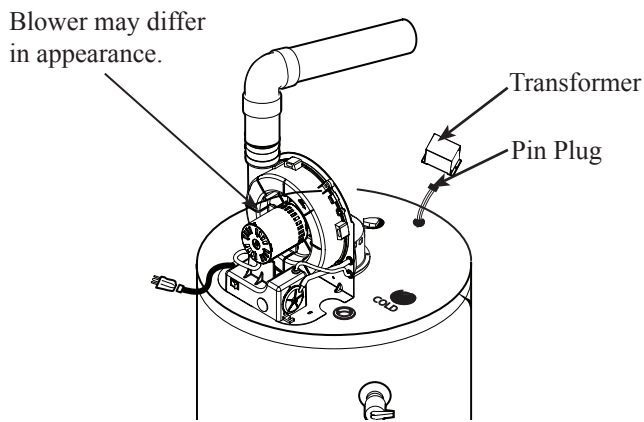

2. The Transformer Enclosure features a 6-pin connection located on the circuit board inside the enclosure. Attach the top pan harness connector to this 6-pin connector in the correct orientation.



3. Locate the two screw pilot holes on the water heater top to attach the Transformer Enclosure to the top pan. Position the enclosure so the terminal strip opening is visible from the front of the water heater. Secure enclosure to top pan with screws provided in the User Display Mounting Kit without pinching any wires.

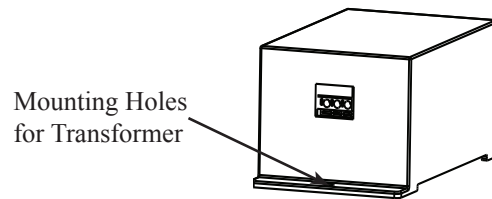

NOTICE: DO NOT over tighten to avoid cracking plastic enclosure.

4. Determine where the User Display will be located. The display can be attached to the water heater jacket with supplied Water Heater Mounting Bracket or mounted remotely to a wall via the wall plate up to 100 feet away using 18 AWG solid copper thermostat wire. Any installation location over 12 feet from the water heater will require additional thermostat wire. (Not supplied.)
5. If remote mounting, go to step 19.
6. Cut enough thermostat wire from the 12 feet provided to connect the front mounted display to the Transformer Enclosure located on the top pan.
7. Strip ½" insulation from the 3 wires on both ends. The wire provided is standard 3-wire with the colors GREEN, RED and WHITE.
8. Connect one end of the wire to the Transformer Enclosure spring terminal strip. From left to right colors shall be GREEN – RED – WHITE. Wires should easily insert into the terminal strip. If required for wire insertion or removal, use small flat blade screw driver to press the tab located below each wire hole.
9. Remove two strips of Display Mounting Tape and attach to the inside flanges of the Water Heater Mounting Bracket.

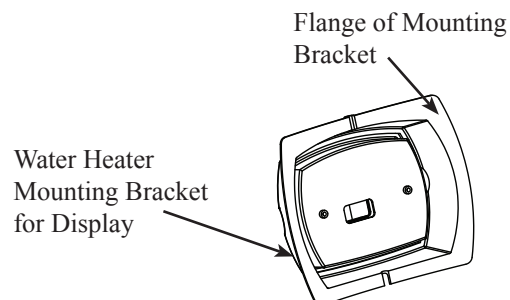
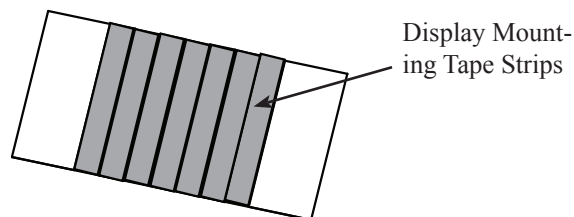

Installing the Optional User Display

10. The Water Heater Mounting Bracket features a wiring slot on the top flange and an opening for the wire. Pass the thermostat wire through the Water Heater Mounting Bracket opening.
11. Clean any dust or dirt from water heater jacket to allow proper tape adhesion.
12. Remove tape backing and carefully attach to the heater jacket above the Rheem logo. Allow the thermostat wire to be positioned in the wire slot located on the bracket top flange.

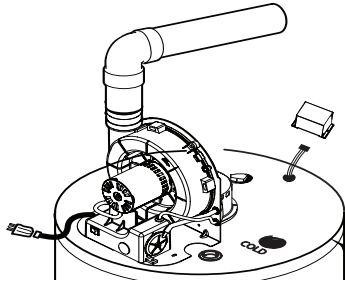

13. The User Display will be mounted to the plastic Water Heater Mounting Bracket.
14. Separate wall plate from the User Display by removing battery cover and carefully pull wall plate from display.

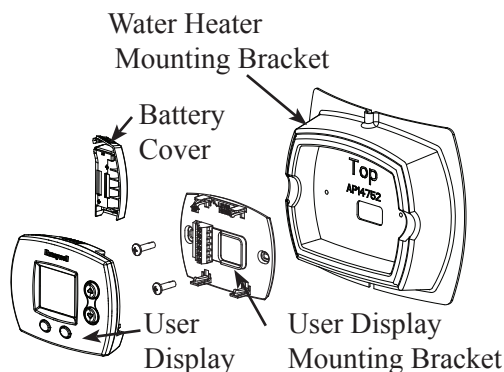

NOTICE: The battery backup option is not available on this model.

15. Replace battery cover.
16. Attach display wall plate to heater bracket using the two #6 x 1/2" Type A screws provided in User Display Mounting Kit. Wire should pass through display wall plate opening.
17. GO TO STEP 26.
18. Remote mounting will not require the Display to Heater Bracket or Display Mounting Tape. The bracket may be kept for future use or recycled.
19. Choose mounting location and route thermostat wire to this location.
20. Separate wall plate from the User Display by removing battery cover and carefully pull wall plate from display.
21. Replace battery cover.
22. Pass thermostat wire through wire hole in wall plate.
23. Use mounting holes on wall plate to mark wall hole locations.
24. Drill 3/16" holes and install wall anchors if required.
25. Use two #6 x 1" Type A screws provided in the User Display box to attach wall plate to surface.
26. Connect thermostat wire to wall plate as follows:
 - Top Terminal - GREEN - Data Communication
 - Middle Terminal - RED - Power
 - Bottom Terminal - WHITE - Common
27. Attach Thermostat Display to wall plate.
- ⚠ ATTENTION: Leave peel off screen protector on the User Display for customer to review and remove.**
28. Connect power to water heater
29. Turn on water heater and allow to heat.
30. Check thermostat display for proper display and function.

User Display Features

Your water heater includes a user display for easy local or remote water heater programming. The user display features:

- Water heater temperature setpoint control
- Large, clear, backlit display is easy to read-even in the dark
- Displays relative available hot water
- Service needed indicator.

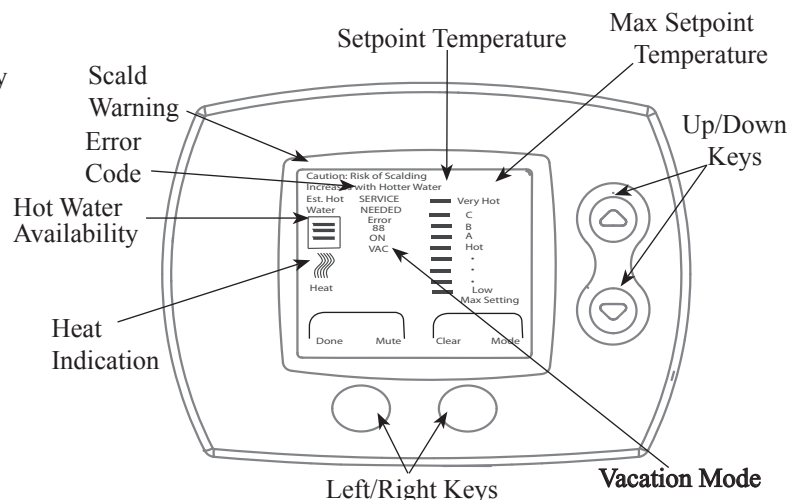

Water Heater Optional User Display - Operation Instructions

Display Temperature Setting Limits

After power on, all segments on the LCD will be displayed for 2 seconds, (See Diagram A) followed by software revision shown for 2 seconds (See Diagram B).

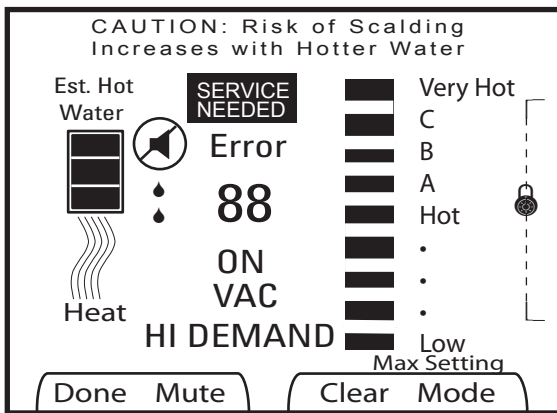

Diagram A

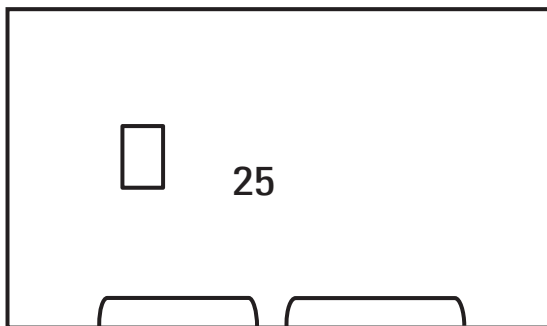
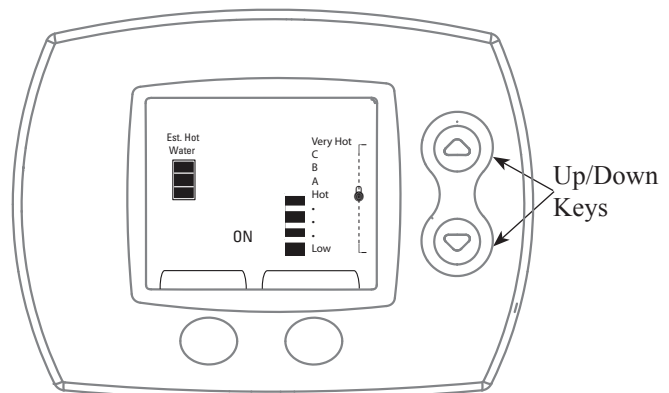

Diagram B

User Mode is entered after all required data is received from the appliance when powered-up. The display shows temperature setpoint, estimated amount of hot water and maximum temperature setpoint. Heat symbol is turned on when heating cycle is active. Scald warning starts flashing whenever the adjusted setpoint exceeds the "Hot" setting and becomes solid after 30 seconds of flashing.

Unlocking the User Display

The user display includes a display lock that will prevent accidental adjustments to the water heater. To unlock the display, hold down the UP and DOWN arrow buttons until the lock icon flashes and disappears. The display can now be adjusted. The display will automatically relock if no button presses are detected within a 60 second period.



Display Temperature Setting

Water heater setpoint temperature is shown using vertical bars on the display. The more bars shown the higher the setpoint temperature. Use the UP or DOWN arrows to select the desired setpoint temperature. The top bar indicates the water heater setpoint. The picture on the right shows a setpoint of "A".

Notice: When the temperature is set above "HOT", the display will show the "Risk of Scalding Caution".

When the desired setpoint is shown on the display, press the "Done" button below the display. The user display will then lock to prevent accidental adjustments.

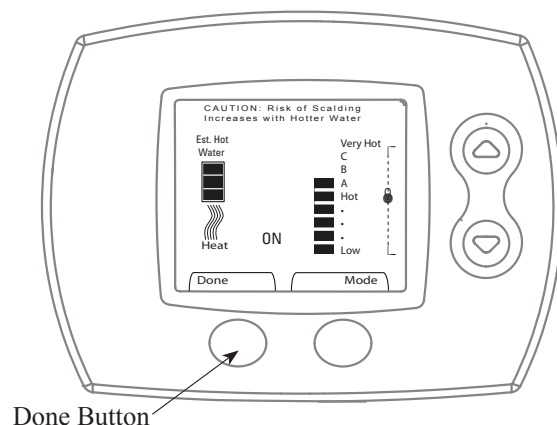

Water Heater Optional User Display - Operation Instructions

Display Temperature Setting Limits

The user display setpoint temperature cannot exceed maximum water heater valve setpoint temperature at any time. Max Setting icon appears when the user display setpoint exceeds the water heater gas valve knob setpoint.

The water heater gas valve knob below is set to HOT therefore the user display shows Hot as the maximum available setpoint. The customer in this example has chosen to set the temperature to Hot. When the user display is set to the maximum available setpoint, the Max Setting message will appear on the user display.

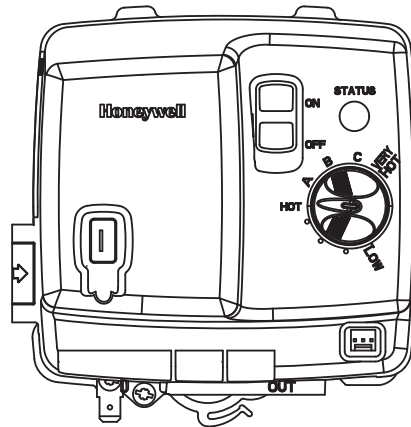

Water Heater Gas Valve

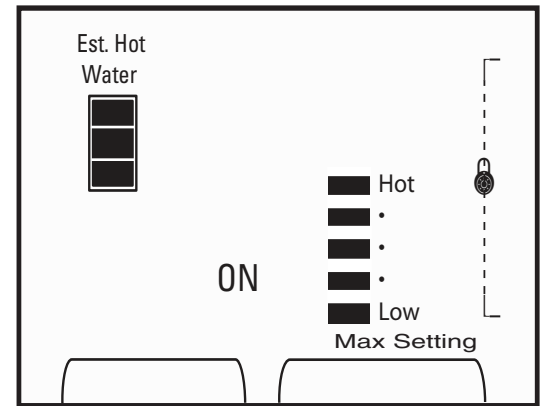

User Display

The water heater gas valve knob below is set to VERY HOT therefore the user display shows Very Hot as the maximum available setpoint. The customer in this example has chosen to set the temperature between Low and Hot. With this gas

valve knob setting, the full range of temperature setpoints is available at the user display. See Figure on left below.

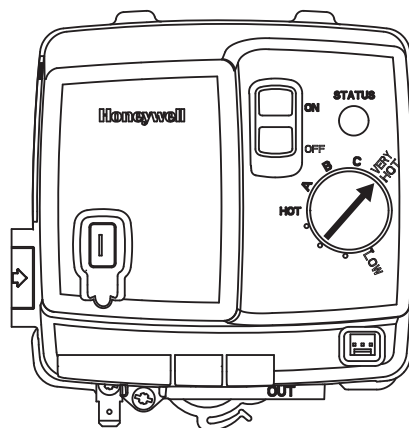

Water Heater Gas Valve

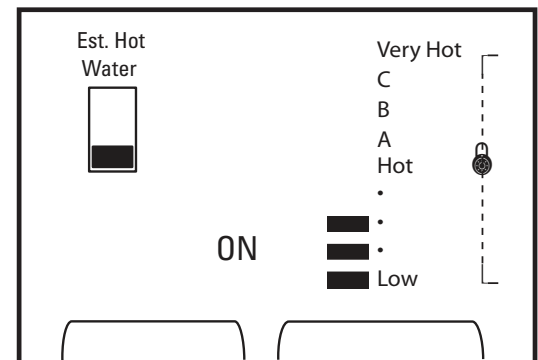





User Display

Installing the water heater continued.....

Estimated Hot Water

Three bars shown on the user display are an estimate of hot water available relative to the temperature setpoint. The chart below describes what each symbol means.

<p>Est. Hot Water</p> 	<p>Tank is full of hot water</p>
<p>Est. Hot Water</p> 	<p>Two thirds of the tank volume available</p>
<p>Est. Hot Water</p> 	<p>One third of the tank volume available</p>
<p>Est. Hot Water</p> 	<p>No hot water available</p>

Vacation Mode

The user display features a vacation mode which sets the water heater temperature to Low. The user display toggles between On and Vacation Modes when "Mode" key is pressed. Note that the Estimated Hot Water symbol shows no hot water available when in VAC mode. To return the water heater to normal "ON" mode, unlock the display and press the Mode button.

Error Display

When an error message is received from the water heater, the "SERVICE NEEDED" icon flashes. See the screen example below. Call your water heater contractor.

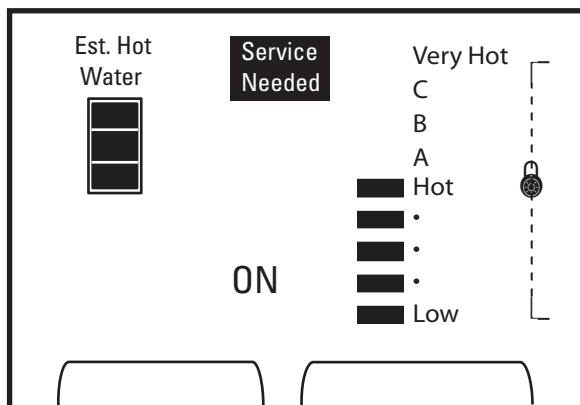
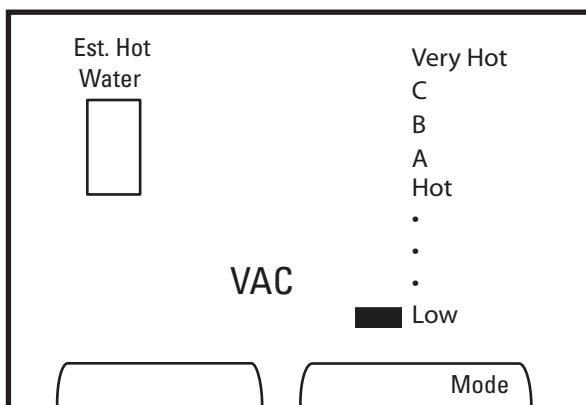

Installing the water heater

Heat Traps

For increased energy efficiency, some water heaters have been supplied with factory installed 3/4" NPT heat traps in the hot outlet line and cold water inlet line.

These heat traps may require a minimum of one (1) 90° 3/4" NPT elbow and may require an additional 90° 3/4" NPT elbow or a 3/4" coupling depending on your installation needs. See Illustration of nipples and heat traps on page 38.

During Installation of this water heater.....

DO

- DO** check inlet gas pressure to ensure that it is within the range specified on the rating plate.
- DO** provide adequate air for combustion and ventilation as discussed in the Use and Care Manual and the CAN/CSA B 149.1
- DO** maintain proper clearances to combustibles as specified on the rating plate.
- DO** allow enough time for joint cement vapours to dissipate BEFORE applying power to the water heater.
- DO** ensure that the venting system complies with the guidelines found in the Use and Care Manual and Section 7 of CAN/CSA B149 Natural Gas and Propane Installation Code
- DO** contact a qualified service technician if the main burner will not stay lit. The burner chamber is designed to be sealed utilizing a gasket and tamper resistant screws.

DON'T

- DON'T** block or restrict Combustion Air Inlet Openings or the Flammable Vapour Sensor located around the lower portion of the water heater jacket.
- DON'T** block or restrict the Blower Assembly Dilution Air holes (see diagram to the left).
- DON'T** remove the Burner Access Door unless absolutely necessary. This should only be done by a qualified service technician. A new burner access door gasket must be installed on any burner access door that has been removed.
- DON'T** install this water heater where standing water may occur. The base of the water heater is meant to be mounted on a dry surface.
- DON'T** allow cleaners, solvents, or other materials to come into contact with the Flammable Vapour Sensor.
- DON'T** operate the water heater if the sight glass or burner access door grommet is damaged or broken (See below).

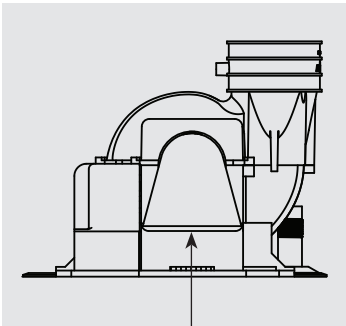

Location of Dilution Air Inlet.
Tall Models

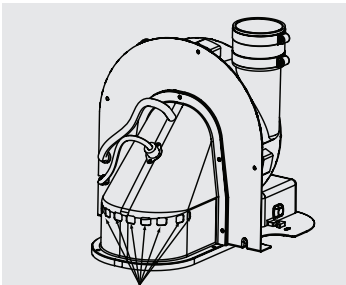

Location of Dilution Air Holes
Short Models

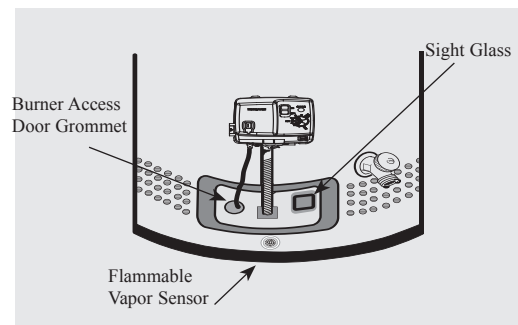

Installation Checklist

A. Water Heater Location

- Close to area of vent.
- Indoors and protected from freezing temperatures.
- Proper clearance from combustible surfaces observed and water heater not installed on carpeted floor.
- Sufficient fresh air supply for proper operation of water heater.
- Air supply free of corrosive elements and flammable vapours.
- Provisions made to protect area from water damage.
- Sufficient room to service heater.
- Combustible materials, such as clothing, cleaning materials, rags, etc. clear of the base of the heater.
- Clearances of 1”(2.54 cm) from combustion air inlet openings observed
- Flammable vapour sensor is not blocked.

B. Water Supply

- Water heater completely filled with water.
- Air purged from water heater and piping.
- Water connections tight and free of leaks.

C. Gas Supply

- Gas line equipped with shut-off valve, union and sediment trap.
- The required inlet gas pressure to the water heater is shown on the water heater rating plate.
- Pressure test as Required in B149.
- Soap and water solution used to check all connections and fittings for possible gas leak.
- Gas Company inspected installation (if required).

D. Relief Valve

- Temperature and Pressure Relief Valve properly installed and discharge line run to open drain.
- Discharge line protected from freezing.

E. Venting

- Heater vented separately from all other appliances.
- Flue baffle properly hung in top of heater's flue.
- Blower assembly properly installed.
- Proper materials and techniques used in vent assembly.
- Vent pipe properly secured to blower housing.
- Vent pipe supported at required intervals.
- Appropriate minimum clearances observed.
- Precautions taken to prevent moisture damage around vent termination.
- Vapours from vent pipe cement and primer have dissipated prior to applying electrical power.

F. Wiring

- Correct power supply (120 V).
- Electrical connections tight.
- Heater properly grounded and proper polarity observed.

Supplemental instructions for gas water heaters installed in potable water/space heating applications.

Local codes or plumbing authority requirements may vary from the instructions or diagrams provided in this manual and take precedent over these instructions.

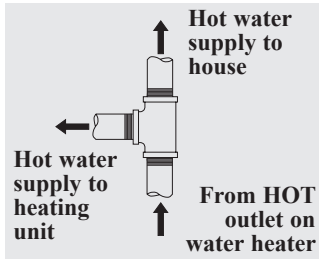

Tee fitting for vertical hot water supply lines.

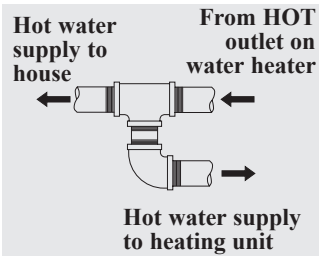

Tee fitting for horizontal hot water supply lines.

Combination Potable Water and Space Heating Application

Tee fitting must be installed as shown. This ensures that any air in the water lines will be purged through the domestic water faucets and showers.

⚠ DANGER: When this system requires water for space heating at elevated temperatures (above 125°F [52°C.]), a mixing valve complying with the Standard for Temperature Actuated Mixing Valves for Hot Water Distribution Systems, ASSE 1017 must be installed in the hot water supply line to the house in order to reduce the scald hazard potential. Water Heaters for combination water/space heating shall not be used in space-heating-applications only

⚠ DANGER: Any piping or components used in the installation of this water heater in a combination potable and space heating application must be suitable for use with drinking water.

NOTICE: Suitable for combination water (potable) heating and space heating and not suitable for space heating applications only.

⚠ DANGER: If this water heater is installed in an application intended to supply domestic hot water needs and hot water for space heating purposes, **DO NOT** connect the heater to an existing heating system that have previously been used with a non drinking water system. Toxic chemicals such as those used for boiler treatment may be present and will contaminate the drinking water supply causing possible health risks. Never introduce toxic chemicals, such as those used for boiler treatment, into this system.

Typical Piping Diagram for Combination Potable/Space Heating Installation

Nominal 3/4" size mixing or tempering valve (refer to warning above). Follow mixing or tempering valve manufacturer's instructions for installation of the valve.

Spring loaded check valve in heating unit hot water supply line and cold water return line (not supplied with water heater)

NOTE: This check valve is incorporated in some heating units. Refer to the installation instructions supplied with specific heating unit to determine if it is required.

Isolation valve in hot water supply line to heating unit (not supplied with water heater)

See diagrams above for proper pipe application for vertical or horizontal supply lines.

Temperature and Pressure Relief Valve, tie to location approved by local code

Gas line to water heater

Temperature and pressure relief valve discharge line

Gas Control (Thermostat)

Water Heater drain pan installed in accordance with the Local and State Code

Water Heater to be in accordance with the Local and State Energy Code

All water piping shall be insulated in accordance with Local and State Energy Code.

Minimum of 2'-0" developed length of 3/4" pipe.

Air vent

3/4" Tempered domestic hot water supply to house.

Pressure Gauge

3/4" Check Valve with 1/8" Hole
3/4" Shut-Off Valve (Typ.)

← 3/4" cold water supply

3/4" Shut-Off Valve (Typ.)

Heat Trap 6" Min.

2 Gallon Thermal Expansion Tank (if required-not supplied with water heater)

Hot water to space heater

Hot water coil

All bronze pump.

Check valve internal in pump.

Air bleed valve.

Water Sample Tap.

Hot water to space heater

Hot water coil

All bronze pump.

Check valve internal in pump.

Air bleed valve.

Water Sample Tap.

Hot water to space heater

Hot water coil

All bronze pump.

Check valve internal in pump.

Air bleed valve.

Water Sample Tap.

Hot water to space heater

Hot water coil

All bronze pump.

Check valve internal in pump.

Air bleed valve.

Water Sample Tap.

Hot water to space heater

Hot water coil

All bronze pump.

Check valve internal in pump.

Air bleed valve.

Water Sample Tap.

Hot water to space heater

Hot water coil

All bronze pump.

Check valve internal in pump.

Air bleed valve.

Water Sample Tap.

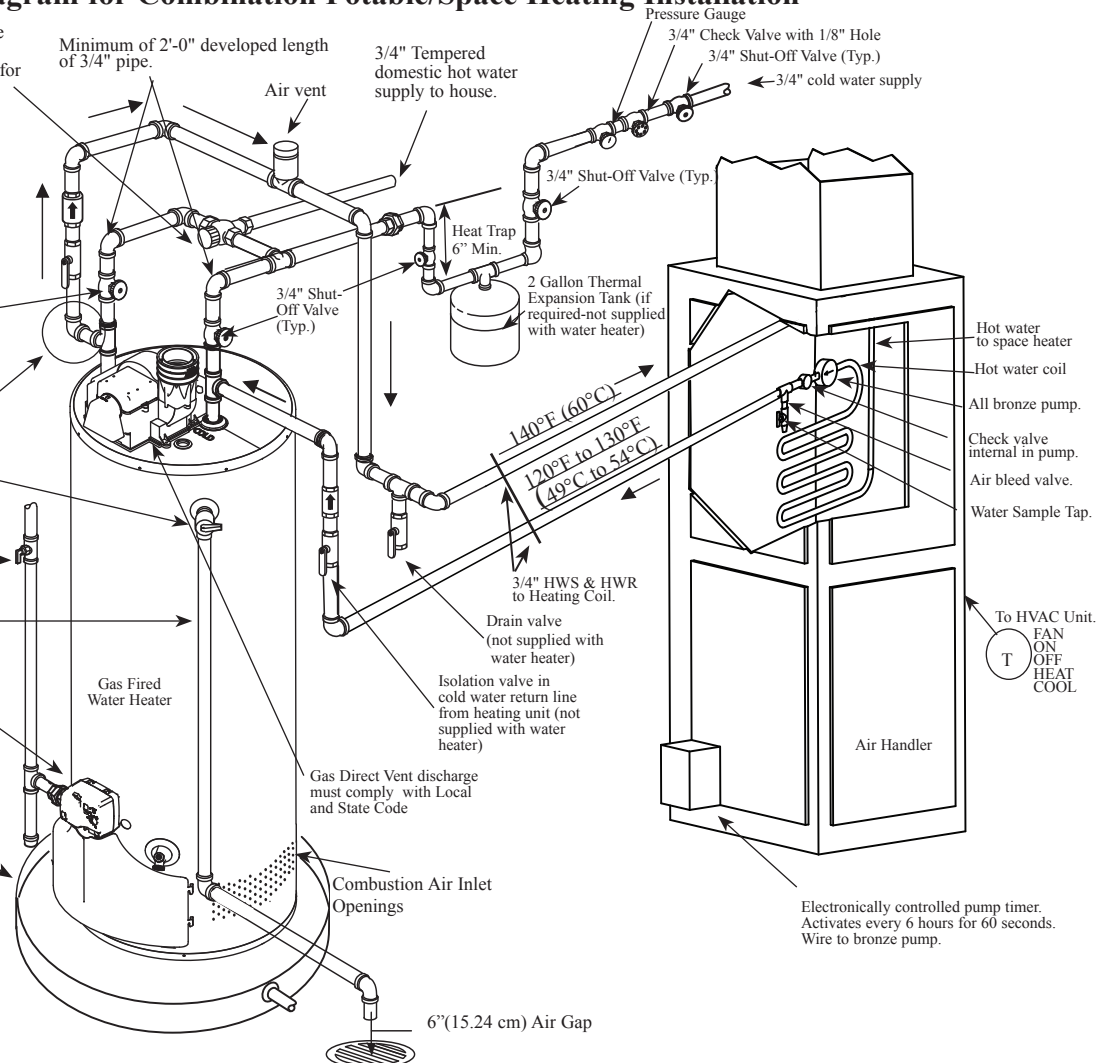

Electronically controlled pump timer. Activates every 6 hours for 60 seconds. Wire to bronze pump.

Lighting the water heater

Before operating this water heater, be sure to read and follow the instructions on the label pictured below and all other labels on the water heater, as well as the warnings printed in this manual. Failure to do so can result in unsafe operation of the water heater resulting in property damage, personal injury, or death. Should you have any problems reading or following the instructions in this manual, STOP, and get help from a qualified person.

FOR YOUR SAFETY READ BEFORE OPERATING

▲ WARNING: If you do not follow these instructions and use the Use & Care Manual instructions exactly, a fire or explosion may result causing property damage, personal injury or loss of life.

- A. This appliance is equipped with an ignition device which automatically lights the pilot. **DO NOT** try to light the pilot by hand.
- B. BEFORE PUTTING THIS APPLIANCE INTO SERVICE - Smell all around the appliance area for gas. Be sure to smell next to the floor because some gas is heavier than air and will settle on the floor.
- WHAT TO DO IF YOU SMELL GAS
- **DO NOT** try to light any appliance.
 - **DO NOT** touch any electric switch;
 - **DO NOT** use any phone in your building.
 - Immediately call your gas supplier from a neighbor's phone. Follow the gas suppliers instructions.
- If you cannot reach your gas supplier, call the fire department.
- C. Use only your hand to turn the gas control knob. Never use tools. If the knob will not turn by hand, do not try to repair it, call a qualified service technician. Force or attempted repair may result in fire or explosion.
- D. **DO NOT** use this appliance if any part has been under water. Immediately call a qualified installer or service agency to replace a flooded water heater. Do not attempt to repair the unit! It must be replaced!

OPERATING INSTRUCTIONS

1. Stop! Read the safety information above on this label.
2. Slide the "ON/OFF" switch located on the gas valve to the "OFF" Position.
3. Toggle the "ON/OFF" switch located on the blower assembly to the "OFF" position.
4. Turn off all electric power to the appliance.
5. Set the valve thermostat dial to "LOW".
6. This appliance has an automatic spark ignition system. **DO NOT** attempt to light the pilot by hand.
7. Wait five (5) minutes to clear out any gas. If you smell gas, stop! Follow "B" in the safety information above on the label. If you do not smell gas, go to the next step.
8. Turn on electric power to the appliance.
9. Toggle the "ON/OFF" switch located on the blower assembly to the "ON" position.
10. Slide the "ON/OFF" switch located on the gas valve to the "ON" position.
11. Set the thermostat dial to the desired setting.
12. If the appliance will not operate, follow the instructions "TO TURN OFF GAS TO APPLIANCE" and call your service technician or gas supplier.

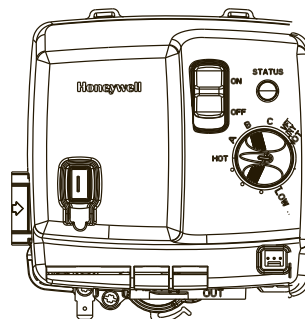

TO TURN OFF GAS TO APPLIANCE

1. Turn off all electric power to the appliance if service is to be performed.
2. Close manual gas shut-off valve.

Operating the water heater

▲ CAUTION: Hydrogen gas can be produced in a hot water system served by this water heater that has not been used for a long period of time (generally two weeks or more). **HYDROGEN GAS IS EXTREMELY FLAMMABLE!!** To dissipate such gas and to reduce risk of injury, it is recommended that the hot water faucet be opened for several minutes at the kitchen sink before using any electrical appliance connected to the hot water system. If hydrogen is present, there will be an unusual sound such as air escaping through the pipe as the water begins to flow. **DO NOT** smoke or use an open flame near the faucet at the time it is open.

Safety Precautions

- A** Do turn off manual gas shut-off valve if water heater has been subjected to over heating, fire, flood, physical damage or if the gas supply fails to shut off.
 - B** **DO NOT** turn on water heater unless it is completely filled with water.
 - C** **DO NOT** turn on water heater if cold water supply shut-off valve is closed.
 - D** **DO NOT** allow combustible materials such as newspaper, rags or mops to accumulate near water heater.
 - E** **DO NOT** store or use gasoline or other flammable vapours and liquids, such as adhesives or paint thinner, in vicinity of this or any other appliance. If such flammables must be used, open doors and windows for ventilation, and all gas burning appliances in the vicinity should be shut off including their pilot burners, to avoid vapours lighting.
- NOTICE: Flammable vapours can be drawn by air currents from surrounding areas to the water heater.**
- F** If there is any difficulty in understanding or following the Operating Instructions or the Care and Cleaning section, it is recommended that a qualified person or serviceman perform the work.

Operating Procedure

This heater is equipped with an electronically lit pilot to light the main burner. The pilot is automatically lit each time there is a demand for heating the water. On initial start-up, it is recommended that the outer door be removed (leave inner door in place for safety) to determine if the pilot and main burner are operating properly. Once filled with water, it is necessary to plug the power cord in and make sure the “ON/OFF” switch located on the blower assembly is in the “ON” position and the

gas control switch is in the “ON” position. The blower will start and within seconds the pilot will light followed by the main burner. After the main burner ignites, replace the outer door.

If no main burner flame is established, the gas control will go through three trials for ignition before going into a lock-out. A warning light will alert the user of this lock-out condition. If this happens, refer to “Troubleshooting Guide.”

Water Temperature Setting

▲ DANGER: Hotter water increases the Potential for Hot Water SCALDS. Households with small children, disabled, or elderly persons may require a 120°F(49° C) or lower gas control (thermostat) setting to prevent contact with HOT water.

The temperature of the water in the water heater can be regulated by turning the knob on the front of the gas control (thermostat). Safety and energy conservation are factors to be considered when selecting the water temperature setting of the water heater’s gas control (thermostat(s)). The lower the temperature setting, the greater the savings in energy and operating costs.

To comply with safety regulations, the gas control (thermostat) was set at 120°F before the water heater was shipped from the factory. The recommended starting point temperature is 120°F.

Water temperatures above 125°F can cause severe burns or death from

scalding. Be sure to read and follow the warnings outlined in this manual and on the label located on the water heater near the gas control thermostat.

Mixing valves are recommended for reducing point of use water temperature by mixing hot and cold water in branch water lines. It is recommended that a mixing valve complying with the Standard for Temperature Actuated Mixing Valves for Hot Water Distribution Systems, ASSE 1017 be installed. See page 4 for more details and contact a licensed plumber or the local plumbing authority for further information.

The chart on the next page may be used as a guide in determining the proper water temperature for your home.

Operating the water heater

Water Temperature Setting...

The following is additional information which aid in determining a safe working temperature to meet each household need.

Maximum water temperatures occur just after the burner has shut off. To determine the water temperature, turn on a hot water faucet and place a thermometer in the water stream. If an adjustment to the water temperature is preferred, then refer to the Water Heater User Display – Operation Instructions for instruction on adjusting the local and remote user display temperature setpoints.

A condition known as “stacking” or “layering” can occur when a series of short and frequent hot water draws are taken. The hottest temperature water will be at the top of the tank, closest to the outlet pipe delivering hot water to the home. Stacking can cause this top layer of water to be hotter than the water toward the bottom of the tank near the gas control (thermostat). Therefore, always remember to test the water temperature with your hand before use and remember that hotter water increases the risk of scald injury. Also, always supervise young children or others who are incapacitated.

The gas control (thermostat) is constructed with a built in safety shut-off device designed to shut off the gas supply to the burner if the main burner is extinguished for any reason.

The gas control (thermostat) is also equipped with a gas shut off device that will shut off the gas supply to the burner if the water heater exceeds normal operating temperatures. Refer to the “Before You Call For Service” section of this manual, or contact your dealer.

▲ WARNING: Should overheating occur or the gas supply fail to shut off, turn off the manual gas control valve to the appliance

If the water heater has been subjected to fire, flood or physical damage, turn off the manual gas control (shut-off) valve and **DO NOT** operate the water heater again until it has been checked by a qualified service technician.

NOTICE: Do not use this appliance if any part has been under water. Immediately call a qualified installer or service agency to replace a flooded water heater. Do Not attempt to repair the unit! It must be replaced.

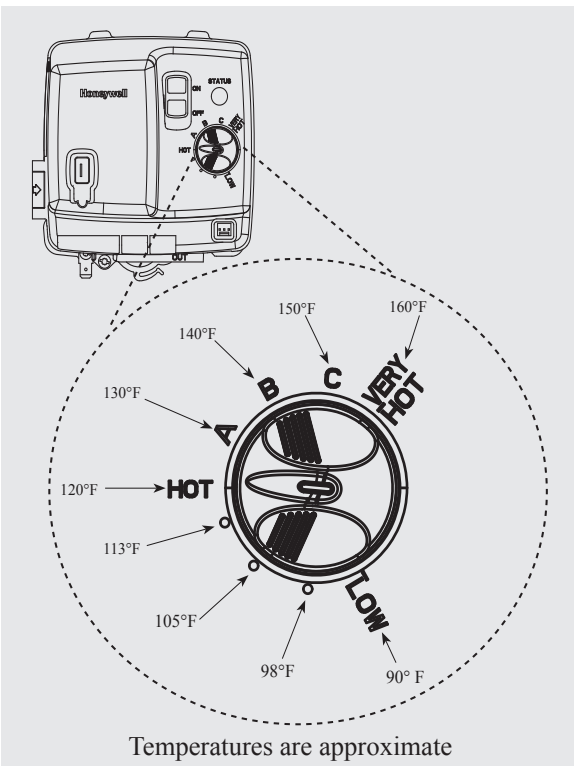

Time/Temperature Relationship in Scalds

Water Temperature	Time To Produce a Serious Burn
120°F (49° C)	More than 5 minutes
125°F (52° C)	1½ to 2 minutes
130°F (54° C)	About 30 seconds
135°F (57° C)	About 10 seconds
140°F (60° C)	Less than 5 seconds
145°F (63° C)	Less than 3 seconds
150°F (66° C)	About 1½ seconds
155°F (68° C)	About 1 second

Table courtesy of Shriners Burn Institute

Operating the water heater

Sequence of Operation...

1. During initial start-up or a call for heat, the control will verify the vacuum switch is open.
2. Once the control verifies the blower vacuum switch is open, the control will energize the blower motor for the pre-purge sequence (approximately 5 seconds).
3. The control will verify the blower vacuum switch has closed, ensuring that the blower is functioning properly and that the venting system is not blocked.
4. The control will then proceed through a sequence of self-diagnostics before initiating a trial for ignition.
5. During the trial for ignition, the pilot will spark in an attempt to light the pilot. Once the pilot flame is established, the main gas valve will open allowing gas to flow to the main burner.
6. The main burner and pilot will remain lit throughout the heat cycle until the water temperature setting is reached.
7. Once the water temperature setting is reached, the control will close the main gas valve and pilot valve which will extinguish both the main burner and pilot burner flames.
8. The blower motor will stay energized for an additional 30 seconds after the control verifies that the burner flame is extinguished in order to clear combustion gases from the water heater.
9. After the post-purge sequence, the control will de-energize the blower motor and go into a stand-by mode awaiting the next call for heat.

This water heater is equipped with a flammable vapor sensor that is monitored continuously by the electronic control in all modes of operation.

In the event that flammable vapors are detected, the control will automatically shut down the water heater and prevent the water heater from being started again.

The following is a list of materials that will cause the Flammable Vapor Sensor to shut down the water heater.

- Vapors of Gasoline.
- Vapors of certain flammable paints, stains, and thinners.
- Vapors of vent pipe Cement & Solvents.
- Bleach (direct contact with flammable vapor sensor).
- Some other flammable materials and their vapors.

If the flammable vapor sensor shuts down the water heater, then the electronic control will display the appropriate error code and you should then promptly contact a qualified service technician.

Refer to the “WARNING” on page 3 for additional information.

Care and cleaning of the water heater

Draining the Water Heater

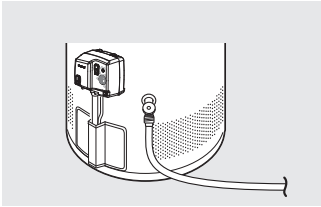

▲CAUTION: Shut off gas to the water heater at the gas control (thermostat) gas cock or manual shut-off valve before draining water.

▲DANGER: Before manually operating the temperature and pressure relief valve, make certain no one will be exposed to the hot water released by the valve. The water drained from the tank may be hot enough to present a scald hazard and should be directed to a suitable drain to prevent injury or damage.

Before turning off the cold water supply to the water heater, open a hot water faucet allowing sufficient cold water into the tank to prevent the risk of a scald injury while draining the water heater. Once the water in the tank is no longer hot, turn off the cold water supply to the water heater. Open a hot water faucet or lift the handle on the relief valve to admit air to the tank.

Attach a garden hose to the drain valve on the water heater and direct the stream of water to a drain. Open the drain valve.

▲DANGER: Before manually operating the relief valve, make certain no one will be exposed to the danger of the hot water released by the valve. The water may be hot enough to create a scald hazard. The water should be released into a suitable drain to prevent injury or property damage.

▲DANGER: Hotter water increases the potential for Hot Water Scalds.

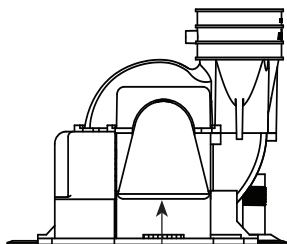

Dilution Air Inlet
Tall Models

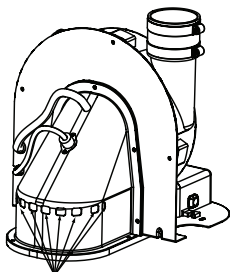

Location of Dilution Air Holes
Short Models

Routine Preventative Maintenance

Properly maintained, your water heater will provide years of dependable trouble-free service.

It is recommended that a periodic inspection of the gas control (thermostat), burner, relief valve, internal flue-way and venting system should be made by service personnel qualified in gas appliance repair.

It is suggested that a routine preventative maintenance program be established and followed by the user.

▲DANGER: Failure to perform the recommended Routine Preventative Maintenance can harm the proper operation of this water heater, which can cause carbon monoxide dangers, excessive hot water temperatures and other potentially hazardous conditions.

Inspect plastic vent pipe. Make certain that all joints are secure and that vent pipe supports are all in place. Check the outdoor vent terminal to see that it is free of obstructions, and that there is no damage nearby caused by condensate.

Inspect dilution air inlet and combustion air inlet openings. Make certain no blockage exists. Clean any lint, dirt or oil accumulation that may exist.

At least once a year, lift and release the lever handle on the temperature pressure relief valve, located near the top of the water heater, to make certain the valve operates freely. Allow several gallons to flush through the discharge line to an open drain.

NOTICE: If the temperature and pressure relief valve on the water heater discharges periodically, this may be due to thermal expansion in a closed water system. Contact the water supplier or your plumbing contractor on how to correct this. **DO NOT** plug the relief valve outlet.

A water heater's tank can act as a settling basin for solids suspended in the water. It is therefore not uncommon for hard water deposits to accumulate in the bottom of the tank. If allowed to accumulate, these solids can cover the gas control (thermostat) sensors, causing the sensors to operate erratically. Because accumulated solids can prevent the gas control (thermostat) sensors from accurately reading the water temperature, the water at the fixture can be hotter than the gas control (thermostat) setting. It is suggested that a few quarts of water be drained from the water heater's tank every month to clean the tank of these deposits.

Rapid closing of faucets or solenoid valves in automatic water using appliances can cause a banging noise heard in a water pipe. Strategically located risers in the water pipe system or water hammer arresting devices can be used to minimize the problem.

The anode rod should be removed from the water heater's tank annually for inspection and replaced when more than 6" of core wire is exposed at either end of the rod.

Make sure the cold water supply is turned off before removing anode rod.

This water heater incorporates a combustion shut off device that shuts the operation of the water heater down if undesirable combustion conditions occur, such as the presence of flammable vapours or blockage of the combustion air inlet openings. Please contact a Qualified Service Technician if this occurs.

Care and cleaning of the water heater

▲ DANGER: Combustible materials, such as clothing, cleaning materials, or flammable liquids, etc., must not be placed against or next to the water heater.

Housekeeping

Visually inspect hot surface ignitor.

To ensure sufficient ventilation and combustion air supply, proper clearances must be maintained.

When installed in a closet, **DO NOT** block or obstruct any of the combustion air inlet openings located around the perimeter of the water heater. A minimum of 1" is required between these combustion air inlet openings and any obstruction.

DO NOT obstruct or block the Flammable Vapour Sensor. The sensor does not require any maintenance or cleaning.

DO NOT expose to cleaning agents.

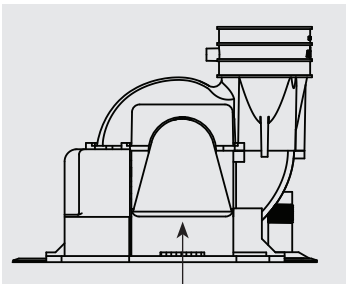

Location of Dilution Air Holes
Tall Models

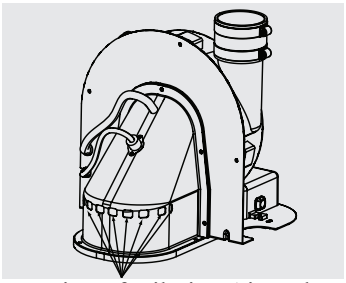

Location of Dilution Air Holes

Venting System Inspection

The water heater's internal flue must be inspected annually to be certain it is clean by removing the blower assembly and flue baffle.

When reinstalling the flue baffle make certain it is hung securely by its hanger at the top of the flue way.

Reinstall the blower assembly.

Inspect plastic vent pipe. Make certain that all joints are secure and that vent pipe supports are all in place. Check the outdoor vent terminal to see that it is free of obstructions, and that there is no damage nearby caused by condensate.

Inspect dilution air holes. Make certain no blockage exists. Clean any lint, dirt or oil accumulation that may exist.

Test for spillage at the dilution air holes after 5 minutes of burner operation. Place a blown out match or candle close to the dilution air holes. The smoke from the candle or match should be drawn into the dilution air holes. If the smoke is pushed away from the dilution air holes, the blower or vent system may be blocked. Contact qualified service personnel.

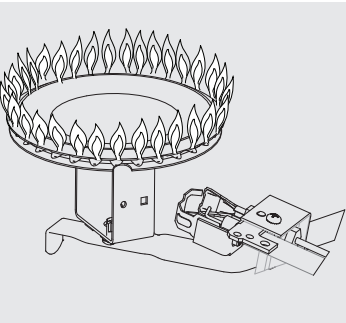

Proper burner flame pattern

Burner Inspection

Visually inspect the pilot flame and main burner annually.

Through the sight glass, inspect the pilot and burner lighting. If any unusual pilot or burner operation is noted, the water heater should be shut off until qualified service assistance can be obtained.

▲ CAUTION: For your safety, cleaning of the burner must be performed only by qualified service personnel, as it involves the disconnection of gas piping and leak testing. The burner chamber is a sealed area. If the burner access door is removed, the burner access door gasket must be replaced.

For cleaning, remove the burner from the water heater. A vacuum cleaner can be used on the burner and floor shield inside the water heater. The burner can also be cleaned by scrubbing with mild detergent.

Vacation and Extended Shut-Down

NOTICE: Refer to the Hydrogen Gas Caution in the Operating Instructions.

If the water heater is to remain idle for an extended period of time, the power and water to the appliance should be turned off to conserve energy and prevent a build-up of dangerous hydrogen gas.

The water heater and piping should be drained if they might be subjected to freezing temperatures.

After a long shut-down period, the water heater's operation and controls should be checked by qualified service personnel. Make certain the water heater is completely filled again before placing it in operation.

Anode Rod

NOTICE: DO NOT remove the anode rod from the water heater's tank, except for inspection and/or replacement, as operation with the anode rod removed will greatly shorten the life of the glass lined tank and will exclude warranty coverage.

This water heater is equipped with an anode rod designed to prolong the life of the glass lined tank. The anode rod is slowly consumed, thereby eliminating or minimizing corrosion of the glass lined tank.

Water sometimes contains a high sulfate and/or mineral content and together with cathodic protection process can produce a hydrogen sulfide, or rotten egg odor in the heated water. Chlorination of the water supply should minimize the problem.

Before You Call For Service...



Troubleshooting Tips

Save time and money! Review the charts on the following pages first and you may not need to call for service.

This water heater incorporates a combustion shut off device that shuts the operation of the water heater down if undesirable combustion conditions occur, such as the presence of flammable vapours or blockage of the combustion air inlet openings. Please contact a Qualified Service Technician if this occurs.

Problem	Possible Causes	What To Do
Condensation	This usually happens when a new water heater is filled for the first time.	<ul style="list-style-type: none"> This is normal. After the water in the tank warms up, the condensation will disappear. If, however, the condition persists, examine the piping and fittings for possible leaks.
	Moisture from the products of combustion condensing on the tank surface.	<ul style="list-style-type: none"> This is normal and will disappear in time. Excessive condensation can cause main burner outage.
	An undersized water heater will cause condensation.	<ul style="list-style-type: none"> Use a water heater size that meets the requirements of your needs.
Yellow flame or soot	Scale on top of the burner.	<ul style="list-style-type: none"> Contact a qualified service technician to remove scale.
	Flue or Combustion air inlet openings are restricted.	<ul style="list-style-type: none"> Remove obstruction or debris from flue or combustion air inlet openings on water heater jacket.
	Not enough combustion or ventilation air supplied to the water heater location.	<ul style="list-style-type: none"> Proper operation of the water heater requires air for combustion and ventilation. See the Combustion and Ventilation Air information in the "Installing The Water Heater" section of this manual.
Unable to light the main burner	Air in gas line.	<ul style="list-style-type: none"> Contact a qualified service technician to purge the air from the gas line.
	Gas Cock Knob not correctly positioned.	<ul style="list-style-type: none"> Contact a qualified service technician to correctly position the gas cock knob.
	Blocked Exhaust.	<ul style="list-style-type: none"> Contact a qualified service technician to evaluate vent pipe for blockage
	Pressure Switch.	<ul style="list-style-type: none"> Make sure the pressure switch hose is not "kinked".
	Wire Connection not fully secured.	<ul style="list-style-type: none"> Contact a qualified service technician to confirm wire connections.
	Combustion Shut-off Device tripped.	<ul style="list-style-type: none"> Combustion shut-off device should be inspected by a qualified service technician.
	Gas Control Problem.	<ul style="list-style-type: none"> Contact a qualified service technician.
Main burner does not stay lit	Combustion Shutoff Device Tripped.	<ul style="list-style-type: none"> The combustion shutoff device should be inspected by a qualified service technician.

⚠ CAUTION: Make certain power to water heater is "OFF" before removing protective cover FOR ANY REASON.

⚠ CAUTION: Label all wires prior to disconnection when servicing controls. Wiring errors can cause improper and dangerous operation. VERIFY PROPER OPERATION AFTER SERVICING.

⚠ CAUTION: For your safety DO NOT attempt repair of gas piping, gas control (thermostat), burners, vent connectors or other safety devices. Refer repairs to qualified service personnel.

Before You Call For Service...

Troubleshooting Tips



Save time and money! Review the charts on the following pages first and you may not need to call for service.

This water heater incorporates a combustion shut off device that shuts the operation of the water heater down if undesirable combustion conditions occur, such as the presence of flammable vapours or blockage of the combustion air inlet openings. Please contact a Qualified Service Technician if this occurs.

Problem	Possible Causes	What To Do
Rumbling noise	Scale and sediment	<ul style="list-style-type: none"> ● Drain the water heater to remove scale and sediment from the tank. Refer to the top of page 26.
Relief valve producing popping noise or draining	Pressure build up caused by thermal expansion to a closed system.	<ul style="list-style-type: none"> ● This is an unacceptable condition and must be corrected. Contact the water supplier or plumbing contractor on how to correct this. Do not plug the relief valve outlet.
Not enough or no hot water	Water usage may have exceeded the capacity of the water heater.	<ul style="list-style-type: none"> ● Wait for the water heater to recover after an abnormal demand.
	Low gas pressure.	<ul style="list-style-type: none"> ● Check gas supply pressure and manifold pressure.
	The gas control (thermostat) may be set too low.	<ul style="list-style-type: none"> ● See the “Water Temperature Setting” of The Water Heater section of this manual.
	Leaking or open hot water faucets.	<ul style="list-style-type: none"> ● Make sure all faucets are closed.
	Check valve error codes.	<ul style="list-style-type: none"> ● Refer to gas valve error code table on page 37.
	“ON/OFF” switch turned off.	<ul style="list-style-type: none"> ● Turn “ON”.
	Blower unplugged.	<ul style="list-style-type: none"> ● Plug in. Verify power supply (120VAC).
	Combustion Shutoff System tripped	<ul style="list-style-type: none"> ● Contact a qualified service technician.
Water is too hot	The gas control (thermostat) is set too high.	<ul style="list-style-type: none"> ● See the “Water Temperature Setting” of The Water Heater section of this manual.
	Gas Control (Thermostat) Defective.	<ul style="list-style-type: none"> ● Contact a qualified service technician to replace the gas control (thermostat).

⚠ CAUTION: Make certain power to water heater is “OFF” before removing protective cover FOR ANY REASON.

⚠ CAUTION: Label all wires prior to disconnection when servicing controls. Wiring errors can cause improper and dangerous operation. VERIFY PROPER OPERATION AFTER SERVICING.

⚠ CAUTION: For your safety DO NOT attempt repair of gas piping, gas control (thermostat), burners, vent connectors or other safety devices. Refer repairs to qualified service personnel.

Gas Valve LED Codes

LCD CODE For Optional Display	GAS VALVE LED	STATUS/PROBLEM	PROBABLE CAUSE	SOLUTION
None	Short flash once every four seconds	IDLE (no call for heat, no fault conditions)	Temperature setpoint achieved and burner is off	No solution required
None	“Heartbeat”, alternates bright/dim	Call For Heat (no fault conditions)	Water temperature is below setpoint and burner is on	No solution required
12	One Flash, three second pause	Low flame signal (control continues to operate)	Pilot tube restriction, carbon buildup on electrode, pilot wire damage or gas supply	1. Gas supply pressure is low 2. Low voltage supply 3. Pilot replacement
44	Two Flash, three second pause.	Pressure switch failed closed	Pressure switch tube blockage or faulty pressure switch.	1. Pressure switch wiring incorrect 2. Replace pressure switch 3. Replace tube or clear blockage
46	Three Flash, three second pause	Pressure switch failed open.	Vent blockage or improper installation, switch tube blockage, faulty switch, blower improper operation or temperature switch open	1. Pressure switch wiring incorrect 2. Replace pressure switch 3. Air intake or exhaust obstructed 4. Replace blower temperature switch 5. Replace blower
31	Four Flash, three second pause.	TCO limit lockout	Thermal well fault, gas control fault or tank is not filled with water	1. Reset valve and check for proper valve cycling 2. Make sure tank is full of water
14	Five Flash, three second pause	Flame out of sequence	Pilot or burner valve has failed open	1. Replace gas valve control
11	Six-One Flash, three second pause	Failed trial for ignition	Insufficient gas supply, unstable pilot, carbon buildup on electrode or wire/pilot tube damage	1. Check gas supply 2. Replace pilot
45	Six-Two Flash, three second pause	Recycle limit - PS/limit opened	Vent blockage or improper installation, switch tube blockage, faulty switch, blower improper operation, blower temperature switch open or excessive wind at vent termination	1. Pressure switch wiring incorrect 2. Replace pressure switch 3. Air intake or exhaust obstructed 4. Replace blower temperature switch 5. Replace blower 6. Check for vent termination compliance as stated in this manual
13	Six-Three Flash, three second pause	Recycle limit - flame lost	Pilot tube restriction, low gas supply pressure, carbon buildup on electrode, wire/pilot tube damage or combustion air port blockage	1. Gas supply pressure is low 2. Jacket air holes obstructed 3. Pilot replacement
14	Six-Four Flash, three second pause	Soft Lockout - flame out of sequence sensed	Valve stuck in open position	1. Replace gas valve control
10	Six - Five Flash, three second pause	Failed Ignition Lockout	Insufficient gas supply, pilot damage or gas valve damage	1. Check gas supply 2. Replace pilot 3. Replace gas valve
47	Seven Flash, three second pause	Flammable vapor sensor lockout	Gasoline or other flammable gas was detected near the appliance or the sensor has failed	1. Verify no gasoline or flammable vapors are present 2. Reset control using ON/OFF switch on the gas control valve 3. Replace the flammable vapor sensor
49	Eight-One Flash, three second pause	FVS fault detected	Flammable vapor sensor resistance is out of range, wiring to FV sensor is faulty or control is faulty	1. Replace FV sensor 2. Replace FV sensor wiring 3. Replace gas control valve
89	Eight-Two Flash, three second pause	Temperature sensor fault detected	Thermal well fault	1. Check thermal well wiring connection 2. Replace thermal well
15	Eight-Three Flash, three second pause	Electronics fault detected	Thermal well fault or gas control fault	1. Replace gas control valve 2. Replace thermal well
93	Eight-Four Flash, three second pause	Valve fault detected	Gas control valve needs to be reset or has been damaged	1. Cycle power to gas control valve 2. Replace gas control valve

⚠ CAUTION: Make certain power to water heater is “OFF” before removing protective cover FOR ANY REASON.

⚠ CAUTION: Label all wires prior to disconnection when servicing controls. Wiring errors can cause improper and dangerous operation. VERIFY PROPER OPERATION AFTER SERVICING.

⚠ CAUTION: For your safety DO NOT attempt repair of gas piping, remote control, burners, vent connectors or other safety devices. Refer repairs to qualified service personnel.

Replacement Parts

For 40 and 50 gallon models using natural or LP gas.

Instructions For Placing a Parts Order

All parts orders should include:

- 1 The model and serial number of the water heater from the rating plate.
- 2 Specify type of gas (natural or LP) as marked on the rating plate.
- 3 Part description (as noted below) and number of parts desired.
- 4 Refer to page 40.

⚠ CAUTION: For your safety, DO NOT attempt repair of gas piping, gas control (thermostat), burners, vent connectors or other safety devices. Refer repairs to qualified service personnel.

Use only original equipment replacement parts.

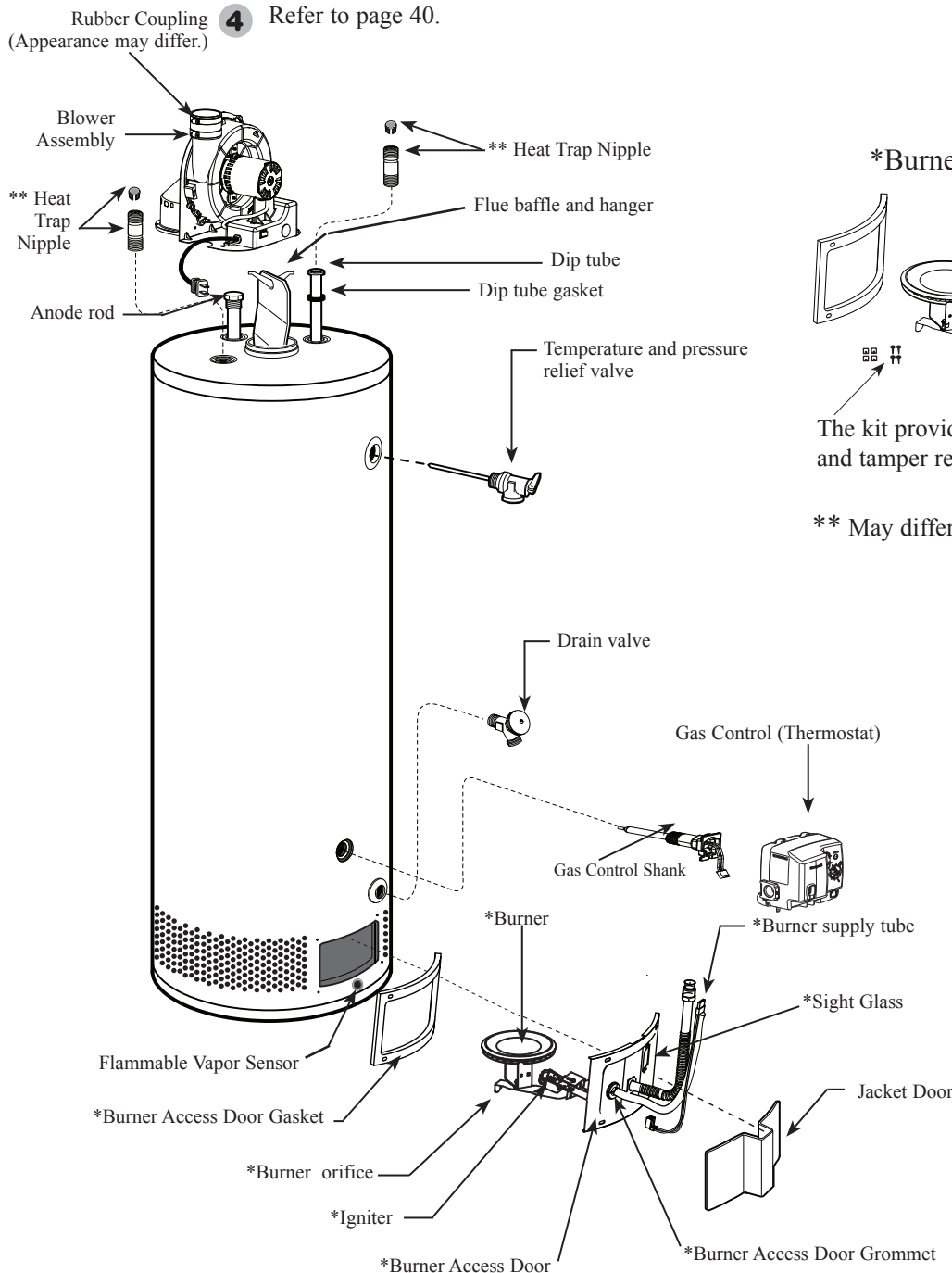

*Burner Assembly Kit

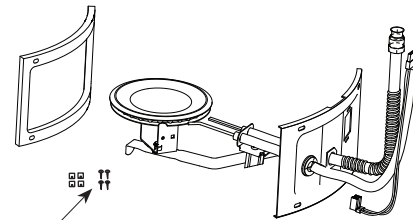

The kit provides extra speed clips and tamper resistant screws.

** May differ in actual appearance.

Notes:

Notes:

IF YOU NEED SERVICE



1. Should you have any questions about your new water heater, or if it requires adjustment, repair, or routine maintenance, it is suggested that you first contact your installer, plumbing contractor or previously agreed upon service agency. In the event the firm has moved, or is unavailable, refer to the telephone directory, commercial listings or local utility for qualified service assistance.
2. Should your problem not be solved to your complete satisfaction, you should then contact the Manufacturer's National Service Department at the following address:

Rheem Canada Ltd./Ltee
125 Edgeware Road, Unit 1
Brampton, Ontario Canada L8Y 0P5
Customer Service Phone: 1-800-432-8373.
Warranty: 1-800-263-8342

When contacting the manufacturer, the following information will be requested:

- a. Model and serial number of the water heater as shown on the rating plate attached to the jacket of the heater.
- b. Address where the water heater is located and physical location.
- c. Name and address of installer and any service agency who performed service on the water heater.
- d. Date of original installation and dates any service work was performed.
- e. Details of the problems as you can best describe them.
- f. List of people, with dates, who have been contacted regarding your problem.