

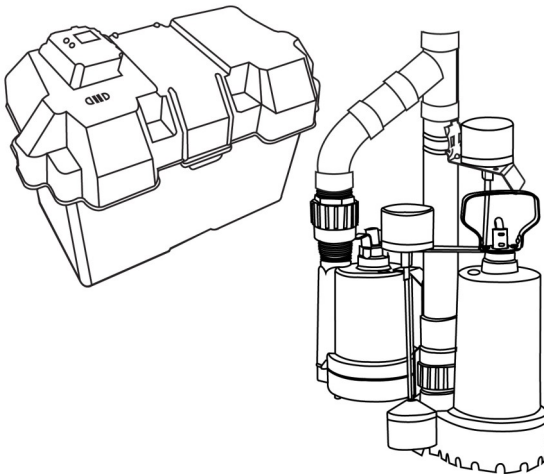



INSTALLATION & OPERATION MANUAL EMERGENCY BACKUP SUMP PUMP SYSTEM

Models:
PF92952, PF92941





Safety Guidelines

Carefully read, understand and follow all safety instructions in this manual.

 **This is the safety alert symbol.** When you see this symbol, look for one of the following signal words.

 **DANGER** Indicates a hazardous situation which, if not avoided, will result in death or serious injury.

 **CAUTION** Indicates a hazardous situation which, if not avoided, could result in death or serious injury.

 **WARNING** Indicates a hazardous situation which, if not avoided, could result in minor or moderate injury.

Safety Information

Read these warnings carefully. Know the application and limitations of this pump. Failure to follow these warnings could result in serious bodily injury and/or property damage.

 **DANGER** **RISK OF ELECTRICAL SHOCK.** Disconnect and lockout power supply before removing old pump or installing or servicing this pump.

 **DANGER** **RISK OF ELECTRICAL SHOCK.** This pump is supplied with a grounding conductor and grounding type attachment plug. To reduce the risk of electric shock, be certain that it is connected only to a properly grounded, grounding type receptacle. For added safety, it is highly recommended to connect this pump to a GFCI (Ground Fault Circuit Interrupter) outlet. Connect only to a receptacle that is adequately rated for the voltage and amperage of this pump

 **WARNING** The installation of this pump must be in accordance with the National Electric Code (NEC), Uniform Plumbing Code (UPC), International Plumbing Code (IPC) as well as all applicable local codes and ordinances.

 **CAUTION** Do not install this pump in any location classified as hazardous by the National Electrical Code, ANSI/NFPA70.

 **CAUTION** Do not use this pump to pump flammable or explosive fluids such as gasoline, kerosene, etc. Do not use this pump in flammable or explosive environments. Use only with liquids compatible with pump component materials.

 **WARNING** **RISK OF ELECTRICAL SHOCK.** This pump has not been investigated for use in swimming pool or marine areas.

 **WARNING** **RISK OF ELECTRICAL SHOCK.** **DO NOT** use the power cord to remove or lower the pump into the basin. The cord may pull apart exposing bare wires which could cause a fire or electrical shock. Use the handle supplied with the pump for installing and removing the pump from the basin.

 **WARNING** Do not run the pump dry. This pump relies on water for cooling. Running the pump dry can cause the pump to overheat and the possibility of burns to anyone that handles the pump. Running the pump dry will void the warranty.

 **WARNING** Don't expose pump to freezing temperatures. Discharge lines exposed to freezing temperatures should be positioned with a downward slope to prevent freezing.

Safety Information (continued)

⚠ WARNING Do not use this pump for potable/drinking water. Use only in applications for which the pump is designed for.

⚠ WARNING According to the state of California (Prop 65), this product contains chemicals known to the state of California to cause cancer and birth defects or other reproductive harm.

⚠ WARNING DO NOT UNDER ANY CIRCUMSTANCES REMOVE THE GROUND PIN. The 3-prong plug must be inserted into a mating 3-prong grounded receptacle. If the installation does not have such a receptacle, it must be changed to the proper type, wired and grounded in accordance with the National Electrical Code and all applicable local codes and ordinances.

⚠ WARNING All wiring must be performed by a qualified electrician.

⚠ WARNING Keep hands clear of suction & discharge openings. To prevent injury, never insert fingers into pump while it is plugged in.

⚠ WARNING Sump basins must be vented according to local plumbing codes.

⚠ CAUTION Do not handle this pump with wet hands or while standing on wet or damp surfaces or in water.

⚠ WARNING If a flexible discharge hose is used, make sure the pump is secured in the basin to prevent movement. Failure to secure the pump could result in flooding from switch malfunction.

⚠ CAUTION This pump motor is equipped with an automatic resetting thermal protector and may restart unexpectedly.

⚠ DANGER Never touch any electrical device, including this pump and charger, when it is touching water, in water, or even in a moist environment. Always unplug (disconnect the electricity) when working on or installing the unit.

⚠ DANGER **RISK OF ELECTRICAL SHOCK.** Do not plug in or unplug the AC transformer while standing on a wet floor. If basement floor is wet, disconnect the power before walking on the floor.

⚠ CAUTION Battery acid is corrosive. Do not spill on skin, clothing, or parts of this system. Wear gloves and eye protection when handling the battery.

⚠ CAUTION This product can expose you to chemicals including vinyl chloride which is known to the state of California to cause cancer. For more information go to www.P65Warnings.ca.gov

Description

This primary/battery backup pump system is designed to remove water from residential sump basins. The all in one kit is pre-assembled for easy installation and includes a 1/3 HP primary pump and 12 volt back up pump. Each pump has a vertical float switch and 10' power cord.

Specifications

Model	Primary Pump PF92352	Primary Pump PF92341	12 Volt Backup Pump PF92910
HP	1/3	1/3	n/a
Volts	120 volt AC	120 volt AC	12 volt DC
Amps	5.9 Amps	4.1 Amps	12 Amps
Hz	60 Hz	60 Hz	n/a
Phase	1	1	n/a
Discharge Size	1-1/2" FNPT	1-1/2" FNPT	1-1/4" or 1/2" NPT
Max. Solids Handling	1/2"	3/8"	1/8"
Liquid Temperature Range	32°F - 120°F	32°F - 120°F	32°F - 120°F
Cord Length	10'	10'	10'
Switch Type	Vertical	Vertical	Vertical
Switch on Level (Factory Set)	8.5"	6"	10"
Switch off Level (Factory Set)	3"	2"	8"
Pump Housing Construction	Cast Iron	Cast Iron	Thermoplastic
Pump Base Construction	Cast Iron	Cast Iron	Thermoplastic
Impeller	Thermoplastic	Stainless Steel	Thermoplastic
Motor Shaft	Stainless Steel	Stainless Steel	Stainless Steel
Shaft Seal	Carbon/Ceramic/ Stainless Steel	Carbon/Ceramic/ Stainless Steel	Carbon/Ceramic/ Stainless Steel
Fasteners	Stainless Steel	Stainless Steel	Stainless Steel
Shut off head	26'	26'	21'
Max. PSI	10.8	10.8	9.0
Battery Charger	n/a	n/a	2 Amp
Low Voltage Cutoff	n/a	n/a	≈10.8 Volts

Battery Selection

This backup pump in this system is designed to work with 12 volt, lead-acid, deep cycle marine/RV and AGM batteries. Either a flooded cell (serviceable or maintenance free) or sealed AGM battery are acceptable. It is recommended to choose a battery with a minimum 40 amp-hour rating. The higher the amp-hour rating on the battery, the longer the pump will run on battery power. Avoid using automobile batteries as these types of batteries are not intended to be charged/discharged for extended periods of time.

The battery case will accommodate group 24 or 27 batteries.

During prolonged periods of power failure or in an emergency situation, your automobile battery may be used. Make sure to replace the deep cycle battery as soon as possible as the automobile battery will be quickly damaged by the continuous charge/discharge cycles.

Carbon Monoxide (CO) Detectors

All backup pump systems that use lead acid batteries, regardless of brand, give off gaseous by-products when the battery is charging. Some of these by-products can cause a carbon monoxide (CO) detector to give a false alarm. When installing this system, position the battery as far away from the CO detector as possible. **DO NOT** move or remove CO detectors from their original location. Always follow the instructions that accompany your CO detector.

If your CO detector alarm sounds, take the following actions.

1. Take immediate action for personal safety as outlined in the CO detector manual.
2. Contact the appropriate utility agency to determine if the CO is coming from your furnace, water heater or other appliance that uses natural gas

If it's determined that a charging battery (sold separately) is causing the CO detector to activate, contact the battery manufacturer for recommendations on how to alleviate the problem.

Installation

1. This primary/backup pump kit comes completely assembled. To install, simply place the pump assembly in the in the bottom of your basin and connect to your new or existing discharge pipe. The pump should be placed on a solid foundation. Do not place the pump directly on the ground or on sandy or rocky surfaces. Sand and small stones may clog or cause damage to your pump.
2. Install this pump making sure that the float switches will operate freely without coming in contact with the sides of the sump basin. Contact with the side of the sump basin may cause the switch to malfunction. See figure below.

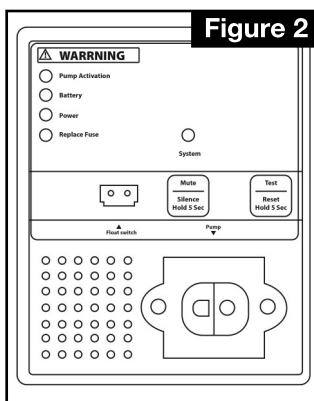
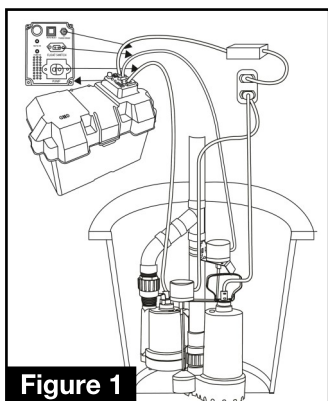

Installation

Electrical Connections

1. If necessary, attach the provided battery terminals to the battery (battery is sold separately). Many deep cycle marine & AGM batteries come with a threaded post terminal built in. **NOTE:** The provided battery terminals are labeled (+) positive and (-) negative. Make sure the terminals are connected to the proper terminal on the battery. Place the battery in the battery box.
2. Connect the battery lead wires from the control panel to the corresponding terminals on the battery. Connect the red (+) positive lead to the positive battery terminal and securely tighten the nut. Connect the black (-) negative lead to the negative battery terminal and securely tighten the nut. Secure the battery box cover to the lower case.
3. Connect the 12 volt pump power cord to the corresponding receptacle on the control panel. Make sure it is fully seated in the receptacle.
4. Connect the 12 volt pump float switch plug to the corresponding receptacle on the control panel. Make sure it is fully seated in the receptacle.
5. Connect the control panel power cord into the side of the control panel. Make sure it is fully seated in the receptacle. Plug the power cord into the outlet.
6. Plug the primary pump float switch plug into a grounded outlet. Next plug the primary pump plug into the piggy back plug of the float switch. See Figure 3
7. Test the float switch and pump by lifting and holding the float. The alarm will sound and the "PUMP ACTIVATION" light on the control panel will illuminate. The "SYSTEM" light will also change from green to red. The pump should start after lifting the float. If it does not run, check your connections and retry.
8. Test the "MUTE" button when the alarm is sounding. Press once to mute the alarm, or press and hold for 5 seconds to silence the alarm. **NOTE:** When silencing the alarm press and hold the "MUTE/SILENCE" button until it beeps (approximately 5-6 seconds). This will indicate that the alarm is silenced. To re-activate the alarm, press and hold the TEST/RESET button until it beeps.
9. Secure the float switch and pump cords to the discharge pipe using the provided zip ties. This is to prevent the cords from obstructing the float switches during operation.

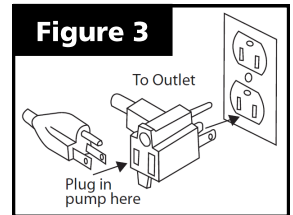

Installation - Testing installation

1. Once your installation and wiring connections are complete, unplug or disconnect the power to the primary pump.
2. Fill the basin using buckets or a hose. Observe the float switches to make sure they are positioned properly when the basin is filling. Fill the basin until the backup float activates the alarm. The pump should start and drain the basin.
3. Make any necessary adjustments to the float(s) and/or pumps at this time.

Operation

1. When the power fails or when there is a problem with the primary pump, the back-up pump will automatically start. The back up pump will operate for many hours intermittently on battery power. During prolonged periods of power outage the pump may stop pumping when the battery voltage drops below 10.8 volts. When this happens the an alarm will sound signaling that the voltage is too low to operate the pump.
2. This unit is equipped with a 2 amp charger. It will charge a discharged battery at a rate of 2 Ah (Amp hours). Once the battery reaches a full charge, the charger will gradually reduce the charge rate. It will also maintain a charged battery by periodically checking the voltage of the battery.
3. The charger is equipped with over charge protection. It will not let the battery become over charged.

WARNING LIGHTS & CONTROLS

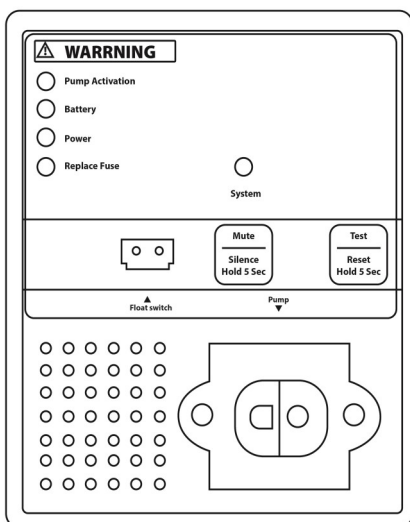

System - When the system is operating normally without any warnings or notifications, this light will illuminate solid green.

Pump Activation - This light will illuminate and the alarm will sound when the back up pump has activated. Press and hold the test/reset for 5 seconds (until it beeps) to re-set.

Battery - This light will illuminate and the alarm will sound when the battery voltage drops below 10.8 volts. Press and hold the Test/Reset button (until it beeps) for 5 seconds to reset.

Power - This light will illuminate and the alarm will sound when the AC power to the control panel is interrupted or disconnected. This would indicate a loose or disconnected power cord, a power outage, or a blown fuse/circuit breaker or tripped GFCI outlet. Press and hold Test/Reset button for 5 seconds (until it beeps) to reset.

Replace Fuse - This light will illuminate and the alarm will sound when the fuse is blown and needs to be replaced. Press and hold Test/Reset button

for 5 seconds (until it beeps) to reset.

Mute / Silence - Press this button once to mute the alarm. The alarm will remain muted until another warning is detected. Press and hold this button for 5 seconds until it beeps to permanently silence the alarm. To reactivate the alarm, press and hold the Test/Reset button for 5 seconds (until it beeps).

Test/Reset - Press this button once to test the status of the control panel and operation of the back up pump. The green light will flash and the pump will operate for approximately 5 seconds and turn off. If any problems are detected, the alarm will sound and the corresponding light will illuminate. Press and hold this button for 5 seconds (until it beeps) to reset all alarm & warning notifications.

Maintenance

⚠ DANGER

Risk of electric shock. Always disconnect the power supply before attempting to install, service or perform maintenance on the pump.

⚠ WARNING

All repairs must be made by an authorized service center.

⚠ CAUTION

The primary sump pump contains oil which may become pressurized and hot under normal operating conditions - allow the pump to cool for 2-3 hours before servicing.

1. The pump motor is hermetically sealed in the housing and does not require any service. Disassembly of the motor housing or modification of the power cord voids the warranty.
2. Periodically check the sump basin for accumulation of mud, silt, sand and foreign objects. Clean the basin as needed to prevent damage or clogging of the pump.
3. Periodically inspect and clean the anti-airlock hole.
4. Inspect the float switch for any accumulated debris that may inhibit it from operating properly. Clean if necessary.
5. In applications where the pump may not activate for extended periods of time, it is recommended to cycle the pump at least once per month to ensure the pumping system is working properly when needed.

Performances

Height and/or piping restriction will reduce the pump output performance. It is recommended to use the same size or larger pipe as the pump discharge for optimum performance.

Model	Discharge Height	0'	5'	10'	15'	20'	25'
PF92910* 12 Volt	Gallons Per Minute	23	22	18	13	8	
PF92941 120 Volt	Gallons Per Minute	46	36	30	25	12	1
PF92952 120 Volt	Gallons Per Minute	60	56	50	35	15	6

*Performance ratings were obtained using a fully charged, 12 volt, deep cycle AGM battery with a 100 Ah rating. Performances may vary depending on size & type of battery used. Performance will decrease as the battery discharges.

Troubleshooting (12 Volt Backup Pump)

PROBLEM	POSSIBLE CAUSES	HOW TO CORRECT
Pump won't run.	Loose, corroded or reversed wire connections	Tighten, clean or reconnect if necessary
	Discharged battery	Charge battery
Pump hums but won't run.	Defective battery	Replace battery
	Blown fuse	Replace with 30 amp fuse
	Float switch is stuck	Position float so it moves freely
	Battery is discharged below 10.8 volts	Fully charge battery
Pump cycles too often	Float switch positioned improperly	Reposition float switch
	Defective or missing check valve	Install or replace check valve
Pump runs but moves little or no water	Low or discharged battery	Fully charge battery
	Obstruction in pipe	Clear obstruction
	Discharge pipe height/length exceeds the capacity of the pump	Check performance section for capacity of this pump
	Defective check valve	Replace Check Valve if necessary

Troubleshooting (120 Volt Primary Pump)

PROBLEM	POSSIBLE CAUSES	HOW TO CORRECT
If the pump does not start or run	Pump is not plugged in, switch or breaker is off	Plug pump in or turn on switch/breaker
	Check for blown fuses or tripped circuit breakers or tripped GFCI outlets	Replace fuse, reset breaker, reset GFCI outlet
	Float switch is defective	Check and replace if necessary
	Motor thermal protector tripped	Allow pump to cool. Pump will reset
	Float switch is stuck or obstructed	Remove obstruction or position pump so it will not become stuck
The pump starts and stops too often	Backflow of water from discharge hose/pipe	Install or replace check valve
	Float switch is defective	Replace float switch
If the pump runs but moves little or no water	Clogged intake screen	Clean or replace screen
	Clogged discharge hose/pipe	Remove clog
	Frozen discharge hose/pipe	Allow hose/pipe to thaw
	Pump is air locked	Clean out airlock hole with a paper clip or pipe cleaner
	Low line voltage	Check wire size and increase if necessary
	Check valve is stuck in the closed position	Inspect, repair or replace if necessary
	Check valve is installed backwards	Make sure check valve is installed in the correct direction of flow
	Worn, damaged or clogged pump parts	Inspect for wear, damage or clog and clean or replace if necessary
	Discharge head exceeds pump capacity	If pumping height is over 25', the pump will not move water. See performance chart
Pump does not shut off	Float switch is obstructed or stuck	Remove obstruction
	Defective Float Switch	Replace switch

Replacement Parts

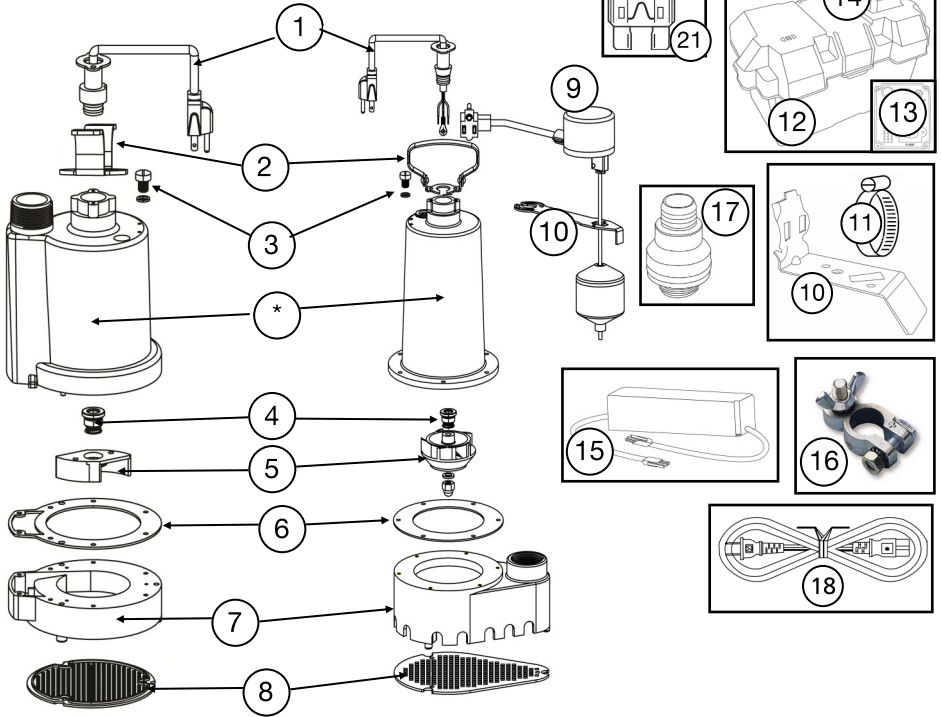

Ref #	Description	PF92910	PF92341	PF92352
1	Power Cord - Pump	99158	99108	99108
2	Handle	99050	99053	99053
3	Plug with O-ring	99056	99056	99056
4	Shaft Seal	99057	99057	99057
5	Impeller	99060	99096	99098
6	Gasket	99062	99088	99064
7	Volute/Base	99067	99078	99074
8	Intake Screen	99073	99073	99074
9	Vertical Float Switch (includes switch, float rod, float ball & grommet)	92091	92010	92010
10	Vertical Float Switch Bracket	99195	99105	99105
11	Stainless Steel Hose Clamp	99183	n/a	n/a
12	Battery Box	99459	n/a	n/a
13	Control Panel (no cover)	99455	n/a	n/a
14	Battery Box Cover with Control Panel	99456	n/a	n/a
15	2 Amp Charger	99454	n/a	n/a
16	Battery Terminals (+ & -) One Set	99460	n/a	n/a
17	Check Valve	99507	99509	99509
18	Power Cord - Control Panel	99452	n/a	n/a

LIMITED WARRANTY - PRIMARY/BATTERY BACKUP PUMPS:

Manufacturer warrants the products specified in this warranty to be free from defects in material or workmanship for three (3) years from date of purchase. During the time period and subject to the terms and conditions, the manufacturer will repair or replace to the original user or consumer any portion of this product which proves to be defective due to materials or workmanship. At all times the manufacturer shall have and possess the sole right and option to determine whether to repair or replace defective equipment, parts, or components. The manufacturer has the option to inspect any product returned under warranty to confirm that the warranty applies before repair or replacement under warranty is approved. This warranty sets forth the manufacturer's sole obligation and purchaser's exclusive remedy for defective product. Return defective product to the place of purchase for warranty consideration.

WARRANTY PERIOD - PRODUCTS:

If, within the duration of product use by the original user, this product proves to be defective due to materials or workmanship, the product shall be repaired or replaced at the manufacturer's option, subject to the terms and conditions set forth in this warranty statement. Proof of purchase is required for warranty consideration. In the absence of suitable proof of the purchase date, the effective period of this warranty is 12 months from the product's date of manufacture.

LABOR, ETC. COSTS:

The manufacturer shall IN NO EVENT be responsible or liable for the cost of field labor or other charges incurred by any customer in removing and/or affixing any product, part, or component thereof.

PRODUCT IMPROVEMENTS:

The manufacturer reserves the right to change or improve its products or any portions thereof without being obligated to provide such a change or improvement for units sold and/or shipped prior to such change or improvement.

GENERAL TERMS AND CONDITIONS:

This warranty shall not apply to damage due to acts of God, normal wear and tear, normal maintenance services and the parts used in connection with such service, lightning or conditions beyond the control of the manufacturer, nor shall it apply to products which, in the sole judgment of the manufacturer, have been subject to negligence, abuse, accident, misapplication, tampering, alteration; nor due to improper installation, operation, maintenance or storage; nor to excess of recommended maximums as set forth in the instructions. Warranty will be VOID if any of the following conditions are found:

1. Product is used for purposes other than those for which it was designed and manufactured
2. Product not installed in accordance with applicable codes, ordinances, and good trade practices
3. Product connected to voltage other than indicated on nameplate or labels
4. Pump exposed to but not limited to the following: sand, gravel, cement, grease, plaster, mud, tar, oil, gasoline, solvents or other abrasive or corrosive substances
5. Pump has been used for pumping liquids above 120°F
6. Pump allowed to operate dry (liquid supply cut off)

DISCLAIMER:

Any oral statements about the product made by the seller, the manufacturer, the representatives, or any other parties do not constitute warranties, shall not be relied upon by the user, and are not part of the contract for sale. Seller's and the manufacturers only obligation, and buyer's only remedy, shall be the replacement and/or repair by the manufacturer of the product as described above. NEITHER SELLER NOR THE MANUFACTURER SHALL BE LIABLE FOR ANY INJURY, LOSS OR DAMAGE, DIRECT, INCIDENTAL OR CONSEQUENTIAL (INCLUDING, BUT NOT LIMITED TO, INCIDENTAL OR CONSEQUENTIAL DAMAGES FOR LOST PROFITS, LOST SALES, INJURY TO PERSON OR PROPERTY, OR ANY OTHER INCIDENTAL OR CONSEQUENTIAL LOSS), ARISING OUT OF THE USE OR THE INABILITY TO USE THE PRODUCT, AND THE USER AGREES THAT NO OTHER REMEDY SHALL BE AVAILABLE TO IT. Before using, the user shall determine the suitability of the product for his/her intended use, and user assumes all risk and liability whatsoever in connection therewith.

THE WARRANTY AND REMEDY DESCRIBED IN THIS LIMITED WARRANTY IS AN EXCLUSIVE WARRANTY AND REMEDY AND IS IN LIEU OF ANY OTHER WARRANTY OR REMEDY, EXPRESSED OR IMPLIED, WHICH OTHER WARRANTIES AND REMEDIES ARE HEREBY EXPRESSLY EXCLUDED, INCLUDING BUT NOT LIMITED TO ANY IMPLIED WARRANTY OF MERCHANTABILITY OR FITNESS FOR A PARTICULAR PURPOSE, TO THE EXTENT EITHER APPLIES TO A PRODUCT SHALL BE LIMITED IN DURATION TO THE PERIODS OF THE EXPRESSED WARRANTIES GIVEN ABOVE.

Some states and countries do not allow the exclusion or limitations on how long an implied warranty lasts or the exclusion or limitation of incidental or consequential damages, so the above exclusion or limitations may not apply to you. This warranty gives you specific legal rights, and you may also have other rights which vary from state to state.

