

# Water Management Product Catalog



THE MOST **ADVANCED** NAME IN WATER MANAGEMENT SOLUTIONS™





# TABLE OF CONTENTS

## PRODUCT APPLICATIONS

Matrix of appropriate applications for all products . . . . 2-3

## PIPE

High Performance

• Sanitary / Storm . . . . . 4-5

Dual Wall

• Characteristics. . . . . 6

• Low Head Water Transmission. . . . . 7

• Storm Drainage. . . . . 8-13

Single Wall

• Characteristics. . . . . 14

• Storm Drainage. . . . . 15-19

Smooth Wall, Triplewall. . . . . 20

## PRESSURE PIPE

• PolyFlex™ Potable Grade . . . . . 21-22

• PolyFlex™ Utility Grade . . . . . 23

• PolyFlex™ Copper Tubing Size . . . . . 24

## FITTINGS

• Dual Wall . . . . . 25-46

• INSERTA TEE® . . . . . 47-48

• INSERTA TEE® Hole Saws . . . . . 49

• Single Wall. . . . . 50-56

• Turf Flow®. . . . . 56

• PVC Fittings . . . . . 57

## NYLOPLAST®

• Road/Highway Structures. . . . . 58

• Catch Basins . . . . . 59

• Grates. . . . . 60

• Water Control Structures . . . . . 61

• Add-A-Branch. . . . . 61

• Fittings . . . . . 62-67

## HICKENBOTTOM® RISERS & PRECISION INTAKES . . . 68-69

## OUTFLOW ACCESSORIES . . . . . 70-71

## RETENTION/DETENTION SYSTEMS . . . . . 72-75

• StormTech® . . . . . 76-86

## STORM WATER TREATMENT

• Storm Water Quality Unit . . . . . 87

• Grease Interceptor . . . . . 87

• FLEXSTORM® Inlet Filters . . . . . 88-92

• BaySaver® Storm Water Treatment . . . . . 93

## DURASLOT® . . . . . 94-97

## ADVANEDGE® . . . . . 98-99

## ONSITE CHAMBERS. . . . . 100-101

## SEPTIC STACK™ . . . . . 102

## WASTE WATER ACCESSORIES . . . . . 103

## FOUNDATION DRAINAGE & ACCESSORIES. . . . . 104

## METER PITS & WATERSTOP GASKETS . . . . . 105

## GEOSYNTHETICS

• Nonwovens. . . . . 106

• Wovens. . . . . 107

• Geogrids. . . . . 107

• Septic Fabrics . . . . . 108

• Erosion Control Blankets . . . . . 109

• Turf Reinforcement Mats . . . . . 109

• Silt Fence . . . . . 109



RESALE ITEMS – MARKED WITH  – ARE PRODUCTS OFFERED FOR SALE BUT NOT MANUFACTURED BY ADS/HANCOR.

STANDARD AND METRIC UNITS ARE PROVIDED ON PRODUCTS THROUGHOUT THE CATALOG. UNLESS STATED OTHERWISE, METRIC UNITS SHOULD BE USED FOR REFERENCE PURPOSES ONLY. PRODUCTS SUBJECT TO CHANGE WITHOUT NOTICE. ALL SALES OF OUR PRODUCT ARE SUBJECT TO A LIMITED WARRANTY AND PURCHASERS ARE SOLELY RESPONSIBLE FOR INSTALLATION AND USE OF OUR PRODUCTS AND DETERMINING WHETHER A PRODUCT IS SUITED FOR ANY SPECIFIC NEEDS. PLEASE CONSULT A FULL COPY OF TERMS AND CONDITIONS FOR SALE FOR FURTHER DETAILS.

# PRODUCT APPLICATIONS

| APPLICATIONS                                   | TRIPLE WALL        | DUAL WALL |                                       |         |         |                |            | SINGLE WALL |            |
|--|--------------------|-----------|---------------------------------------|---------|---------|----------------|------------|-------------|------------|
|  | POLYPROPYLENE (PP) | PP        | HIGH DENSITY POLYETHYLENE PIPE (HDPE) |         |         |                | HDPE       |             |            |
|  | SANITITE® HP       | HP STORM  | N-12® LOW HEAD                        | N-12 WT | N-12 ST | N-12 PLAIN END | MEGA GREEN | HIGHWAY     | HEAVY DUTY |
| <b>CONSTRUCTION PRODUCTS</b>                   |                    |           |                                       |         |         |                |            |             |            |
| STORM SEWER                                    |                    | •         |                                       | •       | •       | •              | •          |             |            |
| RETENTION/DETENTION                            |                    | •         |                                       | •       | •       | •              | •          | •           |            |
| CULVERTS/CROSS DRAINS                          |                    | •         |                                       | •       | •       | •              | •          | •           | •          |
| SLOPE/EDGE DRAINS                              |                    | •         |                                       | •       | •       | •              | •          | •           | •          |
| MINING/FORESTRY/INDUSTRIAL                     |                    | •         |                                       | •       | •       | •              | •          |             |            |
| POST TENSIONING                                |                    |           |                                       |         |         |                |            |             |            |
| <b>RESIDENTIAL PRODUCTS</b>                    |                    |           |                                       |         |         |                |            |             |            |
| FOUNDATIONS/EDGE DRAINS                        |                    |           |                                       | •       | •       | •              | •          |             | •          |
| DOWNSPOUTS/ROOF DRAINAGE                       |                    |           |                                       | •       | •       | •              | •          |             | •          |
| CULVERTS                                       |                    | •         |                                       | •       | •       | •              | •          | •           | •          |
| SUB DRAINAGE                                   |                    |           |                                       |         |         |                |            |             | •          |
| ON-SITE WASTE MANAGEMENT                       |                    |           |                                       |         |         |                |            |             |            |
| <b>RECREATION PRODUCTS</b>                     |                    |           |                                       |         |         |                |            |             |            |
| PATHS/WALKWAYS/EDGE DRAINS                     |                    |           |                                       | •       | •       | •              | •          |             | •          |
| SPORTS PLAYING FIELDS                          |                    | •         |                                       | •       | •       | •              | •          | •           | •          |
| CULVERTS                                       |                    |           |                                       | •       | •       | •              | •          | •           | •          |
| PARKING LOT DRAINAGE                           |                    | •         |                                       | •       | •       | •              | •          | •           | •          |
| GOLF COURSE DRAINAGE                           |                    |           |                                       |         | •       | •              | •          | •           | •          |
| LANDSCAPE/SUB DRAINAGE                         |                    |           |                                       |         |         |                |            | •           | •          |
| <b>AGRICULTURE PRODUCTS</b>                    |                    |           |                                       |         |         |                |            |             |            |
| FIELD DRAINAGE                                 |                    |           |                                       |         |         |                |            |             | •          |
| GRAIN AERATION                                 |                    |           |                                       |         | •       | •              | •          |             | •          |
| LAND RECLAMATION                               |                    |           |                                       | •       | •       | •              | •          |             | •          |
| WATERWAYS                                      |                    |           |                                       | •       | •       | •              | •          | •           | •          |
| TERRACING                                      |                    |           |                                       | •       | •       | •              | •          | •           | •          |
| DITCH ENCLOSURES                               |                    | •         | •                                     | •       | •       | •              | •          | •           | •          |
| <b>SANITARY SEWER/<br/>INDUSTRIAL PRODUCTS</b> |                    |           |                                       |         |         |                |            |             |            |
| SANITARY SEWER TRUNK LINES                     | •                  |           |                                       |         |         |                |            |             |            |
| INDUSTRIAL WASTE                               | •                  |           |                                       |         |         |                |            |             |            |
| IRRIGATION TRANSMISSION LINES                  |                    |           | •                                     |         |         |                |            |             |            |

SUGGESTED PRODUCTS AND APPLICATIONS ARE PROVIDED FOR GENERAL GUIDANCE ONLY.  
CONTACT A SALES REPRESENTATIVE TO DISCUSS THE PRODUCTS ACCEPTABLE FOR SPECIFIC APPLICATIONS.



# SANITARY PIPE

## SANITITE® HP

**APPLICATIONS:** A high-performance polypropylene pipe for use in gravity flow, wastewater conveyance, and high performance storm drain systems. Typically used in trunk/interceptor sanitary sewers to service treatment plant flow.

### CHARACTERISTICS

| PRODUCT            | DESCRIPTION  | DIAMETER                         | CONNECTIONS   | SPECIFICATIONS/<br>PERFORMANCE  |
|--------------------|--|----------------------------------|---|---|
| <b>SANITITE HP</b> | Annular corrugations with smooth interior wall. 30"-60" Triple Wall has smooth exterior surface. Pipe is bell-and-spigot with the bell being reinforced with a polymer wrap and the spigot having two gaskets. | 12"-30" (300-750 mm) Dual Wall   | Bell-and-spigot with two rubber gaskets meeting ASTM D3212. | 12"-60" (300-1500 mm) meets ASTM F2764. 12"-60" (300-1500 mm) joints meet the requirements of ASTM F2764. |
|                    |  | 30"-60" (750-1500 mm) Triplewall |   |   |

### SANITITE HP

| DIAMETER         | LENGTH     | STYLE       | SANITITE HP    |
|------------------|------------|-------------|----------------|
| 12"<br>(300 mm)  | 13' (4.0m) | Dual wall   | 1230 0013 IBPP |
|                  | 20' (6.1m) | Dual wall   | 1230 0020 IBPP |
| 15"<br>(375 mm)  | 13' (4.0m) | Dual wall   | 1530 0013 IBPP |
|                  | 20' (6.1m) | Dual wall   | 1530 0020 IBPP |
| 18"<br>(450 mm)  | 13' (4.0m) | Dual wall   | 1830 0013 IBPP |
|                  | 20' (6.1m) | Dual wall   | 1830 0020 IBPP |
| 21"*<br>(525 mm) | 13' (4.0m) | Dual wall   | 2130 0013 IBPP |
|                  | 20' (6.1m) | Dual wall   | 2130 0020 IBPP |
| 24"<br>(600 mm)  | 13' (4.0m) | Dual wall   | 2430 0013 IBPP |
|                  | 20' (6.1m) | Dual wall   | 2430 0020 IBPP |
| 30"<br>(750 mm)  | 13' (4.0m) | Dual wall   | 3030 0013 IBPP |
|                  | 20' (6.1m) | Dual wall   | 3030 0020 IBPP |
| 30"<br>(750 mm)  | 13' (4.0m) | Triple wall | 3030 0013 IBHP |
|                  | 20' (6.1m) | Triple wall | 3030 0020 IBHP |
| 36"<br>(900 mm)  | 13' (4.0m) | Triple wall | 3630 0013 IBHP |
|                  | 20' (6.1m) | Triple wall | 3630 0020 IBHP |
| 42"<br>(1050 mm) | 13' (4.0m) | Triple wall | 4230 0013 IBHP |
|                  | 20' (6.1m) | Triple wall | 4230 0020 IBHP |
| 48"<br>(1200 mm) | 13' (4.0m) | Triple wall | 4830 0013 IBHP |
|                  | 20' (6.1m) | Triple wall | 4830 0020 IBHP |
| 60"<br>(1500 mm) | 16' (5.0m) | Triple wall | 6030 0016 IBHP |
|                  | 20' (6.1m) | Triple wall | 6030 0020 IBHP |

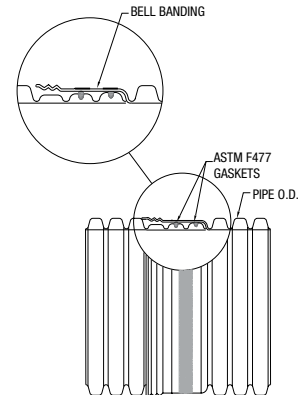

**SANITITE HP  
DUAL WALL**

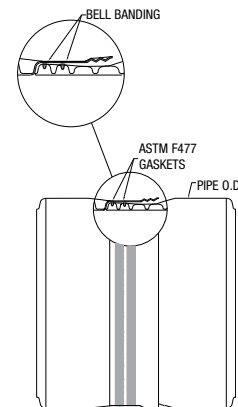

**SANITITE HP  
TRIPLEWALL**

\*LIMITED GEOGRAPHIC AVAILABILITY. PLEASE CHECK WITH SALES REPRESENTATIVE FOR AVAILABILITY.

# STORM SEWER PIPE

## HP STORM

**APPLICATIONS:** HP Storm is a high-performance polypropylene pipe for gravity-flow storm drainage applications.

### CHARACTERISTICS

| PRODUCT         | DESCRIPTION  | DIAMETER                              | CONNECTIONS   | SPECIFICATIONS/<br>PERFORMANCE                                     |
|-----------------|--|---------------------------------------|---|--|
| <b>HP STORM</b> | Annular corrugations with smooth interior surface. Pipe is bell-and-spigot with the bell being reinforced with a polymer wrap. | 12"-60"<br>(300-1500 mm)<br>Dual Wall | Bell-and-spigot with a rubber gasket meeting ASTM F477. | 12"-60" (300-1500 mm) meets or exceeds ASTM F2881 and AASHTO M330. |

### HP STORM

| DIAMETER      | LENGTH      | PRODUCT CODE   |
|---------------|-------------|----------------|
| 12" (300 mm)  | 20' (6.1 m) | 1265 0020 IBPL |
| 15" (375 mm)  | 20' (6.1 m) | 1565 0020 IBPL |
| 18" (450 mm)  | 20' (6.1 m) | 1865 0020 IBPL |
| 24" (600 mm)  | 20' (6.1 m) | 2465 0020 IBPL |
| 30" (750 mm)  | 20' (6.1 m) | 3065 0020 IBPL |
| 36" (900 mm)  | 20' (6.1 m) | 3665 0020 IBPL |
| 42" (1050 mm) | 20' (6.1 m) | 4265 0020 IBPL |
| 48" (1200 mm) | 20' (6.1 m) | 4865 0020 IBPL |
| 60" (1500 mm) | 20' (6.1 m) | 6065 0020 IBPL |

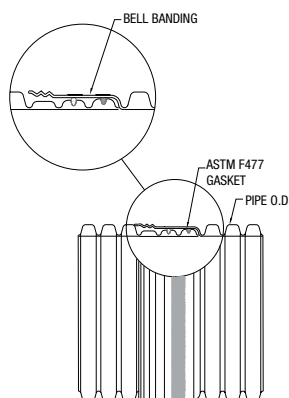

**HP STORM  
DUAL WALL**

# DUAL WALL HDPE PIPE

## N-12<sup>®</sup> LOW-HEAD, N-12 WT IB, N-12 ST IB, N-12 PLAIN END, MEGA GREEN<sup>®</sup> WT IB, MEGA GREEN ST IB, MEGA GREEN PLAIN END

### CHARACTERISTICS

| PRODUCT                                 | DESCRIPTION  | DIAMETER                    | CONNECTION  | SPECIFICATIONS/<br>PERFORMANCE   |
|---|--|-----------------------------|---|--|
| <b>N-12<br/>LOW-HEAD<br/>IRRIGATION</b> | Annular corrugations with HDB rated smooth interior liner. Pipe is bell-and-spigot with the bell being reinforced with a polymer wrap and the spigot having two gaskets. | 24" - 60" *<br>(600-1500mm) | Bell-and-spigot with 2 rubber gaskets meeting ASTM F477.        | 24" - 60" (600-1500mm) meets ASTM F2306.<br>Joints meet the requirements of ASTM D3212.  |
| <b>N-12 WT IB</b>                       | Annular corrugations with smooth interior liner. Pipe is bell-and-spigot with a gasket.  | 4" - 60"<br>(100-1500mm)    | Bell-and-spigot with rubber gasket meeting ASTM F477.           | 4" - 10" (100-250mm) meets AASHTO M252, Type S. **<br>12" - 60" (300-1500mm) meets ASTM F2306 and AASHTO M294, Type S.<br>Joints meet the requirement of ASTM D3212.** |
| <b>N-12 ST IB</b>                       | Annular corrugations with smooth interior.   | 4" - 60"<br>(100-1500mm)    | 12" - 60" bell-and-spigot with rubber gasket meeting ASTM F477. | 4" - 10" (100-250mm) meets AASHTO M252, Type S. **<br>12" - 60" (300-1500mm) meets ASTM F2306 and AASHTO M294, Type S.**   |
| <b>N-12 PLAIN END</b>                   | Annular corrugations with smooth interior.   | 4" - 60"<br>(100-1500mm)    | External snap or split band couplers depending on diameter.     | 4" - 10" (100-250mm) meets AASHTO M252, Type S.**<br>12" - 60" (300-1500mm) meets AASHTO M294, Type S.**   |
| <b>MEGA GREEN<br/>WT IB</b>             | Annular corrugations with smooth interior liner. Pipe is bell-and-spigot with a gasket.  | 4" - 60"<br>(100-1500mm)    | Bell-and-spigot with rubber gasket meeting ASTM F477.           | 4" - 60" (100-1500mm) meets ASTM F2648.<br>Joints meet the requirement of ASTM D3212.  |
| <b>MEGA GREEN<br/>ST IB</b>             | Annular corrugations with smooth interior.   | 4" - 60"<br>(100-1500mm)    | 12" - 60" bell-and-spigot with rubber gasket meeting ASTM F477. | 4" - 60" (100-1500mm) meets ASTM F2648.  |
| <b>MEGA GREEN<br/>PLAIN END</b>         | Annular corrugations with smooth interior.   | 4" - 60" *<br>(100-1500mm)  | External snap or split band couplers depending on diameter.     | 4" - 60" (100-1500mm) meets ASTM F2648.  |

\*Not available in 54"

\*\*Also available manufactured from Engineered Compound meeting ASTM F2648



# DUAL WALL HDPE PIPE

## N-12<sup>®</sup> LOW-HEAD

**N-12 LOW-HEAD APPLICATIONS:** ADS Low-Head Pipe is made of polyethylene and is utilized for ditch enclosures and water transmission.

### 24" - 60" DUAL WALL PIPE OFFERINGS

| INSIDE DIAMETER | STANDARD LENGTHS | N-12 LOW-HEAD IRRIGATION* |
|-----------------|------------------|---------------------------|
| 24" (600mm)     | 20' (6.1m)       | 24600020IB                |
| 30" (750mm)     | 20' (6.1m)       | 30600020IB                |
| 36" (900mm)     | 20' (6.1m)       | 36600020IB                |
| 42" (1050mm)    | 20' (6.1m)       | 42600020IB                |
| 48" (1200mm)    | 20' (6.1m)       | 48600020IB                |
| 60" (1500mm)    | 20' (6.1m)       | 60600020IB                |

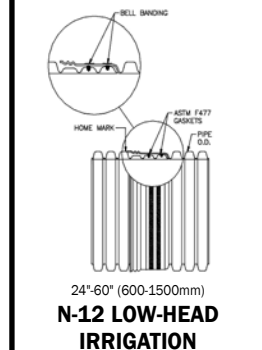

\*LIMITED GEOGRAPHIC AVAILABILITY

# DUAL WALL PIPE

## STORM DRAINAGE

### N-12 PLAIN END, N-12 ST & N-12 WT per AASHTO

#### 4" - 10" DUAL WALL PIPE OFFERINGS

| DIAMETER      | LENGTHS        | STYLE         | N-12 PLAIN END | N-12 ST*   | N-12 WT*   |
|---------------|----------------|---------------|----------------|------------|------------|
| 4"<br>(100mm) | 10'<br>(3.0m)  | solid         | 04150010       | 04150010IB | 04650010IB |
|               |                | perf          | 04110010       | 04110010IB |            |
|               | 20'<br>(6.1m)  | solid         | 04150020       | 04150020IB | 04650020IB |
|               |                | perf          | 04110020       | 04110020IB |            |
|               |                | sock          | 04230020       | 04230020IB |            |
|               | 6"<br>(150mm)  | 10'<br>(3.0m) | solid          | 06150010   | 06150010IB |
| perf          |                |               | 06110010       | 06110010IB |            |
| 20'<br>(6.1m) |                | solid         | 06150020       | 06150020IB | 06650020IB |
|               |                | perf          | 06110020       | 06110020IB |            |
|               |                | sock          | 06230020       | 06230020IB |            |
| 8"<br>(200mm) |                | 10'<br>(3.0m) | solid          | 08150010   | 08150010IB |
|               | perf           |               | 08110010       | 08110010IB |            |
|               | 20'<br>(6.1m)  | solid         | 08150020       | 08150020IB | 08650020IB |
|               |                | perf          | 08110020       | 08110020IB |            |
|               |                | sock          | 08230020       | 08230020IB |            |
|               | 10"<br>(250mm) | 10'<br>(3.0m) | solid          | 10150010   | 10150010IB |
| perf          |                |               | 10110010       | 10110010IB |            |
| 20'<br>(6.1m) |                | solid         | 10150020       | 10150020IB | 10650020IB |
|               |                | perf          | 10110020       | 10110020IB |            |
|               |                | sock          | 10230020       | 10230020IB |            |

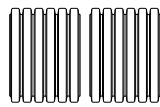

4"-10" (100-250mm)  
**N-12 PLAIN END**

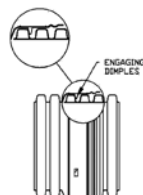

4"-10" (100-250mm)  
**N-12 ST  
BELL-AND-SPIGOT**

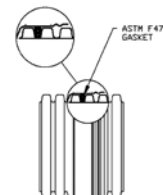

4"-10" (100-250mm)  
**N-12 WT  
BELL-AND-SPIGOT**

# DUAL WALL PIPE

## STORM DRAINAGE

### N-12 PLAIN END, N-12 ST IB & N-12 WT IB per AASHTO

#### 12" - 60" DUAL WALL PIPE OFFERINGS

| DIAMETER         | LENGTHS         | STYLE | N-12 PLAIN END | N-12 ST IB  | N-12 WT IB   |
|------------------|-----------------|-------|----------------|-------------|--------------|
| 12"<br>(300mm)   | 13' (4.0m)      | solid |                | 12850013IB  | 12650013IB   |
|                  | 20'<br>(6.1m)   | solid | 12950020       | 12850020IB  | 12650020IB   |
|                  |                 | perf  | 12910020       | 12810020IB  |              |
|                  |                 | sock  | 12930020       | 12830020IB  |              |
| 15"<br>(375mm)   | 13' (4.0m)      | solid |                | 15850013IB  | 15650013IB   |
|                  | 20'<br>(6.1m)   | solid | 15950020       | 15850020IB  | 15650020IB   |
|                  |                 | perf  | 15910020       | 15810020IB  |              |
|                  |                 | sock  | 15930020       | 15830020IB  |              |
| 18"<br>(450mm)   | 13' (4.0m)      | solid |                | 18850013IB  | 18650013IB   |
|                  | 20'<br>(6.1m)   | solid | 18950020       | 18850020IB  | 18650020IB   |
|                  |                 | perf  | 18910020       | 18810020IB  |              |
|                  |                 | sock  | 18930020       | 18830020IB  |              |
| 24"<br>(600mm)   | 13' (4.0m)      | solid |                | 24850013IB  | 24650013IB   |
|                  | 20'<br>(6.1m)   | solid | 24950020       | 24850020IB  | 24650020IB   |
|                  |                 | perf  | 24910020       | 24810020IB  |              |
|                  |                 | sock  | 24930020       | 24830020IB  |              |
| 30"<br>(750mm)   | 13' (4.0m)      | solid |                | 30850013IB  | 30650013IB   |
|                  | 20'<br>(6.1m)   | solid | 30950020       | 30850020IB  | 30650020IB   |
|                  |                 | perf  | 30910020       | 30810020IB  |              |
|                  |                 | sock  | 30930020       | 30830020IB  |              |
| 36"<br>(900mm)   | 13' (4.0m)      | solid |                | 36850013IB  | 36650013IB   |
|                  | 20'<br>(6.1m)   | solid | 36950020       | 36850020IB  | 36650020IB   |
|                  |                 | perf  | 36910020       | 36810020IB  |              |
|                  |                 | sock  |                | 36830020IB  |              |
| 42"<br>(1050mm)  | 13' (4.0m)      | solid |                | 42850013IB  | 42650013IB   |
|                  | 20'<br>(6.1m)   | solid | 42950020       | 42850020IB  | 42650020IB   |
|                  |                 | perf  | 42910020       | 42810020IB  |              |
|                  |                 | sock  |                | 42830020IB  |              |
| 48"<br>(1200mm)  | 13' (4.0m)      | solid |                | 48850013IB  | 48650013IB   |
|                  | 20'<br>(6.1m)   | solid | 48950020       | 48850020IB  | 48650020IB   |
|                  |                 | perf  | 48910020       | 48810020IB  |              |
|                  |                 | sock  |                | 48830020IB  |              |
| 54"*<br>(1350mm) | 12.5' (3.8m)    | solid |                | 54850013IBA | 54650013IBHA |
|                  | 20.5'<br>(6.2m) | solid |                | 54850021IBA | 54650021IBHA |
| 60"<br>(1500mm)  | 13' (4.0m)      | solid |                | 60850013IB  | 60650013IB   |
|                  | 20'<br>(6.1m)   | solid | 60950020       | 60850020IB  | 60650020IB   |
|                  |                 | perf  | 60910020       | 60810020IB  |              |
|                  |                 | sock  |                | 60830020IB  |              |

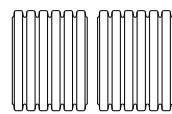

12"-60" (300-1500mm)  
**N-12 PLAIN END**

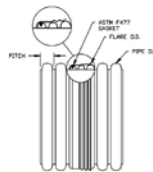

12"-60" (300-1500mm)  
**N-12 ST IB**

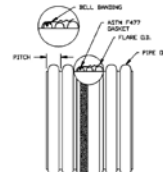

12"-60" (300-1500mm)  
**N-12 WT IB**

\*LIMITED GEOGRAPHIC AVAILABILITY

# DUAL WALL PIPE

## STORM DRAINAGE

### N-12<sup>®</sup> PLAIN END, N-12 ST & N-12 WT per ASTM F2648

#### 4" - 10" DUAL WALL PIPE OFFERINGS

| DIAMETER      | LENGTHS        | STYLE         | N-12 PLAIN END | N-12 ST*    | N-12 WT*    |
|---------------|----------------|---------------|----------------|-------------|-------------|
| 4"<br>(100mm) | 10'<br>(3.0m)  | solid         | 04150010DW     | 04150010BDW | 04650010BDW |
|               |                | perf          | 04110010DW     | 04110010BDW |             |
|               | 20'<br>(6.1m)  | solid         | 04150020DW     | 04150020BDW | 04650020BDW |
|               |                | perf          | 04110020DW     | 04110020BDW |             |
|               |                | sock          | 04230020DW     | 04230020BDW |             |
|               | 6"<br>(150mm)  | 10'<br>(3.0m) | solid          | 06150010DW  | 06150010BDW |
| perf          |                |               | 06110010DW     | 06110010BDW |             |
| 20'<br>(6.1m) |                | solid         | 06150020DW     | 06150020BDW | 06650020BDW |
|               |                | perf          | 06110020DW     | 06110020BDW |             |
|               |                | sock          | 06230020DW     | 06230020BDW |             |
| 8"<br>(200mm) |                | 10'<br>(3.0m) | solid          | 08150010DW  | 08150010BDW |
|               | perf           |               | 08110010DW     | 08110010BDW |             |
|               | 20'<br>(6.1m)  | solid         | 08150020DW     | 08150020BDW | 08650020BDW |
|               |                | perf          | 08110020DW     | 08110020BDW |             |
|               |                | sock          | 08230020DW     | 08230020BDW |             |
|               | 10"<br>(250mm) | 10'<br>(3.0m) | solid          | 10150010DW  | 10150010BDW |
| perf          |                |               | 10110010DW     | 10110010BDW |             |
| 20'<br>(6.1m) |                | solid         | 10150020DW     | 10150020BDW | 10650020BDW |
|               |                | perf          | 10110020DW     | 10110020BDW |             |
|               |                | sock          | 10230020DW     | 10230020BDW |             |

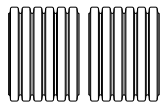

4"-10" (100-250mm)  
**N-12 PLAIN END**

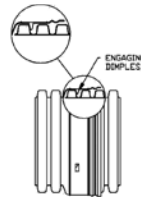

4"-10" (100-250mm)  
**N-12 ST  
BELL-AND-SPIGOT**

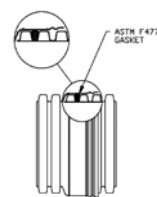

4"-10" (100-250mm)  
**N-12 WT  
BELL-AND-SPIGOT**

# DUAL WALL PIPE

## STORM DRAINAGE

### N-12<sup>®</sup> PLAIN END, N-12<sup>®</sup> ST IB & N-12<sup>®</sup> WT IB

#### per ASTM F2648

#### 12" - 60" DUAL WALL PIPE OFFERINGS

| DIAMETER        | LENGTHS       | STYLE | N-12 PLAIN END | N-12 ST IB | N-12 WT IB |
|-----------------|---------------|-------|----------------|------------|------------|
| 12"<br>(300mm)  | 13' (4.0m)    | solid |                | 12850013DW | 12650013DW |
|                 | 20'<br>(6.1m) | solid | 12950020DW     | 12850020DW | 12650020DW |
|                 |               | perf  | 12910020DW     | 12810020DW |            |
| 15"<br>(375mm)  | 13' (4.0m)    | solid |                | 15850013DW | 15650013DW |
|                 | 20'<br>(6.1m) | solid | 15950020DW     | 15850020DW | 15650020DW |
|                 |               | perf  | 15910020DW     | 15810020DW |            |
| 18"<br>(450mm)  | 13' (4.0m)    | solid |                | 18850013DW | 18650013DW |
|                 | 20'<br>(6.1m) | solid | 18950020DW     | 18850020DW | 18650020DW |
|                 |               | perf  | 18910020DW     | 18810020DW |            |
| 24"<br>(600mm)  | 13' (4.0m)    | solid |                | 24850013DW | 24650013DW |
|                 | 20'<br>(6.1m) | solid | 24950020DW     | 24850020DW | 24650020DW |
|                 |               | perf  | 24910020DW     | 24810020DW |            |
| 30"<br>(750mm)  | 13' (4.0m)    | solid |                | 30850013DW | 30650013DW |
|                 | 20'<br>(6.1m) | solid | 30950020DW     | 30850020DW | 30650020DW |
|                 |               | perf  | 30910020DW     | 30810020DW |            |
| 36"<br>(900mm)  | 13' (4.0m)    | solid |                | 36850013DW | 36650013DW |
|                 | 20'<br>(6.1m) | solid | 36950020DW     | 36850020DW | 36650020DW |
|                 |               | perf  | 36910020DW     | 36810020DW |            |
| 42"<br>(1050mm) | 13' (4.0m)    | solid |                | 42850013DW | 42650013DW |
|                 | 20'<br>(6.1m) | solid | 42950020DW     | 42850020DW | 42650020DW |
|                 |               | perf  | 42910020DW     | 42810020DW |            |
| 48"<br>(1200mm) | 13' (4.0m)    | solid |                | 48850013DW | 48650013DW |
|                 | 20'<br>(6.1m) | solid | 48950020DW     | 48850020DW | 48650020DW |
|                 |               | perf  | 48910020DW     | 48810020DW |            |
| 60"<br>(1500mm) | 13' (4.0m)    | solid |                | 60850013DW | 60650013DW |
|                 | 20'<br>(6.1m) | solid | 60950020DW     | 60850020DW | 60650020DW |
|                 |               | perf  | 60910020DW     | 60810020DW |            |
|                 |               | sock  |                | 60830020DW |            |

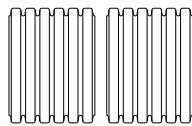

12"-60" (300-1500mm)  
**N-12 PLAIN END**

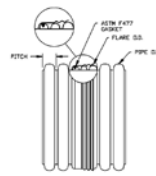

12"-60" (300-1500mm)  
**N-12 ST IB**

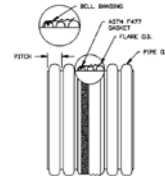

12"-60" (300-1500mm)  
**N-12 WT IB**

# DUAL WALL PIPE

## STORM DRAINAGE

### MEGA GREEN

#### 4" - 10" DUAL WALL PIPE OFFERINGS

| DIAMETER      | LENGTHS        | STYLE         | MEGA GREEN PLAIN END | MEGA GREEN ST* | MEGA GREEN WT* |
|---------------|----------------|---------------|----------------------|----------------|----------------|
| 4"<br>(100mm) | 10'<br>(3.0m)  | solid         | 04150010DW           | 04150010IBDW   | 04650010IBDW   |
|               |                | perf          | 04110010DW           | 04110010IBDW   |                |
|               | 20'<br>(6.1m)  | solid         | 04150020DW           | 04150020IBDW   | 04650020IBDW   |
|               |                | perf          | 04110020DW           | 04110020IBDW   |                |
|               |                | sock          | 04230020DW           | 04230020IBDW   |                |
|               | 6"<br>(150mm)  | 10'<br>(3.0m) | solid                | 06150010DW     | 06150010IBDW   |
| perf          |                |               | 06110010DW           | 06110010IBDW   |                |
| 20'<br>(6.1m) |                | solid         | 06150020DW           | 06150020IBDW   | 06650020IBDW   |
|               |                | perf          | 06110020DW           | 06110020IBDW   |                |
|               |                | sock          | 06230020DW           | 06230020IBDW   |                |
| 8"<br>(200mm) |                | 10'<br>(3.0m) | solid                | 08150010DW     | 08150010IBDW   |
|               | perf           |               | 08110010DW           | 08110010IBDW   |                |
|               | 20'<br>(6.1m)  | solid         | 08150020DW           | 08150020IBDW   | 08650020IBDW   |
|               |                | perf          | 08110020DW           | 08110020IBDW   |                |
|               |                | sock          | 08230020DW           | 08230020IBDW   |                |
|               | 10"<br>(250mm) | 10'<br>(3.0m) | solid                | 10150010DW     | 10150010IBDW   |
| perf          |                |               | 10110010DW           | 10110010IBDW   |                |
| 20'<br>(6.1m) |                | solid         | 10150020DW           | 10150020IBDW   | 10650020IBDW   |
|               |                | perf          | 10110020DW           | 10110020IBDW   |                |
|               |                | sock          | 10230020DW           | 10230020IBDW   |                |

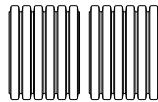

4"-10" (100-250mm)  
**MEGA GREEN  
PLAIN END**

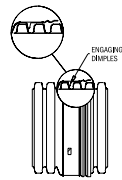

4"-10" (100-250mm)  
**MEGA GREEN ST  
BELL-AND-SPIGOT**

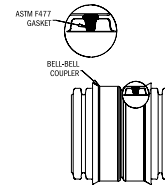

4"-10" (100-250mm)  
**MEGA GREEN WT  
BELL-AND-SPIGOT**

\*LIMITED GEOGRAPHIC AVAILABILITY

# DUAL WALL PIPE

## STORM DRAINAGE

### MEGA GREEN

**12"- 60" DUAL WALL  
PIPE OFFERINGS**

| DIAMETER        | LENGTHS       | STYLE | MEGA GREEN<br>PLAIN END | MEGA GREEN<br>ST IB | MEGA GREEN<br>WT IB |
|-----------------|---------------|-------|-------------------------|---------------------|---------------------|
| 12"<br>(300mm)  | 13' (4.0m)    | solid |                         | 12850013DW          | 12650013IBDW        |
|                 |               | solid | 12950020DW              | 12850020DW          | 12650020IBDW        |
|                 | 20'<br>(6.1m) | perf  | 12910020DW              | 12810020DW          |                     |
|                 |               | sock  | 12930020DW              | 12830020DW          |                     |
| 15"<br>(375mm)  | 13' (4.0m)    | solid |                         | 15850013DW          | 15650013IBDW        |
|                 |               | solid | 15950020DW              | 15850020DW          | 15650020IBDW        |
|                 | 20'<br>(6.1m) | perf  | 15910020DW              | 15810020DW          |                     |
|                 |               | sock  | 15930020DW              | 15830020DW          |                     |
| 18"<br>(450mm)  | 13' (4.0m)    | solid |                         | 18850013DW          | 18650013IBDW        |
|                 |               | solid | 18950020DW              | 18850020DW          | 18650020IBDW        |
|                 | 20'<br>(6.1m) | perf  | 18910020DW              | 18810020DW          |                     |
|                 |               | sock  | 18930020DW              | 18830020DW          |                     |
| 24"<br>(600mm)  | 13' (4.0m)    | solid |                         | 24850013DW          | 24650013IBDW        |
|                 |               | solid | 24950020DW              | 24850020DW          | 24650020IBDW        |
|                 | 20'<br>(6.1m) | perf  | 24910020DW              | 24810020DW          |                     |
|                 |               | sock  | 24930020DW              | 24830020DW          |                     |
| 30"<br>(750mm)  | 13' (4.0m)    | solid |                         | 30850013DW          | 30650013IBDW        |
|                 |               | solid | 30950020DW              | 30850020DW          | 30650020IBDW        |
|                 | 20'<br>(6.1m) | perf  | 30910020DW              | 30810020DW          |                     |
|                 |               | sock  | 30930020DW              | 30830020DW          |                     |
| 36"<br>(900mm)  | 13' (4.0m)    | solid |                         | 36850013DW          | 36650013DW          |
|                 |               | solid | 36950020DW              | 36850020DW          | 36650020DW          |
|                 | 20'<br>(6.1m) | perf  | 36910020DW              | 36810020DW          |                     |
|                 |               | sock  |                         | 36830020DW          |                     |
| 42"<br>(1050mm) | 13' (4.0m)    | solid |                         | 42850013DW          | 42650013DW          |
|                 |               | solid | 42950020DW              | 42850020DW          | 42650020DW          |
|                 | 20'<br>(6.1m) | perf  | 42910020DW              | 42810020DW          |                     |
|                 |               | sock  |                         | 42830020DW          |                     |
| 48"<br>(1200mm) | 13' (4.0m)    | solid |                         | 48850013DW          | 48650013DW          |
|                 |               | solid | 48950020DW              | 48850020DW          | 48650020DW          |
|                 | 20'<br>(6.1m) | perf  | 48910020DW              | 48810020DW          |                     |
|                 |               | sock  |                         | 48830020DW          |                     |
| 60"<br>(1500mm) | 13' (4.0m)    | solid |                         | 60850013DW          | 60650013DW          |
|                 |               | solid | 60950020DW              | 60850020DW          | 60650020DW          |
|                 | 20'<br>(6.1m) | perf  | 60910020DW              | 60810020DW          |                     |
|                 |               | sock  |                         | 60830020DW          |                     |

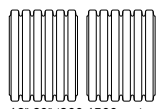

12"-60" (300-1500mm)

**MEGA GREEN  
PLAIN END**

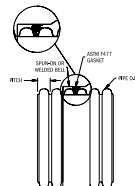

12"-60" (300-1500mm)

**MEGA GREEN  
ST IB**

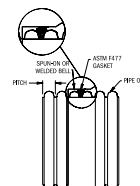

12"-60" (300-1500mm)

**MEGA GREEN  
WT IB**

# SINGLE WALL PIPE

## CHARACTERISTICS

| PRODUCT                                | DESCRIPTION   | DIAMETER RANGE   | LENGTH  | CONNECTION                                     | SPECIFICATIONS/<br>PERFORMANCE   |
|--|---|--|---|--|--|
| <b>HIGHWAY PIPE</b>                    | Annular corrugated single wall  | 3"-24" (75-600 mm)   | 100'-3,200' (30-960 m) coil for 3"-6" (75-150 mm) diameter pipe. 20' (6 m) for 8"-24" (200-600 mm) diameter pipe. | Internal, external snap or split band couplers | 3"-10" (75-250 mm): AASHTO M252, Type C<br>12"-24" (300-600 mm): AASHTO M294, Type C |
| <b>HEAVY DUTY PIPE</b>                 | Annular corrugated single wall  | 3"-24" (75-600 mm)   | 100'-5,500' (30-1676 m) coils, depending on pipe diameter. 10'-20' (3-6 m) sticks.                                | Internal, external snap or split band couplers | 3"-24" (75-600 mm): ASTM F667  |
| <b>CO-EX</b>                           | Annular corrugated single wall with white exterior and black interior       | 4"-6" (100-150 mm)   | 100'-3,200' (30-960 m) depending on the diameter  | Internal or external snap couplers             | ASTM F667  |
| <b>CHANNEL MUCK PIPE</b>               | <b>Annular corrugated single wall with 3/4" holes</b>                       | 4" (100 mm)  | 100'-3,200' (30-960 m) depending on the diameter  | Internal or external snap couplers             | ASTM F667  |
| <b>CHANNEL FLOW PIPE</b>               | <b>Annular corrugated single wall with 3/4" holes</b>                       | 4" (100 mm)  | 10'-250' (3-75 m)   | Internal or external snap couplers             | ASTM F667  |
| <b>GRAVEL-LESS PIPE</b>                | Annular corrugated single wall wrapped in geotextile fabric with 5/8" holes | 8" (200 mm)<br>10" (250 mm)  | 10' (3 m)<br>20' (6 m)  | Internal snap or split band coupler            | ASTM F667  |
| <b>SMOOTHWALL/<br/>TRIPLEWALL PIPE</b> | Smooth white exterior and smooth black interior                             | 3" (75 mm)<br>4" (100 mm)<br>6" (150 mm)   | 10' (3 m)   | Bell-and-spigot                                | ASTM F810  |
| <b>TURF FLOW PIPE</b>                  | Spiral corrugated single wall   | 2" (50 mm)   | Rolls up to 500' (150 m)  | External couplers                              | Local/<br>Manufacturer's recommendations   |
| <b>POST TENSIONING PIPE</b>            | Spiral corrugated single wall   | 2" (50 mm)   | 500' (150 m)  | External couplers                              | Local/<br>Manufacturer's recommendations   |
| <b>POLYFLEX</b>                        | Smooth exterior and interior polyethylene pressure pipe                     | 1/2" (13 mm)<br>3/4" (19 mm)<br>1" (25 mm)<br>1 1/4" (32 mm)<br>1 1/2" (38 mm)<br>2" (50 mm) | 100'-500' (30-152 m)  | Internal and external couplers                 | ASTM D2239<br>ASTM D2737   |
| <b>GRAIN-AIRE GRAIN AERATION PIPE</b>  | Annular corrugated single and dual wall                                     | 12" (300 mm)<br>15" (375 mm)<br>18" (450 mm)**<br>24" (600 mm)**                             | 20' (6 m)   | Split band coupler                             | Local/<br>Manufacturer's recommendations   |
| <b>BEND-A-DRAIN</b>                    | Bendable, expandable single wall pipe                                       | 4" (100 mm)  | 12' (3.6 m)<br>25' (7.6 m)  | External coupler                               | Local/<br>Manufacturer's recommendations   |

\* LIMITED GEOGRAPHIC AVAILABILITY

\*\*DUAL WALL PIPE



# SINGLE WALL PIPE

## HIGHWAY

### 4" - 24" HIGHWAY SINGLE WALL

| INSIDE DIAMETER | OUTSIDE DIAMETER | STANDARD LENGTHS | STYLE     | PRODUCT CODE |
|-----------------|------------------|------------------|-----------|--------------|
| 4" (100mm)      | 4.6" (117mm)     | 100' (30.5m)     | Plain     | 04400100     |
|                 |                  | 250' (76.2m)     | Plain     | 04400250     |
|                 |                  |                  | Perf      | 04410250     |
|                 |                  | 250' (76.2m)     | Perf/wrap | 04430250     |
| 3200' (975.4m)  | 04433200         |                  |           |              |
| 6" (150mm)      | 7.0" (178mm)     | 100' (30.5m)     | Plain     | 06400100     |
|                 |                  | 1500' (457.2m)   |           | 06401500     |
|                 |                  | 100' (30.5m)     | Perf      | 06410100     |
|                 |                  | 1500' (457.2m)   |           | 06411500     |
|                 |                  | 100' (30.5m)     | Perf/wrap | 06430100     |
|                 |                  | 1500' (457.2m)   |           | 06431500     |
| 8" (200mm)      | 9.5" (241mm)     | 20' (6.1m)       | Plain     | 08400020     |
|                 |                  |                  | Perf      | 08410020     |
|                 |                  |                  | Perf/wrap | 08430020     |
| 10" (250mm)     | 12.0" (300mm)    | 20' (6.1m)       | Plain     | 10400020     |
|                 |                  |                  | Perf      | 10410020     |
|                 |                  |                  | Perf/wrap | 10430020     |
| 12" (300mm)     | 14.2" (361mm)    | 20' (6.1m)       | Plain     | 12400020     |
|                 |                  |                  | Perf      | 12410020     |
|                 |                  |                  | Perf/wrap | 12430020     |
| 15" (375mm)     | 17.7" (450mm)    | 20' (6.1m)       | Plain     | 15400020     |
|                 |                  |                  | Perf      | 15410020     |
|                 |                  |                  | Perf/wrap | 15430020     |
| 18" (450mm)     | 21.5" (546mm)    | 20' (6.1m)       | Plain     | 18400020     |
|                 |                  |                  | Perf      | 18410020     |
|                 |                  |                  | Perf/wrap | 18430020     |
| 24" (600mm)     | 28.4" (721mm)    | 20' (6.1m)       | Plain     | 24400020     |
|                 |                  |                  | Perf      | 24410020     |
|                 |                  |                  | Perf/wrap | 24430020     |

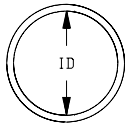
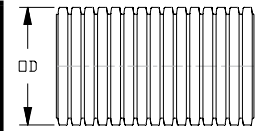

**HIGHWAY PIPE**

# SINGLE WALL PIPE

## HEAVY DUTY

### 3" - 10" HEAVY DUTY SINGLE WALL

| INSIDE DIAMETER | STANDARD LENGTHS | STYLE     | REGULAR     | HEAVY DUTY |
|-----------------|------------------|-----------|-------------|------------|
| 3" (75mm)       | 10' (3.0m)       | Solid     | 03510010    |            |
|                 | 100' (30.5m)     |           | 03510100    | 03800100   |
|                 | 250' (76.2m)     |           | 03510250    | 03800250   |
|                 | 10' (3.0m)       | Perf      | 03010010    |            |
|                 | 100' (30.5m)     |           | 03010100    | 03810100   |
|                 | 250' (76.2m)     |           | 03010250    | 03810250   |
|                 | 5500' (1676.4m)  |           |             | 03815500   |
|                 | 100' (30.5m)     | Perf/wrap | 03730100BS  | 03830100BS |
| 250' (76.2m)    | 03730250BS       |           | 03830250BS  |            |
| 4" (100mm)      | 10' (3.0m)       | Solid     | 04510010    |            |
|                 | 100' (30.5m)     |           | 04510100    | 04800100   |
|                 | 250' (76.2m)     |           | 04510250    | 04800250   |
|                 | 3200' (975.4m)   |           |             | 04803200   |
|                 | 10' (3.0m)       | Perf      | 04010010    |            |
|                 | 100' (30.5m)     |           | 04010100    | 04810100   |
|                 | 250' (76.2m)     |           | 04010250    | 04810250   |
|                 | 3200' (975.4m)   |           |             | 04813200   |
|                 | 100' (30.5m)     | Perf/wrap | 04730100BS  | 04830100BS |
|                 | 250' (76.2m)     |           | 04730250BS  | 04830250BS |
| 3200' (975.4m)  |                  |           | 048303200BS |            |
| 5" (125mm)      | 180' (54.9m)     | Solid     | 05510180    | 05800180   |
|                 | 180' (54.9m)     | Perf      | 05010180    | 05810180   |
|                 | 180' (54.9m)     | Perf/wrap | 05730180BS  | 05830180BS |
|                 | 2000' (609.6m)   | Perf      |             | 05812000   |
|                 | 2000' (609.6m)   | Perf/wrap |             | 05832000BS |
| 6" (150mm)      | 10' (3.0m)       | Solid     | 06510010    |            |
|                 | 20' (6.1m)       |           | 06510020    | 06800020   |
|                 | 100' (30.5m)     |           | 06510100    | 06800100   |
|                 | 1500' (457.2m)   |           |             | 06801500   |
|                 | 10' (3.0m)       | Perf      | 06010010    |            |
|                 | 20' (6.1m)       |           | 06010020    | 06810020   |
|                 | 100' (30.5m)     |           | 06010100    | 06810100   |
|                 | 1500' (457.2m)   |           |             | 06811500   |
|                 | 100' (30.5m)     | Perf/wrap | 06730100BS  | 06830100BS |
|                 | 1500' (457.2m)   |           |             | 06831500BS |
| 8" (200mm)      | 20' (6.1m)       | Solid     | 08510020    | 08800020   |
|                 | 820' (249.9m)    |           |             | 08800820   |
|                 | 20' (6.1m)       | Perf      | 08010020    | 08810020   |
|                 | 820' (249.9m)    |           |             | 08810820   |
|                 | 20' (6.1m)       | Perf/wrap | 08730020    | 08830020   |
|                 | 820' (249.9m)    |           |             | 08830820   |
| 10" (250mm)     | 20' (6.1m)       | Solid     | 10510020    | 10800020   |
|                 | 490' (149.4m)    |           |             | 10800520   |
|                 | 20' (6.1m)       | Perf      | 10010020    | 10810020   |
|                 | 520' (158.5m)    |           |             | 10810520   |
|                 | 20' (6.1m)       | Perf/wrap | 10730020    | 10830020   |
| 520' (158.5m)   |                  |           | 10830520    |            |

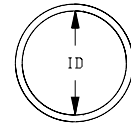
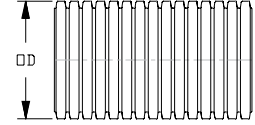

HEAVY DUTY PIPE

# SINGLE WALL PIPE

## HEAVY DUTY, CO-EX

### 12" - 24" HEAVY DUTY SINGLE WALL

| INSIDE DIAMETER | OUTSIDE DIAMETER | STANDARD LENGTHS | STYLE     | PRODUCT CODE |
|-----------------|------------------|------------------|-----------|--------------|
| 12" (300mm)     | 14.2" (361mm)    | 295' (90.0m)     | Plain     | 12510295     |
|                 |                  |                  | Perf      | 12010295     |
|                 |                  |                  | Perf/wrap | 12730295     |
| 12" (300mm)     | 14.2" (361mm)    | 20' (6.1m)       | Plain     | 12510020     |
|                 |                  |                  | Perf      | 12010020     |
| 15" (375mm)     | 17.7" (450mm)    | 20' (6.1m)       | Plain     | 15510020     |
|                 |                  |                  | Perf      | 15010020     |
| 18" (450mm)     | 21.5" (546mm)    | 20' (6.1m)       | Plain     | 18510020     |
|                 |                  |                  | Perf      | 18010020     |
| 24" (600mm)     | 28.4" (721mm)    | 20' (6.1m)       | Plain     | 24510020     |
|                 |                  |                  | Perf      | 24010020     |

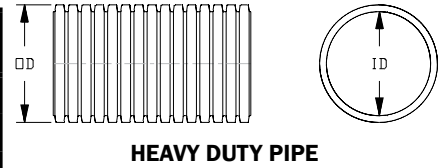

### 4"-6" CO-EX SINGLE WALL

| INSIDE DIAMETER | OUTSIDE DIAMETER | STANDARD LENGTHS | STYLE | PRODUCT CODE |
|-----------------|------------------|------------------|-------|--------------|
| 4" (100mm)      | 4.6" (117mm)     | 100' (30.5m)     | Plain | 04070100     |
|                 |                  | 250' (76.2m)     |       | 04070250     |
|                 |                  | 100' (30.5m)     | Perf  | 04080100     |
|                 |                  | 250' (76.2m)     |       | 04080250     |
|                 |                  | 3200' (975.4m)   |       | 04083200     |
| 6" (150mm)      | 6.?????"         | 100' (30.5m)     | Plain | 06070100     |
|                 |                  | 1500' (457.2m)   |       | 06071500     |
|                 |                  | 100' (30.5m)     | Perf  | 06080100     |
|                 |                  | 1500' (457.2m)   |       | 06081500     |

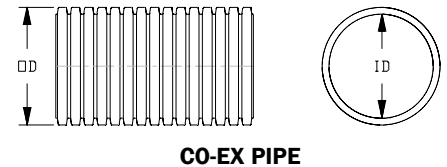

# SINGLE WALL PIPE

## CHANNEL MUCK, CHANNEL-FLOW<sup>®</sup>, GRAVELLESS

### 4" CHANNEL MUCK SINGLE WALL

| INSIDE DIAMETER | OUTSIDE DIAMETER | STANDARD LENGTHS | STYLE             | PRODUCT CODE |
|-----------------|------------------|------------------|-------------------|--------------|
| 4" (100mm)      | 4.7" (119mm)     | 100' (30.5m)     | Perf 3-hole, 360° | 04060100     |
|                 |                  | 250' (76.2m)     |                   | 04060250     |
|                 |                  | 3200' (975.4m)   |                   | 04063200     |
|                 |                  | 250' (76.2m)     | Perf/Wrap         | 04770250     |
|                 |                  | 2900' (883.9m)   |                   | 04772900     |

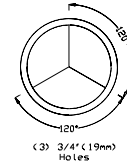
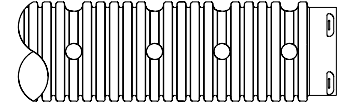

CHANNEL MUCK PIPE

### 4" CHANNEL-FLOW SINGLE WALL

| INSIDE DIAMETER | STANDARD LENGTHS | STYLE             | PRODUCT CODE |
|-----------------|------------------|-------------------|--------------|
| 4" (100mm)      | 10' (3.0m)       | Perf 3-hole, 120° | 04020010     |
|                 | 100' (30.5m)     |                   | 04020100     |
|                 | 250' (76.2m)     |                   | 04020250     |

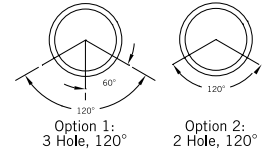
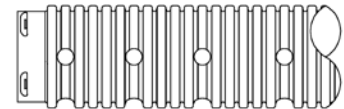

CHANNEL-FLOW PIPE

### 8", 10" SB2

| DIAMETER    | LENGTHS    | STYLE                   | PRODUCT CODE |
|-------------|------------|-------------------------|--------------|
| 8" (200mm)  | 10' (3.0m) | perf/cerex              | 08710010     |
|             |            | perf/cerex with coupler | 08710010WC   |
|             | 20' (6.1m) | perf/cerex              | 08710020     |
|             |            | perf/cerex with coupler | 08710020WC   |
|             |            | perf/cerex with coupler | 08710020WCH  |
|             |            | perf/sock               | 08710020WS   |
| 10" (250mm) | 10' (3.0m) | perf/cerex              | 10710010     |
|             |            | perf/cerex              | 10710010WC   |
|             |            | perf/sock with coupler  | 10710010WSH  |
|             | 20' (6.1m) | perf/cerex              | 10710020     |
|             |            | perf/cerex with coupler | 10710020WC   |
|             |            | perf/cerex with coupler | 10710020WCH  |
| 10" (250mm) | 20' (6.1m) | perf/sock               | 10710020WS   |
|             |            | perf/sock bundle wrap   | 10710020WSBW |
| 10" (250mm) | 20' (6.1m) | perf/sock with coupler  | 10710020WSH  |

### SYNTHETIC FILTER WRAP

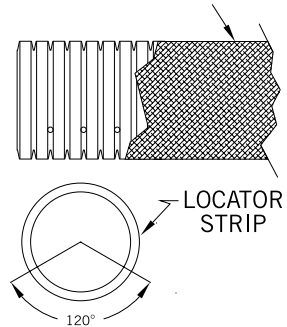

SB2<sup>®</sup>

# SINGLE WALL PIPE

## TURF FLOW®, POST-TENSIONING DUCT, GRAIN-AIRE®

### 2" TURF FLOW SINGLE WALL

| INSIDE DIAMETER | OUTSIDE DIAMETER | STANDARD LENGTHS | STYLE               | PRODUCT CODE |
|-----------------|------------------|------------------|---------------------|--------------|
| 2" (50mm)       | 2.4" (61mm)      | 25' (7.6m)       | Plain               | 02510025     |
|                 |                  | 100' (30.5m)     | Plain               | 02510100     |
|                 |                  |                  | Wide Slot           | 02010100     |
|                 |                  | 118' (36.0m)     | Wide Slot           | 02010118     |
|                 |                  |                  | Wide Slot with Wrap | 02730118     |
|                 |                  | 500' (152.4m)    | Narrow Slot         | 02510500NS   |
|                 |                  | 50' (15.2m)      | Wide Slot           | 02010050     |
|                 |                  | 300' (91.4m)     | Wide Slot           | 02010300     |
| 50' (15.2m)     | Plain            | 02510050         |                     |              |

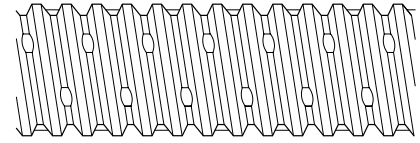

**TURF FLOW PIPE**

### POST-TENSIONING DUCT

| DIAMETER  | STANDARD LENGTH | PRODUCT CODE |
|-----------|-----------------|--------------|
| 2" (50mm) | 500' (152.4m)   | 02510500PT   |

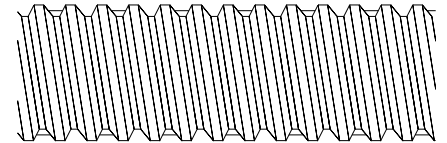

**POST-TENSIONING DUCT**

### GRAIN-AIRE PIPE WITH SCREEN SLEEVE

|                      | DESCRIPTION   | PRODUCT CODE |
|----------------------|---|--------------|
| Single Wall Pipe     | 15" (375mm) Grain-Aire Pipe 20' (6.1m) L                  | 15840020SW   |
|                      | 18" (450mm) Grain-Aire Pipe 20' (6.1m) L                  | 18840020SW   |
| Dual Wall Pipe       | 12" (300mm) Grain-Aire Pipe 20' (6.1m) L                  | 12840020     |
|                      | 15" (375mm) Grain-Aire Pipe 20' (6.1m) L                  | 15840020     |
|                      | 18" (450mm) Grain-Aire Pipe 20' (6.1m) L                  | 18840020     |
|                      | 24" (600mm) Grain-Aire Pipe 20' (6.1m) L                  | 24840020     |
|                      | 30" (750mm) Grain-Aire Pipe 20' (6.1m) L                  | 30840020     |
| Screen Fabric        | 18" (450mm) Grain-Aire Screen Fabric, 300' (91.4m) RL     | 1884HARL     |
|                      | 24" (600mm) Grain-Aire Screen Fabric, 300' (91.4m) RL     | 2484HARL     |
| Screen Fabric Sleeve | 12" (300mm) Grain-Aire Screen Fabric Sleeve, 21' (6.4m) L | 1284HA       |
|                      | 15" (375mm) Grain-Aire Screen Fabric Sleeve, 21' (6.4m) L | 1584HA       |
|                      | 18" (450mm) Grain-Aire Screen Fabric Sleeve, 21' (6.4m) L | 1884HA       |
|                      | 24" (600mm) Grain-Aire Screen Fabric Sleeve, 21' (6.4m) L | 2484HA       |
|                      | 30" (750mm) Grain-Aire Screen Fabric Sleeve, 21' (6.4m) L | 3084HA       |
|                      | 36" (900mm) Grain-Aire Screen Fabric Sleeve, 21' (6.4m) L | 3684HA       |

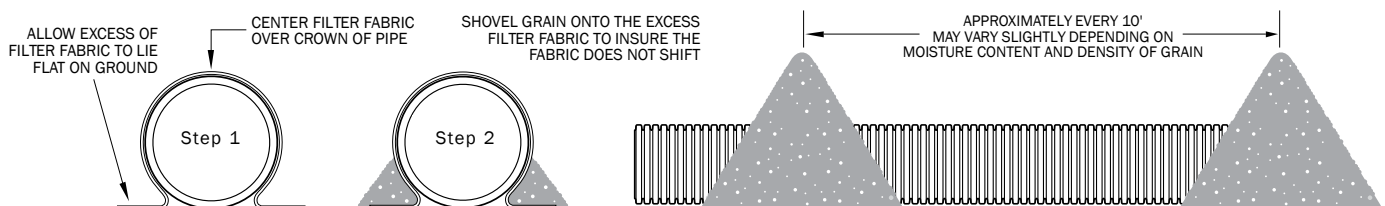

**GRAIN-AIRE PIPE**

# SMOOTHWALL, TRIPLEWALL PIPE

## 3", 4", 6" SMOOTHWALL SINGLE WALL

| DIAMETER   | AVG. OUTSIDE DIAMETER | STANDARD LENGTHS | STYLE                                      | PRODUCT CODE INLINE | PRODUCT CODE SPIN ON BELL* |
|------------|-----------------------|------------------|--|---------------------|----------------------------|
| 3" (75mm)  | 3.25" (83mm)          | 10' (3.0m)       | Plain                                      | 03560010            |                            |
|            |                       |                  | 2-hole, 120°                               | 03570010            |                            |
| 4" (100mm) | 4.215" (107mm)        | 10' (3.0m)       | Plain                                      | 04560010            | 04560010SP                 |
|            |                       |                  | 2-hole, 120°                               | 04570010            | 04570010SP                 |
|            |                       |                  | 3-hole, 120° <sup>5</sup> / <sub>8</sub> " | 04580010            | 04580010SP                 |
| 6" (150mm) | 6.275" (159mm)        | 10' (3.0m)       | Plain                                      | 06560010            |                            |
|            |                       |                  | 2-hole, 120°                               | 06570010            |                            |
|            |                       |                  | 3-hole, 120°                               | 06580010            |                            |

## 3", 4" ADS 3000 TRIPLEWALL®

| DIAMETER   | AVG. OUTSIDE DIAMETER | STANDARD LENGTHS | STYLE  | PRODUCT CODE |
|------------|-----------------------|------------------|--------|--------------|
| 3" (75mm)  | 3.25" (83mm)          | 10' (3.0m)       | Plain  | 0355-0010    |
|            |                       |                  | 2-hole | 0352-0010    |
| 4" (100mm) | 4.215" (107mm)        | 10' (3.0m)       | Plain  | 0455-0010    |
|            |                       |                  | 2-hole | 0452-0010    |
|            |                       |                  | 3-hole | 0453-0010    |

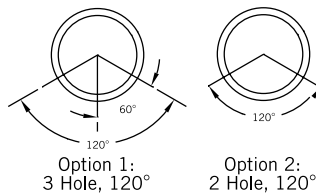
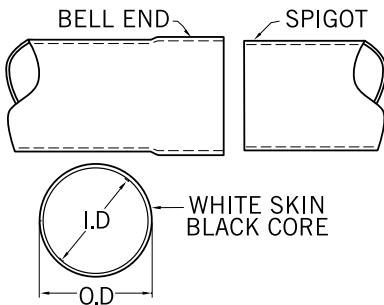

**SMOOTHWALL PIPE  
TRIPLEWALL PIPE**

# SOLID WALL PIPE

## ADS POLYFLEX™ IPS POTABLE GRADE PRESSURE PIPE

### SIDR 19 (100 psi) PE 4710

| SIZE        | COIL LENGTH    | MAXIMUM ALLOWABLE PRESSURE AT 73° F | PRODUCT CODE |
|-------------|----------------|-------------------------------------|--------------|
| ¾" (19 mm)  | 100' (30.5 m)  | 100 psi (690 kPa)                   | X2-75100100  |
| ¾" (19 mm)  | 300' (91.4 m)  | 100 psi (690 kPa)                   | X2-75100300  |
| ¾" (19 mm)  | 500' (152.4 m) | 100 psi (690 kPa)                   | X2-75100500  |
| 1" (25 mm)  | 100' (30.5 m)  | 100 psi (690 kPa)                   | X2-1100100   |
| 1" (25 mm)  | 300' (91.4 m)  | 100 psi (690 kPa)                   | X2-1100300   |
| 1" (25 mm)  | 500' (152.4 m) | 100 psi (690 kPa)                   | X2-1100500   |
| 1¼" (32 mm) | 100' (30.5 m)  | 100 psi (690 kPa)                   | X2-125100100 |
| 1¼" (32 mm) | 300' (91.4 m)  | 100 psi (690 kPa)                   | X2-125100300 |
| 1½" (38 mm) | 100' (30.5 m)  | 100 psi (690 kPa)                   | X2-150100100 |
| 1½" (38 mm) | 300' (91.4 m)  | 100 psi (690 kPa)                   | X2-150100300 |
| 2" (50 mm)  | 100' (30.5 m)  | 100 psi (690 kPa)                   | X2-2100100   |
| 2" (50 mm)  | 300' (91.4 m)  | 100 psi (690 kPa)                   | X2-2100300   |



### SIDR 15 (125 psi) PE 4710

| SIZE       | COIL LENGTH   | MAXIMUM ALLOWABLE PRESSURE AT 73° F | PRODUCT CODE |
|------------|---------------|-------------------------------------|--------------|
| ½" (13 mm) | 100' (30.5 m) | 125 psi (862 kPa)                   | X2-50125100  |
| ½" (13 mm) | 300' (91.4 m) | 125 psi (862 kPa)                   | X2-50125300  |



### SIDR 11.5 (160 psi) PE 4710

| SIZE        | COIL LENGTH    | MAXIMUM ALLOWABLE PRESSURE AT 73° F | PRODUCT CODE |
|-------------|----------------|-------------------------------------|--------------|
| ¾" (19 mm)  | 100' (30.5 m)  | 160 psi (1103 kPa)                  | X2-75160100  |
| ¾" (19 mm)  | 300' (91.4 m)  | 160 psi (1103 kPa)                  | X2-75160300  |
| ¾" (19 mm)  | 500' (152.4 m) | 160 psi (1103 kPa)                  | X2-75160500  |
| 1" (25 mm)  | 100' (30.5 m)  | 160 psi (1103 kPa)                  | X2-1160100   |
| 1" (25 mm)  | 300' (91.4 m)  | 160 psi (1103 kPa)                  | X2-1160300   |
| 1" (25 mm)  | 500' (152.4 m) | 160 psi (1103 kPa)                  | X2-1160500   |
| 1¼" (32 mm) | 100' (30.5 m)  | 160 psi (1103 kPa)                  | X2-125160100 |
| 1¼" (32 mm) | 300' (91.4 m)  | 160 psi (1103 kPa)                  | X2-125160300 |
| 1½" (38 mm) | 100' (30.5 m)  | 160 psi (1103 kPa)                  | X2-150160100 |
| 1½" (38 mm) | 300' (91.4 m)  | 160 psi (1103 kPa)                  | X2-150160300 |
| 2" (50 mm)  | 100' (30.5 m)  | 160 psi (1103 kPa)                  | X2-2160100   |
| 2" (50 mm)  | 300' (91.4 m)  | 160 psi (1103 kPa)                  | X2-2160300   |



OTHER LENGTHS AVAILABLE. LIMITED GEOGRAPHIC AVAILABILITY.

# SOLID WALL PIPE

## ADS POLYFLEX IPS POTABLE GRADE PRESSURE PIPE

### SIDR 9 (200 psi) PE 4710

| SIZE        | COIL LENGTH    | MAXIMUM ALLOWABLE PRESSURE AT 73° F | PRODUCT CODE |
|-------------|----------------|-------------------------------------|--------------|
| ¾" (19 mm)  | 100' (30.5 m)  | 200 psi (1379 kPa)                  | X2-75200100  |
| ¾" (19 mm)  | 300' (91.4 m)  | 200 psi (1379 kPa)                  | X2-75200300  |
| ¾" (19 mm)  | 500' (152.4 m) | 200 psi (1379 kPa)                  | X2-75200500  |
| 1" (25 mm)  | 100' (30.5 m)  | 200 psi (1379 kPa)                  | X2-1200100   |
| 1" (25 mm)  | 300' (91.4 m)  | 200 psi (1379 kPa)                  | X2-1200300   |
| 1" (25 mm)  | 500' (152.4 m) | 200 psi (1379 kPa)                  | X2-1200500   |
| 1¼" (32 mm) | 100' (30.5 m)  | 200 psi (1379 kPa)                  | X2-125200100 |
| 1¼" (32 mm) | 300' (91.4 m)  | 200 psi (1379 kPa)                  | X2-125200300 |
| 1½" (38 mm) | 100' (30.5 m)  | 200 psi (1379 kPa)                  | X2-150200100 |
| 1½" (38 mm) | 300' (91.4 m)  | 200 psi (1379 kPa)                  | X2-150200300 |
| 2" (50 mm)  | 100' (30.5 m)  | 200 psi (1379 kPa)                  | X2-2200100   |
| 2" (50 mm)  | 300' (91.4 m)  | 200 psi (1379 kPa)                  | X2-2200300   |



### SIDR 7 (250 psi) PE 4710

| SIZE        | COIL LENGTH    | MAXIMUM ALLOWABLE PRESSURE AT 73° F | PRODUCT CODE |
|-------------|----------------|-------------------------------------|--------------|
| ¾" (19 mm)  | 100' (30.5 m)  | 250 psi (1724 kPa)                  | X2-75250100  |
| ¾" (19 mm)  | 300' (91.4 m)  | 250 psi (1724 kPa)                  | X2-75250300  |
| ¾" (19 mm)  | 500' (152.4 m) | 250 psi (1724 kPa)                  | X2-75250500  |
| 1" (25 mm)  | 100' (30.5 m)  | 250 psi (1724 kPa)                  | X2-1250100   |
| 1" (25 mm)  | 300' (91.4 m)  | 250 psi (1724 kPa)                  | X2-1250300   |
| 1" (25 mm)  | 500' (152.4 m) | 250 psi (1724 kPa)                  | X2-1250500   |
| 1¼" (32 mm) | 100' (30.5 m)  | 250 psi (1724 kPa)                  | X2-125250100 |
| 1¼" (32 mm) | 300' (91.4 m)  | 250 psi (1724 kPa)                  | X2-125250300 |
| 1½" (38 mm) | 100' (30.5 m)  | 250 psi (1724 kPa)                  | X2-150250100 |
| 1½" (38 mm) | 300' (91.4 m)  | 250 psi (1724 kPa)                  | X2-150250300 |
| 2" (50 mm)  | 100' (30.5 m)  | 250 psi (1724 kPa)                  | X2-2250100   |
| 2" (50 mm)  | 300' (91.4 m)  | 250 psi (1724 kPa)                  | X2-2250300   |





# SOLID WALL PIPE

## ADS POLYFLEX UTILITY GRADE PRESSURE PIPE

### 80 psi NON-POTABLE

| SIZE        | COIL LENGTH   | MAXIMUM ALLOWABLE PRESSURE AT 73° F | PRODUCT CODE |
|-------------|---------------|-------------------------------------|--------------|
| ¾" (19 mm)  | 100' (30.5 m) | 80 psi (551 kPa)                    | 7580100      |
| ¾" (19 mm)  | 300' (91.4 m) | 80 psi (551 kPa)                    | 7580300      |
| 1" (25 mm)  | 100' (30.5 m) | 80 psi (551 kPa)                    | 180100       |
| 1" (25 mm)  | 300' (91.4 m) | 80 psi (551 kPa)                    | 180300       |
| 1¼" (32 mm) | 100' (30.5 m) | 80 psi (551 kPa)                    | 12580100     |
| 1¼" (32 mm) | 300' (91.4 m) | 80 psi (551 kPa)                    | 12580300     |
| 1½" (38 mm) | 100' (30.5 m) | 80 psi (551 kPa)                    | 15080100     |
| 1½" (38 mm) | 300' (91.4 m) | 80 psi (551 kPa)                    | 15080300     |
| 2" (50 mm)  | 100' (30.5 m) | 80 psi (551 kPa)                    | 280100       |
| 2" (50 mm)  | 300' (91.4 m) | 80 psi (551 kPa)                    | 280300       |



### 100 psi NON-POTABLE

| SIZE        | COIL LENGTH   | MAXIMUM ALLOWABLE PRESSURE AT 73° F | PRODUCT CODE |
|-------------|---------------|-------------------------------------|--------------|
| ¾" (19 mm)  | 100' (30.5 m) | 100 psi (689 kPa)                   | 75100100     |
| ¾" (19 mm)  | 300' (91.4 m) | 100 psi (689 kPa)                   | 75100300     |
| 1" (25 mm)  | 100' (30.5 m) | 100 psi (689 kPa)                   | 1100100      |
| 1" (25 mm)  | 300' (91.4 m) | 100 psi (689 kPa)                   | 1100300      |
| 1¼" (32 mm) | 100' (30.5 m) | 100 psi (689 kPa)                   | 125100100    |
| 1¼" (32 mm) | 300' (91.4 m) | 100 psi (689 kPa)                   | 125100300    |
| 1½" (38 mm) | 100' (30.5 m) | 100 psi (689 kPa)                   | 150100100    |
| 1½" (38 mm) | 300' (91.4 m) | 100 psi (689 kPa)                   | 150100300    |
| 2" (50 mm)  | 100' (30.5 m) | 100 psi (689 kPa)                   | 2100100      |
| 2" (50 mm)  | 300' (91.4 m) | 100 psi (689 kPa)                   | 2100300      |



### 125 psi NON-POTABLE

| SIZE       | COIL LENGTH   | MAXIMUM ALLOWABLE PRESSURE AT 73° F | PRODUCT CODE |
|------------|---------------|-------------------------------------|--------------|
| ½" (13 mm) | 100' (30.5 m) | 125 psi (862 kPa)                   | 50125100     |
| ½" (13 mm) | 300' (91.4 m) | 125 psi (862 kPa)                   | 50125300     |
| 1" (25 mm) | 100' (30.5 m) | 125 psi (862 kPa)                   | 1125100      |
| 1" (25 mm) | 300' (91.4 m) | 125 psi (862 kPa)                   | 1125300      |



# SOLID WALL PIPE

## ADS POLYFLEX COPPER TUBING SIZE PIPE

### SDR 9 (250 psi) PE 4710 (BLUE)

| SIZE        | COIL LENGTH    | MAXIMUM ALLOWABLE PRESSURE AT 73° F | PRODUCT CODE |
|-------------|----------------|-------------------------------------|--------------|
| ¾" (19 mm)  | 100' (30.5 m)  | 250 psi (1724 kPa)                  | X4-75250100  |
| ¾" (19 mm)  | 300' (91.4 m)  | 250 psi (1724 kPa)                  | X4-75250300  |
| ¾" (19 mm)  | 500' (152.4 m) | 250 psi (1724 kPa)                  | X4-75250500  |
| 1" (25 mm)  | 100' (30.5 m)  | 250 psi (1724 kPa)                  | X4-1250100   |
| 1" (25 mm)  | 300' (91.4 m)  | 250 psi (1724 kPa)                  | X4-1250300   |
| 1" (25 mm)  | 500' (152.4 m) | 250 psi (1724 kPa)                  | X4-1250500   |
| 1¼" (32 mm) | 100' (30.5 m)  | 250 psi (1724 kPa)                  | X4-125250100 |
| 1¼" (32 mm) | 300' (91.4 m)  | 250 psi (1724 kPa)                  | X4-125250300 |
| 1¼" (32 mm) | 500' (152.4 m) | 250 psi (1724 kPa)                  | X4-125250500 |
| 1½" (38 mm) | 100' (30.5 m)  | 250 psi (1724 kPa)                  | X4-150250100 |
| 1½" (38 mm) | 300' (91.4 m)  | 250 psi (1724 kPa)                  | X4-150250300 |
| 1½" (38 mm) | 500' (152.4 m) | 250 psi (1724 kPa)                  | X4-150250500 |
| 2" (50 mm)  | 100' (30.5 m)  | 250 psi (1724 kPa)                  | X4-2250100   |
| 2" (50 mm)  | 300' (91.4 m)  | 250 psi (1724 kPa)                  | X4-2250300   |
| 2" (50 mm)  | 500' (152.4 m) | 250 psi (1724 kPa)                  | X4-2250500   |



### SDR 9 (250 psi) PE 4710 (BLACK)

| SIZE        | COIL LENGTH    | MAXIMUM ALLOWABLE PRESSURE AT 73° F | PRODUCT CODE  |
|-------------|----------------|-------------------------------------|---------------|
| ¾" (19 mm)  | 100' (30.5 m)  | 250 psi (1724 kPa)                  | X4-75250100B  |
| ¾" (19 mm)  | 300' (91.4 m)  | 250 psi (1724 kPa)                  | X4-75250300B  |
| ¾" (19 mm)  | 500' (152.4 m) | 250 psi (1724 kPa)                  | X4-75250500B  |
| 1" (25 mm)  | 100' (30.5 m)  | 250 psi (1724 kPa)                  | X4-1250100B   |
| 1" (25 mm)  | 300' (91.4 m)  | 250 psi (1724 kPa)                  | X4-1250300B   |
| 1" (25 mm)  | 500' (152.4 m) | 250 psi (1724 kPa)                  | X4-1250500B   |
| 1¼" (32 mm) | 100' (30.5 m)  | 250 psi (1724 kPa)                  | X4-125250100B |
| 1¼" (32 mm) | 300' (91.4 m)  | 250 psi (1724 kPa)                  | X4-125250300B |
| 1¼" (32 mm) | 500' (152.4 m) | 250 psi (1724 kPa)                  | X4-125250500B |
| 1½" (38 mm) | 100' (30.5 m)  | 250 psi (1724 kPa)                  | X4-150250100B |
| 1½" (38 mm) | 300' (91.4 m)  | 250 psi (1724 kPa)                  | X4-150250300B |
| 1½" (38 mm) | 500' (152.4 m) | 250 psi (1724 kPa)                  | X4-150250500B |
| 2" (50 mm)  | 100' (30.5 m)  | 250 psi (1724 kPa)                  | X4-2250100B   |
| 2" (50 mm)  | 300' (91.4 m)  | 250 psi (1724 kPa)                  | X4-2250300B   |
| 2" (50 mm)  | 500' (152.4 m) | 250 psi (1724 kPa)                  | X4-2250500B   |



# COUPLERS

## N-12

### 4" - 24" EXTERNAL SNAP COUPLERS

| DIAMETER    | PRODUCT CODE |
|-------------|--------------|
| 4" (100mm)  | 0412AA       |
| 6" (150mm)  | 0613AA       |
| 8" (200mm)  | 0813AA       |
| 10" (250mm) | 1013AA       |
| 12" (300mm) | 1214AA       |
| 15" (375mm) | 1514AA       |
| 18" (450mm) | 1814AA       |
| 24" (600mm) | 2414AA       |

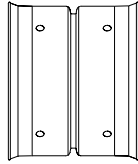

EXTERNAL SNAP COUPLER

### 10" - 60" SPLIT BAND COUPLERS

| DIAMETER     | PRODUCT CODE |                     |
|--------------|--------------|---------------------|
|              | Coupler only | Coupler with Gasket |
| 10" (250mm)  | 1011AA       | 1066AA              |
| 12" (300mm)  | 1265AA       | 1266AA              |
| 15" (375mm)  | 1565AA       | 1566AA              |
| 18" (450mm)  | 1865AA       | 1866AA              |
| 24" (600mm)  | 2465AA       | 2412AA              |
| 30" (750mm)  | 3065AA       | 3066AA              |
| 36" (900mm)  | 3661AA       | 3662AA              |
| 42" (1050mm) | 4265AA       | 4266AA              |
| 48" (1200mm) | 4865AA       | 4866AA              |
| 60" (1500mm) | 6065AA       | 6066AA              |

### 10" - 36" N-12 PLAIN END, PLAIN END DOUBLE WIDE COUPLER

| DIAMETER    | PRODUCT CODE |
|-------------|--------------|
| 10" (250mm) | 1069AA       |
| 12" (300mm) | 1269AA       |
| 15" (375mm) | 1569AA       |
| 18" (450mm) | 1869AA       |
| 24" (600mm) | 2469AA       |
| 30" (750mm) | 3069AA       |
| 36" (900mm) | 3669AC       |

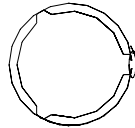

SPLIT COUPLER DOUBLE WIDE

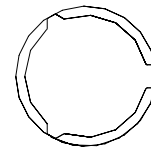
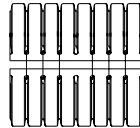

SPLIT COUPLER

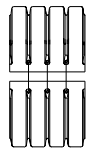

### WT MITERED BELL-BELL COUPLERS 12" - 60"

| DIAMETER     | ANGLE | PRODUCT CODE | ANGLE | PRODUCT CODE |
|--------------|-------|--------------|-------|--------------|
| 12" (300mm)  | 3°    | 1213ANMC03   | 5°    | 1213ANMC05   |
| 15" (375mm)  | 3°    | 1513ANMC03   | 5°    | 1513ANMC05   |
| 18" (450mm)  | 3°    | 1813ANMC03   | 5°    | 1813ANMC05   |
| 24" (600mm)  | 3°    | 2413ANMC03   | 5°    | 2413ANMC05   |
| 30" (750mm)  | 3°    | 3013ANMC03   | 5°    | 3013ANMC05   |
| 36" (900mm)  | 3°    | 3613ANMC03   | 5°    | 3613ANMC05   |
| 42" (1050mm) | 3°    | 4213ANMC03   | 5°    | 4213ANMC05   |
| 48" (1200mm) | 3°    | 4813ANMC03   | 5°    | 4813ANMC05   |
| 60" (1500mm) | 3°    | 6013ANMC03   | 5°    | 6013ANMC05   |

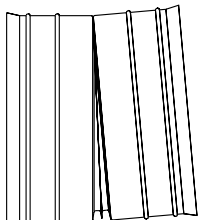

MITERED BELL/BELL COUPLER

### BELL-BELL COUPLERS 12" - 60"

| DIAMETER                        | PRODUCT CODE |          |
|---------------------------------|--------------|----------|
|                                 | N-12 ST      | N-12WT   |
| Double Bell Coupler + 2 gaskets |              |          |
| 12" (300mm)                     | 1215AA       | 1215AA   |
| 15" (375mm)                     | 1515AA       | 1515AA   |
| 18" (450mm)                     | 1815AA       | 1815AA   |
| 24" (600mm)                     | 2415AA       | 2415AA   |
| 30" (750mm)                     | 3013AN65     | 3013AN65 |
| 36" (900mm)                     | 3613AN65     | 3613AN65 |
| 42" (1050mm)                    | 4213AN85     | 4213AN65 |
| 48" (1200mm)                    | 4813AN85     | 4813AN65 |
| 60" (1500mm)                    | 6013AN85     | 6013AN65 |

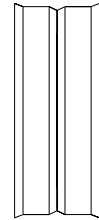

BELL/BELL COUPLER

# COUPLERS

## N-12

### NPC INTERNAL JOINT SEAL



| DIAMETER     | WIDTH         | PRODUCT CODE |
|--------------|---------------|--------------|
| 18" (450mm)  | 7.5" (190mm)  | 1891NS       |
|              | 10.5" (266mm) | 1892NS       |
| 24" (600mm)  | 7.5" (190mm)  | 2491NS       |
|              | 10.5" (266mm) | 2492NS       |
| 30" (750mm)  | 7.5" (190mm)  | 3091NS       |
|              | 10.5" (266mm) | 3092NS       |
| 36" (900mm)  | 7.5" (190mm)  | 3691NS       |
|              | 10.5" (266mm) | 3692NS       |
| 42" (1050mm) | 7.5" (190mm)  | 4291NS       |
|              | 10.5" (266mm) | 4292NS       |
| 48" (1200mm) | 7.5" (190mm)  | 4891NS       |
|              | 10.5" (266mm) | 4892NS       |
| 60" (1500mm) | 7.5" (190mm)  | 6091NS       |
|              | 10.5" (266mm) | 6092NS       |

### MAR-MAC® COUPLERS



| DIAMETER     | PRODUCT CODE |
|--------------|--------------|
| 8" (200mm)   | 0867RC       |
| 10" (250mm)  | 1067RC       |
| 12" (300mm)  | 1267RC       |
| 15" (375mm)  | 1567RC       |
| 18" (450mm)  | 1867RC       |
| 24" (600mm)  | 2467RC       |
| 30" (750mm)  | 3067RC       |
| 36" (900mm)  | 3667RC       |
| 42" (1050mm) | 4267RC       |
| 48" (1200mm) | 4867RC       |
| 54" (1350mm) | 5467RC       |
| 60" (1500mm) | 6067RC       |



**FIELD REPAIR COUPLER -  
SINGLE WIDE**

### MAR-MAC® COUPLERS DOUBLE WIDE



| DIAMETER     | PRODUCT CODE |
|--------------|--------------|
| 12" (300mm)  | 1267RCD      |
| 15" (375mm)  | 1567RCD      |
| 18" (450mm)  | 1867RCD      |
| 24" (600mm)  | 2467RCD      |
| 30" (750mm)  | 3067RCD      |
| 36" (900mm)  | 3667RCD      |
| 42" (1050mm) | 4267RCD      |
| 48" (1200mm) | 4867RCD      |
| 54" (1350mm) | 5467RCD      |
| 60" (1500mm) | 6067RCD      |

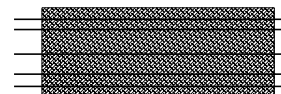

**FIELD REPAIR COUPLER -  
DOUBLE WIDE**

# LUBRICANT, REPAIR KITS

## LUBRICANTS



| DIAMETER     | BRUSH ON                                | BRUSH ON                                  |
|--------------|---|---|
|              | 1 QUART(0.9L)<br>PRODUCT CODE<br>0200LU | 1 GALLON (3.8L)<br>PRODUCT CODE<br>0800LU |
|              | Typical # Joints Covered*               |   |
| 4" (100mm)   | 89                                      | 356                                       |
| 6" (150mm)   | 61                                      | 244                                       |
| 8" (200mm)   | 43                                      | 172                                       |
| 10" (250mm)  | 33                                      | 132                                       |
| 12" (300mm)  | 25                                      | 100                                       |
| 15" (375mm)  | 20                                      | 80  |
| 18" (450mm)  | 16                                      | 64  |
| 24" (600mm)  | 10                                      | 40  |
| 30" (750mm)  | 9                                       | 36  |
| 36" (900mm)  | 7                                       | 28  |
| 42" (1050mm) | 6                                       | 24  |
| 48" (1200mm) | 6                                       | 24  |
| 54" (1350mm) | 5                                       | 20  |
| 60" (1500mm) | 5                                       | 20  |

\* Based on joints with single gasket. Pipe with dual gaskets will require 75% more lube to cover the same number of joints.

## PVC REPAIR SLEEVE

| DIAMETER     | PRODUCT CODE |
|--------------|--------------|
| 10" (250 mm) | 1075AG       |
| 12" (300 mm) | 1275AG       |
| 15" (375 mm) | 1575AG       |
| 18" (450 mm) | 1875AG       |
| 24" (600 mm) | 2475AG       |

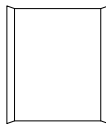

**PVC REPAIR SLEEVE**

TYPICALLY TWO REPAIR SLEEVES, GASKETS, LUBE AND A PIECE OF PIPE ARE NEEDED FOR POST INSTALLATION PIPE REPAIR.

NOTE: CONTACT YOUR LOCAL SALES REPRESENTATIVE FOR FIELD REPAIR OF 30"-60" (900-1500mm) DIAMETER PIPE AND FOR AVAILABILITY OF SIZES NOT LISTED.

# END CAPS & ADAPTERS TO SMOOTH HDPE

## N-12

### 12" - 60" END CAPS\*

| DIAMETER     | N-12 PLAIN END | N-12 WT<br>Includes 1 gasket |
|--------------|----------------|------------------------------|
| 12" (300mm)  | 1201AN         | 1201AN65B                    |
| 15" (375mm)  | 1501AN         | 1501AN65B                    |
| 18" (450mm)  | 1801AN         | 1801AN65B                    |
| 24" (600mm)  | 2401AN         | 2401AN65B                    |
| 30" (750mm)  | 3001AN         | 3001AN65B                    |
| 36" (900mm)  | 3601AN         | 3601AN65B                    |
| 42" (1050mm) | 4201AN         | 4201AN65B                    |
| 48" (1200mm) | 4801AN         | 4801AN65B                    |
| 60" (1500mm) | 6001AN         | 6001AN65B                    |



N-12 PLAIN END  
END CAP

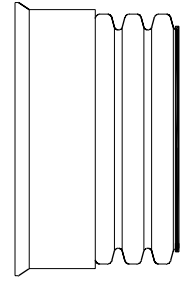

N-12 WT  
END CAP

\*END CAPS ARE FOR HORIZONTAL APPLICATIONS ONLY. END CAPS ARE NOT PERMITTED TO BE USED IN ANY VERTICAL APPLICATIONS. MISUSE OR FAILURE TO PROPERLY SECURE END CAPS MAY RESULT IN DAMAGE TO PERSONS OR PROPERTY OR MAY RESULT IN INJURY OR DEATH.

### DUAL WALL SNAP END CAPS - 6" - 10"

| DIAMETER    | PRODUCT CODE |
|-------------|--------------|
| 6" (150mm)  | 0667AA       |
| 8" (200mm)  | 0867AA       |
| 10" (250mm) | 1067AA       |

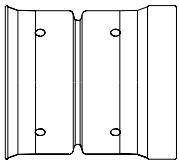

SNAP END CAP

### SEWER & DRAIN ADAPTER

| DIAMETER   | PRODUCT CODE |
|------------|--------------|
| 4" (100mm) | 0467AA       |

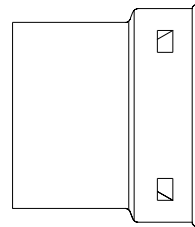

SEWER & DRAIN  
ADAPTER

### 8" - 60" NON-PRESSURE PIPE END PLUG WITH GASKETS\*



| DIAMETER     | PRODUCT CODE |
|--------------|--------------|
| 8" (200mm)   | 0833AA       |
| 10" (250mm)  | 1033AA       |
| 12" (300mm)  | 1233AA       |
| 15" (375mm)  | 1533AA       |
| 18" (450mm)  | 1833AA       |
| 24" (600mm)  | 2433AA       |
| 30" (750mm)  | 3033AA       |
| 36" (900mm)  | 3633AA       |
| 42" (1050mm) | 4233AA       |
| 48" (1200mm) | 4833AA       |
| 60" (1500mm) | 6033AA       |

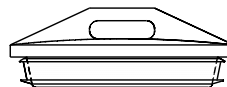
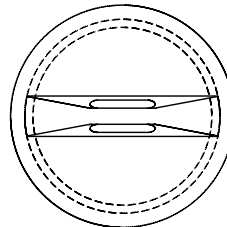

END PLUG

\* NOT INTENDED FOR PERMANENT USE OR VERTICAL ORIENTATION.

NOTE: CONTACT YOUR LOCAL SALES REPRESENTATIVE FOR AVAILABILITY OF SIZES NOT LISTED ABOVE.

# REDUCERS

## N-12

**DUAL WALL FABRICATED  
REDUCERS – 6" - 30"**

| <b>DIAMETER</b>           | <b>N-12 PLAIN END</b> | <b>N-12 ST<br/>BELL-AND-SPIGOT</b><br>Includes 2 gaskets | <b>N-12 WT</b><br>Includes 2 gaskets |
|---------------------------|-----------------------|--|--------------------------------------|
| 6" x 4" (150mm x 100mm)   | 0670AN                |  |                                      |
| 8" x 4" (200mm x 100mm)   | 0870AN                |  |                                      |
| 8" x 6" (200mm x 150mm)   | 0871AN                |  |                                      |
| 10" x 4" (250mm x 100mm)  | 1070AN                |  |                                      |
| 10" x 6" (250mm x 150mm)  | 1071AN                |  |                                      |
| 10" x 8" (250mm x 200mm)  | 1072AN                |  |                                      |
| 12" x 4" (300mm x 100mm)  | 1270AN                |  | 1270AN65B                            |
| 12" x 6" (300mm x 150mm)  | 1271AN                |  | 1271AN65B                            |
| 12" x 8" (300mm x 200mm)  | 1272AN                |  | 1272AN65B                            |
| 12" x 10" (300mm x 250mm) | 1273AN                |  | 1273AN65B                            |
| 15" x 4" (375mm x 100mm)  | 1570AN                |  | 1570AN65B                            |
| 15" x 6" (375mm x 150mm)  | 1571AN                |  | 1571AN65B                            |
| 15" x 8" (375mm x 200mm)  | 1572AN                |  | 1572AN65B                            |
| 15" x 10" (375mm x 250mm) | 1573AN                |  | 1573AN65B                            |
| 15" x 12" (375mm x 300mm) | 1574AN                | 1574AN85B  | 1574AN65B                            |
| 18" x 4" (450mm x 100mm)  | 1870AN                |  | 1870AN65B                            |
| 18" x 6" (450mm x 150mm)  | 1871AN                |  | 1871AN65B                            |
| 18" x 8" (450mm x 200mm)  | 1872AN                |  | 1872AN65B                            |
| 18" x 10" (450mm x 250mm) | 1873AN                |  | 1873AN65B                            |
| 18" x 12" (450mm x 300mm) | 1874AN                | 1874AN85B  | 1874AN65B                            |
| 18" x 15" (450mm x 375mm) | 1875AN                | 1875AN85B  | 1875AN65B                            |
| 24" x 4" (600mm x 100mm)  | 2470AN                |  | 2470AN65B                            |
| 24" x 6" (600mm x 150mm)  | 2471AN                |  | 2471AN65B                            |
| 24" x 8" (600mm x 200mm)  | 2472AN                |  | 2472AN65B                            |
| 24" x 10" (600mm x 250mm) | 2473AN                |  | 2473AN65B                            |
| 24" x 12" (600mm x 300mm) | 2474AN                | 2474AN85B  | 2474AN65B                            |
| 24" x 15" (600mm x 375mm) | 2475AN                | 2475AN85B  | 2475AN65B                            |
| 24" x 18" (600mm x 450mm) | 2476AN                | 2476AN85B  | 2476AN65B                            |
| 30" x 4" (750mm x 100mm)  | 3070AN                |  | 3070AN65B                            |
| 30" x 6" (750mm x 150mm)  | 3071AN                |  | 3071AN65B                            |
| 30" x 8" (750mm x 200mm)  | 3072AN                |  | 3072AN65B                            |
| 30" x 10" (750mm x 250mm) | 3073AN                |  | 3073AN65B                            |
| 30" x 12" (750mm x 300mm) | 3074AN                | 3074AN85B  | 3074AN65B                            |
| 30" x 15" (750mm x 375mm) | 3075AN                | 3075AN85B  | 3075AN65B                            |
| 30" x 18" (750mm x 450mm) | 3076AN                | 3076AN85B  | 3076AN65B                            |
| 30" x 24" (750mm x 600mm) | 3077AN                | 3077AN85B  | 3077AN65B                            |

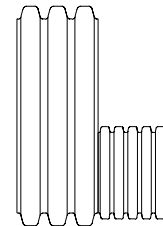

**N-12 PLAIN END REDUCER**

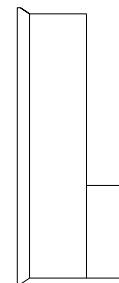

**N-12 ST AND  
N-12 WT REDUCER**

NOTE: CONTACT YOUR LOCAL SALES REPRESENTATIVE FOR AVAILABILITY OF SIZES NOT LISTED ABOVE.

# REDUCERS

## N-12

### DUAL WALL FABRICATED REDUCERS - 36" - 60"

| DIAMETER                    | N-12 PLAIN END | N-12 ST BELL-AND-SPIGOT<br>Includes 2 gaskets | N-12 WT<br>Includes 2 gaskets |
|-----------------------------|----------------|---|-------------------------------|
| 36" x 4" (900mm x 100mm)    | 3670AN         |   | 3670AN65B                     |
| 36" x 6" (900mm x 150mm)    | 3671AN         |   | 3671AN65B                     |
| 36" x 8" (900mm x 200mm)    | 3672AN         |   | 3672AN65B                     |
| 36" x 10" (900mm x 250mm)   | 3673AN         |   | 3673AN65B                     |
| 36" x 12" (900mm x 300mm)   | 3674AN         | 3674AN85B                                     | 3674AN65B                     |
| 36" x 15" (900mm x 375mm)   | 3675AN         | 3675AN85B                                     | 3675AN65B                     |
| 36" x 18" (900mm x 450mm)   | 3676AN         | 3676AN85B                                     | 3676AN65B                     |
| 36" x 24" (900mm x 600mm)   | 3677AN         | 3677AN85B                                     | 3677AN65B                     |
| 36" x 30" (900mm x 750mm)   | 3678AN         | 3678AN85B                                     | 3678AN65B                     |
| 42" x 6" (1050mm x 150mm)   | 4271AN         | 4271AN85B                                     | 4271AN65B                     |
| 42" x 8" (1050mm x 200mm)   | 4272AN         | 4272AN85B                                     | 4272AN65B                     |
| 42" x 10" (1050mm x 250mm)  | 4273AN         | 4273AN85B                                     | 4273AN65B                     |
| 42" x 12" (1050mm x 300mm)  | 4274AN         | 4274AN85B                                     | 4274AN65B                     |
| 42" x 15" (1050mm x 375mm)  | 4275AN         | 4275AN85B                                     | 4275AN65B                     |
| 42" x 18" (1050mm x 450mm)  | 4276AN         | 4276AN85B                                     | 4276AN65B                     |
| 42" x 24" (1050mm x 600mm)  | 4277AN         | 4277AN85B                                     | 4277AN65B                     |
| 42" x 30" (1050mm x 750mm)  | 4278AN         | 4278AN85B                                     | 4278AN65B                     |
| 42" x 36" (1050mm x 900mm)  | 4279AN         | 4279AN85B                                     | 4279AN65B                     |
| 48" x 12" (1200mm x 300mm)  | 4874AN         | 4874AN85B                                     | 4874AN65B                     |
| 48" x 15" (1200mm x 375mm)  | 4875AN         | 4875AN85B                                     | 4875AN65B                     |
| 48" x 18" (1200mm x 450mm)  | 4876AN         | 4876AN85B                                     | 4876AN65B                     |
| 48" x 24" (1200mm x 600mm)  | 4877AN         | 4877AN85B                                     | 4877AN65B                     |
| 48" x 30" (1200mm x 750mm)  | 4878AN         | 4878AN85B                                     | 4878AN65B                     |
| 48" x 36" (1200mm x 900mm)  | 4879AN         | 4879AN85B                                     | 4879AN65B                     |
| 48" x 42" (1200mm x 1050mm) | 4842AN         | 4842AN85B                                     | 4842AN65B                     |
| 60" x 24" (1500mm x 600mm)  | 6077AN         | 6077AN85B                                     | 6077AN65B                     |
| 60" x 30" (1500mm x 750mm)  | 6078AN         | 6078AN85B                                     | 6078AN65B                     |
| 60" x 36" (1500mm x 900mm)  | 6079AN         | 6079AN85B                                     | 6079AN65B                     |
| 60" x 42" (1500mm x 1050mm) | 6042AN         | 6042AN85B                                     | 6042AN65B                     |
| 60" x 48" (1500mm x 1200mm) | 6048AN         | 6048AN85B                                     | 6048AN65B                     |

TOP VIEW

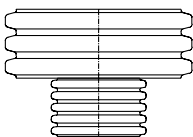

END VIEW

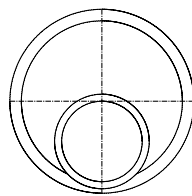

SIDE VIEW

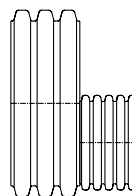

### FABRICATED REDUCERS

NOTE: CONTACT YOUR LOCAL SALES REPRESENTATIVE FOR AVAILABILITY OF SIZES NOT LISTED ABOVE.



# TAP REDUCERS

## N-12 WT

### TAP REDUCERS

| DIAMETER                 | N-12 WT<br>Includes 1 gasket |
|--------------------------|------------------------------|
| 6" x 4" (150mm x 100mm)  | 0670AN65BS                   |
| 8" x 4" (200mm x 100mm)  | 0870AN65BS                   |
| 8" x 6" (200mm x 150mm)  | 0871AN65BS                   |
| 10" x 4" (250mm x 100mm) | 1070AN65BS                   |
| 10" x 6" (250mm x 150mm) | 1071AN65BS                   |
| 10" x 8" (250mm x 200mm) | 1072AN65BS                   |
| 12" x 4" (300mm x 100mm) | 1270AN65BS                   |
| 12" x 6" (300mm x 150mm) | 1271AN65BS                   |
| 12" x 8" (300mm x 200mm) | 1272AN65BS                   |
| 15" x 4" (375mm x 100mm) | 1570AN65BS                   |
| 15" x 6" (375mm x 150mm) | 1571AN65BS                   |
| 15" x 8" (375mm x 200mm) | 1572AN65BS                   |
| 18" x 4" (450mm x 100mm) | 1870AN65BS                   |
| 18" x 6" (450mm x 150mm) | 1871AN65BS                   |
| 18" x 8" (450mm x 200mm) | 1872AN65BS                   |
| 24" x 4" (600mm x 100mm) | 2470AN65BS                   |
| 24" x 6" (600mm x 150mm) | 2471AN65BS                   |
| 24" x 8" (600mm x 200mm) | 2472AN65BS                   |
| 30" x 4" (750mm x 100mm) | 3070AN65BS                   |
| 30" x 6" (750mm x 150mm) | 3071AN65BS                   |
| 30" x 8" (750mm x 200mm) | 3072AN65BS                   |
| 36" x 4" (750mm x 100mm) | 3670AN65BS                   |
| 36" x 6" (750mm x 150mm) | 3671AN65BS                   |
| 36" x 8" (750mm x 200mm) | 3672AN65BS                   |

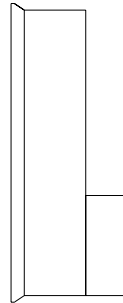

**N-12 WT**

# BENDS

## N-12

### DUAL WALL FABRICATED 11.25° BENDS – 4" - 60"

| DIAMETER     | N-12 PLAIN END | N-12 ST<br>Includes 2 gaskets | N-12 WT<br>Includes 2 gaskets |
|--------------|----------------|-------------------------------|-------------------------------|
| 4" (100mm)   | 0491AN         |                               |                               |
| 6" (150mm)   | 0691AN         |                               |                               |
| 8" (200mm)   | 0891AN         |                               |                               |
| 10" (250mm)  | 1091AN         |                               |                               |
| 12" (300mm)  | 1291AN         | 1291AN85B                     | 1291AN65B                     |
| 15" (375mm)  | 1591AN         | 1591AN85B                     | 1591AN65B                     |
| 18" (450mm)  | 1891AN         | 1891AN85B                     | 1891AN65B                     |
| 24" (600mm)  | 2491AN         | 2491AN85B                     | 2491AN65B                     |
| 30" (750mm)  | 3091AN         | 3091AN85B                     | 3091AN65B                     |
| 36" (900mm)  | 3691AN         | 3691AN85B                     | 3691AN65B                     |
| 42" (1050mm) | 4291AN         | 4291AN85B                     | 4291AN65B                     |
| 48" (1200mm) | 4891AN         | 4891AN85B                     | 4891AN65B                     |
| 60" (1500mm) | 6091AN         | 6091AN85B                     | 6091AN65B                     |

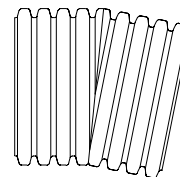

11.25° BEND  
N-12 PLAIN END,  
PLAIN END

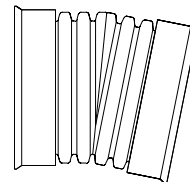

11.25° BEND  
N-12 ST AND N-12  
WT

### DUAL WALL FABRICATED 22.5° BENDS – 4" - 60"

| DIAMETER     | N-12 PLAIN END | N-12 ST<br>Includes 2 gaskets | N-12 WT<br>Includes 2 gaskets |
|--------------|----------------|-------------------------------|-------------------------------|
| 4" (100mm)   | 0492AN         |                               |                               |
| 6" (150mm)   | 0692AN         |                               |                               |
| 8" (200mm)   | 0892AN         |                               |                               |
| 10" (250mm)  | 1092AN         |                               |                               |
| 12" (300mm)  | 1292AN         | 1292AN85B                     | 1292AN65B                     |
| 15" (375mm)  | 1592AN         | 1592AN85B                     | 1592AN65B                     |
| 18" (450mm)  | 1892AN         | 1892AN85B                     | 1892AN65B                     |
| 24" (600mm)  | 2492AN         | 2492AN85B                     | 2492AN65B                     |
| 30" (750mm)  | 3092AN         | 3092AN85B                     | 3092AN65B                     |
| 36" (900mm)  | 3692AN         | 3692AN85B                     | 3692AN65B                     |
| 42" (1050mm) | 4292AN         | 4292AN85B                     | 4292AN65B                     |
| 48" (1200mm) | 4892AN         | 4892AN85B                     | 4892AN65B                     |
| 60" (1500mm) | 6092AN         | 6092AN85B                     | 6092AN65B                     |

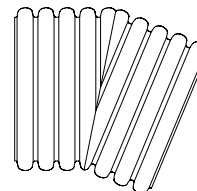

22.5° BEND  
N-12 PLAIN END,  
PLAIN END

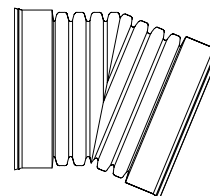

22.5° BEND  
N-12 ST AND  
N-12 WT

### DUAL WALL FABRICATED 30° BENDS – 4" - 60"

| DIAMETER     | N-12 PLAIN END | N-12 ST<br>Includes 2 gaskets | N-12 WT<br>Includes 2 gaskets |
|--------------|----------------|-------------------------------|-------------------------------|
| 4" (100mm)   | 0495AN         |                               |                               |
| 6" (150mm)   | 0695AN         |                               |                               |
| 8" (200mm)   | 0895AN         |                               |                               |
| 10" (250mm)  | 1095AN         |                               |                               |
| 12" (300mm)  | 1295AN         | 1295AN85B                     | 1295AN65B                     |
| 15" (375mm)  | 1595AN         | 1595AN85B                     | 1595AN65B                     |
| 18" (450mm)  | 1895AN         | 1895AN85B                     | 1895AN65B                     |
| 24" (600mm)  | 2495AN         | 2495AN85B                     | 2495AN65B                     |
| 30" (750mm)  | 3095AN         | 3095AN85B                     | 3095AN65B                     |
| 36" (900mm)  | 3695AN         | 3695AN85B                     | 3695AN65B                     |
| 42" (1050mm) | 4295AN         | 4295AN85B                     | 4295AN65B                     |
| 48" (1200mm) | 4895AN         | 4895AN85B                     | 4895AN65B                     |
| 60" (1500mm) | 6095AN         | 6095AN85B                     | 6095AN65B                     |

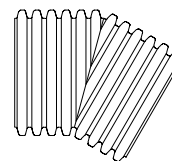

30° BEND  
N-12 PLAIN END,  
PLAIN END

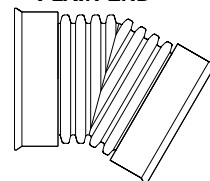

30° BEND  
N-12 ST AND N-12  
WT

NOTE: CONTACT YOUR LOCAL SALES REPRESENTATIVE FOR AVAILABILITY OF SIZES NOT LISTED ABOVE.

# BENDS

## N-12

### DUAL WALL FABRICATED 45° BENDS - 12" - 60"

| DIAMETER     | N-12 PLAIN END | N-12 WT<br>Includes 2 gaskets |
|--------------|----------------|-------------------------------|
| 12" (300mm)  | 1297AN         | 1297AN65BB                    |
| 15" (375mm)  | 1597AN         | 1597AN65BB                    |
| 18" (450mm)  | 1897AN         | 1897AN65BB                    |
| 24" (600mm)  | 2497AN         | 2497AN65BB                    |
| 30" (750mm)  | 3097AN         | 3097AN65BB                    |
| 36" (900mm)  | 3697AN         | 3697AN65BB                    |
| 42" (1050mm) | 4297AN         | 4297AN65BB                    |
| 48" (1200mm) | 4897AN         | 4897AN65BB                    |
| 60" (1500mm) | 6097AN         | 6097AN65BB                    |

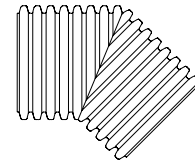

45° BEND  
N-12 PLAIN END,  
PLAIN END

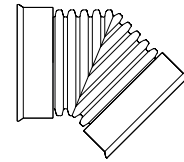

45° BEND  
N-12 ST AND N-12 WT

### DUAL WALL FABRICATED MITERED 45° BENDS - 12" - 60"

| DIAMETER     | N-12 PLAIN END | N-12 ST<br>Includes 2 gaskets | N-12 WT<br>Includes 2 gaskets |
|--------------|----------------|-------------------------------|-------------------------------|
| 12" (300mm)  | 1294AN         | 1294AN85B                     | 1294AN65B                     |
| 15" (375mm)  | 1594AN         | 1594AN85B                     | 1594AN65B                     |
| 18" (450mm)  | 1894AN         | 1894AN85B                     | 1894AN65B                     |
| 24" (600mm)  | 2494AN         | 2494AN85B                     | 2494AN65B                     |
| 30" (750mm)  | 3094AN         | 3094AN85B                     | 3094AN65B                     |
| 36" (900mm)  | 3694AN         | 3694AN85B                     | 3694AN65B                     |
| 42" (1050mm) | 4294AN         | 4294AN85B                     | 4294AN65B                     |
| 48" (1200mm) | 4894AN         | 4894AN85B                     | 4894AN65B                     |
| 60" (1500mm) | 6094AN         | 6094AN85B                     | 6094AN65B                     |

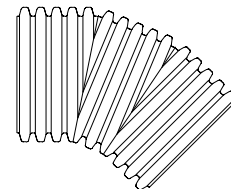

45° MITERED BEND  
N-12 PLAIN END,  
PLAIN END

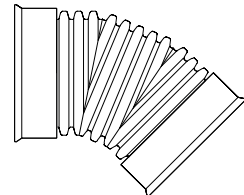

45° MITERED BEND  
N-12 ST AND N-12 WT

### DUAL WALL FABRICATED MITERED 90° BENDS - 12" - 18"

| DIAMETER    | N-12 PLAIN END | N-12 ST<br>Includes 2 gaskets | N-12 WT<br>Includes 2 gaskets |
|-------------|----------------|-------------------------------|-------------------------------|
| 12" (300mm) | 1299AN         | 1299AN85B                     | 1299AN65B                     |
| 15" (375mm) | 1599AN         | 1599AN85B                     | 1599AN65B                     |
| 18" (450mm) | 1899AN         | 1899AN85B                     | 1899AN65B                     |

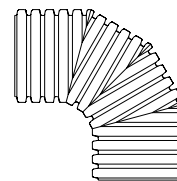

90° MITERED BEND  
PLAIN END

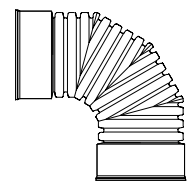

90° MITERED BEND  
N-12 ST AND N-12 WT

NOTE: CONTACT YOUR LOCAL SALES REPRESENTATIVE FOR AVAILABILITY OF SIZES NOT LISTED ABOVE.

# TEES

## N-12

### DUAL WALL FABRICATED TEES 12" - 60"

| DIAMETER     | N-12 PLAIN END | N-12 ST<br>Includes 3 gaskets | N-12 WT<br>Includes 3 gaskets |
|--------------|----------------|-------------------------------|-------------------------------|
| 12" (300mm)  | 1264AN         | 1264AN85B                     | 1264AN65B                     |
| 15" (375mm)  | 1565AN         | 1565AN85B                     | 1565AN65B                     |
| 18" (450mm)  | 1866AN         | 1866AN85B                     | 1866AN65B                     |
| 24" (600mm)  | 2467AN         | 2467AN85B                     | 2467AN65B                     |
| 30" (750mm)  | 3068AN         | 3068AN85B                     | 3068AN65B                     |
| 36" (900mm)  | 3669AN         | 3669AN85B                     | 3669AN65B                     |
| 42" (1050mm) | 4251AN         | 4251AN85B                     | 4251AN65BB                    |
| 48" (1200mm) | 4851AN         | 4851AN85B                     | 4851AN65BB                    |
| 60" (1500mm) | 6051AN         | 6051AN85B                     | 6051AN65BB                    |

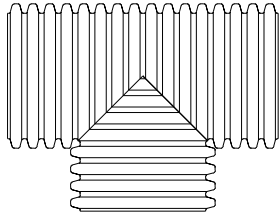

**TEE N-12 PLAIN END**

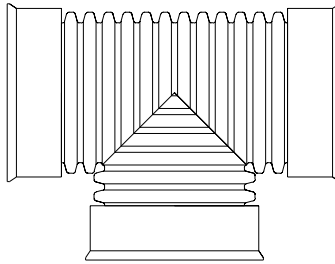

**TEE N-12 ST AND N-12 WT**

# REDUCING TEES

## N-12

### DUAL WALL FABRICATED REDUCING TEES – 10" - 36"

| DIAMETER                  | N-12 PLAIN END | N-12 ST<br>Includes 2 main and<br>1 stub gasket | N-12 WT<br>Includes 2 main and<br>1 stub gasket |
|---------------------------|----------------|---|---|
| 10" x 4" (250mm x 100mm)  | 1060AN         |   |   |
| 10" x 6" (250mm x 150mm)  | 1061AN         |   |   |
| 10" x 8" (250mm x 200mm)  | 1062AN         |   |   |
| 12" x 4" (300mm x 100mm)  | 1260AN         | 1260AN85B                                       | 1260AN65B                                       |
| 12" x 6" (300mm x 150mm)  | 1261AN         | 1261AN85B                                       | 1261AN65B                                       |
| 12" x 8" (300mm x 200mm)  | 1262AN         | 1262AN85B                                       | 1262AN65B                                       |
| 12" x 10" (300mm x 250mm) | 1263AN         | 1263AN85B                                       | 1263AN65B                                       |
| 15" x 4" (375mm x 100mm)  | 1560AN         | 1560AN85B                                       | 1560AN65B                                       |
| 15" x 6" (375mm x 150mm)  | 1561AN         | 1561AN85B                                       | 1561AN65B                                       |
| 15" x 8" (375mm x 200mm)  | 1562AN         | 1562AN85B                                       | 1562AN65B                                       |
| 15" x 10" (375mm x 250mm) | 1563AN         | 1563AN85B                                       | 1563AN65B                                       |
| 15" x 12" (375mm x 300mm) | 1564AN         | 1564AN85B                                       | 1564AN65B                                       |
| 18" x 4" (450mm x 100mm)  | 1860AN         | 1860AN85B                                       | 1860AN65B                                       |
| 18" x 6" (450mm x 150mm)  | 1861AN         | 1861AN85B                                       | 1861AN65B                                       |
| 18" x 8" (450mm x 200mm)  | 1862AN         | 1862AN85B                                       | 1862AN65B                                       |
| 18" x 10" (450mm x 250mm) | 1863AN         | 1863AN85B                                       | 1863AN65B                                       |
| 18" x 12" (450mm x 300mm) | 1864AN         | 1864AN85B                                       | 1864AN65B                                       |
| 18" x 15" (450mm x 375mm) | 1865AN         | 1865AN85B                                       | 1865AN65B                                       |
| 24" x 4" (600mm x 100mm)  | 2460AN         | 2460AN85B                                       | 2460AN65B                                       |
| 24" x 6" (600mm x 150mm)  | 2461AN         | 2461AN85B                                       | 2461AN65B                                       |
| 24" x 8" (600mm x 200mm)  | 2462AN         | 2462AN85B                                       | 2462AN65B                                       |
| 24" x 10" (600mm x 250mm) | 2463AN         | 2463AN85B                                       | 2463AN65B                                       |
| 24" x 12" (600mm x 300mm) | 2464AN         | 2464AN85B                                       | 2464AN65B                                       |
| 24" x 15" (600mm x 375mm) | 2465AN         | 2465AN85B                                       | 2465AN65B                                       |
| 24" x 18" (600mm x 450mm) | 2466AN         | 2466AN85B                                       | 2466AN65B                                       |
| 30" x 4" (750mm x 100mm)  | 3060AN         | 3060AN85B                                       | 3060AN65B                                       |
| 30" x 6" (750mm x 150mm)  | 3061AN         | 3061AN85B                                       | 3061AN65B                                       |
| 30" x 8" (750mm x 200mm)  | 3062AN         | 3062AN85B                                       | 3062AN65B                                       |
| 30" x 10" (750mm x 250mm) | 3063AN         | 3063AN85B                                       | 3063AN65B                                       |
| 30" x 12" (750mm x 300mm) | 3064AN         | 3064AN85B                                       | 3064AN65B                                       |
| 30" x 15" (750mm x 375mm) | 3065AN         | 3065AN85B                                       | 3065AN65B                                       |
| 30" x 18" (750mm x 450mm) | 3066AN         | 3066AN85B                                       | 3066AN65B                                       |
| 30" x 24" (750mm x 600mm) | 3067AN         | 3067AN85B                                       | 3067AN65B                                       |
| 36" x 4" (900mm x 100mm)  | 3660AN         | 3660AN85B                                       | 3660AN65B                                       |
| 36" x 6" (900mm x 150mm)  | 3661AN         | 3661AN85B                                       | 3661AN65B                                       |
| 36" x 8" (900mm x 200mm)  | 3662AN         | 3662AN85B                                       | 3662AN65B                                       |
| 36" x 10" (900mm x 250mm) | 3663AN         | 3663AN85B                                       | 3663AN65B                                       |
| 36" x 12" (900mm x 300mm) | 3664AN         | 3664AN85B                                       | 3664AN65B                                       |
| 36" x 15" (900mm x 375mm) | 3665AN         | 3665AN85B                                       | 3665AN65B                                       |
| 36" x 18" (900mm x 450mm) | 3666AN         | 3666AN85B                                       | 3666AN65B                                       |
| 36" x 24" (900mm x 600mm) | 3667AN         | 3667AN85B                                       | 3667AN65B                                       |
| 36" x 30" (900mm x 750mm) | 3668AN         | 3668AN85B                                       | 3668AN65B                                       |

END VIEW

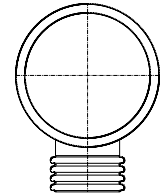

TOP VIEW

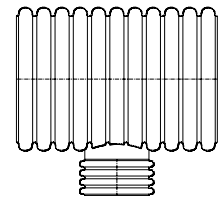

**N-12 PLAIN END**

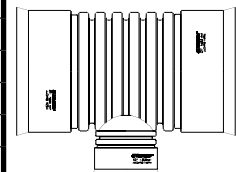

**N-12 ST  
& N-12 WT**

NOTE: CONTACT YOUR LOCAL SALES REPRESENTATIVE FOR AVAILABILITY OF SIZES NOT LISTED ABOVE.

# REDUCING TEES

## N-12

### DUAL WALL FABRICATED REDUCING TEES – 42" - 60"

| DIAMETER                    | N-12 PLAIN END | N-12 ST<br>Includes 2 main and<br>1 stub gasket | N-12 WT<br>Includes 2 main<br>and 1 stub gasket |
|-----------------------------|----------------|---|---|
| 42" x 4" (1050mm x 100mm)   | 4260AN         | 4260AN85B                                       | 4260AN65B                                       |
| 42" x 6" (1050mm x 150mm)   | 4261AN         | 4261AN85B                                       | 4261AN65B                                       |
| 42" x 8" (1050mm x 200mm)   | 4262AN         | 4262AN85B                                       | 4262AN65B                                       |
| 42" x 10" (1050mm x 250mm)  | 4263AN         | 4263AN85B                                       | 4263AN65B                                       |
| 42" x 12" (1050mm x 300mm)  | 4264AN         | 4264AN85B                                       | 4264AN65B                                       |
| 42" x 15" (1050mm x 375mm)  | 4265AN         | 4265AN85B                                       | 4265AN65B                                       |
| 42" x 18" (1050mm x 450mm)  | 4266AN         | 4266AN85B                                       | 4266AN65B                                       |
| 42" x 24" (1050mm x 600mm)  | 4267AN         | 4267AN85B                                       | 4267AN65B                                       |
| 42" x 30" (1050mm x 750mm)  | 4268AN         | 4268AN85B                                       | 4268AN65B                                       |
| 42" x 36" (1050mm x 900mm)  | 4269AN         | 4269AN85B                                       | 4269AN65B                                       |
| 48" x 4" (1200mm x 100mm)   | 4860AN         | 4860AN85B                                       | 4860AN65B                                       |
| 48" x 6" (1200mm x 150mm)   | 4861AN         | 4861AN85B                                       | 4861AN65B                                       |
| 48" x 8" (1200mm x 200mm)   | 4862AN         | 4862AN85B                                       | 4862AN65B                                       |
| 48" x 10" (1200mm x 250mm)  | 4863AN         | 4863AN85B                                       | 4863AN65B                                       |
| 48" x 12" (1200mm x 300mm)  | 4864AN         | 4864AN85B                                       | 4864AN65B                                       |
| 48" x 15" (1200mm x 375mm)  | 4865AN         | 4865AN85B                                       | 4865AN65B                                       |
| 48" x 18" (1200mm x 450mm)  | 4866AN         | 4866AN85B                                       | 4866AN65B                                       |
| 48" x 24" (1200mm x 600mm)  | 4867AN         | 4867AN85B                                       | 4867AN65B                                       |
| 48" x 30" (1200mm x 750mm)  | 4868AN         | 4868AN85B                                       | 4868AN65B                                       |
| 48" x 36" (1200mm x 900mm)  | 4869AN         | 4869AN85B                                       | 4869AN65B                                       |
| 48" x 42" (1200mm x 1050mm) | 4840AN         | 4840AN85B                                       | 4840AN65B                                       |
| 60" x 4" (1500mm x 100mm)   | 6060AN         | 6060AN85B                                       | 6060AN65B                                       |
| 60" x 6" (1500mm x 150mm)   | 6061AN         | 6061AN85B                                       | 6061AN65B                                       |
| 60" x 8" (1500mm x 200mm)   | 6062AN         | 6062AN85B                                       | 6062AN65B                                       |
| 60" x 10" (1500mm x 250mm)  | 6063AN         | 6063AN85B                                       | 6063AN65B                                       |
| 60" x 12" (1500mm x 300mm)  | 6064AN         | 6064AN85B                                       | 6064AN65B                                       |
| 60" x 15" (1500mm x 375mm)  | 6065AN         | 6065AN85B                                       | 6065AN65B                                       |
| 60" x 18" (1500mm x 450mm)  | 6066AN         | 6066AN85B                                       | 6066AN65B                                       |
| 60" x 24" (1500mm x 600mm)  | 6067AN         | 6067AN85B                                       | 6067AN65B                                       |
| 60" x 30" (1500mm x 750mm)  | 6068AN         | 6068AN85B                                       | 6068AN65B                                       |
| 60" x 36" (1500mm x 900mm)  | 6069AN         | 6069AN85B                                       | 6069AN65B                                       |
| 60" x 42" (1500mm x 1050mm) | 6040AN         | 6040AN85B                                       | 6040AN65B                                       |
| 60" x 48" (1500mm x 1200mm) | 6041AN         | 6041AN85B                                       | 6041AN65B                                       |

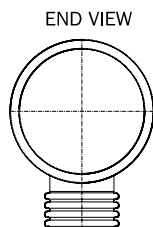

N-12 PLAIN END

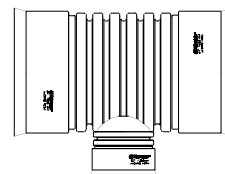
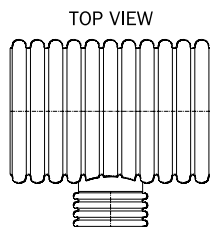

N-12 ST & N-12 WT

NOTE: CONTACT YOUR LOCAL SALES REPRESENTATIVE FOR AVAILABILITY OF SIZES NOT LISTED ABOVE.

# REDUCING TAP & CROSS TEES

## N-12

### REDUCING HDPE TAP TEES

| DIAMETER                 | N-12 WT<br>Includes 2 gaskets |
|--------------------------|-------------------------------|
| 6" x 4" (150mm x 100mm)  | 0660AN65BS                    |
| 8" x 4" (200mm x 100mm)  | 0860AN65BS                    |
| 8" x 6" (200mm x 150mm)  | 0861AN65BS                    |
| 10" x 4" (250mm x 100mm) | 1060AN65BS                    |
| 10" x 6" (250mm x 150mm) | 1061AN65BS                    |
| 10" x 8" (250mm x 200mm) | 1062AN65BS                    |
| 12" x 4" (300mm x 100mm) | 1260AN65BS                    |
| 12" x 6" (300mm x 150mm) | 1261AN65BS                    |
| 12" x 8" (300mm x 200mm) | 1262AN65BS                    |
| 15" x 4" (375mm x 100mm) | 1560AN65BS                    |
| 15" x 6" (375mm x 150mm) | 1561AN65BS                    |
| 15" x 8" (375mm x 200mm) | 1562AN65BS                    |
| 18" x 4" (450mm x 100mm) | 1860AN65BS                    |
| 18" x 6" (450mm x 150mm) | 1861AN65BS                    |
| 18" x 8" (450mm x 200mm) | 1862AN65BS                    |
| 24" x 4" (600mm x 100mm) | 2460AN65BS                    |
| 24" x 6" (600mm x 150mm) | 2461AN65BS                    |
| 24" x 8" (600mm x 200mm) | 2462AN65BS                    |
| 30" x 4" (750mm x 100mm) | 3060AN65BS                    |
| 30" x 6" (750mm x 150mm) | 3061AN65BS                    |
| 30" x 8" (750mm x 200mm) | 3062AN65BS                    |
| 36" x 4" (750mm x 100mm) | 3660AN65BS                    |
| 36" x 6" (750mm x 150mm) | 3661AN65BS                    |
| 36" x 8" (750mm x 200mm) | 3662AN65BS                    |

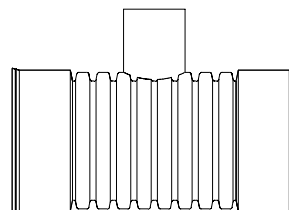

REDUCING TAP TEE

### REDUCING CROSS TEES

| DIAMETER                  | N-12 PLAIN END |
|---------------------------|----------------|
| 6" x 4" (150mm x 100mm)   | 0630AN         |
| 8" x 4" (200mm x 100mm)   | 0830AN         |
| 8" x 6" (200mm x 150mm)   | 0831AN         |
| 10" x 4" (250mm x 100mm)  | 1030AN         |
| 10" x 6" (250mm x 150mm)  | 1031AN         |
| 10" x 8" (250mm x 200mm)  | 1032AN         |
| 12" x 4" (300mm x 100mm)  | 1230AN         |
| 12" x 6" (300mm x 150mm)  | 1231AN         |
| 12" x 8" (300mm x 200mm)  | 1232AN         |
| 12" x 10" (300mm x 250mm) | 1233AN         |

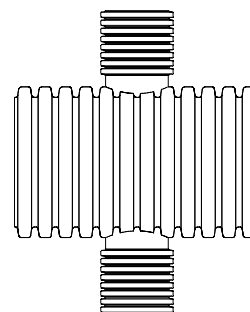

REDUCING CROSS TEE

NOTE: CONTACT YOUR LOCAL SALES REPRESENTATIVE FOR AVAILABILITY OF SIZES NOT LISTED ABOVE.

# SADDLE TEES AND CROSS TEES

## N-12

### REDUCING SADDLE TEES

| DIAMETER                    | N-12 ST |
|-----------------------------|---------|
| 8" x 4" (200 mm x 100 mm)   | 0840AN  |
| 10" x 4" (250 mm x 100 mm)  | 1040AN  |
| 10" x 6" (250 mm x 150 mm)  | 1041AN  |
| 12" x 4" (300 mm x 100 mm)  | 1240AN  |
| 12" x 6" (300 mm x 150 mm)  | 1241AN  |
| 12" x 8" (300 mm x 200 mm)  | 1242AN  |
| 15" x 4" (375 mm x 100 mm)  | 1540AN  |
| 15" x 6" (375 mm x 150 mm)  | 1541AN  |
| 15" x 8" (375 mm x 200 mm)  | 1542AN  |
| 18" x 4" (450 mm x 100 mm)  | 1840AN  |
| 18" x 6" (450 mm x 150 mm)  | 1841AN  |
| 18" x 8" (450 mm x 200 mm)  | 1842AN  |
| 24" x 4" (600 mm x 100 mm)  | 2440AN  |
| 24" x 6" (600 mm x 150 mm)  | 2441AN  |
| 24" x 8" (600 mm x 200 mm)  | 2442AN  |
| 24" x 10" (600 mm x 250 mm) | 2443AN  |
| 30" x 4" (750 mm x 100 mm)  | 3040AN  |
| 30" x 6" (750 mm x 150 mm)  | 3041AN  |
| 30" x 8" (750 mm x 200 mm)  | 3042AN  |
| 30" x 10" (750 mm x 250 mm) | 3043AN  |
| 30" x 12" (750 mm x 300 mm) | 3044AN  |
| 30" x 15" (750 mm x 375 mm) | 3045AN  |
| 36" x 4" (900 mm x 100 mm)  | 3640AN  |
| 36" x 6" (900 mm x 150 mm)  | 3641AN  |
| 36" x 8" (900 mm x 200 mm)  | 3642AN  |
| 36" x 10" (900 mm x 250 mm) | 3643AN  |
| 36" x 12" (900 mm x 300 mm) | 3644AN  |
| 36" x 15" (900 mm x 375 mm) | 3645AN  |
| 36" x 18" (900 mm x 450 mm) | 3646AN  |

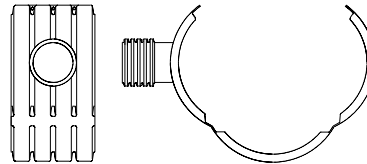

REDUCING SADDLE TEE

### 4" - 24" CROSS TEES

| DIAMETER    | N-12 PLAIN END |
|-------------|----------------|
| 4" (100mm)  | 0430AN         |
| 6" (150mm)  | 0631AN         |
| 8" (200mm)  | 0832AN         |
| 10" (250mm) | 1033AN         |
| 12" (300mm) | 1234AN         |
| 15" (375mm) | 1535AN         |
| 18" (450mm) | 1836AN         |
| 24" (600mm) | 2437AN         |

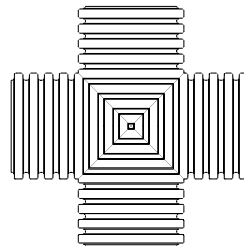

N-12 PLAIN END

NOTE: CONTACT YOUR LOCAL SALES REPRESENTATIVE FOR AVAILABILITY OF SIZES NOT LISTED ABOVE.



# WYES

## N-12

**DUAL WALL FABRICATED 45°  
STANDARD WYES 12" - 24"**

| DIAMETER    | N-12 PLAIN END | N-12 ST<br>BELL-AND-SPIGOT<br>Includes 3 gaskets | N-12 WT<br>Includes 3 gaskets |
|-------------|----------------|--|-------------------------------|
| 12" (300mm) | 1284AN         | 1284AN85B  | 1284AN65B                     |
| 15" (375mm) | 1585AN         | 1585AN85B  | 1585AN65B                     |
| 18" (450mm) | 1886AN         | 1886AN85B  | 1886AN65B                     |
| 24" (600mm) | 2487AN         | 2487AN85B  | 2487AN65B                     |

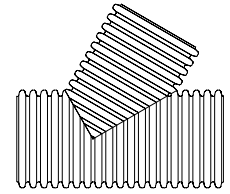

**WYE N-12 PLAIN  
END**

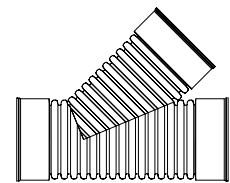

**WYE N-12 ST AND  
N-12 WT**

**DUAL WALL FABRICATED 60°  
STANDARD WYES 18" - 24"**

| DIAMETER    | N-12 PLAIN END | N-12 ST<br>BELL-AND-SPIGOT<br>Includes 3 gaskets | N-12 WT     |
|-------------|----------------|--|-------------|
| 18" (450mm) | 1886AN60       | 1886AN6085B                                      | 1886AN6065B |
| 24" (600mm) | 2487AN60       | 2487AN6085B                                      | 2487AN6065B |

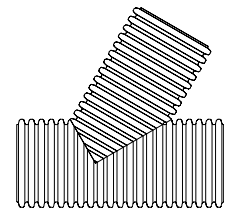

**60° WYE  
N-12 PLAIN END**

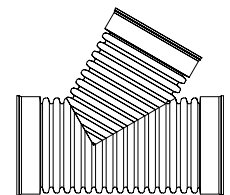

**60° WYE  
N-12 ST AND N-12  
WT**

# REDUCING WYES

## N-12

**DUAL WALL FABRICATED 45 DEGREE  
REDUCING WYES – 10" - 60"**

| DIAMETER                   | N-12 PLAIN END | N-12 ST<br>BELL-AND-SPIGOT<br>Includes 2 main and<br>1 stub gasket | N-12 WT<br>Includes 2 main and<br>1 stub gasket |
|----------------------------|----------------|--|---|
| 10" x 4" (250mm x 100mm)   | 1080AN         |  |   |
| 10" x 6" (250mm x 150mm)   | 1081AN         |  |   |
| 10" x 8" (250mm x 200mm)   | 1082AN         |  |   |
| 12" x 4" (300mm x 100mm)   | 1280AN         | 1280AN85B  | 1280AN65B                                       |
| 12" x 6" (300mm x 150mm)   | 1281AN         | 1281AN85B  | 1281AN65B                                       |
| 12" x 8" (300mm x 200mm)   | 1282AN         | 1282AN85B  | 1282AN65B                                       |
| 12" x 10" (300mm x 250mm)  | 1283AN         | 1283AN85B  | 1283AN65B                                       |
| 15" x 4" (375mm x 100mm)   | 1580AN         | 1580AN85B  | 1580AN65B                                       |
| 15" x 6" (375mm x 150mm)   | 1581AN         | 1581AN85B  | 1581AN65B                                       |
| 15" x 8" (375mm x 200mm)   | 1582AN         | 1582AN85B  | 1582AN65B                                       |
| 15" x 10" (375mm x 250mm)  | 1583AN         | 1583AN85B  | 1583AN65B                                       |
| 15" x 12" (375mm x 300mm)  | 1584AN         | 1584AN85B  | 1584AN65B                                       |
| 18" x 4" (450mm x 100mm)   | 1880AN         | 1880AN85B  | 1880AN65B                                       |
| 18" x 6" (450mm x 150mm)   | 1881AN         | 1881AN85B  | 1881AN65B                                       |
| 18" x 8" (450mm x 200mm)   | 1882AN         | 1882AN85B  | 1882AN65B                                       |
| 18" x 10" (450mm x 250mm)  | 1883AN         | 1883AN85B  | 1883AN65B                                       |
| 18" x 12" (450mm x 300mm)  | 1884AN         | 1884AN85B  | 1884AN65B                                       |
| 18" x 15" (450mm x 375mm)  | 1885AN         | 1885AN85B  | 1885AN65B                                       |
| 24" x 4" (600mm x 100mm)   | 2480AN         | 2480AN85B  | 2480AN65B                                       |
| 24" x 6" (600mm x 150mm)   | 2481AN         | 2481AN85B  | 2481AN65B                                       |
| 24" x 8" (600mm x 200mm)   | 2482AN         | 2482AN85B  | 2482AN65B                                       |
| 24" x 10" (600mm x 250mm)  | 2483AN         | 2483AN85B  | 2483AN65B                                       |
| 24" x 12" (600mm x 300mm)  | 2484AN         | 2484AN85B  | 2484AN65B                                       |
| 30" x 4" (750mm x 100mm)   | 3080AN         | 3080AN85B  | 3080AN65B                                       |
| 30" x 6" (750mm x 150mm)   | 3081AN         | 3081AN85B  | 3081AN65B                                       |
| 30" x 8" (750mm x 200mm)   | 3082AN         | 3082AN85B  | 3082AN65B                                       |
| 30" x 10" (750mm x 250mm)  | 3083AN         | 3083AN85B  | 3083AN65B                                       |
| 30" x 12" (750mm x 300mm)  | 3084AN         | 3084AN85B  | 3084AN65B                                       |
| 30" x 15" (750mm x 375mm)  | 3085AN         | 3085AN85B  | 3085AN65B                                       |
| 36" x 4" (900mm x 100mm)   | 3680AN         | 3680AN85B  | 3680AN65B                                       |
| 36" x 6" (900mm x 150mm)   | 3681AN         | 3681AN85B  | 3681AN65B                                       |
| 36" x 8" (900mm x 200mm)   | 3682AN         | 3682AN85B  | 3682AN65B                                       |
| 36" x 10" (900mm x 250mm)  | 3683AN         | 3683AN85B  | 3683AN65B                                       |
| 36" x 12" (900mm x 300mm)  | 3684AN         | 3684AN85B  | 3684AN65B                                       |
| 36" x 15" (900mm x 375mm)  | 3685AN         | 3685AN85B  | 3685AN65B                                       |
| 36" x 18" (900mm x 450mm)  | 3686AN         | 3686AN85B  | 3686AN65B                                       |
| 42" x 4" (1050mm x 100mm)  | 4280AN         | 4280AN85B  | 4280AN65B                                       |
| 42" x 6" (1050mm x 150mm)  | 4281AN         | 4281AN85B  | 4281AN65B                                       |
| 42" x 8" (1050mm x 200mm)  | 4282AN         | 4282AN85B  | 4282AN65B                                       |
| 42" x 10" (1050mm x 250mm) | 4283AN         | 4283AN85B  | 4283AN65B                                       |
| 42" x 12" (1050mm x 300mm) | 4284AN         | 4284AN85B  | 4284AN65B                                       |
| 42" x 15" (1050mm x 375mm) | 4285AN         | 4285AN85B  | 4285AN65B                                       |
| 42" x 18" (1050mm x 450mm) | 4286AN         | 4286AN85B  | 4286AN65B                                       |
| 48" x 4" (1200mm x 100mm)  | 4880AN         | 4880AN85B  | 4880AN65B                                       |
| 48" x 6" (1200mm x 150mm)  | 4881AN         | 4881AN85B  | 4881AN65B                                       |
| 48" x 8" (1200mm x 200mm)  | 4882AN         | 4882AN85B  | 4882AN65B                                       |
| 48" x 10" (1200mm x 250mm) | 4883AN         | 4883AN85B  | 4883AN65B                                       |
| 48" x 12" (1200mm x 300mm) | 4884AN         | 4884AN85B  | 4884AN65B                                       |
| 48" x 15" (1200mm x 375mm) | 4885AN         | 4885AN85B  | 4885AN65B                                       |
| 48" x 18" (1200mm x 450mm) | 4886AN         | 4886AN85B  | 4886AN65B                                       |
| 48" x 24" (1200mm x 600mm) | 4887AN         | 4887AN85B  | 4887AN65B                                       |
| 60" x 4" (1500mm x 100mm)  | 6080AN         | 6080AN85B  | 6080AN65B                                       |
| 60" x 6" (1500mm x 150mm)  | 6081AN         | 6081AN85B  | 6081AN65B                                       |
| 60" x 8" (1500mm x 200mm)  | 6082AN         | 6082AN85B  | 6082AN65B                                       |
| 60" x 10" (1500mm x 250mm) | 6083AN         | 6083AN85B  | 6083AN65B                                       |
| 60" x 12" (1500mm x 300mm) | 6084AN         | 6084AN85B  | 6084AN65B                                       |
| 60" x 15" (1500mm x 375mm) | 6085AN         | 6085AN85B  | 6085AN65B                                       |
| 60" x 18" (1500mm x 450mm) | 6086AN         | 6086AN85B  | 6086AN65B                                       |
| 60" x 24" (1500mm x 600mm) | 6087AN         | 6087AN85B  | 6087AN65B                                       |

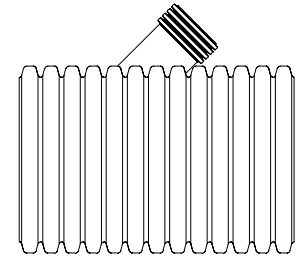

**45° REDUCING WYE  
PLAIN END**

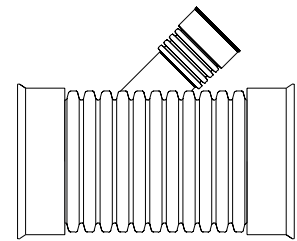

**45° REDUCING WYE N-12  
ST AND  
N-12 WT**

NOTE: CONTACT YOUR LOCAL SALES REPRESENTATIVE FOR AVAILABILITY OF SIZES NOT LISTED ABOVE.

# REDUCING WYES

## N-12

**DUAL WALL FABRICATED 60 DEGREE REDUCING WYES – 18" - 60"**

| DIAMETER                   | N-12 PLAIN END | N-12 ST BELL-AND-SPIGOT<br>Includes 2 main and 1 stub gasket | N-12 WT<br>Includes 2 main and 1 stub gasket |
|----------------------------|----------------|--|--|
| 18" x 4" (450mm x 100mm)   | 1880AN60       | 1880AN6085B  | 1880AN6065B                                  |
| 18" x 6" (450mm x 150mm)   | 1881AN60       | 1881AN6085B  | 1881AN6065B                                  |
| 18" x 8" (450mm x 200mm)   | 1882AN60       | 1882AN6085B  | 1882AN6065B                                  |
| 18" x 10" (450mm x 250mm)  | 1883AN60       | 1883AN6085B  | 1883AN6065B                                  |
| 18" x 12" (450mm x 300mm)  | 1884AN60       | 1884AN6085B  | 1884AN6065B                                  |
| 18" x 15" (450mm x 375mm)  | 1885AN60       | 1885AN6085B  | 1885AN6065B                                  |
| 24" x 4" (600mm x 100mm)   | 2480AN60       | 2480AN6085B  | 2480AN6065B                                  |
| 24" x 6" (600mm x 150mm)   | 2481AN60       | 2481AN6085B  | 2481AN6065B                                  |
| 24" x 8" (600mm x 200mm)   | 2482AN60       | 2482AN6085B  | 2482AN6065B                                  |
| 24" x 10" (600mm x 250mm)  | 2483AN60       | 2483AN6085B  | 2483AN6065B                                  |
| 24" x 12" (600mm x 300mm)  | 2484AN60       | 2484AN6085B  | 2484AN6065B                                  |
| 24" x 15" (600mm x 375mm)  | 2485AN60       | 2485AN6085B  | 2485AN6065B                                  |
| 24" x 18" (600mm x 450mm)  | 2486AN60       | 2486AN6085B  | 2486AN6065B                                  |
| 30" x 4" (750mm x 100mm)   | 3080AN60       | 3080AN6085B  | 3080AN6065B                                  |
| 30" x 6" (750mm x 150mm)   | 3081AN60       | 3081AN6085B  | 3081AN6065B                                  |
| 30" x 8" (750mm x 200mm)   | 3082AN60       | 3082AN6085B  | 3082AN6065B                                  |
| 30" x 10" (750mm x 250mm)  | 3083AN60       | 3083AN6085B  | 3083AN6065B                                  |
| 30" x 12" (750mm x 300mm)  | 3084AN60       | 3084AN6085B  | 3084AN6065B                                  |
| 30" x 15" (750mm x 375mm)  | 3085AN60       | 3085AN6085B  | 3085AN6065B                                  |
| 30" x 18" (750mm x 450mm)  | 3086AN60       | 3086AN6085B  | 3086AN6065B                                  |
| 30" x 24" (750mm x 600mm)  | 3087AN60       | 3087AN6085B  | 3087AN6065B                                  |
| 36" x 4" (900mm x 100mm)   | 3680AN60       | 3680AN6085B  | 3680AN6065B                                  |
| 36" x 6" (900mm x 150mm)   | 3681AN60       | 3681AN6085B  | 3681AN6065B                                  |
| 36" x 8" (900mm x 200mm)   | 3682AN60       | 3682AN6085B  | 3682AN6065B                                  |
| 36" x 10" (900mm x 250mm)  | 3683AN60       | 3683AN6085B  | 3683AN6065B                                  |
| 36" x 12" (900mm x 300mm)  | 3684AN60       | 3684AN6085B  | 3684AN6065B                                  |
| 36" x 15" (900mm x 375mm)  | 3685AN60       | 3685AN6085B  | 3685AN6065B                                  |
| 36" x 18" (900mm x 450mm)  | 3686AN60       | 3686AN6085B  | 3686AN6065B                                  |
| 36" x 24" (900mm x 600mm)  | 3687AN60       | 3687AN6085B  | 3687AN6065B                                  |
| 42" x 4" (1050mm x 100mm)  | 4280AN60       | 4280AN6085B  | 4280AN6065B                                  |
| 42" x 6" (1050mm x 150mm)  | 4281AN60       | 4281AN6085B  | 4281AN6065B                                  |
| 42" x 8" (1050mm x 200mm)  | 4282AN60       | 4282AN6085B  | 4282AN6065B                                  |
| 42" x 10" (1050mm x 250mm) | 4283AN60       | 4283AN6085B  | 4283AN6065B                                  |
| 42" x 12" (1050mm x 300mm) | 4284AN60       | 4284AN6085B  | 4284AN6065B                                  |
| 42" x 15" (1050mm x 375mm) | 4285AN60       | 4285AN6085B  | 4285AN6065B                                  |
| 42" x 18" (1050mm x 450mm) | 4286AN60       | 4286AN6085B  | 4286AN6065B                                  |
| 42" x 24" (1050mm x 600mm) | 4287AN60       | 4287AN6085B  | 4287AN6065B                                  |
| 48" x 4" (1200mm x 100mm)  | 4880AN60       | 4880AN6085B  | 4880AN6065B                                  |
| 48" x 6" (1200mm x 150mm)  | 4881AN60       | 4881AN6085B  | 4881AN6065B                                  |
| 48" x 8" (1200mm x 200mm)  | 4882AN60       | 4882AN6085B  | 4882AN6065B                                  |
| 48" x 10" (1200mm x 250mm) | 4883AN60       | 4883AN6085B  | 4883AN6065B                                  |
| 48" x 12" (1200mm x 300mm) | 4884AN60       | 4884AN6085B  | 4884AN6065B                                  |
| 48" x 15" (1200mm x 375mm) | 4885AN60       | 4885AN6085B  | 4885AN6065B                                  |
| 48" x 18" (1200mm x 450mm) | 4886AN60       | 4886AN6085B  | 4886AN6065B                                  |
| 48" x 24" (1200mm x 600mm) | 4887AN60       | 4887AN6085B  | 4887AN6065B                                  |
| 60" x 4" (1500mm x 100mm)  | 6080AN60       | 6080AN6085B  | 6080AN6065B                                  |
| 60" x 6" (1500mm x 150mm)  | 6081AN60       | 6081AN6085B  | 6081AN6065B                                  |
| 60" x 8" (1500mm x 200mm)  | 6082AN60       | 6082AN6085B  | 6082AN6065B                                  |
| 60" x 10" (1500mm x 250mm) | 6083AN60       | 6083AN6085B  | 6083AN6065B                                  |
| 60" x 12" (1500mm x 300mm) | 6084AN60       | 6084AN6085B  | 6084AN6065B                                  |
| 60" x 15" (1500mm x 375mm) | 6085AN60       | 6085AN6085B  | 6085AN6065B                                  |
| 60" x 18" (1500mm x 450mm) | 6086AN60       | 6086AN6085B  | 6086AN6065B                                  |
| 60" x 24" (1500mm x 600mm) | 6087AN60       | 6087AN6085B  | 6087AN6065B                                  |

TOP VIEW

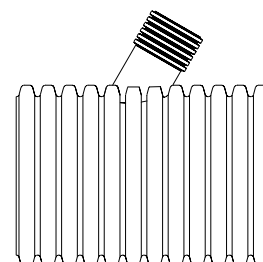

END VIEW

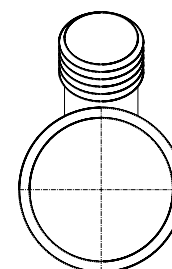

**N-12 PLAIN END REDUCING WYES**

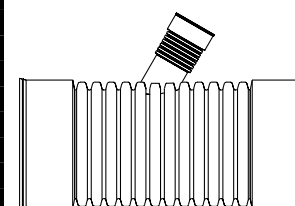

**60° REDUCING WYE  
N-12 ST AND  
N-12 WT**

NOTE: CONTACT YOUR LOCAL SALES REPRESENTATIVE FOR AVAILABILITY OF SIZES NOT LISTED ABOVE.

# REDUCING TAP WYES

## N-12 WT

### REDUCING 45° TAP WYES

| DIAMETER |                 | N-12 WT<br>Includes 2 main gaskets |
|----------|-----------------|------------------------------------|
| 6" x 4"  | (150mm x 100mm) | 0680AN65BS                         |
| 8" x 4"  | (200mm x 100mm) | 0880AN65BS                         |
| 8" x 6"  | (200mm x 150mm) | 0881AN65BS                         |
| 10" x 4" | (250mm x 100mm) | 1080AN65BS                         |
| 10" x 6" | (250mm x 150mm) | 1081AN65BS                         |
| 10" x 8" | (250mm x 200mm) | 1082AN65BS                         |
| 12" x 4" | (300mm x 100mm) | 1280AN65BS                         |
| 12" x 6" | (300mm x 150mm) | 1281AN65BS                         |
| 12" x 8" | (300mm x 200mm) | 1282AN65BS                         |
| 15" x 4" | (375mm x 100mm) | 1580AN65BS                         |
| 15" x 6" | (375mm x 150mm) | 1581AN65BS                         |
| 15" x 8" | (375mm x 200mm) | 1582AN65BS                         |
| 18" x 4" | (450mm x 100mm) | 1880AN65BS                         |
| 18" x 6" | (450mm x 150mm) | 1881AN65BS                         |
| 18" x 8" | (450mm x 200mm) | 1882AN65BS                         |
| 24" x 4" | (600mm x 100mm) | 2480AN65BS                         |
| 24" x 6" | (600mm x 150mm) | 2481AN65BS                         |
| 24" x 8" | (600mm x 200mm) | 2482AN65BS                         |
| 30" x 4" | (750mm x 100mm) | 3080AN65BS                         |
| 30" x 6" | (750mm x 150mm) | 3081AN65BS                         |
| 30" x 8" | (750mm x 200mm) | 3082AN65BS                         |

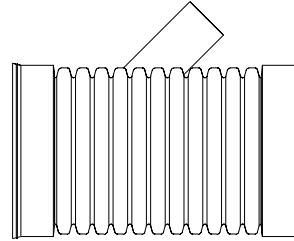

**REDUCING WYE**

# INJECTION MOLDED FITTINGS

## SOIL-TIGHT FITTINGS (Cleated Bells)

### TEE, BELL/BELL

| SIZE        | PRODUCT CODE |
|-------------|--------------|
| 4" (100mm)  | 0460ST       |
| 6" (150mm)  | 0661ST       |
| 8" (200mm)  | 0862ST       |
| 10" (250mm) | 1063ST       |
| 12" (300mm) | 1264ST       |

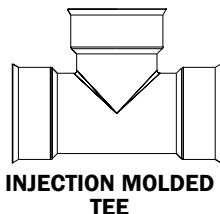

### REDUCING TEE

| SIZE                    | PRODUCT CODE |
|-------------------------|--------------|
| 6" x 4" (150 x 100 mm)  | 0660ST       |
| 10" x 8" (250 x 200 mm) | 1062ST       |
| 12" x 8" (300 x 200 mm) | 1262ST       |

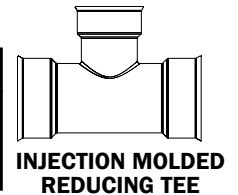

### 45° WYE, BELL/BELL

| SIZE        | PRODUCT CODE |
|-------------|--------------|
| 4" (100mm)  | 0480ST       |
| 6" (150mm)  | 0681ST       |
| 8" (200mm)  | 0882ST       |
| 10" (250mm) | 1083ST       |
| 12" (300mm) | 1284ST       |

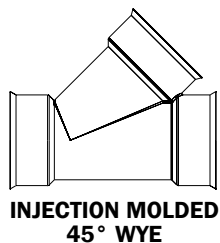

### 45° REDUCING WYE

| SIZE                   | PRODUCT CODE |
|------------------------|--------------|
| 6" x 4" (150 x 100mm)  | 0680ST       |
| 8" x 4" (200 x 100mm)  | 0880ST       |
| 8" x 6" (200 x 150mm)  | 0881ST       |
| 10" x 8" (250 x 200mm) | 1082ST       |

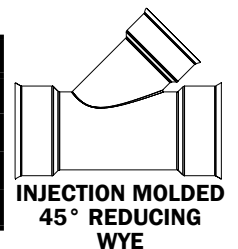

### 45° ELBOW, BELL/BELL

| SIZE        | PRODUCT CODE |
|-------------|--------------|
| 4" (100mm)  | 0494ST       |
| 6" (150mm)  | 0694ST       |
| 8" (200mm)  | 0894ST       |
| 10" (250mm) | 1094ST       |
| 12" (300mm) | 1294ST       |

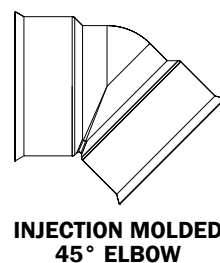

### SWEEPING TEE

| SIZE                   | PRODUCT CODE |
|------------------------|--------------|
| 8" x 4" (200 x 100mm)  | 0863ST       |
| 8" x 6" (200 x 150mm)  | 0836ST       |
| 10" x 6" (250 x 150mm) | 1036ST       |

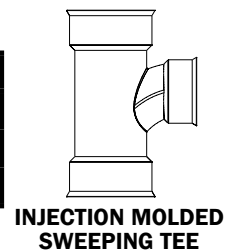

### 90° ELBOW, BELL/BELL

| SIZE        | PRODUCT CODE |
|-------------|--------------|
| 4" (100mm)  | 0499ST       |
| 6" (150mm)  | 0699ST       |
| 8" (200mm)  | 0899ST       |
| 10" (250mm) | 1099ST       |
| 12" (300mm) | 1299ST       |

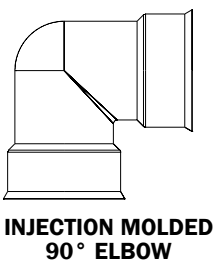

# INJECTION MOLDED FITTINGS

**WATERTIGHT FITTINGS** (includes F477 gaskets for attachment on pipe end)

## TEE, BELL/BELL

| SIZE        | PRODUCT CODE |
|-------------|--------------|
| 4" (100mm)  | 0460WT       |
| 6" (150mm)  | 0661WT       |
| 8" (200mm)  | 0862WT       |
| 10" (250mm) | 1063WT       |
| 12" (300mm) | 1264WT       |

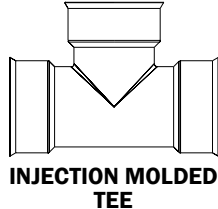

## REDUCING TEE

| SIZE                   | PRODUCT CODE |
|------------------------|--------------|
| 6" x 4" (150 x 100mm)  | 0660WT       |
| 10" x 8" (250 x 200mm) | 1062WT       |
| 12" x 8" (300 x 200mm) | 1262WT       |

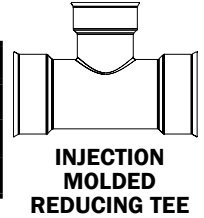

## 45° WYE, BELL/BELL

| SIZE        | PRODUCT CODE |
|-------------|--------------|
| 4" (100mm)  | 0480WT       |
| 6" (150mm)  | 0681WT       |
| 8" (200mm)  | 0882WT       |
| 10" (250mm) | 1083WT       |
| 12" (300mm) | 1284WT       |

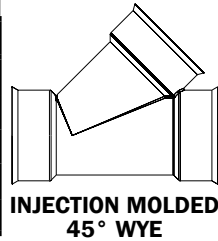

## 45° REDUCING WYE

| SIZE                   | PRODUCT CODE |
|------------------------|--------------|
| 6" x 4" (150 x 100mm)  | 0680WT       |
| 8" x 4" (200 x 100mm)  | 0880WT       |
| 8" x 6" (200 x 150mm)  | 0881WT       |
| 10" x 8" (250 x 200mm) | 1082WT       |
| 12" x 6" (300 x 150mm) | 1281WT       |
| 12" x 8" (300 x 200mm) | 1282WT       |

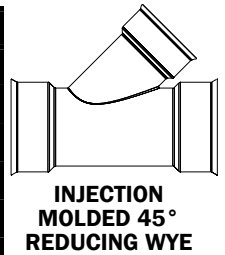

## 45° ELBOW, BELL/BELL

| SIZE        | PRODUCT CODE |
|-------------|--------------|
| 4" (100mm)  | 0494WT       |
| 6" (150mm)  | 0694WT       |
| 8" (200mm)  | 0894WT       |
| 10" (250mm) | 1094WT       |
| 12" (300mm) | 1294WT       |

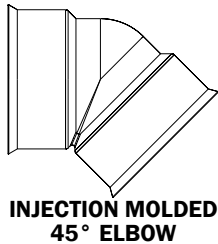

## SWEEPING TEE

| SIZE                   | PRODUCT CODE |
|------------------------|--------------|
| 8" x 4" (200 x 100mm)  | 0863WT       |
| 8" x 6" (200 x 150mm)  | 0836WT       |
| 10" x 6" (250 x 150mm) | 1036WT       |
| 12" x 6" (300 x 150mm) | 1236WT       |

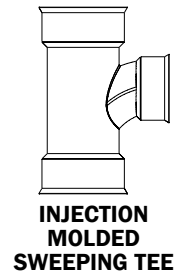

## 90° ELBOW, BELL/BELL

| SIZE        | PRODUCT CODE |
|-------------|--------------|
| 4" (100mm)  | 0499WT       |
| 6" (150mm)  | 0699WT       |
| 8" (200mm)  | 0899WT       |
| 10" (250mm) | 1099WT       |
| 12" (300mm) | 1299WT       |

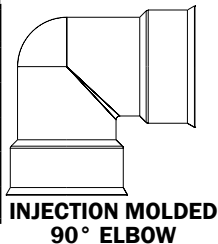

## END CAP

| SIZE       | PRODUCT CODE |
|------------|--------------|
| 4" (100mm) | 0432WT       |
| 6" (150mm) | 0632WT       |

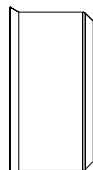

# INJECTION MOLDED FITTINGS

## WATERTIGHT FITTINGS

### COUPLER, BELL/BELL

| SIZE        | PRODUCT CODE |
|-------------|--------------|
| 4" (100mm)  | 0413WT       |
| 6" (150mm)  | 0613WT       |
| 8" (200mm)  | 0813WT       |
| 10" (250mm) | 1013WT       |

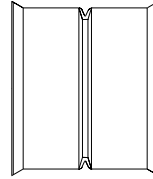

**INJECTION MOLDED BELL/BELL COUPLER**

### REDUCING COUPLER, BELL/BELL

| SIZE                    | PRODUCT CODE |
|-------------------------|--------------|
| 6" x 4" (150 x 100mm)   | 0614WT       |
| 8" x 4" (200 x 100mm)   | 0814WT       |
| 8" x 6" (200 x 150mm)   | 0816WT       |
| 10" x 8" (250 x 200mm)  | 1018WT       |
| 12" x 8" (300 x 200mm)  | 1218WT       |
| 12" x 10" (300 x 250mm) | 1210WT       |

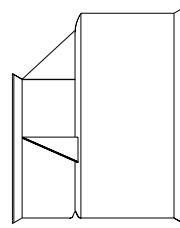

**INJECTION MOLDED REDUCING BELL/BELL COUPLER**

### REDUCING COUPLER, BELL/SPIGOT

| SIZE                  | PRODUCT CODE |
|-----------------------|--------------|
| 6" x 4" (150 x 100mm) | 0674WT       |
| 8" x 4" (200 x 100mm) | 0874WT       |
| 8" x 6" (200 x 150mm) | 0876WT       |

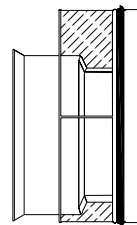

**INJECTION MOLDED BELL SPIGOT REDUCER**

# INJECTION MOLDED REDUCING FITTING KITS N-12 ST & N-12 WT

## TEE

| SIZE                      | CONSISTS OF<br>TEE REDUCER       | N-12 ST<br>BELL-AND-SPIGOT |
|---------------------------|----------------------------------|----------------------------|
| 10" x 4" (250mm x 100mm)  | 1062ST 10" x 8" + 0874WT 8" x 4" | 1060ST                     |
| 12" x 10" (300mm x 250mm) | 1264ST 12" + 1210WT 12" x 10"    | 1263ST <sup>1,2</sup>      |

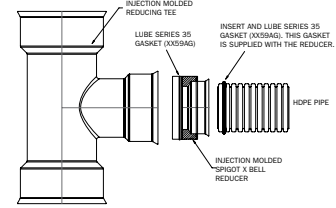

## TEE

| SIZE                      | CONSISTS OF<br>TEE REDUCER       | N-12 WT               |
|---------------------------|----------------------------------|-----------------------|
| 10" x 4" (250mm x 100mm)  | 1062WT 10" x 8" + 0874WT 8" x 4" | 1060WT                |
| 12" x 4" (300mm x 100mm)  | 1262WT 12" x 8" + 0874WT 8" x 4" | 1260WT                |
| 12" x 10" (300mm x 250mm) | 1264WT 12" + 1210WT 12" x 10"    | 1263WT <sup>1,2</sup> |

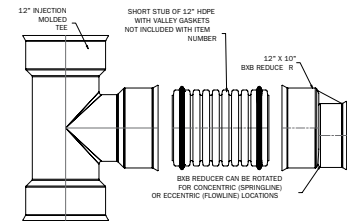

## WYE

| SIZE                      | CONSISTS OF<br>TEE REDUCER    | N-12 ST<br>BELL-AND-SPIGOT |
|---------------------------|-------------------------------|----------------------------|
| 12" x 10" (300mm x 250mm) | 1284ST 12" + 1210WT 12" x 10" | 1283ST <sup>3</sup>        |

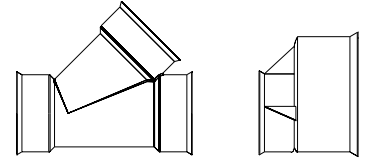

## WYE

| SIZE                      | CONSISTS OF<br>TEE REDUCER       | N-12 WT             |
|---------------------------|----------------------------------|---------------------|
| 10" x 4" (250mm x 100mm)  | 1082WT 10" x 8" + 0874WT 8" x 4" | 1080WT              |
| 10" x 6" (250mm x 150mm)  | 1082WT 10" x 8" + 0876WT 8" x 6" | 1081WT              |
| 12" x 4" (300mm x 100mm)  | 1282WT 12" x 8" + 0874WT 8" x 4" | 1280WT              |
| 12" x 10" (300mm x 250mm) | 1284WT 12" + 1210WT 12" x 10"    | 1283WT <sup>3</sup> |

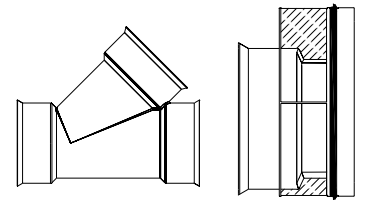

## REDUCER

| SIZE                     | CONSISTS OF<br>TEE REDUCER       | N-12 WT |
|--------------------------|----------------------------------|---------|
| 10" x 4" (250mm x 100mm) | 1018WT 10" x 8" + 0874WT 8" x 4" | 1074WT  |
| 10" x 6" (250mm x 150mm) | 1018WT 10" x 8" + 0876WT 8" x 6" | 1076WT  |
| 12" x 4" (300mm x 100mm) | 1218WT 12" x 8" + 0874WT 8" x 4" | 1274WT  |
| 12" x 6" (300mm x 150mm) | 1218WT 12" x 8" + 0876WT 8" x 6" | 1276WT  |

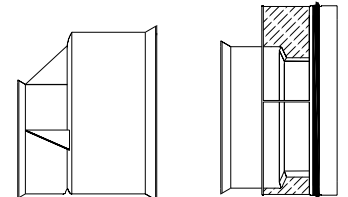

<sup>1</sup> Additional pipe stub not shipped with item number. Order this pipe separately.

<sup>2</sup> **12" x 10" Tee:** order 1264 (WT or ST) 12" x 12" Tee, 1210WT 12" x 10" Bell/Bell Reducer, and approximately 15" of 12" diameter dual wall pipe to make the connection between the two bell ends.

<sup>3</sup> **12" x 10" Wye:** order 1284 (WT or ST) 12" x 12" Wye, 1210WT 12" x 10" Bell/Bell Reducer, and approximately 15" of 12" diameter dual wall pipe to make the connection between the two bell ends.



# INSERTA TEE® FITTINGS

## N-12 PLAIN END/N-12 ST/N-12 WT INTO SAME

| DIAMETER                        | PRODUCT CODE |
|---------------------------------|--------------|
| 4" into 6" (100mm into 150mm)   | 4N126N12     |
| 4" into 8" (100mm into 200mm)   | 4N128N12     |
| 4" into 10" (100mm into 250mm)  | 4N1210N12    |
| 4" into 12" (100mm into 300mm)  | 4N1212N12    |
| 4" into 15" (100mm into 375mm)  | 4N1215N12    |
| 4" into 18" (100mm into 450mm)  | 4N1218N12    |
| 4" into 24" (100mm into 600mm)  | 4N1224N12    |
| 4" into 30" (100mm into 750mm)  | 4N1230N12    |
| 4" into 36" (100mm into 900mm)  | 4N1236N12    |
| 4" into 42" (100mm into 1050mm) | 4N1242N12    |
| 4" into 48" (100mm into 1200mm) | 4N1248N12    |
| 4" into 60" (100mm into 1500mm) | 4N1260N12    |
| 6" into 8" (150mm into 200mm)   | 6N128N12     |
| 6" into 10" (150mm into 250mm)  | 6N1210N12    |
| 6" into 12" (150mm into 300mm)  | 6N1212N12    |
| 6" into 15" (150mm into 375mm)  | 6N1215N12    |
| 6" into 18" (150mm into 450mm)  | 6N1218N12    |
| 6" into 24" (150mm into 600mm)  | 6N1224N12    |
| 6" into 30" (150mm into 750mm)  | 6N1230N12    |
| 6" into 36" (150mm into 900mm)  | 6N1236N12    |
| 6" into 42" (150mm into 1050mm) | 6N1242N12    |
| 6" into 48" (150mm into 1200mm) | 6N1248N12    |
| 6" into 60" (150mm into 1500mm) | 6N1260N12    |
| 8" into 10" (200mm into 250mm)  | 8N1210N12    |
| 8" into 12" (200mm into 300mm)  | 8N1212N12    |
| 8" into 15" (200mm into 375mm)  | 8N1215N12    |
| 8" into 18" (200mm into 450mm)  | 8N1218N12    |
| 8" into 24" (200mm into 600mm)  | 8N1224N12    |
| 8" into 30" (200mm into 750mm)  | 8N1230N12    |
| 8" into 36" (200mm into 900mm)  | 8N1236N12    |
| 8" into 42" (200mm into 1050mm) | 8N1242N12    |
| 8" into 48" (200mm into 1200mm) | 8N1248N12    |
| 8" into 60" (200mm into 1500mm) | 8N1260N12    |

## N-12 PLAIN END/N-12 ST/N-12 WT INTO SAME

| DIAMETER                         | PRODUCT CODE |
|----------------------------------|--------------|
| 10" into 12" (250mm into 300mm)  | 10N1212N12   |
| 10" into 15" (250mm into 375mm)  | 10N1215N12   |
| 10" into 18" (250mm into 450mm)  | 10N1218N12   |
| 10" into 24" (250mm into 600mm)  | 10N1224N12   |
| 10" into 30" (250mm into 750mm)  | 10N1230N12   |
| 10" into 36" (250mm into 900mm)  | 10N1236N12   |
| 10" into 42" (250mm into 1050mm) | 10N1242N12   |
| 10" into 48" (250mm into 1200mm) | 10N1248N12   |
| 10" into 60" (250mm into 1500mm) | 10N1260N12   |
| 12" into 15" (300mm into 375mm)  | 12N1215N12   |
| 12" into 18" (300mm into 450mm)  | 12N1218N12   |
| 12" into 24" (300mm into 600mm)  | 12N1224N12   |
| 12" into 30" (300mm into 750mm)  | 12N1230N12   |
| 12" into 36" (300mm into 900mm)  | 12N1236N12   |
| 12" into 42" (300mm into 1050mm) | 12N1242N12   |
| 12" into 48" (300mm into 1200mm) | 12N1248N12   |
| 12" into 60" (300mm into 1500mm) | 12N1260N12   |
| 15" into 18" (375mm into 450mm)  | 15N1218N12   |
| 15" into 24" (375mm into 600mm)  | 15N1224N12   |
| 15" into 30" (375mm into 750mm)  | 15N1230N12   |
| 15" into 36" (375mm into 900mm)  | 15N1236N12   |
| 15" into 42" (375mm into 1050mm) | 15N1242N12   |
| 15" into 48" (375mm into 1200mm) | 15N1248N12   |
| 15" into 60" (375mm into 1500mm) | 15N1260N12   |
| 18" into 24" (450mm into 600mm)  | 18N1224N12   |
| 18" into 30" (450mm into 750mm)  | 18N1230N12   |
| 18" into 36" (450mm into 900mm)  | 18N1236N12   |
| 18" into 42" (450mm into 1050mm) | 18N1242N12   |
| 18" into 48" (450mm into 1200mm) | 18N1248N12   |
| 18" into 60" (450mm into 1500mm) | 18N1260N12   |
| 24" into 36" (600mm into 900mm)  | 24N1236N12   |
| 24" into 42" (600mm into 1050mm) | 24N1242N12   |
| 24" into 48" (600mm into 1200mm) | 24N1248N12   |
| 24" into 60" (600mm into 1500mm) | 24N1260N12   |
| 30" into 42" (750mm into 1050mm) | 30N1242N12   |
| 30" into 48" (750mm into 1200mm) | 30N1248N12   |
| 30" into 60" (750mm into 1500mm) | 30N1260N12   |

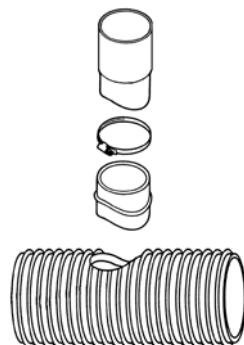

# INSERTA TEE FITTINGS

## SDR35 INTO N-12 PLAIN END/N-12 ST/N-12 WT

| DIAMETER                              | PRODUCT CODE |
|---------------------------------------|--------------|
| 4" SDR35 into 6" (100mm into 150mm)   | 4P26FB6N12   |
| 4" SDR35 into 8" (100mm into 200mm)   | 4P26FB8N12   |
| 4" SDR35 into 10" (100mm into 250mm)  | 4P26FB10N12  |
| 4" SDR35 into 12" (100mm into 300mm)  | 4P26FB12N12  |
| 4" SDR35 into 15" (100mm into 375mm)  | 4P26FB15N12  |
| 4" SDR35 into 18" (100mm into 450mm)  | 4P26FB18N12  |
| 4" SDR35 into 24" (100mm into 600mm)  | 4P26FB24N12  |
| 4" SDR35 into 30" (100mm into 750mm)  | 4P26FB30N12  |
| 4" SDR35 into 36" (100mm into 900mm)  | 4P26FB36N12  |
| 4" SDR35 into 42" (100mm into 1050mm) | 4P26FB42N12  |
| 4" SDR35 into 48" (100mm into 1200mm) | 4P26FB48N12  |
| 4" SDR35 into 60" (100mm into 1500mm) | 4P26FB60N12  |
| 6" SDR35 into 8" (150mm into 200mm)   | 6P26FB8N12   |
| 6" SDR35 into 10" (150mm into 250mm)  | 6P26FB10N12  |
| 6" SDR35 into 12" (150mm into 300mm)  | 6P26FB12N12  |
| 6" SDR35 into 15" (150mm into 375mm)  | 6P26FB15N12  |
| 6" SDR35 into 18" (150mm into 450mm)  | 6P26FB18N12  |
| 6" SDR35 into 24" (150mm into 600mm)  | 6P26FB24N12  |
| 6" SDR35 into 30" (150mm into 750mm)  | 6P26FB30N12  |
| 6" SDR35 into 36" (150mm into 900mm)  | 6P26FB36N12  |
| 6" SDR35 into 42" (150mm into 1050mm) | 6P26FB42N12  |
| 6" SDR35 into 48" (150mm into 1200mm) | 6P26FB48N12  |
| 6" SDR35 into 60" (150mm into 1500mm) | 6P26FB60N12  |
| 8" SDR35 into 10" (200mm into 250mm)  | 8P3510N12    |
| 8" SDR35 into 12" (200mm into 300mm)  | 8P3512N12    |
| 8" SDR35 into 15" (200mm into 375mm)  | 8P3515N12    |
| 8" SDR35 into 18" (200mm into 450mm)  | 8P3518N12    |
| 8" SDR35 into 24" (200mm into 600mm)  | 8P3524N12    |
| 8" SDR35 into 30" (200mm into 750mm)  | 8P3530N12    |
| 8" SDR35 into 36" (200mm into 900mm)  | 8P3536N12    |
| 8" SDR35 into 42" (200mm into 1050mm) | 8P3542N12    |
| 8" SDR35 into 48" (200mm into 1200mm) | 8P3548N12    |
| 8" SDR35 into 60" (200mm into 1500mm) | 8P3560N12    |

## SDR35 INTO N-12 PLAIN END/N-12 ST/N-12 WT

| DIAMETER                               | PRODUCT CODE |
|--|--------------|
| 10" SDR35 into 12" (250mm into 300mm)  | 10P3512N12   |
| 10" SDR35 into 15" (250mm into 375mm)  | 10P3515N12   |
| 10" SDR35 into 18" (250mm into 450mm)  | 10P3518N12   |
| 10" SDR35 into 24" (250mm into 600mm)  | 10P3524N12   |
| 10" SDR35 into 30" (250mm into 750mm)  | 10P3530N12   |
| 10" SDR35 into 36" (250mm into 900mm)  | 10P3536N12   |
| 10" SDR35 into 42" (250mm into 1050mm) | 10P3542N12   |
| 10" SDR35 into 48" (250mm into 1200mm) | 10P3548N12   |
| 10" SDR35 into 60" (250mm into 1500mm) | 12P3560N12   |
| 12" SDR35 into 15" (300mm into 375mm)  | 12P3515N12   |
| 12" SDR35 into 18" (300mm into 450mm)  | 12P3518N12   |
| 12" SDR35 into 24" (300mm into 600mm)  | 12P3524N12   |
| 12" SDR35 into 30" (300mm into 750mm)  | 12P3530N12   |
| 12" SDR35 into 36" (300mm into 900mm)  | 12P3536N12   |
| 12" SDR35 into 42" (300mm into 1050mm) | 12P3542N12   |
| 12" SDR35 into 48" (300mm into 1200mm) | 12P3548N12   |
| 12" SDR35 into 60" (300mm into 1500mm) | 12P3560N12   |
| 15" SDR35 into 18" (375mm into 450mm)  | 15P3518N12   |
| 15" SDR35 into 24" (375mm into 600mm)  | 15P3524N12   |
| 15" SDR35 into 30" (375mm into 750mm)  | 15P3530N12   |
| 15" SDR35 into 36" (375mm into 900mm)  | 15P3536N12   |
| 15" SDR35 into 42" (375mm into 1050mm) | 15P3542N12   |
| 15" SDR35 into 48" (375mm into 1200mm) | 15P3548N12   |
| 15" SDR35 into 60" (375mm into 1500mm) | 15P3560N12   |
| 18" SDR35 into 24" (450mm into 600mm)  | 18P3524N12   |
| 18" SDR35 into 30" (450mm into 750mm)  | 18P3530N12   |
| 18" SDR35 into 36" (450mm into 900mm)  | 18P3536N12   |
| 18" SDR35 into 42" (450mm into 1050mm) | 18P3542N12   |
| 18" SDR35 into 48" (450mm into 1200mm) | 18P3548N12   |
| 18" SDR35 into 60" (450mm into 1500mm) | 18P3560N12   |
| 24" SDR35 into 36" (600mm into 900mm)  | 24P3536N12   |
| 24" SDR35 into 42" (600mm into 1050mm) | 24P3542N12   |
| 24" SDR35 into 48" (600mm into 1200mm) | 24P3548N12   |
| 24" SDR35 into 60" (600mm into 1500mm) | 24P3560N12   |
| 30" SDR35 into 42" (750mm into 1050mm) | 30P3542N12   |
| 30" SDR35 into 48" (750mm into 1200mm) | 30P3548N12   |
| 30" SDR35 into 60" (750mm into 1500mm) | 30P3560N12   |

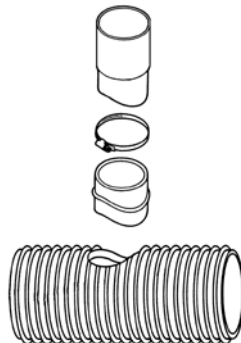

# HOLE SAWS

## INSERTA TEE

### YELLOW SERIES (BIMETAL)

| SIZE | PRODUCT CODE | PILOT DRILL | WEIGHT   |
|------|--------------|-------------|----------|
| 4½"  | Y412         | ¼"          | 2 pounds |
| 6½"  | Y612         | ¼"          | 3 pounds |
| 8¾"  | Y834         | ¼"          | 5 pounds |

### SILVER SERIES (USE WITH HEAVY DUTY ½" DRILL MOTOR)

| SIZE | PRODUCT CODE | PILOT DRILL | WEIGHT     |
|------|--------------|-------------|------------|
| 4½"  | S412         | 10mm        | 4 pounds   |
| 6½"  | S612         | 10mm        | 7½ pounds  |
| 8¾"  | S834         | 10mm        | 12½ pounds |

### RED SERIES (HEAT TREATED TEETH)

| SIZE | PRODUCT CODE | PILOT DRILL | WEIGHT    |
|------|--------------|-------------|-----------|
| 4½"  | R412         | ⅜"          | 2½ pounds |
| 6½"  | R612         | ⅜"          | 3½ pounds |
| 8¾"  | R834         | ⅜"          | 5½ pounds |
| 10⅞" | R1078        | 12mm        | 8½ pounds |

### GOLD SERIES (USE WITH HEAVY DUTY ½" DRILL MOTOR)

| SIZE | PRODUCT CODE | PILOT DRILL | WEIGHT    |
|------|--------------|-------------|-----------|
| 4½"  | GA412        | ¾"          | 12 pounds |
| 6½"  | GA612        | ¾"          | 18 pounds |
| 8¾"  | GA834        | ¾"          | 24 pounds |
| 10⅞" | GA1078       | ¾"          | 33 pounds |

### BLUE SERIES (CARBON STEEL)

| SIZE | PRODUCT CODE | PILOT DRILL | WEIGHT    |
|------|--------------|-------------|-----------|
| 4½"  | BL412        | ⅜"          | 2½ pounds |
| 6½"  | BL612        | ⅜"          | 3½ pounds |
| 8¾"  | BL834        | ⅜"          | 5½ pounds |

### GOLD SERIES (USE WITH CORING MACHINE)

| SIZE                               | PRODUCT CODE | PILOT DRILL | WEIGHT    |
|------------------------------------|--------------|-------------|-----------|
| 4½"                                | G412         | ¾"          | 9 pounds  |
| 6½"                                | G612         | ¾"          | 15 pounds |
| 8¾"                                | G834         | ¾"          | 21 pounds |
| 10⅞"                               | G1078        | ¾"          | 30 pounds |
| 12⅞"                               | G1278        | ¾"          | 41 pounds |
| 15 <sup>13</sup> / <sub>16</sub> " | G151316      | ¾"          | 59 pounds |
| 19 <sup>3</sup> / <sub>16</sub> "  | G19316       | ¾"          | 60 pounds |

### GREY SERIES (CARBIDE TIPPED)

| SIZE | PRODUCT CODE | PILOT DRILL | WEIGHT    |
|------|--------------|-------------|-----------|
| 4½"  | PE412        | ½"          | 6 pounds  |
| 6½"  | PE612        | ½"          | 8¾ pounds |

### ORANGE SERIES (FOR HP PIPE)

| SIZE                              | PRODUCT CODE | PILOT DRILL | WEIGHT    |
|-----------------------------------|--------------|-------------|-----------|
| 4⅜"                               | HP438SAW     | 12mm        | 3 pounds  |
| 6⅜"                               | HP638SAW     | 12mm        | 4 pounds  |
| 8⅝"                               | HP858SAW     | 12mm        | 6 pounds  |
| 10¾"                              | HP1034SAW    | ¾"          | 12 pounds |
| 12¾"                              | HP1234SAW    | ¾"          | 15 pounds |
| 15¾"                              | HP1534SAW    | ¾"          | 21 pounds |
| 19 <sup>1</sup> / <sub>16</sub> " | HP19116SAW   | ¾"          | 35 pounds |

# COUPLERS

## INTERNAL SNAP, EXTERNAL SNAP & SPLIT BAND

### INTERNAL COUPLERS

| DIAMETER    | PACKAGE QUANTITY | PRODUCT CODE |
|-------------|------------------|--------------|
| 3" (75mm)   | 50               | 0315AA       |
| 4" (100mm)  | 16               | 0417AA       |
| 5" (125mm)  | 12               | 0515AA       |
| 6" (150mm)  | 9                | 0615AA       |
| 8" (200mm)  | 4                | 0815AA       |
| 10" (250mm) | 4                | 1015AA       |

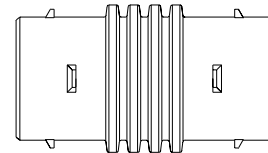

INTERNAL COUPLER

### INTERNAL REDUCING COUPLERS

| SIZE                  | PACKAGE QUANTITY | PRODUCT CODE |
|-----------------------|------------------|--------------|
| 5" x 4" (125 x 100mm) | 16               | 0425AA       |
| 6" x 5" (150 x 125mm) | 9                | 0526AA       |

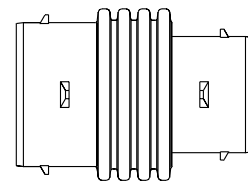

INTERNAL REDUCING COUPLER

### EXTERNAL SNAP COUPLERS

| DIAMETER    | PACKAGE QUANTITY | PRODUCT CODE |
|-------------|------------------|--------------|
| 3" (75mm)   | 24               | 0312AA       |
| 4" (100mm)  | 24               | 0412AA       |
|             |                  | 0412AABM     |
| 5" (125mm)  | 24               | 0512AA       |
| 6" (150mm)  | 8                | 0612AA       |
| 8" (200mm)  | 6                | 0812AA       |
| 10" (250mm) | 3                | 1012AA       |

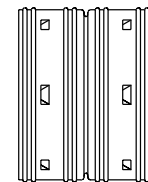

EXTERNAL SNAP COUPLER

### SPLIT COUPLERS

| DIAMETER    | PACKAGE QUANTITY | PRODUCT CODE |
|-------------|------------------|--------------|
| 3" (75mm)   | 36               | 0311AA       |
| 4" (100mm)  | 24               | 0411AA       |
| 5" (125mm)  | 24               | 0511AA       |
| 6" (150mm)  | 14               | 0611AA       |
| 8" (200mm)  | 8                | 0811AA       |
| 10" (250mm) | 12               | 1011AA       |

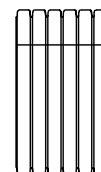

SPLIT COUPLER

# END CAPS & END PLUGS

## END CAPS\*

| DIAMETER    | PACKAGE QUANTITY |       | TYPE  | PRODUCT CODE |        |
|-------------|------------------|-------|-------|--------------|--------|
|             | SNAP             | SPLIT |       | SNAP         | SPLIT  |
| 3" (75mm)   | 30               | 32    | Solid | 0332AA       | 0331AA |
| 4" (100mm)  | 40               | 34    | Solid | 0432AA       | 0431AA |
| 5" (125mm)  |                  | 24    | Solid |              | 0531AA |
| 6" (150mm)  |                  | 12    | Solid |              | 0631AA |
| 8" (200mm)  | 6                |       | Solid | 0832AA       |        |
| 10" (250mm) | 6                |       | Solid | 1032AA       |        |
| 12" (300mm) |                  | 4     | Solid |              | 1267AA |
| 15" (375mm) |                  | 1     | Solid |              | 1567AA |
| 18" (450mm) |                  | 1     | Solid |              | 1867AA |
| 24" (600mm) |                  | 1     | Solid |              | 2467AA |

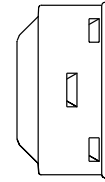

**SNAP END CAP**

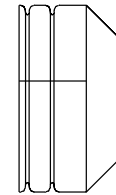

**SPLIT END CAP 3"-10"**

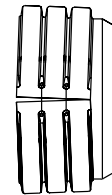

**SPLIT END CAP 12"-24"**

*\*END CAPS ARE FOR HORIZONTAL APPLICATIONS ONLY. END CAPS ARE NOT PERMITTED TO BE USED IN ANY VERTICAL APPLICATIONS. MISUSE OR FAILURE TO PROPERLY SECURE END CAPS MAY RESULT IN DAMAGE TO PERSONS OR PROPERTY OR MAY RESULT IN INJURY OR DEATH.*

## INTERNAL SNAP PLUGS

| DIAMETER   | PACKAGE QUANTITY | PRODUCT CODE |
|------------|------------------|--------------|
| 3" (75mm)  | 16               | 0332AAIN     |
| 4" (100mm) | 34               | 0433AAHAN    |
| 5" (125mm) | 24               | 0533AAHAN    |
| 6" (150mm) | 50               | 0633AAHAN    |

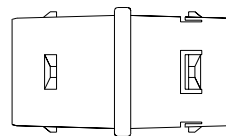

**INTERNAL SNAP PLUG**

## INTERNAL END PLUGS

| DIAMETER   | PACKAGE QUANTITY | TYPE       | PRODUCT CODE |
|------------|------------------|------------|--------------|
| 3" (75mm)  | 100              | Solid      | 0333AA       |
| 4" (100mm) | 100              | Solid      | 0433AA       |
|            |                  | Perforated | 0434AA       |
| 5" (125mm) | 100              | Solid      | 0533AA       |
| 6" (150mm) | 50               | Solid      | 0633AA       |

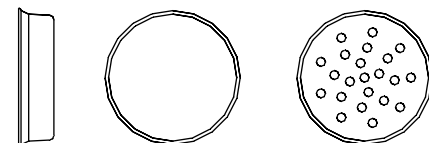

**INTERNAL END PLUG - SOLID AND PERFORATED**

# ADAPTERS, DOWNSPOUT ADAPTERS & EXPANDABLE PIPE

## ADAPTERS

| DIAMETER   | PACKAGE QUANTITY | TYPE          | PRODUCT CODE |
|------------|------------------|---------------|--------------|
| 3" (75mm)  | 24               | Clay          | 0362AA       |
| 4" (100mm) | 24               | Clay          | 0462AA       |
| 5" (125mm) | 24               | Clay          | 0562AA       |
| 6" (150mm) | 11               | Clay          | 0662AAHAN    |
| 8" (200mm) | 9                | Clay          | 0862AA       |
| 4" (100mm) | 24               | Sewer & Drain | 0467AA       |
| 4" (100mm) | 24               | Septic Tank   | 0463AA       |

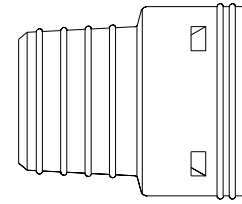

ADAPTER

## DOWNSPOUT ADAPTERS

| SIZE                                      | PACKAGE QUANTITY | PRODUCT CODE |
|---|------------------|--------------|
| Pipe Diameter x Downspout Dimensions      |                  |              |
| 3" x 3.25" x 2.5" (75mm x 81mm x 62.5mm)  | 24               | 0364AA       |
| 4" x 3.25" x 2.5" (100mm x 81mm x 62.5mm) | 24               | 0464AA       |
| 4" x 4.25" x 3" (100mm x 106mm x 75mm)    | 20               | 0465AA       |
| 4" x 2.56" x 2.56" (100mm x 63mm x 63mm)  | 24               | 0466AA       |
| 6" x 4" x 6" (150mm x 100mm x 150mm)      | 1                | 0664AA       |
| 6" x 4" x 6" (150mm x 100mm x 150mm)      | 1                | 0664AC*      |

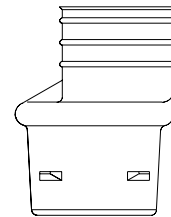

DOWNSPOUT ADAPTER

\*PVC

## EXPANDABLE DOWNSPOUT ADAPTERS

| SIZE                   | PACKAGE QUANTITY | PRODUCT CODE |
|------------------------|------------------|--------------|
| 2" x 3" (50mm x 75mm)  | 6                | 0473AA       |
| 3" x 3" (75mm x 75 mm) | 6                | 0474AA       |



## BEND-A-DRAIN™ PIPE

| DIAMETER                                     | PACKAGE QUANTITY | PRODUCT CODE |
|--|------------------|--------------|
| 4" x 12' (100mm x 3.7 m) Solid Pipe          | 6                | 335112       |
| 4" x 12' (100mm x 3.7 m) Perforated Pipe     | 6                | 330112       |
| 4" x 25' (100mm x 7.6 m) Solid Pipe          | 3                | 335125       |
| 4" x 25' (100mm x 7.6 m) Perforated Pipe     | 3                | 330125       |
| 4" x 25' (100mm x 7.6 m) Perf. Sock Pipe     | 3                | 33732585     |
| 4" x 2' (100mm x 0.6 m) Solid Repair Coupler | 6                | 335102       |



# REDUCERS & ELBOWS

## REDUCERS\*

| SIZE                      | PACKAGE QUANTITY | PRODUCT CODE |
|---------------------------|------------------|--------------|
| (Main x Stub)             |                  |              |
| 4" x 3" (100mm x 75mm)    | 24               | 0314AA       |
| 5" x 4" (125mm x 100mm)   | 20               | 0514AA       |
| 6" x 4" (150mm x 100mm)   | 9                | 0614AA       |
| 6" x 5" (150mm x 125mm)   | 9                | 0516AA       |
| 8" x 6" (200mm x 150mm)   | 9                | 0816AA       |
| 10" x 8" (250mm x 200mm)  | 6                | 1018AA       |
| 12" x 10" (300mm x 250mm) | 1                | 1210AA       |
| 15" x 12" (375mm x 300mm) | 1                | 1512AA       |

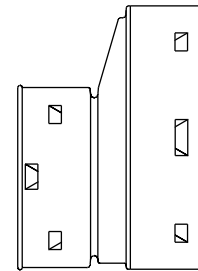

**SNAP REDUCING COUPLER**

## 90 DEGREE SNAP ELBOWS

| SIZE       | PACKAGE QUANTITY | PRODUCT CODE |
|------------|------------------|--------------|
| 3" (75mm)  | 12               | 0390AA       |
| 4" (100mm) | 10               | 0490AA       |



**90° SNAP ELBOW**

## 45 DEGREE SNAP ELBOWS

| SIZE       | PACKAGE QUANTITY | PRODUCT CODE |
|------------|------------------|--------------|
| 4" (100mm) | 15               | 0445AA       |



**45° SNAP ELBOW**

\*COUPLERS SOLD SEPARATELY

# TEES

## BLIND, SNAP, REDUCING & BLIND MULTIPLE

### BLIND TEES

| SIZE        | PACKAGE QUANTITY | PRODUCT CODE |
|-------------|------------------|--------------|
| 3" (75mm)   | 12               | 0341AA       |
| 4" (100mm)  | 8                | 0441AA       |
| 5" (125mm)  | 4                | 0541AA       |
| 6" (150mm)  | 3                | 0641AA       |
| 8" (200mm)  | 1                | 0841AA       |
| 10" (250mm) | 1                | 1041AA       |

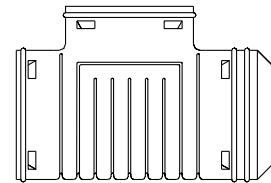

BLIND TEE

### SNAP TEES

| SIZE       | PACKAGE QUANTITY | PRODUCT CODE |
|------------|------------------|--------------|
| 3" (75mm)  | 12               | 0321AA       |
| 4" (100mm) | 8                | 0421AA       |
| 5" (125mm) | 4                | 0525AA       |
| 6" (150mm) | 3                | 0626AA       |

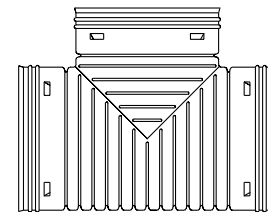

SNAP TEE

### REDUCING TEES

| SIZE                              | PACKAGE QUANTITY | PRODUCT CODE |
|-----------------------------------|------------------|--------------|
| (Main x Stub)                     |                  |              |
| 5" x 3" (125mm x 75mm) Red. Tee   | 4                | 0523AA       |
| 5" x 4" (125mm x 100mm) Red. Tee  | 4                | 0524AA       |
| 6" x 4" (150mm) x 100mm) Red. Tee | 3                | 0624AA       |
| 6" x 5" (150mm x 125mm) Red. Tee  | 3                | 0625AA       |

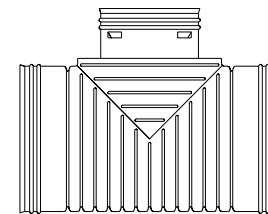

REDUCING TEE

### BLIND MULTIPLE TEES

| SIZE                              | PACKAGE QUANTITY | PRODUCT CODE |
|-----------------------------------|------------------|--------------|
| (Main x Stub)                     |                  |              |
| 8" x 8"/6"/4" (200mm/150mm/100mm) | 1                | 0845AA       |
| 10" x 10"/8" (250mm/200mm)        | 1                | 1045AA       |
| 12" x 12"/10" (300mm/250mm)       | 1                | 1247AA       |
| 15" x 10" (375mm/250mm)           | 1                | 1547AA       |
| 18" x 12" (450mm/300mm)           | 1                | 1847AA       |

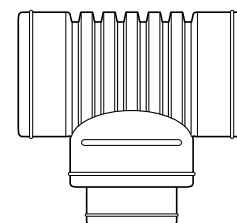

BLIND MULTIPLE TEE



# TEES

## MULTIPLE, MULTIPLE CROSS & INTERNAL TAP

### MULTIPLE TEES

| SIZE  | PACKAGE QUANTITY | PRODUCT CODE |
|---|------------------|--------------|
| (Main x Stub)                                   |                  |              |
| 6" x 3"/4"/5"/6"<br>(150mm x 75/100/125/150mm)  | 3                | 0644AA       |
| 8" x 4"/5"/6"/8"<br>(200mm x 100/125/150/200mm) | 1                | 0844AA       |
| 10" x 6"/8"/10"<br>(250mm x 150/200/250mm)      | 1                | 1044AA       |

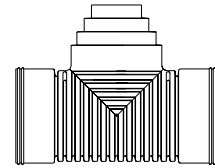

**MULTIPLE TEE**

### MULTIPLE CROSS TEES

| SIZE       | PACKAGE QUANTITY | PRODUCT CODE |
|------------|------------------|--------------|
| 6" (150mm) | 3                | 0654AA       |

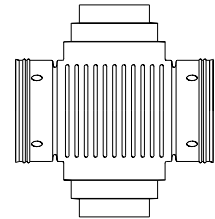

**MULTIPLE CROSS TEE**

### INTERNAL TAP TEES

| SIZE                               | PACKAGE QUANTITY | PRODUCT CODE |
|------------------------------------|------------------|--------------|
| 3" x 6"/8" (75mm x 150mm/200mm)    | 24               | 0350AA       |
| 4" x 6"/8" (100mm x 150mm/200mm)   | 24               | 0450AA       |
| 4" x 10"/12" (100mm x 250mm/300mm) | 24               | 0410AA       |
| 4" x 10"/12" (100mm x 250mm/300mm) | 24               | 0410AA       |

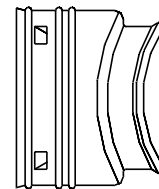

**TAP TEE**

### HINGED TEE\*

| SIZE       | PACKAGE QUANTITY | PRODUCT CODE |
|------------|------------------|--------------|
| 4" (100mm) | 12               | 0421AAHF     |

\*Fits singlewall and dual-wall pipe.



**HINGED TEE**

# WYES

## WYES

| SIZE (Size on Size) | PACKAGE QUANTITY | PRODUCT CODE |
|---------------------|------------------|--------------|
| 3" (75mm)           | 7                | 0322AA       |
| 4" (100mm)          | 5                | 0422AA       |
| 5" (125mm)          | 4                | 0522AA       |
| 6" (150mm)          | 2                | 0622AA       |
| 8" (200mm)          | 1                | 0822AA       |



**WYE**

## INTERNAL WYES

| SIZE (Size on Size) | PACKAGE QUANTITY | PRODUCT CODE |
|---------------------|------------------|--------------|
| 3" (75mm)           | 12               | 0322AAIN     |

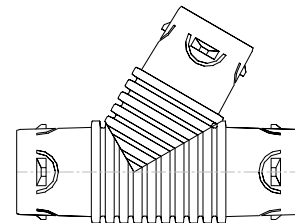

**INTERNAL WYE**

# GRAVELLESS ACCESSORIES

## GRAVELLESS ACCESSORIES

| PRODUCT DESCRIPTION                        | STYLE           | PRODUCT CODE |
|--|-----------------|--------------|
| 8" x 4" offset adapter<br>(200mm x 100mm)  | with grommet    | 0840AAGF     |
| 8" x 4" offset adapter<br>(200mm x 100mm)  | without grommet | 0839AA       |
| 10" x 4" offset adapter<br>(250mm x 100mm) | with grommet    | 1040AAGF     |
| 10" x 4" offset adapter<br>(250mm x 100mm) | without grommet | 1039AA       |

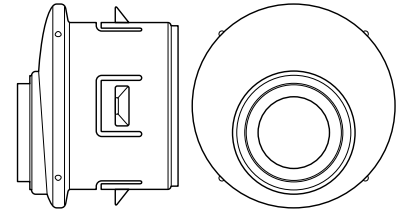

**OFFSET ADAPTER**

# TURF FLOW

## 2" TURF FLOW FITTINGS

| FITTINGS        | PACKAGE QUANTITY | PRODUCT CODE |
|-----------------|------------------|--------------|
| Coupler         | 50               | 0212AA       |
| End cap         | 50               | 0232AA       |
| Blind tee/elbow | 50               | 0241AA       |
| Reducer         | 25               | 0214AA       |
| Tee             | 50               | 0221AA       |

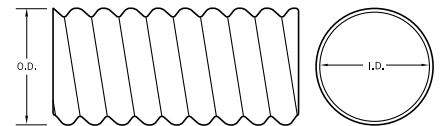

**TURF FLOW COUPLER**

# NYLOPLAST® ROAD/ HIGHWAY STRUCTURES

## ROAD/HWY STRUCTURES

| STRUCTURE   | GRATE DIMENSIONS        | PRODUCT CODE |
|-------------|-------------------------|--------------|
| 12" (300mm) | 2' x 2' (610mm x 610mm) | 3212AGS      |
| 15" (375mm) | 2' x 2' (610mm x 610mm) | 3215AGS      |
| 18" (450mm) | 2' x 2' (610mm x 610mm) | 3218AGS      |
| 18" (450mm) | 2' x 3' (610mm x 914mm) | 3218AGR      |
| 24" (600mm) | 2' x 2' (610mm x 610mm) | 3224AGS      |
| 24" (600mm) | 2' x 3' (610mm x 914mm) | 3224AGR      |
| 30" (750mm) | 2' x 2' (610mm x 610mm) | 3230AGS      |
| 30" (750mm) | 2' x 3' (610mm x 914mm) | 3230AGR      |
| 36" (900mm) | 2' x 2' (610mm x 610mm) | 3236AGS      |
| 36" (900mm) | 2' x 3' (610mm x 914mm) | 3236AGR      |

Road & Highway Structures are custom manufactured for each project. 5-10 day lead times are required for product delivery.

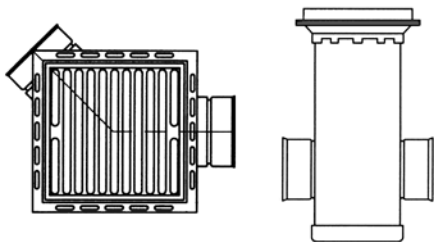

## STEEL BAR GRATES AND FRAME

| STRUCTURE   | GRATE DIMENSIONS        | PRODUCT CODE |
|-------------|-------------------------|--------------|
| 12" (300mm) | 2' x 2' (610mm x 610mm) | 3212CGSQFSB  |
| 15" (375mm) | 2' x 2' (610mm x 610mm) | 3215CGSQFSB  |
| 18" (450mm) | 2' x 2' (610mm x 610mm) | 3218CGSQFSB  |
| 18" (450mm) | 2' x 3' (610mm x 914mm) | 3218CGRFSB   |
| 24" (600mm) | 2' x 2' (610mm x 610mm) | 3224CGSQFSB  |
| 24" (600mm) | 2' x 3' (610mm x 914mm) | 3224CGRFSB   |
| 30" (750mm) | 2' x 2' (610mm x 610mm) | 3230CGSQFSB  |
| 30" (750mm) | 2' x 3' (610mm x 914mm) | 3230CGRFSB   |

# CURB INLET STRUCTURES

## CURB INLET STRUCTURES

| STRUCTURE   | GRATE DIMENSIONS        | PRODUCT CODE |
|-------------|-------------------------|--------------|
| 12" (300mm) | 2' x 2' (610mm x 610mm) | 3012AGS      |
| 15" (375mm) | 2' x 2' (610mm x 610mm) | 3015AGS      |
| 18" (450mm) | 2' x 2' (610mm x 610mm) | 3018AGS      |
| 18" (450mm) | 2' x 3' (610mm x 914mm) | 3018AGR      |
| 24" (600mm) | 2' x 2' (610mm x 610mm) | 3024AGS      |
| 24" (600mm) | 2' x 3' (610mm x 914mm) | 3024AGR      |
| 30" (750mm) | 2' x 2' (610mm x 610mm) | 3030AGS      |
| 30" (750mm) | 2' x 3' (610mm x 914mm) | 3030AGR      |
| 36" (900mm) | 2' x 2' (610mm x 610mm) | 3036AGS      |
| 36" (900mm) | 2' x 3' (610mm x 914mm) | 3036AGR      |

Curb Inlet Structures are custom manufactured for each project. 5-10 day lead times are required for product delivery.

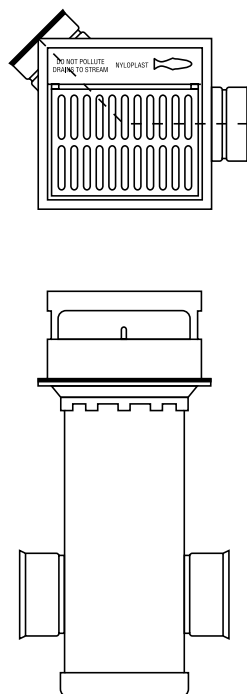

### Grate Options

#### 2' x 2' Grate Options

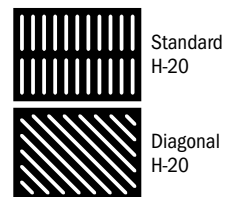

#### 2' x 3' Grate Options

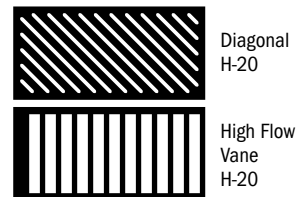

# DRAIN BASINS

## DRAIN BASINS\*

| STRUCTURE   | STUB DIMENSIONS             | PRODUCT CODE |
|-------------|-----------------------------|--------------|
| 8" (200mm)  | 4" (100mm) thru 8" (200mm)  | 2808AG       |
| 10" (250mm) | 4" (100mm) thru 10" (250mm) | 2810AG       |
| 12" (300mm) | 4" (100mm) thru 12" (300mm) | 2812AG       |
| 15" (375mm) | 4" (100mm) thru 15" (375mm) | 2815AG       |
| 18" (450mm) | 4" (100mm) thru 18" (450mm) | 2818AG       |
| 24" (600mm) | 4" (100mm) thru 24" (600mm) | 2824AG       |
| 30" (750mm) | 4" (100mm) thru 30" (750mm) | 2830AG       |
| 36" (900mm) | 4" (100mm) thru 36" (900mm) | 2836AG       |

\*Drain Basin Structures are custom manufactured for each project. 5-10 day lead times are required for product delivery.

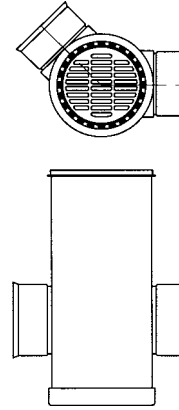

## DRAIN BASINS WITH WEIR\*

| STRUCTURE   | STUB DIMENSIONS             | PRODUCT CODE |
|-------------|-----------------------------|--------------|
| 24" (600mm) | 4" (100mm) thru 24" (600mm) | 2824AGWE     |
| 30" (750mm) | 4" (100mm) thru 30" (750mm) | 2830AGWE     |
| 36" (900mm) | 4" (100mm) thru 30" (750mm) | 2836AGWE     |

\*Contact Nyloplast for Weir heights greater than 84" (2134 mm).



# INLINE DRAINS

## INLINE DRAINS

| DRAIN BASIN | ADAPTS TO PIPE DIAMETER  | PRODUCT CODE |
|-------------|--|--------------|
| 8" (200mm)  | 4" (100mm), 6" (150mm), 8" (200mm)   | 2708AG       |
| 10" (250mm) | 4" (100mm), 6" (150mm), 8" (200mm), 10" (250mm)  | 2710AG       |
| 12" (300mm) | 4" (100mm), 6" (150mm), 8" (200mm), 10" (250mm), 12" (300mm)   | 2712AG       |
| 15" (375mm) | 4" (100mm), 6" (150mm), 8" (200mm), 10" (250mm), 12" (300mm), 15" (375mm)  | 2715AG       |
| 18" (450mm) | 4" (100mm), 6" (150mm), 8" (200mm), 10" (250mm), 12" (300mm), 15" (375mm), 18" (450mm)                           | 2718AG       |
| 24" (600mm) | 4" (100mm), 6" (150mm), 8" (200mm), 10" (250mm), 12" (300mm), 15" (375mm), 18" (450mm), 24" (600mm),             | 2724AG       |
| 30" (750mm) | 4" (100mm), 6" (150mm), 8" (200mm), 10" (250mm), 12" (300mm), 15" (375mm), 18" (450mm), 24" (600mm), 30" (750mm) | 2730AG       |

3-7 day lead times are required for product delivery.

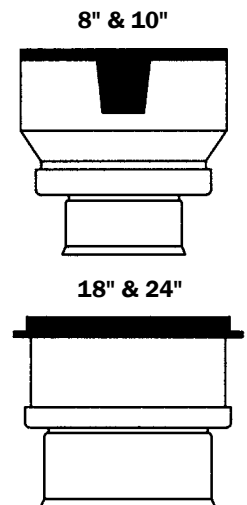

# DRAIN BASIN & INLINE DRAIN GRATE OPTIONS



**Dome - Light-Duty**

- 8" (200mm) - 0899CGD
- 10" (250mm) - 1099CGD
- 12" (300mm) - 1299CGD
- 15" (375mm) - 1599CGD
- 18" (450mm) - 1899CGD
- 24" (600mm) - 2199CGD



**Standard - Light-Duty**

- 8" (200mm) - 0899CGS
- 10" (250mm) - 1099CGS



**Light-Duty Bronze**

- 8" (200mm) - 0899CGB
- 10" (250mm) - 1099CGB



**Solid - Light-Duty**

- 8" (200mm) - 0899CGC
- 10" (250mm) - 1099CGC

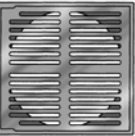

**Standard H-20**

- 12" (300mm) - 1299CGS
  - 15" (375mm) - 1599CGS
- Hinged Design

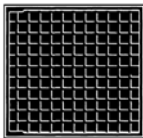

**Bronze Pedestrian - Light-Duty**

- 12" (300mm) - 1299CGPB
- 15" (375mm) - 1599CGPB



**Solid H-20**

- 12" (300mm) - 1299CGC
  - 15" (375mm) - 1599CGC
- Hinged Design

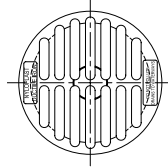

**Standard H-20**

- 18" (450mm) - 1899CGS



**Solid H-20**

- 18" (450mm) - 1899CGC
- 24" (600mm) - 2499CGC



**Solid H-20**

- 30" (750mm) - 3099CGC



**Standard H-20**

- 24" (600mm) - 2499CGS



**Standard H-20**

- 30" (750mm) - 3099CGS



**Pedestrian H-10**

- 18" (450mm) - 1899CGP



**Pedestrian H-10**

- 24" (600mm) - 2499CGP

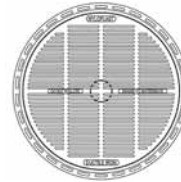

**Pedestrian H-20**

- 30" (750mm) - 3099CGP

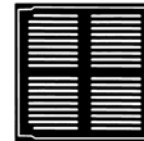

**Pedestrian H-10**

- 12" (300mm) - 1299CGP
  - 15" (375mm) - 1599CGP
- Hinged Design

*(Locking option is available for most grates)*

## DROP-IN GRATES

### LIGHT DUTY DROP-IN GRATES

| SIZE        | PRODUCT CODE |
|-------------|--------------|
| 6" (150mm)  | 0601DI       |
| 8" (200mm)  | 0801DI       |
| 10" (250mm) | 1001DI       |
| 12" (300mm) | 1201DI       |
| 15" (375mm) | 1501DI       |
| 18" (450mm) | 1801DI       |
| 24" (600mm) | 2401DI       |



Fits inside Sewer SDR 35  
Pipe and IPS SCH 40 Pipe

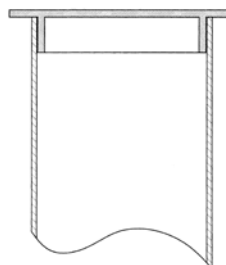

Fits inside N-12 Dual Wall Pipe

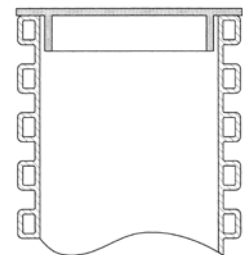

# WATER CONTROL STRUCTURE

## WATER CONTROL STRUCTURE

| SIZE                             | PRODUCT CODE |
|----------------------------------|--------------|
| 12" (300mm) Diameter Drain Basin | 4912AG       |
| 15" (375mm) Diameter Drain Basin | 4915AG       |
| 18" (450mm) Diameter Drain Basin | 4918AG       |
| 24" (600mm) Diameter Drain Basin | 4924AG       |

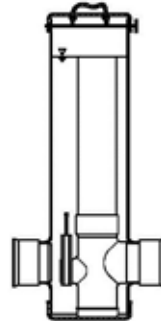

# SUMP INSERTS

## SUMP INSERTS

| BASIN DIAMETER | PRODUCT CODE |
|----------------|--------------|
| 12" (300mm)    | 3812AGSI     |
| 15" (375mm)    | 3815AGSI     |
| 18" (450mm)    | 3818AGSI     |
| 24" (600mm)    | 3824AGSI     |
| 30" (750mm)    | 3830AGSI     |

# ADD-A-BRANCH

## ADD-A-BRANCH

| SIZE                               | ADAPTS TO STRUCTURE                         | PRODUCT CODE |
|------------------------------------|---|--------------|
| 4" (100mm) Field Installation Kit  | Adapts to 8"-24" (200-600mm) Structure      | 6004AG _     |
| 4" (100mm) Field Installation Kit  | Adapts to 30" (750mm) Structure             | 6004AG _ 30  |
| 6" (150mm) Field Installation Kit  | Adapts to 10"-24" (250-600mm) Structure     | 6006AG _     |
| 6" (150mm) Field Installation Kit  | Adapts to 30" (750mm) Structure             | 606AG _ 30   |
| 8" (200mm) Field Installation Kit  | Adapts to 12"-24" (300-600mm) Structure     | 6008AG _     |
| 8" (200mm) Field Installation Kit  | Adapts to 30" (750mm) Structure             | 6008AG _ 30  |
| 10" (250mm) Field Installation Kit | Adapts to 15"-24" (375-600mm) Structure     | 6010AG _     |
| 10" (250mm) Field Installation Kit | Adapts to 30" (750mm) Structure             | 6010AG _ 30  |
| 12" (300mm) Field Installation Kit | Adapts to 18" & 24" (450 & 600mm) Structure | 6012AG _     |
| 12" (300mm) Field Installation Kit | Adapts to 30" (750mm) Structure             | 6012AG _ 30  |
| 15" (375mm) Field Installation Kit | Adapts to 24" (600mm) Structure             | 6015AG _     |
| 15" (375mm) Field Installation Kit | Adapts to 30" (750mm) Structure             | 6015AG _ 30  |
| 18" (450mm) Field Installation Kit | Adapts to 30" (750mm) Structure             | 6018AG _ 30  |



# COUPLINGS & ADAPTERS

## DUAL WALL CORRUGATED COUPLING

| SIZE        | PRODUCT CODE |
|-------------|--------------|
| 4" (100mm)  | 0471AG       |
| 6" (150mm)  | 0671AG       |
| 8" (200mm)  | 0871AG       |
| 10" (250mm) | 1071AG       |
| 12" (300mm) | 1271AG       |
| 15" (375mm) | 1571AG       |
| 18" (450mm) | 1871AG       |
| 24" (600mm) | 2471AG       |

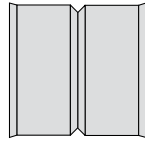

**CORRUGATED COUPLING**

## DUAL WALL CORRUGATED ADAPTER WITH SDR 35 SPIGOT

| SIZE        | PRODUCT CODE |
|-------------|--------------|
| 4" (100mm)  | 0468AG       |
| 6" (150mm)  | 0668AG       |
| 8" (200mm)  | 0868AG       |
| 10" (250mm) | 1068AG       |
| 12" (300mm) | 1268AG       |
| 15" (375mm) | 1568AG       |
| 18" (450mm) | 1868AG       |
| 24" (600mm) | 2468AG       |

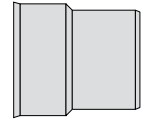

**ADAPTER WITH SDR 35 SPIGOT**

## DUAL WALL CORRUGATED ADAPTER WITH SDR 35 BELL

| SIZE        | PRODUCT CODE |
|-------------|--------------|
| 4" (100mm)  | 0469AG       |
| 6" (150mm)  | 0669AG       |
| 8" (200mm)  | 0869AG       |
| 10" (250mm) | 1069AG       |
| 12" (300mm) | 1269AG       |
| 15" (375mm) | 1569AG       |
| 18" (450mm) | 1869AG       |
| 24" (600mm) | 2469AG       |

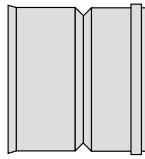

**ADAPTER WITH SDR 35 BELL**

## DUAL WALL CORRUGATED ADAPTER WITH SCHEDULE 40 SPIGOT

| SIZE        | PRODUCT CODE |
|-------------|--------------|
| 4" (100mm)  | 0478AG       |
| 6" (150mm)  | 0678AG       |
| 8" (200mm)  | 0878AG       |
| 10" (250mm) | 1078AG       |
| 12" (300mm) | 1278AG       |
| 15" (375mm) | 1578AG       |
| 18" (450mm) | 1878AG       |
| 24" (600mm) | 2478AG       |

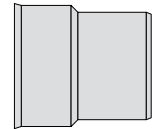

**ADAPTER WITH SCH 40 SPIGOT**

## DUAL WALL CORRUGATED ADAPTER WITH SCHEDULE 40 BELL

| SIZE        | PRODUCT CODE |
|-------------|--------------|
| 4" (100mm)  | 0479AG       |
| 6" (150mm)  | 0679AG       |
| 8" (200mm)  | 0879AG       |
| 10" (250mm) | 1079AG       |
| 12" (300mm) | 1279AG       |
| 15" (375mm) | 1579AG       |
| 18" (450mm) | 1879AG       |
| 24" (600mm) | 2479AG       |

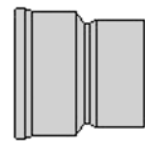

**ADAPTER WITH SCH 40 BELL**

## CLEAN OUT PLUGS

| SIZE        | PRODUCT CODE |
|-------------|--------------|
| 4" (100mm)  | 0474AG       |
| 6" (150mm)  | 0674AG       |
| 8" (200mm)  | 0874AG       |
| 10" (250mm) | 1074AG       |
| 12" (300mm) | 1274AG       |

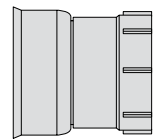

**CLEAN OUT PLUG**

## REPAIR COUPLING

| SIZE        | PRODUCT CODE |
|-------------|--------------|
| 4" (100mm)  | 0475AG       |
| 6" (150mm)  | 0675AG       |
| 8" (200mm)  | 0875AG       |
| 10" (250mm) | 1075AG       |
| 12" (300mm) | 1275AG       |
| 15" (375mm) | 1575AG       |
| 18" (450mm) | 1875AG       |
| 24" (600mm) | 2475AG       |

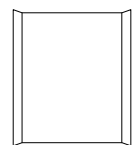

**PVC REPAIR SLEEVE**

NOTE: GASKET NOT REQUIRED FOR SDR 35 OR SCH 40 PORTION OF FITTING.



# TEES

## DUAL WALL TEE WITH DUAL WALL N-12 GASKETED BRANCH

| SIZE                      | PRODUCT CODE |
|---------------------------|--------------|
| 10" (250mm) x 4" (100mm)  | 1081AG       |
| 10" (250mm) x 6" (150mm)  | 1082AG       |
| 10" (250mm) x 8" (200mm)  | 1083AG       |
| 10" (250mm) x 10" (250mm) | 1084AG       |
| 12" (300mm) x 4" (100mm)  | 1281AG       |
| 12" (300mm) x 6" (150mm)  | 1282AG       |
| 12" (300mm) x 8" (200mm)  | 1283AG       |
| 12" (300mm) x 10" (250mm) | 1284AG       |
| 12" (300mm) x 12" (300mm) | 1285AG       |
| 15" (375mm) x 4" (100mm)  | 1581AG       |
| 15" (375mm) x 6" (150mm)  | 1582AG       |
| 15" (375mm) x 8" (200mm)  | 1583AG       |
| 15" (375mm) x 10" (250mm) | 1584AG       |
| 15" (375mm) x 12" (300mm) | 1585AG       |
| 15" (375mm) x 15" (375mm) | 1586AG       |
| 18" (450mm) x 4" (100mm)  | 1881AG       |
| 18" (450mm) x 6" (150mm)  | 1882AG       |
| 18" (450mm) x 8" (200mm)  | 1883AG       |
| 18" (450mm) x 10" (250mm) | 1884AG       |
| 18" (450mm) x 12" (300mm) | 1885AG       |
| 18" (450mm) x 15" (375mm) | 1886AG       |
| 18" (450mm) x 18" (450mm) | 1887AG       |
| 24" (600mm) x 4" (100mm)  | 2481AG       |
| 24" (600mm) x 6" (150mm)  | 2482AG       |
| 24" (600mm) x 8" (200mm)  | 2483AG       |
| 24" (600mm) x 10" (250mm) | 2484AG       |
| 24" (600mm) x 12" (300mm) | 2485AG       |
| 24" (600mm) x 15" (375mm) | 2486AG       |
| 24" (600mm) x 18" (450mm) | 2487AG       |
| 24" (600mm) x 24" (600mm) | 2488AG       |

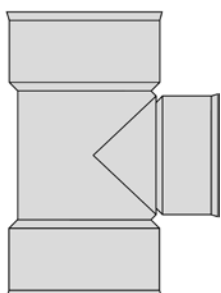

**TEE WITH BRANCH**

## DUAL WALL CORRUGATED TEE WITH SDR 35 BRANCH

| SIZE                      | PRODUCT CODE |
|---------------------------|--------------|
| 10" (250mm) x 4" (100mm)  | 1061AG       |
| 10" (250mm) x 6" (150mm)  | 1062AG       |
| 10" (250mm) x 8" (200mm)  | 1063AG       |
| 10" (250mm) x 10" (250mm) | 1064AG       |
| 12" (300mm) x 4" (100mm)  | 1261AG       |
| 12" (300mm) x 6" (150mm)  | 1262AG       |
| 12" (300mm) x 8" (200mm)  | 1263AG       |
| 12" (300mm) x 10" (250mm) | 1264AG       |
| 12" (300mm) x 12" (300mm) | 1265AG       |
| 15" (375mm) x 4" (100mm)  | 1561AG       |
| 15" (375mm) x 6" (150mm)  | 1562AG       |
| 15" (375mm) x 8" (200mm)  | 1563AG       |
| 15" (375mm) x 10" (250mm) | 1564AG       |
| 15" (375mm) x 12" (300mm) | 1565AG       |
| 15" (375mm) x 15" (375mm) | 1566AG       |
| 18" (450mm) x 4" (100mm)  | 1861AG       |
| 18" (450mm) x 6" (150mm)  | 1862AG       |
| 18" (450mm) x 8" (200mm)  | 1863AG       |
| 18" (450mm) x 10" (250mm) | 1864AG       |
| 18" (450mm) x 12" (300mm) | 1865AG       |
| 18" (450mm) x 15" (375mm) | 1866AG       |
| 18" (450mm) x 18" (450mm) | 1867AG       |
| 24" (600mm) x 4" (100mm)  | 2461AG       |
| 24" (600mm) x 6" (150mm)  | 2462AG       |
| 24" (600mm) x 8" (200mm)  | 2463AG       |
| 24" (600mm) x 10" (250mm) | 2464AG       |
| 24" (600mm) x 12" (300mm) | 2465AG       |
| 24" (600mm) x 15" (375mm) | 2466AG       |
| 24" (600mm) x 18" (450mm) | 2467AG       |

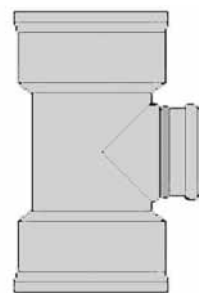

**TEE WITH SDR 35 BRANCH**

# WYES

## DUAL WALL CORRUGATED WYE WITH N-12 GASKETED BRANCH

| SIZE                      | PRODUCT CODE |
|---------------------------|--------------|
| 10" (250mm) x 4" (100mm)  | 1091AG       |
| 10" (250mm) x 6" (150mm)  | 1092AG       |
| 10" (250mm) x 8" (200mm)  | 1093AG       |
| 10" (250mm) x 8" (200mm)  | 1094AG       |
| 12" (300mm) x 4" (100mm)  | 1291AG       |
| 12" (300mm) x 6" (150mm)  | 1292AG       |
| 12" (300mm) x 8" (200mm)  | 1293AG       |
| 12" (300mm) x 10" (250mm) | 1294AG       |
| 12" (300mm) x 12" (300mm) | 1295AG       |
| 15" (375mm) x 4" (100mm)  | 1591AG       |
| 15" (375mm) x 6" (150mm)  | 1592AG       |
| 15" (375mm) x 8" (200mm)  | 1593AG       |
| 15" (375mm) x 10" (250mm) | 1594AG       |
| 15" (375mm) x 12" (300mm) | 1595AG       |
| 15" (375mm) x 15" (375mm) | 1596AG       |
| 18" (450mm) x 4" (100mm)  | 1891AG       |
| 18" (450mm) x 6" (150mm)  | 1892AG       |
| 18" (450mm) x 8" (200mm)  | 1893AG       |
| 18" (450mm) x 10" (250mm) | 1894AG       |
| 18" (450mm) x 12" (300mm) | 1895AG       |
| 18" (450mm) x 15" (375mm) | 1896AG       |
| 18" (450mm) x 18" (450mm) | 1897AG       |
| 24" (600mm) x 4" (100mm)  | 2491AG       |
| 24" (600mm) x 6" (150mm)  | 2492AG       |
| 24" (600mm) x 8" (200mm)  | 2493AG       |
| 24" (600mm) x 10" (250mm) | 2494AG       |
| 24" (600mm) x 12" (300mm) | 2495AG       |
| 24" (600mm) x 15" (375mm) | 2496AG       |
| 24" (600mm) x 18" (450mm) | 2497AG       |
| 24" (600mm) x 24" (600mm) | 2498AG       |

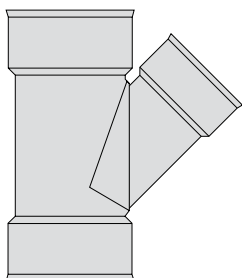

WYE WITH BRANCH

## DUAL WALL CORRUGATED WYE WITH SDR 35 BRANCH

| SIZE                      | PRODUCT CODE |
|---------------------------|--------------|
| 4" (100mm) x 4" (100mm)   | 0401AG       |
| 6" (150mm) x 4" (100mm)   | 0601AG       |
| 6" (150mm) x 6" (150mm)   | 0602AG       |
| 8" (200mm) x 4" (100mm)   | 0801AG       |
| 8" (200mm) x 6" (150mm)   | 0802AG       |
| 8" (200mm) x 8" (200mm)   | 0803AG       |
| 10" (250mm) x 4" (100mm)  | 1001AG       |
| 10" (250mm) x 6" (150mm)  | 1002AG       |
| 10" (250mm) x 8" (200mm)  | 1003AG       |
| 10" (250mm) x 10" (250mm) | 1004AG       |
| 12" (300mm) x 4" (100mm)  | 1201AG       |
| 12" (300mm) x 6" (150mm)  | 1202AG       |
| 12" (300mm) x 8" (200mm)  | 1203AG       |
| 12" (300mm) x 10" (250mm) | 1204AG       |
| 12" (300mm) x 12" (300mm) | 1205AG       |
| 15" (375mm) x 4" (100mm)  | 1501AG       |
| 15" (375mm) x 6" (150mm)  | 1502AG       |
| 15" (375mm) x 8" (200mm)  | 1503AG       |
| 15" (375mm) x 10" (250mm) | 1504AG       |
| 15" (375mm) x 12" (300mm) | 1505AG       |
| 15" (375mm) x 15" (375mm) | 1506AG       |
| 18" (450mm) x 4" (100mm)  | 1801AG       |
| 18" (450mm) x 6" (150mm)  | 1802AG       |
| 18" (450mm) x 8" (200mm)  | 1803AG       |
| 18" (450mm) x 10" (250mm) | 1804AG       |
| 18" (450mm) x 12" (300mm) | 1805AG       |
| 18" (450mm) x 15" (375mm) | 1806AG       |
| 18" (450mm) x 18" (450mm) | 1807AG       |
| 24" (600mm) x 4" (100mm)  | 2401AG       |
| 24" (600mm) x 6" (150mm)  | 2402AG       |
| 24" (600mm) x 8" (200mm)  | 2403AG       |
| 24" (600mm) x 10" (250mm) | 2404AG       |
| 24" (600mm) x 12" (300mm) | 2405AG       |
| 24" (600mm) x 15" (375mm) | 2406AG       |
| 24" (600mm) x 18" (450mm) | 2407AG       |
| 24" (600mm) x 24" (600mm) | 2408AG       |

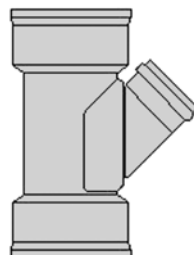

WYE WITH SDR 35 BRANCH

# SWEEPING TEE & REDUCER

## SWEEPING TEE WITH N-12 GASKETED BRANCH

| SIZE                     | PRODUCT CODE |
|--------------------------|--------------|
| 4" (100mm) x 4" (100mm)  | 0435AG       |
| 6" (150mm) x 4" (100mm)  | 0635AG       |
| 6" (150mm) x 6" (150mm)  | 0636AG       |
| 8" (200mm) x 4" (100mm)  | 0835AG       |
| 8" (200mm) x 6" (150mm)  | 0836AG       |
| 8" (200mm) x 8" (200mm)  | 0837AG       |
| 10" (250mm) x 4" (100mm) | 1035AG       |
| 10" (250mm) x 6" (150mm) | 1036AG       |
| 10" (250mm) x 8" (200mm) | 1037AG       |
| 12" (300mm) x 4" (100mm) | 1235AG       |
| 12" (300mm) x 6" (150mm) | 1236AG       |
| 12" (300mm) x 8" (200mm) | 1237AG       |
| 15" (375mm) x 4" (100mm) | 1535AG       |
| 15" (375mm) x 6" (150mm) | 1536AG       |
| 15" (375mm) x 8" (200mm) | 1537AG       |
| 18" (450mm) x 4" (100mm) | 1835AG       |
| 18" (450mm) x 6" (150mm) | 1836AG       |
| 18" (450mm) x 8" (200mm) | 1837AG       |
| 24" (600mm) x 4" (100mm) | 2435AG       |
| 24" (600mm) x 6" (150mm) | 2436AG       |
| 24" (600mm) x 8" (200mm) | 2437AG       |

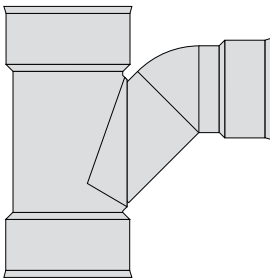

**SWEEPING  
TEE**

## CONCENTRIC REDUCER WITH N-12 GASKETED BRANCH

| SIZE                      | PRODUCT CODE |
|---------------------------|--------------|
| 6" (150mm) x 4" (100mm)   | 0611AG       |
| 8" (200mm) x 4" (100mm)   | 0811AG       |
| 8" (200mm) x 8" (200mm)   | 0812AG       |
| 10" (250mm) x 4" (100mm)  | 1011AG       |
| 10" (250mm) x 6" (150mm)  | 1012AG       |
| 10" (250mm) x 8" (200mm)  | 1013AG       |
| 12" (300mm) x 4" (100mm)  | 1211AG       |
| 12" (300mm) x 6" (150mm)  | 1212AG       |
| 12" (300mm) x 8" (200mm)  | 1213AG       |
| 12" (300mm) x 10" (250mm) | 1214AG       |
| 15" (375mm) x 4" (100mm)  | 1511AG       |
| 15" (375mm) x 6" (150mm)  | 1512AG       |
| 15" (375mm) x 8" (200mm)  | 1513AG       |
| 15" (375mm) x 10" (250mm) | 1514AG       |
| 15" (375mm) x 12" (300mm) | 1515AG       |
| 18" (450mm) x 4" (100mm)  | 1811AG       |
| 18" (450mm) x 6" (150mm)  | 1812AG       |
| 18" (450mm) x 8" (200mm)  | 1813AG       |
| 18" (450mm) x 10" (250mm) | 1814AG       |
| 18" (450mm) x 12" (300mm) | 1815AG       |
| 18" (450mm) x 15" (375mm) | 1816AG       |
| 24" (600mm) x 4" (100mm)  | 2411AG       |
| 24" (600mm) x 6" (150mm)  | 2412AG       |
| 24" (600mm) x 8" (200mm)  | 2413AG       |
| 24" (600mm) x 10" (250mm) | 2414AG       |
| 24" (600mm) x 12" (300mm) | 2415AG       |
| 24" (600mm) x 15" (375mm) | 2416AG       |
| 24" (600mm) x 18" (450mm) | 2417AG       |

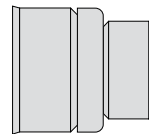

**CONCENTRIC REDUCER**

# ELBOWS

## ELBOW 22.5° WITH N-12 GASKETED BRANCH

| SIZE        | PRODUCT CODE |
|-------------|--------------|
| 4" (100mm)  | 0422AG       |
| 6" (150mm)  | 0622AG       |
| 8" (200mm)  | 0822AG       |
| 10" (250mm) | 1022AG       |
| 12" (300mm) | 1222AG       |
| 15" (375mm) | 1522AG       |
| 18" (450mm) | 1822AG       |
| 24" (600mm) | 2422AG       |

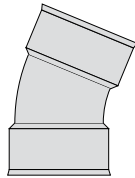

ELBOW 22.5°

## ELBOW 90° WITH N-12 GASKETED BRANCH

| SIZE        | PRODUCT CODE |
|-------------|--------------|
| 10" (250mm) | 1090AG       |
| 12" (300mm) | 1290AG       |
| 15" (375mm) | 1590AG       |
| 18" (450mm) | 1890AG       |
| 24" (600mm) | 2490AG       |

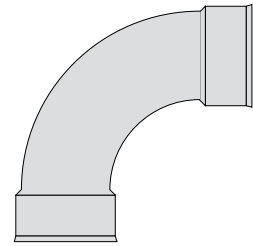

ELBOW 90°

## ELBOW 45° WITH N-12 GASKETED BRANCH

| SIZE        | PRODUCT CODE |
|-------------|--------------|
| 10" (250mm) | 1045AG       |
| 12" (300mm) | 1245AG       |
| 15" (375mm) | 1545AG       |
| 18" (450mm) | 1845AG       |
| 24" (600mm) | 2445AG       |

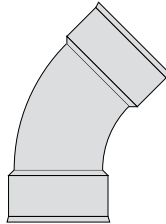

ELBOW 45°

# END CAP

## END CAP WITH N-12 GASKETED BRANCH

| SIZE        | PRODUCT CODE |
|-------------|--------------|
| 4" (100mm)  | 0432AG       |
| 6" (150mm)  | 0632AG       |
| 8" (200mm)  | 0832AG       |
| 10" (250mm) | 1032AG       |
| 12" (300mm) | 1232AG       |
| 15" (375mm) | 1532AG       |
| 18" (450mm) | 1832AG       |
| 24" (600mm) | 2432AG       |



END CAP

# MANHOLE ADAPTER

## SANDED MANHOLE ADAPTER

| SIZE        | PRODUCT CODE |
|-------------|--------------|
| 4" (100mm)  | 0477AG       |
| 6" (150mm)  | 0677AG       |
| 8" (200mm)  | 0877AG       |
| 10" (250mm) | 1077AG       |
| 12" (300mm) | 1277AG       |
| 15" (375mm) | 1577AG       |
| 18" (450mm) | 1877AG       |
| 24" (600mm) | 2477AG       |

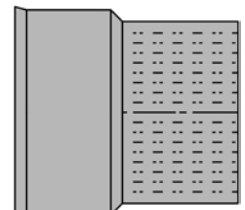

SANDED MANHOLE ADAPTER

# CATCH BASINS

## POLYETHYLENE CATCH BASINS\* Custom made to order only

| RISER DIAMETER          | RISER HEIGHT        | STUB** DIAMETER        |
|-------------------------|---------------------|------------------------|
| 12" - 36" (300mm-900mm) | 2' - 8' (0.6m-2.4m) | 4" - 30" (100mm-750mm) |

\*RISERS MUST BE PROPERLY BACKFILLED VERTICALLY PER DRAINAGE HANDBOOK - INSTALLATIONS/ VERTICAL. USE FITTING LIMITATION SHEET TO INFORM AND ENSURE PROPER INSTALLATION COMPLIANCE. 42" THROUGH 60" (1050 THROUGH 1500MM) HDPE NOT AVAILABLE FOR VERTICAL APPLICATIONS.

STUBS MUST FIT ON CIRCUMFERENCE AND HEIGHT OF RISER AND MUST NOT BE OVERLAPPING. STUBS ARE STANDARD LENGTH FOR COUPLING AND MUST BE A SMALLER DIAMETER THAN THE RISER. NO MORE THAN THREE STUBS PER STRUCTURE UNDER MOST CIRCUMSTANCES.

LIDS SHOULD BE INSTALLED PER LIGHT DUTY CATCH BASIN DETAIL AND ARE AVAILABLE THROUGH OTHER MANUFACTURERS. CATCH BASIN LIDS ARE NOT FABRICATED BY ADS/HANCOR. HDPE BOTTOM DOES NOT COME STANDARD WITH RISERS. MUST BE REQUESTED. \*\*STUBS AVAILABLE IN N-12® (HUB), N-12® PLAIN END OR SMOOTH HDPE.

END CAPS ARE FOR HORIZONTAL APPLICATIONS ONLY. END CAPS ARE NOT PERMITTED TO BE USED IN ANY VERTICAL APPLICATIONS. MISUSE OR FAILURE TO PROPERLY SECURE END CAPS MAY RESULT IN DAMAGE TO PERSONS OR PROPERTY OR MAY RESULT IN INJURY OR DEATH.

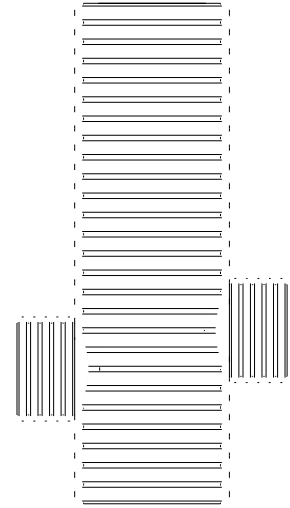

**CATCH BASIN**

## HP MANHOLE FOR STORM DRAINAGE\* Custom made to order only

| RISER DIAMETER | RISER HEIGHT        | STUB** DIAMETER        |
|----------------|---------------------|------------------------|
| 48" (1200mm)   | 2' - 8' (0.6m-2.4m) | 4" - 30" (100mm-750mm) |

\*RISERS MUST BE PROPERLY BACKFILLED VERTICALLY PER DRAINAGE HANDBOOK - INSTALLATIONS/ VERTICAL. USE FITTING LIMITATION SHEET TO INFORM AND ENSURE PROPER INSTALLATION COMPLIANCE.

STUBS MUST FIT ON CIRCUMFERENCE AND HEIGHT OF RISER AND MUST NOT BE OVERLAPPING. STUBS ARE STANDARD LENGTH FOR COUPLING AND MUST BE A SMALLER DIAMETER THAN THE RISER. NO MORE THAN THREE STUBS PER STRUCTURE UNDER MOST CIRCUMSTANCES.

LIDS SHOULD BE INSTALLED PER LIGHT DUTY CATCH BASIN DETAIL AND ARE AVAILABLE THROUGH OTHER MANUFACTURERS. CATCH BASIN LIDS ARE NOT FABRICATED BY ADS/HANCOR. \*\*STUBS AVAILABLE IN N-12® HP (HUB) OR N-12® HP PLAIN END.

END CAPS ARE FOR HORIZONTAL APPLICATIONS ONLY. END CAPS ARE NOT PERMITTED TO BE USED IN ANY VERTICAL APPLICATIONS. MISUSE OR FAILURE TO PROPERLY SECURE END CAPS MAY RESULT IN DAMAGE TO PERSONS OR PROPERTY OR MAY RESULT IN INJURY OR DEATH.



**HP MANHOLE FOR STORM DRAINAGE**

# HICKENBOTTOM® RISERS

## HICKENBOTTOM RISERS



| SIZE                      | DESCRIPTION               | PRODUCT CODE |
|---------------------------|---------------------------|--------------|
| 5" (125mm) x 1" (25mm)    | Orange Intake (12 Holes)  | 5013GC       |
| 5" (125mm) x 1" (25mm)    | Orange Riser with Cap-Top | 5023GC       |
| 5" (125mm) x 5/16" (8mm)  | Orange Ext-Btm            | 5033GC       |
| 5" (125mm)                | Blind Tee                 | 5043GC       |
| 5" (125mm)                | Restrictor                | 5063GC       |
| 6" (150mm) x 1" (25mm)    | Orange Riser with Cap-Top | 6023GC       |
| 6" (150mm) x 5/16" (8mm)  | Orange Ext-Btm            | 6033GC       |
| 6" (150mm)                | Black Slotted Intake      | 6073GC       |
| 6" (150mm)                | Black Blank Section       | 6053GC       |
| 6" (150mm)                | Black Riser Blind Tee     | 6043GC       |
| 6" (150mm)                | Restrictor                | 6063GC       |
| 8" (200mm) x 1" (25mm)    | Orange Riser with Cap-Top | 0823GC       |
| 8" (200mm) x 5/16" (8mm)  | Orange Ext-Btm            | 0833GC       |
| 8" (200mm)                | Black Slotted Intake      | 0873GC       |
| 8" (200mm)                | Black Blank Section       | 0853GC       |
| 8" (200mm)                | Black Riser Blind Tee     | 0843GC       |
| 8" (200mm)                | Restrictor                | 0863GC       |
| 10" (250mm) x 1" (25mm)   | Orange Riser with Cap-Top | 1023GC       |
| 10" (250mm) x 5/16" (8mm) | Orange Ext-Btm            | 1033GC       |
| 10" (250mm)               | Black Slotted Intake      | 1073GC       |
| 10" (250mm)               | Black Blank Section       | 1053GC       |
| 10" (250mm)               | Black Riser Blind Tee     | 1043GC       |
| 12" (300mm) x 1" (25mm)   | Orange Riser with Cap-Top | 1223GC       |
| 12" (300mm) x 5/16" (8mm) | Orange Ext-Btm            | 1233GC       |
| 12" (300mm)               | Black Slotted Intake      | 1273GC       |
| 12" (300mm)               | Black Blind Tee           | 1243GC       |



**HICKENBOTTOM RISER**



**HICKENBOTTOM RESTRICTOR**



# PRECISION INTAKES & RISERS

## PRECISION INTAKES



| SIZE                     | DESCRIPTION               | PRODUCT CODE |
|--------------------------|---------------------------|--------------|
| 6" x 1" (150 x 25 mm)    | Yellow Riser with Cap-Top | 6023GKY      |
| 6" x 5/16" (150 x 8 mm)  | Yellow Ext-Btm            | 6033GKY      |
| 6" (150 mm)              | Black Slotted Intake      | 6073GKY      |
| 6" (150 mm)              | Black Blank Section       | 6053GKY      |
| 6" (150 mm)              | Black Riser Blind Tee     | 6043GKY      |
| 6" (150 mm)              | Restrictor                | 6063GKY      |
| 8" x 1" (200 x 25 mm)    | Yellow Riser with Cap-Top | 0823GKY      |
| 8" x 5/16" (200 x 8 mm)  | Yellow Ext-Btm            | 0833GKY      |
| 8" (200 mm)              | Black Slotted Intake      | 0873GKY      |
| 8" (200 mm)              | Black Blank Section       | 0853GKY      |
| 8" (200 mm)              | Black Riser Blind Tee     | 0843GKY      |
| 8" (200 mm)              | Restrictor                | 0863GKY      |
| 10" x 1" (250 x 25 mm)   | Yellow Riser with Cap-Top | 1023GKY      |
| 10" x 5/16" (200 x 8 mm) | Yellow Ext-Btm            | 1033GKY      |
| 10" (250 mm)             | Black Slotted Intake      | 1073GKY      |
| 10" (250 mm)             | Black Blank Section       | 1053GKY      |
| 10" (250 mm)             | Black Riser Blind Tee     | 1043GKY      |

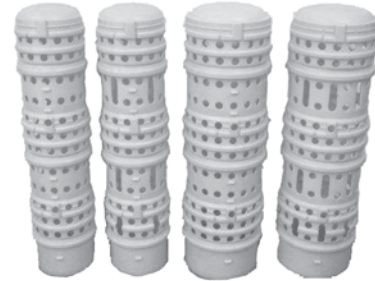

## QUICK DRAIN RISERS



| SIZE  | PRODUCT CODE |
|---|--------------|
| 6" Diameter x 6" Inlet (150 x 150 mm)                       | 0606QD       |
| 10" Diameter x 6" Inlet (250 x 150 mm)                      | 1006QD       |
| 10" Diameter x 8" Inlet (250 x 200 mm)                      | 1008QD       |
| 6" Diameter x 6" Inlet (150 x 150 mm) with Adjustable Inlet | 0606TPTQD    |

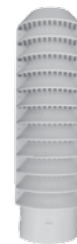

**QUICK DRAIN RISER**



**ADJUSTABLE INLET**

# OUTFLOW ACCESSORIES

## FLARED END SECTIONS, ANIMAL GUARDS & TRASH GUARDS

### FLARED END SECTIONS



| SIZE                      | PRODUCT CODE |
|---------------------------|--------------|
| 10" (250mm)               | 1015NP       |
| 12" (300mm) / 15" (375mm) | 1215NP       |
| 18" (450mm)               | 1810NP       |
| 24" (600mm)               | 2410NP       |
| 30" (750mm)               | 3015NP       |
| 36" (900mm)               | 3615NP       |

TOP VIEW

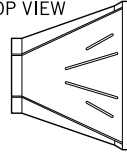

SIDE VIEW

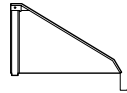

FRONT VIEW  
STAINLESS STEEL  
THREADED FASTENER

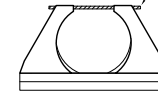

FLARED END SECTION

### METAL TRASH GUARDS\*



| DIAMETER    | DESCRIPTION      | PRODUCT CODE |
|-------------|------------------|--------------|
| 12" (300mm) | GALVANIZED STEEL | 1290DA       |
| 15" (375mm) | GALVANIZED STEEL | 1590DA       |
| 18" (450mm) | GALVANIZED STEEL | 1890DA       |
| 24" (600mm) | GALVANIZED STEEL | 2490DA       |
| 30" (750mm) | GALVANIZED STEEL | 3090DA       |
| 36" (900mm) | GALVANIZED STEEL | 3690DA       |

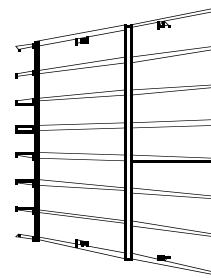

METAL TRASH GUARD

\*Grate is sized to fit flared end sections only.

### ANIMAL GUARDS



| DIAMETER    | DESCRIPTION                 | PRODUCT CODE |
|-------------|-----------------------------|--------------|
| 4" (100mm)  | METAL ANIMAL GUARD (FINGER) | 0470DA       |
|             | ANIMAL GUARD (SOLID)        | 0471DA       |
| 6" (150mm)  | METAL ANIMAL GUARD (FINGER) | 0670DA       |
|             | ANIMAL GUARD (SOLID)        | 0671DA       |
| 8" (200mm)  | METAL ANIMAL GUARD (FINGER) | 0870DA       |
|             | ANIMAL GUARD (SOLID)        | 0871DA       |
| 10" (250mm) | METAL ANIMAL GUARD (FINGER) | 1070DA       |
|             | ANIMAL GUARD (SOLID)        | 1071DA       |
| 12" (300mm) | METAL ANIMAL GUARD (FINGER) | 1270DA       |
| 15" (375mm) | METAL ANIMAL GUARD (FINGER) | 1570DA       |
| 18" (450mm) | METAL ANIMAL GUARD (FINGER) | 1870DA       |
| 24" (600mm) | METAL ANIMAL GUARD (FINGER) | 2470DA       |
| 30" (750mm) | METAL ANIMAL GUARD (FINGER) | 3070DA       |
| 36" (900mm) | METAL ANIMAL GUARD (FINGER) | 3670DA       |

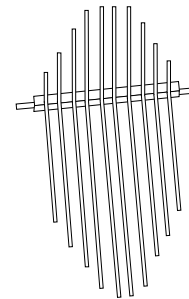

ANIMAL GUARD  
(FINGER)

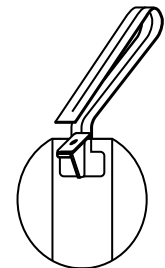

ANIMAL GUARD  
(SOLID)



# OUTFLOW ACCESSORIES

## BAR GUARDS & FLAP GATES

### BAR GUARDS



| DIAMETER    | PRODUCT CODE |
|-------------|--------------|
| 4" (100mm)  | 0420DA       |
| 6" (150mm)  | 0620DA       |
| 8" (200mm)  | 0820DA       |
| 10" (250mm) | 1020DA       |
| 12" (300mm) | 1220DA       |
| 15" (375mm) | 1520DA       |
| 18" (450mm) | 1820DA       |
| 24" (600mm) | 2420DA       |
| 30" (750mm) | 3020DA       |
| 36" (900mm) | 3620DA       |

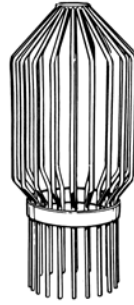

**BAR GUARD**

### FLAP GATES



| DIAMETER    | PRODUCT CODE |
|-------------|--------------|
| 4" (100mm)  | 0440DA       |
| 6" (150mm)  | 0640DA       |
| 8" (200mm)  | 0840DA       |
| 10" (250mm) | 1040DA       |
| 12" (300mm) | 1240DA       |
| 15" (375mm) | 1540DA       |
| 18" (450mm) | 1840DA       |
| 24" (600mm) | 2440DA       |
| 30" (750mm) | 3040DA       |
| 36" (900mm) | 3640DA       |



**FLAP GATE**

# RETENTION/DETENTION SYSTEMS

LANDMAX®

## MANIFOLDS – SIZE ON SIZE STUBS

| PIPE SIZE    | N-12 PLAIN END<br>COMPONENT MANIFOLD – SIZE ON SIZE |        |        |
|--------------|---|--------|--------|
|              | SINGLE  | DOUBLE | TRIPLE |
| 12" (300mm)  | 1251AN  | 1252AN | 1253AN |
| 15" (375mm)  | 1551AN  | 1552AN | 1553AN |
| 18" (450mm)  | 1851AN  | 1852AN | 1853AN |
| 24" (600mm)  | 2451AN  | 2452AN | 2453AN |
| 30" (750mm)  | 3051AN  | 3052AN | 3053AN |
| 36" (900mm)  | 3651AN  | 3652AN | 3653AN |
| 42" (1050mm) | 4251AN  | 4252AN |        |
| 48" (1200mm) | 4851AN  | 4852AN |        |
| 60" (1500mm) | 6051AN  | 6052AN |        |

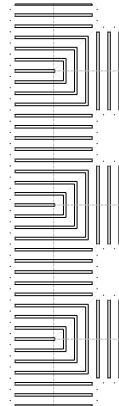
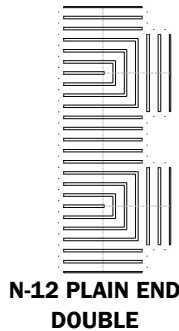
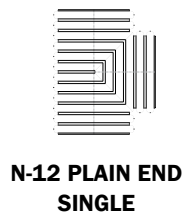

## 90° BEND MANIFOLDS

| PIPE SIZE    | N-12 PLAIN END | N-12 (WT)<br>BELL x BELL | N-12 (WT)<br>GASKET x GASKET | N-12 (WT)<br>BELL x GASKET |
|--------------|----------------|--------------------------|------------------------------|----------------------------|
| 12" (300mm)  | 1298AN         | 1298AN65BB               | 1298AN65GG                   | 1298AN65BBG                |
| 15" (375mm)  | 1598AN         | 1598AN65BB               | 1598AN65GG                   | 1598AN65BBG                |
| 18" (450mm)  | 1898AN         | 1898AN65BB               | 1898AN65GG                   | 1898AN65BBG                |
| 24" (600mm)  | 2498AN         | 2498AN65BB               | 2498AN65GG                   | 2498AN65BBG                |
| 30" (750mm)  | 3098AN         | 3098AN65BB               | 3098AN65GG                   | 3098AN65BBG                |
| 36" (900mm)  | 3698AN         | 3698AN65BB               | 3698AN65GG                   | 3698AN65BBG                |
| 42" (1050mm) | 4298AN         | 4298AN65BB               | 4298AN65GG                   | 4298AN65BBG                |
| 48" (1200mm) | 4898AN         | 4898AN65BB               | 4898AN65GG                   | 4898AN65BBG                |
| 60" (1500mm) | 6098AN         | 6098AN65BB               | 6098AN65GG                   | 6098AN65BBG                |

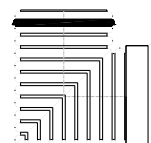
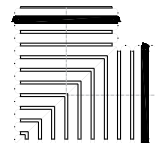
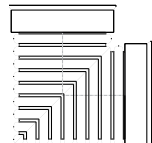
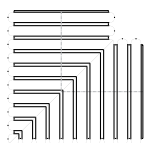

NOTE: CONTACT YOUR LOCAL SALES REPRESENTATIVE FOR AVAILABILITY OF SIZES NOT LISTED ABOVE. \*FOR RETENTION SYSTEMS ONLY.

# RETENTION/DETENTION SYSTEMS

LANDMAX®

## MANIFOLDS – SIZE ON SIZE STUBS

| PIPE SIZE    | N-12 (WT) BELL END COMPONENT MANIFOLD – SIZE ON SIZE |           |           | N-12 (WT) GASKET END COMPONENT MANIFOLD – SIZE ON SIZE |           |           |
|--------------|--|-----------|-----------|--|-----------|-----------|
|              | SINGLE   | DOUBLE    | TRIPLE    | SINGLE   | DOUBLE    | TRIPLE    |
| 12" (300mm)  | 1251AN65B  | 1252AN65B | 1253AN65B | 1251AN65G  | 1252AN65G | 1253AN65G |
| 15" (375mm)  | 1551AN65B  | 1552AN65B | 1553AN65B | 1551AN65G  | 1552AN65G | 1553AN65G |
| 18" (450mm)  | 1851AN65B  | 1852AN65B | 1853AN65B | 1851AN65G  | 1852AN65G | 1853AN65G |
| 24" (600mm)  | 2451AN65B  | 2452AN65B | 2453AN65B | 2451AN65G  | 2452AN65G | 2453AN65G |
| 30" (750mm)  | 3051AN65B  | 3052AN65B | 3053AN65B | 3051AN65G  | 3052AN65G | 3053AN65G |
| 36" (900mm)  | 3651AN65B  | 3652AN65B | 3653AN65B | 3651AN65G  | 3652AN65G | 3653AN65G |
| 42" (1050mm) | 4251AN65B  | 4252AN65B |           | 4251AN65G  | 4252AN65G |           |
| 48" (1200mm) | 4851AN65B  | 4852AN65B |           | 4851AN65G  | 4852AN65G |           |
| 60" (1500mm) | 6051AN65B  | 6052AN65B |           | 6051AN65G  | 6052AN65G |           |

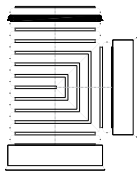

N-12 WT  
BELL END  
SINGLE

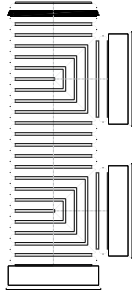

N-12 WT  
BELL END  
DOUBLE

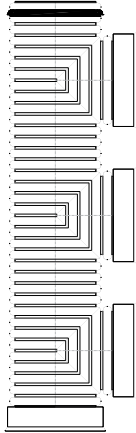

N-12 WT  
BELL END  
TRIPLE

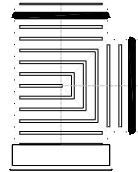

N-12 WT  
GASKET END  
SINGLE

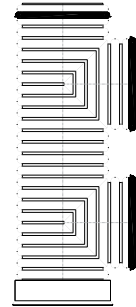

N-12 WT  
GASKET END  
DOUBLE

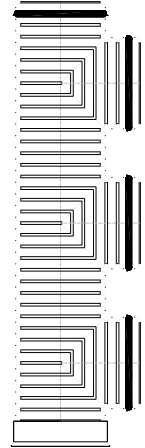

N-12 WT  
GASKET END  
TRIPLE

NOTE: CONTACT YOUR LOCAL SALES REPRESENTATIVE FOR AVAILABILITY OF SIZES NOT LISTED ABOVE.  
\*FOR RETENTION SYSTEMS ONLY.

# RETENTION/DETENTION SYSTEMS

## LANDMAX® ACCESSORIES

### DUAL WALL FABRICATED MANIFOLD INLET RISER

| PIPE SIZE   | PRODUCT CODE |
|-------------|--------------|
| 4" (100mm)  | 0403AN       |
| 6" (150mm)  | 0603AN       |
| 8" (200mm)  | 0803AN       |
| 10" (250mm) | 1003AN       |
| 12" (300mm) | 1203AN       |
| 15" (375mm) | 1503AN       |
| 18" (450mm) | 1803AN       |
| 24" (600mm) | 2403AN       |

This component item can only be ordered with standard manifold fittings or standard pipe. When ordering this component item, be sure to include shop drawing showing the location of inlet riser on standard manifold or pipe product.

Contact your local sales representative for acceptable size combinations, i.e.: 48" manifold fitting with a 24" diameter riser. **Not all combinations of inlet riser on standard manifold or pipe product are allowed.**

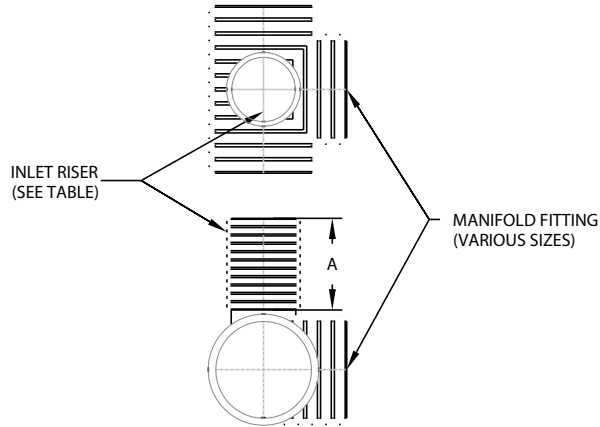

### DUAL WALL FABRICATED MANIFOLD CLEANOUT RISER

| PIPE SIZE  | PRODUCT CODE |
|------------|--------------|
| 4" (100mm) | 0402AN       |
| 6" (150mm) | 0602AN       |
| 8" (200mm) | 0802AN       |

This component item can only be ordered with standard manifold fittings. When ordering this component item, be sure to include shop drawing showing the location of inlet riser on standard manifold.

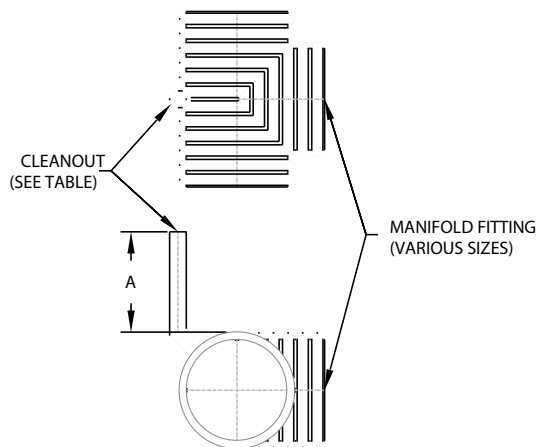

# RETENTION/DETENTION SYSTEMS

## LANDMAX® ACCESSORIES\*

### WELDED END PLATES (ST/WT CONNECTION)

| PIPE SIZE    | PRODUCT CODE |
|--------------|--------------|
| 4" (100mm)   | 0409AN       |
| 6" (150mm)   | 0609AN       |
| 8" (200mm)   | 0809AN       |
| 10" (250mm)  | 1009AN       |
| 12" (300mm)  | 1209AN       |
| 15" (375mm)  | 1509AN       |
| 18" (450mm)  | 1809AN       |
| 24" (600mm)  | 2409AN       |
| 30" (750mm)  | 3009AN       |
| 36" (900mm)  | 3609AN       |
| 42" (1050mm) | 4209AN       |
| 48" (1200mm) | 4809AN       |
| 60" (1500mm) | 6009AN       |

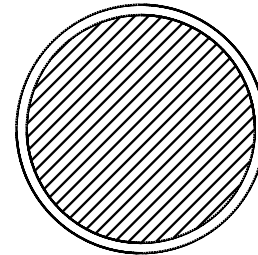
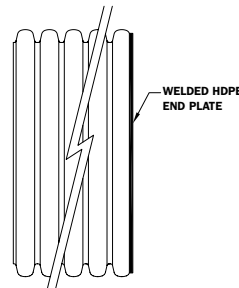

TOP VIEW  
WELDED END PLATE

### DUAL WALL FABRICATED STUB

| DIAMETER    | PRODUCT CODE |
|-------------|--------------|
| 4" (100mm)  | 0406AN       |
| 6" (150mm)  | 0606AN       |
| 8" (200mm)  | 0806AN       |
| 10" (250mm) | 1006AN       |
| 12" (300mm) | 1206AN       |
| 15" (375mm) | 1506AN       |
| 18" (450mm) | 1806AN       |
| 24" (600mm) | 2406AN       |

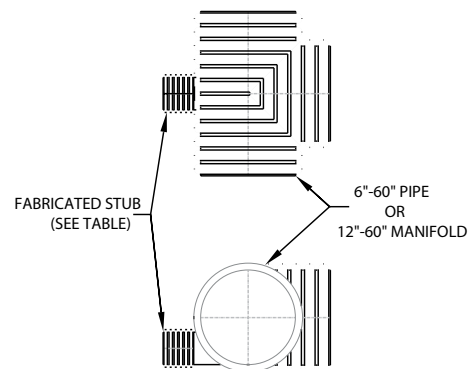

This component item can only be ordered with standard manifold fittings or standard pipe. When ordering this component item, be sure to include shop drawing showing the location of stub on standard manifold or pipe product.

Contact your local sales representative for acceptable size combinations, i.e.: 48" manifold fitting with a 24" stub. **Not all combinations of stub on standard manifold or pipe product are allowed.**

# RETENTION/DETENTION

## STORMTECH®

### SC-160

| DIMENSIONS<br>L x W x H                    | NOMINAL<br>WEIGHT | STORAGE<br>CAPACITY                        | MIN. INSTALLED<br>STORAGE                  | PRODUCT<br>CODE |
|--|-------------------|--|--|-----------------|
| 85.4" (2169mm) x 25" (635mm) x 12" (305mm) | 24 lbs. (10.9kg)  | 6.85 ft <sup>3</sup> (0.19m <sup>3</sup> ) | 15.0 ft <sup>3</sup> (0.42m <sup>3</sup> ) | SC160           |

### SC-310

| DIMENSIONS<br>L x W x H                    | NOMINAL<br>WEIGHT | STORAGE<br>CAPACITY                        | MIN. INSTALLED<br>STORAGE                  | PRODUCT<br>CODE |
|--|-------------------|--|--|-----------------|
| 85.4" (2169mm) x 34" (864mm) x 16" (406mm) | 35 lbs. (15.9kg)  | 14.7 ft <sup>3</sup> (0.42m <sup>3</sup> ) | 31.0 ft <sup>3</sup> (0.88m <sup>3</sup> ) | SC310           |

### SC-740

| DIMENSIONS<br>L x W x H                     | NOMINAL<br>WEIGHT | STORAGE<br>CAPACITY                        | MIN. INSTALLED<br>STORAGE                  | PRODUCT<br>CODE |
|---|-------------------|--|--|-----------------|
| 85.4" (2169mm) x 51" (1295mm) x 30" (762mm) | 75 lbs. (34.1kg)  | 45.9 ft <sup>3</sup> (1.30m <sup>3</sup> ) | 74.9 ft <sup>3</sup> (2.12m <sup>3</sup> ) | SC740           |

### DC-780

| DIMENSIONS<br>L x W x H                     | NOMINAL<br>WEIGHT | STORAGE<br>CAPACITY                        | MIN. INSTALLED<br>STORAGE                  | PRODUCT<br>CODE |
|---|-------------------|--|--|-----------------|
| 85.4" (2169mm) x 51" (1295mm) x 30" (762mm) | 80 lbs. (36.3kg)  | 46.2 ft <sup>3</sup> (1.30m <sup>3</sup> ) | 78.4 ft <sup>3</sup> (2.20m <sup>3</sup> ) | DC780           |

### MC-3500

| DIMENSIONS<br>L x W x H                      | NOMINAL<br>WEIGHT | STORAGE<br>CAPACITY                         | MIN. INSTALLED<br>STORAGE                   | PRODUCT<br>CODE |
|--|-------------------|---|---|-----------------|
| 86.0" (2184mm) x 77" (1956mm) x 45" (1143mm) | 135 lbs. (61.2kg) | 109.9 ft <sup>3</sup> (3.11m <sup>3</sup> ) | 178.9 ft <sup>3</sup> (5.06m <sup>3</sup> ) | MC3500          |

### MC-4500

| DIMENSIONS<br>L x W x H                     | NOMINAL<br>WEIGHT | STORAGE<br>CAPACITY                         | MIN. INSTALLED<br>STORAGE                   | PRODUCT<br>CODE |
|---|-------------------|---|---|-----------------|
| 52" (1321mm) x 100" (2540mm) x 60" (1524mm) | 130 lbs. (59.0kg) | 106.5 ft <sup>3</sup> (3.01m <sup>3</sup> ) | 162.6 ft <sup>3</sup> (4.60m <sup>3</sup> ) | MC4500          |



MC-4500

MC-3500

DC-780

SC-740

SC-310

SC-160LP

# RETENTION/DETENTION

## STORMTECH ENDCAPS

### SC-160LP

| DIMENSIONS<br>L x W x H                      | NOMINAL<br>WEIGHT | PRODUCT CODE |
|--|-------------------|--------------|
| 4.4" (112mm) x 18.6" (472mm) x 11.7" (297mm) | 2 lbs. (0.6kg)    | SC160IEPP    |

### SC-310

| DIMENSIONS<br>L x W x H                     | NOMINAL<br>WEIGHT | PRODUCT CODE |
|---|-------------------|--------------|
| 9.9" (252mm) x 29" (737mm) x 15.6" (396 mm) | 4 lbs. (1.8kg)    | SC310EPE     |

### SC-740

| DIMENSIONS<br>L x W x H                        | NOMINAL<br>WEIGHT | PRODUCT CODE |
|--|-------------------|--------------|
| 12.2 (310mm) x 45.9" (1166mm) x 29.3" (744 mm) | 13 lbs. (5.9kg)   | SC740EPE     |

### DC-780

| DIMENSIONS<br>L x W x H                       | NOMINAL<br>WEIGHT | PRODUCT CODE |
|---|-------------------|--------------|
| 12.2 (310mm) x 45.9" (1166mm) x 29.3" (744mm) | 13 lbs. (5.9kg)   | SC740EPE     |

### MC-3500

| DIMENSIONS<br>L x W x H                        | NOMINAL<br>WEIGHT | STORAGE<br>CAPACITY                        | MIN. INSTALLED<br>STORAGE*                 | PRODUCT<br>CODE |
|--|-------------------|--|--|-----------------|
| 25.7" (653mm) x 77" (1956mm) x 45.0" (1143 mm) | 50 lbs. (22.7kg)  | 14.9 ft <sup>3</sup> (0.42m <sup>3</sup> ) | 46.0 ft <sup>3</sup> (1.30m <sup>3</sup> ) | MC3500IEPP      |

### MC-4500

| DIMENSIONS<br>L x W x H                         | NOMINAL<br>WEIGHT | STORAGE<br>CAPACITY                        | MIN. INSTALLED<br>STORAGE*                  | PRODUCT<br>CODE |
|---|-------------------|--|---|-----------------|
| 35.1" (892mm) x 90.2" (2291mm) x 59.4" (1509mm) | 135 lbs. (61.2kg) | 35.7 ft <sup>3</sup> (1.01m <sup>3</sup> ) | 108.7 ft <sup>3</sup> (3.08m <sup>3</sup> ) | MC4500REPE      |

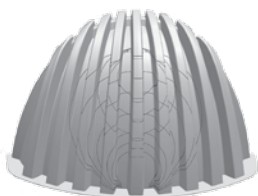

MC-4500 END CAP

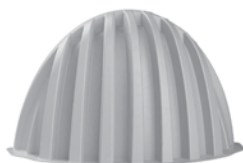

MC-3500 END CAP



DC-780 END CAP

SC-310, SC-740  
END CAPS

SC-160LP END CAP

# RETENTION/DETENTION

## STORMTECH ENDCAPS/ACCESSORIES

### TOP INLET FABRICATED END CAPS

| TYPE              | DIAMETER         | PRODUCT CODE  |
|-------------------|------------------|---------------|
| SC-310            | 6" (150mm) HDPE  | SC310EPE06T   |
| SC-740/<br>DC-780 | 6" (150mm) HDPE  | SC740EPE06T   |
|                   | 12" (300mm) HDPE | SC740EPE12T   |
|                   | 15" (375mm) HDPE | SC740EPE15T   |
|                   | 18" (450mm) HDPE | SC740EPE18T   |
| MC-3500           | 6" (150mm) HDPE  | MC3500IEPP06T |
|                   | 8" (200mm) HDPE  | MC3500IEPP08T |
|                   | 10" (250mm) HDPE | MC3500IEPP10T |
|                   | 12" (300mm) HDPE | MC3500IEPP12T |
|                   | 15" (375mm) HDPE | MC3500IEPP15T |
|                   | 18" (450mm) HDPE | MC3500IEPP18T |
| MC-4500           | 24" (600mm) HDPE | MC3500IEPP24T |
|                   | 12" (300mm) HDPE | MC4500REPE12T |
|                   | 15" (375mm) HDPE | MC4500REPE15T |
|                   | 18" (450mm) HDPE | MC4500REPE18T |
|                   | 24" (600mm) HDPE | MC4500REPE24T |



**TOP INLET  
FABRICATED ENDCAP**

### BOTTOM INLET FABRICATED END CAPS

| TYPE              | DIAMETER         | PRODUCT CODE  |
|-------------------|------------------|---------------|
| SC-310            | 6" (150mm) HDPE  | SC310EPE06B   |
|                   | 8" (200mm) HDPE  | SC310EPE08B   |
|                   | 10" (250mm) HDPE | SC310EPE10B   |
|                   | 12" (300mm) HDPE | SC310EPE12B   |
| SC-740/<br>DC-780 | 6" (150mm) HDPE  | SC740EPE06B   |
|                   | 8" (200mm) HDPE  | SC740EPE08B   |
|                   | 10" (300mm) HDPE | SC740EPE10B   |
|                   | 12" (300mm) HDPE | SC740EPE12B   |
|                   | 15" (375mm) HDPE | SC740EPE15B   |
|                   | 18" (450mm) HDPE | SC740EPE18B   |
| MC-3500           | 24" (600mm) HDPE | SC740EPE24B   |
|                   | 6" (150mm) HDPE  | MC3500IEPP06B |
|                   | 8" (200mm) HDPE  | MC3500IEPP08B |
|                   | 10" (250mm) HDPE | MC3500IEPP10B |
|                   | 12" (300mm) HDPE | MC3500IEPP12B |
|                   | 15" (375mm) HDPE | MC3500IEPP15B |
|                   | 18" (450mm) HDPE | MC3500IEPP18B |
| MC-4500           | 24" (600mm) HDPE | MC3500IEPP24B |
|                   | 30" (750mm) HDPE | MC3500IEPP30B |
|                   | 12" (300mm) HDPE | MC4500REPE12B |
|                   | 15" (250mm) HDPE | MC4500REPE15B |
|                   | 18" (300mm) HDPE | MC4500REPE18B |
|                   | 24" (375mm) HDPE | MC4500REPE24B |
|                   | 30" (450mm) HDPE | MC4500REPE30B |
|                   | 36" (600mm) HDPE | MC4500REPE36B |
| 42" (750mm) HDPE  | MC4500REPE42B    |               |



**BOTTOM INLET  
FABRICATED ENDCAP**



# RETENTION/DETENTION

## STORMTECH ACCESSORIES 90° BENDS

### SC-310 BENDS

| DESCRIPTION | PRODUCT CODE |
|-------------|--------------|
| 6" (150mm)  | 0698AN31     |
| 8" (200mm)  | 0898AN31     |
| 10" (250mm) | 1098AN31     |
| 12" (300mm) | 1298AN31     |

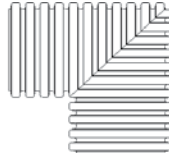

BEND

### SC-740/DC-780 BENDS

| DESCRIPTION | PRODUCT CODE |
|-------------|--------------|
| 8" (200mm)  | 0898AN74     |
| 10" (250mm) | 1098AN74     |
| 12" (300mm) | 1298AN74     |
| 15" (375mm) | 1598AN74     |
| 18" (450mm) | 1898AN74     |
| 24" (600mm) | 2498AN74     |

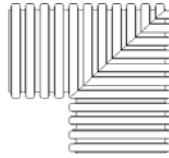

BEND

### MC-3500 BENDS

| DESCRIPTION | PRODUCT CODE |
|-------------|--------------|
| 12" (300mm) | 1298AN3512   |
| 15" (375mm) | 1598AN3515   |
| 18" (450mm) | 1898AN3518   |
| 24" (600mm) | 2498AN3524   |

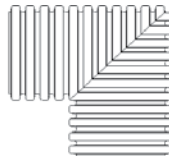

BEND

### MC-4500 BENDS

| DESCRIPTION | PRODUCT CODE |
|-------------|--------------|
| 12" (300mm) | 1298AN4512   |
| 15" (375mm) | 1598AN4515   |
| 18" (450mm) | 1898AN4518   |
| 24" (600mm) | 2498AN4524   |

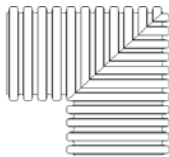

BEND

# RETENTION/DETENTION

## STORMTECH ACCESSORIES\*

### SC-310 SINGLE MANIFOLDS SIZE ON SIZE

| DESCRIPTION                   | PRODUCT CODE |
|-------------------------------|--------------|
| 6" x 6" (150mm x 150mm) Tee   | 0651AN3106   |
| 8" x 8" (200mm x 200mm) Tee   | 0851AN3108   |
| 10" x 10" (250mm x 250mm) Tee | 1051AN3110   |
| 12" x 12" (300mm x 300mm) Tee | 1251AN3112   |

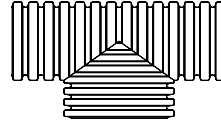

SINGLE MANIFOLD

### SC-740/DC-780 SINGLE MANIFOLDS SIZE ON SIZE

| DESCRIPTION                   | PRODUCT CODE |
|-------------------------------|--------------|
| 6" x 6" (150mm x 150mm) Tee   | 0651AN7406   |
| 8" x 8" (200mm x 200mm) Tee   | 0851AN7408   |
| 10" x 10" (250mm x 250mm) Tee | 1051AN7410   |
| 12" x 12" (300mm x 300mm) Tee | 1251AN7412   |
| 15" x 15" (375mm x 375mm) Tee | 1551AN7415   |
| 18" x 18" (450mm x 450mm) Tee | 1851AN7418   |
| 24" x 24" (600mm x 600mm) Tee | 2451AN7424   |

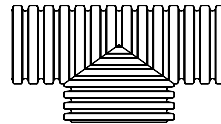

SINGLE MANIFOLD

### MC-3500 SINGLE MANIFOLDS SIZE ON SIZE

| DESCRIPTION                   | PRODUCT CODE |
|-------------------------------|--------------|
| 12" x 12" (300mm x 300mm) Tee | 1251AN3512   |
| 15" x 15" (375mm x 375mm) Tee | 1551AN3515   |
| 18" x 18" (450mm x 450mm) Tee | 1851AN3518   |
| 24" x 24" (600mm x 600mm) Tee | 2451AN3524   |

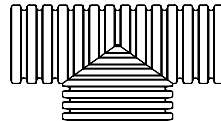

SINGLE MANIFOLD

### MC-4500 SINGLE MANIFOLDS SIZE ON SIZE

| DESCRIPTION                   | PRODUCT CODE |
|-------------------------------|--------------|
| 12" x 12" (300mm x 300mm) Tee | 1251AN4512   |
| 15" x 15" (375mm x 375mm) Tee | 1551AN4515   |
| 18" x 18" (450mm x 450mm) Tee | 1851AN4518   |
| 24" x 24" (600mm x 600mm) Tee | 2451AN4524   |

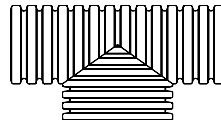

SINGLE MANIFOLD

# RETENTION/DETENTION

## STORMTECH ACCESSORIES\*

### SC-310 DOUBLE MANIFOLDS SIZE ON SIZE

| DESCRIPTION                   | PRODUCT CODE |
|-------------------------------|--------------|
| 6" x 6" (150mm x 150mm) Tee   | 0652AN3106   |
| 8" x 8" (200mm x 200mm) Tee   | 0852AN3108   |
| 10" x 10" (250mm x 250mm) Tee | 1052AN3110   |
| 12" x 12" (300mm x 300mm) Tee | 1252AN3112   |

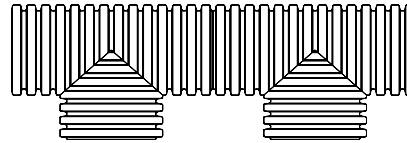

DOUBLE MANIFOLD

### SC-740/DC-780 DOUBLE MANIFOLDS SIZE ON SIZE

| DESCRIPTION                   | PRODUCT CODE |
|-------------------------------|--------------|
| 6" x 6" (150mm x 150mm) Tee   | 0652AN7406   |
| 8" x 8" (200mm x 200mm) Tee   | 0852AN7408   |
| 10" x 10" (250mm x 250mm) Tee | 1052AN7410   |
| 12" x 12" (300mm x 300mm) Tee | 1252AN7412   |
| 15" x 15" (375mm x 375mm) Tee | 1552AN7415   |
| 18" x 18" (450mm x 450mm) Tee | 1852AN7418   |
| 24" x 24" (600mm x 600mm) Tee | 2452AN7424   |

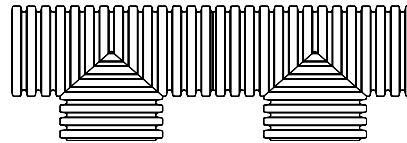

DOUBLE MANIFOLD

### MC-3500 DOUBLE MANIFOLDS SIZE ON SIZE

| DESCRIPTION                   | PRODUCT CODE |
|-------------------------------|--------------|
| 12" x 12" (300mm x 300mm) Tee | 1252AN3512   |
| 15" x 15" (375mm x 375mm) Tee | 1552AN3515   |
| 18" x 18" (450mm x 450mm) Tee | 1852AN3518   |
| 24" x 24" (600mm x 600mm) Tee | 2452AN3524   |

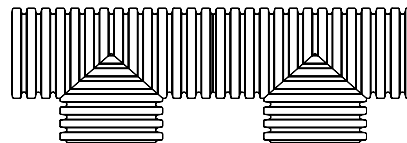

DOUBLE MANIFOLD

### SC-310 TRIPLE MANIFOLDS SIZE ON SIZE

| DESCRIPTION                   | PRODUCT CODE |
|-------------------------------|--------------|
| 6" x 6" (150mm x 150mm) Tee   | 0653AN3106   |
| 8" x 8" (200mm x 200mm) Tee   | 0853AN3108   |
| 10" x 10" (250mm x 250mm) Tee | 1053AN3110   |
| 12" x 12" (300mm x 300mm) Tee | 1253AN3112   |

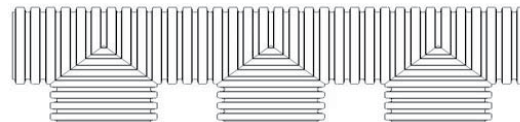

TRIPLE MANIFOLD

### SC-740/DC-780 TRIPLE MANIFOLDS SIZE ON SIZE

| DESCRIPTION                   | PRODUCT CODE |
|-------------------------------|--------------|
| 6" x 6" (150mm x 150mm) Tee   | 0653AN7406   |
| 8" x 8" (200mm x 200mm) Tee   | 0853AN7408   |
| 10" x 10" (250mm x 250mm) Tee | 1053AN7410   |
| 12" x 12" (300mm x 300mm) Tee | 1253AN7412   |
| 15" x 15" (375mm x 375mm) Tee | 1553AN7415   |
| 18" x 18" (450mm x 450mm) Tee | 1853AN7418   |
| 24" x 24" (600mm x 600mm) Tee | 2453AN7424   |

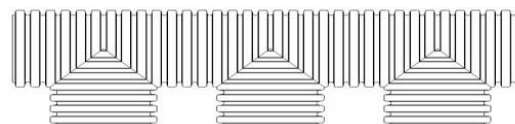

TRIPLE MANIFOLD

\*ADDITIONAL ACCESSORIES CAN BE FOUND ON PAGES 29-30.

# RETENTION/DETENTION

## STORMTECH ACCESSORIES\*

### SC-310 SINGLE MANIFOLDS REDUCING

| DESCRIPTION                   | PRODUCT CODE |
|-------------------------------|--------------|
| 8" x 6" (200mm x 150mm) Tee   | 0851AN3106   |
| 10" x 6" (250mm x 150mm) Tee  | 1051AN3106   |
| 10" x 8" (250mm x 200mm) Tee  | 1051AN3108   |
| 12" x 6" (300mm x 150mm) Tee  | 1251AN3106   |
| 12" x 8" (300mm x 200mm) Tee  | 1251AN3108   |
| 12" x 10" (300mm x 250mm) Tee | 1251AN3110   |
| 15" x 6" (375mm x 150mm) Tee  | 1551AN3106   |
| 15" x 8" (375mm x 200mm) Tee  | 1551AN3108   |
| 15" x 10" (375mm x 250mm) Tee | 1551AN3110   |
| 15" x 12" (375mm x 300mm) Tee | 1551AN3112   |
| 18" x 6" (450mm x 150mm) Tee  | 1851AN3106   |
| 18" x 8" (450mm x 200mm) Tee  | 1851AN3108   |
| 18" x 10" (450mm x 250mm) Tee | 1851AN3110   |
| 18" x 12" (450mm x 300mm) Tee | 1851AN3112   |
| 24" x 6" (600mm x 150mm) Tee  | 2451AN3106   |
| 24" x 8" (600mm x 200mm) Tee  | 2451AN3108   |
| 24" x 10" (600mm x 250mm) Tee | 2451AN3110   |
| 24" x 12" (600mm x 300mm) Tee | 2451AN3112   |

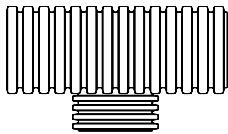

**SINGLE MANIFOLD REDUCING\*\***

### SC-740/DC-780 SINGLE MANIFOLDS REDUCING

| DESCRIPTION                    | PRODUCT CODE |
|--------------------------------|--------------|
| 8" x 6" (200mm x 150mm) Tee    | 0851AN7406   |
| 10" x 6" (250mm x 150mm) Tee   | 1051AN7406   |
| 10" x 8" (250mm x 200mm) Tee   | 1051AN7408   |
| 12" x 6" (300mm x 150mm) Tee   | 1251AN7406   |
| 12" x 8" (300mm x 200mm) Tee   | 1251AN7408   |
| 12" x 10" (300mm x 250mm) Tee  | 1251AN7410   |
| 15" x 6" (375mm x 150mm) Tee   | 1551AN7406   |
| 15" x 8" (375mm x 200mm) Tee   | 1551AN7408   |
| 15" x 10" (375mm x 250mm) Tee  | 1551AN7410   |
| 15" x 12" (375mm x 300mm) Tee  | 1551AN7412   |
| 18" x 6" (450mm x 150mm) Tee   | 1851AN7406   |
| 18" x 8" (450mm x 200mm) Tee   | 1851AN7408   |
| 18" x 10" (450mm x 250mm) Tee  | 1851AN7410   |
| 18" x 12" (450mm x 300mm) Tee  | 1851AN7412   |
| 18" x 15" (450mm x 375mm) Tee  | 1851AN7415   |
| 24" x 6" (600mm x 150mm) Tee   | 2451AN7406   |
| 24" x 8" (600mm x 200mm) Tee   | 2451AN7408   |
| 24" x 10" (600mm x 250mm) Tee  | 2451AN7410   |
| 24" x 12" (600mm x 300mm) Tee  | 2451AN7412   |
| 24" x 15" (600mm x 375mm) Tee  | 2451AN7415   |
| 24" x 18" (600mm x 450mm) Tee  | 2451AN7418   |
| 30" x 6" (750mm x 150mm) Tee   | 3051AN7406   |
| 30" x 12" (750mm x 300mm) Tee  | 3051AN7412   |
| 30" x 15" (750mm x 375mm) Tee  | 3051AN7415   |
| 30" x 18" (750mm x 450mm) Tee  | 3051AN7418   |
| 30" x 24" (750mm x 600mm) Tee  | 3051AN7424   |
| 36" x 12" (900mm x 300mm) Tee  | 3651AN7412   |
| 36" x 15" (900mm x 375mm) Tee  | 3651AN7415   |
| 36" x 18" (900mm x 450mm) Tee  | 3651AN7418   |
| 36" x 24" (900mm x 600mm) Tee  | 3651AN7424   |
| 42" x 12" (1050mm x 300mm) Tee | 4251AN7412   |
| 42" x 15" (1050mm x 375mm) Tee | 4251AN7415   |
| 42" x 18" (1050mm x 450mm) Tee | 4251AN7418   |
| 42" x 24" (1050mm x 600mm) Tee | 4251AN7424   |
| 48" x 12" (1200mm x 300mm) Tee | 4851AN7412   |
| 48" x 15" (1200mm x 375mm) Tee | 4851AN7415   |
| 48" x 18" (1200mm x 450mm) Tee | 4851AN7418   |
| 48" x 24" (1200mm x 600mm) Tee | 4851AN7424   |

\*ADDITIONAL ACCESSORIES CAN BE FOUND ON PAGES 29-30.

\*\*ALL STORMTECH REDUCING MANIFOLDS ARE ECCENTRIC.

# RETENTION/DETENTION

## STORMTECH ACCESSORIES\*

### MC-3500 SINGLE MANIFOLDS REDUCING

| DESCRIPTION                    | PRODUCT CODE |
|--------------------------------|--------------|
| 15" x 12" (375mm x 300mm) Tee  | 1551AN3512   |
| 18" x 12" (450mm x 300mm) Tee  | 1851AN3512   |
| 18" x 15" (450mm x 375mm) Tee  | 1851AN3515   |
| 24" x 12" (600mm x 300mm) Tee  | 2451AN3512   |
| 24" x 15" (600mm x 375mm) Tee  | 2451AN3515   |
| 24" x 18" (600mm x 450mm) Tee  | 2451AN3518   |
| 30" x 12" (750mm x 300mm) Tee  | 3051AN3512   |
| 30" x 15" (750mm x 375mm) Tee  | 3051AN3515   |
| 30" x 18" (750mm x 450mm) Tee  | 3051AN3518   |
| 30" x 24" (750mm x 600mm) Tee  | 3051AN3524   |
| 36" x 12" (750mm x 300mm) Tee  | 3651AN3512   |
| 36" x 15" (750mm x 375mm) Tee  | 3651AN3515   |
| 36" x 18" (750mm x 450mm) Tee  | 3651AN3518   |
| 36" x 24" (750mm x 600mm) Tee  | 3651AN3524   |
| 42" x 12" (750mm x 300mm) Tee  | 4251AN3512   |
| 42" x 15" (750mm x 375mm) Tee  | 4251AN3515   |
| 42" x 18" (750mm x 450mm) Tee  | 4251AN3518   |
| 42" x 24" (750mm x 600mm) Tee  | 4251AN3524   |
| 48" x 12" (1200mm x 300mm) Tee | 4851AN3512   |
| 48" x 15" (1200mm x 375mm) Tee | 4851AN3515   |
| 48" x 18" (1200mm x 450mm) Tee | 4851AN3518   |
| 48" x 24" (1200mm x 600mm) Tee | 4851AN3524   |

### MC-4500 SINGLE MANIFOLDS REDUCING

| DESCRIPTION                    | PRODUCT CODE |
|--------------------------------|--------------|
| 15" x 12" (375mm x 300mm) Tee  | 1551AN4512   |
| 18" x 12" (450mm x 300mm) Tee  | 1851AN4512   |
| 18" x 15" (450mm x 375mm) Tee  | 1851AN4515   |
| 24" x 12" (600mm x 300mm) Tee  | 2451AN4512   |
| 24" x 15" (600mm x 375mm) Tee  | 2451AN4515   |
| 24" x 18" (600mm x 450mm) Tee  | 2451AN4518   |
| 30" x 12" (750mm x 300mm) Tee  | 3051AN4512   |
| 30" x 15" (750mm x 375mm) Tee  | 3051AN4515   |
| 30" x 18" (750mm x 450mm) Tee  | 3051AN4518   |
| 30" x 24" (750mm x 600mm) Tee  | 3051AN4524   |
| 36" x 12" (750mm x 300mm) Tee  | 3651AN4512   |
| 36" x 15" (750mm x 375mm) Tee  | 3651AN4515   |
| 36" x 18" (750mm x 450mm) Tee  | 3651AN4518   |
| 36" x 24" (750mm x 600mm) Tee  | 3651AN4524   |
| 42" x 12" (750mm x 300mm) Tee  | 4251AN4512   |
| 42" x 15" (750mm x 375mm) Tee  | 4251AN4515   |
| 42" x 18" (750mm x 450mm) Tee  | 4251AN4518   |
| 42" x 24" (750mm x 600mm) Tee  | 4251AN4524   |
| 48" x 12" (1200mm x 300mm) Tee | 4851AN4512   |
| 48" x 15" (1200mm x 375mm) Tee | 4851AN4515   |
| 48" x 18" (1200mm x 450mm) Tee | 4851AN4518   |
| 48" x 24" (1200mm x 600mm) Tee | 4851AN4524   |

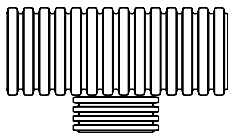

**SINGLE MANIFOLD REDUCING\*\***

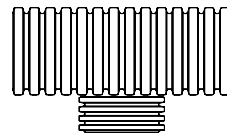

**SINGLE MANIFOLD REDUCING\*\***

\*ADDITIONAL ACCESSORIES CAN BE FOUND ON PAGES 29-30.

\*\*ALL STORMTECH REDUCING MANIFOLDS ARE ECCENTRIC.

# RETENTION/DETENTION

## STORMTECH ACCESSORIES\*

### SC-310 DOUBLE MANIFOLDS REDUCING

| DESCRIPTION                   | PRODUCT CODE |
|-------------------------------|--------------|
| 8" x 6" (200mm x 150mm) Tee   | 0852AN3106   |
| 10" x 6" (250mm x 150mm) Tee  | 1052AN3106   |
| 10" x 8" (250mm x 200mm) Tee  | 1052AN3108   |
| 12" x 6" (300mm x 150mm) Tee  | 1252AN3106   |
| 12" x 8" (300mm x 200mm) Tee  | 1252AN3108   |
| 12" x 10" (300mm x 250mm) Tee | 1252AN3110   |
| 15" x 6" (375mm x 150mm) Tee  | 1552AN3106   |
| 15" x 8" (375mm x 200mm) Tee  | 1552AN3108   |
| 15" x 10" (375mm x 250mm) Tee | 1552AN3110   |
| 15" x 12" (375mm x 300mm) Tee | 1552AN3112   |
| 18" x 6" (450mm x 150mm) Tee  | 1852AN3106   |
| 18" x 8" (450mm x 200mm) Tee  | 1852AN3108   |
| 18" x 10" (450mm x 250mm) Tee | 1852AN3110   |
| 18" x 12" (450mm x 300mm) Tee | 1852AN3112   |
| 24" x 6" (600mm x 150mm) Tee  | 2452AN3106   |
| 24" x 8" (600mm x 200mm) Tee  | 2452AN3108   |
| 24" x 10" (600mm x 250mm) Tee | 2452AN3110   |
| 24" x 12" (600mm x 300mm) Tee | 2452AN3112   |

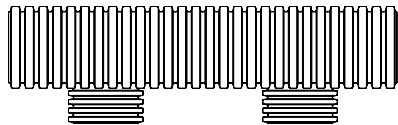

**DOUBLE MANIFOLD REDUCING\*\***

### SC-740/DC-780 DOUBLE MANIFOLDS REDUCING

| DESCRIPTION                    | PRODUCT CODE |
|--------------------------------|--------------|
| 8" x 6" (200mm x 150mm) Tee    | 0852AN7406   |
| 10" x 6" (250mm x 150mm) Tee   | 1052AN7406   |
| 10" x 8" (250mm x 200mm) Tee   | 1052AN7408   |
| 12" x 6" (300mm x 150mm) Tee   | 1252AN7406   |
| 12" x 8" (300mm x 200mm) Tee   | 1252AN7408   |
| 12" x 10" (300mm x 250mm) Tee  | 1252AN7410   |
| 15" x 6" (375mm x 150mm) Tee   | 1552AN7406   |
| 15" x 8" (375mm x 200mm) Tee   | 1552AN7408   |
| 15" x 10" (375mm x 250mm) Tee  | 1552AN7410   |
| 15" x 12" (375mm x 300mm) Tee  | 1552AN7412   |
| 18" x 6" (450mm x 150mm) Tee   | 1852AN7406   |
| 18" x 8" (450mm x 200mm) Tee   | 1852AN7408   |
| 18" x 10" (450mm x 250mm) Tee  | 1852AN7410   |
| 18" x 12" (450mm x 300mm) Tee  | 1852AN7412   |
| 18" x 15" (450mm x 375mm) Tee  | 1852AN7415   |
| 24" x 6" (600mm x 150mm) Tee   | 2452AN7406   |
| 24" x 8" (600mm x 200mm) Tee   | 2452AN7408   |
| 24" x 10" (600mm x 250mm) Tee  | 2452AN7410   |
| 24" x 12" (600mm x 300mm) Tee  | 2452AN7412   |
| 24" x 15" (600mm x 375mm) Tee  | 2452AN7415   |
| 24" x 18" (600mm x 450mm) Tee  | 2452AN7418   |
| 30" x 6" (750mm x 150mm) Tee   | 3052AN7406   |
| 30" x 12" (750mm x 300mm) Tee  | 3052AN7412   |
| 30" x 15" (750mm x 375mm) Tee  | 3052AN7415   |
| 30" x 18" (750mm x 450mm) Tee  | 3052AN7418   |
| 30" x 24" (750mm x 600mm) Tee  | 3052AN7424   |
| 36" x 12" (900mm x 300mm) Tee  | 3652AN7412   |
| 36" x 15" (900mm x 375mm) Tee  | 3652AN7415   |
| 36" x 18" (900mm x 450mm) Tee  | 3652AN7418   |
| 36" x 24" (900mm x 600mm) Tee  | 3652AN7424   |
| 42" x 12" (1050mm x 300mm) Tee | 4252AN7412   |
| 42" x 15" (1050mm x 375mm) Tee | 4252AN7415   |
| 42" x 18" (1050mm x 450mm) Tee | 4252AN7418   |
| 42" x 24" (1050mm x 600mm) Tee | 4252AN7424   |
| 48" x 12" (1200mm x 300mm) Tee | 4852AN7412   |
| 48" x 15" (1200mm x 375mm) Tee | 4852AN7415   |
| 48" x 18" (1200mm x 450mm) Tee | 4852AN7418   |
| 48" x 24" (1200mm x 600mm) Tee | 4852AN7424   |

\*ADDITIONAL ACCESSORIES CAN BE FOUND ON PAGES 29-30.

\*\*ALL STORMTECH REDUCING MANIFOLDS ARE ECCENTRIC.

# RETENTION/DETENTION

## STORMTECH ACCESSORIES\*

### MC-3500 DOUBLE MANIFOLDS REDUCING

| DESCRIPTION                    | PRODUCT CODE |
|--------------------------------|--------------|
| 15" x 12" (375mm x 300mm) Tee  | 1552AN3512   |
| 18" x 12" (450mm x 300mm) Tee  | 1852AN3512   |
| 18" x 15" (450mm x 375mm) Tee  | 1852AN3515   |
| 24" x 12" (600mm x 300mm) Tee  | 2452AN3512   |
| 24" x 15" (600mm x 375mm) Tee  | 2452AN3515   |
| 24" x 18" (600mm x 450mm) Tee  | 2452AN3518   |
| 30" x 12" (750mm x 300mm) Tee  | 3052AN3512   |
| 30" x 15" (750mm x 375mm) Tee  | 3052AN3515   |
| 30" x 18" (750mm x 450mm) Tee  | 3052AN3518   |
| 30" x 24" (750mm x 600mm) Tee  | 3052AN3524   |
| 36" x 12" (750mm x 300mm) Tee  | 3652AN3512   |
| 36" x 15" (750mm x 375mm) Tee  | 3652AN3515   |
| 36" x 18" (750mm x 450mm) Tee  | 3652AN3518   |
| 36" x 24" (750mm x 600mm) Tee  | 3652AN3524   |
| 42" x 12" (750mm x 300mm) Tee  | 4252AN3512   |
| 42" x 15" (750mm x 375mm) Tee  | 4252AN3515   |
| 42" x 18" (750mm x 450mm) Tee  | 4252AN3518   |
| 42" x 24" (750mm x 600mm) Tee  | 4252AN3524   |
| 48" x 12" (1200mm x 300mm) Tee | 4852AN3512   |
| 48" x 15" (1200mm x 375mm) Tee | 4852AN3515   |
| 48" x 18" (1200mm x 450mm) Tee | 4852AN3518   |
| 48" x 24" (1200mm x 600mm) Tee | 4852AN3524   |

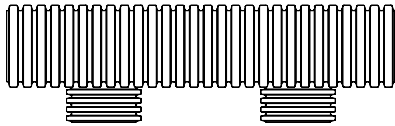

**DOUBLE MANIFOLD REDUCING\*\***

\*ADDITIONAL ACCESSORIES CAN BE FOUND ON PAGES 29-30.

\*\*ALL STORMTECH REDUCING MANIFOLDS ARE ECCENTRIC.

# RETENTION/DETENTION

## STORMTECH ACCESSORIES\*

### SC-310 TRIPLE MANIFOLDS REDUCING

| DESCRIPTION                   | PRODUCT CODE |
|-------------------------------|--------------|
| 8" x 6" (200mm x 150mm) Tee   | 0853AN3106   |
| 10" x 6" (250mm x 150mm) Tee  | 1053AN3106   |
| 10" x 8" (250mm x 200mm) Tee  | 1053AN3108   |
| 12" x 6" (300mm x 150mm) Tee  | 1253AN3106   |
| 12" x 8" (300mm x 200mm) Tee  | 1253AN3108   |
| 12" x 10" (300mm x 250mm) Tee | 1253AN3110   |
| 15" x 6" (375mm x 150mm) Tee  | 1553AN3106   |
| 15" x 8" (375mm x 200mm) Tee  | 1553AN3108   |
| 15" x 10" (375mm x 250mm) Tee | 1553AN3110   |
| 15" x 12" (375mm x 300mm) Tee | 1553AN3112   |
| 18" x 6" (450mm x 150mm) Tee  | 1853AN3106   |
| 18" x 8" (450mm x 200mm) Tee  | 1853AN3108   |
| 18" x 10" (450mm x 250mm) Tee | 1853AN3110   |
| 18" x 12" (450mm x 300mm) Tee | 1853AN3112   |
| 24" x 6" (600mm x 150mm) Tee  | 2453AN3106   |
| 24" x 8" (600mm x 200mm) Tee  | 2453AN3108   |
| 24" x 10" (600mm x 250mm) Tee | 2453AN3110   |
| 24" x 12" (600mm x 300mm) Tee | 2453AN3112   |

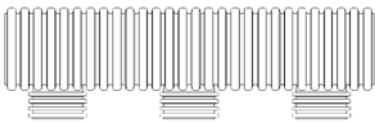

**TRIPLE MANIFOLD REDUCING\*\***

### SC-740/DC-780 TRIPLE MANIFOLDS REDUCING

| DESCRIPTION                    | PRODUCT CODE |
|--------------------------------|--------------|
| 8" x 6" (200mm x 150mm) Tee    | 0853AN7406   |
| 10" x 6" (250mm x 150mm) Tee   | 1053AN7406   |
| 10" x 8" (250mm x 200mm) Tee   | 1053AN7408   |
| 12" x 6" (300mm x 150mm) Tee   | 1253AN7406   |
| 12" x 8" (300mm x 200mm) Tee   | 1253AN7408   |
| 12" x 10" (300mm x 250mm) Tee  | 1253AN7410   |
| 15" x 6" (375mm x 150mm) Tee   | 1553AN7406   |
| 15" x 8" (375mm x 200mm) Tee   | 1553AN7408   |
| 15" x 10" (375mm x 250mm) Tee  | 1553AN7410   |
| 15" x 12" (375mm x 300mm) Tee  | 1553AN7412   |
| 18" x 6" (450mm x 150mm) Tee   | 1853AN7406   |
| 18" x 8" (450mm x 200mm) Tee   | 1853AN7408   |
| 18" x 10" (450mm x 250mm) Tee  | 1853AN7410   |
| 18" x 12" (450mm x 300mm) Tee  | 1853AN7412   |
| 18" x 15" (450mm x 375mm) Tee  | 1853AN7415   |
| 24" x 6" (600mm x 150mm) Tee   | 2453AN7406   |
| 24" x 8" (600mm x 200mm) Tee   | 2453AN7408   |
| 24" x 10" (600mm x 250mm) Tee  | 2453AN7410   |
| 24" x 12" (600mm x 300mm) Tee  | 2453AN7412   |
| 24" x 15" (600mm x 375mm) Tee  | 2453AN7415   |
| 24" x 18" (600mm x 450mm) Tee  | 2453AN7418   |
| 30" x 6" (750mm x 150mm) Tee   | 3053AN7406   |
| 30" x 12" (750mm x 300mm) Tee  | 3053AN7412   |
| 30" x 15" (750mm x 375mm) Tee  | 3053AN7415   |
| 30" x 18" (750mm x 450mm) Tee  | 3053AN7418   |
| 30" x 24" (750mm x 600mm) Tee  | 3053AN7424   |
| 36" x 12" (900mm x 300mm) Tee  | 3653AN7412   |
| 36" x 15" (900mm x 375mm) Tee  | 3653AN7415   |
| 36" x 18" (900mm x 450mm) Tee  | 3653AN7418   |
| 36" x 24" (900mm x 600mm) Tee  | 3653AN7424   |
| 42" x 12" (1050mm x 300mm) Tee | 4253AN7412   |
| 42" x 15" (1050mm x 375mm) Tee | 4253AN7415   |
| 42" x 18" (1050mm x 450mm) Tee | 4253AN7418   |
| 42" x 24" (1050mm x 600mm) Tee | 4253AN7424   |
| 48" x 12" (1200mm x 300mm) Tee | 4853AN7412   |
| 48" x 15" (1200mm x 375mm) Tee | 4853AN7415   |
| 48" x 18" (1200mm x 450mm) Tee | 4853AN7418   |
| 48" x 24" (1200mm x 600mm) Tee | 4853AN7424   |

\*ADDITIONAL ACCESSORIES CAN BE FOUND ON PAGES 29-30.

\*\*ALL STORMTECH REDUCING MANIFOLDS ARE ECCENTRIC.



# WATER QUALITY UNIT, GREASE INTERCEPTOR

## WATER QUALITY UNIT

| DIAMETER     | LENGTH      | INLET SIZE  | OUTLET SIZE | TREATED FLOW RATE  | PRODUCT CODE |
|--------------|-------------|-------------|-------------|--------------------|--------------|
| 36" (900mm)  | 20' (6.1m)  | 10" (250mm) | 10" (250mm) | 1.5 cfs (42 L/s)   | 3620WQA      |
| 36" (900mm)  | 40' (12.2m) | 10" (250mm) | 10" (250mm) | 2.38 cfs (67 L/s)  | 3640WQA      |
| 36" (900mm)  | 20' (6.1m)  | 10" (250mm) | 10" (250mm) | 0.7 cfs (20 L/s)   | 3620WQB      |
| 36" (900mm)  | 40' (12.2m) | 10" (250mm) | 10" (250mm) | 1.6 cfs (45 L/s)   | 3640WQB      |
| 42" (1050mm) | 20' (6.1m)  | 12" (300mm) | 12" (300mm) | 1.79 cfs (49 L/s)  | 4220WQA      |
| 42" (1050mm) | 40' (12.2m) | 12" (300mm) | 12" (300mm) | 3.66 cfs (104 L/s) | 4240WQA      |
| 42" (1050mm) | 20' (6.1m)  | 12" (300mm) | 12" (300mm) | 0.86 cfs (24 L/s)  | 4220WQB      |
| 42" (1050mm) | 40' (12.2m) | 12" (300mm) | 12" (300mm) | 1.83 cfs (52 L/s)  | 4240WQB      |
| 48" (1200mm) | 20' (6.1m)  | 12" (300mm) | 12" (300mm) | 2.26 cfs (64 L/s)  | 4820WQA      |
| 48" (1200mm) | 40' (12.2m) | 12" (300mm) | 12" (300mm) | 3.94 cfs (112 L/s) | 4840WQA      |
| 48" (1200mm) | 20' (6.1m)  | 12" (300mm) | 12" (300mm) | 1.13 cfs (32 L/s)  | 4820WQB      |
| 48" (1200mm) | 40' (12.2m) | 12" (300mm) | 12" (300mm) | 2.39 cfs (68 L/s)  | 4840WQB      |
| 60" (1500mm) | 20' (6.1m)  | 15" (375mm) | 15" (375mm) | 2.95 cfs (84 L/s)  | 6020WQA      |
| 60" (1500mm) | 40' (12.2m) | 15" (375mm) | 15" (375mm) | 6.23 cfs (176 L/s) | 6040WQA      |
| 60" (1500mm) | 20' (6.1m)  | 15" (375mm) | 15" (375mm) | 1.47 cfs (42 L/s)  | 6020WQB      |
| 60" (1500mm) | 40' (12.2m) | 15" (375mm) | 15" (375mm) | 3.12 cfs (88 L/s)  | 6040WQB      |

- Add two digit number at end of product number for bypass size.
- 00 at end of product number indicates no bypass.

### MODULE I

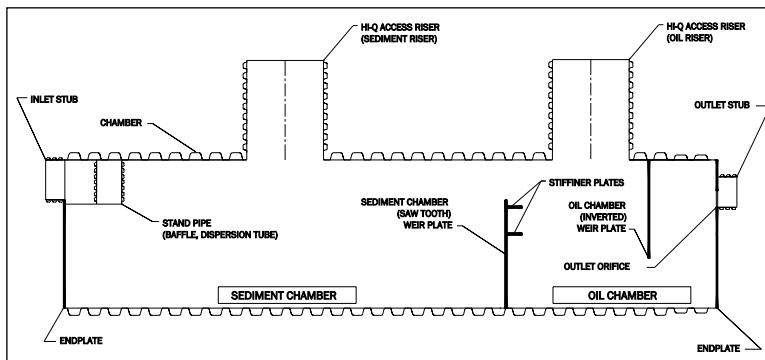

## GREASE INTERCEPTOR

| DIAMETER     | VOLUME                 | PRODUCT CODE |
|--------------|------------------------|--------------|
| 48" (1200mm) | 750 gal (2839 liters)  | 0750ANGT     |
| 48" (1200mm) | 1000 gal (3785 liters) | 1000ANGT     |
| 60" (1200mm) | 1500 gal (5678 liters) | 1500ANGT     |

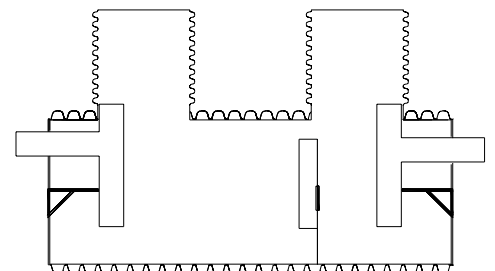

**GREASE INTERCEPTOR**

# FLEXSTORM® INLET FILTERS

## FLEXSTORM PURE (PERMANENT) FILTERS

### FILTERS FOR ROUND FRAMES/GRATES\*

| Sizing Guidelines<br>(Opening diameter up to) | Storage Capacity<br>ft <sup>3</sup> (m <sup>3</sup> ) | FX-Large<br>Sediment +<br>Trash | FX+<br>Trash + Oils | PC-Oils,<br>Fine<br>Sediments<br>& TSS | PC+<br>Excessive<br>Oils, Fine<br>Sediments<br>& TSS |
|---|---|---------------------------------|---------------------|--|--|
| 18" (450 mm)                                  | 1.6 (0.05)  | 62SHDRFX                        | 62SHDRFXP           | 62SHDRPC                               | 62SHDRPCP  |
| 24" (600 mm)                                  | 2.1 (0.06)  | 62MHDRFX                        | 62MHDRFXP           | 62MHDRPC                               | 62MHDRPCP  |
| 36" (900 mm)                                  | 3.8 (0.11)  | 62LHDRFX                        | 62LHDRFXP           | 62LHDRPC                               | 62LHDRPCP  |
| 42" (1050 mm)                                 | 4.2 (0.12)  | 62XLHDRFX                       | 62XLHDRFXP          | 62XLHDRPC                              | 62XLHDRPCP   |



### FILTERS FOR RECTANGULAR/ SQUARE FRAMES/GRATES\*

| Sizing Guidelines<br>(Up to)  | Storage Capacity<br>ft <sup>3</sup> (m <sup>3</sup> ) | FX-Large<br>Sediment +<br>Trash | FX+<br>Trash + Oils | PC-Oils,<br>Fine<br>Sediments<br>& TSS | PC+<br>Excessive<br>Oils, Fine<br>Sediments<br>& TSS |
|-------------------------------|---|---------------------------------|---------------------|--|--|
| 16" x 16"<br>(400 x 400 mm)   | 1.6 (0.05)  | 62SHDFX                         | 62SHDFXP            | 62SHDPC                                | 62SHDPCP   |
| 24" x 24"<br>(600 x 600 mm)   | 2.1 (0.06)  | 62MHDFX                         | 62MHDFXP            | 62MHDPC                                | 62MHDPCP   |
| 36" x 24"<br>(900 x 600 mm)   | 3.8 (0.11)  | 62LHDFX                         | 62LHDFXP            | 62LHDPC                                | 62LHDPCP   |
| 48" x 48"<br>(1200 x 1200 mm) | 6.6 (0.18)  | 62XLHDFX                        | 62XLHDFXP           | 62XLHDPC                               | 62XLHDPCP  |

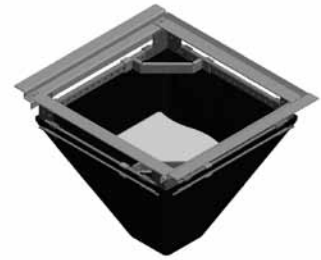

### FILTERS FOR OPEN THROAT CURB INLETS\*

| Sizing Guidelines                    | Storage Capacity<br>ft <sup>3</sup> (m <sup>3</sup> ) | FX-Large<br>Sediment +<br>Trash | FX+<br>Trash + Oils | PC-Oils,<br>Fine<br>Sediments<br>& TSS | PC+<br>Excessive<br>Oils, Fine<br>Sediments &<br>TSS |
|--------------------------------------|---|---------------------------------|---------------------|--|--|
| Up to 4' (1.2 m)                     | 3.3 (0.09)  | 6HDWM1FX                        | 6HDWM1FXP           | 6HDWM1PC                               | 6HDWM1PCP  |
| Between 4' & 8'<br>(1.2 & 2.4 m)     | 6.6 (0.18)  | 62HDWM2FX                       | 62HDWM2FXP          | 62HDWM2PC                              | 62HDWM2PCP   |
| Between 8' & 12'<br>(2.4 & 3.7 m)    | 9.9 (0.28)  | 62HDWM3FX                       | 62HDWM3FXP          | 62HDWM3PC                              | 62HDWM3PCP   |
| Between 12' & 16'<br>(3.6 m & 4.9 m) | 13.2 (0.37)   | 62HDWM4FX                       | 62HDWM4FXP          | 62HDWM4PC                              | 62HDWM4PCP   |



\*Custom sizes and bag depths available. Typical depth is 22" (550 mm).

# FLEXSTORM INLET FILTERS

## FLEXSTORM CATCH-IT® (TEMPORARY) FILTERS

### FILTERS FOR ROUND FRAMES/GRATES\*

| OPENING (DIA.)<br>(Up to size opening) | FX Woven Bag |
|--|--------------|
| 18" (450 mm)                           | 62SRDFX      |
| 25" (625 mm)                           | 62MRDFX      |
| 30" (750 mm)                           | 62LRDFX      |
| 37" (925 mm)                           | 62XLRDFX     |
| 48" (1200 mm)                          | 62XXLRDFX    |



### FILTERS FOR RECTANGULAR/ SQUARE FRAMES/GRATES\*

| OPENING (DIA.)<br>(Up to size opening) | FX Woven Bag |
|--|--------------|
| 16" x 16" (400 x 400 mm)               | 62SSQFX      |
| 24" x 24" (600 x 600 mm)               | 62MSQFX      |
| 36" x 24" (900 x 600 mm)               | 62LSQFX      |
| 48" x 48" (1200 x 1200 mm)             | 62XLSQFX     |



### FILTERS FOR RECTANGULAR FRAMES/GRATES/CURB HOODS\*

| OPENING (DIA.)<br>(Up to size opening) | FX Woven Bag |
|--|--------------|
| 16" x 16" (400 x 400 mm)               | 62SCBFX      |
| 24" x 24" (600 x 600 mm)               | 62MCBFX      |
| 36" x 24" (900 x 600 mm)               | 62LCBFX      |
| 48" x 48" (1200 x 1200 mm)             | 62XLCBFX     |



### CATCH-IT LITE FILTERS

| FRAME/GRATE TYPE                        | PRODUCT CODES |
|---|---------------|
| Square/Rectangular                      | 62LITE        |
| Square/Rectangular<br>with Curb Opening | 62LITECB      |
| Round Frame/Grate                       | 62LITERD      |



62LITE



62LITECB

\*Custom sizes and bag depths available. Typical depth is 22" (550 mm).

# FLEXSTORM INLET FILTERS

## NYLOPLAST FILTERS, REPLACEMENT BAGS & ACCESSORIES

### ROUND NYLOPLAST STAINLESS STEEL

| OPENING (DIA.)                         | FX Woven Bag | FX+ Woven with Oil Skimmer | PC Bag (Adsorb-It Lined) | PC+ Bag   | LL: Litter Leaf Bag |
|--|--------------|----------------------------|--------------------------|-----------|---------------------|
| 8" (200 mm)<br>Drop In/In Line Grates  | 6208NYFX     | 6208NYFXP                  | 6208NYPC                 | 6208NYPCP | 6208NYLL            |
| 10" (250 mm)<br>Drop In/In Line Grates | 6210NYFX     | 6210NYFXP                  | 6210NYPC                 | 6210NYPCP | 6210NYLL            |
| 12" (300 mm)<br>Nyloplast Casting      | 6212NYFX     | 6212NYFXP                  | 6212NYPC                 | 6212NYPCP | 6212NYLL            |
| 15" (375 mm)<br>Nyloplast Casting      | 6215NYFX     | 6215NYFXP                  | 6215NYPC                 | 6215NYPCP | 6215NYLL            |
| 18" (450 mm)<br>Nyloplast Casting      | 6218NYFX     | 6218NYFXP                  | 6218NYPC                 | 6218NYPCP | 6218NYLL            |
| 24" (600 mm)<br>Nyloplast Casting      | 6224NYFX     | 6224NYFXP                  | 6224NYPC                 | 6224NYPCP | 6224NYLL            |
| 30" (750 mm)<br>Nyloplast Casting      | 6230NYFX     | 6230NYFXP                  | 6230NYPC                 | 6230NYPCP | 6230NYLL            |



### REPLACEMENT BAGS\*

| BAG SIZES<br>(Round or Rectangle) | FX       | FXP       | PC Bag   | PCP Bag   |
|-----------------------------------|----------|-----------|----------|-----------|
| Small                             | 62SRBFX  | 62SRBFXP  | 62SRBPC  | 62SRBPCP  |
| Medium                            | 62MRBFX  | 62MRBFXP  | 62MRBPC  | 62MRBPCP  |
| Large                             | 62LRBFX  | 62LRBFXP  | 62LRBPC  | 62LRBPCP  |
| X-Large (Round only)              | 62XLRBFX | 62XLRBFXP | 62XLRBPC | 62XLRBPCP |

\*Part numbers listed for standard depth filter bags of 22". To order the 12" deep "short" bags simply add a "-S" suffix to part number.

### CLEARTEC RUBBERIZER OIL SKIMMER BAG

| BAG SIZES  | PCP Bag  |
|--|----------|
| Standard Skimmer Pouch with Swivel Hook/Strap              | 62CTSB   |
| 3" diameter x 34" Long Skimmer Boom with Swivel Hook/Strap | 62CTSB34 |

### MAINTENANCE TOOL

|                                     |       |
|-------------------------------------|-------|
| 2-Person to Remove Grates & Filters | 62UMT |
|-------------------------------------|-------|



# FLEXSTORM INLET FILTERS

## FULL TRASH CAPTURE INSERTS

### FULL TRASH CAPTURE INSERTS\*

| DESCRIPTION   | BASIN SIZE               | BASKET DEPTH | PRODUCT CODE |
|---|--------------------------|--------------|--------------|
| 12" x 12" (300 x 300 mm)<br>Full Trash Capture Insert | 12" x 12" (300 x 300 mm) | 12" (300 mm) | 62HD12FTC    |
| 18" x 18" (450 x 450 mm)<br>Full Trash Capture Insert | 18" x 18" (450 x 450 mm) | 12" (300 mm) | 62HD18FTC    |
| 24" x 24" (600 x 600 mm)<br>Full Trash Capture Insert | 24" x 24" (600 x 600 mm) | 12" (300 mm) | 62HD24FTC    |
| 36" x 18" (900 x 450 mm)<br>Full Trash Capture Insert | 36" x 18" (900 x 450 mm) | 12" (300 mm) | 62HD3618FTC  |
| 36" x 24" (900 x 600 mm)<br>Full Trash Capture Insert | 36" x 24" (900 x 600 mm) | 12" (300 mm) | 62HD3624FTC  |
| 36" x 36" (900 x 900 mm)<br>Full Trash Capture Insert | 36" x 36" (900 x 900 mm) | 12" (300 mm) | 62HD36FTC    |



ROUND GRATE FILTER



SQUARE/RECTANGULAR GRATE FILTER

\* Custom sizes and basket depths available.

### CURB INLETS FULL TRASH CAPTURE INSERTS\*

| DESCRIPTION  | CURB OPENING WIDTH<br>in. (mm) | BASKET DEPTH | PRODUCT CODE |
|--|--------------------------------|--------------|--------------|
| 36" (900 mm) Curb Inlet<br>Full Trash Capture Insert   | 36" (900 mm)                   | 12" (300 mm) | 62HDWM36FTC  |
| 42" (1050 mm) Curb Inlet<br>Full Trash Capture Insert  | 42" (1050 mm)                  | 12" (300 mm) | 62HDWM42FTC  |
| 48" (1200 mm) Curb Inlet<br>Full Trash Capture Insert  | 48" (1200 mm)                  | 12" (300 mm) | 62HDWM48FTC  |
| 60" (1500 mm) Curb Inlet<br>Full Trash Capture Insert  | 60" (1500 mm)                  | 12" (300 mm) | 62HDWM60FTC  |
| 72" (1800 mm) Curb Inlet<br>Full Trash Capture Insert  | 72" (1800 mm)                  | 12" (300 mm) | 62HDWM72FTC  |
| 84" (2100 mm) Curb Inlet<br>Full Trash Capture Insert  | 84" (2100 mm)                  | 12" (300 mm) | 62HDWM84FTC  |
| 96" (2400 mm) Curb Inlet<br>Full Trash Capture Insert  | 96" (2400 mm)                  | 12" (300 mm) | 62HDWM96FTC  |
| 120" (3000 mm) Curb Inlet<br>Full Trash Capture Insert | 120" (3000 mm)                 | 12" (300 mm) | 62HDWM120FTC |

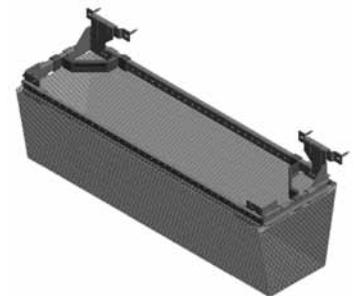

CURB INLET INSERT

\* Custom sizes and basket depths available.

# FLEXSTORM INLET FILTERS

## Connector Pipe Screen

### CONNECTOR PIPE SCREEN U-SHAPE\*

| DESCRIPTION  | SCREEN LENGTH | SCREEN HEIGHT | PRODUCT CODE | REFERENCE CODE |
|--|---------------|---------------|--------------|----------------|
| 36" x 18" (900 x 450 mm)<br>Connector Pipe Screen  | 36" (900 mm)  | 18" (450 mm)  | 62CPS        | 3L18H-Bypass-U |
| 48" x 18" (1200 x 450 mm)<br>Connector Pipe Screen | 48" (1200 mm) | 18" (450 mm)  | 62CPS        | 4L18H-Bypass-U |
| 60" x 18" (1500 x 450 mm)<br>Connector Pipe Screen | 60" (1500 mm) | 18" (450 mm)  | 62CPS        | 5L18H-Bypass-U |



### CONNECTOR PIPE SCREEN L-SHAPE\*

| DESCRIPTION  | SCREEN LENGTH | SCREEN HEIGHT | PRODUCT CODE | REFERENCE CODE |
|--|---------------|---------------|--------------|----------------|
| 36" x 18" (900 x 450 mm)<br>Connector Pipe Screen  | 36" (900 mm)  | 18" (450 mm)  | 62CPS        | 3L18H-Bypass-L |
| 48" x 18" (1200 x 450 mm)<br>Connector Pipe Screen | 48" (1200 mm) | 18" (450 mm)  | 62CPS        | 4L18H-Bypass-L |
| 60" x 18" (1500 x 450 mm)<br>Connector Pipe Screen | 60" (1500 mm) | 18" (450 mm)  | 62CPS        | 5L18H-Bypass-L |

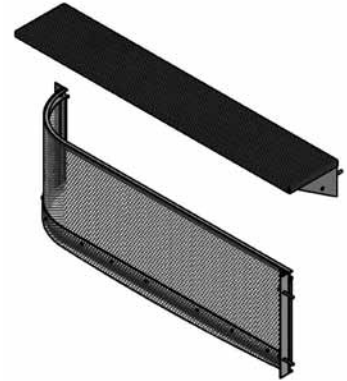

### CONNECTOR PIPE SCREEN U EXTENDED SHAPE\*

| DESCRIPTION  | SCREEN LENGTH | SCREEN HEIGHT | PRODUCT CODE | REFERENCE CODE    |
|--|---------------|---------------|--------------|-------------------|
| 36" x 18" (900 x 450 mm)<br>Connector Pipe Screen  | 36" (900 mm)  | 18" (450 mm)  | 62CPS        | 3L18H-Bypass-UEXT |
| 48" x 18" (1200 x 450 mm)<br>Connector Pipe Screen | 48" (1200 mm) | 18" (450 mm)  | 62CPS        | 4L18H-Bypass-UEXT |
| 60" x 18" (1500 x 450 mm)<br>Connector Pipe Screen | 60" (1500 mm) | 18" (450 mm)  | 62CPS        | 5L18H-Bypass-UEXT |



\* Custom shapes and sizes available. Bypass height determined by catch basin size.

# BAYSAVER STORMWATER TREATMENT

*BayFilter™, BaySeparator™, Barracuda™*

## BAYFILTER STORMWATER TREATMENT

| MODEL         | DIAMETER     | FLOW RATE           | MEDIA AREA                               | SEDIMENT CAPTURE CAPACITY | PRODUCT CODE |
|---------------|--------------|---------------------|--|---------------------------|--------------|
| BayFilter 545 | 28" (711 mm) | 45 gpm (170 l/min)  | 90 ft <sup>2</sup> (8.4 m <sup>2</sup> ) | 350 lbs (159 kg)          | BAYFLTR-545  |
| BayFilter 530 | 28" (711 mm) | 30 gpm (114 l/min)  | 90ft <sup>2</sup> (8.4 m <sup>2</sup> )  | 350 lbs (159 kg)          | BAYFLTR-530  |
| BayFilter 522 | 28" (711 mm) | 22.5 gpm (85 l/min) | 45 ft <sup>2</sup> (4.2 m <sup>2</sup> ) | 175 lbs (79 kg)           | BAYFLTR-522  |
| BayFilter 645 | 28" (711 mm) | 45 gpm (170 l/min)  | 90 ft <sup>2</sup> (8.4 m <sup>2</sup> ) | 350 lbs (159 kg)          | BAYFLTR-645  |
| BayFilter 630 | 28" (711 mm) | 30 gpm (114 l/min)  | 90 ft <sup>2</sup> (8.4 m <sup>2</sup> ) | 350 lbs (159 kg)          | BAYFLTR-630  |
| BayFilter 622 | 28" (711 mm) | 22.5 gpm (85 l/min) | 45 ft <sup>2</sup> (4.2 m <sup>2</sup> ) | 175 lbs (79 kg)           | BAYFLTR-622  |



## BAYSEPARATOR STORMWATER TREATMENT

| MODEL            | MANHOLE DIAMETER | MANHOLE DEPTH | MAXIMUM TREATMENT RATE | MAXIMUM HYDRAULIC RATE | PRODUCT CODE |
|------------------|------------------|---------------|------------------------|------------------------|--------------|
| BaySeparator ½K  | 48" (1219 mm)    | 6' (1.8 m)    | 1.1 cfs (31.4 l/sec)   | 8.5 cfs (241 l/sec)    | BAYSEP00500  |
| BaySeparator 1K  | 48" (1219 mm)    | 8' (2.4 m)    | 2.4 cfs (68 l/sec)     | 10 cfs (283 l/sec)     | BAYSEP01000  |
| BaySeparator 3K  | 60" (1524 mm)    | 8' (2.4 m)    | 7.8 cfs (221 l/sec)    | 30 cfs (850 l/sec)     | BAYSEP03000  |
| BaySeparator 5K  | 72" (1829 mm)    | 8' (2.4 m)    | 11.1 cfs (314 l/sec)   | 50 cfs (1416 l/sec)    | BAYSEP05000  |
| BaySeparator 10K | 120" (3048 mm)   | 8' (2.4 m)    | 21.8 cfs (617 l/sec)   | 100 cfs (2832 l/sec)   | BAYSEP10000  |
| BaySeparator XK  | Custom           | Custom        | Custom                 | Custom                 | BAYSYSXK     |

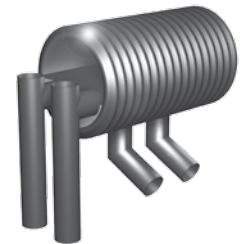

## BARRACUDA

| MODEL | MANHOLE DIAMETER | OK-110 (80% REMOVAL)   | NJCAT/NJDEP (50% TSS REMOVAL) |
|-------|------------------|------------------------|-------------------------------|
| S4    | 48" (1219 mm)    | 1.08 cfs (30.6 l/sec)  | 1.25 cfs (35.4 l/sec)         |
| S6    | 72" (1829 mm)    | 2.43 cfs (68.8 l/sec)  | 2.80 cfs (79.3 l/sec)         |
| S8    | 96" (2438 mm)    | 4.32 cfs (122.3 l/sec) | 5.00 cfs (141.6 l/sec)        |



# DURASLOT® SURFACE DRAINS

## DURASLOT SURFACE DRAINS

| PIPE DIAMETER | SLOT HEIGHT         | PRODUCT CODE |
|---------------|---------------------|--------------|
| 4" (100mm)    | 2.5" (64mm)         | 0420DS       |
| 4" (100mm)    | Variable            | 0490DS       |
| 6" (150mm)    | 2.5" (64mm)         | 0620DS       |
| 6" (150mm)    | 6" (150mm)          | 0660DS       |
| 6" (150mm)    | 6" (150mm) Open Top | 0660DSOT     |
| 6" (150mm)    | Variable            | 0690DS       |
| 6" (150mm)    | Variable Open Top   | 0690DSOT     |
| 8" (200mm)    | 2.5" (64mm)         | 0820DS       |
| 8" (200mm)    | 6" (150mm)          | 0860DS       |
| 8" (200mm)    | 6" (150mm) Open Top | 0860DSOT     |
| 8" (200mm)    | Variable            | 0890DS       |
| 8" (200mm)    | Variable Open Top   | 0890DSOT     |
| 10" (250mm)   | 2.5" (64mm)         | 1020DS       |
| 10" (250mm)   | 6" (150mm)          | 1060DS       |
| 10" (250mm)   | 6" (150mm) Open Top | 1060DSOT     |
| 10" (250mm)   | Variable            | 1090DS       |
| 10" (250mm)   | Variable Open Top   | 1090DSOT     |
| 12" (300mm)   | 2.5" (64mm)         | 1220DS       |
| 12" (300mm)   | 6" (150mm)          | 1260DS       |
| 12" (300mm)   | 6" (150mm) Open Top | 1260DSOT     |
| 12" (300mm)   | Variable            | 1290DS       |
| 12" (300mm)   | Variable Open Top   | 1290DSOT     |
| 15" (375mm)   | 6" (150mm)          | 1560DS       |
| 15" (375mm)   | 6" (150mm) Open Top | 1560DSOT     |
| 15" (375mm)   | Variable            | 1590DS       |
| 15" (375mm)   | Variable Open Top   | 1590DSOT     |
| 18" (450mm)   | 6" (150mm)          | 1860DS       |
| 18" (450mm)   | 6" (150mm) Open Top | 1860DSOT     |
| 18" (450mm)   | Variable            | 1890DS       |
| 18" (450mm)   | Variable Open Top   | 1890DSOT     |
| 24" (600mm)   | 6" (150mm)          | 2460DS       |
| 24" (600mm)   | 6" (150mm) Open Top | 2460DSOT     |
| 24" (600mm)   | Variable            | 2490DS       |
| 24" (600mm)   | Variable Open Top   | 2490DSOT     |
| 30" (750mm)   | 6" (150mm)          | 3060DS       |
| 30" (750mm)   | 6" (150mm) Open Top | 3060DSOT     |
| 30" (750mm)   | Variable            | 3090DS       |
| 30" (750mm)   | Variable Open Top   | 3090DSOT     |
| 36" (900mm)   | 6" (150mm)          | 3660DS       |
| 36" (900mm)   | Variable            | 3690DS       |
| 36" (900mm)   | Variable Open Top   | 3690DSOT     |

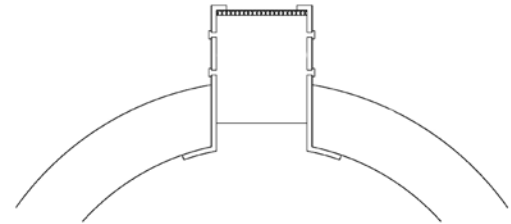
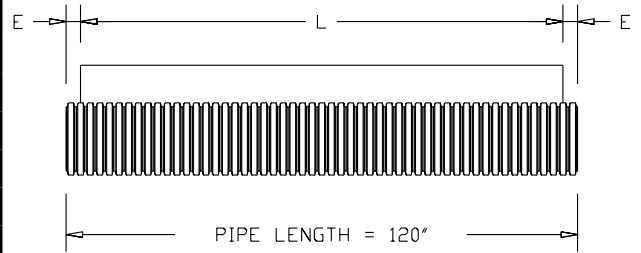

**DURASLOT WITH GRATE**

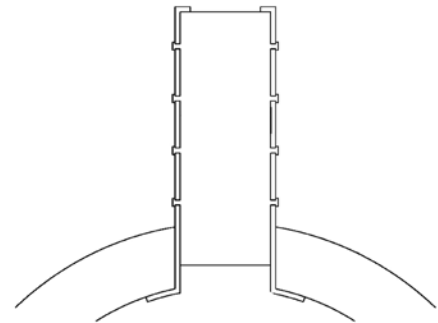

**OPEN TOP DURASLOT**



# DURASLOT SURFACE DRAINS FITTINGS

## COUPLERS

| PIPE DIAMETER | FITTING COMPATIBLE WITH PRODUCT CODE | PRODUCT CODE |
|---------------|--------------------------------------|--------------|
| 4" (100mm)    | 0420DS                               | 0421DS       |
| 4" (100mm)    | 0490DS                               | 0491DS       |
| 6" (150mm)    | 0660DS                               | 0626DS       |
| 6" (150mm)    | 0690DS                               | 0691DS       |
| 8" (200mm)    | 0860DS                               | 0826DS       |
| 8" (200mm)    | 0890DS                               | 0891DS       |
| 10" (250mm)   | 1060DS                               | 1026DS       |
| 10" (250mm)   | 1090DS                               | 1091DS       |
| 12" (300mm)   | 1260DS                               | 1226DS       |
| 12" (300mm)   | 1290DS                               | 1291DS       |
| 15" (375mm)   | 1560DS                               | 1526DS       |
| 15" (375mm)   | 1590DS                               | 1591DS       |
| 18" (450mm)   | 1860DS                               | 1826DS       |
| 18" (450mm)   | 1890DS                               | 1891DS       |
| 24" (600mm)   | 2460DS                               | 2426DS       |
| 24" (600mm)   | 2490DS                               | 2491DS       |
| 30" (750mm)   | 3060DS                               | 3026DS       |
| 30" (750mm)   | 3090DS                               | 3091DS       |
| 36" (900mm)   | 3660DS                               | 3626DS       |
| 36" (900mm)   | 3690DS                               | 3691DS       |



**4" COUPLER**

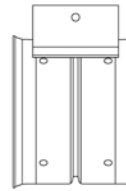

**6" COUPLER**

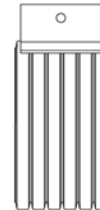

**8" & 10" COUPLER**

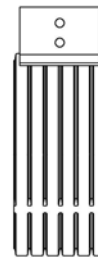

**12"-36" COUPLER**

# DURASLOT SURFACE DRAINS FITTINGS

## END CAPS

| PIPE DIAMETER | FITTING COMPATIBLE WITH PRODUCT CODE | PRODUCT CODE |
|---------------|--------------------------------------|--------------|
| 4" (100mm)    | 0420DS                               | 0433DS       |
| 4" (100mm)    | 0490DS                               | 0493DS       |
| 6" (150mm)    | 0660DS                               | 0633DS       |
| 6" (150mm)    | 0690DS                               | 0693DS       |
| 8" (200mm)    | 0860DS                               | 0833DS       |
| 8" (200mm)    | 0890DS                               | 0893DS       |
| 10" (250mm)   | 1060DS                               | 1033DS       |
| 10" (250mm)   | 1090DS                               | 1093DS       |
| 12" (300mm)   | 1260DS                               | 1233DS       |
| 12" (300mm)   | 1290DS                               | 1293DS       |
| 15" (375mm)   | 1560DS                               | 1533DS       |
| 15" (375mm)   | 1590DS                               | 1593DS       |
| 18" (450mm)   | 1860DS                               | 1833DS       |
| 18" (450mm)   | 1890DS                               | 1893DS       |
| 24" (600mm)   | 2460DS                               | 2433DS       |
| 24" (600mm)   | 2490DS                               | 2493DS       |
| 30" (750mm)   | 3060DS                               | 3033DS       |
| 30" (750mm)   | 3090DS                               | 3093DS       |
| 36" (900mm)   | 3660DS                               | 3633DS       |
| 36" (900mm)   | 3690DS                               | 3693DS       |

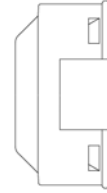

4" & 8" END CAP

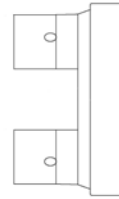

6" & 10" END CAP

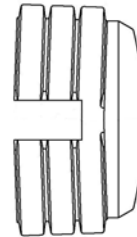

12"-36" END CAP

# DURASLOT SURFACE DRAINS FITTINGS

## ADAPTERS

| PIPE DIAMETER | FITTING COMPATIBLE WITH PRODUCT CODE | PRODUCT CODE |
|---------------|--------------------------------------|--------------|
| 4" (100mm)    | 0420DS                               | 0462DS       |
| 4" (100mm)    | 0490DS                               | 0496DS       |
| 6" (150mm)    | 0660DS                               | 0662DS       |
| 6" (150mm)    | 0690DS                               | 0696DS       |
| 8" (200mm)    | 0860DS                               | 0862DS       |
| 8" (200mm)    | 0890DS                               | 0896DS       |
| 10" (250mm)   | 1060DS                               | 1062DS       |
| 10" (250mm)   | 1090DS                               | 1096DS       |
| 12" (300mm)   | 1260DS                               | 1262DS       |
| 12" (300mm)   | 1290DS                               | 1296DS       |
| 15" (375mm)   | 1560DS                               | 1562DS       |
| 15" (375mm)   | 1590DS                               | 1596DS       |
| 18" (450mm)   | 1860DS                               | 1862DS       |
| 18" (450mm)   | 1890DS                               | 1896DS       |
| 24" (600mm)   | 2460DS                               | 2462DS       |
| 24" (600mm)   | 2490DS                               | 2496DS       |
| 30" (750mm)   | 3060DS                               | 3062DS       |
| 30" (750mm)   | 3090DS                               | 3096DS       |
| 36" (900mm)   | 3660DS                               | 3662DS       |
| 36" (900mm)   | 3690DS                               | 3696DS       |



**4" ADAPTER**

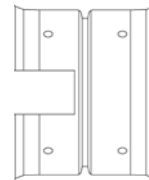

**6"-10" ADAPTER**

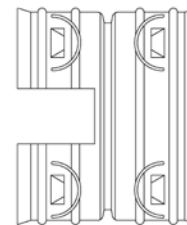

**12"-24" ADAPTER**

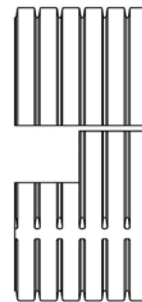

**30"-36" ADAPTER**

# ADVANEDGE® PIPE

## 12" AND 18" ADVANEDGE PIPE

| DIAMETER    | LENGTH         | DESCRIPTION                  | PRODUCT CODE |
|-------------|----------------|------------------------------|--------------|
| 12" (300mm) | 100' (30.5m)   | No Fabric                    | 04900100     |
|             | 100' (30.5m)   | 3.5 oz. Spunbond             | 04910100     |
|             | 100' (30.5m)   | 4.0 oz. Spunbond             | 04930100     |
|             | 400' (121.9m)  | 4.0 oz. Spunbond             | 04930400     |
|             | 112' (34.1m)   | 4.0 oz. Spunbond             | 04930112     |
|             | 100' (30.5m)   | Knitted Polyester Sock       | 04940100     |
|             | 100' (30.5m)   | 4.0 oz. Amoco Fabric (Grey)  | 04950100     |
| 18" (450mm) | 100' (30.5m)   | No Fabric                    | 06900100     |
|             | 100' (30.5m)   | 4.0 oz. Fabric               | 06930100     |
|             | 1600' (487.7m) | 4.0 oz. Fabric               | 06931600     |
|             | 100' (30.5m)   | 4.0 oz. Needleponched Fabric | 06950100     |



# ADVANEDGE FITTINGS

## ADVANEDGE FITTINGS

| PIPE SIZE                   | FITTING                              | PRODUCT CODE |
|-----------------------------|--------------------------------------|--------------|
| 12" (300mm)                 | Snap End Cap                         | 1432AA       |
| 18" (450mm)                 |                                      | 1632AA       |
| 12" (300mm)                 | External Split Coupler               | 1411AA       |
| 18" (450mm)                 |                                      | 1611AA       |
| 12" (300mm)                 | Wye                                  | 1480AA       |
| 12" (300mm) and 18" (450mm) | Coupling Pin (2/pk)                  | 0840MB       |
| 12" (300mm)                 | End Outlet                           | 1472AA       |
| 18" (450mm)                 |                                      | 1672AA       |
| 12" (300mm)                 | Side Outlet                          | 1471AA       |
| 18" (450mm)                 |                                      | 1671AA       |
| 4" (100mm)                  | 12" (300mm) Flat Outlet              | 1432AN       |
| 12" (300mm)                 | Fabricated Tee                       | 1460AN       |
| 18" (450mm)                 |                                      | 1660AN       |
| 12" (300mm)                 | Fabricated Tee (Horizontal)          | 1460ANH      |
| 18" (450mm)                 |                                      | 1660ANH      |
| 12" (300mm)                 | Fabricated Tee with Side Outlet      | 1464ANH      |
| 12" (300mm)                 | Fabricated Tee with Perf Side Outlet | 1464ANH81    |
| 12" (300mm)                 | Fabricated Cross Tee (Horizontal)    | 1436ANH      |
| 12" (300mm)                 | Fabricated Wye                       | 1480AN       |
| 18" (450mm)                 |                                      | 1680AN       |
| 12" (300mm)                 | Fabricated Wye (Horizontal)          | 1480ANH      |
| 18" (450mm)                 |                                      | 1680ANH      |
| 12" (300mm)                 | Fabricated Cross Wye                 | 1438ANH      |

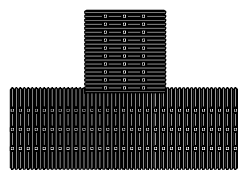
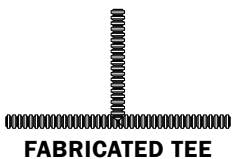
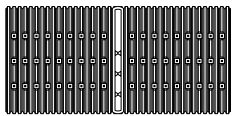
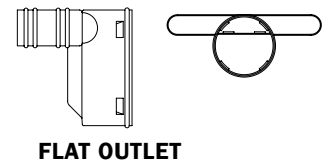
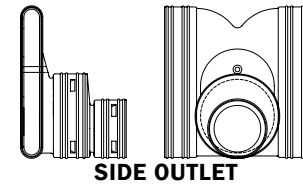
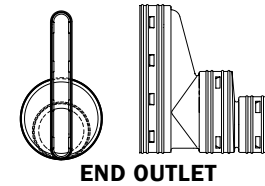
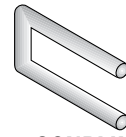
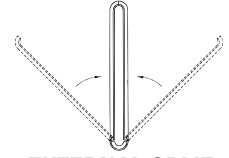
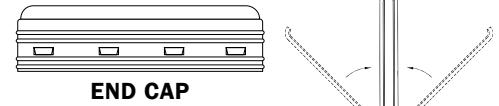

FABRICATED TEE (HORIZONTAL)

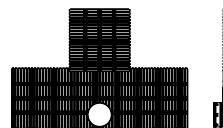

FABRICATED TEE WITH SIDE OUTLET

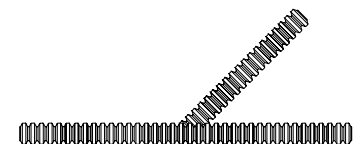

WYE

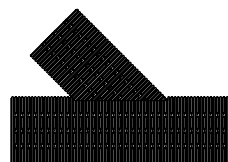
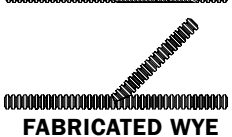
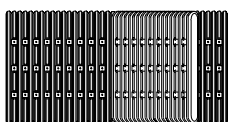

FABRICATED WYE (HORIZONTAL)

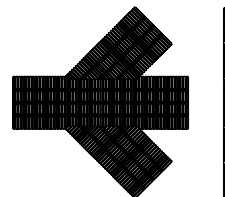

FABRICATED CROSS WYE

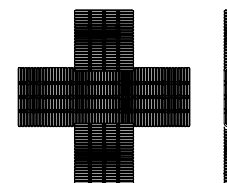

FABRICATED CROSS TEE

# ARC™ CHAMBERS & ACCESSORIES

## ARC CHAMBERS

| TYPE     | LOAD RATING | NOMINAL DIMENSIONS (L x W x H)             | CAPACITY                                    | PRODUCT CODE |
|----------|-------------|--|---|--------------|
| Arc 18   | H-10        | 67" x 16" x 12" (1702mm x 406mm x 300mm)   | 3.42 ft. <sup>3</sup> (0.10m <sup>3</sup> ) | 1812BD       |
| Arc 24   | H-10        | 67" x 22.5" x 12" (1702mm x 572mm x 300mm) | 5.02 ft. <sup>3</sup> (0.14m <sup>3</sup> ) | 2412BD       |
| Arc 36   | H-10        | 63" x 34.5" x 13" (1600mm x 876mm x 330mm) | 8 ft. <sup>3</sup> (0.23m <sup>3</sup> )    | 3613BD2      |
| Arc 36HC | H-10        | 63"x 34.5" x 16" (1600mm x 876mm x 400mm)  | 10.7 ft. <sup>3</sup> (0.30m <sup>3</sup> ) | 3616BD2      |
| Arc 36LP | H-10        | 63" x 34" x 8" (1600mm x 864mm x 200mm)    | 5.84 ft. <sup>3</sup> (0.17m <sup>3</sup> ) | 3608BD       |



ARC 18



ARC 24



ARC 36



ARC 36HC



ARC 36LP

## ARC ACCESSORIES

| TYPE                       | PRODUCT CODE |
|----------------------------|--------------|
| Arc 18 Endcap              | 1802BD       |
| Arc 24 Endcap              | 2402BD       |
| Arc 36 Endcap              | 3603BD2      |
| Arc 36HC Endcap            | 3606BD3      |
| Arc 36LP Endcap            | 3624LPEC     |
| Arc 24 Side Port Coupler   | 2403BD       |
| Arc 36 Side Port Coupler   | 3604BD       |
| Arc 36HC Side Port Coupler | 3607BD       |
| Endcap Splash Plate        | 0068         |



END CAP



SIDE PORT COUPLER

# BIODIFFUSER® & ACCESSORIES

## BIODIFFUSER CHAMBERS

| TYPE                    | LOAD RATING | NOMINAL DIMENSIONS (L x W x H)           | CAPACITY                           | PRODUCT CODE |
|-------------------------|-------------|--|------------------------------------|--------------|
| 15" (375mm) Narrow      | H-10        | 87" x 15" x 12" (2210mm x 375mm x 300mm) | 5.0 cu. ft. (0.14m <sup>3</sup> )  | 1500BD       |
| 22" (560mm) Narrow      | H-10        | 87" x 22" x 12" (2210mm x 560mm x 300mm) | 8.5 cu. ft. (0.24m <sup>3</sup> )  | 2200BD       |
| 11" (280mm) Standard    | H-10        | 76" x 34" x 11" (1930mm x 863mm x 280mm) | 9.2 cu. ft. (0.26m <sup>3</sup> )  | 1100BD       |
| 16" (400mm) Hi Capacity | H-10        | 76" x 34" x 16" (1930mm x 863mm x 400mm) | 13.6 cu. ft. (0.39m <sup>3</sup> ) | 1600BD       |
| 16" (400mm) Hi Capacity | H-20        | 76" x 34" x 16" (1930mm x 863mm x 400mm) | 13.6 cu. ft. (0.39m <sup>3</sup> ) | 1620BD       |

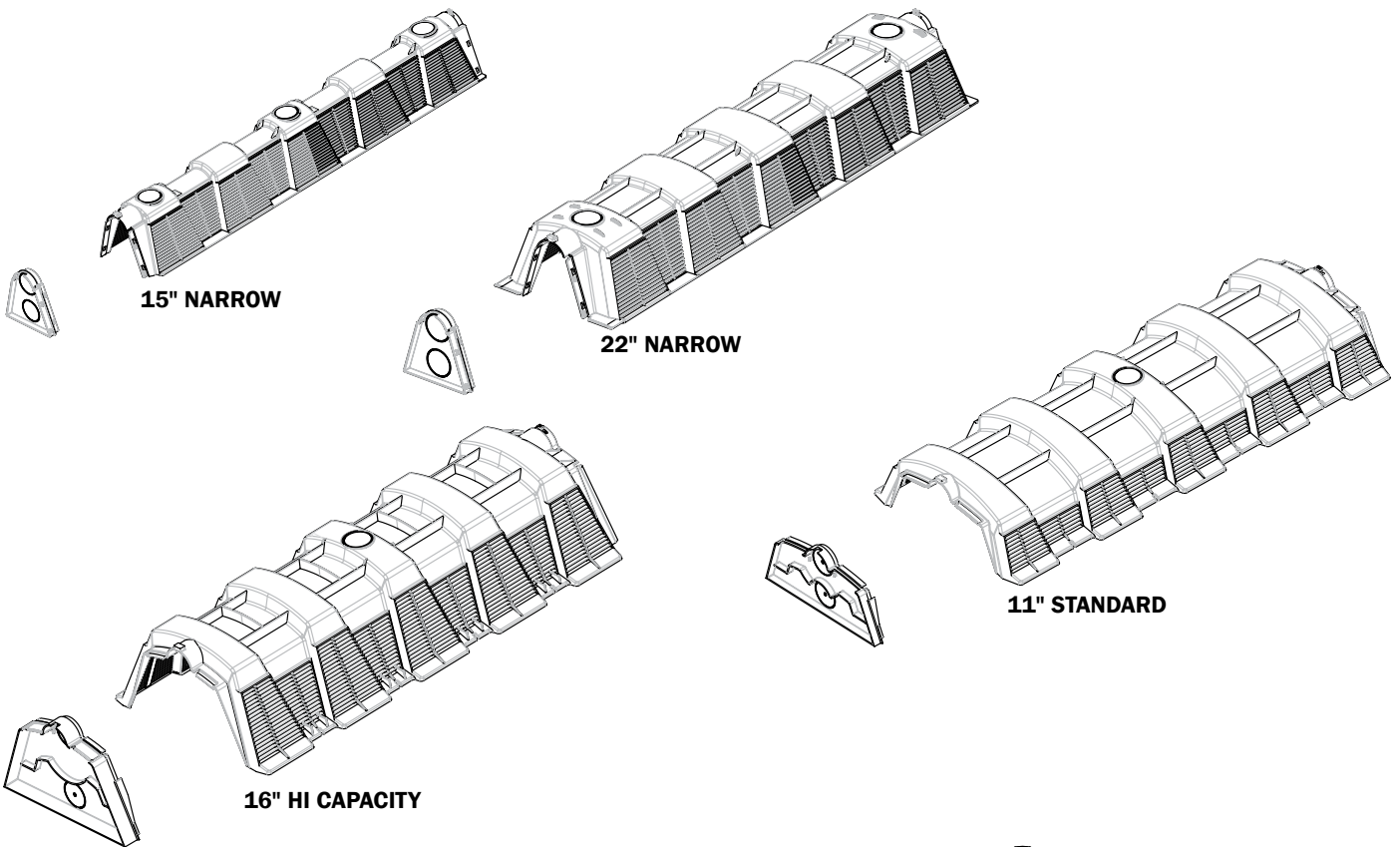

## BIODIFFUSER ACCESSORIES

| TYPE                             | PRODUCT CODE |
|----------------------------------|--------------|
| 11" (280mm) Endcap               | 1101BD       |
| 11" (280mm) Angle Section 0°-22° | 1122BD       |
| 16" (400mm) Endcap               | 1601BD       |
| 16" (400mm) Angle Section 0°-22° | 1622BD       |
| 15" (375mm) Endcap               | 1501BD       |
| 15" (375mm) Angle Section 0°-22° | 1522BD       |

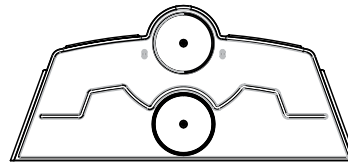

11" STANDARD ENDCAP

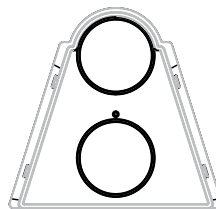

15" AND 22" NARROW ENDCAP

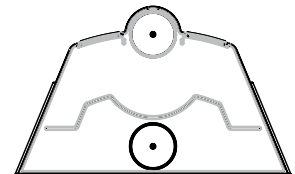

16" HI CAPACITY ENDCAP

# SEPTIC STACK™ SYSTEMS

## SEPTIC STACK SYSTEM

| DESCRIPTION                                      | NOMINAL LENGTH | PRODUCT CODE |
|--|----------------|--------------|
| 4" (100 mm) Perforated 9 Pipe at 10' (3 m) each  | 10' (3 m)      | 04710090     |
| 4" (100 mm) Perforated 11 Pipe at 10' (3 m) each | 10' (3 m)      | 04710110     |
| 4" (100 mm) Perforated 13 Pipe at 10' (3 m) each | 10' (3 m)      | 04710130     |
| 3611 System of 4" (100 mm) Perforated Pipe       | 10' (3 m)      | 04710110     |
| 3613 System of 4" (100 mm) Perforated Pipe       | 10' (3 m)      | 04710130     |

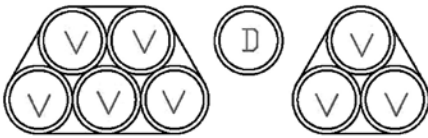

9 PIPE SEPTIC STACK

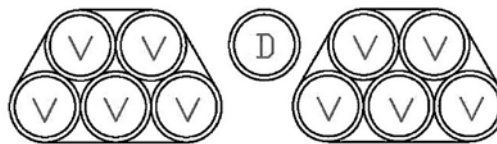

11 PIPE SEPTIC STACK

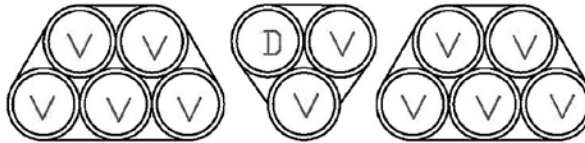

13 PIPE SEPTIC STACK

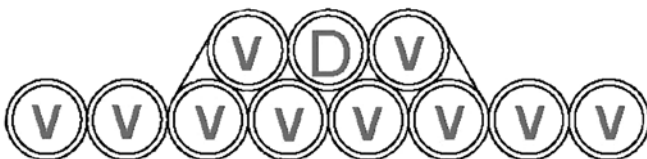

3611 SYSTEM

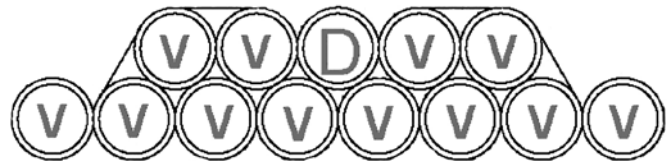

3613 SYSTEM



# WASTE WATER ACCESSORIES

## WASTE WATER ACCESSORIES

| DESCRIPTION   | PRODUCT CODE |
|---|--------------|
|  Bull Run Valve with 24" (600mm) Key | 4182FG       |
| Multi-purpose Regular Distribution Box  | 1369AB       |
| Multi-purpose Hillside Distribution Box   | 1370AB       |
| Regular Distribution Box Plug   | 1379AB       |
| Hillside Distribution Box Plug  | 1380AB       |
| Lid Kit for Sewage Ejector Sump and Radon Vented Sump   | 1530ADLX     |
| 18" x 30" Sewage Ejector Sump with PVC Hub  | 1530ADE      |



**BULL RUN VALVE**

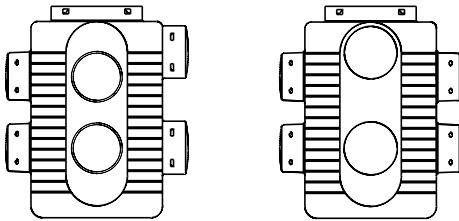

**MULTI-PURPOSE DISTRIBUTION BOX HILLSIDE**

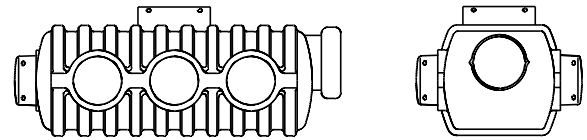

**MULTI-PURPOSE DISTRIBUTION BOX REGULAR**

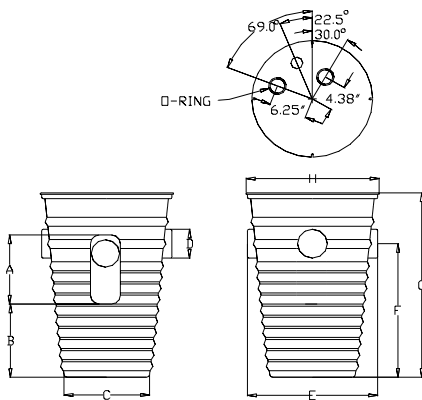

**SEWAGE EJECTOR SUMP AND LID**

## VENTED ELLS & BAFFLES

| DESCRIPTION                                 | PRODUCT CODE |
|---|--------------|
| 4" (100mm) Vented Ells                      | 0497AA       |
| 4" (100mm) Vented Ell                       | 0497AAFL*    |
| 4" (100mm) Vented Baffle,<br>3" (75mm) Spur | 0493AA       |

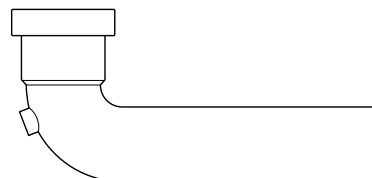

**VENTED ELL**

\*LIMITED GEOGRAPHIC AVAILABILITY.

# FOUNDATION DRAINAGE & ACCESSORIES

## FOUNDATION DRAINAGE PRODUCTS

| DESCRIPTION   | DIMENSIONS                                | PRODUCT CODE |
|---|---|--------------|
| 14 gal. (53L) Sump Liner  | 18" diameter x 24" height (450mm x 600mm) | 1524ADH      |
| 19 gal. (72L) Sump Liner  | 18" diameter x 30" height (450mm x 750mm) | 1530ADH      |
| 14 gal. (53L) Sump Liner  | 18" diameter x 24" height (450mm x 600mm) | 1524ADL      |
| 19 gal. (72L) Sump Liner  | 18" diameter x 30" height (450mm x 750mm) | 1530ADL      |
| Standard, Non-Locking Sump Lid                                    | 18" diameter (450mm)                      | 1536AD**     |
| Solid, Non-Locking Sump Lid                                       | 18" diameter (450mm)                      | 1537AD**     |
| Solid, Locking Sump Lid   | 18" diameter (450mm)                      | 1537ADL**    |
| Notched, Locking Sump Lid   | 18" diameter (450mm)                      | 1537ADNL**   |
| Radon Dual Purpose Vented Liner                                   | 20" diameter x 24" height (500mm x 600mm) | 1524ADR      |
| Sewage Ejector Sump Liner   | 20" diameter x 30" height (500mm x 750mm) | 1530ADE      |
| Non-Locking Lid Kit for Sewage Ejector Sump and Radon Vented Sump | 20" diameter (500mm)                      | 1530ADLX*    |

\*\*For use with ADS 1524ADL and 1530ADL.

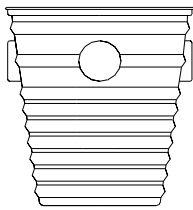

SUMP WELL

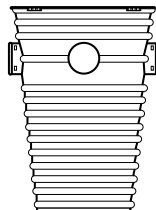

SUMP WELL

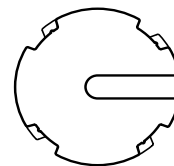

NOTCHED, LOCKING SUMP LID



STANDARD, NON-LOCKING SUMP LID

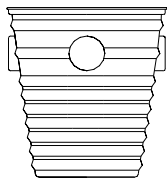

RADON SUMP WELL

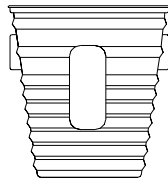

SEWAGE EJECTOR SUMP WELL



SOLID, NON-LOCKING SUMP LID

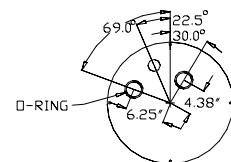

NON-LOCKING LID KIT FOR SEWAGE EJECTOR & RADON SUMP

## LAYOUT FLAGS, BLACK TAPE & VENT TUBE SEALING KITS



| DESCRIPTION                     | AVAIL. LENGTHS       | PRODUCT CODE   |
|---------------------------------|----------------------|----------------|
| Layout Flags                    | —                    | MR F00 00 0000 |
| 2" (50mm) Black Tape            | 100 ft. (30.5m) roll | 1137KA         |
| ½" (12.5mm) Black Filament Tape | 100 ft. (30.5m) roll | 1147KA         |
| Vent Tube Kit #1                | —                    | VENT-TUBE-KIT1 |
| Vent Tube Kit #2                | —                    | VENT-TUBE-KIT2 |

# METER PITS & WATERSTOP GASKETS

## METER PITS\*

| I.D. x LENGTH                            | PRODUCT CODE |
|--|--------------|
| 18" x 24" (450mm x 600mm)                | 1805ACH      |
| 18" x 30" (450mm x 750mm)                | 1805AAH      |
| 18" x 36" (450mm x 900mm)                | 1805ABH      |
| 18" x 42" (450mm x 1050mm)               | 1805ADH      |
| 18" x 48" (450mm x 1200mm)               | 1805AEH      |
| 21" x 24" (525mm x 600mm)                | 2105ACH      |
| 21" x 30" (525mm x 750mm)                | 2105AAH      |
| 21" x 36" (525mm x 900mm)                | 2105ABH      |
| 21" x 48" (525mm x 1200mm)               | 2105AEH      |
| 24" x 24" (600mm x 600mm)                | 2405ACH      |
| 24" x 30" (600mm x 750mm)                | 2405AAH      |
| 24" x 36" (600mm x 900mm)                | 2405ABH      |
| 24" x 42" (600mm x 1050mm)               | 2405ADH      |
| 24" x 48" (600mm x 1200mm)               | 2405AEH      |
| 18" x 12' (450mm x 3.5m) (UNCUT SECTION) | 18050012H    |
| 21" x 12' (525mm x 3.5m) (UNCUT SECTION) | 21050012H    |
| 24" x 12' (600mm x 3.5m) (UNCUT SECTION) | 24050012H    |

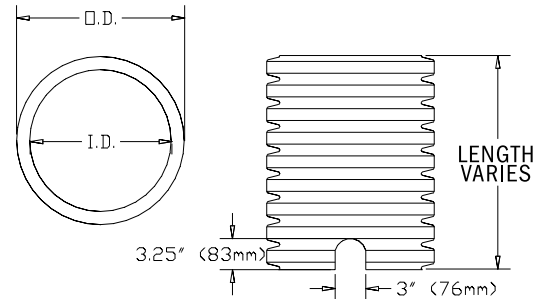

METER PITS

\*ALL METER PITS ARE WHITE AND NOTCHED.  
UNCUT SECTIONS DO NOT HAVE NOTCHES.

## WATERSTOP GASKETS

| PIPE SIZE     | RECOMMENDED MINIMUM HOLE DIAMETER | MINIMUM DISTANCE PIPE INVERT TO STRUCTURE INVERT | PRODUCT CODE |
|---------------|-----------------------------------|--|--------------|
| 12" (300mm)   | 19.50" (495mm)                    | 3.7" (94mm)                                      | 1202PS       |
| 15" (375mm)   | 23.00" (584mm)                    | 4.0" (102mm)                                     | 1502PS       |
| 18" (450mm)   | 26.50" (673mm)                    | 4.2" (107mm)                                     | 1802PS       |
| 24" (600mm)   | 33.25" (845mm)                    | 4.5" (114mm)                                     | 2402PS       |
| 30" (750mm)   | 40.50" (1029mm)                   | 5.2" (132mm)                                     | 3002PS       |
| 36" (900mm)   | 47.00" (1194mm)                   | 5.5" (140mm)                                     | 3602PS       |
| 42" (1050mm)  | 53.00" (1346mm)                   | 5.75" (146mm)                                    | 4202PS       |
| 48" (1200mm)  | 59.00" (1499mm)                   | 5.75" (146mm)                                    | 4802PS       |
| *54" (1350mm) | 65.00" (1651mm)                   | 6.4" (163mm)                                     | 5402PS       |
| 60" (1500mm)  | 72.00" (1829mm)                   | 6.4" (163mm)                                     | 6002PS       |

\*Limited Geographical Availability

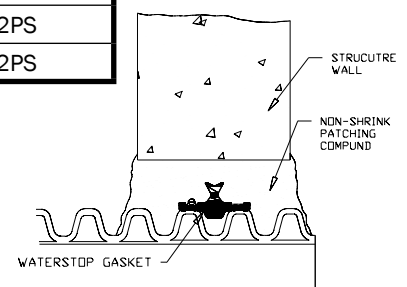

\*LIMITED GEOGRAPHIC AVAILABILITY.

# GEOSYNTHETICS

## NONWOVEN

### LIGHTWEIGHT – NONWOVEN



| WEIGHT          | W X L                        | SY/ROLL                   | PRODUCT CODE |
|-----------------|------------------------------|---------------------------|--------------|
| 3 oz. (85 g)    | 12.5' x 360' (3.8m x 109.7m) | 500 (418 m <sup>2</sup> ) | 0311TG       |
| 3 oz. (85 g)    | 15' x 360' (4.6m x 109.7m)   | 600 (502 m <sup>2</sup> ) | 0311TS       |
| 3.5 oz. (99 g)  | 12.5' x 360' (3.8m x 109.7m) | 500 (418 m <sup>2</sup> ) | 0351TG       |
| 3.5 oz. (99 g)  | 15' x 360' (4.6m x 109.7m)   | 600 (502 m <sup>2</sup> ) | 0351TS       |
| 4.0 oz. (113 g) | 12.5' x 360' (3.8m x 109.7m) | 500 (418 m <sup>2</sup> ) | 0401TG       |
| 4.0 oz. (113 g) | 15' x 360' (4.6m x 109.7m)   | 600 (502 m <sup>2</sup> ) | 0401TS       |
| 4.5 oz. (128 g) | 12.5' x 360' (3.8m x 109.7m) | 500 (418 m <sup>2</sup> ) | 0451TG       |
| 4.5 oz. (128 g) | 15' x 360' (4.6m x 109.7m)   | 600 (502 m <sup>2</sup> ) | 0451TS       |

### MEDIUM WEIGHT – NONWOVEN



| WEIGHT        | W X L                        | SY/ROLL                   | PRODUCT CODE |
|---------------|------------------------------|---------------------------|--------------|
| 6 oz. (170 g) | 12.5' x 360' (3.8m x 109.7m) | 500 (418 m <sup>2</sup> ) | 0601TG       |
| 6 oz. (170 g) | 15' x 300' (4.6m x 91.4m)    | 500 (418 m <sup>2</sup> ) | 0601TS       |
| 7 oz. (198 g) | 6' x 360' (1.8m x 109.7m)    | 240 (201 m <sup>2</sup> ) | 0701TE       |
| 7 oz. (198 g) | 12.5' x 360' (3.8m x 109.7m) | 500 (418 m <sup>2</sup> ) | 0701TG       |
| 7 oz. (198 g) | 15' x 300' (4.6m x 91.4m)    | 500 (418 m <sup>2</sup> ) | 0701TS       |
| 8 oz. (227 g) | 12.5' x 360' (3.8m x 109.7m) | 500 (418 m <sup>2</sup> ) | 0801TG       |
| 8 oz. (227 g) | 15' x 300' (4.6m x 91.4m)    | 500 (418 m <sup>2</sup> ) | 0801TS       |

### HEAVY WEIGHT – NONWOVEN



| WEIGHT         | W X L                     | SY/ROLL                   | PRODUCT CODE |
|----------------|---------------------------|---------------------------|--------------|
| 10 oz. (284 g) | 15' x 300' (4.6m x 91.4m) | 500 (418 m <sup>2</sup> ) | 1001TS       |
| 12 oz. (340 g) | 15' x 300' (4.6m x 91.4m) | 500 (418 m <sup>2</sup> ) | 1201TS       |
| 16 oz. (454 g) | 15' x 300' (4.6m x 91.4m) | 500 (418 m <sup>2</sup> ) | 1601TS       |

\*ADDITIONAL WIDTHS AVAILABLE 2' (0.6 m), 3' (0.9 m), 4' (1.2 m), 7.5' (2.3 m).

# GEOSYNTHETICS

## WOVEN & GEOGRIDS

### WOVEN FABRIC SYR STABILIZATION – WOVEN



| GRAB TENSILE | W X L                        | SY/ROLL                   | PRODUCT CODE |
|--------------|------------------------------|---------------------------|--------------|
| 200          | 12.5' x 432' (3.8m x 131.7m) | 600 (502 m <sup>2</sup> ) | 200WTK       |
| 200          | 15' x 360' (4.6m x 109.7m)   | 600 (502 m <sup>2</sup> ) | 200WTS       |
| 200          | 17.5' x 309' (5.3m x 94.2m)  | 600 (502 m <sup>2</sup> ) | 200WTM       |
| 250          | 12.5' x 360' (3.8m x 109.7m) | 500 (418 m <sup>2</sup> ) | 250WTK       |
| 250          | 17.5' x 258' (5.3m x 78.6m)  | 500 (418 m <sup>2</sup> ) | 250WTM       |
| 270          | 12.5' x 360' (3.8m x 109.7m) | 500 (418 m <sup>2</sup> ) | 270WTK       |
| 270          | 15' x 300' (4.6m x 91.4m)    | 500 (418 m <sup>2</sup> ) | 270WTS       |
| 270          | 17.5' x 258' (5.3m x 78.6m)  | 500 (418 m <sup>2</sup> ) | 270WTM       |
| 315          | 12.5' x 360' (3.8m x 109.7m) | 500 (418 m <sup>2</sup> ) | 315WTK       |
| 315          | 15' x 300' (4.6m x 91.4m)    | 500 (418 m <sup>2</sup> ) | 315WTS       |
| 315          | 17.5' x 258' (5.3m x 78.6m)  | 500 (418 m <sup>2</sup> ) | 315WTM       |
| 465          | 12.5' x 360' (3.8m x 109.7m) | 500 (418 m <sup>2</sup> ) | 315WTK       |

### WOVEN FABRIC SYR MONOFILAMENT – WOVEN



| W X L                       | SY/ROLL                   | PRODUCT CODE |
|-----------------------------|---------------------------|--------------|
| 12' x 300' (3.6m x 91.4m)   | 400 (334 m <sup>2</sup> ) | 104FWF       |
| 15' x 300' (4.6m x 91.4m)   | 500 (418 m <sup>2</sup> ) | 2x2HFTS      |
| 12.5' x 300' (3.8m x 91.4m) | 417 (348 m <sup>2</sup> ) | 111FTK       |
| 12' x 300' (3.6m x 91.4m)   | 400 (334 m <sup>2</sup> ) | 117FTK       |

### WOVEN FABRIC SYR MEDIUM STRENGTH – WOVEN



| W X L                       | SY/ROLL                   | PRODUCT CODE |
|-----------------------------|---------------------------|--------------|
| 15' x 300' (4.6m x 91.4m)   | 500 (418 m <sup>2</sup> ) | 270HPTS      |
| 17' x 258' (5.3m x 78.6m)   | 500 (418 m <sup>2</sup> ) | 270HPTM      |
| 17.5' x 257' (5.3m x 78.3m) | 500 (418 m <sup>2</sup> ) | 370HPTS      |
| 15' x 300' (4.6m x 91.4m)   | 500 (418 m <sup>2</sup> ) | 570HPTS      |

### BIAXIAL GEOGRIDS



| W X L                         | SY/ROLL                   | PRODUCT CODE |
|-------------------------------|---------------------------|--------------|
| 13.1' x 246' (4.0 m x 75.0 m) | 359 (300 m <sup>2</sup> ) | BX114GG      |
| 13.1' x 164' (4.0 m x 50.0 m) | 239 (200m <sup>2</sup> )  | BX124GG      |
| 13.1' x 164' (4.0m x 50.0m)   | 239 (200m <sup>2</sup> )  | BX134GG      |
| 13.1' x 164' (4.0m x 50.0m)   | 239 (200m <sup>2</sup> )  | BX154GG      |
| 13.1' x 246' (4.0m x 75.0m)   | 359 (300 m <sup>2</sup> ) | BX414GG      |
| 13.1' x 328' (4.0m x 100m)    | 478 (400 m <sup>2</sup> ) | BX2525GG     |
| 13.1' x 328' (4.0m x 100m)    | 478 (400 m <sup>2</sup> ) | BX224GG      |
| 13.1' x 164' (4.0m x 50m)     | 239 (200 m <sup>2</sup> ) | BX40404GG    |

### UNIAXIAL GEOGRIDS



| W X L                      | SY/ROLL                   | PRODUCT CODE |
|----------------------------|---------------------------|--------------|
| 3.28' x 328' (1 m x 100 m) | 120 (100 m <sup>2</sup> ) | UX11SGG      |
| 3.28' x 246' (1 m x 75 m)  | 90 (75m <sup>2</sup> )    | UX14SGG      |
| 3.28' x 164' (1 m x 50 m)  | 60 (50m <sup>2</sup> )    | UX15SGG      |
| 3.28' x 99' (1 m x 30 m)   | 36 (30m <sup>2</sup> )    | UX16SGG      |
| 3.28' x 99' (1 m x 30 m)   | 36 (30m <sup>2</sup> )    | UX17SGG      |

### PAVING FABRIC



| W X L                        | SY/ROLL                   | PRODUCT CODE |
|------------------------------|---------------------------|--------------|
| 12.5' x 360' (3.8m x 109.7m) | 500 (418 m <sup>2</sup> ) | 4598TG       |
| 15' x 360' (4.6m x 109.7m)   | 600 (502 m <sup>2</sup> ) | 4598TS       |
| 12.5' x 360' (3.8m x 109.7m) | 500 (418 m <sup>2</sup> ) | 4599TG       |
| 15' x 360' (4.6m x 109.7m)   | 600 (502 m <sup>2</sup> ) | 4599TS       |

# GEOSYNTHETICS

## SEPTIC FABRIC

### SPUNBOND



| WEIGHT          | W X L                       | SY/ROLL                      | PRODUCT CODE |
|-----------------|-----------------------------|------------------------------|--------------|
| 1.5 oz. (43 g)  | 3' x 300' (.9m x 91.4m)     | 100 (84 m <sup>2</sup> )     | 3151TA       |
| 1.5 oz. (43 g)  | 4' x 300' (1.2m x 91.4m)    | 133.33 (111 m <sup>2</sup> ) | 3151TB       |
| 1.5 oz. (43 g)  | 6.3' x 300' (1.9m x 91.4m)  | 208.33 (174 m <sup>2</sup> ) | 3151TE       |
| 1.5 oz. (43 g)  | 12.6' x 300' (3.8m x 91.4m) | 420 (351 m <sup>2</sup> )    | 3151TG       |
| 2.0 oz. (57 g)  | 6.3' x 300' (1.9m x 91.4m)  | 208 (174 m <sup>2</sup> )    | 3201TE       |
| 2.0 oz. (57 g)  | 3' x 300' (.9m x 91.4m)     | 100 (84 m <sup>2</sup> )     | 3201TA       |
| 2.0 oz. (57 g)  | 4' x 300' (1.2m x 91.4m)    | 133.33 (111 m <sup>2</sup> ) | 3201TB       |
| 2.0 oz. (57 g)  | 12.6' x 300' (3.8m x 91.4m) | 420 (351 m <sup>2</sup> )    | 3201TG       |
| 3.0 oz. (85 g)  | 3' x 300' (.9m x 91.4m)     | 100 (84 m <sup>2</sup> )     | 3301TA       |
| 3.0 oz. (85 g)  | 4' x 300' (1.2m x 91.4m)    | 133.33 (111 m <sup>2</sup> ) | 3301TB       |
| 3.0 oz. (85 g)  | 6.3' x 300' (1.9m x 91.4m)  | 208.33 (174 m <sup>2</sup> ) | 3301TE       |
| 3.0 oz. (85 g)  | 9' x 300' (2.7m x 91.4m)    | 300 (247 m <sup>2</sup> )    | 3301TT       |
| 3.0 oz. (85 g)  | 12.6' x 300' (3.8m x 91.4m) | 420 (351 m <sup>2</sup> )    | 3301TG       |
| 4.0 oz. (113 g) | 12.6' x 300' (3.8m x 91.4m) | 420 (351 m <sup>2</sup> )    | 3401TG       |
| 4.0 oz. (113 g) | 15.6' x 300' (4.8m x 91.4m) | 520 (435 m <sup>2</sup> )    | 3401TH       |
| 6.0 oz. (170 g) | 3.8' x 300' (3.8m x 91m)    | 420 (351 m <sup>2</sup> )    | 3601TG       |
| 6.0 oz. (170 g) | 15.6 x 300' (4.8m x 91m)    | 520 (435 m <sup>2</sup> )    | 3601TH       |

### SEPTIC FABRIC



| WEIGHT          | W X L                      | PRODUCT CODE |
|-----------------|----------------------------|--------------|
| 0.45 oz. (13 g) | 2' x 300' (.6m x 91.4m)    | 2624RB       |
| 0.45 oz. (13 g) | 3' x 300' (.9m x 91.4m)    | 2636RB       |
| 0.45 oz. (13 g) | 2' x 1500' (.6m x 457.2m)  | 2724RB       |
| 0.45 oz. (13 g) | 3' x 1500' (.9m x 457.2m)  | 2736RB       |
| 0.45 oz. (13 g) | 4' x 1500' (1.2m x 457.2m) | 2748RB       |
| 0.45 oz. (13 g) | 5' x 1500' (1.5m x 457.2m) | 2760RB       |
| 0.45 oz. (13 g) | 6' x 1500' (1.8m x 457.2m) | 2772RB       |

### SEPTIC FABRIC (TX)



| WEIGHT         | W X L                      | PRODUCT CODE |
|----------------|----------------------------|--------------|
| 0.7 oz. (13 g) | 2' x 300' (.6m x 91.4m)    | 2824RB       |
| 0.7 oz. (13 g) | 3' x 300' (.9m x 91.4m)    | 2836RB       |
| 0.7 oz. (13 g) | 2' x 1500' (.6m x 457.2m)  | 2924RB       |
| 0.7 oz. (13 g) | 3' x 1500' (.9m x 457.2m)  | 2936RB       |
| 0.7 oz. (13 g) | 4' x 1500' (1.2m x 457.2m) | 2948RB       |
| 0.7 oz. (13 g) | 6' x 1500' (1.8m x 457.2m) | 2972RB       |

# GEOSYNTHETICS

## BLANKETS, MATS, SILT FENCES, FABRIC PINS

### EROSION CONTROL BLANKETS (ECB) - BIODEGRADABLE



| W X L                        | SY/ROLL                  | DESCRIPTION                  | PRODUCT CODE |
|------------------------------|--------------------------|------------------------------|--------------|
| 7.8' x 112.5' (2.4m x 34.3m) | 100 (84 m <sup>2</sup> ) | Single net straw             | OOS1TT       |
| 7.8' x 112.5' (2.4m x 34.3m) | 100 (84 m <sup>2</sup> ) | Double net straw             | OOS2TT       |
| 7.8' x 112.5' (2.4m x 34.3m) | 100 (84 m <sup>2</sup> ) | Coconut/Straw                | OCS2TT       |
| 7.8' x 112.5' (2.4m x 34.3m) | 100 (84 m <sup>2</sup> ) | 100% Coconut                 | OOC2TT       |
| 7.8' x 112.5' (2.4m x 34.3m) | 100 (84 m <sup>2</sup> ) | Single net straw all natural | OOS1AN       |
| 7.8' x 112.5' (2.4m x 34.3m) | 100 (84 m <sup>2</sup> ) | Double net straw all natural | OOS2AN       |
| 7.8' x 112.5' (2.4m x 34.3m) | 100 (84 m <sup>2</sup> ) | Coconut/Straw all natural    | OCS2AN       |
| 7.8' x 112.5' (2.4m x 34.3m) | 100 (84 m <sup>2</sup> ) | 100% Coconut all natural     | OOC2AN       |

### TURF REINFORCEMENT MAT (TRM) - PERMANENT



| SIZE                       | SY/ROLL                  | PRODUCT CODE |
|----------------------------|--------------------------|--------------|
| 7.5' x 120' (2.3m x 36.6m) | 100 (84 m <sup>2</sup> ) | PP58GTR      |
| 7.5' x 120' (2.3m x 36.6m) | 100 (84 m <sup>2</sup> ) | PP510GTR     |
| 7.5' x 120' (2.3m x 36.6m) | 100 (84 m <sup>2</sup> ) | PP512GTR     |

### HIGH PERFORMANCE TURF REINFORCEMENT MAT - PERMANENT



| SIZE                       | SY/ROLL                  | PRODUCT CODE |
|----------------------------|--------------------------|--------------|
| 8.5' x 109' (2.6m x 42.2m) | 100 (84 m <sup>2</sup> ) | PP5XGTR      |

### FABRIC PINS



| SIZE             | QUANTITY | PRODUCT CODE |
|------------------|----------|--------------|
| 6" (50mm) Staple | 1000/box | 3206TP       |
| 12" (300mm) Pin  | 100/box  | 3212TP       |
| 18" (457mm) Pin  | 100/box  | 3218TP       |

### SILT FENCE



| DESCRIPTION  | PRODUCT CODE |
|--|--------------|
| 2' x 100' (.6m x 30m) rolls with 11 hardwood stakes per roll                       | 3301WE       |
| 3' x 100' (.9m x 30m) rolls with 11 hardwood stakes per roll                       | 3302WE       |
| Premium Silt Fence - AASHTO 3' x 100' (.9m x 30m) with 17 hardwood stakes per roll | 3302WP       |

### OUTFLOW MAT



| SIZE                     | SY/ROLL                   | PRODUCT CODE |
|--------------------------|---------------------------|--------------|
| 12' x 75' (3.7m x 22.9m) | 100 (83.6m <sup>2</sup> ) | OFM100       |

ADS "Terms and Conditions of Sale" are available on the ADS website, [www.ads-pipe.com](http://www.ads-pipe.com).  
Advanced Drainage Systems, the ADS logo, the Green Stripe, ADS 3000 TripleWall®, N-12®, AdvanEDGE®, Grain Aire®, Septic Stack™, Duraslot®, LandMax®, SaniTite® HP, MEGA GREEN™, Channel-Flow®, Turf Flow®, Bend-A-Drain™, and ADS PolyFlex™ are registered trademarks of Advanced Drainage Systems, Inc. FLEXSTORIM® and CATCH-IT® are registered trademarks of Inlet & Pipe Protection, Inc. StormTech® is a registered trademark of StormTech, Inc. INSERTA TEE® is a registered trademark of Inserta Fittings, Inc. Nyloplast® and EnviroHood™ are registered trademarks of Nyloplast, Inc. Arc™ and Biodiffuser® are registered trademarks of ISI. Hickenbottom® is a registered trademark of Hickenbottom, Inc. BayFilter™ BaySeparator™ and Barracuda™ are registered trademarks of BaySaver Technologies® LLC. Mar Mac® is a registered trademark of Mar Mac Construction Products Co., Inc.  
© 2019 Advanced Drainage Systems, Inc. BRO #10524 04/19 MH



## Innovation in product, process and technology. *That's ADS.*

Beginning with single wall corrugated polyethylene pipe, ADS has continually introduced drainage products that have set the industry standard. Our commitment to being the best means that we continue to refine the structural design of our pipe and redefine the limits of its application in the structural design community.

Advanced Drainage Systems, Inc.  
4640 Trueman Blvd. Hilliard, OH 43026  
1-800-821-6710  
[www.ads-pipe.com](http://www.ads-pipe.com)

THE MOST **ADVANCED** NAME IN WATER MANAGEMENT SOLUTIONS™

