

Manifold Electronic Control System (MECS)

Infinity units can be manifolded together (up to 25) by connecting them in parallel to enable a greater hot water flow rate than is possible with a single unit. MECS is a totally integrated system unique to Rinnai that links each Infinity unit in the system and will turn on each unit as required.

The system is designed to ensure gas is not wasted and that an endless supply of hot water is always available.

How it works

A master and sub-communication PCB is installed in the first unit and other subsequent units have only the sub-communication PCB (slave cable) installed. The master communication PCB receives information about flow rates from the PCB of each unit and balances the load on each unit. Random selection of the units required to supply the flow demand means that all units share the workload evenly.

All information is transmitted via communication cables to the slave units. The master control also had an inbuilt fault detection system and will allocate a replacement unit should one fail.

MSB-C1, C2 and C3

This MECS system has the capability of joining up to 25 Infinity units and will replace the previous Rinnai REU-SA2M/2S and REU-SA3M/3S MECS systems.

Description

Part number	Instruction book	Description
REU-MSBM	MSB-C1	MESC master board for internal mounting inside Infinity to connect five units
REU-MSBMB	MSB-C1	MECS master board for external mounting to connect five units
REU-MSBC1	MSB-C1	Slave cable to connect one additional unit
REU-MSBC2	MSB-C2	Joiner cable to daisy chain two MECS master boards together (up to a maximum of five boards can be connected)
REU-MSBC3	MSB-C3	Slave cable as a spare part for the older REU-MSA2S MECS system

What to use where

Older MECS system	New installs substitute	Replacement spare part
REU-MSA2M	REU-MSBM	REUMSBM
REU-MSA2S	REU-MSBC1	REUMSBC3
REU-MSA3M	REU-MSBMB	REUMSBMB
REU-MSA3S	REU-SBC1	REUMSBC1

Decription	Master		Slave	Joiner
Location	Inside Infinity ¹	External box ²		
Part number	REU-MSBM	REU-MSBMB	REU-MSBC1	REU-MSBC2
No. of water heaters				
2	1	1	-	-
3	1	1	1	-
4	1	1	2	-
5	1	1	3	-
6	2	2	2	1
7	2	2	3	1
8	2	2	4	1
9	2	2	5	1
10	2	2	6	1
11	3	3	5	2
12	3	3	6	2
13	3	3	7	2
14	3	3	8	2
15	3	3	9	2
16	4	4	8	3
17	4	4	9	3
18	4	4	10	3
19	4	4	11	3
20	4	4	12	3
21	5	5	11	4
22	5	5	12	4
23	5	5	13	4
24	5	5	14	4
25	5	5	15	4

1 Refer Infinity model compatibility on next page

Infinity model compatibility

	Current model	Previous model
HD200	REU-VRM2632WC	-
HD200i	REU-VR2632FFU	REU-VM2632FFUG
HD250	REU-VR3237WC	REU-VM3237WC
HD250i		REU-VM3237FFUC
XR26i		REU-V2632FFUG
XR32		REU-V3237WG
HD250E	REU-K3237WC	
HD250Ei	REU-3237FFUC	

- 2 Can be used for all above models, and **MUST** be used for all HD200 (REU-VM2630WC), XR & VT domestic models³ and Efficiency24 (REU-K2430)
- 3 Reduced warranty applies to domestic models used in commercial applications



Manifold Electronic Control System Installation Instructions

MSB-M
MSB-C1

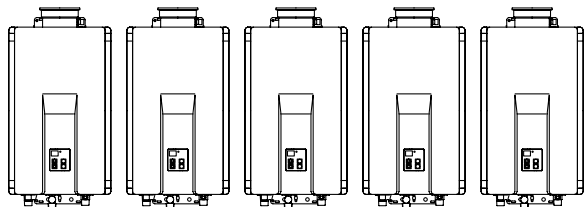

Note:

- Up to 5 water heaters can be connected together using the MSB-M and MSB-C1 kits.
- When over 5 water heaters are connected together, MSB-M units are connected using MSB-C2 kits.
- If multiple MSB-M are used, then at least three water heaters should be connected to each MSB-M.
Ex: With 7 water heaters, one MSB-M should control 4 water heaters and the other MSB-M should control 3 water heaters.
- United States & Canada: For use with Rinnai Tankless Water Heaters (except for models V53e, V53i and R63LSe which must use pressure activation valves, PVA).
- Please contact Rinnai if you have further questions on the applicable water heater models.

WARNING

Disconnect all water heaters from their power source before carrying out the following installation procedures.

NOTE: The front cover panels of each water heater must be removed prior to completing the following installation procedures.

Kit Components

MSB-M (Pack A) (For wiring Units 1 and 2)		MSB-C1 (Pack B) (For wiring Units 3, 4 and 5)	
Parts List		Parts List	
Part	Qty	Part	Qty
Control Board	1	Communication Cable B (9.8 ft, 3 m)	1
Communication Cable A (18 in, 450 mm)	1	Cable tie bracket	2
Communication Cable B (9.8 ft, 3 m)	1	Cable tie	2
Cable tie bracket	2	Instruction Sheet	1
Cable tie	2	Note: One MSB-C1 is required for each water heater (Units 3, 4, and 5)	
Instruction Sheet bracket	1		
Screw	2		

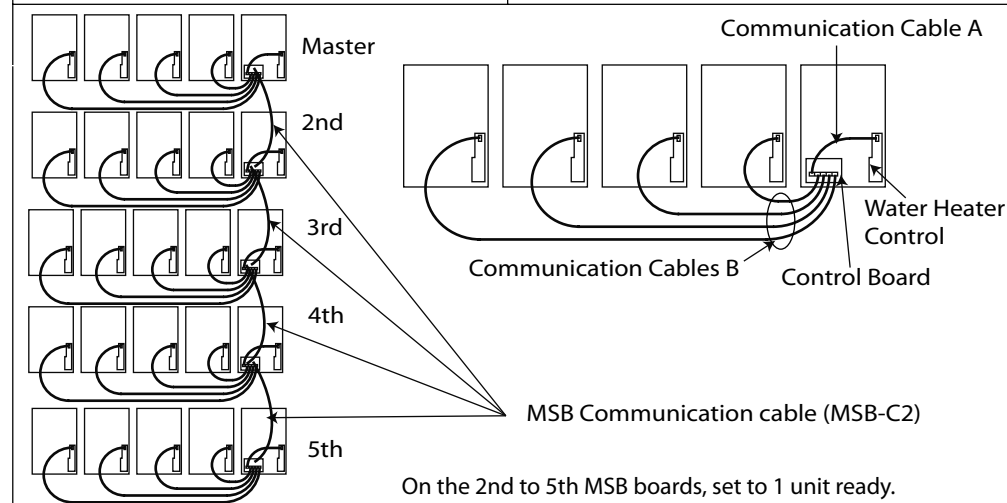
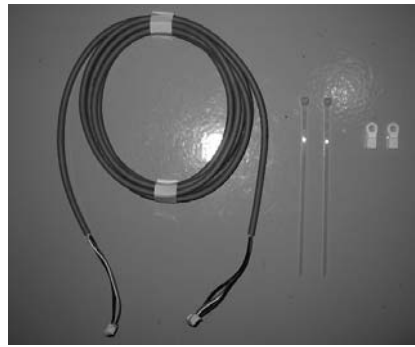

For Unit 1:

1) Remove the screw from the sheet metal reinforcement plate located at the bottom of the water heater cabinet, and then use it to secure the Control Board to the water heater cabinet.



If installing on a condensing water heater, refer to the additional instruction showing below.*

2) Connect the connector from Communication Cable A (18 inch, 450 mm cable) to socket No. 1 on Control Board.

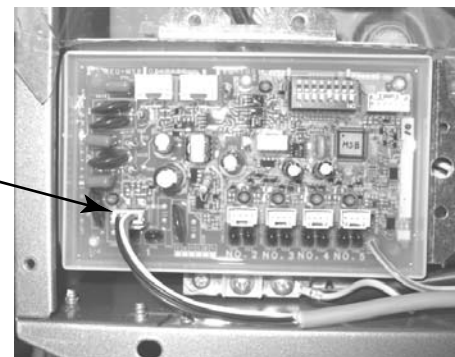

Ground wire of Communication Cable A

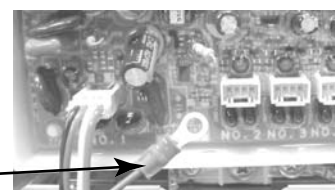

3) Connect the connector from Communication Cable A to the 4-pin socket located at the top of the water heater control board. Communication Cable A ground wire terminal should be grounded with the PC board ground wire.



Ground wire of Communication Cable A

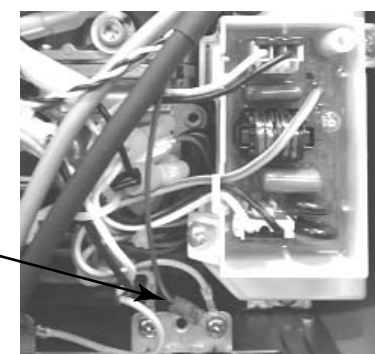

4) Attach the cable tie bracket to the bottom of the water heater cabinet using the existing screw. Loosely secure the cable tie through the bracket and around the communication cable. DO NOT TIGHTEN THE CABLE TIE AT THIS TIME - the Communication Cables B from the other water heaters must be secured by this cable tie.

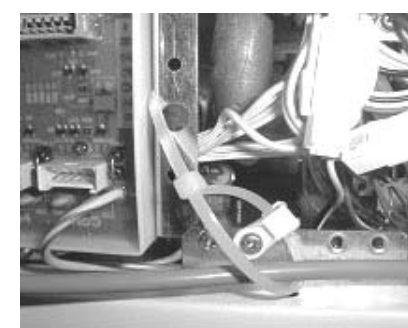

* These condensing water heaters require a bracket for the control board:

- RC98HPi (REU-KA3237FFUD)/RC98HPe (REU-KA3237WD)
- /RC80HPi (REU-KA2530FFUD)/RC80HPe (REU-KA2530WD)
- /REU-KM3237FFUD/REU-KM3237WD/ REU-KM2635FFUD
- /REU-KM2635WD

Attach the control board to this bracket with one screw in Step 1.

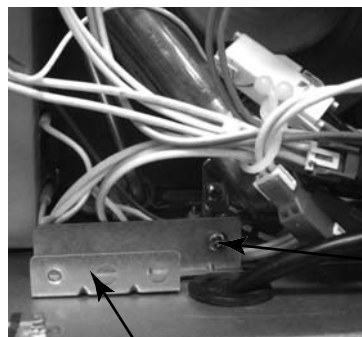

Install the bracket

Attach the control board

Install the bracket with one screw as shown above and continue with the rest of the installation.

For Units 2, 3, 4, and 5:

5) Run the 4-pin connector of Communication Cable B (9.8 ft, 3 m cable) up through the cable access in the bottom of Unit 1's cabinet.

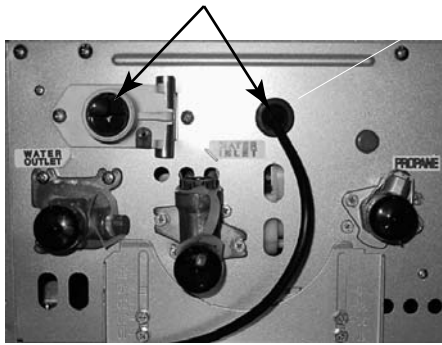

6) Connect the connector of the Communication Cable B to socket 2 on the Control Board. The Communication Cable B ground wire terminals should be grounded with the MSB ground wire and Communication Cable A ground wire terminal.



Ground wires of Communication Cable B

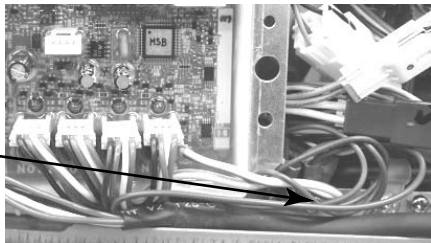

7) Run the other end of Communication Cable B through the cable access in the bottom of Unit 2's cabinet.

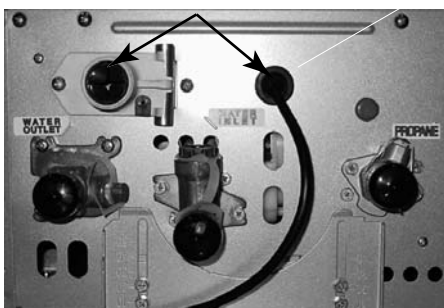

8) Connect the 4-pin connector from Communication Cable B to the 4-pin socket located at the top of the water heater control board of Unit 2. Communication Cable B ground wire terminal should be grounded with the PC board ground wire.

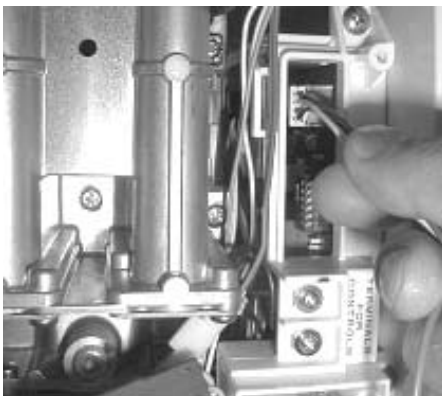

Ground wire of Communication Cable B

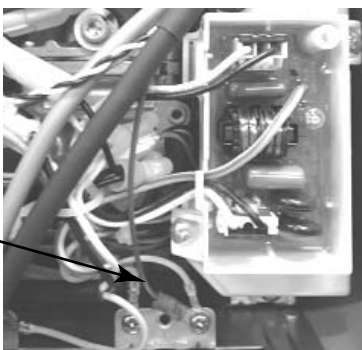

9) Attach the cable tie bracket to the bottom of the water heater cabinet using the existing screw. Pull all of the excess cable up into Unit 2's cabinet, and then secure it tightly to the bracket using the cable tie.



10) Repeat steps 5 to 9 for Units 3, 4, and 5, as applicable.

Note: Communication Cable B for Unit 3 plugs into socket 3, Unit 4 plugs into socket 4, etc.

11) After making all of the connections to the Control Board, tighten all of the cable ties used to secure the Communication Cables.



12) Place the front cover panels back on each of the water heaters using (4) screws.



13) Restore power to the water heaters.

System Operation

- The Control Board can electronically connect up to 25 water heaters.
- When multiple water heaters are operating, they will attempt to supply equal amounts of hot water.
- On initial water flow demand, from 1 to 3 units which can be determined by Dip SW setting of Master MSB board will open their servos valves until flow demand is determined. See Dip SW table for open water flow valve. Only the necessary number of water heaters will begin to fire to meet demand. Water heaters not firing will close their valves.
- As the default setting, 3 units will open its servo valve until flow demand is determined.
- It is recommended that the dip switch settings on MSB boards other than the Master MSB board be set for 1 unit ready.
- When installation is completed, do a test run for all units.
- After the test run, check and clean the water filter on all units.
- The temperature setting for all of the connected water heaters is controlled by the temperature controller connected to the water heater with the Master MSB Board. Temperature controllers connected to the other units will provide maintenance codes for their respective units.
- If water heaters do not use a temperature controller, the temperature setting for the water heater with the Master MSB board is used.
- If a water temperature over 140 degree F is desired, then an MCC-91 controller needs to be connected to Master Control Board.
- For proper operation, it is not recommended that different models be connected together. Combining different models may result in lower performance.
- The order in which each water heater operates is occasionally rotated to ensure equal usage among the entire system.

Dip SW table for open water flow servo valve

When viewing the installed MSB board, the dip switch will be as shown below (upside down).

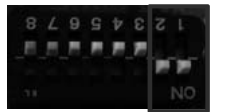
	3 units ready (default)	2 units ready	1 unit ready
Dip SW setting	No1 OFF No2 OFF	No1 ON No2 OFF	No1 ON No2 ON
			

NOTE: In a recirculation system, in order to increase the temperature setting, it is necessary to turn off the power supply to the circulation pump, increase the temperature setting, and then turn the pump back on. No additional action is necessary when decreasing the temperature setting.

Indicator lights on the Control Board indicate the status of each of the water heaters as follows:

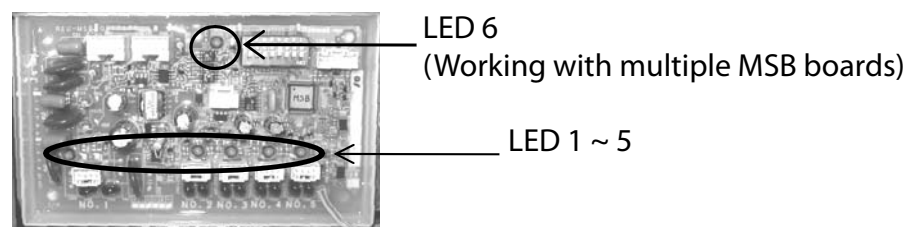

LED 1 ~ 5	EXPLANATION
Solid	Water flow servo valve is open when water heater is in standby or working.
Flashing Slowly (1.2 sec on / 0.5 sec off)	Water flow servo valve is closed when water heater is not operating.
Flashing Quickly (0.5 sec on / 0.5 sec off)	An error is detected. A temperature controller must be connected to this unit to read the error code.
Off	No unit detected at this connection.



Manifold Electronic Control System Installation Instructions

MSB-C2

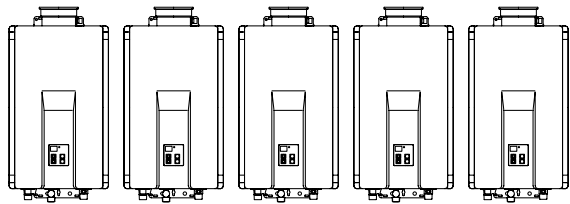

Note:

- Up to 5 water heaters can be connected together using the MSB-M and MSB-C1 kits.
- When over 5 water heaters are connected together, MSB-M units are connected using MSB-C2 kits.
- If multiple MSB-M are used, then at least three water heaters should be connected to each MSB-M.
Ex: With 7 water heaters, one MSB-M should control 4 water heaters and the other MSB-M should control 3 water heaters.
- United States & Canada: For use with Rinnai Tankless Water Heaters (except for models V53e, V53i and R63LSe which must use pressure activation valves, PVA).
- Please contact Rinnai if you have further questions on the applicable water heater models.

WARNING

Disconnect all water heaters from their power source before carrying out the following installation procedures.

NOTE: The front cover panels of each water heater must be removed prior to completing the following installation procedures.

Kit Components

MSB-C2 (Pack C)
(For wiring MSB units)

Part	Qty
MSB Communication cable (13.1 ft, 4 m)	1
Terminal connector	2
Instruction Sheet	1



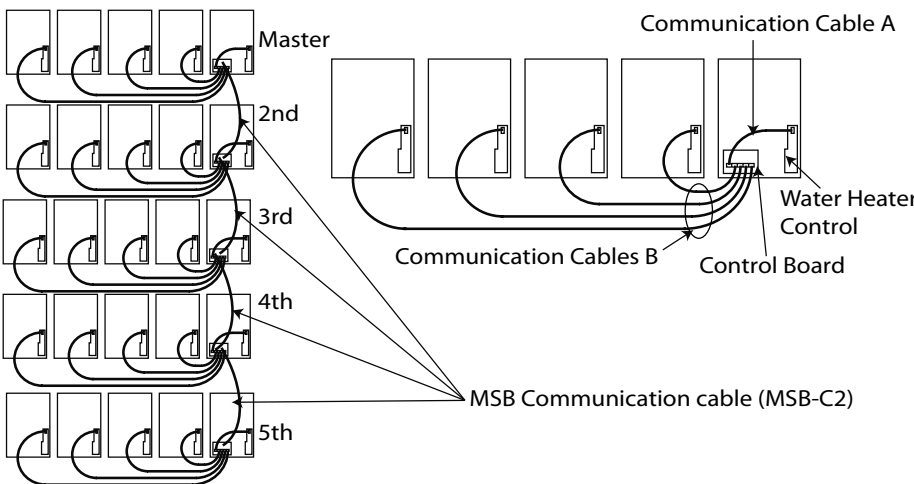

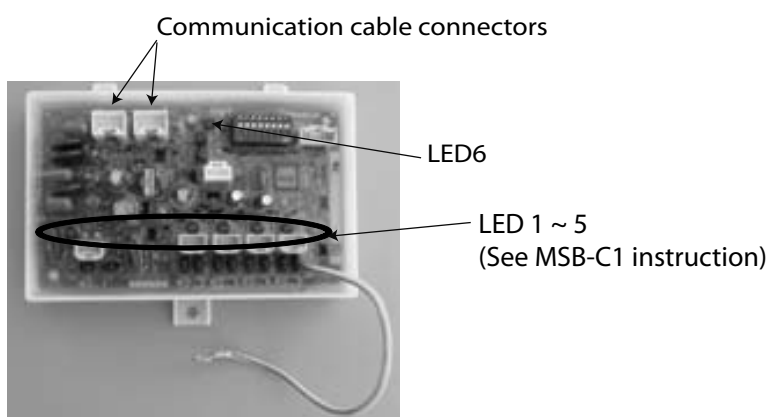

Connecting Multiple MSB-M Units

1) On the master MSB, one connector is connected to the terminal connector and the other one is connected to the MSB Communication cable.

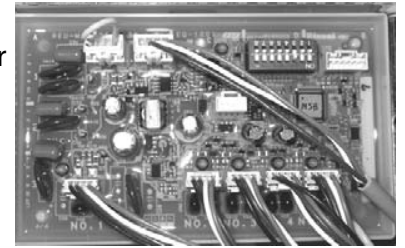

Master MSB board

2) When 2 MSB boards are used a MSB Communication cable will be installed between the master MSB board and the second MSB. The open connector will have the Terminal connector installed on both MSB boards.

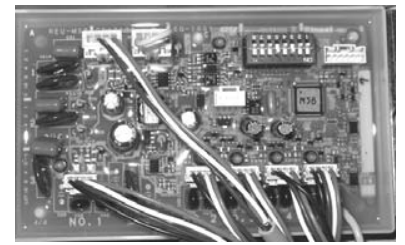

2nd MSB board

A maximum of 5 MSB boards can be connected to each other. The terminal connection is connected on the terminal MSB which has an open connector.

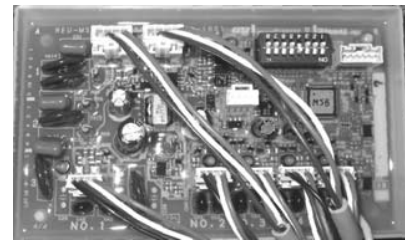

2nd to 4th MSB board

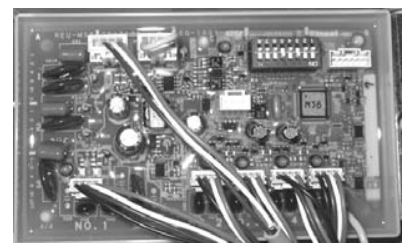

5th MSB board (Terminal MSB)

NOTE:

When viewing the installed MSB board, the dip switch will be as shown below (upside down).

3) Set No 3 switch on the master MSB to ON. The LED light 6 should turn ON confirming the connection.

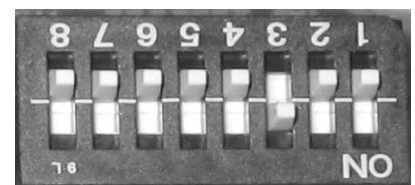

4) Set No 4 switch on the second MSB to ON. The LED light 6 should turn ON confirming the connection.

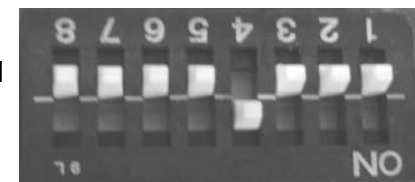

5) Set No 3 and No 4 switches on the third MSB board to ON. The LED light 6 should turn ON confirming the connection.

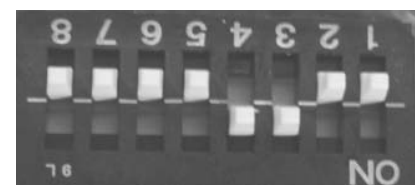

6) Set the No 5 switch on the fourth MSB board to ON. The LED light 6 should turn ON confirming the connection.

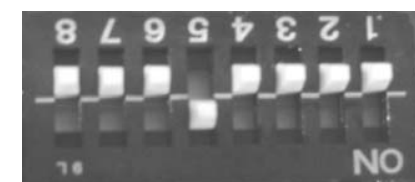

7) Set No 3 and No 5 switches on the fifth MSB board to ON. The LED light 6 should turn ON confirming the connection.

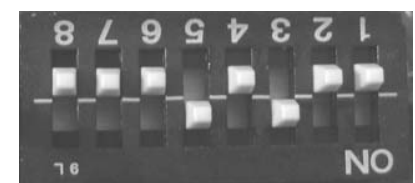

Indicator light (LED 6) on the Control Board indicates the status as follows:

LED 6	EXPLANATION
Solid	Working with multiple MSB boards
Off	Stand alone



Manifold Electronic Control System Installation Instructions

MSB-C3

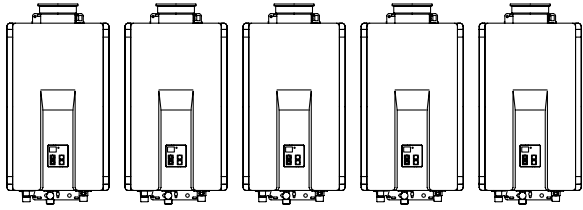

Note:

- Up to 5 water heaters can be connected together using the MSB-M and MSB-C3 kits.
- When over 5 water heaters are connected together, MSB-M units are connected using MSB-C2 kits.
- If multiple MSB-M are used, then at least three water heaters should be connected to each MSB-M.
Ex: With 7 water heaters, one MSB-M should control 4 water heaters and the other MSB-M should control 3 water heaters.
- United States & Canada: For use with Rinnai Tankless Water Heaters (except for models V53e, V53i and R63LSe which must use pressure activation valves, PVA).
- Please contact Rinnai if you have further questions on the applicable water heater models.

WARNING

Disconnect all water heaters from their power source before carrying out the following installation procedures.

NOTE: The front cover panels of each water heater must be removed prior to completing the following installation procedures.

Kit Components

MSB-C3 (Pack D)

Parts List

Part	Qty
Communication Cable (9.8 ft, 3 m)	1
Instruction Sheet	1

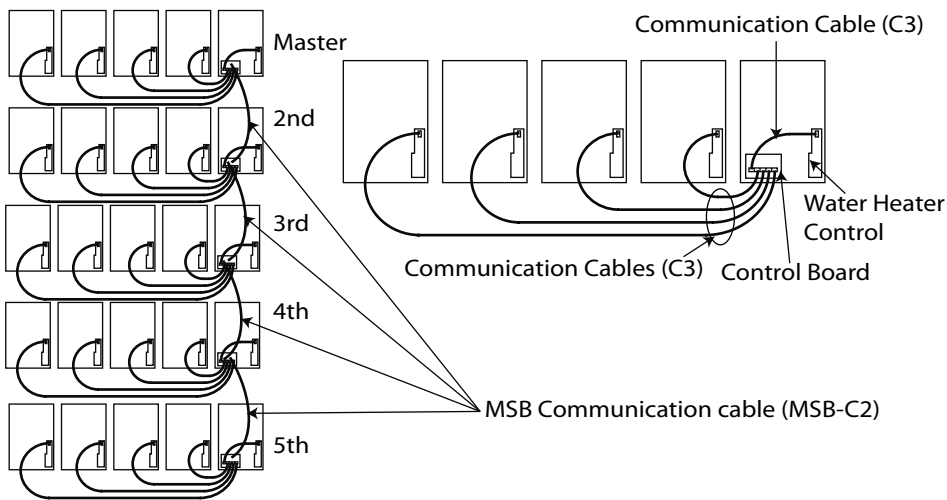

For Unit 1:

1) Remove the screw from the sheet metal reinforcement plate located at the bottom of the water heater cabinet, and then use it to secure the Control Board to the water heater cabinet.



2) Connect the connector from Communication Cable to socket No. 1 on Control Board.

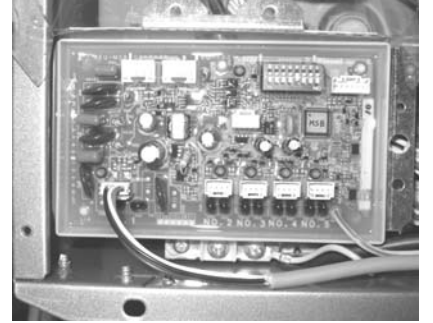

Ground wire of Communication Cable A

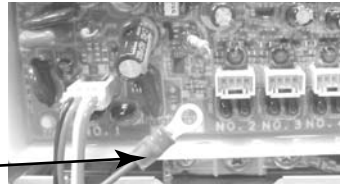

3) Connect the 4-pin connector from Communication Cable to the 4-pin socket located at the top of the water heater control board. The Communication Cable ground wire terminal should be grounded with the PC board ground wire.



Ground wire of Communication Cable A

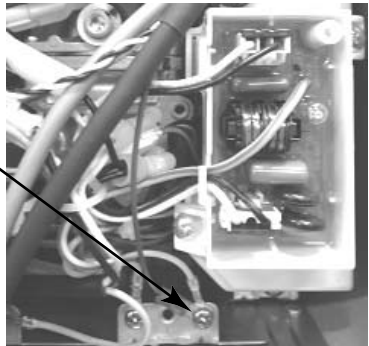

4) Remove the protective cap from the 2-pin connector marked "MS" (located in the middle of the water heater wiring harness).

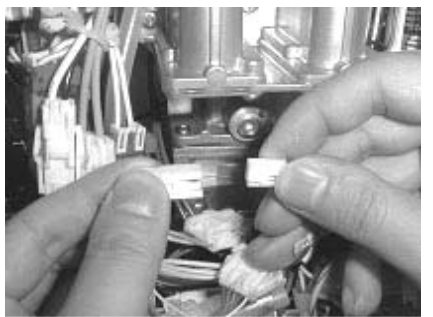

5) Connect the 2-pin connector from Communication Cable into the 2-pin connector marked "MS".
6) Repeat steps 2 to 5 for Units 2, 3, 4, and 5, as applicable.

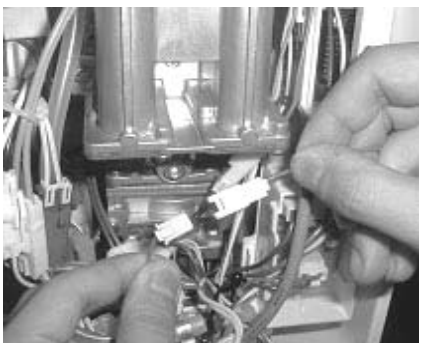

Note: Communication Cable for Unit 2 plugs into socket 2, Unit 3 plugs into socket 3, etc.

7) After making all of the connections to the Control Board, tighten all of the cable ties used to secure the Communication Cables. Ground all the Communication Cables.

