



Catalan®



24-1/8" W x 36-1/8" H aluminum single-door medicine cabinet with 1 K-2936-PG-SAA

1158624** [11" (27.9 cm)]
1158673** [16" (40.6 cm)]
1158674** [20" (50.8 cm)]

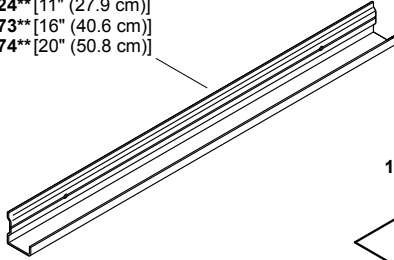

1172601**

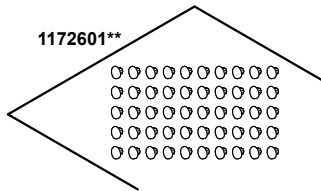

1158657

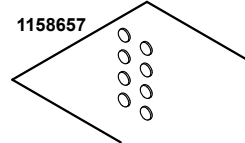

1172602

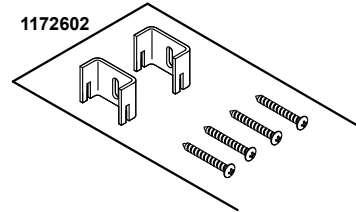

1158659

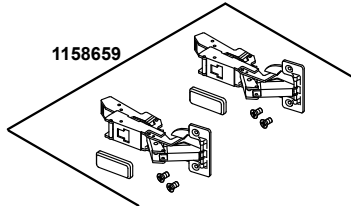

1158660

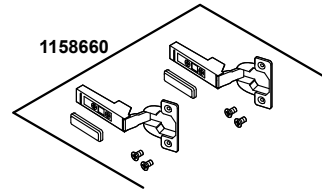

1172604** [13-1/2" (34.3 cm)]
1172605** [18-1/2" (47 cm)]
1172606** [22-1/2" (57.2 cm)]

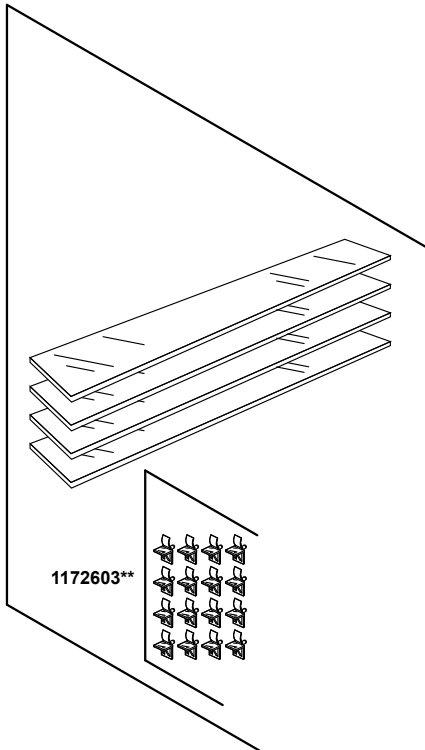

1172603**