

Stainless Steel Pipe System

PRESSFIT 304™



SEE VICTAULIC PUBLICATION 10.01 FOR DETAILS

The Victaulic® Pressfit 304™ System for joining approved Type 304/304L stainless steel pipe provides a fast, easy, clean, reliable means for joining ½"/15mm, ¾"/20mm, 1"/25mm, 1 ½"/40mm, and 2"/50mm stainless steel pipe. Pressfit 304 products and Type 304/304L stainless steel pipe are designed for pressure service to 300psi/2065kPa or ANSI Class 150 (except steam, according to standard temperature/pressure charts, below) for water, oil, non-combustible gaseous and general chemical services. Refer to o-ring selection data for the intended service. The system requires no flame as with welding; no cutting oil, chips or preparation time as with threading or flanging. Stainless steel pipe is cut to size, inserted into the coupling and the coupling pressed onto the pipe and fitting in seconds.



Victaulic Type 304 stainless steel pipe meets the requirements of ASTM A-312, Grade 304/304L (TP304, UNS designation S30400). **Only approved Pressfit 304 pipe must be used with Pressfit 304 stainless steel products.**

The system meets the hanging requirements of ASME B31.1, B31.3 and B31.9.

Pressfit 304 couplings, fittings and approved pipe are UL classified in accordance with ANSI/NSF 61 for cold +86°F/+30°C and hot +180°F/+82°C potable water service.

For product installation instructions, refer to Pressfit Product Assembly Instructions (I-500) and the appropriate Tool Operating and Maintenance Instructions Manual.

*Style 500 Series Pressfit products are FM Approved as noted below when installed on Victaulic Pressfit 304 Schedule 5 stainless steel pipe only for services up to 175 psi/1205 kPa. See Submittal Publication 18.01 for products Approved for use with Pressfit 316 Schedule 5 stainless steel pipe.

PERFORMANCE

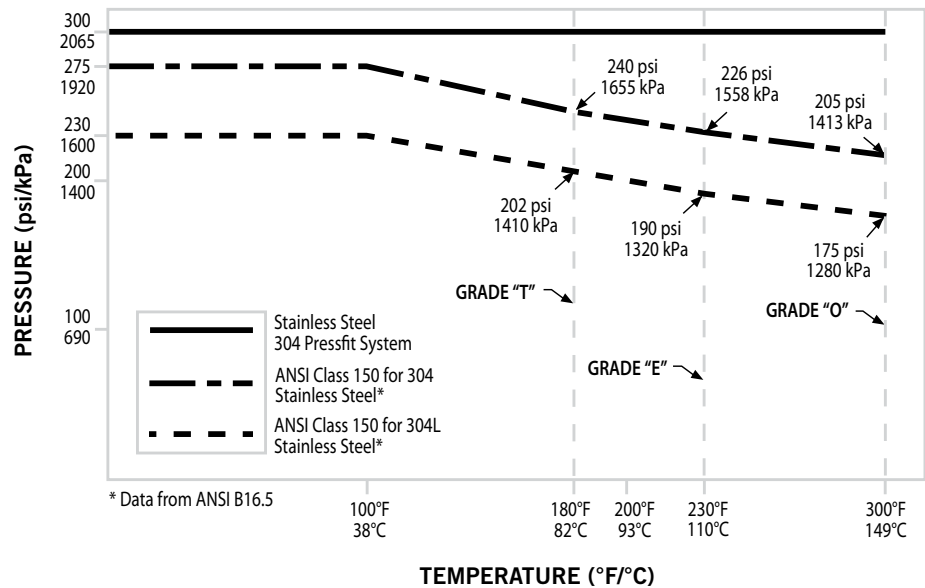

JOB/OWNER

System No. _____
 Location _____

CONTRACTOR

Submitted By _____
 Date _____

ENGINEER

Spec Sect _____ Para _____
 Approved _____
 Date _____



Stainless Steel Pipe System

PRESSFIT 304™

MATERIAL SPECIFICATIONS

Housing Body: Precision cold drawn austenitic stainless steel.

Threaded Outlets: Austenitic stainless steel bar conforming to ASTM A-276 or pipe conforming to ASTM A-312.

Plain End or Grooved End Products: Austenitic stainless steel pipe conforming to ASTM A-312.

Flanges for Style 595: Austenitic stainless steel conforming to ANSI Class 150.

O-Ring Seals: (Specify choice on order) O-ring seals shall be molded of synthetic rubber.

- **Grade "E" EPDM**

EPDM (Green color code). Temperature range -30°F to +230°F/-34°C to +110°C.

Recommended for hot water service within the specified temperature range plus a variety of dilute acids, compressed air and many chemical services. UL classified in accordance with ANSI/NSF 61 for cold +86°F/+30°C and hot +180°F/+82°C potable water service. NOT RECOMMENDED FOR PETROLEUM SERVICES. NOT RECOMMENDED FOR STEAM SERVICES.

- **Grade "T" nitrile**

Nitrile (Orange color code). Temperature range -20°F to +180°F/-29°C to +82°C.

Recommended for petroleum products, vegetable and mineral oils within the specified temperature range; except hot, dry air over +140°F/+60°C and water over +150°F/+66°C. NOT RECOMMENDED FOR HOT WATER SERVICES.

- **Grade "O" fluoroelastomer**

Fluoroelastomer (Blue color code). Temperature range +20°F to +300°F/-7°C to +149°C.

Recommended for many oxidizing acids, petroleum oils, halogenated hydrocarbons, lubricants, hydraulic fluids, organic liquids and air with hydrocarbons.

* Services listed are General Service Recommendations only. It should be noted that there are services for which these o-rings are not recommended. Reference should always be made to the latest Victaulic Gasket Selection Guide for specific o-ring service recommendations and for a listing of services which are not recommended.

WARNING

WARNING

- Pressfit 304 products must only be used on services compatible with o-ring and fitting materials.

- Incompatible services may result in leakage.

For services not listed or special services, contact Victaulic for recommendations.

Stainless Steel Pipe System

PRESSFIT 304™

PRESSFIT COMPONENTS

- 1** O-RING
- 2** O-RING POCKET
- 3** HOUSING
- 4** PIPE STOP
- 5** INSERTION MARK
- 6** TOOL INDENT

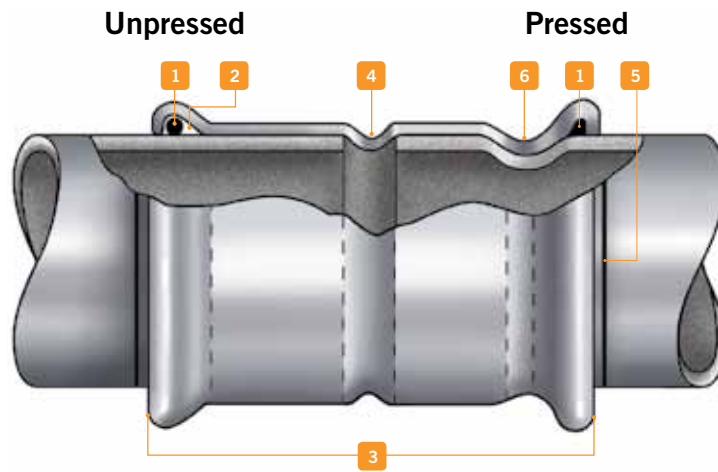

Exaggerated for clarity

FRICITION LOSS

Size		Flow Rate GPM LPM	Friction Loss – (psi Per Ft./ kPa/m) C = 120				
Nom. Size Inches mm	Actual Out. Dia. Inches mm		Sch. 5	Schedule 10		Schedule 40	
				psi/Ft. kPa/m	Higher	psi/Ft. kPa/m	Higher
½ 15	0.840 21.3	15	0.5000	0.6430	22%	0.9510	90%
		56.8	11.3	14.6		21.5	
¾ 20	1.050 26.7	25	0.3713	0.4510	21%	0.6351	71%
		94.6	8.4	10.2		14.4	
1 25	1.315 33.7	40	0.2584	0.3773	46%	0.4691	82%
		151.4	5.9	8.5		10.6	
1½ 40	1.900 48.3	120	0.2800	0.3592	28%	0.4445	59%
		454.2	6.3	8.1		10.1	
2 50	2.375 60.3	150	0.1330	0.1616	22%	0.1989	50%
		567.8	3.0	3.7		4.5	

FLOW AREA

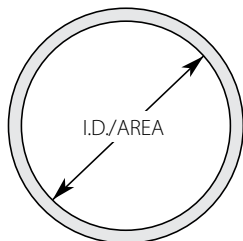

Pressfit 304 stainless steel pipe provides larger flow area and greater capacity frequently permitting pipe downsizing.

Size		Sch. 5	Available Flow Area (Sq. Inches/mm ²)			
Nom. Size Inches mm	Actual Out. Dia. Inches mm		Schedule 10		Schedule 40	
			Flow Area	Less	Flow Area	Less
½ 15	0.840 21.3	0.396	0.357	10%	0.304	23%
		255.4	230.3		196.1	
¾ 20	1.050 26.7	0.655	0.614	8%	0.533	20%
		422.5	396.0		343.8	
1 25	1.315 33.7	1.103	0.945	14%	0.864	22%
		711.4	609.5		557.3	
1½ 40	1.900 48.3	2.461	2.222	10%	2.036	17%
		1587.3	1433.2		1313.2	
2 50	2.375 60.3	3.960	3.650	8%	3.360	15%
		2554.2	2354.3		2167.2	

Stainless Steel Pipe System

PRESSFIT 304™

Dimensional Information

Products in the Pressfit 304/316 Systems have unique center-to-end or end-to-end dimensions which incorporate specific, uniform "takeout" dimensions for easy fabrication calculations. Use of threaded products employing special features such as probes, escutcheon cups, etc., should be checked to be certain the thread standard and length of insertion are compatible with fitting dimensions. Failure to verify dimensional suitability in advance may result in difficulties in assembly

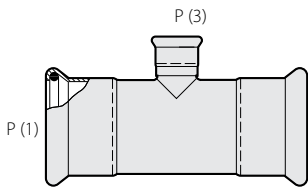

- END TYPE CODE**
- P = Pressfit
 - F = Female Pipe Thread
 - M = Male Pipe Thread
 - T = Plain End
 - L = Flanged
 - G = Grooved

Standard Coupling

STYLE 597 (P x P)

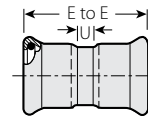

STYLE 597

Size		Dimensions – Inches/mm		Approx. Weight Each
Nominal Size Inches mm	Actual Outside Diameter Inches mm	E to E	U Takeout	Lbs. kg
½	0.840	2.00	0.35	0.1
15	21.3	51	9	0.1
¾*	1.050	2.17	0.28	0.2
20	26.7	55	7	0.1
1*	1.315	2.44	0.39	0.2
25	33.7	62	10	0.1
1½*	1.900	3.15	0.32	0.5
40	48.3	80	8	0.2
2*	2.375	3.94	0.33	0.7
50	60.3	100	8	0.3

*FM Approved for services up to 175 psi/1205 kPa.

Elbows

- STYLE 590 90° Elbow (P x P)
- STYLE 586 Short Tangent 90° Elbow (P x P)
- STYLE 591 45° Elbow (P x P)

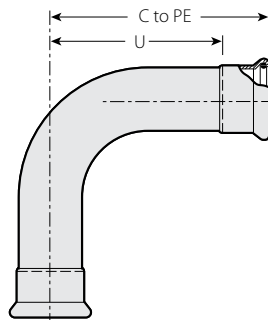

STYLE 590

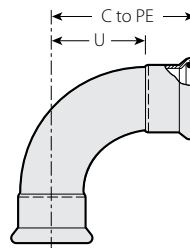

STYLE 586

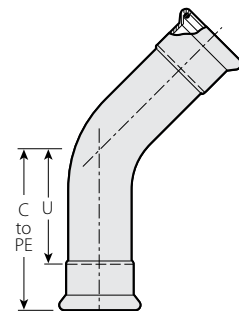

STYLE 591

Size		Style 590 90° Elbow			Style 586 Short Tangent 90° Elbow			Style 591 45° Elbow		
Nominal Size Inches mm	Actual Outside Diameter Inches mm	C to PE Inches mm	U Takeout Inches mm	Approx. Weight Each Lbs. kg	C to PE Inches mm	U Takeout Inches mm	Approx. Weight Each Lbs. kg	C to PE Inches mm	U Takeout Inches mm	Approx. Weight Each Lbs. kg
½	0.840	2.67	1.84	0.3	—	—	—	1.65	0.82	0.2
15	21.3	68	47	0.1	—	—	—	42	21	0.1
¾*	1.050	3.43	2.48	0.4	2.83	1.88	0.3	2.44	1.50	0.3
20	26.7	87	63	0.2	72	48	0.2	62	38	0.1
1*	1.315	4.33	3.31	0.6	3.36	2.34	0.5	3.11	2.09	0.5
25	33.7	110	84	0.3	85	59	0.2	79	53	0.2
1½*	1.900	6.73	5.32	1.4	4.60	3.19	1.0	5.00	3.59	1.3
40	48.3	171	135	0.6	117	81	0.5	127	91	0.6
2*	2.375	8.19	6.38	2.3	5.71	3.90	1.5	6.02	4.22	2.0
50	60.3	208	162	1.0	145	99	0.7	153	107	0.9

*FM Approved for services up to 175 psi/1205 kPa.

Stainless Steel Pipe System

PRESSFIT 304™

Tee

STYLE 592 (P × P × P)

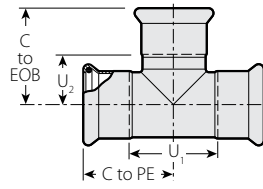

STYLE 592

Size		Dimensions – Inches/mm				Approx. Wgt. Each
Nominal Size Inches mm	Actual Outside Dia. Inches mm	C to PE	U ₁	C to EOB	U ₂	Lbs. kg
½	0.840	1.40	1.04	1.60	0.72	0.2
15	21.3	36	26	41	18	0.1
¾*	1.050	1.89	1.89	1.89	0.95	0.3
20	26.7	48	48	48	24	0.1
1*	1.315	2.11	2.17	2.15	1.13	0.4
25	33.7	54	55	55	29	0.2
1½*	1.900	2.76	2.69	2.80	1.39	0.9
40	48.3	70	68	71	35	0.4
2*	2.375	3.39	3.17	3.62	1.81	1.4
50	60.3	86	81	92	46	0.6

*FM Approved for services up to 175 psi/1205 kPa.

Tee with Threaded Branch

STYLE 588 (P × P × F)

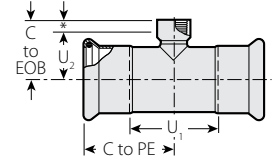

STYLE 588

Size			Dimensions – Inches/mm				Approx. Wgt. Each
Nominal Size Inches mm			C to PE	U ₁	C to EOB	U ₂	Lbs. kg
½	× ½	× ½	1.50	1.35	1.50	0.97	0.2
15	× 15	× 15	38	34	38	25	0.1
¾	× ¾	× ½	1.89	1.89	1.64	1.11	0.3
		20	48	48	42	28	0.2
1	× 1	× ¾*	1.89	1.89	1.71	1.16	0.4
		20	48	48	43	29	0.2
		× ½	2.11	2.17	1.78	1.25	0.4
25	× 25	× 15	54	55	45	32	0.2
		× ¾*	2.11	2.17	1.85	1.30	0.5
		20	54	55	47	33	0.2
1*	× 1*	× ½	2.11	2.17	2.02	1.34	0.6
		25	54	55	51	34	0.3
		× 1½	2.76	2.69	2.07	1.54	0.8
40	× 40	× 15	70	68	53	39	0.4
		× ¾*	2.76	2.69	2.14	1.59	0.9
		20	70	68	54	40	0.4
1*	× 1*	× 25	2.76	2.69	2.31	1.63	0.9
		70	68	59	40	0.4	
		× 2	3.39	3.16	2.31	1.78	1.2
50	× 50	× 15	86	80	59	45	0.5
		× ¾*	3.39	3.16	2.38	1.83	1.3
		20	86	80	60	46	0.6
1*	× 1*	× 25	3.39	3.16	2.55	1.87	1.3
		86	80	65	48	0.6	

*FM Approved for services up to 175 psi/1205 kPa.

Stainless Steel Pipe System

PRESSFIT 304™

Tee with Reducing Branch

STYLE 593 (P × P × P)

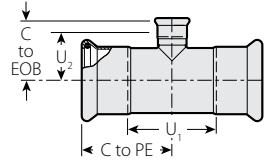

STYLE 593

Size			Dimensions – Inches/mm				Approx. Weight Each
Nominal Size Inches			C to PE	U ₁	C to EOB	U ₂	Lbs. kg
¾	×	¾	1.90	1.91	2.10	1.27	0.3
20		20	48	48	53	32	0.1
	×	½	2.10	2.15	2.30	1.47	0.3
1		15	53	55	58	37	0.1
		¾*	2.11	2.17	2.03	1.09	0.4
		20	54	55	52	28	0.2
1½	×	1½	2.76	2.69	2.60	1.77	0.6
40		40	70	68	66	45	0.3
		¾*	2.76	2.69	2.32	1.68	0.7
		20	70	68	59	43	0.3
		1*	2.76	2.69	2.44	1.42	0.8
		25	70	68	62	36	0.4
2	×	2	3.39	3.17	2.80	1.97	1.2
50		50	86	81	71	50	0.5
		¾*	3.39	3.17	2.56	1.62	1.3
		20	86	81	65	41	0.6
		1*	3.39	3.17	2.68	1.66	1.1
		25	86	81	68	42	0.5
		1½*	3.39	3.17	3.03	1.62	1.3
		40	86	81	77	41	0.6

*FM Approved for services up to 175 psi/1205 kPa.

Male Threaded Adapter

STYLE 596 (P × M)

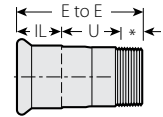

STYLE 596

Size		Dimensions – Inches/mm			Approx. Weight Each	
Nominal Size Inches		E to E	U Takeout	IL Insert. Length	Lbs. kg	
½	×	3.68	2.32	0.83	0.2	
15		93	59	21	0.1	
¾	×	3.22	1.75	0.95	0.3	
20		82	44	24	0.1	
		¾*	3.72	2.22	0.95	0.3
		20	94	56	24	0.1
		1*	3.22	1.60	0.95	0.4
		25	82	41	24	0.2
1	×	3.34	1.77	1.02	0.4	
25		85	45	26	0.1	
		1*	4.02	2.32	1.02	0.4
		25	102	59	26	0.2
1½	×	3.69	1.73	1.42	0.6	
40		94	44	36	0.3	
		1½*	4.40	2.27	1.42	0.7
		40	112	58	36	0.3
2	×	5.03	2.46	1.81	1.0	
50		128	62	46	0.5	

*FM Approved for services up to 175 psi/1205 kPa.

Stainless Steel Pipe System

PRESSFIT 304™

Female Threaded Adapter

STYLE 599 (P × F)

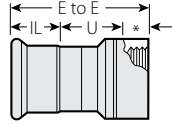

STYLE 599

Size Nominal Size Inches mm	Dimensions – Inches/mm			Approx. Weight Each
	E to E	U Takeout	IL Insert. Length	Lbs. kg
½ × ½ 15 × 15	2.15	0.79	0.83	0.2
	55	20	21	0.1
¾ × ½ 20 × 15	2.20	0.71	0.95	0.2
	56	18	24	0.1
¾ × ¾ 20 × 20	2.20	0.79	0.95	0.2
	56	20	24	0.1
1 × ½ 25 × 15	2.30	0.75	1.02	0.4
	58	19	26	0.2
	2.30	0.73	1.02	0.3
1 × ¾ 25 × 20	2.30	0.73	1.02	0.3
	58	19	26	0.1
	2.40	0.75	1.02	0.4
1* × ½ 25 × 15	2.40	0.75	1.02	0.4
	61	19	26	0.2
	2.96	0.92	1.42	0.8
1½ × 1 40 × 25	2.96	0.92	1.42	0.8
	75	23	36	0.4
	2.96	0.87	1.42	0.6
1½ × ¾ 40 × 32	2.96	0.87	1.42	0.6
	75	22	36	0.3
	2.96	0.87	1.42	0.8
2 × 1½ 50 × 40	2.96	0.87	1.42	0.8
	75	22	36	0.4
	3.75	1.27	1.81	0.9
2 × 1¼ 50 × 32	3.75	1.27	1.81	0.9
	95	32	46	0.4
	3.75	1.27	1.81	1.1
2 × 1½ 50 × 40	3.75	1.27	1.81	1.1
	95	32	46	0.5
	3.75	1.27	1.81	1.0
2 × 2 50 × 50	3.75	1.27	1.81	1.0
	95	32	46	0.5

*FM Approved for services up to 175 psi/1205 kPa.

Weld Adapter

STYLE 561 (P × T)

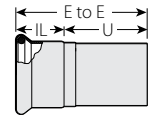

STYLE 561

Size Nominal Size Inches mm	Dimensions – Inches/mm			Approx. Weight Each
	E to E	U Takeout	IL Insert. Length	Lbs. kg
½ × ½ 15 × 15	3.68	2.85	0.83	0.2
	93	72	21	0.1
¾ × ¾ 20 × 20	3.72	2.77	0.95	0.3
	94	70	24	0.1
1 × 1 25 × 25	4.02	3.00	1.02	0.4
	102	76	26	0.2
1½ × 1 40 × 25	4.40	2.98	1.42	0.7
	112	76	36	0.3
2 × 2 50 × 50	5.03	3.22	1.81	1.0
	128	82	46	0.5

Threaded Union

STYLE 584 (P × P)

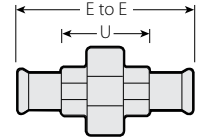

STYLE 584

Size		Dimensions – Inches/mm		Approx. Weight Each
Nominal Size Inches mm	Actual Outside Diameter Inches mm	E to E	U Takeout	Lbs. kg
½ 15	0.840 21.3	7.02 178	5.27 134	2.80 1.3
	¾* 20	1.050 26.7	7.14 181	5.14 131
1* 25		1.315 33.7	7.26 184	5.26 134
	1½* 40	1.900 48.3	8.44 214	5.44 138
2* 50		2.375 60.3	8.38 213	4.67 119

*FM Approved for services up to 175 psi/1205 kPa.

Stainless Steel Pipe System

PRESSFIT 304™

Grooved End Union

STYLE 547

Request Publication 06.02 for Style 77 Flexible Joint
 Request Publication 06.04 for Style 07 Rigid Joint
 Request Publication 17.03/17.14 for Style 77S/475 Flexible Joints
 Request Publication 17.25 for Style 489 Rigid Joints

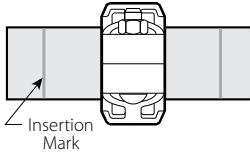

- Style 547 grooved end union can be formed with two Style 587 transition nipples and a variety of grooved end couplings with varied gaskets to meet service requirements
- Standard ductile iron couplings request Style 77 for flexible joints or Style 07 for rigid joints
- Where external corrosion is a concern request Style 77S/475 for flexible joints or Style 489 for rigid joints

Flange Adapter

STYLE 595 (P × L)

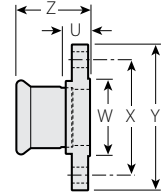

STYLE 595

Size		Dimensions – Inches/mm					Approx. Weight Each	
Nominal Size Inches mm	Actual Out. Dia. Inches mm	U Takeout	W	X	Y	Z	Lbs. kg	
½ 15	0.840 21.3	2.39 61	1.38 35	2.38 60	3.50 89	3.22 82	2.3 1.1	
¾* 20	1.050 26.7	2.27 58	1.69 43	2.75 70	3.88 99	3.22 82	1.7 0.8	
1* 25	1.315 33.7	2.27 58	2.00 51	3.12 79	4.25 108	3.29 84	2.2 1.0	
1½* 40	1.900 48.3	2.07 53	2.88 73	3.88 99	5.00 127	3.48 88	3.6 1.6	
2* 50	2.375 60.3	1.80 46	3.62 92	4.75 121	6.00 152	3.60 92	5.4 2.4	

*FM Approved for services up to 175 psi/1205 kPa.

Van Stone Flange Adapter

STYLE 565 (P × L)

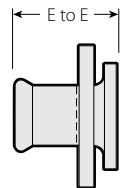

STYLE 565

Size		Dimensions	Approx. Weight Each
Nominal Size Inches mm	Actual Outside Diameter Inches mm	E to E Inches mm	Lbs. kg
½ 15	0.840 21.3	3.12 79	3.00 1.4
¾* 20	1.050 26.7	3.17 81	3.30 1.5
1* 25	1.315 33.7	3.28 83	3.60 1.6
1½* 40	1.900 48.3	3.64 93	5.00 2.3
2* 50	2.375 60.3	4.73 120	5.90 2.7

*FM Approved for services up to 175 psi/1205 kPa.

Stainless Steel Pipe System

PRESSFIT 304™

Transition Nipple

STYLE 587 (G × T)

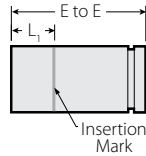

STYLE 587

Size		Dimensions – Inches/mm		Approx. Weight Each
Nominal Size Inches mm	Actual Outside Diameter Inches mm	E to E	L ₁ Minimum	Lbs. kg
¾*	20	4.00	1.00	0.2
		102	25	0.1
1*	25	4.00	1.00	0.3
		102	25	0.1
1½*	40	4.00	1.50	0.4
		102	38	0.2
2*	50	4.00	1.88	0.5
		102	48	0.2

*FM Approved for services up to 175 psi/1205 kPa.

Concentric Reducer

STYLE 594 (T × T)

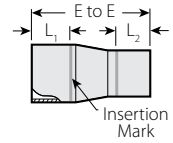

STYLE 594

Size		Dimensions – Inches/mm			Approx. Weight Each
Nominal Size Inches mm		E to E	L ₁ Minimum	L ₂ Minimum	Lbs. kg
¾	× ½	3.50	1.00	0.88	0.2
		89	25	22	0.1
1	× ½	3.56	1.03	0.88	0.2
		90	26	22	0.1
		¾*	3.56	1.03	1.00
20	× 20	90	26	25	0.1
		3.56	1.03	1.00	0.2
1½	× ½	4.25	1.44	0.88	0.3
		108	37	22	0.1
40	× ¾*	4.25	1.44	1.00	0.4
		108	37	25	0.2
1*	× 25	4.25	1.44	1.03	0.4
		108	37	26	0.2
1¼*	× 32	4.25	1.44	1.25	0.4
		108	37	32	0.2
2	× ½	5.00	1.81	0.88	0.6
		127	46	22	0.3
50	× ¾*	5.00	1.81	1.00	0.6
		127	46	25	0.3
1*	× 25	5.00	1.81	1.03	0.6
		127	46	26	0.3
1½*	× 40	5.00	1.81	1.44	0.7
		127	46	37	0.3

*FM Approved for services up to 175 psi/1205 kPa.

Reducer Insert

STYLE 582 (T × P)

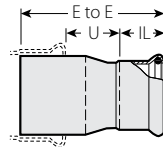

STYLE 582

Size		Dimensions – Inches/mm			Approx. Weight Each
Nominal Size Inches mm		E to E	U Takeout	IL Insertion Length	Lbs. kg
1	× ¾*	2.95	0.98	0.95	0.2
		75	25	24	0.1
2	× 1½*	4.33	1.11	1.42	0.6
		110	28	36	0.3

*FM Approved for services up to 175 psi/1205 kPa.

Stainless Steel Pipe System

PRESSFIT 304™

Pressfit 304™ Brass Body Ball Valve with Stainless Steel Pressfit Ends

SERIES 589 (P × P)



Series 589 Ball Valve is a standard port valve with Pressfit ends for fast, easy installation. The valve, with Pressfit ends is designed for service to 300 psi/2065 kPa.

The valve body is constructed from forged brass. The ball is chrome plated brass and seals on TFE seats. A hollow ball design eliminates unnecessary weight while maintaining flow and mechanical strength. TFE seats and washers reduce the friction coefficient which eases valve operation.

The valve with Pressfit ends is designed for service to 300 psi/2065 kPa.

The Pressfit ends are of austenitic stainless steel.

Size		Dimensions				Approx. Weight Each	Flow Coefficient@ (Fully Open) C _v Values K _v Values
Nominal Size Inches mm	Actual Outside Diameter Inches/mm	A End to End Inches mm	C Inches mm	F Inches mm	U Takeout Inches mm	Lbs. kg	
½ 15	0.840 21.3	8.49 216	1.33 34	3.07 78	6.84 174	0.9 0.4	10 8.7
¾ 20	1.050 26.7	8.88 226	1.79 46	3.78 96	6.99 178	1.3 0.6	25 21.6
1 25	1.315 33.7	9.74 247	1.95 50	3.78 96	7.69 195	1.8 0.8	37 32.0
1½ 40	1.900 48.3	11.09 282	2.68 68	5.43 138	8.26 210	3.4 1.5	87 75.3
2 50	2.375 60.3	12.90 328	2.89 73	5.43 138	9.29 236	4.4 2.0	110 95.2

@ C_v/K_v values for flow of water at +60°F/+16°C with valve fully open.

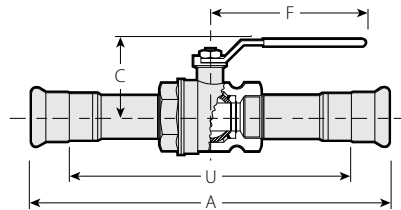

Stainless Steel Pipe System

PRESSFIT 304™

SERIES 589 MATERIAL SPECIFICATIONS

Valve Body: Forged Brass ASTM B-16

Ball: Brass ASTM B-16, chrome plated

Stem: Brass ASTM B-16, chrome plated

Seats: (TFE) Tetrafluoroethylene, rated to +450°F/+232°C.

Handle: Carbon steel, zinc plated

Stem Nut: Carbon steel, zinc plated

Stem Washer: (TFE) Tetrafluoroethylene

O-ring: Fluoroelastomer

Pressfit Ends: Precision cold drawn austenitic stainless steel.

O-ring Seals: (specify choice*) O-ring seals shall be molded of synthetic rubber.

- **Grade "E" EPDM**

EPDM (Green color code). Temperature range -30°F to +230°F/-34°C to +110°C.

Recommended for cold and hot water service within the specified temperature range plus a variety of dilute acids, oil-free air and many chemical services. NOT RECOMMENDED FOR PETROLEUM SERVICES.

- **Grade "T" nitrile**

Nitrile (Orange color code). Temperature range -20°F to +180°F/-29°C to +82°C.

Recommended for petroleum products, air with oil vapors, vegetable and mineral oils within the specified temperature range. Not recommended for hot water services over +150°F/+66°C or for hot dry air over +140°F/+60°C.

- **Optional: Grade "O" fluoroelastomer**

Fluoroelastomer (Blue color code). Temperature range +20°F to +300°F/-7°C to +149°C.

Recommended for many oxidizing acids, petroleum oils, halogenated hydrocarbons, lubricants, hydraulic fluids, organic liquids and air with hydrocarbons within the specified temperature range.

* Services listed are General Service Recommendations only. It should be noted that there are services for which these gaskets are not recommended. Reference should always be made to the latest Victaulic Gasket Selection Guide for specific gasket service recommendations and for a listing of services which are not recommended.

WARNING



WARNING

- Pressfit 304 products must only be used on services compatible with o-ring and fitting materials.
- Incompatible services may result in leakage.

For services not listed or special services, contact Victaulic for recommendations.

Stainless Steel Pipe System

PRESSFIT 304™

Pressfit 316™ Type 316 Stainless Steel Ball Valve

SERIES 569



Series 569 Pressfit System Ball Valves feature full stainless steel body and trim, rated for service up to 300 psi/2065 kPa with Pressfit ends and up to 400 psi/2750 kPa with grooved ends, depending upon the joining coupling.

The valves are constructed of rugged Type 316 (CF8M) stainless steel with PTFE seats. The valves feature a blow-out proof stem and self-adjusting floating ball which provides uniform sealing. The full port design minimizes pressure drop for maximum flow efficiency. The three-piece swing-out design permits easy in-line maintenance.

Size		Dimensions – Inches/mm				Approx. Weight Each
Nominal Size Inches mm	Actual Outside Diameter Inches mm	A End to End	B	C	E	Lbs. kg
1/2*	0.840	7.98	2.36	0.88	5.12	1.5
15	21.3	200.0	59.9	22.4	130.0	0.7
3/4	1.050	8.57	2.52	1.00	5.12	2.4
20	26.7	217.2	64.0	25.4	130.0	1.1
1	1.315	8.89	2.80	1.00	6.50	3.6
25	33.7	225.8	71.1	25.4	165.1	1.6
1 1/2	1.900	11.20	3.39	1.50	7.48	6.9
40	48.3	284.5	86.1	38.1	190.0	3.1
2	2.375	12.52	3.74	1.88	7.48	9.5
50	60.3	318.0	95.0	47.8	190.0	4.3

For dimensions and weights with gear operator contact Victaulic.

*1/2"/15 mm only available in plain end x plain end (T x T).

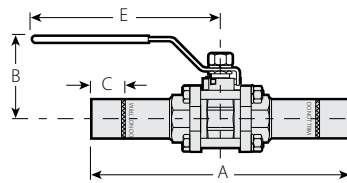

PLAIN END X PLAIN END

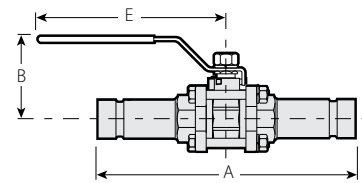

GROOVED X GROOVED

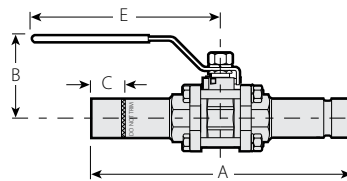

PLAIN END X GROOVED

Stainless Steel Pipe System

PRESSFIT 304™

SERIES 569 MATERIAL SPECIFICATIONS**Body:** Stainless steel, CF8M**Ball:** Stainless steel, CF8M**Stem:** Stainless steel, Type 316**Seats:** (PTFE) Polytetrafluoroethylene**Handle:** Stainless steel, Type 304**Stem Nut:** Stainless steel, Type 304**Stem Washer:** Stainless steel, Type 304**Stem Packing and Thrust Washer:** Tetrafluoroethylene**Bolt/Nut/Washer:** Stainless steel, Type 304**Cap:** Stainless steel, CF8M**Extended Ends:** Schedule 5S Stainless steel, Type 316**Specify end style:**

- Plain End for Pressfit (T x T)
- Grooved End (G x G)
- Plain End x Grooved End (T x G)

WARNING

**WARNING**

- Pressfit 304 products must only be used on services compatible with o-ring and fitting materials.
- Incompatible services may result in leakage.

For services not listed or special services, contact Victaulic for recommendations.

Stainless Steel Pipe System

PRESSFIT 304™

APPROVED PIPE

For Type 304/304L stainless steel Schedule 5S pipe approved for use with the Victaulic Pressfit 304 System, contact Victaulic or your nearest Pressfit 304 Stainless Steel distributor.

Approved pipe meets the requirements of ASTM A-312, Grade 304/304L and carries the label, **“Pressfit 304™ Pipe Certified for use with Pressfit 304 Products”**.

The Pressfit 304 System requires no special preparation of the pipe ends before assembly. Pipe should be square cut (± 0.030 ") and deburred, if required, to prevent damage to the o-ring during assembly.

Pressfit 304 System products are designed only for use on approved Pressfit 304 stainless steel pipe.

For product installation instructions, refer to Pressfit Product Assembly Instructions (I-500) and the appropriate Tool Operating and Maintenance Instructions Manual.

Pipe – Inches/mm			Aprx. Pipe Weight Per Ft.
Nominal Size	Actual Outside Dia.	Wall Thickness	Lbs kg
½ 15	0.840 21.3	0.065 1.7	0.6 0.3
¾ 20	1.050 26.7	0.065 1.7	0.7 0.3
1 25	1.315 33.7	0.065 1.7	0.9 0.4
1½ 40	1.900 48.3	0.065 1.7	1.3 0.6
2 50	2.375 60.3	0.065 1.7	1.6 0.7

*Pipe is supplied in random mill lengths (RML) (17 – 24 ft.) which nominally measure 21 ft. Order quantities will be accepted only in 21 ft. random length increments, subject to industry standard $\pm 10\%$ tolerance. Minimum footage requirements must be specified on the order when required.

WARNING



WARNING

- It is the responsibility of designers of piping systems to verify the suitability of Schedule 5S, Type 304 stainless steel pipe for use with the intended fluid media. The fluid's chemical composition, pH level, operating temperature, chloride level, oxygen level and flow rate and their effect on AISI Type 304 stainless steel must be evaluated by the material specifier to confirm system life will be adequate for the intended service.

Failure to do so may cause serious personal injury or property damage.

Stainless Steel Pipe System

PRESSFIT 304™

PIPE SUPPORT

Piping joined with Pressfit 304 System products, like all other piping systems, requires support to carry the weight of pipes and equipment. As for other methods of joining pipes, the support or hanging method must be such as to eliminate undue stresses on joints, piping and other components. Additionally, the method of support must be such as to allow movement of the pipes where required and to provide drainage, etc., as may be specified by the designer.

The maximum hanger spacing corresponds to ASME B31.1, B31.3 or B31.9 as noted, and should be used in conjunction with Victaulic Pressfit 304 System products on approved Type 304/304L stainless steel pipe.

Pipe Size		Suggested Max. Span Between Supports - Feet/meters					
Nominal Size Inches mm	Actual Out. Dia. Inches mm	Water Service			Gas/Air Service		
		B31.1	B31.3	B31.9	B31.1	B31.3	B31.9
½	0.840	6	6	7	8	8	7
15	21.3	1.8	1.8	2.1	2.4	2.4	2.1
¾	1.050	7	7	8	9	9	8
20	26.7	2.1	2.1	2.4	2.7	2.7	2.4
1	1.315	7	7	9	9	9	9
25	33.7	2.1	2.1	2.7	2.7	2.7	2.7
1½	1.900	7	7	12	9	9	13
40	48.3	2.1	2.1	3.7	2.7	2.7	4.0
2	2.375	10	10	13	13	13	15
50	60.3	3.1	3.1	4.0	4.0	4.0	4.6

Pressfit Tools



PFT505



PFT505

- The Pressfit System requires a Pressfit tool designed for securing Pressfit products onto pipe
- Jaws are available separately for rental (with rental tool) or purchase
- Pressfit tool is designed for industrial and trade use only

Capacity: ½ – 2"/15 – 50mm IPS Schedule 5 steel and stainless steel pipe

Power Requirements: 110 volt, 60cycle, 6.5amp

Accessories: Pressing jaws in ½"/15mm, ¾"/20mm, 1"/25mm, 1½"/40mm and 2"/50mm sizes

Note: PFT505 and PFT509 components are not interchangeable



PFT509

PFT509

- The Pressfit System requires a Pressfit tool designed for securing Pressfit products onto pipe
- Tool packages include the actual pressing tool, two (2) batteries and a charger, carrying case, and ½"/15mm, ¾"/20mm, 1"/25mm, and 1½"/40mm press jaws
- Jaws are available separately for purchase (as needed for replacements)
- Pressfit tool is designed for industrial and trade use only
- Pressfit tool is battery powered and requires a 12V battery charger

Capacity: ½ – 1" and 1½"/15 – 25mm and 40mm IPS Schedule 5 steel and stainless steel pipe

Power Requirements: 110volt/60cycle/6.5amp

Note: PFT505 and PFT509 components are not interchangeable

Stainless Steel Pipe System

PRESSFIT 304™

WARRANTY

Refer to the Warranty section of the current Price List or contact Victaulic for details.

NOTE

This product shall be manufactured by Victaulic or to Victaulic specifications. All products to be installed in accordance with current Victaulic installation/assembly instructions. Victaulic reserves the right to change product specifications, designs and standard equipment without notice and without incurring obligations.

For complete contact information, visit www.victaulic.com

18.02 1278 REV I UPDATED 5/2011

VICTAULIC IS A REGISTERED TRADEMARK OF VICTAULIC COMPANY. © 2011 VICTAULIC COMPANY. ALL RIGHTS RESERVED.

18.02

