



VG295214CA
Stainless steel control panel
Width 36" (90 cm)
Natural gas

Solid smooth-surface cast-iron pan support
59, 700 BTU on five burners including wok burner

Cooking zones

Up to 17.5 kW on 5 burners
1 three-ring wok burner (300 W - 5,500 W) 1,000 – 18,800 BTU, suitable for pots up to max. 12 5/8"
2 two-ring high output burners (160 W – 4000 W), suitable for pots up to max. ø 28 cm.
2 two-ring standard burners (160 W - 2000 W), suitable for pots up to max. ø 24 cm.

Operation

Integrated control panel with cooking zone and output level markings.
One-handed operation.
Gas valve with fine control.

Features

Three-part cast iron pan support with flat, continuous pot surface.
Brass burner rings.

Safety

Electronic flame monitoring with automatic re-ignition.
Automatic quick ignition.

Planning notes

Special nozzles can be ordered as spare parts.
Plan for an electrical connection (the appliance is not operable without power supply).
Panel thickness 16 - 26 mm.
Air intake from above.
No intermediate shelf required.
The rear panel must consist of a non-flammable material. Wall trims must be resistant to heat.
Installation in a 90 cm wide lower cabinet is required.
An oven can be installed under the cooktop.
Appliance must be fixed from underneath. Hardwire required.
A minimum lateral clearance of at least 12" from adjacent heat-sensitive furniture or contact surfaces must be observed or thermal insulation fitted.
Minimum distance between gas cooktop and ventilation hood must be 30".
Cooktop clamping range: 30 - 50 mm.

Rating

Connecting cable 55" with ground plug.
Total Amps: 16A. 208/220 - 240 V. / 60 Hz

Product Features

Product name / series name
gas hob w integrated controls
Construction type
CONSTR_TYPE.Built-in
Energy source
Gas
Total number of cooktop burners
5
Required cutout size (HxWxD) (mm)
132 x 885 x 490
Width of the product (mm)
914
Overall appliance dimensions (HxWxD) (mm)
132 x 914 x 510
Product packaging dimensions (HxWxD) (mm)
289 x 675 x 993
Net weight (kg)
29.137
Gross weight (kg)
32.0
Residual heat indicator
without
Location of control panel
Cooktop front
Basic surface material
brushed stainless steel
Color of surface
Stainless steel
Color of frame
Stainless steel
Approval certificates
ETL
Power cord length (cm)
140

Consumption and connection features

Watts (W)
25
Gas connection rating (W)
17500
Current (A)
10
Volts (V)
110-240
Frequency (Hz)
50; 60
2019-01-16
Page 1

Color Variants

VG295214CA
Width 36" (90 cm)
Natural gas

Optional accessories

WP400001
Wok pan made of multiple-layer material

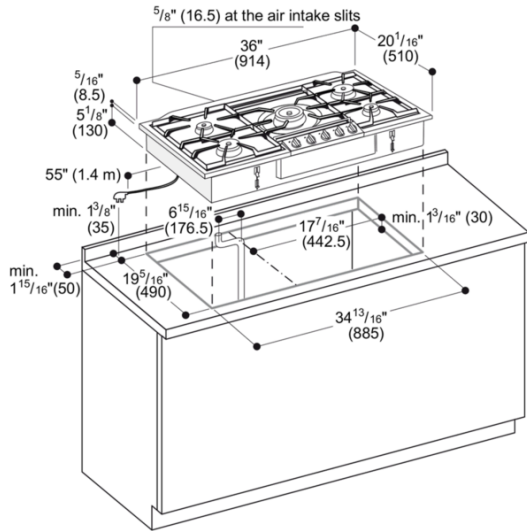

Gas connection

