

Electrical
specs on
page 2



LT Plus Series - Single Phase Tank Mounted Air Compressors for Dry Pipe Sprinkler Systems

LT Plus Series

This tank mounted air compressor is specifically designed to fill systems to 40 PSI in 30 minutes as per NFPA 13



- A.S.M.E. Coded Industrial Receiver
- A.S.M.E. Coded Safety Valve
- Single Stage Air Cooled Pump
- Fan Type Flywheel
- Integral Air Filter
- NEMA Standard Multi-Voltage Motors
- UL Listed Unloading Pressure Switch
- **Pressure Switch Prewired to Motor (NEW)**
- **30" Stainless Steel Flex Hose (NEW)**
- **Vibration Isolation Pads (NEW)**

System Capacity (gal) +	Model Number	Average CFM *	Motor HP	Recommended Wire Size ++	Dimensions			Weight (lbs)	Tank Capacity (gal)	Pressure Switch Prewired **
					L	W	H			
200	LT20033A	2.43	1/3	10	33	13	28	115	10	YES
290	LT29050A	3.52	1/2	8	33	13	28	115	10	YES
365	LT36575A	4.43	3/4	8	33	13	28	124	10	YES
425	LT425100A	5.15	1	6	33	13	28	130	10	YES
660	LT620100A	7.91	1	6	36	15	30	170	20	YES
900	LT900150A	10.91	1½	6	36	15	30	181	20	YES
1050	LT1220200A	12.70	2	4	36	15	30	190	20	NO
1300	LT1300300A	15.76	3	4	36	15	30	190	20	NO
1400	LT1600300A	19.40	3	2	40	18	44	310	30	NO
2000	LT2000500A	24.25	5	2	40	18	44	319	30	NO
2500	LT2500500A	30.32	5	2	40	18	44	336	30	NO

Accessories:



Air Maintenance Device - Part # AMD-1

The AMD-1 is **required** for supplying air to a dry pipe system when using a tank mounted unit. The AMD-1 regulates the volume of air being delivered to the system.

Motor Line Starters - Thermal Overload Protection Single Phase

Maximum HP	115V	208/230V	Size	Model
	1/3 HP	1 HP	00	MG00A
1 HP	2 HP	0	MGX0A	
2 HP	3 HP	1	MG01A	
3 HP	5 HP	1P	MG15A	

When Ordering a Motor Starter you must specify HP, Voltage and Phase that is supplied to the motor.

Notes:

- + System Capacity based on 70°F system temperature.
- * Average CFM is the average free air delivery from 0 to 40 PSIG
- ++ Recommended Wire Sizes based on 100ft run. consult factory for longer or shorter runs.
- ** Only Units With Internal Overload Protection Prewired.

VOLTAGE - All Single Phase Units:

Up to 2 HP: 115/208-230 VAC / 3 to 5 HP: 208-230 VAC

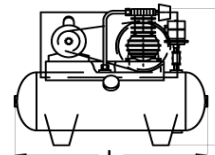

WARNING: Cancer and Reproductive Harm - www.p65warnings.ca.gov



LT Plus Series - Single Phase Tank Mounted Fire Protection Air Compressor Electrical Cut Sheet

LT Plus Series

This tank mounted air compressor is specifically designed to fill systems to 40 PSI in 30 minutes as per NFPA 13



Only Units With Internal Overload Protection Prewired

Model Number	Nominal HP	Factory Wired Voltage	Amperage (amps)			Recommended Wire Size Based on Run Length (gage)			Motor Protection Included
			Voltage	FLA	Start Up	25 FT	50 FT	100 FT	
LT20033A	1/3	115	115	6.4	44.8	12	12	10	YES
			208	3	21	12	12	10	
			230	3.2	22.4	12	12	12	
LT29050A	1/2	115	115	8.6	60.2	12	12	8	YES
			208	4.1	28.7	12	10	8	
			230	4.3	30.1	12	12	12	
LT36575A	3/4	115	115	11	77	12	10	8	YES
			208	5.5	38.5	12	10	8	
			230	5.5	38.5	12	12	12	
LT425100A	1	115	115	13.6	95.2	12	10	6	YES
			208	6.9	48.3	12	10	6	
			230	6.8	47.6	12	12	12	
LT620100A	1	115	115	14.7	102.9	12	10	8	YES
			208	7.1	49.7	12	8	6	
			230	7.3	51.4	12	12	12	
LT900150A	1 1/2	115	115	14.7	102.9	12	10	8	YES
			208	7.1	49.7	12	8	6	
			230	7.3	51.4	12	12	12	
LT1220200A	2	230	115	21	147	10	8	4	NO
			208	11.3	79.1	10	8	4	
			230	10.5	73.5	12	12	10	
LT1300300A	3	230	208	14	98	10	6	4	NO
			230	12.6	88.2	12	12	10	
LT1600300A	3	230	208	17.4	121.8	8	4	2	NO
			230	16.8	117.6	12	12	10	
LT2000500A	5	230	208	23	161	8	4	2	NO
			230	21	147	12	12	8	
LT2500500A	5	230	208	23	161	8	4	2	NO
			230	21	147	12	12	8	

Note:

Wire sizes are based on maintaining 90% of the nominal voltage at starting amps. Starting amps are assumed to be 6 times the SFA.

Warning:

Failure to consult with a licensed electrical professional can result in serious personal injury or death. Disconnect all power before servicing. Undersized wire between the motor and the power source will limit the starting and load carrying abilities of the motor causing motor overheating and permanent damage to the motor. Wire sizes listed are recommendations only - consult the National Electric Code (NEC) and any applicable local electrical safety codes. The NEC and GAP recommends a maximum voltage drop of 3%. Install motors and related equipment in accordance with the National Electrical Code (NEC) local electrical safety codes and practices. **It is always the electrician's responsibility to determine and install a wire size that ensures motors can start and run well.**

LT Plus Series - Connection Diagram

LT Plus Series

This tank mounted air compressor is specifically designed to fill systems to 40 PSI in 30 minutes as per NFPA 13



System Layout

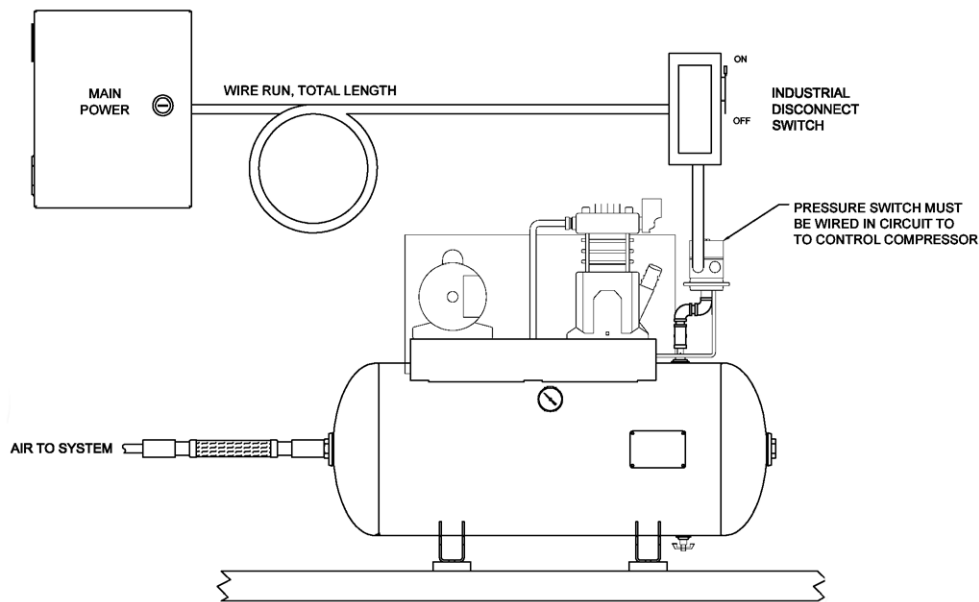

Pressure Switch Connection (Single Phase Only)

PRESSURE SWITCH Diagram

Note: Location of pressure switch varies based on model. This is a general diagram of components. For help specific to your switch please contact General Air Products.

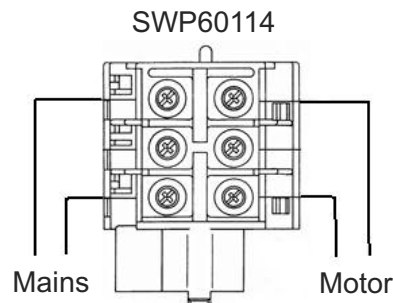

Warning:

Failure to consult with a licensed electrical professional can result in serious personal injury or death. Disconnect all power before servicing. Undersized wire between the motor and the power source will limit the starting and load carrying abilities of the motor causing motor overheating and permanent damage to the motor. Wire sizes listed are recommendations only - consult the National Electric Code (NEC) and any applicable local electrical safety codes. The NEC and GAP recommends a maximum voltage drop of 3%. Install motors and related equipment in accordance with the National Electric Code (NEC) local electrical safety codes and practices. **It is always the electrician's responsibility to determine and install a wire size that ensures motors can start and run well.**