

Mueller Co. offers a variety of proven service connections to fit most pipe and tubing used in today's service lines. These connections include the Mueller 110[®] Compression Connection,

Mueller Pack Joint Connection, Mueller INSTA-TITE[®] Connection, Mueller GRIP Connection, copper flare connection and several types of threaded connections.

The Mueller 110 Compression Connection offers high resistance to pull-out, fast installation, and a visual means to check for proper tightness. This connection is available on most Mueller valves and stops in sizes from 3/4" to 2", and for CTS tubing or IPS pipe.

All service brass will comply with AWWA C-800. Components in contact with potable water will also comply with latest requirements of the Federal Safe Drinking Water Act.

Mueller 110[®] Compression Connection Features

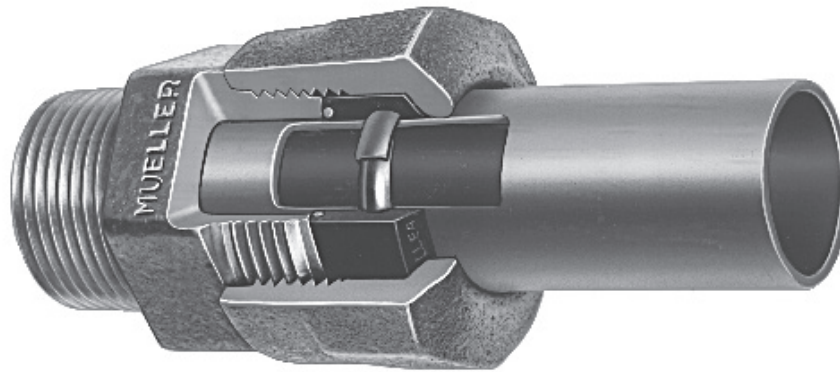

- **Nut** - corrosion resistant cast bronze ASTM B62 (85- 5-5-5). Bottoms out on shoulder of coupling to give quick visual indication of proper tightening.
- **Two Designs** - conductive compression connection fits type "K" copper tubing and CTS O.D. PE plastic tubing. A separate design fits IPS PE plastic pipe. Recommended stainless steel liners for plastic tubing and pipe available.
- **Conductor Spring** - provides metal-to-metal contact between copper tubing and fitting for electrical conductivity.
- **Gasket** - compresses concave gripper band and seals against fitting body, pipe and nut. Uniform pressure is applied around the concave gripper, forcing each outer edge to grip the pipe for pull-out resistance .
- **Entire Gasket** - is enclosed to resist cold flow & creep.
- **Fluorocarbon Coating** - on inside surface of nut reduces tightening effort and avoids gasket
- **Pressure Rating** - The pressure holding capability of the Mueller 110 Compression Connection is designed to be greater than that of the valve or fitting on which it is used (only in potable water distribution applications complying with AWWA standards).
- **Gripper Band** - is stainless steel and overlaps itself so no gasket material can get underneath.

Rev. 3-15 Shaded area indicates changes

Mueller® INSTA-TITE® Connection



- **Body** - is cast from corrosion resistant Low Lead bronze in compliance with AWWA C-800.
- **Large Wrench Flats** - provide generous gripping area for tightening connections to valve bodies.
- **Two Designs** - are available to fit either CTS O.D. PE plastic tubing or IPS PE plastic pipe.
- **Simple Design** - eliminates flaring, heating, threading, cementing, and nut tightening. Liners (inserts) are not required.
- **Pressure Rating** - The pressure holding capability of the Mueller INSTA-TITE Connection is designed to be greater than that of the valve or fitting on which it is used (only in potable water distribution applications complying with AWWA standards).
- **O-Ring** - between the connection housing and the tubing or pipe creates a positive seal. Any increase in pressure, up to the maximum rating of the PE tubing or pipe, increases the sealing force.
- **Mueller INSTA-TITE Connection** - is used on polyethylene (PE) pipe or tubing only.
- **Grip Ring** - is made from a high strength plastic and is designed to allow easy installation of the pipe or tubing while providing high resistance to pullout.
- **Color Coded** - grip ring, RED for CTS O.D. and WHITE for IPS, aids in proper selection and use.

Copper Flare Connection

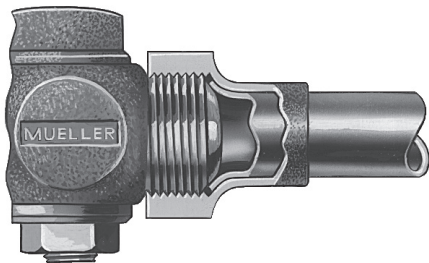

- **Connection** - Meets all applicable parts of AWWA C800 standard.
- **Mueller Co.** - was instrumental in introducing the copper flare connection to the water industry as an alternative to the old lead connections.
- **Pressure Rating** - The pressure holding capability of the Mueller Copper Flare Connection is designed to be greater than that of the valve or fitting on which it is used (only in potable water distribution applications complying with AWWA standards).
- **Mueller® Copper Flare Connection** - is for use on type "K" copper tubing.
- **Convex Surface** - in nut opposes convex surface on body to provide a line contact, assuring greater pullout resistance and a dependable seal.
- **Extra Long Skirt** - on copper flare nut provides added support to tubing and reduces possibility of leaks.

Pack Joint Connection

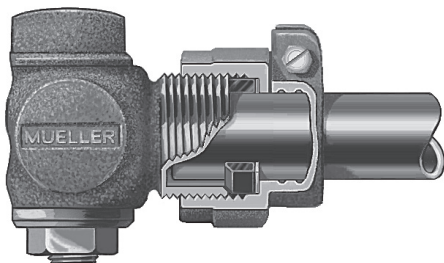

- **Nut** - corrosion resistant cast bronze ASTM B62 (85-5-5-5).
- **Gasket** - compressed against the fitting and pipe outer surface by tightening of nut. Not interchangeable with the Mueller 110 Compression Connection gasket.
- **Mueller PACK JOINT Connection** - available in three styles: for type "K" copper and PE tubing (CTS), for IPS PE (PEP) and PVC pipe.
- **3/4" & 1" CTS Nut/Gasket Are Interchangeable** - with comparable size of Mueller 110® Compression Connections nut/gasket assembly CTS only. (Note that 1-1/2" and 2" CTS components and all sizes of IPS components are NOT interchangeable.)
- **Pressure Rating** - The pressure holding capability of the Mueller Pack Joint Connection is designed to be greater than that of the valve or fitting on which it is used (only in potable water distribution applications complying with AWWA standards).

Mueller® Grip Compression Connection

The Mueller® Grip Compression Connection is a stab connection with large wrench flats. It is available in CTS and IPS. Products can be ordered by adding a "G" in front of an existing compression connection Part Number (EX: B25008N to G25008N).

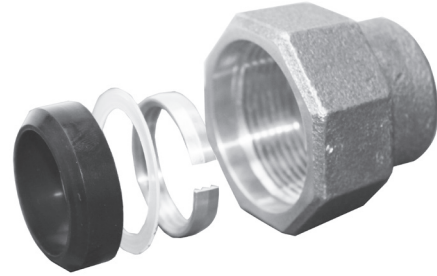
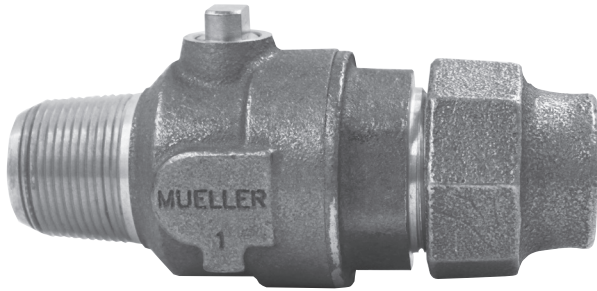

- **Pressure Rating** -The pressure holding capability of the Mueller Grip Compression Connection is designed to be greater than that of the valve or fitting on which it is used (only in potable water distribution applications complying with AWWA standards).
- **Gasket** - compressed against the fitting and pipe outer surface by tightening of nut.
- **Mueller Grip Compression Connection** - available for type "K" copper and PE tubing (CTS) and IPS PE pipe.
- **Interchangeable** - with 110® CTS Compression Connection in 3/4" - 1" or CTS Pack Joint in 3/4" - 2". IPS with 3/4" and 1" PEP Pack Joint.
- **Nut** - corrosion resistant cast bronze.

Grip Joint kits

Size	Kit	Grip ring	Washer	Gasket	Connection nut
3/4" CTS	682861	312919	311692	537881	537838
1" CTS	682862	312920	311695	537882	537839
1-1/2" CTS	682863	312921	538107	537883	537840
2" CTS	682864	312922	538108	538109	537841
3/4" IPS	683023	313094	313695	311869	538320
1" IPS	683024	313095	312122	313098	538321

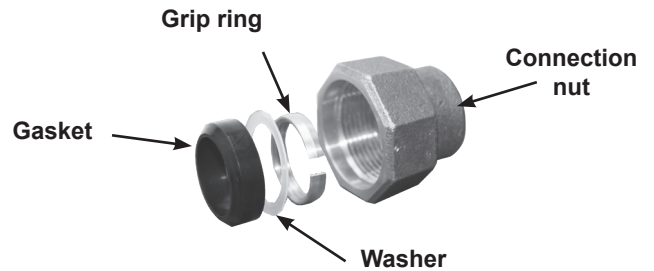

Mueller KITEC® Compression Connection

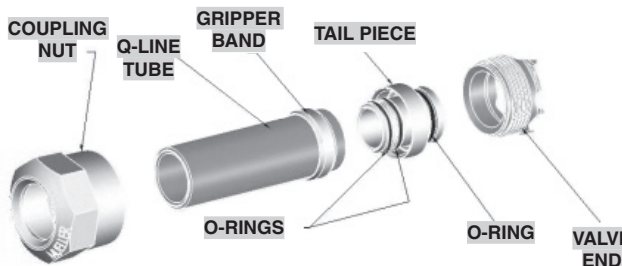

Fig. 1

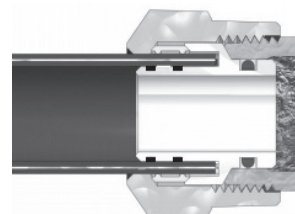

Fig. 2

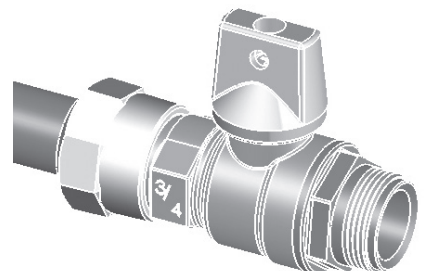

Fig. 3

6.4



SERVICE FITTINGS WITH COPPER FLARE CONNECTION

Rev. 4-14 Shaded area indicates changes

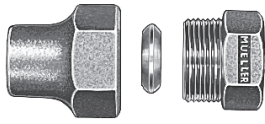

Two Part Union
Copper flare nut x female copper flare thread

H-15405N

3/4"	1"	1-1/2"	2"
------	----	--------	----

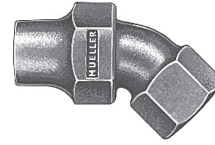

Eighth bend coupling
Copper flare nut x F.I.P.

H-15455N

3/4"	1" ‡
------	------

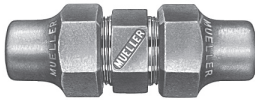

Straight three part union
Copper flare nut—both ends

H-15400N

1/2"	5/8"	5/8" x 1/2"	5/8" x 3/4"	3/4"	3/4" x 1/2"
3/4" x 1"	1"	1-1/4"	1-1/4" x 1"	1-1/2"	2"

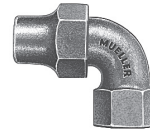

Quarter bend coupling
Copper flare nut x F.I.P.

H-15460N

3/4"	1"	1" x 3/4"	1-1/4" ‡	1-1/2" ‡	2"
------	----	-----------	----------	----------	----

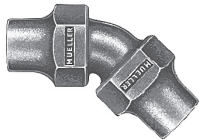

Eighth bend three part union
Copper flare nut—both ends

H-15522N

3/4"	1"
------	----

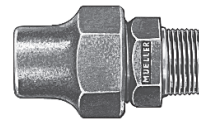

Straight coupling
Copper flare nut x M.I.P.

H-15425N

1/2" ‡	1/2" x 3/4"	5/8" x 3/4"	3/4"	5/8" x 1/2"	3/4" x 1/2"
3/4" x 1"	1"	1" x 3/4"	1" x 1-1/4" ‡	1-1/4"	1-1/2"
					2"

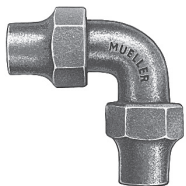

Quarter bend three part union
Copper flare nut—both ends

H-15525N

3/4"	3/4" x 1"	1"	1-1/2"	2"
------	-----------	----	--------	----

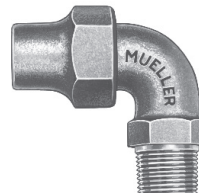

Quarter bend coupling
Copper flare nut x M.I.P.

H-15530N

1/2" ‡	3/4"	3/4" x 1"	1"	1" x 3/4"	1-1/2" ‡	2"
--------	------	-----------	----	-----------	----------	----

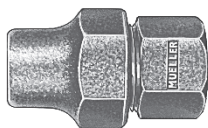

Straight coupling
Copper flare nut x F.I.P.

H-15450N

1/2"	1/2" x 3/4" ‡	5/8" x 3/4"	3/4"	3/4" x 1/2"	1"
1" x 3/4"	1-1/4"	1-1/2"	2"		

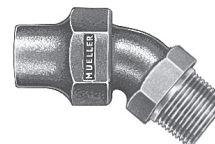

Eighth bend coupling
M.I.P x copper flare nut

H-15539N

3/4"	1"
------	----

NOTE: Sizes shown above represent normal size of fitting. When two sizes are given, the first is size of copper flare nut and second is size of threaded end. ‡Requires minimum ordering quantity. Contact MUELLER Customer Service Center for minimum ordering requirements and availability.

Mueller Service Tees are manufactured and tested in accordance with ANSI/AWWA C800. Components in contact with potable water will also comply with latest requirements of the Federal Safe Drinking Water Act.

Shaded area indicates change Rev. 8-15

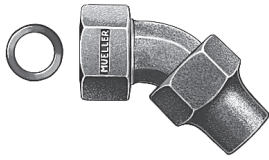

Eighth bend coupling
Swivel nut with female copper flare thread x copper flare nut

H-15064N

3/4"	1"	1-1/2"	2"
------	----	--------	----



Eighth bend coupling
Swivel nut with female Mueller® Coupling thread x copper flare nut

H-15486N

3/4"	1"
------	----

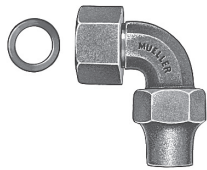

Quarter bend coupling
Swivel nut with female copper flare thread x copper flare nut

H-15069N

3/4"	1"	3/4" x 1"	1-1/2"	2"
------	----	-----------	--------	----



Quarter bend coupling
Swivel nut with female Mueller Coupling thread x copper flare nut

H-15491N

1/2" x 3/4"	5/8" x 3/4"	3/4"	3/4" x 1"	1"
-------------	-------------	------	-----------	----

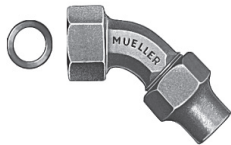

Eighth bend coupling
Swivel nut with female increasing I.P. thread (this thread is one size larger than nominal size of fitting) x copper flare nut

H-15471N

3/4"	1" ‡
------	------



Straight coupling
Female copper flare thread x copper flare nut

H-15062N

3/4"x1"	1"x3/4"	1"x1-1/4"
---------	---------	-----------

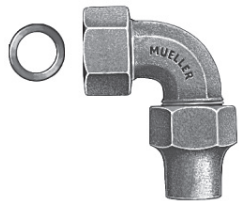

Quarter bend coupling
Swivel nut with female increasing I.P. thread (this thread is one size larger than nominal size of fitting) x copper flare nut

H-15476N

3/4"	1"
------	----

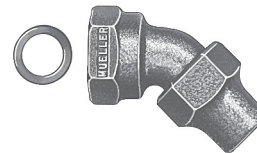

Eighth bend coupling
Female copper flare thread x copper flare nut

H-15063N

3/4"	1"	1-1/2"	2"
------	----	--------	----

Note: Sizes shown above represent nominal size of fitting. When two sizes are listed, the first is the size of threaded end and the second is size of copper flare nut. ‡Requires minimum ordering quantity. Contact MUELLER Customer Center for minimum order requirements and availability.

Mueller Service Tees are manufactured and tested in accordance with ANSI/AWWA C800. Components in contact with potable water will also comply with latest requirements of the Federal Safe Drinking Water Act.

6.6



SERVICE FITTINGS WITH COPPER FLARE CONNECTION

Rev. 4-14 Shaded area indicates changes



Quarter bend coupling
Female copper flare thread x copper flare nut

H-15068N

3/4"	1"	1"x3/4"	1-1/4" ‡	1-1/2"	2"
------	----	---------	----------	--------	----

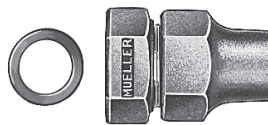

Straight coupling Female
Mueller® Coupling thread x copper flare nut

H-15480N

1/2"x 3/4"	5/8"x 3/4"	3/4"	3/4" x 1"	1"	1" x 3/4"
------------	------------	------	-----------	----	-----------

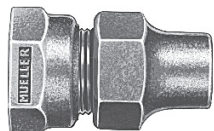

Straight coupling
Female increasing I.P. thread (this thread is one size larger than nominal size of fitting) x copper flare nut

H-15465N

3/4"	1-1/2" ‡
------	----------

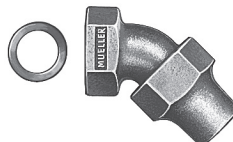

Eighth bend coupling
Female Mueller Coupling thread x copper flare nut

H-15485N

1/2"x3/4"	5/8"x3/4"	5/8" x 1"	3/4"	3/4"x1"	1"	1"x3/4"
-----------	-----------	-----------	------	---------	----	---------

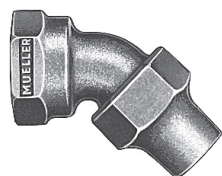

Eighth bend coupling
Female increasing I.P. thread (this thread is one size larger than nominal size of fitting) x copper flare nut

H-15470N

3/4"	1"	1-1/4"	1-1/2"	2"
------	----	--------	--------	----

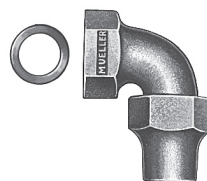

Quarter bend coupling
Female Mueller Coupling thread x copper flare nut

H-15490N

1/2"x3/4"	5/8"x3/4"	3/4"	1"	1"x3/4"
-----------	-----------	------	----	---------

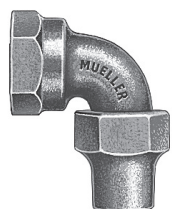

Quarter bend coupling
Female increasing I.P. thread (this thread is one size larger than nominal size of fitting) x copper flare nut

H-15475N

3/4"	1"	1-1/2"	2"
------	----	--------	----

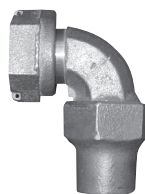

Quarter bend coupling
Internal swivel connection for 110 compression or pack joint CTS x copper flare nut

H-15551N

3/4"	1"
------	----

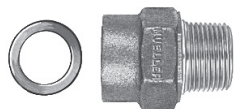

Straight coupling
Female copper flare thread x M.I.P. thread

H-15098N

3/4"	1"
------	----



Straight coupling
Female copper flare thread x F.I.P. thread

H-15082N

3/4"	1"	1-1/2"	2"
------	----	--------	----

NOTE: Sizes shown above represent nominal size of fitting. When two sizes are listed, the first is the size of the threaded end and the second is size of copper flare nut. ‡Requires minimum ordering quantity. Contact MUELLER Customer Service Center for minimum order requirements and availability.

Mueller Service Tees are manufactured and tested in accordance with ANSI/AWWA C800. Components in contact with potable water will also comply with latest requirements of the Federal Safe Drinking Water Act.

Shaded area indicates change Rev. 3-16

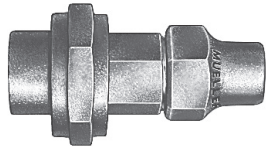

Straight union
Extra strong (XS) lead flange
coupling x copper flare nut

H-15506N

1/2"	1/2" x 3/4"	5/8" x 3/4"	3/4"	3/4" x 5/8"
------	-------------	-------------	------	-------------

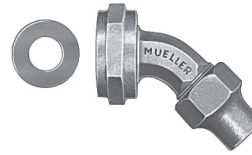

Eighth bend coupling
Swivel nut with female extra
strong (XS) lead flange thread
x copper flare nut

H-15516N

5/8" x 3/4"	3/4"	2"
-------------	------	----

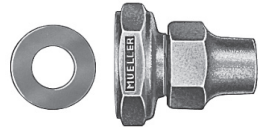

Straight coupling
Female extra strong (XS)
lead flange thread x copper
flare nut

H-15505N

1/2"	1/2" x 3/4"	5/8"	5/8" x 3/4"	3/4"
3/4" x 1"	1"	1" x 3/4"	1-1/4" x 1"	1-1/2" 2"

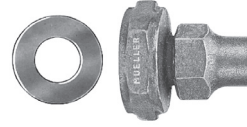

Straight coupling
Female double extra strong
(XXS) lead flange thread x
copper flare nut

H-15510N

5/8" x 3/4"	3/4"	2"
-------------	------	----

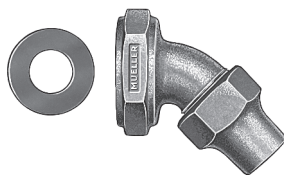

Eighth bend coupling
Female extra strong (XS) lead
flange thread x copper flare nut

H-15515N

5/8" x 3/4"	3/4"	1"
-------------	------	----

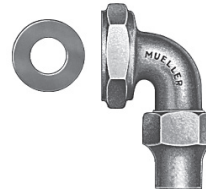

Quarter bend coupling
Female extra strong (XS)
lead flange thread x copper
flare nut

H-15513N

1/2"x3/4"	5/8"x3/4"	3/4"	1"‡	1"x3/4"
-----------	-----------	------	-----	---------

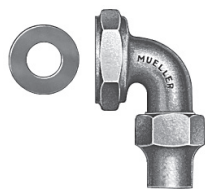

Quarter bend coupling
Female extra strong (XS)
lead flange thread x copper
flare nut (pre-1920)

H-15513-03N

1"x3/4"

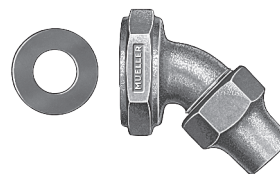

Eighth bend coupling
Female double extra strong
(XXS) lead flange thread x
copper flare nut

H-15521N

1/2" x 3/4"	3/4"
-------------	------

NOTE: Sizes shown above represent nominal size of fitting. When two sizes are given, first is size of lead flange end and second is size of copper flare nut.
‡Requires minimum ordering quantity. Contact MUELLER Customer Service Center for minimum ordering requirements and availability.

Mueller Service Tees are manufactured and tested in accordance with ANSI/AWWA C800. Components in contact with potable water will also comply with latest requirements of the Federal Safe Drinking Water Act.

Rev. 9-17 Shaded area indicates changes

Copper flare connection optional equipment

Copper flare nut



CATALOG NUMBER: **H-15430**

1/2"	3/4"	1"	1-1/4"	1-1/2"	2"
------	------	----	--------	--------	----

Solid copper disc

Used with regular copper flare nut to shut off line.



CATALOG NUMBER: **H-15535**

1/2"	3/4"	1"	1-1/4"	1-1/2"	2"
------	------	----	--------	--------	----

Brass cap

Used with regular copper flare nut to shut off line. Fits on copper flare spud to cap off line.



CATALOG NUMBER: **H-15540N**

3/4"	1"	1-1/2"	2"
------	----	--------	----

Flaring tool

Used to make 45° flare on type "K" copper tubing.



CATALOG NUMBER: **H-18000**

1/2"	5/8"	3/4"	1"	1-1/4"	1-1/2"	2"
------	------	------	----	--------	--------	----

Drilled flaring tool

Used to make 45° flare on type "K" copper tubing without shutting off water drilled to exhaust water at right angle to tubing.



CATALOG NUMBER: **H-18005**

3/4"	1"
------	----

Reamer

Used to ream the inside of type "K" copper tubing to remove burrs prior to flaring.



CATALOG NUMBER: N/A

1/2"	3/4"	1"
------	------	----

Brass Hammer

Solid brass head with 10" wooden handle. Weight 2-3/4 lb. CATALOG NUMBER: **H-18025**



Note: When using any striking tool, safety eye protection must be worn. Inspect hammer and tools for any damage after each use and repair or replace if mushrooming or chipping is evident.

Copper Gasket



Replacement gasket to be used inside Female Copper Service Thread when assembling Fitting onto a Corporation Valve/Stop. Gasket is intended for single use only and must be replaced if Fitting is disassembled or reused.

CATALOG NUMBER: **H-15053**

1/2"	5/8"	3/4"	1"	1-1/4"	1-1/2"	2"
------	------	------	----	--------	--------	----

Pulling coupling - 3/4" & 1"

For replacing iron pipe with copper service pipe. Copper and iron pipes are joined, iron is pulled through, leaving copper in place. Coupling is steel. One end has Inside I.P. Thread, other end has Copper Service Pipe Connection. Spud and nut have flat surfaces to provide firm grip for wrench.



CATALOG NUMBER: **H-18030**

Shaded area indicates change Rev. 10-14

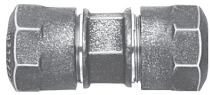

H-15403N

Straight three part union
Mueller 110® Conductive
Compression Connection for
CTS O.D.* tubing-both ends

1/2"	1/2"x3/4"	5/8"x3/4"	5/8"	3/4"	1"
1"x3/4"	1-1/4"	1-1/4"x1"	1-1/2"	1-1/2"x1"	2"

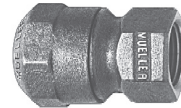

H-15451N

Straight coupling
Mueller 110 Conductive Com-
pression Connection for CTS
O.D.* tubing x F.I.P. thread

1/2"	1/2" x 3/4"	5/8" x 3/4"	3/4"	3/4" x 1/2"	3/4" x 1"
1"	1" x 3/4"	1" x 1-1/4"	1-1/4"	1-1/4" x 1"	1-1/2"
1-1/2" x 1"		2"	2" x 1-1/2"		

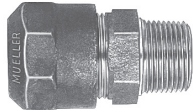

H-15428N

Straight coupling
Mueller 110 Conductive
Compression Connection for
CTS O.D.* tubing x M.I.P.
thread

1/2"‡	1/2" x 3/4"	5/8" x 3/4"	3/4"	3/4" x 1/2"	3/4" x 1"
1"	1" x 3/4"	1-1/4"	1-1/4" x 1"		1-1/2"
1-1/2" x 1"		1-1/2" x 2"	1" x 2"	2"	2" x 1-1/2"



H-15429N

Straight coupling
Mueller 110 Compression
Connection for IPS PE* pipe
x M.I.P. thread

3/4"	1"	1"x3/4"
------	----	---------

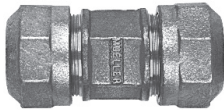

H-15404N

Straight three part union
Mueller 110® Compression
Connection for IPS PE*
pipe-both ends

3/4"	1"	1"x3/4"
------	----	---------

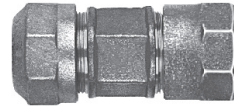

H-15409N

Straight coupling three part union
Mueller 110 Conductive
Compression Connection
for CTS O.D.* tubing x 110
Compression Connection for
IPS PE* pipe

3/4"	3/4"x1"	1"	1"x3/4"
------	---------	----	---------

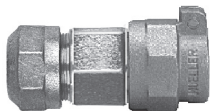

E-15409N

Straight coupling
Mueller 110 Conductive
Compression Connection for
CTS O.D. tubing x Pack Joint
Connection for IPS PE pipe
***Note: 3/4" size only may also be used
on PVC*

3/4"***	3/4"x1"	1"	1"x3/4"
---------	---------	----	---------

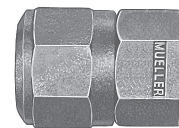

H-15454N

Straight coupling
Mueller 110 Compression
Connection for IPS PE* pipe
x F.I.P. thread

3/4"	1"	1"x3/4"
------	----	---------



H-15413N

Straight Female coupling
Mueller Coupling Thread
Swivel x 110 CTS Conductive
Compression Connection for
CTS O.D.

1"



H-15079N

Straight coupling
Mueller 110 Conductive
Compression Connection for
CTS O.D. tubing x copper
flare nut

3/4"	1"
------	----

*See chart on page 6.11 for tubing and pipe that may be used with these connections.

‡Requires minimum ordering quantity. Contact MUELLER Customer Service Center for minimum ordering requirements and availability.

NOTE: Sizes shown above represent nominal size of fitting. When two sizes are given, first is size of MUELLER 110 Compression Connection and second is size of threaded end.

6.10



SERVICE FITTINGS WITH MUELLER 110[®] COMPRESSION CONNECTION

Rev. 1-17 Shaded area indicates changes

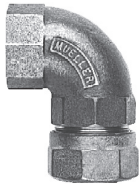

Quarter bend coupling
Mueller 110 Conductive
Compression Connection for
CTS O.D.* tubing x F.I.P. thread

H-15533N

3/4"	3/4" x 1"	1"	1" x 3/4"	1-1/2"	2"
------	-----------	----	-----------	--------	----

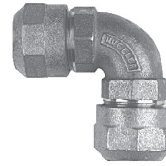

Quarter bend union
Mueller 110 Conductive
Compression Connection for
CTS O.D.* tubing - both ends

H-15526N

3/4"	1"	1" x 3/4"	1-1/2"	2"
------	----	-----------	--------	----

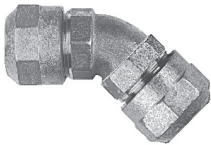

Eight bend coupling
Mueller 110[®] Conductive
Compression Connection for
CTS O.D.* tubing - both ends

H-15528N

3/4"	1"
------	----

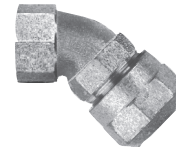

Eight bend union
Mueller 110 Conductive
Compression Connection for
CTS O.D.* tubing x F.I.P. thread

H-15534N

3/4"	1"
------	----

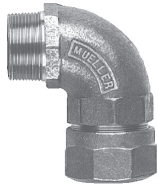

Quarter bend coupling
Mueller 110 Conductive
Compression Connection for
CTS O.D.* tubing x M.I.P.
thread

H-15531N

3/4"	3/4" x 1"	1"	1-1/2"	2"
------	-----------	----	--------	----

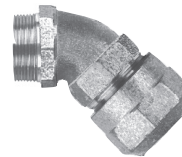

Eight bend coupling
Mueller 110 Conductive
Compression Connection for
CTS O.D.* tubing x M.I.P.
thread

H-15529N

3/4"	1"
------	----



Quarter bend union
Internal swivel connection for
110 compression or pack joint
CTS x Mueller 110 Conductive
Compression Connection for
CTS O.D.* tubing

H-15550N

3/4"	1"
------	----



Straight coupling
Female Mueller Coupling thread
x Mueller 110 Conductive
Compression Connection for
CTS O.D.* tubing

H-15481N

1/2"x3/4"	5/8"x3/4"	3/4"	1"
-----------	-----------	------	----

*See chart on page 6.11 for tubing and pipe that may be used with these connections.

Shaded area indicates change Rev. 12-18

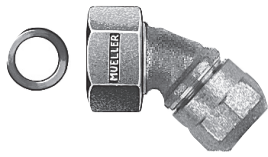

H-15487N

Eight bend coupling
Mueller 110® Conductive
Compression Connection
Type K x swivel nut with
female Mueller
coupling thread

3/4"	1"
------	----

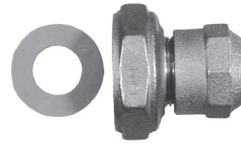

H-15512N

Straight coupling
Mueller 110 Conductive
Compression Connection for
CTS O.D.* tubing x Double
Extra Strong (XXS) lead
flange thread

3/4"	1"
------	----



H-15067N

Quarter bend coupling
Mueller 110® Conductive
Compression Connection for
CTS O.D.* tubing x female
copper flare thread

3/4"	
------	--

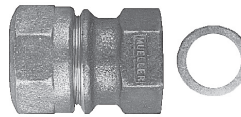

H-15072N

Straight coupling
Mueller 110 Compression
Connection for IPS PE* pipe
x female copper flare thread

3/4"	1"
------	----

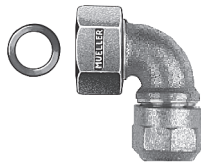

H-15076N

Quarter bend coupling
Mueller 110 Conductive
Compression Connection for
CTS O.D. * tubing x swivel nut
with female copper thread

3/4"	1"x3/4"	1"	1 1/2"	2"
------	---------	----	--------	----

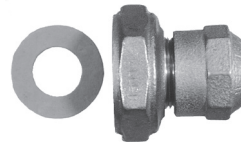

H-15509N

Straight coupling
Mueller 110 Conductive
Compression Connection
for CTS O.D.* tubing x Extra
strong (XS) lead flange thread

1/2" x 3/4"	5/8" x 3/4"***	3/4"	1" x 3/4"	1"
-------------	----------------	------	-----------	----

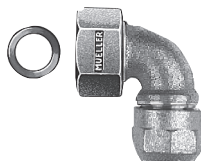

H-15492N

Quarter bend coupling
Mueller 110 Conductive Com-
pression Connection for CTS
O.D. * tubing x swivel nut with
female Mueller
coupling thread

3/4"	1"
------	----

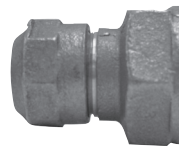

H-15077N

Straight coupling
Mueller 110 Conductive
Compression Connection for
CTS O.D.* tubing x female
IPS PE Connection

1"	
----	--

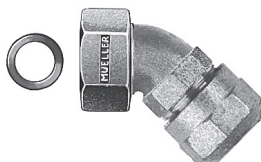

H-15075N

Eighth bend coupling
Mueller 110 Conductive
Compression Connection for
CTS O.D. * tubing x swivel
nut with female copper thread

3/4"	1"	1-1/2"	2"
------	----	--------	----

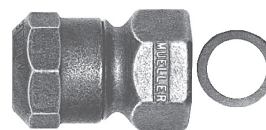

H-15071N

Straight coupling
Mueller 110 Conductive
Compression Connection for
CTS O.D.* tubing x female
copper flare thread

1/2"	5/8"	3/4"	3/4" x 1"	1"	1" x 3/4"
1" x 1-1/4"			1-1/4"	1 1/2"	2"

*See chart on page 6.11 for tubing and pipe that may be used with these connections.

**When two sizes are given, first is size of lead flange thread and second is size of MUELLER 110 Compression Connection.

NOTE: Sizes shown above represent nominal size of fitting. When two sizes are given, first is size of MUELLER 110 Compression Connection and second is size of threaded end.

Rev. 9-17 Shaded area indicates changes

Tubeing, pipe and liners used with Mueller 110 Compression Connection

Nominal size of connection	Material*	Tubeing or pipe O.D. range - inches	Tubeing or pipe wall thickness range - inches	Tubeing or pipe I.D. range - inches	Liner part number
1/2" CTS	Type "K" copper	0.622 - 0.628	0.045 - 0.053	-	-
3/4" CTS	Type "K" copper	0.872 - 0.878	0.061 - 0.069	-	-
	Polyethylene	0.871 - 0.879	0.097 - 0.107	0.657 - 0.685	504281
1" CTS	Type "K" copper	1.121 - 1.129	0.061 - 0.069	-	-
	Polyethylene	1.120 - 1.130	0.125 - 0.137	0.846 - 0.880	504385
1-1/4" CTS	Type "K" copper	1.371 - 1.379	0.060 - 0.070	-	-
	Polyethylene	1.370 - 1.380	0.153 - 0.168	1.034 - 1.074	505142
1-1/2" CTS	Type "K" copper	1.621 - 1.630	0.067 - 0.077	-	-
	Polyethylene	1.619 - 1.631	0.181 - 0.199	1.221 - 1.269	506139
2" CTS	Type "K" copper	2.120 - 2.130	0.076 - 0.090	-	-
	Polyethylene	2.119 - 2.131	0.236 - 0.260	1.599 - 1.659	506141
3/4" IPS	Polyethylene	1.045 - 1.110	0.118 - 0.138	0.809 - 0.834	505141
1" IPS	Polyethylene	1.329 - 1.399	0.150 - 0.170	1.029 - 1.059	505142

*Type "K" soft copper tubeing per ASTM B88; CTS polyethylene (PE) per ASTM D-2737 - SDR-9; IPS polyethylene (PE) per ASTM D-2239 - PE SDR-7; IPS polyvinylchloride (PVC) per ASTM D1785



Liner

Mueller 110 Compression Connection Replacement Parts

Size	Gasket part number†	Connection nut
1/2" CTS	681516	147542
3/4" CTS	581949	507831
1" CTS	581951	507835
1-1/4" CTS	581953	507843
1-1/2" CTS	581955	507847
2" CTS	581957	507851
3/4" IPS	89599	508826
1" IPS PE	89788	508827



Gasket assembly



Nut

†Gasket and gripper band assembly

Adapter Nut for pre-1976 style Mueller 110 Compression Connection for CTS tubeing

Kit includes one standard Gasket (same used with current style 110 connections) and a special Nut that adapts to the older style connection threads on the fittings. It is installed in the same way as the current style connection (Gasket conductor spring should be toward fitting body).

Size	Connection kit
3/4" CTS	682552
1" CTS	682551



Copper Gasket

Replacement gasket to be used inside Female Copper Service Thread when assembling Fitting onto a Corporation Valve/Stop. Gasket is intended for single use only and must be replaced if Fitting is disassembled or reused. CATALOG NUMBER: **H-15053**



1/2"	5/8"	3/4"	1"	1-1/4"	1-1/2"	2"
------	------	------	----	--------	--------	----

Shaded area indicates change Rev. 1-19



Straight three part union
Mueller Grip for CTS O.D.*
tubing-both ends

G-15403N

3/4"	1"
------	----



Straight coupling
Mueller Grip for CTS O.D.*
tubing x F.I.P. thread

G-15451N

3/4"	1"
------	----



Straight coupling
Mueller Grip for CTS O.D.*
tubing x M.I.P. thread

G-15428N

3/4"	1"
------	----



Straight coupling three part union
Mueller Grip for CTS O.D.*
tubing x 110 Compression
Connection for IPS PE* pipe

G-15409N

3/4"	1"
------	----



Straight coupling
Mueller Grip for CTS
O.D. tubing x Pack Joint
Connection for IPS PE pipe
***Note: 3/4" size only may also be used
on PVC*

G-15409N

3/4"***	1"
---------	----



Straight Female coupling
Thread Swivel x Mueller Grip
for CTS O.D. tubing

G-15413N

1"	
----	--



Straight coupling
Mueller Grip for CTS O.D.
tubing x copper flare nut

G-15079N

3/4"	1"
------	----

*See chart on page 6.11 for tubing and pipe that may be used with these connections.

‡Requires minimum ordering quantity. Contact MUELLER Customer Service Center for minimum ordering requirements and availability.

NOTE: Sizes shown above represent nominal size of fitting. When two sizes are given, first is size of MUELLER 110 Compression Connection and second is size of threaded end.

6.14



SERVICE FITTINGS WITH MUELLER GRIP COMPRESSION CONNECTION

Rev. 1-19 Shaded area indicates changes

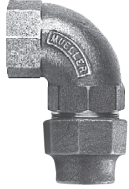

Quarter bend coupling
Mueller Grip for CTS O.D.*
tubing x F.I.P. thread

G-15533N

3/4"	1"
------	----

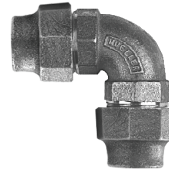

Quarter bend union
Mueller Grip for CTS O.D.*
tubing - both ends

G-15526N

3/4"	1"
------	----

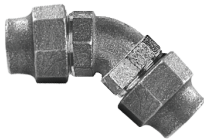

Eight bend coupling
Mueller Grip for CTS O.D.*
tubing - both ends

G-15528N

3/4"	1"
------	----

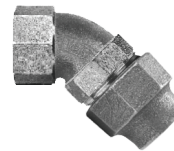

Eight bend union
Mueller Grip for CTS O.D.* tubing
x F.I.P. thread

G-15534N

3/4"	1"
------	----

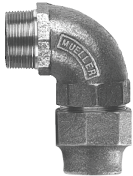

Quarter bend coupling
Mueller Grip for CTS O.D.*
tubing x M.I.P. thread

G-15531N

3/4"	1"
------	----

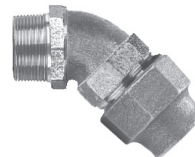

Eight bend coupling
Mueller Grip for CTS O.D. *
tubing x M.I.P. thread

G-15529N

3/4"	1"
------	----



Quarter bend union
Internal swivel connection for
110 compression or pack joint
CTS x Mueller Grip for CTS
O.D.* tubing

G-15550N

3/4"	1"
------	----



Straight coupling
Female Mueller Coupling thread
x Mueller Grip for CTS O.D.*
tubing

G-15481N

3/4"	1"
------	----

*See chart on page 6.11 for tubing and pipe that may be used with these connections.

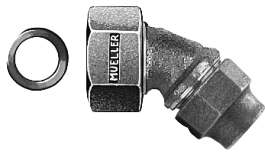

Eight bend coupling
Mueller Grip for CTS O.D.*
tubing Type K x swivel nut
with female Mueller
coupling thread

G-15487N

3/4"	1"
------	----

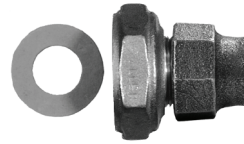

Straight coupling
Mueller Grip for CTS O.D.*
tubing x Double Extra Strong
(XXS) lead flange thread

G-15512N

3/4"	1"
------	----



Quarter bend coupling
Mueller Grip for CTS O.D.*
tubing x female copper flare
thread

G-15067N

3/4"	
------	--

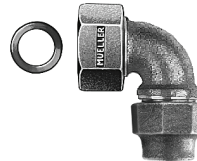

Quarter bend coupling
Mueller Grip for CTS O.D.*
tubing x swivel nut with
female copper thread

G-15076N

3/4"	1"
------	----

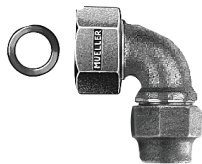

Quarter bend coupling
Mueller Grip for CTS O.D.*
tubing x swivel nut
with female Mueller
coupling thread

G-15492N

3/4"	1"
------	----

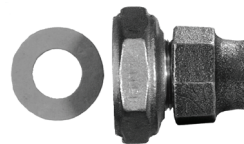

Straight coupling
Mueller Grip for CTS O.D.*
tubing x Extra strong (XS)
lead flange thread

G-15509N

3/4"	1"
------	----

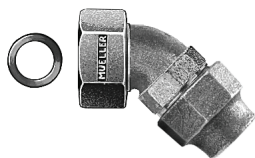

Eighth bend coupling
Mueller Grip for CTS O.D.*
tubing x swivel nut with
female copper thread

G-15075N

3/4"	1"
------	----

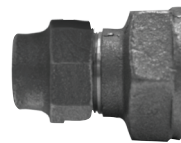

Straight coupling
Mueller Grip for CTS O.D.*
tubing x female IPS PE
Connection

G-15077N

1"	
----	--

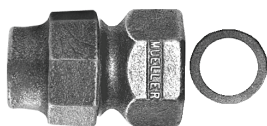

Straight coupling
Mueller Grip for CTS O.D.*
tubing x female copper flare
thread

G-15071N

3/4"	1"
------	----

*See chart on page 6.11 for tubing and pipe that may be used with these connections.

** When two sizes are given, first is size of lead flange thread and second is size of MUELLER 110 Compression Connection.

NOTE: Sizes shown above represent nominal size of fitting. When two sizes are given, first is size of MUELLER 110 Compression Connection and second is size of threaded end.



Straight three part union
Mueller Pack Joint Connection
for CTS O.D.* tubing -
both ends

P-15403N

3/4"	1"	1" x 3/4"	1-1/4"	1-1/2"	1-1/2" x 1"	2"
------	----	-----------	--------	--------	-------------	----



Quarter bend coupling
Mueller Pack Joint
Connection for CTS O.D.*
tubing x F.I.P. thread

P-15533N

3/4"	1"	1" x 3/4"	1-1/2"	2"
------	----	-----------	--------	----

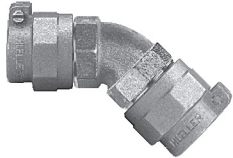

Eighth bend union
Mueller Pack Joint
Connection for CTS O.D.*
tubing - **both ends**

P-15528N

3/4"	1"
------	----

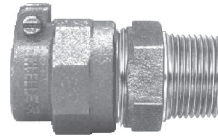

Straight coupling
Mueller Pack Joint
Connection for CTS O.D.*
tubing x M.I.P. thread

P-15428N

1/2"	3/4"	3/4" x 1/2"	5/8" x 3/4"	3/4" x 1"
1"	1-1/4"	1" x 3/4"	1-1/4" x 1"	1-1/2"
1-1/2" x 1"	1-1/2" x 2"	2"	2" x 1-1/2"	

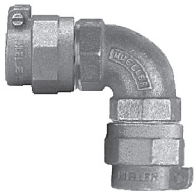

Quarter bend union
Mueller Pack Joint
Connection for CTS O.D.*
tubing - **both ends**

P-15526N

3/4"	1"	1" x 3/4"	1-1/2"	2"
------	----	-----------	--------	----

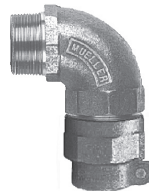

Quarter bend coupling
Mueller Pack Joint
Connection for CTS O.D.*
tubing x M.I.P. thread

P-15531N

3/4"	3/4" x 1"	1"	1" x 3/4"	1-1/2"	2"
------	-----------	----	-----------	--------	----

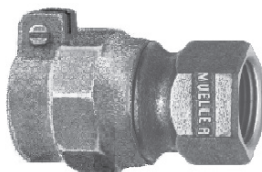

Straight coupling
Mueller Pack Joint
Connection for CTS O.D.*
tubing x F.I.P. thread

P-15451N

3/4"	3/4" x 1"	1"	1" x 3/4"	1-1/2"	2"	2" x 1-1/2"
------	-----------	----	-----------	--------	----	-------------



Quarter bend coupling
Female Mueller Coupling
thread x PJ for CTS O.D.*
tubing

P-15493N

1/2" x 3/4"	3/4"	1"
-------------	------	----

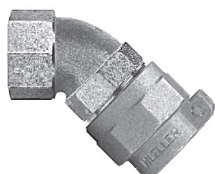

Eighth bend coupling
Mueller Pack Joint
Connection for CTS O.D.*
tubing x F.I.P. thread

P-15534N

3/4"	1"	1" x 1-1/4"
------	----	-------------

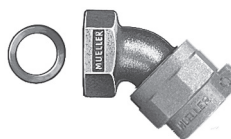

Eighth bend coupling
Female Mueller Coupling
thread x PJ for
CTS O.D.* tubing

P-15485N

1"

*See chart on page 6.15 for tubing and pipe that may be used with these connections.

NOTE: Sizes shown above represent nominal size of fitting. When two sizes are given, first is size of MUELLER Pack Joint Connection and second is size of threaded end.

SERVICE FITTINGS WITH MUELLER® PACK JOINT CONNECTION

Rev. 1-16 Shaded area indicates changes

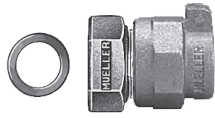

P-15481N

Straight coupling
Female Mueller Coupling
thread x PJ for CTS O.D.*
tubing

1/2"x3/4"	5/8"x3/4"	3/4"	1"
-----------	-----------	------	----

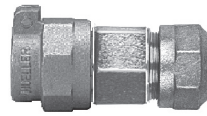

V-15445N

Straight coupling
Mueller Pack Joint Connection
for IPS PVC pipe x Mueller
110® Conductive Compression
Connection for CTS O.D.*
tubing. 2 pc. const. Assembled
wrench tight.

2"



E-15404N

Straight coupling
Mueller Pack Joint
Connection for IPS PE pipe -
both ends
***Note: 3/4" size only may also be used
on PVC*

3/4"***	1"	1"x3/4"	1-1/4"	1-1/2"	2"
---------	----	---------	--------	--------	----



V-15401N

Straight coupling
Mueller Pack Joint
Connection for IPS PVC pipe
- both ends
***Note: 3/4" size only may also be used
with PVC*

1"	1" x 3/4"***	1-1/2"	2"
----	--------------	--------	----



E-15443N

Straight coupling
Mueller Pack Joint
Connection for IPS PE pipe
x Pack Joint Connection for
CTS O.D. tubing
***Note: 3/4" size only may also be used on
PVC*

3/4"***	3/4"***x1"	1"
---------	------------	----



V-15441N

Straight coupling
Mueller Pack Joint
Connection for IPS PVC pipe
x Pack Joint Connection for
CTS O.D.

1"	1"x3/4"	1-1/2"	1-1/2"x3/4"	2"
----	---------	--------	-------------	----

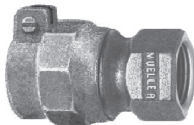

E-15454N

Straight coupling
Mueller Pack Joint
Connection for IPS PE* x
F.I.P. thread
***Note: 3/4" size only may also be used
on PVC*

3/4"***	1"	1"x3/4"***	1-1/4"	1-1/2"	2"
---------	----	------------	--------	--------	----

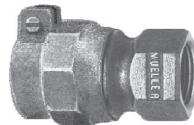

V-15442N

Straight coupling
Mueller Pack Joint
Connection for IPS PVC* pipe
x F.I.P. thread

1"	1"x3/4"	1-1/2"	1-1/2"x3/4"	1-1/2"x1"	2"
----	---------	--------	-------------	-----------	----

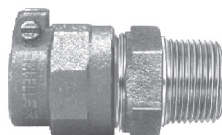

E-15429N

Straight coupling
Mueller Pack Joint
Connection for IPS PE* x
M.I.P. thread
***Note: 3/4" size only may also be used
on PVC*

3/4"***	3/4"***x1"	1"	1"x3/4"	1-1/4"	1-1/2"	2"
---------	------------	----	---------	--------	--------	----

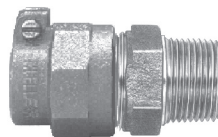

V-15440N

Straight coupling
Mueller Pack Joint
Connection for IPS PVC* pipe
x M.I.P. thread

1"	1"x3/4"	1-1/2"	1-1/2"x3/4"	1-1/2"x1"	2"
----	---------	--------	-------------	-----------	----

*See chart on page 6.15 for tubing and pipe that may be used with these connections.

**Note: 3/4" size only may also be used on PVC

NOTE: Sizes shown above represent nominal size of fitting. When two sizes are given, first is size of MUELLER Pack Joint Connection and second is size of threaded end.

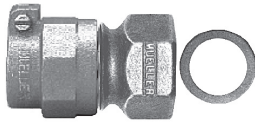

Straight coupling
Mueller Pack Joint
Connection for CTS O.D.*
tubing x female copper flare
thread

P-15071N

3/4"	1"	1" x 3/4"	3/4" x 1"	1-1/2"	2"
------	----	-----------	-----------	--------	----

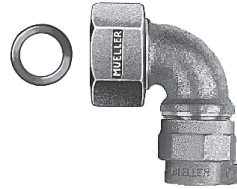

Quarter bend coupling
Mueller Pack Joint
Connection for CTS O.D.*
tubing x swivel nut with female
copper thread

P-15076N

3/4"	1"	1" x 3/4"
------	----	-----------

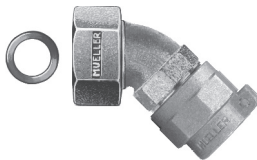

Eighth bend coupling
Mueller Pack Joint
Connection for CTS O.D.*
tubing x swivel nut with
female copper thread

P-15075N

3/4"	1"
------	----

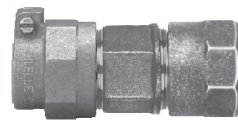

Straight three part union
Mueller Pack Joint Connection for
CTS O.D.* tubing x 110
Compression Connection for
IPS PE* pipe

P-15409N

3/4"	1"
------	----

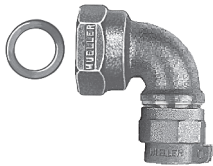

Quarter bend coupling
Mueller Pack Joint
Connection for CTS O.D.*
tubing x female copper
flare thread

P-15067N

3/4"	1" x 3/4"***	1"
------	--------------	----

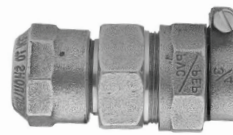

Straight coupling
Mueller 110 Conductive
Compression CTS O.D.
tubing x Pack Joint IPS
PE pipe

E-15409

3/4"	3/4" x 1"	1"	1" x 3/4"
------	-----------	----	-----------



Quarter bend coupling
Mueller Pack Joint
Connection IPS PE pipe
- both ends
***Note: 3/4" size only may also be
used with PVC*

E-15547N

3/4"



Quarter bend coupling
Mueller Pack Joint
Connection IPS PVC pipe
- both ends

V-15111N

1"	1-1/2"	2"
----	--------	----

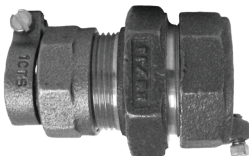

Straight coupling
Mueller Pack Joint
Connection for CTS O.D.*
tubing x steel pipe Pack Joint

P-15421N

3/4"	1"	1"x3/4"
------	----	---------

*See chart on page 6.15 for tubing and pipe that may be used with these connections.

**Note: 3/4" size only may also be used on PVC

NOTE: Sizes shown above represent nominal size of fitting. When two sizes are given, first is size of MUELLER Pack Joint Connection and second is size of threaded end.

Rev. 10-17 Shaded area indicates changes

Tubing, pipe and liners used with Mueller Pack Joint Connection

Nominal size of connection	Material*	Tubing or pipe O.D. range - inches	Tubing or pipe wall thickness range - inches	Tubing or pipe I.D. range - inches	Liner part number
3/4" CTS	Type "K" copper	0.872 - 0.878	0.061 - 0.069	-	-
	Polyethylene	0.871 - 0.879	0.097 - 0.107	0.657 - 0.685	528704
1" CTS	Type "K" copper	1.121 - 1.129	0.061 - 0.069	-	-
	Polyethylene	1.120 - 1.130	0.125 - 0.137	0.846 - 0.880	528705
1-1/2" CTS	Type "K" copper	1.621 - 1.630	0.067 - 0.077	-	-
	Polyethylene	1.619 - 1.631	0.181 - 0.199	1.221 - 1.269	528706
2" CTS	Type "K" copper	2.120 - 2.130	0.076 - 0.090	-	-
	Polyethylene	2.119 - 2.131	0.236 - 0.260	1.599 - 1.659	528707
3/4" IPS	Polyethylene	1.045 - 1.110	0.118 - 0.138	0.809 - 0.834	505141
	3/4" Sch. 40 PVC	1.046 - 1.054	0.113 - 0.133	0.780 - 0.828	509759
	3/4" Sch. 80 PVC	1.046 - 1.054	0.154 - 0.174	0.698 - 0.746	509760
1" IPS	Polyethylene	1.329 - 1.399	0.150 - 0.170	1.029 - 1.059	505142
	1" Sch. 40 PVC	1.310 - 1.320	0.133 - 0.153	-	-
	1" Sch. 80 PVC	1.310 - 1.320	0.179 - 0.200	-	-
1-1/4" IPS	Polyethylene	1.754 - 1.832	0.197 - 0.221	1.360 - 1.390	312787
1-1/2" IPS	Polyethylene	2.05 - 2.141	0.230 - 0.258	1.590 - 1.625	529116
	1-1/2" Sch. 40 PVC	1.894 - 1.906	0.145 - 0.165	-	-
	1-1/2" Sch. 80 PVC	1.894 - 1.906	0.200 - 0.224	-	-
2" IPS	Polyethylene	2.637 - 2.742	0.295 - 0.330	2.047 - 2.082	529117
	2" Sch. 40 PVC	2.369 - 2.381	0.154 - 0.174	-	-
	2" Sch. 80 PVC	2.369 - 2.381	0.218 - 0.244	-	-

*Type "K" soft copper tubing per ASTM B88; CTS polyethylene (PE) per ASTM D-2737 - SDR-9; IPS polyethylene (PE) per ASTM D-2239 - PE SIDR-7; IPS polyvinylchloride (PVC) per ASTM D1785

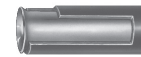

Liner

Liners used with Mueller PVC Pack Joint Connection for OD Controlled PE Pipe

Nominal size of connection	Material	Tubing or pipe O.D. range - inches	Tubing or pipe I.D. range - inches	Length - inches	Liner part number
3/4" IPS	IPS PE OD controlled DR-9	1.046 - 1.054	0.772 - 0.820	2.00	313073
	IPS PE OD controlled DR-11	1.046 - 1.054	0.816 - 0.864	2.00	313074
1" IPS	IPS PE OD controlled DR-9	1.310 - 1.320	.0978 - 1.028	2.125	313084
	IPS PE OD controlled DR-11	1.310 - 1.320	1.030 - 1.080	1.84	505142
1-1/2" IPS	IPS PE OD controlled DR-9	1.894 - 1.906	1.412 - 1.484	3.00	538266
	IPS PE OD controlled DR-11	2.369 - 2.381	2.082 - 2.047	3.20	538267
2" IPS	IPS PE OD controlled DR-9	1.894 - 1.906	1.496 - 1.560	3.00	538269
	IPS PE OD controlled DR-11	2.369 - 2.381	1.885 - 1.949	3.20	538270

Mueller Pack Joint Connection Kit

Size	Connection Kit
3/4" CTS	681921
1" CTS	681922
1-1/2" CTS	681923
2" CTS	681924
3/4" IPS PE	682377
1" IPS PE	682556
1-1/4" CTS	682556
1-1/2" IPS PE	682557
2" IPS PE	682558
3/4" IPS PVC	682377
1" IPS PVC	682553
1-1/2" IPS PVC	682554
2" IPS PVC	682555



Connection Kit
(includes Pack Joint, Gasket and washer)

Copper Gasket

Replacement gasket to be used inside Female Copper Service Thread when assembling Fitting onto a Corporation Valve/ Stop. Gasket is intended for single use only and must be replaced if Fitting is disassembled or reused.



CATALOG NUMBER: **H-15053**

1/2"	5/8"	3/4"	1"	1-1/4"	1-1/2"	2"
------	------	------	----	--------	--------	----



Straight union
Mueller INSTA-TITE
Connection for CTS O.D.* PE
tubing-both ends

H-15406N

3/4"	1"
------	----

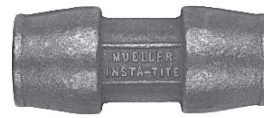

Straight union
Mueller INSTA-TITE
Connection for IPS* PE
pipe- both ends

H-15408N

3/4"	1"
------	----



Straight coupling
Mueller INSTA-TITE
Connection for CTS O.D.*
PE tubing x M.I.P. thread

H-15424N

3/4"	1"
------	----



Straight coupling
Mueller INSTA-TITE
Connection for IPS* PE pipe
x M.I.P. thread

H-15426N

3/4"	3/4"x1"	1"
------	---------	----

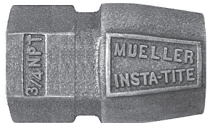

Straight coupling
Mueller INSTA-TITE
Connection for CTS O.D.* PE
tubing x F.I.P. thread

H-15457N

3/4"	1"
------	----

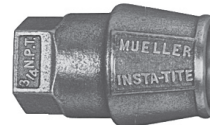

Straight coupling
Mueller INSTA-TITE
Connection for IPS* PE pipe
x F.I.P. thread

H-15456N

3/4"	3/4"x1"	1"
------	---------	----



Straight coupling
Mueller INSTA-TITE
Connection for CTS O.D.* PE
tubing x female copper flare
thread

H-15074N

3/4"	1"
------	----

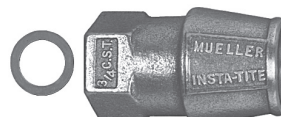

Straight coupling
Mueller INSTA-TITE
Connection for IPS* PE pipe
x female copper flare thread

H-15073N

3/4"	3/4"x1"	1"
------	---------	----



Quarter bend coupling
Mueller INSTA-TITE
Connection for IPS* PE
pipe- both ends

H-15464N

3/4"	1"
------	----



Quarter bend union
Mueller INSTA-TITE
Connection for CTS O.D.*
PE tubing x F.I.P.

H-15468N

3/4"	1"
------	----

* See chart on page 6.17 for tubing and pipe that can be used with these connections.

NOTE: Sizes shown above represent nominal size of fitting. When two sizes are given, first is size of threaded end and second is size of MUELLER INSTA-TITE Connection.

SERVICE FITTINGS WITH MUELLER® INSTA-TITE® CONNECTION

Rev. 3-16 Shaded area indicates changes



Quarter bend union
Mueller INSTA-TITE
Connection for CTS O.D.*
PE tubing x M.I.P.

H-15473N

3/4"	1"
------	----

Polyethylene PE Tubing and pipe used with Mueller INSTA-TITE Connections

Nominal size of connection	Material	Tubing or pipe O.D. range (in.)	Tubing or pipe wall thickness range (in.)	Tubing or pipe I.D. range (in.)
3/4" CTS PE	Polyethylene PE	0.871-0.879	0.097-0.107	0.657-0.685
1" CTS PE	Polyethylene PE	1.120-1.130	0.125-0.137	0.846-0.880
3/4" IPS PE	Polyethylene PE	1.045-1.110	0.118-0.138	0.809-0.834
1" IPS PE	Polyethylene PE	1.329-1.399	0.150-0.170	1.029-1.059

CTS polyethylene (PE) per ASTM D-2737 - SDR-9
IPS polyethylene (PE) per ASTM D-2239 - SDR-7

Mueller INSTA-TITE Connection replacement parts

Size	Gripper ring part number	O-ring part number
3/4" CTS PE (red gripper)	506325	606324
1" CTS PE (red gripper)	506327	506326
3/4" IPS PE (white gripper)	505885	505883
1" IPS PE (white gripper)	505886	505884



Optional tools for use with Mueller INSTA-TITE Connections

Pipe beveling tool

To assure proper installation, the end of the pipe or tubing must be properly beveled before it is inserted into the Mueller INSTA-TITE Connection. Mueller Co. offers a special beveling tool for both CTS PE tubing and IPS PE pipe.



PART NUMBER: **H-18015** for 3/4" and 1" CTS PE tubing
PART NUMBER: **H-18017** for 3/4" and 1" IPS PE pipe

Pipe removal tool

Pipe or tubing may be removed from the Mueller INSTA-TITE Connection using special removal tools. Use one tool for 3/4" size connection and two tools for 1" size.



PART NUMBER: **506336**

Copper Gasket

Replacement gasket to be used inside Female Copper Service Thread when assembling Fitting onto a Corporation Valve/Stop. Gasket is intended for single use only and must be replaced if Fitting is disassembled or reused.



CATALOG NUMBER: **H-15053**

1/2"	5/8"	3/4"	1"	1-1/4"	1-1/2"	2"
------	------	------	----	--------	--------	----

Rev. 9-15 Shaded area indicates changes



Straight coupling
Swivel nut with female increasing I.P. thread (this thread is one size larger than the nominal size of the fitting) x M.I.P. thread.

H-10094N

3/4"

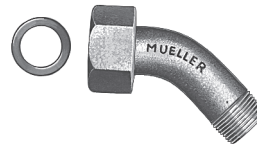

Eighth bend coupling
Swivel nut with female Mueller® Coupling thread x M.I.P. thread

H-10022N

5/8"	3/4"	1"
------	------	----

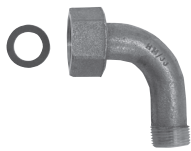

Quarter bend coupling
Swivel nut with female increasing I.P. thread (this thread is one size larger than the nominal size of the fitting) x M.I.P. thread.

H-10096N

3/4"	1"	1-1/4" ‡	1-1/2"	2"
------	----	----------	--------	----

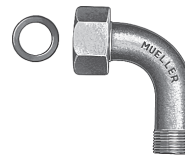

Quarter bend coupling
Swivel nut with female Mueller Coupling thread x M.I.P. thread

H-10023N

5/8"	3/4"	1"
------	------	----

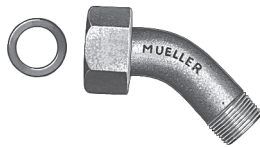

Eighth bend coupling
Swivel nut with female Mueller® Coupling I/S I.P. thread x M.I.P. outlet

H-10095N

1-1/2"	2"
--------	----

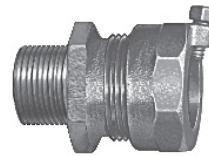

Straight coupling
Compression connection with set screw for use on steel pipe x M.I.P. thread

H-15423-10N

3/4"	1" ‡
------	------

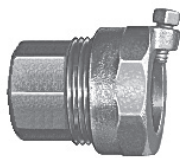

Straight coupling
Compression connection with set screw (drilled for wire seal) for use on steel pipe x F.I.P. thread

H-14233-10N

3/4"	1" ‡
------	------

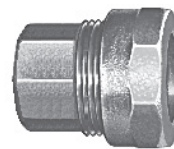

Straight coupling
Compression connection for use on steel pipe x F.I.P. thread

H-14232N

3/4" ‡ *

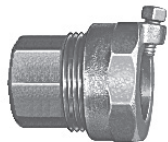

Straight coupling
Compression connection with set screw for use on steel pipe x F.I.P. thread

H-14233N

3/4"	1" ‡
------	------

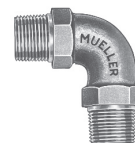

Quarter bend coupling
Mueller Coupling thread M.I.P. thread - **both ends**

H-15538N

3/4"	1"	1-1/2"	2"
------	----	--------	----

* Both ends of coupling are 3/4" size.

‡ Requires minimum ordering quantity. Contact MUELLER Customer Service Center for minimum order requirements and availability.

NOTE: Sizes shown above represent nominal size of fitting.

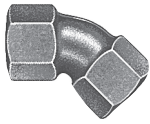

Eighth bend coupling
F.I.P. thread x both ends

H-10076N

3/4"	1"
------	----



Quarter bend coupling
F.I.P. thread x F.I.P. thread
90 degree elbow

H-15541N

3/4"	1"	1-1/2"	2"
------	----	--------	----



Quarter bend coupling
F.I.P. thread x M.I.P. thread
90 degree elbow

H-15542N

3/4"	1"	1-1/2"	2"
------	----	--------	----

* Both ends of coupling are 3/4" size.

‡ Requires minimum ordering quantity. Contact MUELLER Customer Service Center for minimum order requirements and availability.

NOTE: Sizes shown above represent nominal size of fitting.

SERVICE FITTINGS WITH HOSE CLAMP RIBBED INSERT TYPE CONNECTION

Rev. 10-17 Shaded area indicates changes



H-12200N

Straight coupling
Ribbed insert connection for IPS PE pipe (includes 2 stainless steel hose clamps) x female copper flare thread

3/4"	1"
------	----



H-12215N

Straight coupling
Ribbed insert connection for IPS PE pipe (includes 2 stainless steel hose clamps) x F.I.P. thread

3/4"	1"
------	----



H-12203N

Straight coupling
Ribbed insert connection for IPS PE pipe (hose clamps NOT included) x female copper flare thread

3/4"	1"
------	----



H-12218N

Straight coupling
Ribbed insert connection for IPS PE pipe (hose clamps NOT included) x F.I.P. thread

3/4"	1"
------	----



H-12210N

Straight coupling
Ribbed insert connection for IPS PE pipe (includes 2 stainless steel hose clamps) x M.I.P. thread

3/4"	3/4" x 1"	1"
------	-----------	----



Stainless steel hose clamp for 3/4" pipe-
PART NUMBER : 504030

Stainless steel hose clamp for 1" pipe-
PART NUMBER: 504031

504030 - 3/4"
504031 - 1"



H-12213N

Straight coupling
Ribbed insert connection for IPS PE pipe (hose clamps NOT included) x M.I.P. thread

3/4"	1"
------	----

Copper Gasket

Replacement gasket to be used inside Female Copper Service Thread when assembling Fitting onto a Corporation Valve/Stop. Gasket is intended for single use only and must be replaced if Fitting is disassembled or reused.



CATALOG NUMBER: **H-15053**

1/2"	5/8"	3/4"	1"	1-1/4"	1-1/2"	2"
------	------	------	----	--------	--------	----

NOTE: Sizes shown above represent nominal size of fitting.

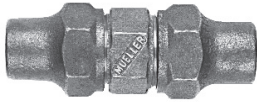

Straight three part union
I.P. threaded copper flare nut
-both ends

H-15402N

3/4"

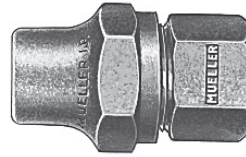

Straight coupling
I.P. threaded copper flare nut
x F.I.P. thread

H-15452N

3/4" ‡	1" ‡
--------	------



Straight coupling
I.P. threaded copper flare nut
x M.I.P. thread

H-15427N

3/4"

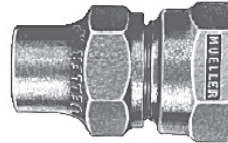

Straight coupling
I.P. threaded copper flare nut
x female increasing I.P. thread
(this thread is one size larger
than nominal size of fitting)

H-15467N

3/4"



Copper flare nut I.P. threaded

H-15432N

3/4"	1"
------	----

FOR OTHER FLARE CONNECTION OPTIONAL EQUIPMENT, SEE PAGE 6.7

‡ Requires minimum ordering quantity. Contact MUELLER Customer Service Center for minimum ordering requirements and availability.
NOTE: Sizes shown above represent nominal size of fitting.

SERVICE FITTINGS WITH LEAD FLANGE CONNECTION

Rev. 10-16 Shaded area indicates changes

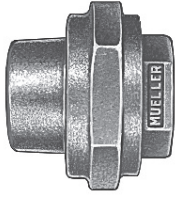

Straight coupling
Extra strong (XS) lead flange coupling x F.I.P. thread

H-10050N

1/2"‡	1/2"x3/4"‡	5/8"x3/4"	5/8" x 1/2"	3/4"	1"	1-1/2"
-------	------------	-----------	-------------	------	----	--------

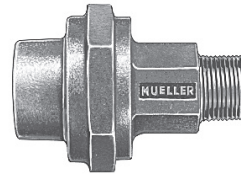

Straight coupling
Extra strong (XS) lead flange coupling x M.I.P. thread

H-10051N

5/8"x3/4"	3/4"
-----------	------

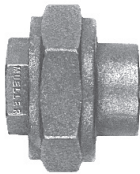

Straight coupling
Extra strong (XS) lead flange coupling -both ends

H-10054N

3/4" ‡

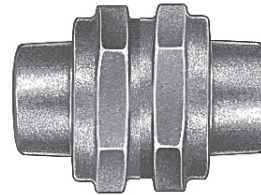

Straight coupling
Double extra strong (XXS) lead flange coupling x F.I.P. thread

H-10052N

1/2"	5/8"	3/4"
------	------	------

‡ Requires minimum ordering quantity. Contact MUELLER Customer Service Center for minimum ordering requirements and availability.

NOTE: Sizes shown above represent nominal size of fitting. When two sizes are given, first is size of lead flange coupling and second is size of threaded connection.

Shaded area indicates change Rev. 1-15

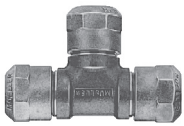

H-15381N

Service tee
Mueller 110 Conductive
Compression Connection for
CTS O.D.* tubing-all ends

3/4"	3/4" x 3/4" x 1"	1"	1" x 3/4" x 3/4"	1" x 1" x 3/4"
1-1/2" x 1-1/2" x 3/4"		1-1/2" x 1-1/2" x 1"		1-1/2" x 1-1/2" x 1-1/2"
2" x 2" x 3/4"		2" x 2" x 1"		2" x 2" x 2"

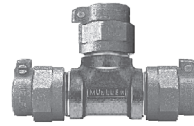

P-15381N

Service tee
Mueller Pack Joint
Compression Connection for
CTS O.D.* tubing-all ends

3/4"	3/4" x 3/4" x 1"	1"	1" x 1" x 3/4"	1-1/2"	2"
1-1/2" x 1-1/2" x 1"		2" x 2" x 3/4"		2" x 2" x 1"	

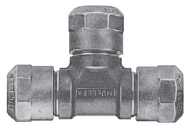

H-15444N

Service tee
Mueller 110 Conductive
Compression Connection for
IPS* PE tubing-all ends

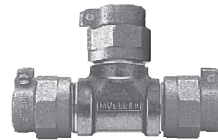

E-15444N

Service tee
Mueller Pack Joint
Connection for IPS PE*
tubing-all ends

3/4"

3/4"

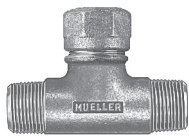

H-15385N

Service tee
M.I.P. thread x M.I.P. thread x
Mueller 110 Conductive
Compression Connection for
CTS O.D.* tubing

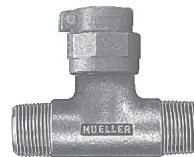

P-15385N

Service tee
M.I.P. thread x M.I.P. thread x
Mueller Pack Joint
Connection for CTS O.D.* tub

3/4"	1"	1"x1"x3/4"
------	----	------------

3/4"	3/4"x3/4"x1"	1"
------	--------------	----

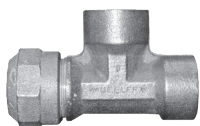

H-15392N

Service tee
F.I.P. thread x F.I.P. thread x
Mueller 110 Conductive

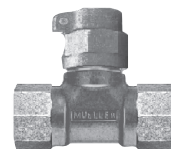

P-15393N

Service tee
F.I.P. thread x F.I.P. thread x
Mueller Pack Joint
Connection for CTS
O.D.*tubing

3/4"	1"
------	----

3/4"	1" ‡
------	------

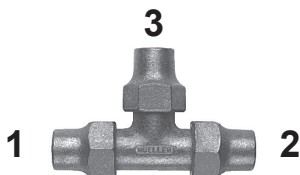

Service tee sizing - sizes of ends are listed in the order shown above - when all three end sizes are the same, only one size is listed.

‡Requires minimum ordering quantity. Contact MUELLER Customer Service Center for minimum ordering requirements and availability.

* See page 6.29 for tubing that can be used with this connection.

Rev. 4-14 Shaded area indicates changes



H-15391N

Service tee
Mueller 110 Conductive
Compression Connection
for CTS O.D.* tubing x 110
Conductive Compression
Connection for CTS O.D.*
tubing x F.I.P. thread

3/4"	1"	2"x2"x1"
------	----	----------



H-15393N

Service tee
Mueller 110 Conductive
Compression Connection
for CTS O.D.* tubing x 110
Conductive Compression
Connection for CTS O.D.*
tubing x Inside CC thread

2"x2"x3/4"	2"x2"x1"
------------	----------

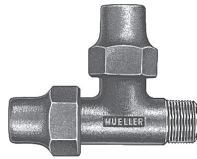

H-15382N

Service tee
Copper flare nut x M.I.P.
thread x copper flare nut

3/4" ‡



H-15384N

Service tee
M.I.P. thread x M.I.P. thread x
copper flare

3/4" ‡



H-15380N

Service tee
Copper flare nut - all ends

1/2" ‡	3/4"	3/4"x3/4"x1"	1"	1" x 3/4" x 3/4"	1" x 1" x 3/4"	1-1/4" ‡
1-1/4" x 1-1/4" x 3/4" ‡		1-1/4" x 1-1/4" x 1" ‡		1-1/2"	1-1/2" x 1-1/2" x 3/4" ‡	
1-1/2" x 1-1/2" x 1"		2"		2" x 2" x 3/4" ‡		2" x 2" x 1"

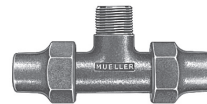

H-15386N

Service tee
Copper flare nut x copper
flare nut x M.I.P. thread

3/4"	3/4"x3/4"x1"	1"
------	--------------	----



H-10097N

Service tee
F.I.P. thread - all ends

1"

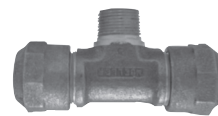

H-15387N

Service tee
Mueller 110 Conductive
Compression Connection
for CTS O.D.* tubing x 110
Conductive Compression
Connection for CTS O.D.*
tubing x M.I.P. thread

3/4"	3/4"x3/4"x1"	1"
------	--------------	----

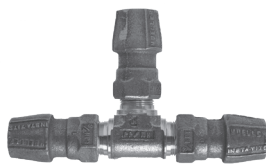

H-15399N

Service tee
CTS Insta-Tite - all ends

3/4"	1"
------	----

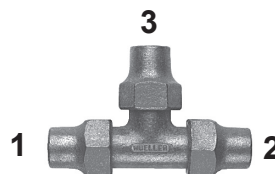

Service tee sizing - sizes of
ends are listed in the order
shown above - when all three
end sizes are the same, only
one size is listed.

‡Requires minimum ordering quantity. Contact MUELLER Customer Service Center for minimum ordering requirements and availability.
* See page 6.29 for tubing that can be used with this connection.

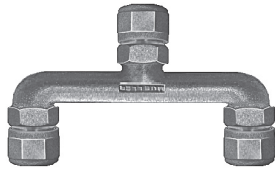

H-15373N

Inlet: Mueller® 110®
Conductive Compression
Connection for CTS
O.D.* tubing
Outlets: Mueller 110
Conductive Compression
Connection for CTS O.D.*
tubing straight line

3/4"x3/4"x7-1/2"	1"x3/4"x7-1/2"	1"x3/4"x5-1/4"
1-1/2"x3/4"x7-1/2" ‡		

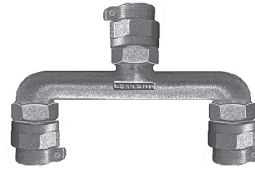

P-15373N

Inlet: MUELLER Pack Joint
Connection for CTS
O.D.* tubing
Outlets: MUELLER Pack
Joint Connection for CTS
O.D.* tubing straight line

1"x3/4"x7-1/2"	1-1/2"x3/4"x7-1/2" ‡
----------------	----------------------

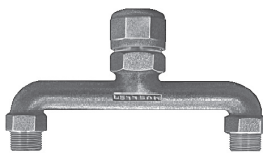

H-15363N

Inlet: Mueller 110 Conductive
Compression Connection for
CTS O.D.* tubing
Outlets: M.I.P. thread
straight line

3/4"x3/4"x7-1/2"	1"x3/4"x6-1/2"	1"x3/4"x7-1/2"
1"x3/4"x13-1/2"	1"x1"x7-1/2"	1-1/2"x3/4"x7-1/2"
1-1/2"x1"x7-1/2"		

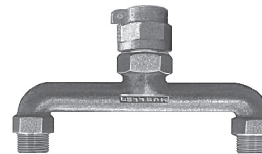

P-15363N

Inlet: Mueller® Pack Joint
Connection for CTS
O.D.* tubing
Outlets: M.I.P. thread
straight line

3/4"x3/4"x7-1/2"	1"x3/4"x6-1/2"	1"x3/4"x7-1/2"
1"x3/4"x13-1/2"	1"x1"x7-1/2"	1"x1"x13-1/2"
1-1/2"x3/4"x7-1/2"	1-1/2"x1"x7-1/2"	



H-15369N

Inlet: Mueller 110 Conductive
Compression Connection for
CTS O.D.* tubing
Outlets: M.I.P. threads
right angle

1"x3/4"x7" ‡

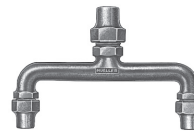

H-15360N

Inlet: Copper flare nut
Outlets: Copper flare nut
straight line

3/4"x3/4"x5-1/2"	3/4"x3/4"x10"	1"x3/4"x5-1/4"
1"x3/4"x10"		



H-15362N

Inlet: Copper flare nut
Outlets: M.I.P. thread
straight line

3/4"x3/4"x7"	3/4"x3/4"x7-1/2"	3/4"x3/4"x13-1/2"
1"x3/4"x6-1/2"	1"x3/4"x7"	1"x3/4"x7-1/2"
1"x3/4"x13-1/2"		



H-15368N

Inlet: Copper flare nut
Outlets: M.I.P. thread right
angle

3/4"x3/4"x7" ‡	1"x3/4"x7" ‡
----------------	--------------

NOTE: Inline or Angle valves with *fi* threads can be added to any U Branch with MIP Ends

‡Requires minimum ordering quantity. Contact MUELLER Customer Service Center for minimum ordering requirements and availability.

* See page 6.29 for tubing that can be used with this connection.

NOTE: Sizes shown above represent nominal size of end connections. First is size of inlet, second is size of outlets, and third is center-to-center dimension between outlets.

Rev. 4-17 Shaded area indicates changes



Inlet: M.I.P. thread
Outlets: M.I.P. thread straight line

H-15364N

3/4"x3/4"x13-1/2" ‡	3/4"x1"x5-1/4"	1"x3/4"x5-1/4"
1"x3/4"x6-1/2" ‡	1"x3/4"x7-1/2"	1"x3/4"x8"
1"x3/4"x13-1/2"	1"x1"x7-1/2"	1"x1"x13-1/2"



Inlet: F.I.P. thread
Outlets: M.I.P. thread straight line

H-15365N

3/4"x3/4"x7-1/2"	1"x3/4"x6-1/2"	1"x3/4"x7-1/2"
1"x3/4"x13-1/2"	1"x3/4"x13-1/2"	1"x3/4"x14"
1"x1"x7-1/2"	1-1/4"x3/4"x13-1/2"	1-1/2"x3/4"x7-1/2"
1-1/2"x1"x7-1/2"		



Inlet: F.I.P. thread
Outlets: F.I.P. thread straight line

H-15367N

1"x3/4"x7-1/2"

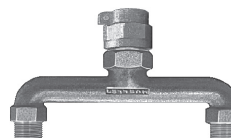

Inlet: Pack Joint Connection for PVC tubing
Outlet: M.I.P. thread straight line with 7-1/2" Center
 Two piece factory assembled

V-15361N

1"x3/4"x7-1/2"	1-1/2"x3/4"x7-1/2"
----------------	--------------------

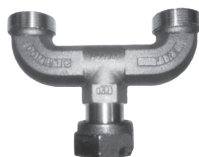

Inlet: Meter swivel nut
Outlets: Male meter thread

H-15375N

1"x1"x5"



Inlet: M.I.P. thread
Outlet: Male meter thread

H-15376N

1"x1"x5"



Inlet: Meter nut
Outlets: CTS PJ outlets

P-25250N

1"



Inlet: Meter nut
Outlet: M.I.P. thread straight line with F.I.P. outlets

B-25251N

1"

NOTE: Inline or Angle valves with fip threads can be added to any U Branch with MIP Ends

‡Requires minimum ordering quantity. Contact MUELLER Customer Service Center for minimum ordering requirements and availability.

* See page 6.29 for tubing that can be used with this connection.

NOTE: Sizes shown above represent nominal size of end connections. First is size of inlet, second is size of outlets, and third is center-to-center dimension between outlets.

Mueller Co. has the capability to supply "U" Branches with virtually any combination of end connections, including styles with any standard Mueller valve or fitting attached to one or more of the connections. Use the illustrations below to sketch what is needed. Label each of the three positions with the type/size of connection (eg: MUELLER 110 Connection, M.I.P., etc.), and type/size valve/fitting to be attached if applicable. Best availability will result by selecting a standard "U" Branch from the preceding page, however special configurations may be available.

_____ Enter catalog number of standard "U" branch, otherwise mark the appropriate illustration below to show important dimensions of the special "U" branch you require, such as distance between outlets.

Position #1 Type/size connection: _____

- Check this box if nothing is to be attached at position #1, otherwise provide the following information.
 Valve/fitting catalog number: _____
 Valve options (eg: handles): _____

Position #2 Type/size connection: _____

- Check this box if nothing is to be attached at position #2, otherwise provide the following information.
 Valve/fitting catalog number: _____
 Valve options (eg: handles): _____

Position #3 Type/size connection: _____

- Check this box if nothing is to be attached at position #3, otherwise provide the following information.
 Valve/fitting catalog number: _____
 Valve options (eg: handles): _____

If angle valves are needed: Draw an arrow head on the end of the red line at each of the appropriate positions to show the direction the angle valve outlet should point. If ordering inline valves: Draw an arrow head to show the direction the valve head (cap) or access cover should point.

Note: Although the arrow lines are shown in the 12, 3, 6 and 9 o'clock positions, which are most common and preferred, other angles can be ordered. If some other angle is required, draw in your own arrow line and mark the angle in degrees referenced to the centerline of the "U" branch body.

Straight line "U" branch viewed from outlet end

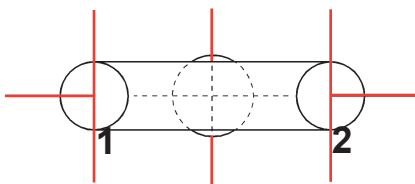

Right angle "U" branch - top right illustration: viewed from inlet end; bottom right illustration: viewed from outlet end

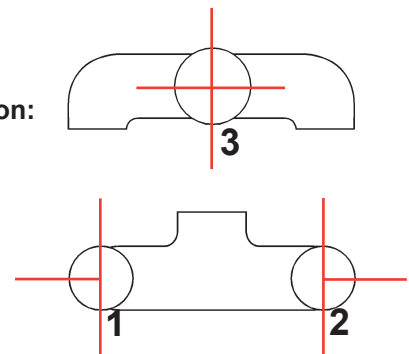

There are three possible locations where a special fitting can be attached: at outlets 1 and 2, or inlet 3.

FAX this page to Mueller Customer Service (217) 425-7537. A representative will contact you to discuss availability submitting this page does not constitute placing an order.

Rev. 4-14 Shaded area indicates changes

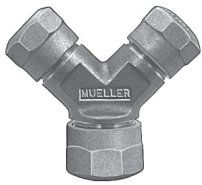

H-15343N

Two branch-short body
***Inlets:** Mueller 110[®] Conductive Compression Connection for CTS O.D.** tubing
***Outlet:** Mueller 110 Conductive Compression Connection for CTS O.D.** tubing

3/4"x1"	1"	1"x1-1/2"	1"x2"
---------	----	-----------	-------

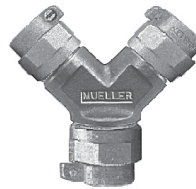

P-15343N

Two branch-short body
***Inlets:** Mueller[®] Pack Joint Connection for CTS O.D.** tubing
***Outlet:** Mueller Pack Joint Connection for CTS O.D.** tubing

3/4"x1"	1"	1"x1-1/2"	1"x2"
---------	----	-----------	-------



H-15347N

Two branch-short body
***Inlets:** Mueller 110[®] Conductive Compression Connection for CTS O.D.** tubing
***Outlet:** M.I.P. thread

3/4"x1"	1"	1"x1-1/2"	1"x2"
---------	----	-----------	-------



P-15347N

Two branch-short body
***Inlets:** Mueller Pack Joint Connection for CTS O.D.** tubing
***Outlet:** M.I.P. thread

3/4"x1"	1"	1"x1-1/2"	1"x2"
---------	----	-----------	-------



H-15341N

Two branch
***Inlets:** Copper flare nut
***Outlet:** M.I.P. thread

3/4"x1-1/2" ‡	3/4"x1-1/4" ‡	1"x1-1/4" ‡	1"x1-1/2"	1"x2"
---------------	---------------	-------------	-----------	-------



H-15340N

Two branch
***Inlets:** Copper flare nut
***Outlet:** Copper flare nut

3/4"	3/4"x1"	1"x1-1/4"	1"x1-1/2"
------	---------	-----------	-----------

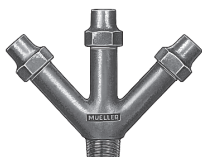

H-15346N

Three branch
***Inlets:** Copper flare nut
***Outlet:** M.I.P. thread

3/4"x1-1/2" ‡	1"x1-1/2"	1"x2"
---------------	-----------	-------

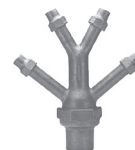

H-15350N

Four branch
***Inlets:** Copper flare nut
***Outlet:** Copper flare nut

3/4"x2" ‡	1"x2"
-----------	-------



H-15351N

Four branch
***Inlets:** Copper flare
***Outlet:** M.I.P. thread

3/4"x2" ‡	1"x2"
-----------	-------

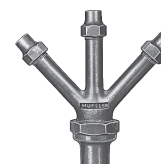

H-15345N

***Inlets:** Copper flare nut
***Outlet:** Copper flare nut

3/4"x1-1/2" ‡	1"x1-1/2"	1"x2"
---------------	-----------	-------

NOTE: Minimum length of copper tubing "gooseneck" is: 3/4" size-30", 1" size-40".
 ‡Requires minimum ordering quantity. Contact MUELLER Customer Service Center for minimum ordering requirements and availability.
 *Inlets and outlet can be reversed.
 **See page 6.29-6.30 for tubing that can be used with this connection.

Shaded area indicates change Rev. 2-15



Two branch
*Inlets: Copper flare nut
*Outlet: F.I.P. thread

H-15342N

1"x2"



Two branch-short body
*Inlets: M.I.P. thread
*Outlet: M.I.P. thread

H-10070N

3/4"x1"



Two branch - Short body
*Inlets: Solder joint
*Outlet: Mueller 110[®]
Conductive Compression
Connection for CTS
O.D.** tubing

H-15344N

1"x1-1/2"

1"x2"



Two branch
*Inlets: Mueller INSTA-TITE
Connection for IPS* PE pipe
*Outlet: Mueller INSTA-TITE
Connection for IPS* PE pipe

H-15353N

3/4"x1"



Two branch
*Inlets: Mueller 110[®]
Conductive Compression
Connection for IPS PE pipe
*Outlet: Mueller 110[®]
Conductive Compression
Connection for IPS PE pipe

H-15354N

3/4"x1"

NOTE: Minimum length of copper tubing "gooseneck" is: 3/4" size-30", 1" size-40".

‡Requires minimum ordering quantity. Contact MUELLER Customer Service Center for minimum ordering requirements and availability.

*Inlets and outlet can be reversed.

**See page 6.29 for tubing that can be used with this connection.

MUELLER 110® COMPRESSION CONNECTION INFORMATION

Rev. 4-14 Shaded area indicates changes

Tubing, pipe and liners used with Mueller 110 Compression Connection

Nominal size of connection	Material*	Tubing or pipe O.D. range - inches	Tubing or pipe wall thickness range - inches	Tubing or pipe I.D. range - inches	Liner part number
1/2" CTS	Type "K" copper	0.622 - 0.628	0.045 - 0.053	-	-
3/4" CTS	Type "K" copper	0.872 - 0.878	0.061 - 0.069	-	-
	Polyethylene	0.871 - 0.879	0.097 - 0.107	0.657 - 0.685	504281
1" CTS	Type "K" copper	1.121 - 1.129	0.061 - 0.069	-	-
	Polyethylene	1.120 - 1.130	0.125 - 0.137	0.846 - 0.880	504385
1-1/4" CTS	Type "K" copper	1.371 - 1.379	0.060 - 0.070	-	-
	Polyethylene	1.370 - 1.380	0.153 - 0.168	1.034 - 1.074	505142
1-1/2" CTS	Type "K" copper	1.621 - 1.630	0.067 - 0.077	-	-
	Polyethylene	1.619 - 1.631	0.181 - 0.199	1.221 - 1.269	506139
2" CTS	Type "K" copper	2.120 - 2.130	0.076 - 0.090	-	-
	Polyethylene	2.119 - 2.131	0.236 - 0.260	1.599 - 1.659	506141
3/4" IPS	Polyethylene	1.045 - 1.110	0.118 - 0.138	0.809 - 0.834	505141
	3/4" Sch. 40 PVC	1.046 - 1.054	0.113 - 0.133	0.780 - 0.828	509759
	3/4" Sch. 80 PVC	1.046 - 1.054	0.154 - 0.174	0.698 - 0.746	509760
1" IPS	Polyethylene	1.329 - 1.399	0.150 - 0.170	1.029 - 1.059	505142
	1" Sch. 40 PVC	1.310-1.320	0.133-0.153	-	-
	1" Sch. 80 PVC	1.310-1.320	0.179-0.200	-	-

*Type "K" soft copper tubing per ASTM B88; CTS polyethylene (PE) per ASTM D-2737 - SDR-9; IPS polyethylene (PE) per ASTM D-2239 - PE SDR-7; IPS polyvinylchloride (PVC) per ASTM D1785



Liner

Mueller 110 Compression Connection Replacement Parts

Size	Gasket part number†	Connection nut
1/2" CTS	681516	147542
3/4" CTS	581949	507831
1" CTS	581951	507835
1-1/4" CTS	581953	507843
1-1/2" CTS	581955	507847
2" CTS	581957	507851
3/4" IPS	89599	508826
1" IPS	89788	508827



Gasket assembly



Nut

†Gasket and gripper band assembly

Adapter Nut for pre-1976 style Mueller 110 Compression Connection for CTS tubing

Kit includes one standard Gasket (same used with current style 110 connections) and a special Nut that adapts to the older style connection threads on the fittings. It is installed in the same way as the current style connection (Gasket conductor spring should be toward fitting body).

Size	Connection kit
3/4" CTS	682552
1" CTS	682551

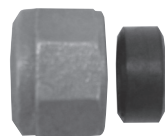

Tubing, pipe and liners used with Mueller® Pack Joint Connections

Nominal size of connection	Material*	Tubing or pipe O.D. range - inches	Tubing or pipe wall thickness range - inches	Tubing or pipe I.D. range - inches	Liner part number
3/4" CTS	Type "K" copper	0.872 - 0.878	0.061 - 0.069	-	-
	Polyethylene	0.871 - 0.879	0.097 - 0.107	0.657 - 0.685	528704
1" CTS	Type "K" copper	1.121 - 1.129	0.061 - 0.069	-	-
	Polyethylene	1.120 - 1.130	0.125 - 0.137	0.846 - 0.880	528705
1-1/2" CTS	Type "K" copper	1.621 - 1.630	0.067 - 0.077	-	-
	Polyethylene	1.619 - 1.631	0.181 - 0.199	1.221 - 1.269	528706
2" CTS	Type "K" copper	2.120 - 2.130	0.076 - 0.090	-	-
	Polyethylene	2.119 - 2.131	0.236 - 0.260	1.599 - 1.659	528707
3/4" IPS	Polyethylene	1.045 - 1.110	0.118 - 0.138	0.809 - 0.834	505141
	3/4" Sch. 40 PVC	1.046 - 1.054	0.113 - 0.133	0.780 - 0.828	509759
	3/4" Sch. 80 PVC	1.046 - 1.054	0.154 - 0.174	0.698 - 0.746	509760
	Polyethylene	1.329 - 1.399	0.150 - 0.170	1.029 - 1.059	505142
1" IPS	1" Sch. 40 PVC	1.310 - 1.320	0.133 - 0.153	-	-
	1" Sch. 80 PVC	1.310 - 1.320	0.179 - 0.200	-	-
	Polyethylene	1.754 - 1.832	0.197 - 0.221	1.360 - 1.390	312787
1-1/4" IPS	Polyethylene	2.05 - 2.141	0.230 - 0.258	1.590 - 1.625	529116
	1-1/2" Sch. 40 PVC	1.894 - 1.906	0.145 - 0.165	-	-
	1-1/2" Sch. 80 PVC	1.894 - 1.906	0.200 - 0.224	-	-
2" IPS	Polyethylene	2.637 - 2.742	0.295 - 0.330	2.047 - 2.082	529117
	2" Sch. 40 PVC	2.369 - 2.381	0.154 - 0.174	-	-
	2" Sch. 80 PVC	2.369 - 2.381	0.218 - 0.244	-	-
	Polyethylene	1.754 - 1.832	0.197 - 0.221	1.360 - 1.390	312787

*Type "K" soft copper tubing per ASTM B88; CTS polyethylene (PE) per ASTM D-2737 - SDR-9; IPS polyethylene (PE) per ASTM D-2239 - PE SDR-7; IPS polyvinylchloride (PVC) per ASTM D1785



Liners used with Mueller PVC Pack Joint Connection for OD Controlled PE Pipe

Nominal size of connection	Material	Tubing or pipe O.D. range - inches	Tubing or pipe I.D. range - inches	Length - inches	Liner part number
3/4" IPS	IPS PE OD controlled DR-9	1.046 - 1.054	0.772 - 0.820	2.00	313073
	IPS PE OD controlled DR-11	1.046 - 1.054	0.816 - 0.864	2.00	313074
1" IPS	IPS PE OD controlled DR-9	1.310 - 1.320	.0978 - 1.028	2.125	313084
	IPS PE OD controlled DR-11	1.310 - 1.320	1.030 - 1.080	1.84	505142
1-1/2" IPS	IPS PE OD controlled DR-9	1.894 - 1.906	1.412 - 1.484	3.00	538266
	IPS PE OD controlled DR-11	2.369 - 2.381	2.082 - 2.047	3.20	538267
2" IPS	IPS PE OD controlled DR-9	1.894 - 1.906	1.496 - 1.560	3.00	538269
	IPS PE OD controlled DR-11	2.369 - 2.381	1.885 - 1.949	3.20	538270

MUELLER Pack Joint Connection Kit

Size	Connection Kit
3/4" CTS	681921
1" CTS	681922
1-1/2" CTS	681923
2" CTS	681924
3/4" IPS PE	682377
1" IPS PE	682556
1-1/2" IPS PE	682557
2" IPS PE	682558
3/4" IPS PVC	682377
1" IPS PVC	682553
1-1/2" IPS PVC	682554
2" IPS PVC	682555



Rev. 4-16 Shaded area indicates changes

Tubing, pipe and liners used with Mueller Grip Compression Connection

Nominal size of connection	Material*	Tubing or pipe O.D. range - inches	Tubing or pipe wall thickness range - inches	Tubing or pipe I.D. range - inches	Liner part number
3/4" CTS	Type "K" copper	0.872 - 0.878	0.061 - 0.069	-	-
	Polyethylene	0.871 - 0.879	0.097 - 0.107	0.657 - 0.685	528704
1" CTS	Type "K" copper	1.121 - 1.129	0.061 - 0.069	-	-
	Polyethylene	1.120 - 1.130	0.125 - 0.137	0.846 - 0.880	528705
1-1/2" CTS	Type "K" copper	1.621 - 1.630	0.067 - 0.077	-	-
	Polyethylene	1.619 - 1.631	0.181 - 0.199	1.221 - 1.269	528706
2" CTS	Type "K" copper	2.120 - 2.130	0.076 - 0.090	-	-
	Polyethylene	2.119 - 2.131	0.236 - 0.260	1.599 - 1.659	528707
3/4" IPS	Polyethylene	1.045 - 1.110	0.118 - 0.138	0.809 - 0.834	505141
1" IPS	Polyethylene	1.329 - 1.399	0.150 - 0.170	1.029 - 1.059	505142

*Type "K" soft copper tubing per ASTM B88; CTS polyethylene (PE) per ASTM D-2737 - SDR-9
IPS polyethylene (PE) per ASTM D-2239 - PE SIDR-7



Liner

Grip Joint kits

Size	Kit	Grip ring	Washer	Gasket	Connection nut
3/4" CTS	682861	312919	311692	537881	537838
1" CTS	682862	312920	311695	537882	537839
1-1/2" CTS	682863	312921	538107	537883	537840
2" CTS	682864	312922	538108	538109	537841
3/4" IPS	683023	313094	313695	311869	538320
1" IPS	683024	313095	312122	313098	538321

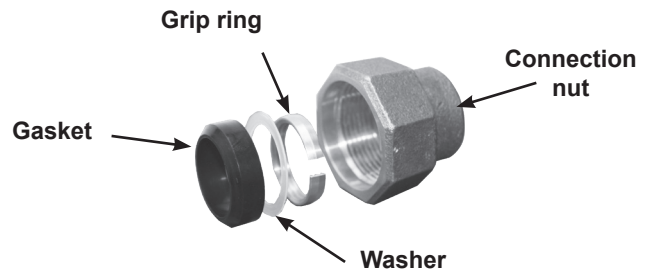

Shaded area indicates change Rev. 3-16



Brass plug - Machine inserted*
AWWA taper
(Mueller "CC") thread

H-10034N

1/2" ‡	5/8"	3/4"	1"	1-1/4" ‡	1-1/2"	2"
--------	------	------	----	----------	--------	----



Brass plug - Square head with**
AWWA taper
(Mueller "CC") thread

H-10033N

1/2"	5/8"	3/4"	1"	1-1/4"	1-1/2"	2"
------	------	------	----	--------	--------	----



Brass plug - Machine inserted*
I.P. thread

H-10037N

3/4" ‡	1" ‡	1-1/4" ‡	1-1/2" ‡	2" ‡	2-1/2" ‡
--------	------	----------	----------	------	----------



Brass plug - Square head with
I.P. thread

H-10035N

1/2" ‡	3/4"	1"	1-1/4" ‡	1-1/2" ‡	2" ‡
--------	------	----	----------	----------	------



Brass bushing
Male AWWA taper
(Mueller "CC") thread x
female AWWA taper
(Mueller "CC") thread

H-10036N

1"x3/4"	1-1/2"x1"	2"x2/4"	2"x1"	2"x2-1/2"
---------	-----------	---------	-------	-----------



Brass Bushings

47162N	1-1/4" MIP x 1" FIP
47163N	2" MIP x 3/4" FIP
47164N	2" MIP x 1" FIP
47165N	1" MIP x 3/4" FIP
47168N	1-1/2" MIP x 3/4" FIP
47169N	1-1/2" MIP x 1" FIP
47172N	2" MIP x 1-1/2" FIP



Adapter with Slip Coupling
F.I.P. x PVC slip coupling

H-700065E

3/4"x1-1/2"



Adapter with Slip Coupling
F.I.P. x PVC slip coupling

H-700066E

1"x1-1/2"

*Nominal size.

‡Requires minimum ordering quantity. Contact MUELLER Customer Service Center for minimum ordering requirements and availability.



Reliable Connections™

www.muellercompany.com • moreinfo@muellercompany.com
