

JM-2900™ Gas Jet Operating Instructions



Your JM-2900 Jet-Set gas-powered water jet is designed to give you years of trouble-free, profitable service. However, no machine is better than its operator.

Read, understand and follow all safety warnings and instructions provided with the product. Failure to follow the warnings and instructions may result in electric shock and/or serious injury. Save all warnings and instructions for future reference.

SAVE THESE INSTRUCTIONS!

General
PIPE CLEANERS



WARNING

Read and understand operator's manual before using this machine. Failure to follow operating instructions could result in death or serious injury.

WARNING! Read and understand all instructions. Failure to follow all instructions listed below may result in electric shock, fire and/or serious personal injury. Replacement manuals are available upon request at no charge, or may be downloaded from our website, www.drainbrain.com. Instructional videos are available for download on our website, and may be ordered. If you have any questions or problems, please call General's customer service department at 412-771-6300.

SAVE THESE INSTRUCTIONS!

These instructions are intended to familiarize all personnel with the safe operation and maintenance procedures for the JM-2900.

SAFETY SYMBOLS



This is the safety alert symbol. It is used to alert you to potential personal injury hazards. Obey all safety messages that follow this symbol to avoid possible injury or death.

DANGER

DANGER indicates a hazard with a high level of risk which, if not avoided, will result in death or serious injury.

WARNING

WARNING indicates a hazard with a medium level of risk which, if not avoided, could result in death or serious injury.

CAUTION

CAUTION indicates a hazard with a low level of risk which, if not avoided, will result in minor or moderate injury.

WARNING

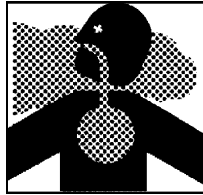

Serious injury or death may occur from inhaling engine exhaust or dangerous vapors. Use this product only in a well ventilated area. This water jet is designed for outdoor use only. Always make sure there is adequate ventilation (fresh outside air) for breathing and combustion.



Do not operate power tools in explosive atmospheres, such as in the presence of flammable liquids, gases, or dust. Power tools create sparks which may ignite the dust or fumes.

Do not spray flammable liquids. Risk of explosion. Flammable liquids can create fumes which can ignite causing property damage or severe injury.



Do not direct discharge stream at people. This equipment can produce a high pressure stream of fluid that can pierce skin and its underlying tissues, leading to serious injury and possible amputation or death.



Always wear safety glasses and rubber soled, non-slip shoes. High pressure spray can cause paint chips or other particles to become airborne and fly at high speeds. Use of this safety equipment may prevent serious injury.

WARNING

This product contains lead, a chemical known to the State of California to cause birth defects or other reproductive harm. Wash your hands after handling this product.

WARNING

This product contains one or more chemicals known to the State of California to cause cancer and birth defects or other reproductive harm.

GENERAL SAFETY RULES

WARNING

Read and understand all instructions. Failure to follow all instructions listed below may result in electric shock, fire, and/or serious injury.

SAVE THESE INSTRUCTIONS!

WORK AREA SAFETY

1. **All installations must comply with local codes.** Contact your plumber, utility company or the selling distributor for specific details.
2. **Risk of explosion. Do not spray flammable liquids or operate in an area where flammable or explosive materials are used or stored.** Power tools create sparks which may ignite dust and fumes.
3. **Keep bystanders, children, and visitors away while operating machine.** Distractions can cause you to lose control.

PERSONAL SAFETY

1. **High pressure developed by jet machines will cause personal injury. Water spray should not be pointed at any person.** High pressure spray can result in serious injury. If fluid seems to have penetrated the skin, seek emergency medical attention at once.
2. **Grip jet hose or spray wand securely with both hands before starting the machine.** Failure to do so could result in injury from a whipping hose or wand.
3. **Always wear eye protection and rubber gloves.** Safety equipment, eye safety devices, non-skid safety shoes and protective clothing must be worn when using this equipment.
4. **Do not touch engine during operation.** The muffler and other parts of the engine get hot and can cause severe burns.
5. **Do not smoke while filling engine fuel tank.** Fumes can ignite causing property damage and severe injury.
6. **Stay alert, watch what you are doing and use common sense when operating a power tool. Do not use tool while tired or under the influence of drugs, alcohol, or medication.** A moment of inattention while operating power tools may result in serious personal injury.
7. **Dress properly. Do not wear loose clothing or jewelry. Contain long hair. Keep your hair, clothing, and gloves away from moving parts.** Loose clothes, jewelry, or long hair can be caught in moving parts.

SERVICE

1. **Tool service must only be performed by qualified service personnel.** Service or maintenance performed by untrained personnel could result in injury and damage to the equipment.
2. **When servicing tool, use only identical replacement parts. Follow instructions in maintenance section of this manual.** Use of unauthorized parts or failure to follow maintenance instructions may cause injury or damage to equipment.

JET SAFETY

1. **Do not operate jet above rated pressure or above 140 degrees (rated water temperature).** Operating jet above rate specifications risks damage to the pump and related components, and will void the warranty.
2. **Do not operate jet with the output valve in the off position for extensive periods of time.** This will cause the water to overheat and damage the pump.
3. **Never run pump without water in it.** Operating the machine without water will cause the pump to fail and void the warranty.
4. **Check for worn hose and components before each use. Check that all fittings are secured before using jet.** Worn or lose fittings can cause damage to the machine and injure the operator.
5. **Protect machine and pump from freezing.** Storing or operating the jet in temperatures below freezing can damage pump, hose and other jet components. Store unit indoors or protect with anti-freeze when not in use.
6. **General Wire Spring Co. will not be liable for any changes made to our standard machines or any components not purchased from General Wire Spring Co.**

JM-2900 SPECIFICATIONS

200 ft. Capacity Hose Reel

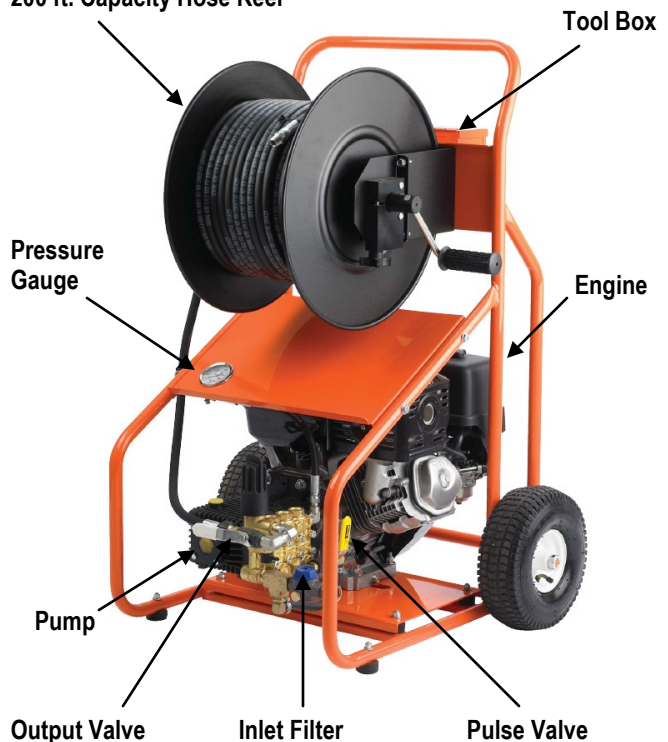

JET HOSE

1. When selecting hose size, consider that pressure is lost as the water travels down the length of the hose. As the length increases, the pressure decreases. In addition, the smaller the diameter of the hose, the greater the loss of pressure per foot will be. As an example, at 4 GPM, a 3/8" hose will lose 90 lbs. of pressure over a 100 ft. length. The gauge reflects pressure from the pump only, not pressure at the end of the hose. It is important to select the largest possible hose size in order to have as much pressure as possible at the end of the hose.
2. Hoses of the same diameter may be coupled together using the CC-1 coupling, but it is not recommended for use in lines smaller than 8" in diameter. The long length of the hose connectors and coupling together can get caught in bends in the line. It is not advisable to have two different hose sizes coupled in a drain line. There is a tremendous loss of pressure when combined, aside from the difficulty of getting around bends.

HOSE SELECTION GUIDE

Hose Size (ID*)	Pipe Size	Typical Applications	Available Hose Lengths
3/8"	4" - 8"	Floor drains, septic lines, long runs	100 ft., 200 ft.
1/4"	2" - 4"	Kitchen sinks, laundry drains, clean outs	100 ft., 150 ft., 200 ft.
1/8"	1-1/2" - 2"	Small lines, bathroom sinks, tight bends	30 ft., 50 ft., 75 ft.

* Inside Diameter

JET NOZZLES

1. A variety of jet nozzles are available for drain cleaning. Each has a different spray pattern and purpose. Some nozzles may have an orifice in the front to cut through the stoppage. All will have holes in the back to drive the hose down the line and clean the walls of the pipe. A tight spray pattern (15°) has more driving power for long runs, a wide spray pattern (40°) does a better job of cutting the grease off of the walls of the pipe. A combination of nozzles may be required to clear a line. Always turn off the machine and turn off output valve before changing nozzles.
2. Make sure the nozzle you are using matches the pump size. A 3000 psi pump requires a different nozzle orifice than a 1500 psi pump. Mismatching nozzles with pump size will either cause too little pressure, which may not clear the drain, or too much pressure, which may damage the machine.
3. Check nozzles before and after each use for clogged holes which can cause pressure to increase to dangerously high levels and damage the pump. A clogged hole can be cleared by simply using the NCT Nozzle Cleaning Tool.

4. Use the nozzle selection guide to determine what nozzle you will need for various applications. Examples: If a nozzle is stamped #52, it is a JN-52, drilled for 4 GPM @ 3000 PSI with several 15° rear jets and one forward cutting jet.

Powerful penetrating nozzle cuts through grease and ice.

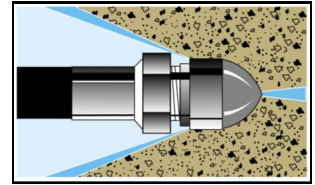

Wide spray flushing nozzle cleans inside of pipe thoroughly.

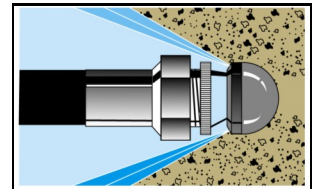

SPECIALTY NOZZLES

Spring leader nozzles and down head nozzles are special nozzles to help hose travel through the pipe when there are a lot of Tee's, curves, and bends.

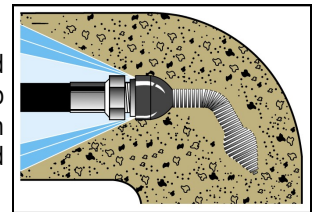

ROTARY NOZZLES

Rotary nozzles are useful as a finishing tool. After the line has been cleared, you may switch to the rotary nozzle to more thoroughly clean the walls of the pipe. Use these nozzles only in a predominantly straight run since they are longer than regular nozzles and may get caught in tight bends.

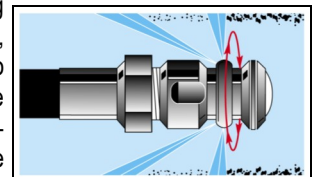

CHAIN SAW NOZZLES

Chain saw nozzles spin at up to 10,000 rpm to rip through roots. Lengths of chain can be quickly and easily switched for different diameter pipes.



NOZZLE SELECTION GUIDE

HOSE SIZE	1/8"	1/4"	3/8"
	CAT #	CAT #	CAT #
15° Rear Jets w/No Forward Jet	JN-31	JN-41	JN-51
15° Rear Jets w/One Forward Jet	JN-32	JN-42	JN-52
30° Rear Jets w/No Forward Jet	JN-33	-	-
40° Rear Jets w/No Forward Jet	-	JN-44	JN-54
Spring Leader	JNSL-4	JNSL-5	JNSL-6
Rotary Nozzle (Optional)	-	JNRB-4	JNRB-6
Chain Saw Nozzle (Optional)	-	-	JCSN-6

JET ASSEMBLY

- Upon arrival, inspect the shipping crate for damages. Uncrate and examine all parts. Note any damage to machine or components for claims against freight carrier.
- Jet must be stored and operated in horizontal position. Never store in upright position or oil may leak from pump. If low, fill with SAE 30 weight non-detergent oil.
- Gas jets are shipped with oil in the engine. **Consult motor manufacturer's guide for oil requirements.**
- Jet machines are meant to be used at or near the working area and under operator supervision. If machine must be located out of sight of operator, special controls may be required for proper machine operation and operator safety

OPERATION

SET-UP

1. Locate the jet near the drain line on a level surface with drainage.
Tip: Ideally, the drain line should be cleared from the downstream side, that is, from the street back toward the house. If you must clear the line from the drain toward the street, you may need to use a siphon pump to clear away excess water.
2. Check the oil level in the pump. If low, fill with SAE 30 weight non-detergent oil.
3. Check the oil level in the engine. If low, fill with the oil weight recommended in the motor manufacturer's manual.
4. Check the inlet filter to make sure it's clean before each use. To clean, unscrew filter cap, remove the screen and rinse thoroughly with water. Then, replace screen.
5. Check that incoming water supply is clean and free of debris. Turn the water source on for at least 15 seconds to remove any possible debris in the water before connecting hose to water inlet.

6. Connect one end of a water supply hose (not included) to the water supply and the other end to the water inlet of the jet machine. Water supply must be a minimum of 20 psi and not to exceed 100 psi. Caution: Water temperature must not exceed 140 degrees or damage to the pump can occur. Use only heavy duty 3/4" hose of no more than 50 ft. in length. If run without an adequate water supply, the pump will cavitate. Cavitation causes the pump to vibrate, causing damage to the pump. Note: Lack of water supply can lead to seal damage, causing a loss of pressure and will void the warranty to the pump.
7. Maximum temperature from the water source should not exceed 140°F (60°C). Using water hotter than 140°F (60°C) can cause damage to the pump and void the warranty. If jet is being used to clear ice blockages, see instructions on Ice Blockages.
8. Select the proper hose diameter for the line to be cleaned. When using new hose, run water through it to clean it out before attaching the nozzle.

OPERATION



NEVER POINT THE END OF THE JET HOSE AT A PERSON WHILE OPERATING.

1. Select the correct jet hose size to match the line size you are clearing. (See Hose Section Guide) Check all hoses for wear and damage. Tighten all connections securely.
2. Select the correct nozzle and attach to the end of the hose. (See Nozzle Selection Guide) Note: If you are using a new jet hose, run water through it to flush out debris before connecting a nozzle.
3. Insert the jet hose 2 to 3 feet into the drain line before turning on machine.
4. Turn on the water supply valve fully to allow for maximum flow.
5. Turn on the jet output valve and allow water to run through the supply hose, jet, and jet hose to purge air from system before turning on the machine.
6. Make sure that the output valve is turned on and the water is flowing.
7. Start the engine using the Engine Start-up procedures listed below.

GAS ENGINE START-UP

1. Make sure that the ball valve is turned on and water is flowing.
2. Move choke lever to the closed position. **Note:** Do not use choke if engine is warm or ambient air temperature is high.
3. Move throttle lever to the midpoint position.
4. Turn the engine switch to the ON position.
5. Pull the starter grip lightly until resistance is felt, then pull briskly.
6. As the engine warms up, gradually move the choke lever to the open position.
7. Position the throttle to the desired engine speed.

OPERATION CONTINUED

9. Guide the jet hose into the drain line. Do not feed the hose continuously, but rather, move the hose forward and back to allow the pressure to break up the stoppage and the water flow to flush it away. If you are clearing the line from the upstream side, this may take more time. Clearing the line from the downstream side allows debris to flow away easily.

10. It is often helpful to turn on the Vibra-pulse valve. The vibration generated helps to hose overcome the friction in the line and glide farther down the line. See Vibra-pulse section.
11. When the jet hose encounters a bend in the line, its advance may slow or stop. The hose has a slight curve to it from the hose reel. It may be necessary to manually feed or rotate the jet hose to work it around the bends. If the hose won't advance, put the hose in a loop and rotate it a quarter to half turn so the curve of the hose matches the pipe. It may also be necessary to pull the hose back six inches and snap it forward to hop across a gap in the pipe fitting.
12. Once you reach the stoppage, move the hose back and forth through the section several times to ensure the line is thoroughly cleared. You may also switch nozzles to a wide spray or rotary (optional) nozzle for wall to wall cleaning action.

VIBRA-PULSE®

Pulsation makes the hose vibrate, helping the jet go longer distances and around tight bends easier. The pulse control valve is located on the front of the pump. Simply turn the valve on to engage the pulse. Vibra-pulse is most effective in a 1/8" hose. You'll notice less vibration with a 1/4" hose, and almost none with a 3/8" hose. However, the pulse is still effective, causing the water to burst from the nozzle hundreds of times per second. If you are still having difficulty getting hose around a tight bend, switch to a smaller diameter hose. Turn the pulse off before turning machine off.

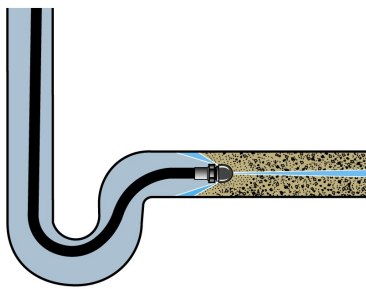

SHUT DOWN INSTRUCTIONS

After drain cleaning or spray washing is completed, run clear water through the system. Always leave the output valve in the on position when turning off motor. Turn off water supply and drain as much water from the pump as possible. Remove water supply hose from inlet. If you are in a cold climate, see Freeze Protection section.

SPECIAL APPLICATIONS

ICE BLOCKAGES

High pressure water can be used to clear an ice blockage. A 3000 psi gas jet can clear a 4" line at an approximate rate of one foot per minute. The smaller, electric jet will take twice as long. Ambient air temperature will effect these times. Use a 15° nozzle with a forward jet. DO NOT allow the incoming water supply to exceed 140°F (60°C) or it could cause damage to the pump. Remember to follow the cold weather precautions found in the Freeze Protection section.

FREEZE PROTECTION

To protect your machine from severe damage caused by water freezing inside the components, it is important to winterize it whenever it is subjected to freezing temperatures.

The best way to protect the system is to keep it out of the cold. Barring that, the next best way is to flush the system with anti-freeze. To do so, simply attach a short garden hose (not to exceed four feet) to inlet on the pump and put other end into the anti-freeze container. Be sure to remove the nozzle from the hose. Turn the machine on to draw anti-freeze into the system. When anti-freeze flows out of the end of the hose, turn the machine off. Connect high pressure hose and trigger, and follow above procedure. Cycle trigger on/off so that the anti-freeze will flow into unloader and injector section of machine.

When preparing to operate equipment for the next job, remove the anti-freeze. To do so, reconnect water source, turn pump on and direct flow of anti-freeze back into container. Be careful not to dilute anti-freeze with incoming water supply. Anti-freeze, if kept relatively undiluted, can be used again and again.

Hoses can also be protected from freezing by using compressed air to clear them of residual water. Remember to remove nozzle from jet hose and hold trigger of spray wand in open position.

ADJUSTING PRESSURE UNLOADER

The machine is equipped with a regulating pressure unloader to prevent pressure overload in the event that the nozzle is clogged or the output valve or spray wand trigger is off. When the machine is in the bypass mode, the pump will continue to run. However, running in bypass mode for extended periods will cause damage to the pump - no more than 5 minutes. Excessive temperatures will damage the pump and void the warranty.

The machine also comes with thermal overload protection. When water temperature in the pump increases to 140°F (60°C), the thermal relief valve will release hot water and allow cool water to enter pump from the fresh water supply.

To adjust the unloader, loosen the lock nut and turn the knob counter-clockwise to decrease pressure and clockwise to increase pressure. Caution: Do not over-tighten unloader. Tighten lock nut after adjustments are made.

ACCESSORIES

HANDY-REEL WITH FOOT PEDAL - Cat # HM-200-W (OPTIONAL)

The Handy-Reel allows for remove application of the jet. The jet can be positioned at ground level, while the Handy-Reel can be carried up on a roof to clear vents and stacks. With the help of the Handy-Reel, gas jets can be used for indoor applications while the machine operates safely outside. The Foot Pedal interrupts the flow of water between the pump and the nozzle while leaving both hands free to guide the hose. Position the Handy-Reel at the drain site. Connect the jet machine to the inlet on the Foot Pedal. Select and attach nozzle to the hose on the reel. Put the hose 2 to 3 ft. into the drain line. Follow the start-up procedures.



FOOT PEDAL ONLY - Cat # FM-1 (OPTIONAL)

The Foot Pedal can be used with any jet manufactured by General. It interrupts the flow of water between the pump and the nozzle while leaving both hands free to guide the hose. The pump will continue to run in by-pass mode. Do not leave pump in by-pass for more than a few minutes or the pump can be damaged. (See Pressure Unloader)

The Foot Pedal may be connected either at the machine or remotely at the drain site. To use the foot pedal at the machine, remove the hose going to the swivel on the hose reel and attach it to the inlet side of the Foot Pedal. Then, connect the accessory hose (available in 6 ft., 25 ft., or 50 ft. lengths) between the outlet of the pedal and the swivel on the hose reel. Some jet models may need the added length of the accessory hose on the inlet side of the pedal.

For remote operation, pull the hose from the hose reel to the drain site. Attach the hose to the inlet of the pedal. The pedal is designed for 3/8" hose fittings. If using a 1/4" hose, use the AD-1 adapter, as well. Then, attach the smaller hose (1/8" or 1/4") to the outlet side of the pedal. Use the smaller hose to clear the drain line.

SPRAY WAND - Cat#SWA-3000 (OPTIONAL)



The Spray Wand can be used to clean your truck or other applications. Caution: Never clean the machine with its own spray. Follow the same procedures listed previously for safety, set-up, operation, and maintenance. To operate the spray wand with your water jet, disconnect to twist connect at the output valve. Then, connect the spray wand hose, trigger and wand at the output valve. Turn on the water supply, then squeeze the trigger to purge air from the system. Continue to squeeze trigger as you turn on the machine.

Hold the high pressure spray nozzle approximately 6 – 8 ft. from the surface to be cleaned. When cleaning with a detergent, apply from bottom up with an even left to right movement. Rinse from top down with a similar motion. This will help reduce potential streaking. Always apply soap to a dry surface. This will enhance penetration and detergent cling and reduce dilution of detergent with an already wet surface.

You may draw soap through the spray wand in conjunction with the optional chemical injector. First set up the Chemical injector system (see Chemical Injector). Then, simply turn the nozzle barrel on the end of the wand counter-clockwise. As the spray pattern widens, more of the detergent will be drawn through the wand. Turn the nozzle clockwise to reduce the detergent flow and narrow the water spray pattern to return to high pressure.

CHEMICAL INJECTOR – Cat # CMA-1 (Optional)

To use the chemical injector, disconnect the Twist Connect at the output valve on the jet. Then thread the Chemical Injector on to it. The Spray Wand then threads onto the free end of the Chemical Injector. Do not attach Chemical Injector to the inlet side of the pump. Detergents can damage pump.

To use the detergent injector, attach one end of the siphon hose to the barbed fitting on the injector and put the filter end into the detergent solution. Be sure the end of the hose is at the bottom of the container or bucket. Some models have adjustable valves to control the amount of detergent drawn through the hose.

MAINTENANCE

Regular inspection is the key to preventing breakdowns and prolonging the life of the equipment. Follow this simple procedure religiously.

DAILY

- Check INLET FILTER for debris before each use.
- Check that the PUMP OIL LEVEL is within operating range on dipstick or sight glass.
- Check that the jet nozzles are not clogged or worn out.

WEEKLY

- Check the pressure hose for wear and damage. Damaged hose can be repaired at a local service dealer or by your equipment dealer.

Pump Crankcase Oil Change: Service after the 1st month, or after 20 hours. Then service every year or 500 hours. Use SAE 30W Non-Detergent Motor Oil to full mark on dipstick or to dot on sight glass.

Engine Maintenance: Check engine manual for specific maintenance procedures.



USE CAUTION WHEN PRESSURE WASHING. WEAR GOGGLES AND RUBBER GLOVES AND BOOTS. ANALYZE ANGLE OF SPRAY AND ANTICIPATE ANGLE OF BACK SPLASH. DO NOT POINT SPRAY AT ANYONE, INCLUDING YOURSELF. DO NOT PUT YOUR HAND IN FRONT OF WATER SPRAY. IT CAN PENETRATE THE SKIN AND CAUSE A NEED FOR AMPUTATION. IT IS BEST TO START AT A 45° ANGLE AT A 7 TO 10 FT. (2 TO 3M) DISTANCE FROM OBJECT TO BE CLEANED. DIRECT SPRAY AT CLOSE RANGE CAN BE POWERFUL ENOUGH TO CAUSE DAMAGE.

TROUBLE SHOOTING GUIDE		
Problem	Probable Cause	Solution
Low pressure.	Worn, clogged, or oversized nozzle.	Clean or replace worn nozzle. Check nozzle size.
	Clogged water inlet strainer.	Clean or replace strainers.
	Inadequate water supply.	Make certain water supply valve is on fully. Make certain water supply hose is at least 3/4" in diameter, in good condition, with no kinks or damage, and is not longer than 50 ft.
	Worn or damaged piston cups.	Replace piston cups.
	Worn or damaged inlet or discharge valve.	Replace worn valve poppets or valve springs.
	Dirt or foreign particles in valve assembly.	Remove any dirt particles.
	Air leak in inlet plumbing.	Locate air leak. Re-seal connection or replace damaged port.
Rough operation with loss of pressure.	Restricted inlet plumbing or air leak in inlet plumbing.	Repair clogged inlet fittings. Check supply hose and ensure adequate water supply.
	Damaged piston, cup or pump valve.	Replace any damaged pump parts and clean out any foreign particles.
	Clogged nozzle.	Clean or replace nozzle.
Water leakage at intake manifold or crankcase.	Worn manifold seals, piston or o-rings, or condensation inside crankcase.	Replace seals, sleeves or o-rings. Change oil at regular intervals.
	Inadequate water supply to pump, creating a vacuum lock.	Ensure adequate tap water supply. Clear inlet filter.
Oil leaks.	Worn pistons and/or leaking crank seals, crankcase cover seal, or drain plugs.	Replace seals, sleeves or o-rings.
Excessive wear.	Worn or loose bearings.	Replace bearings. Check bearing seals, spacers and retainers. Replace any worn parts.
Short piston cup life.	Scored cylinders from pumping acids.	Replace cylinders. Do no pump acid solutions. For acid application, ask your dealer for a pump saver injector.
	Abrasive particles in fluid being pumped.	Replace water and detergent strainers if damaged or missing. Install additional filter if fine abrasives are still evident.
	Operator(s) running pump without water supply.	Do no allow washer to be run without proper water supply.
	Hot water in pump.	Do not run in bypass for more than 5 minutes. Do not let water supply exceed 140°F (60°C).
Irregular spray pattern.	Worn or partially clogged nozzle.	Clean or replace nozzle.

TROUBLE SHOOTING GUIDE continued		
Problem	Probable Cause	Solution
Washer fails to draw detergent.	Detergent metering valve closed, or valve clogged or defective.	Open detergent metering valve, following procedure in operating instructions.
	Back pressure in hose (when using additional lengths of pressure hose).	Contact dealer for proper injector size when adding lengths of hose.
	Back pressure in pressure hose (when using dual lance wand).	Use proper size flood nozzle in dual lance wand (refer to parts breakdown).
	Suction tube not below liquid surface.	Completely submerge suction tube and strainer in detergent solution.
	Clogged or damaged suction strainer.	Clean or replace strainer.
Detergent solution too weak.	Clogged detergent strainer.	Clean or replace strainer.
	Air leak in detergent suction tube or inlet plumbing.	Find air leak and clean or replace parts as necessary.
Detergent solution too concentrated.	Original detergent too concentrated.	Dilute product as necessary to achieve proper concentration.
Detergent in rinse cycle.	Dual lance wand or adjustable nozzle holder in open position or chemical metering valve open.	Close dual lance wand adjustable lance holder to achieve high pressure. Close detergent metering valve.
	Worn or defective internal check valve.	Repair or replace check valve or injector parts as necessary.
Dilution of detergent concentrate during cycle.	Defective check valve in detergent tank.	Replace parts as necessary.
Unloader cycles.	Fitting leaking downstream.	Tighten/replace fitting.
	Piston or valve spring broken or worn.	Replace parts as necessary.
	Clogged nozzle.	Clean or replace nozzle.
Fluid leaking from body.	O-ring worn or cut.	Replace part as necessary.
Unloader will not come to pressure.	Foreign particle in valve.	Clean or replace valve.
	Nozzle worn or wrong size.	Replace part as necessary.
	Piston or valve worn.	Replace part as necessary.
Extreme pressure spikes.	Adjusting nut turned completely into unloader.	Back off adjusting nut.
	Clogged nozzle.	Clean or replace nozzle.

See pages 10 & 11 for Parts List and Schematic Diagram.

JM-2900 PARTS LIST

ITEM	DESCRIPTION	PART #	QTY	ITEM	DESCRIPTION	PART #	QTY
1	ENGINE - HONDA	JM1-0086	1	29	GAUGE PANEL	JM20-1217A64	1
2	LOCKNUT	JM30-0159	4	30	HANDLE GRIP	JM7-0167	1
3	WASHER	JM28-0023	8	31	REDUCER	JM24-0282	2
4	BALL VALVE	JM22-0494	1	32	BOLT	JM27-0070	4
5	HANDLE GRIP	JM7-0227	1	33	CLIP	JM33-0291	1
6	TEE	JM23-0043	1	34	HIGH PRESSURE HOSE	JM15-0312	1
7	FILTER	JM19-0206	1	35	1/2" SWIVEL	JM24-0360	1
8	REDUCER BUSHING	JM23-0016	1	36	HOSE REEL - 18"	JM50-0192	1
9	ELBOW	JM23-0074	2	37	BOLT	JM27-0067	5
10	LOCKNUT	JM30-0157	17	38	HANDLE GRIP	JM7-0226	1
11	WASHER	JM28-0003	26	39	BALL VALVE	JM22-0461	1
12	ISOLATION PLATE	JM5-0308A64	1	40	ELBOW	JM24-0105	2
13	ISOLATOR	JM14-0097	4	41	HOSE	JM15-0020	1
14	DECAL - WARNING/OPERATION (SEE JM71-0002)	N/A	1	42	HOSE CLAMP	JM42-0011	2
15	BOLT	JM27-0121	4	43	COMPONENT TOOL BOX	JM20-1213A64	1
16	FRAME	JM5-0303A64	1	44	SCREW COUPLER	JM23-0490	1
17	SPACER	JM62-0188	2	45	SCREW NIPPLE	JM23-0493	1
18	WHEEL	JM14-0130	2	46	PUMP	JM3-0357	1
19	COLLAR	JM33-0351	2	47	BOLT	JM27-0118	4
20	LOCKNUT	JM30-0155	2	48	LOCKWASHER	JM29-0008	4
21	WASHER	JM28-0002	2	49	WASHER	JM28-0022	4
22	ISOLATOR	JM14-0069	2	50	ELBOW	JM24-0004	1
23	BOLT	JM27-0020	2	51	RELIEF VALVE	JM22-0005	1
24	DECAL - MARKETING	JM34-2632	1	52	VALVE CAP	JM46-1427	1
25	HIGH PRESSURE HOSE	JM15-0309	1	53	ELBOW	JM23-0130	1
26	ELBOW	JM23-0014	1	54	REDUCER	JM23-0017	1
27	U CLAMP	JM13-0211	1	55	KEY	JM43-0078	1
28	PRESSURE GAUGE	JM22-0465	1	-	DECAL SET/JM-2900	JM71-0002	1

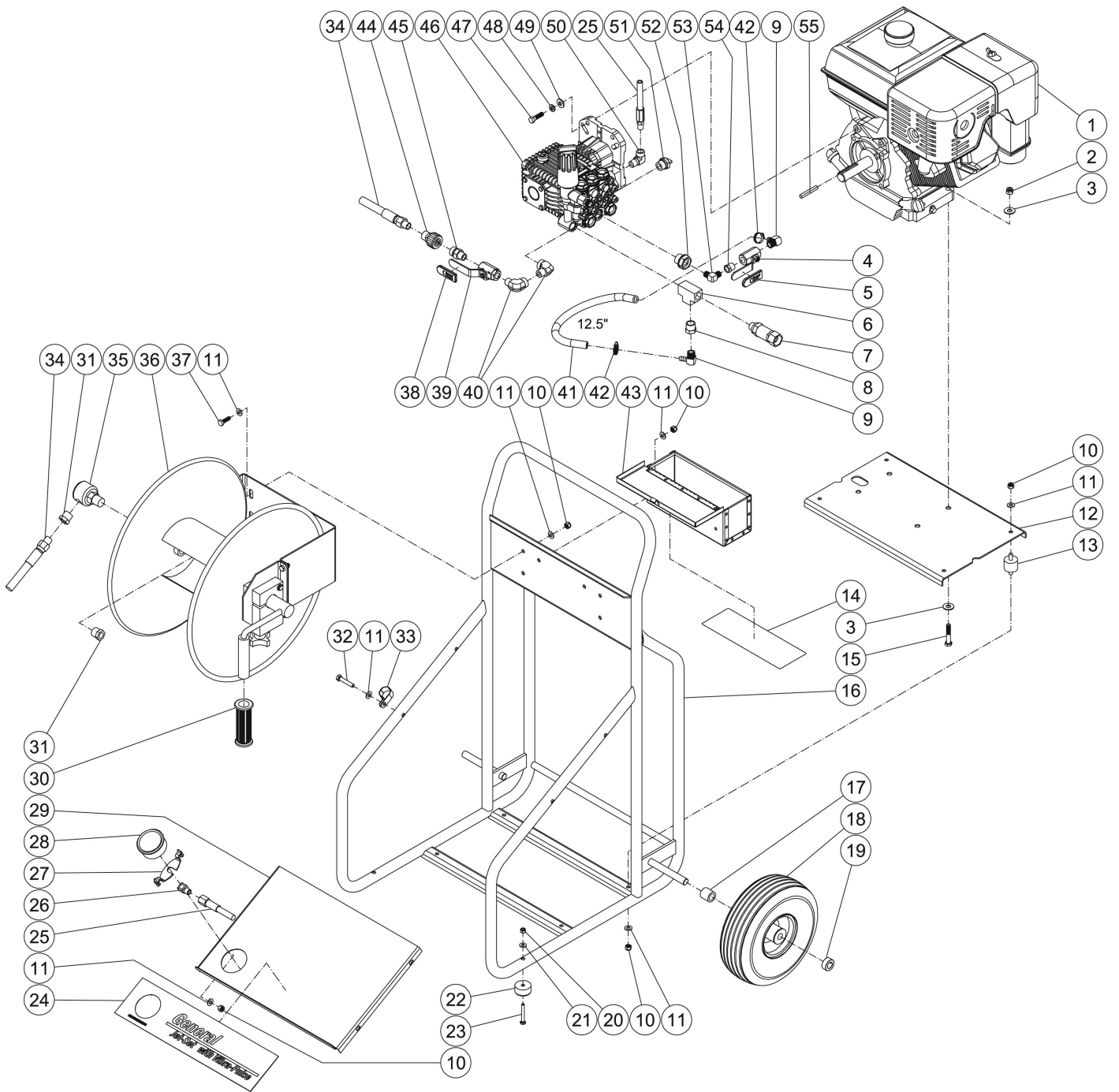

JM-2900 PARTS LIST

ITEM	DESCRIPTION	PART #	QTY	ITEM	DESCRIPTION	PART #	QTY
1	UNLOADER ASSEMBLY	JM8-0563	1	30	O-RING (SEE KIT 70-0415)	SEE KIT	3
2	KIT - UNLOADER REPAIR	JM70-0394	1	31	SEAL (SEE KIT 70-0415)	SEE KIT	3
3	O-RING	JM25-0050	1	32	OIL SEAL (SEE KIT 70-0414)	SEE KIT	3
4	ORIFICE	JM8-0126	1	33	SET SCREW	JM27-8886	1
5	O-RING	JM25-0051	1	34	CRANKSHAFT	JM46-1168	1
6	NIPPLE	JM46-1480	1	35	BEARING	JM48-0040	1
7	O-RING (SEE KIT 70-0416)	JM25-0120	1	36	O-RING	JM25-0060	2
8	SPRING (SEE KIT 70-0416)	JM49-0020	1	37	FLANGE	JM38-0038	1
9	BALL (SEE KIT 70-0416)	JM50-0012	1	38	OIL SEAL	JM26-0181	1
10	O-RING (SEE KIT 70-0416)	JM25-0045	1	39	LOCKWASHER	JM29-0153	4
11	HOSE BARB (SEE KIT 70-0416)	JM46-0789	1	40	BOLT	JM27-8404	4
12	O-RING (SEE KIT 70-0416)	JM25-0310	2	41	PIN	JM46-1162	3
13	VALVE SEAT (SEE KIT 70-0416)	JM8-0174	1	42	SIGHT GLASS	JM46-1163	1
14	BOLT	JM27-9576	8	43	O-RING	JM25-0059	1
15	LOCKWASHER	JM29-0154	8	44	BOLT	JM27-8401	4
16	PLUG	JM39-0017	2	45	CRANKCASE COVER	JM46-1164	1
17	PLUG	JM39-0071	6	46	O-RING	JM25-0317	1
18	O-RING	JM25-0012	6	47	CONNECTING ROD	JM46-1160	3
19	VALVE ASSEMBLY (SEE KIT 70-0028)	JM46-0565	6	48	PLUNGER GUIDE	JM46-1165	3
20	WASHER	JM28-0600	1	49	SLINGER WASHER	JM28-1049	3
21	WASHER	JM28-1038	1	50	RING	JM25-0143	3
22	PLUG	JM39-0019	1	51	O-RING	JM25-0502	3
23	PLUG	JM39-0018	1	52	PLUNGER	JM46-0228	3
24	MANIFOLD	JM46-1481	1	53	WASHER	JM46-0166	3
25	HEAD RING (SEE KIT 70-0415)	SEE KIT	3	54	NUT	JM46-0168	3
26	PACKING (SEE KIT 70-0415)	SEE KIT	3	55	DIPSTICK	JM46-0143	1
27	RESTOP (SEE KIT 70-0415)	SEE KIT	3	56	CRANKCASE	JM46-1166	1
28	SEAL RETAINER (SEE KIT 70-0415)	SEE KIT	3	57	BEARING	JM48-0093	1
29	SEAL (SEE KIT 70-0415)	SEE KIT	3	58	SNAP RING	JM46-0104	1
26	PACKING (SEE KIT 70-0415)	SEE KIT	3	59	OIL LEVEL INDICATOR	JM46-0574	1
27	RESTOP (SEE KIT 70-0415)	SEE KIT	3	60	RETAINER	JM46-0084	1
28	SEAL RETAINER (SEE KIT 70-0415)	SEE KIT	3	61	BOLT	JM27-8000	4
29	SEAL (SEE KIT 70-0415)	SEE KIT	3				

REPLACEMENT KITS

KIT #	DESCRIPTION	ITEMS	# OF ASSEMBLIES	# OF CYLINDERS
JM70-0028	VALVE KIT	19	6	3
JM70-0414	OIL SEAL	32	3	3
JM70-0415	PACKING ASSEMBLY	25-31	1,1,1,1,1,1,1	-
JM70-0416	INJECTOR REPAIR	7-13	1	-

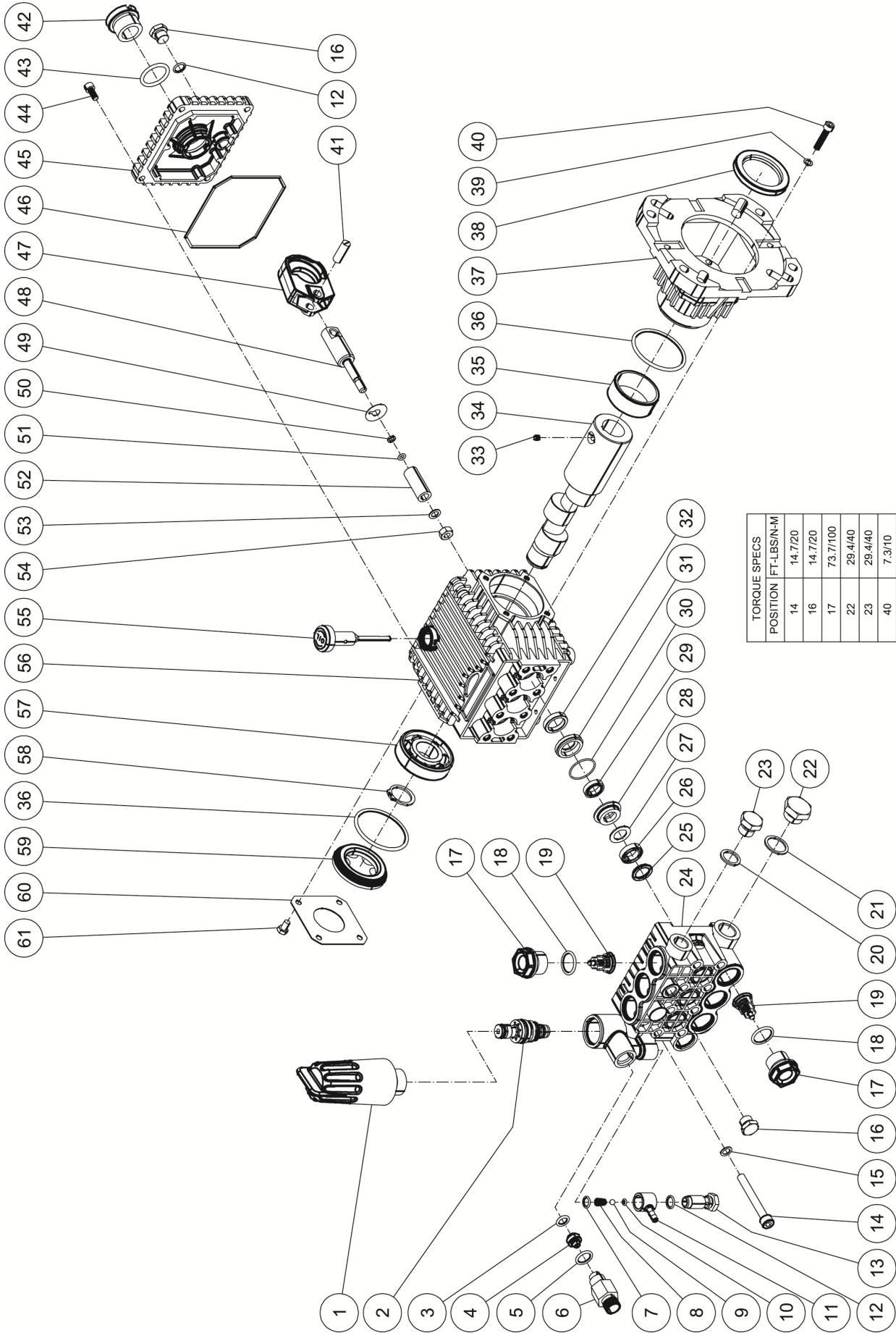

TORQUE SPECS	
POSITION	FT-LBS/IN-M
14	14.7/20
16	14.7/20
17	73.7/100
22	29.4/40
23	29.4/40
40	7.3/10
44	7.3/10
54	11.0/15
61	7.3/10

**General Wire Spring Co,
1101 Thompson Avenue
McKees Rocks, PA 15136
412-771-6300 www.drainbrain.com**