



**BASYS® Sensor Faucet**

**EFX-300-PLG-TEE-CP-0.5GPM-MLM-FCT**

**Product description**

Trim Plate: None, Plug Adapter Power Supply, Back-Check Tee, Polished Chrome Finish, 0.5 gpm, Multi-Laminar Spray, Infrared Sensor, BASYS® Hardwired-Powered Deck-Mounted Low Body Faucet.

**Compliances & Certifications**







(ADA Compliant, ASME A112.18.1 Compliant, CalGreen Compliant, CEC Compliant, EPD, HPD, IAPMO, NYC604.4, Proposition 65, Satisfies LEED Credits, TAS, UPC Low Lead Certified, WELL Building Standard)

**Code 3324096**



**Finish**

-  Polished Chrome (CP)

**Downloads**

-  [EFX 3Xx\\_6Xx Active IR Installation Instructions.pdf](#)
-  [Trim Plate Guide.pdf](#)
-  [IR FAQs Repair and Maintenance Guide.pdf](#)
-  [Sloan BASYS Brochure.pdf](#)
-  [Additional Downloads](#)

**Videos**

-  [Sloan Connect App®](#)
-  [BASYS® Faucet Installation and Features](#)
-  [BASYS® Faucet Installation Low Height Model](#)

---

## Details

- Flow Rate: 0.5 gpm (1.9 Lpm) (0.5GPM)
- Spray Type: Multi-Laminar (MLM)
- Sensor Type: Infrared
- Mounting Type: Single Hole
- Trim Plate: None
- Power Supply: Plug Adapter (PLG)
- Temperature Mixer: Back-Check Tee (TEE)
- Finish: Polished Chrome (CP)
- Factory Default Timeout: 10s
- Factory Default GPC: 0.083 gpc

---

## Features

Commercial Grade, ADA Compliant, Electronic, Sensor-Activated, Die-Cast Metal Hand Washing Faucet with the following features:

- One tool service
- Solenoid housed in removable carrier that includes supply strainer
- Integral water supply shut off
- Vandal resistant spray insert, key housed inside faucet body
- All electronics sealed to IP-67
- Gold plated electrical contacts
- Above deck individual diagnostic indicators for battery life, solenoid condition, and power-up mode
- Flexible, high pressure supply hose, 3/8" compression connections
- Bi-stable magnetic solenoid
- Four (4) "AA" alkaline batteries
- Double infrared sensors with automatic setting feature
- Single hole installation (pedestal)
- Includes all mounting hardware
- 3 year limited warranty
- Chrome plated finish

---

## Recommended specifications

Sloan BASYS Model No. EFX-300-PLG-CP-0.5GPM-MLM-IR-FCT Infrared Sensor Activated Electronic Handwashing Faucet for pretempered or hot/cold water supplies. Product to have double infrared sensors with automatic setting feature. Solenoid valve housed in removable carrier that closes water supply upon removal eliminating, need to access control stops. Solenoid carrier includes strainer for easy above deck service. Thermostatic mixer ordered separately to comply with ASSE 1070 requirements. The product shall be tested and certified to industry standards: ASME A112.18.1M, CSA B125.1, California Health and Safety Code 116875

---

## Electrical specifications

- Battery Life: 3 years 8,000 cycles/month
- Optional power harvesting significantly extends service life
- Sensor Range: 4" -5" (102-127 mm)

---

## Warranty

[View Warranty Information](#)

---

## Notes

All information contained within this document subject to change without notice.

Looking for other variations of the EFX-300 product? [View the general spec sheet with all options.](#)

[Find a matching soap dispenser](#) for this faucet.

[Find a compatible sink](#) for this faucet

**EFX-300.00X.0X1X Faucet**  
with Single Line Water Supply

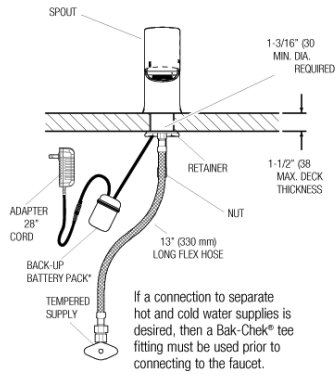

**EFX-300.50X.0X1X Faucet**  
with Hot & Cold Water Supply

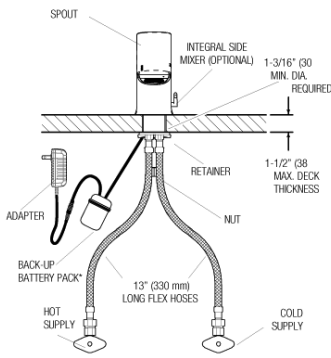

**EFX-300.X0X.0X1X Faucet**  
with Hot & Cold Water Supply

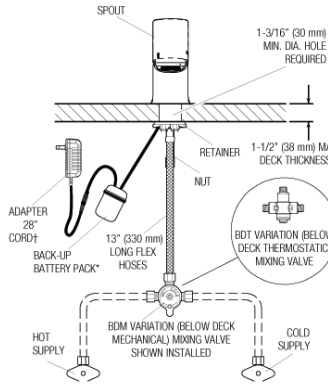

**Electrical Connection for up to 6 Faucets**  
Can combine up to six (6) faucets using one adapter

