



A CSW Industrials Company

PRODUCT DATA SHEET

SLIMDUCT®

Premium Lineset Duct and Fittings

Description

The Slimduct premium lineset cover system is designed to protect and conceal exposed ducted and ductless HVAC piping. It complements any residence or business with a finished look. Slimduct helps to organize multiple lineset applications while protecting linesets from environmental factors. It's "snap together" design and unique features allow for quick installation, saving time and money.

Additional information:

- Weather and fire resistant; UV stabilized: Tested to over 2,000 hours. Temp range: (-4°F to 140°F).
- Protects linesets from pets, pest, and vandals: Flat bottom channel and elbow hugs wall, eliminates insect, bird nests.
- Rigid Construction: For challenging installations and extreme conditions.
- Wider Design: Allows for multiple linesets under one cover.
- Deeper Profile: Provides more room to work and accommodates thicker insulation per latest codes.

Applications

Covers and fittings for the majority of applications; available in a wide assortment of sizes, grades, and colors. Avoids damage to HVAC systems by protecting lineset, wiring, and drain hose from weather, vandalism, pet and pest damage.

Lineset Cover Kits

Kit includes 13' of duct (two 6.6' lengths) and all essential fittings to hide and protect the lineset for a typical A/C installation. Available in white only. Each SDK Kit includes:

- SD - Ducting 39" Long (4)
- SJ - Couplers (2)
- SW - Wall Inlet (1)
- SEN - End Fitting (1)
- SK - 90° flat ELL (1)





















Characteristics | Features

- Premium post paint Finish
- Heavy duty grade
- Easy and quick installation, saving time and money
- UV, weather and fire resistant
- Stylish, complements any residential or commercial building
- Professional grade polymers to deliver long lasting durability
- 78" duct lengths, 5 lengths per box

SLIMDUCT®

Premium Lineset Duct and Fittings



	RS# (ref. #) White	RS# (ref. #) Ivory	RS# (ref. #) Brown	Description	L	W	H
	86032 (SKS-77-W)	86012 (SKS-77-I)	85072 (SKS-77-B)	SD 2.75" 45° flat ELL	5 1/2"	5 1/2"	2 3/5"
	85004 (SD-77-W)	85024 (SD-77-I)	85064 (SD-77-B)	SD Slimduct 78" L - 77	78"	2 7/8"	2 3/8"
	85104 (SD-100-W)	85124 (SD-100-I)	85164 (SD-100-B)	SD Slimduct 78" L - 100	78"	4"	2 3/4"
	85204 (SD-140-W)	85224 (SD-140-I)	85264 (SD-140-B)	SD Slimduct 78" L - 140	78"	5 3/8"	3 1/4"
	86010 (SJ-77-W)	86030 (SJ-77-I)	85370 (SJ-77-B)	SJ coupler 77	2"	3 3/8"	2 5/8"
	86110 (SJ-100-W)	86130 (SJ-100-I)	85470 (SJ-100-B)	SJ coupler 100	2 1/2"	4 1/4"	3"
	86210 (SJ-140-W)	86230 (SJ-140-I)	85570 (SJ-140-B)	SJ coupler 140	3 1/2"	5 3/4"	3 3/8"
	86016 (SW-77-W)	86036 (SW-77-I)	85376 (SW-77-B)	SW wall inlet 77	8"	4 3/8"	3"
	86116 (SW-100-W)	86136 (SW-100-I)	85476 (SW-100-B)	SW wall inlet 100	8 3/4"	5"	3 3/8"
	85216 (SW-140-W)	85236 (SW-140-I)	85576 (SW-140-B)	SW wall inlet 140	11"	6 1/2"	3 3/8"
	85014 (SP-77-W)	85034 (SP-77-I)	85374 (SP-77-B)	SP soffit inlet 77	5 1/8"	4 3/8"	5 1/8"
	86114 (SP-100-W)	86134 (SP-100-I)	85474 (SP-100-B)	SP soffit inlet 100	5 3/8"	5 3/8"	5 3/8"
	85214 (SP-140-W)	85234 (SP-140-I)	85574 (SP-140-B)	SP soffit inlet 140	5 3/4"	6 7/8"	5 3/4"
	86007 (SE/SEN-77-W)	86027 (SE/SEN-77-I)	85367 (SE/SEN-77-B)	SEN end fitting 77	1 3/4"	3 1/4"	2 5/8"
	86107 (SEN-100-W)	86127 (SEN-100-I)	85467 (SEN-100-B)	SEN end fitting 100	4 1/2"	4 1/4"	3"
	86207 (SEN-140-W)	86227 (SEN-140-I)	85567 (SEN-140-B)	SEN end fitting 140	6"	5 3/4"	3 3/8"
	86011 (SK-77-W)	86031 (SK-77-I)	85371 (SK-77-B)	SK 90° flat ELL 77	5"	2 5/8"	5"
	86111 (SK-100-W)	86131 (SK-100-I)	85471 (SK-100-B)	SK 90° flat ELL 100	6"	3"	6"
	85211 (SK-140-W)	85231 (SK-140-I)	85571 (SK-140-B)	SK 90° flat ELL 140	7 1/2"	3 3/8"	7 1/2"
	85012 (SKF-77-W)	85032 (SKF-77-I)	85372 (SKF-77-B)	SKF 45° flat ELL 77	4 1/2"	3 1/4"	2 5/8"
	86112 (SKF-100-W)	86132 (SKF-100-I)	85472 (SKF-100-B)	SKF 45° flat ELL 100	5 1/4"	4 1/4"	3"
	85212 (SKF-140-W)	85232 (SKF-140-I)	85572 (SKF-140-B)	SKF 45° flat ELL 140	6 1/4"	5 3/4"	3 3/8"
	86002 (SC-77-W)	86022 (SC-77-I)	85362 (SC-77-B)	SC 90° vertical ELL 77	4"	3 1/4"	4"
	86102 (SC-100-W)	86122 (SC-100-I)	85462 (SC-100-B)	SC 90° vertical ELL 100	4 5/8"	4 1/4"	4 5/8"
	85202 (SC-140-W)	85222 (SC-140-I)	85562 (SC-140-B)	SC 90° vertical ELL 140	5"	5 3/4"	5"
	85000 (SCF-77-W)	85020 (SCF-77-I)	85360 (SCF-77-B)	SCF 45° vertical ELL 77	4 1/8"	3 1/4"	2 5/8"
	86100 (SCF-100-W)	86120 (SCF-100-I)	85460 (SCF-100-B)	SCF 45° vertical ELL 100	4 3/8"	4 1/4"	3"
	85200 (SCF-140-W)	85220 (SCF-140-I)	85560 (SCF-140-B)	SCF 45° vertical ELL 140	4 5/8"	5 3/4"	3 3/8"
	86015 (ST-77-W)	86035 (ST-77-I)	85375 (ST-77-B)	ST TEE 77	6 1/2"	4 7/8"	2 5/8"
	86115 (ST-100-W)	86135 (ST-100-I)	85475 (ST-100-B)	ST TEE 100	7 7/8"	6"	3"
	85215 (ST-140-W)	85235 (ST-140-I)	85575 (ST-140-B)	ST TEE 140	9 7/8"	7 7/8"	3"
	85106 (SDR-100-77-W)	85126 (SDR-100-77-I)	85466 (SDR-100-77-B)	SDR reducer 100-77	2 1/2"	4 1/4"	3"
	86206 (SDR-140-100-W)	86226 (SDR-140-100-I)	85566 (SDR-140-100-B)	SDR reducer 140-100	4"	5 3/4"	3 3/8"
	86018 (SIF-77-W)	86038 (SIF-77-I)	85378 (SIF-77-B)	SIF 2" fixed offset 77	7 1/8"	3 1/4"	3 1/4"
	86118 (SIF-100-W)	86138 (SIF-100-I)	85478 (SIF-100-B)	SIF 2" fixed offset 100	7 1/8"	4 1/4"	4 1/4"
	-	-	85395 (SN-77-B)	SD 2.75" Twist ELL 77	5 1/2"	5 1/2"	3 3/16"
	85008 (SF-77-500-W)	85028 (SF-77-500-I)	85368 (SF-77-500-B)	SF flex ELL 20" L - 77-500	19 1/2"	3"	2 1/2"
	86108 (SF-100-800-W)	86128 (SF-100-800-I)	85468 (SF-100-800-B)	SF flex ELL 31" L - 100-800	31 1/2"	4"	2 3/4"
	85208 (SF-140-800-W)	85228 (SF-140-800-I)	85568 (SF-140-800-B)	SF flex ELL 31" L - 140-800	31 1/2"	5 3/4"	3 3/8"
	85009 (SFJ-77-W)	85029 (SFJ-77-I)	85369 (SFJ-77-B)	SFJ flex adapter 77	1 3/8"	3 1/4"	3 1/4"
	85109 (SFJ-100-W)	85129 (SFJ-100-I)	85469 (SFJ-100-B)	SFJ flex adapter 100	1 1/2"	4 1/4"	4 1/4"
	86001 (SFS-77)	-	-	SFS saddle for flex ELL 77	1 3/8"	3 1/4"	2 1/2"
	86101 (SFS-100)	-	-	SFS saddle for flex ELL 100	1 1/2"	3 1/4"	3"
	86201 (SFS-140)	-	-	SFS saddle for flex ELL 140	1 1/2"	4 1/4"	3"
	86299 (SL-300)	-	-	SL strap kit for line sets	-	-	-

Pacakaging

Code	Description	Color	Qty per Case	Lbs. per Case	Cubic Ft per Case
85000	SCF-77-W, SCF 45° vertical ELL 77	White	20	0.25	0.73
85004	SD-77-W, SD Slimduct 78" L - 77	White	5	14.56	2.65
85008	SF-77-500-W, SF flex ELL 20" L - 77-500	White	20	9.22	1.95
85009	SFJ-77-W, SFJ flex adapter 77	White	20	0.11	0.23
85012	SKF-77-W, SKF 45° flat ELL 77	White	20	5.64	0.71
85014	SP-77-W, SP soffit inlet 77	White	10	4.9	0.93
85020	SCF-77-I, SCF 45° vertical ELL 77	Ivory	20	0.25	0.73
85024	SD-77-I, SD Slimduct 78" L - 77	Ivory	5	14.56	2.65
85028	SF-77-500-I, SF flex ELL 20" L - 77-500	Ivory	20	9.22	1.95
85029	SFJ-77-I, SFJ flex adapter 77	Ivory	20	2.2	0.23
85032	SKF-77-I, SKF 45° flat ELL 77	Ivory	20	4.8	0.71
85034	SP-77-I, SP soffit inlet 77	Ivory	10	3.3	0.93
85064	SD-77-B, SD Slimduct 78" L - 77	Brown	5	15	2.65
85072	SKS-77-B, SD 2.75" 45° flat ELL	Brown	1	0.322	0.05
85080	SN-77-W, SD 2.75" twist ELL 77	White	5	2.5	0.41
85085	SN-77-I, SD 2.75" twist ELL 77	Ivory	5	2.5	0.41
85104	SD-100-W, SD Slimduct 78" L - 100	White	5	24.5	2.78
85106	SDR-100-77-W, SDR reducer 100-77	White	20	4.4	0.48
85109	SFJ-100-W, SFJ flex adapter 100	White	20	3	0.36
85124	SD-100-I, SD Slimduct 78" L - 100	Ivory	5	24.5	2.78
85126	SDR-100-77-I, SDR reducer 100-77	Ivory	20	4.4	0.48
85129	SFJ-100-I, SFJ flex adapter 100	Ivory	20	3	0.36
85164	SD-100-B, SD Slimduct 78" L - 100	Brown	5	24.5	2.78
85200	SCF-140-W, SCF 45° vertical ELL 140	White	5	2.25	0.46
85202	SC-140-W, SC 90° vertical ELL 140	White	5	4	0.54
85204	SD-140-W, SD Slimduct 78" L - 140	White	5	36	2.01
85208	SF-140-800-W, SF flex ELL 31" L - 140-800	White	5	4.88	2.10
85211	SK-140-W, SK 90° flat ELL 140	White	5	2.65	0.67

Code	Description	Color	Qty per Case	Lbs. per Case	Cubic Ft per Case
85212	SKF-140-W, SKF 45° flat ELL 140	White	5	1.58	0.55
85214	SP-140-W, SP soffit inlet 140	White	5	1.07	0.41
85215	ST-140-W, ST TEE 140	White	5	4.7	1.14
85216	SW-140-W, SW wall inlet 140	White	5	6	0.99
85220	SCF-140-I, SCF 45° vertical ELL 140	Ivory	5	1.13	0.46
85222	SC-140-I, SC 90° vertical ELL 140	Ivory	5	4	0.54
85224	SD-140-I, SD Slimduct 78" L - 140	Ivory	5	36	2.01
85228	SF-140-800-I, SF flex ELL 31" L - 140-800	Ivory	5	4.88	2.10
85231	SK-140-I, SK 90° flat ELL 140	Ivory	5	2.65	0.67
85232	SKF-140-I, SKF 45° flat ELL 140	Ivory	5	1.58	0.55
85234	SP-140-I, SP soffit inlet 140	Ivory	5	1.75	0.41
85235	ST-140-I, ST TEE 140	Ivory	5	7.75	1.14
85236	SW-140-I, SW wall inlet 140	Ivory	5	6.35	0.99
85264	SD-140-B, SD Slimduct 78" L - 140	Brown	5	36	2.01
85360	SCF-77-B, SCF 45° vertical ELL 77	Brown	1	0.25	0.02
85362	SC-77-B, SC 90° vertical ELL 77	Brown	1	0.17	0.03
85367	SE/SEN-77-B, SEN end fitting 77	Brown	1	0.22	0.01
85368	SF-77-500-B, SF flex ELL 20" L - 77-500	Brown	1	0.46	0.08
85369	SFJ-77-B, SFJ flex adapter 77	Brown	1	0.11	0.01
85370	SJ-77-B, SJ coupler 77	Brown	1	0.17	0.01
85371	SK-77-B, SK 90° flat ELL 77	Brown	1	0.46	0.04
85372	SKF-77-B, SKF 45° flat ELL 77	Brown	1	0.28	0.02
85374	SP-77-B, SP soffit inlet 77	Brown	1	0.25	0.07
85375	ST-77-B, ST TEE 77	Brown	1	0.77	0.05
85376	SW-77-B, SW wall inlet 77	Brown	1	0.49	0.06
85378	SIF-77-B, SIF 2" fixed offset 77	Brown	1	0.5	0.04
85395	SN-77-B	Brown	1	0.5	0.05
85460	SCF-100-B, SCF 45° vertical ELL 100	Brown	1	0.36	0.03
85462	SC-100-B, SC 90° vertical ELL 100	Brown	1	0.55	0.05

Code	Description	Color	Qty per Case	Lbs. per Case	Cubic Ft per Case
85466	SDR-100-77-B, SDR reducer 100-77	Brown	1	0.22	0.02
85467	SEN-100-B, SEN end fitting 100	Brown	1	0.37	0.03
85468	SF-100-800-B, SF flex ELL 31" L - 100-800	Brown	1	1.2	0.20
85469	SFJ-100-B, SFJ flex adapter 100	Brown	1	0.15	0.02
85470	SJ-100-B, SJ coupler 100	Brown	1	0.25	0.02
85471	SK-100-B, SK 90° flat ELL 100	Brown	1	0.62	0.06
85472	SKF-100-B, SKF 45° flat ELL 100	Brown	1	0.41	0.04
85474	SP-100-B, SP soffit inlet 100	Brown	1	0.42	0.09
85475	ST-100-B, ST TEE 100	Brown	1	0.63	0.08
85476	SW-100-B, SW wall inlet 100	Brown	1	0.74	0.09
85478	SIF-100-B, SIF 2" fixed offset 100	Brown	1	0.75	0.07
85560	SCF-140-B, SCF 45° vertical ELL 140	Brown	1	0.35	0.07
85562	SC-140-B, SC 90° vertical ELL 140	Brown	1	0.78	0.08
85566	SDR-140-100-B, SDR reducer 140-100	Brown	1	0.33	0.04
85567	SEN-140-B, SEN end fitting 140	Brown	1	0.66	0.07
85568	SF-140-800-B, SF flex ELL 31" L - 140-800	Brown	1	1.95	0.35
85570	SJ-140B, SJ coupler 140	Brown	1	0.41	0.04
85571	SK-140-B, SK 90° flat ELL 140	Brown	1	1.06	0.11
85572	SKF-140-B, SKF 45° flat ELL 140	Brown	1	0.63	0.07
85574	SP-140-B, SP soffit inlet 140	Brown	1	0.43	0.07
85575	ST-140-B, ST TEE 140	Brown	1	1.89	0.14
85576	SW-140-B, SW wall inlet 140	Brown	1	1.28	0.16
86001	SFS-77, SFS saddle for flex ELL 77	White	10	0.88	0.30
86002	SC-77-W, SC 90° vertical ELL 77	White	10	3.45	0.67
86007	SE/SEN-77-W, SEN end fitting 77	White	10	2.2	0.27
86010	SJ-77-W, SJ coupler 77	White	10	1.62	0.32
86011	SK-77-W, SK 90° flat ELL 77	White	10	4.62	0.97
86012	SKS-77-I, SD 2.75" 45° flat ELL	Ivory	10	3.97	0.60
86015	ST-77-W, ST TEE 77	White	10	7.7	0.82

Code	Description	Color	Qty per Case	Lbs. per Case	Cubic Ft per Case
86016	SW-77-W, SW wall inlet 77	White	10	4.85	1.18
86018	SIF-77-W, SIF 2" fixed offset 77	White	10	5	0.83
86022	SC-77-I, SC 90° vertical ELL 77	Ivory	10	3.45	2.42
86027	SE/SEN-77-I, SEN end fitting 77	Ivory	10	2.2	0.98
86030	SJ-77-I, SJ coupler 77	Ivory	10	1.62	1.18
86031	SK-77-I, SK 90° flat ELL 77	Ivory	10	4.62	3.20
86032	SKS-77-W, SD 2.75" 45° flat ELL	White	10	3.97	0.60
86035	ST-77-I, ST TEE 77	Ivory	10	7.7	0.82
86036	SW-77-I, SW wall inlet 77	Ivory	10	4.85	3.87
86038	SIF-77-I, SIF 2" fixed offset 77	Ivory	10	5	0.83
86100	SCF-100-W, SCF 45° vertical ELL 100	White	10	3.45	0.54
86101	SFS-100, SFS saddle for flex ELL 100	White	10	0.95	0.31
86102	SC-100-W, SC 90° vertical ELL 100	White	10	5.52	0.67
86107	SEN-100-W, SEN end fitting 100	White	10	3.73	0.81
86108	SF-100-800-W, SF flex ELL 31" L - 100-800	White	10	7.5	2.57
86110	SJ-100-W, SJ coupler 100	White	10	3.73	0.51
86111	SK-100-W, SK 90° flat ELL 100	White	10	26	0.73
86112	SKF-100-W, SKF 45° flat ELL 100	White	10	6.2	0.64
86114	SP-100-W, SP soffit inlet 100	White	10	3.5	0.61
86115	ST-100-W, ST TEE 100	White	10	16.3	1.69
86116	SW-100-W, SW wall inlet 100	White	10	6.2	0.97
86118	SIF-100-W, SIF 2" fixed offset 100	White	10	7.45	0.99
86120	SCF-100-I, SCF 45° vertical ELL 100	Ivory	10	3.59	0.54
86122	SC-100-I, SC 90° vertical ELL 100	Ivory	10	5.52	0.67
86127	SEN-100-I, SEN end fitting 100	Ivory	10	3.74	0.81
86128	SF-100-800-I, SF flex ELL 31" L - 100-800	Ivory	10	7.5	2.57
86130	SJ-100-I, SJ coupler 100	Ivory	10	2.5	0.51
86131	SK-100-I, SK 90° flat ELL 100	Ivory	10	6.2	0.73
86132	SKF-100-I, SKF 45° flat ELL 100	Ivory	10	4.1	0.64

Code	Description	Color	Qty per Case	Lbs. per Case	Cubic Ft per Case
86134	SP-100-I, SP soffit inlet 100	Ivory	10	4.17	0.61
86135	ST-100-I, ST TEE 100	Ivory	10	16.3	1.69
86136	SW-100-I, SW wall inlet 100	Ivory	10	7.35	0.97
86138	SIF-100-I, SIF 2" fixed offset 100	Ivory	10	5.5	0.99
86201	SFS-140, SFS saddle for flex ELL 140	White	10	4.5	0.38
86206	SDR-140-100-W, SDR reducer 140-100	White	10	3.3	0.58
86207	SEN-140-W, SEN end fitting 140	White	10	6.55	0.83
86210	SJ-140-W, SJ coupler 140	White	10	4.4	0.47
86226	SDR-140-100-I, SDR reducer 140-100	Ivory	10	3.3	0.58
86227	SEN-140-I, SEN end fitting 140	Ivory	10	6.55	0.83
86230	SJ-140-I, SJ coupler 140	Ivory	10	4.4	0.47
86299	SL-300. SL strap kit for linesets	White	10	1.24	0.62
KIT					
85005	SDK77W Kit, Slimduct 2 3/4" kit	White	1	9	1.11
85105	SDK100W Kit, Slimduct 3 3/4" kit	White	1	10	1.11

Installation Instructions

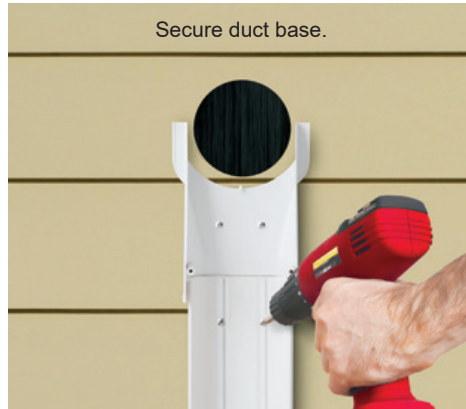
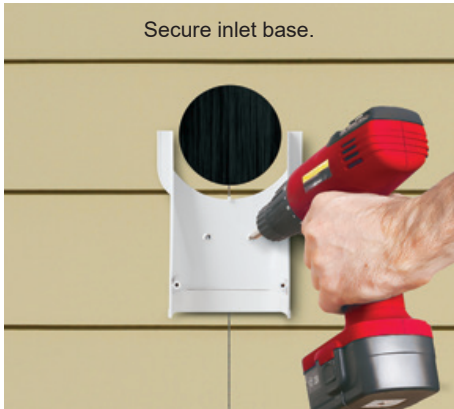

(1) Determine the path which the lineset will follow and strike a chalk line to mark the surface material. Attach the base only of all fittings first (ducting will be placed last), along the marked path, using fasteners of sufficient length (not provided). Pre-drill where necessary.

Duct must terminate with a fitting to prevent cover from sliding out of position.

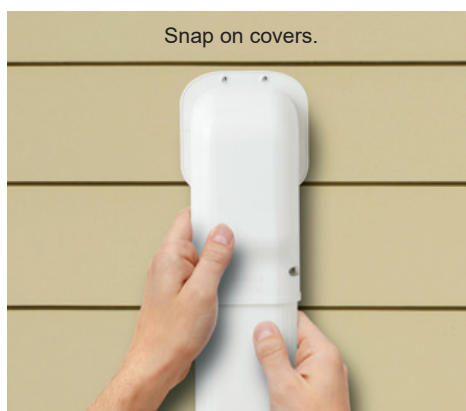
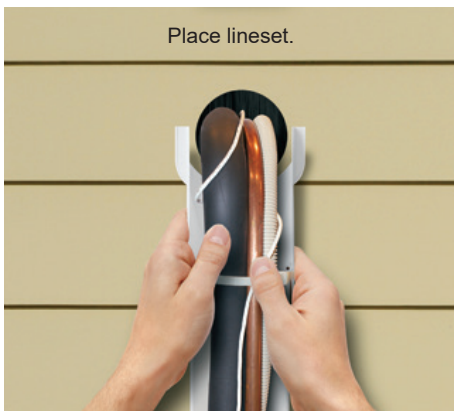

(3) Secure optional SL300 straps (strap kit not included) evenly spaced inside Slimduct. Run lineset, drain hose, wiring etc. over the fitting/duct bases and straps. Tighten straps to secure.

(4) Snap straight duct top over mating straight base pieces. Seat fitting tops over mating fitting bases and secure with provided stainless screws.

Duct must terminate with a fitting to prevent cover from sliding out of position.

SD-77 27/8" W x 23/8" D

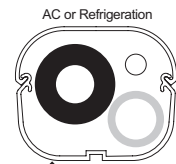

SD-77 w/Single 3/4" Lineset
 BTU - 35,000
 Suction Line - 11/8"OD
 (Insulation) - 1/2"
 Liquid Line - 1/2"OD
 Drain Line - 3/4"PVC

SD-100 4" W x 23/4" D

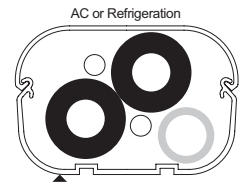

SD-100 w/Dual 3/4" Lineset
 BTU - 36,000
 Suction Lines - 3/4"OD
 (Insulation) - 3/8"
 Liquid Lines - 3/8"OD
 Drain Line - 3/4"PVC

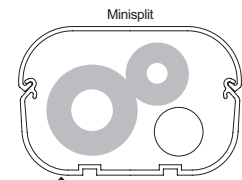

SD-100 w/Single 3/4" Lineset
 BTU - 42,000
 Suction Line - 3/4"OD
 (Insulation) - 1/2"
 Liquid Line - 3/8"OD
 (Insulation) - 1/2"
 Drain Hose - 7/8" OD

SD-140 53/8" W x 31/8" D

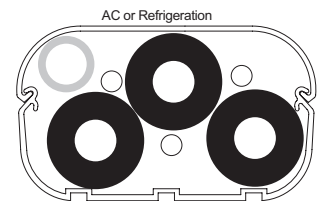

SD-140 w/Triple 3/4" Lineset
 BTU - 36,000
 Suction Lines - 3/4"OD
 (Insulation) - 1/2"
 Liquid Lines - 3/8"OD
 Drain Line - 3/4"PVC

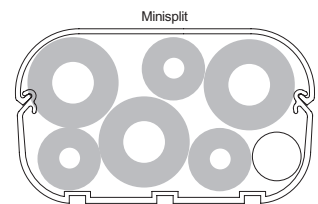

SD-140 w/Triple 3/4" Lineset
 BTU - 42,000
 Suction Lines - 3/4"OD
 (Insulation) - 1/2"
 Liquid Lines - 3/8"OD
 (Insulation) - 1/2"
 Drain Hose - 7/8" OD

Specialty Fitting Installation Instructions

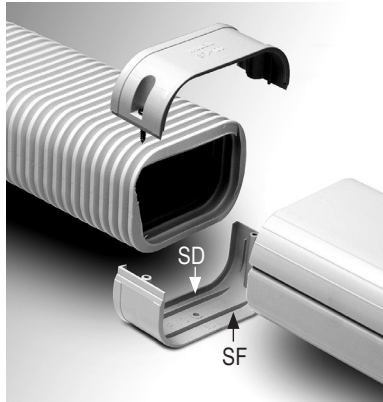
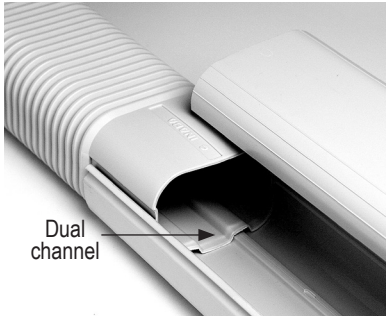

Flexible ELL SF

Installation style A

1. Slip lineset through Flexible ELL
2. Mate the dual channel side of Flexible ELL end into the dual channel of the Duct Base
3. Snap on Duct Cover.

Installation style B

1. Cut off ends of Flexible ELL at ridges.
2. Slip lineset through Flexible ELL
3. Slip Flexible Adaptor base under Duct base with SD side toward the Flexible ELL.
4. Drop Flexible ELL into SF side of Flexible Adaptor base.
5. Cover with Flexible Adaptor Cap and secure with screws provided.



End Fitting SEN

End fitting provides critical support to the lineset duct cover. Without this fitting, the duct cover can slide out of place.

1. Determine the size of the lineset to exit the end fitting.
2. Snip the end fitting along the desired groove, and break off unwanted sections. A coupling can also be utilized at the duct end for larger lineset fill.

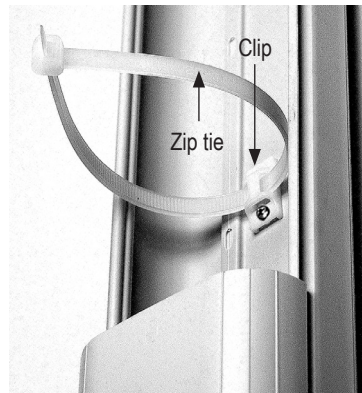

Strap Kit SL300

Strap kit tightens lineset together and holds lineset in place.

1. Center and screw clip to back of duct base.
2. Slip zip tie through clip.
3. Install lineset over open zip tie.
4. Close and tighten zip tie around lineset.
5. Snap on duct cover.

Limited Warranty



For more information on our product limited warranty, visit RectorSeal.com

Distributed by

RectorSeal, LLC

2601 Spenwick Drive • Houston, TX 77055, USA • 800-231-3345 • Fax 800-441-0051 • rectorseal.com

A CSW Industrials Company. RectorSeal, the logos and other trademarks are property of RectorSeal, LLC, its affiliates or its licensor's and are protected by copyright, trademark and other intellectual property laws, and may not be used without permission. RectorSeal reserves the right to change specifications without prior notice. ©2021 RectorSeal. All rights reserved. R50560-1021