

Definitions: Safety Alert Symbols and Words

This instruction manual uses the following safety alert symbols and words to alert you to hazardous situations and your risk of personal injury or property damage.







-  **DANGER:** Indicates an imminently hazardous situation which, if not avoided, **will** result in **death or serious injury**.
-  **WARNING:** Indicates a potentially hazardous situation which, if not avoided, **could** result in **death or serious injury**.
-  **CAUTION:** Indicates a potentially hazardous situation which, if not avoided, **may** result in **minor or moderate injury**.
-  (Used without word) Indicates a safety related message.
- NOTICE:** Indicates a practice **not related to personal injury** which, if not avoided, **may** result in **property damage**.

Fig. A

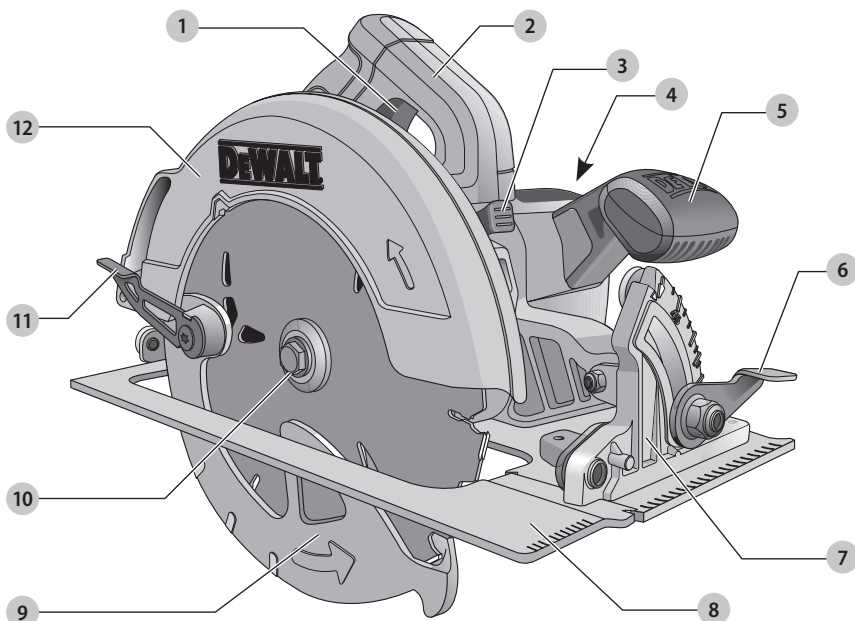

- 1 Trigger switch
- 2 Main handle
- 3 Blade lock
- 4 End cap
- 5 Auxiliary handle
- 6 Bevel adjustment lever
- 7 Bevel angle adjustment
- 8 Foot plate
- 9 Lower blade guard
- 10 Blade clamping screw
- 11 Lower guard lever
- 12 Upper blade guard

 **WARNING: Read all safety warnings and all instructions.** Failure to follow the warnings and instructions may result in electric shock, fire and/or serious injury.

 **WARNING:** To reduce the risk of injury, read the instruction manual.

If you have any questions or comments about this or any product, call DEWALT toll free at: (1-800-433-9258).

7-1/4" (184 mm) Circular Saws DWE574

GENERAL POWER TOOL SAFETY WARNINGS



WARNING: Read all safety warnings, instructions, illustrations and specifications provided with this power tool. Failure to follow all instructions listed below may result in electric shock, fire and/or serious injury.

SAVE ALL WARNINGS AND INSTRUCTIONS FOR FUTURE REFERENCE.

The term "power tool" in the warnings refers to your mains-operated (corded) power tool or battery-operated (cordless) power tool.

1) Work Area Safety

- a) **Keep work area clean and well lit.** Cluttered or dark areas invite accidents.
- b) **Do not operate power tools in explosive atmospheres, such as in the presence of flammable liquids, gases or dust.** Power tools create sparks which may ignite the dust or fumes.
- c) **Keep children and bystanders away while operating a power tool.** Distractions can cause you to lose control.

2) Electrical Safety

- a) **Power tool plugs must match the outlet. Never modify the plug in any way. Do not use any adapter plugs with earthed (grounded) power tools.** Unmodified plugs and matching outlets will reduce risk of electric shock.
- b) **Avoid body contact with earthed or grounded surfaces, such as pipes, radiators, ranges and refrigerators.** There is an increased risk of electric shock if your body is earthed or grounded.
- c) **Do not expose power tools to rain or wet conditions.** Water entering a power tool will increase the risk of electric shock.
- d) **Do not abuse the cord. Never use the cord for carrying, pulling or unplugging the power tool. Keep cord away from heat, oil, sharp edges or moving parts.** Damaged or entangled cords increase the risk of electric shock.
- e) **When operating a power tool outdoors, use an extension cord suitable for outdoor use.** Use of a cord suitable for outdoor use reduces the risk of electric shock.
- f) **If operating a power tool in a damp location is unavoidable, use a ground fault circuit interrupter (GFCI) protected supply.** Use of a GFCI reduces the risk of electric shock.

3) Personal Safety

- a) **Stay alert, watch what you are doing and use common sense when operating a power tool. Do not use a power tool while you are tired or under the influence of drugs, alcohol or medication.** A

moment of inattention while operating power tools may result in serious personal injury.

- b) **Use personal protective equipment. Always wear eye protection.** Protective equipment such as a dust mask, non-skid safety shoes, hard hat, or hearing protection used for appropriate conditions will reduce personal injuries.
- c) **Prevent unintentional starting. Ensure the switch is in the off-position before connecting to power source and/or battery pack, picking up or carrying the tool.** Carrying power tools with your finger on the switch or energizing power tools that have the switch on invites accidents.
- d) **Remove any adjusting key or wrench before turning the power tool on.** A wrench or a key left attached to a rotating part of the power tool may result in personal injury.
- e) **Do not overreach. Keep proper footing and balance at all times.** This enables better control of the power tool in unexpected situations.
- f) **Dress properly. Do not wear loose clothing or jewelry. Keep your hair, clothing and gloves away from moving parts.** Loose clothes, jewelry or long hair can be caught in moving parts.
- g) **If devices are provided for the connection of dust extraction and collection facilities, ensure these are connected and properly used.** Use of dust collection can reduce dust-related hazards.
- h) **Do not let familiarity gained from frequent use of tools allow you to become complacent and ignore tool safety principles.** A careless action can cause severe injury within a fraction of a second.

4) Power Tool Use and Care

- a) **Do not force the power tool. Use the correct power tool for your application.** The correct power tool will do the job better and safer at the rate for which it was designed.
- b) **Do not use the power tool if the switch does not turn it on and off.** Any power tool that cannot be controlled with the switch is dangerous and must be repaired.
- c) **Disconnect the plug from the power source and/or remove the battery pack, if detachable, from the power tool before making any adjustments, changing accessories, or storing power tools.** Such preventive safety measures reduce the risk of starting the power tool accidentally.
- d) **Store idle power tools out of the reach of children and do not allow persons unfamiliar with the power tool or these instructions to operate the power tool.** Power tools are dangerous in the hands of untrained users.
- e) **Maintain power tools and accessories. Check for misalignment or binding of moving parts, breakage of parts and any other condition that may affect the power tool's operation. If**

damaged, have the power tool repaired before use. Many accidents are caused by poorly maintained power tools.

- f) **Keep cutting tools sharp and clean.** Properly maintained cutting tools with sharp cutting edges are less likely to bind and are easier to control.
- g) **Use the power tool, accessories and tool bits etc. in accordance with these instructions, taking into account the working conditions and the work to be performed.** Use of the power tool for operations different from those intended could result in a hazardous situation.
- h) **Keep handles and grasping surfaces dry, clean and free from oil and grease.** Slippery handles and grasping surfaces do not allow for safe handling and control of the tool in unexpected situations.

5) Service

- a) **Have your power tool serviced by a qualified repair person using only identical replacement parts.** This will ensure that the safety of the power tool is maintained.

Safety Instructions for All Saws

Cutting Procedures

- a) **⚠ DANGER: Keep hands away from cutting area and the blade. Keep your second hand on auxiliary handle, or motor housing.** If both hands are holding the saw, they cannot be cut by the blade.
- b) **Do not reach underneath the workpiece.** The guard cannot protect you from the blade below the workpiece.
- c) **Adjust the cutting depth to the thickness of the workpiece.** Less than a full tooth of the blade teeth should be visible below the workpiece.
- d) **Never hold the workpiece in your hands or across your leg while cutting. Secure the workpiece to a stable platform.** It is important to support the work properly to minimize body exposure, blade binding, or loss of control.
- e) **Hold the power tool by insulated gripping surfaces, when performing an operation where the cutting tool may contact hidden wiring or its own cord.** Contact with a "live" wire will also make exposed metal parts of the power tool "live" and could give the operator an electric shock.
- f) **When ripping, always use a rip fence or straight edge guide.** This improves the accuracy of cut and reduces the chance of blade binding.
- g) **Always use blades with correct size and shape (diamond versus round) of arbor holes.** Blades that do not match the mounting hardware of the saw will run off-center, causing loss of control.
- h) **Never use damaged or incorrect blade washers or bolt.** The blade washers and bolt were specially designed for your saw, for optimum performance and safety of operation.

Further Safety Instructions for all Saws

Kickback Causes and Related Warnings

- Kickback is a sudden reaction to a pinched, jammed or misaligned saw blade, causing an uncontrolled saw to lift up and out of the workpiece toward the operator;
- When the blade is pinched or jammed tightly by the kerf closing down, the blade stalls and the motor reaction drives the unit rapidly back toward the operator;
- If the blade becomes twisted or misaligned in the cut, the teeth at the back edge of the blade can dig into the top surface of the wood causing the blade to climb out of the kerf and jump back toward the operator.

Kickback is the result of saw misuse and/or incorrect operating procedures or conditions and can be avoided by taking proper precautions as given below:

- a) **Maintain a firm grip with both hands on the saw and position your arms to resist kickback forces. Position your body to either side of the blade, but not in line with the blade.** Kickback could cause the saw to jump backwards, but kickback forces can be controlled by the operator, if proper precautions are taken.
- b) **When blade is binding, or when interrupting a cut for any reason, release the trigger and hold the saw motionless in the material until the blade comes to a complete stop. Never attempt to remove the saw from the work or pull the saw backward while the blade is in motion or kickback may occur.** Investigate and take corrective actions to eliminate the cause of blade binding.
- c) **When restarting a saw in the workpiece, center the saw blade in the kerf so that the saw teeth are not engaged into the material.** If a saw blade binds, it may walk up or kickback from the workpiece as the saw is restarted.
- d) **Support large panels to minimize the risk of blade pinching and kickback.** Large panels tend to sag under their own weight. Supports must be placed under the panel on both sides, near the line of cut and near the edge of the panel.
- e) **Do not use dull or damaged blades.** Unsharpened or improperly set blades produce narrow kerf causing excessive friction, blade binding and kickback.
- f) **Blade depth and bevel adjusting locking levers must be tight and secure before making cut.** If blade adjustment shifts while cutting, it may cause binding and kickback.
- g) **Use extra caution when sawing into existing walls or other blind areas.** The protruding blade may cut objects that can cause kickback.

Lower Guard Function

- a) **Check the lower guard for proper closing before each use. Do not operate the saw if the lower guard does not move freely and close instantly. Never clamp or tie the lower guard into the open**

position. If saw is accidentally dropped, lower guard may be bent. Raise the lower guard with the retracting handle and make sure it moves freely and does not touch the blade or any other part, in all angles and depths of cut.

- b) **Check the operation of the lower guard spring. If the guard and the spring are not operating properly, they must be serviced before use.** Lower guard may operate sluggishly due to damaged parts, gummy deposits, or a build-up of debris.
- c) **The lower guard may be retracted manually only for special cuts such as “plunge cuts” and “compound cuts.” Raise the lower guard by retracting the handle and as soon as the blade enters the material, the lower guard must be released.** For all other sawing, the lower guard should operate automatically.
- d) **Always observe that the lower guard is covering the blade before placing saw down on bench or floor.** An unprotected, coasting blade will cause the saw to walk backwards, cutting whatever is in its path. Be aware of the time it takes for the blade to stop after switch is released.

Additional Safety Information

 **WARNING:** Never modify the power tool or any part of it. Damage or personal injury could result.

 **WARNING: ALWAYS** use safety glasses. Everyday eyeglasses are NOT safety glasses. Also use face or dust mask if operation is dusty. ALL USERS AND BYSTANDERS MUST ALWAYS WEAR CERTIFIED SAFETY EQUIPMENT:

- ANSI Z87.1 eye protection (CAN/CSA Z94.3),
- ANSI S12.6 (S3.19) hearing protection,
- NIOSH/OSHA/MSHA respiratory protection.

 **WARNING:** Some dust created by power sanding, sawing, grinding, drilling, and other construction activities contains chemicals known to the State of California to cause cancer, birth defects or other reproductive harm. Some examples of these chemicals are:

- lead from lead-based paints,
- crystalline silica from bricks and cement and other masonry products, and
- arsenic and chromium from chemically-treated lumber.

Your risk from these exposures varies, depending on how often you do this type of work. To reduce your exposure to these chemicals: work in a well ventilated area, and work with approved safety equipment, such as those dust masks that are specially designed to filter out microscopic particles.

- **Avoid prolonged contact with dust from power sanding, sawing, grinding, drilling, and other construction activities. Wear protective clothing and wash exposed areas with soap and water.** Allowing

dust to get into your mouth, eyes, or lay on the skin may promote absorption of harmful chemicals.

 **WARNING:** Use of this tool can generate and/or disperse dust, which may cause serious and permanent respiratory or other injury. Always use NIOSH/OSHA approved respiratory protection appropriate for the dust exposure. Direct particles away from face and body.

 **WARNING: Always wear proper personal hearing protection that conforms to ANSI S12.6 (S3.19) during use.** Under some conditions and duration of use, noise from this product may contribute to hearing loss.











 **CAUTION: When not in use, place tool on its side on a stable surface where it will not cause a tripping or falling hazard.** Some tools will stand upright but may be easily knocked over.

- **Air vents often cover moving parts and should be avoided.** Loose clothes, jewelry or long hair can be caught in moving parts.
- **An extension cord must have adequate wire size (AWG or American Wire Gauge) for safety.** The smaller the gauge number of the wire, the greater the capacity of the cable, that is, 16 gauge has more capacity than 18 gauge. An undersized cord will cause a drop in line voltage resulting in loss of power and overheating. When using more than one extension to make up the total length, be sure each individual extension contains at least the minimum wire size. The following table shows the correct size to use depending on cord length and nameplate ampere rating. If in doubt, use the next heavier gauge. The lower the gauge number, the heavier the cord.

Minimum Gauge for Cord Sets					
Volts	Total Length of Cord in Feet (meters)				
	120V	25 (7.6)	50 (15.2)	100 (30.5)	150 (45.7)
240V	50 (15.2)	100 (30.5)	200 (61.0)	300 (91.4)	
Ampere Rating		American Wire Gauge			
More Than	Not More Than				
0	6	18	16	16	14
6	10	18	16	14	12
10	12	16	16	14	12
12	16	14	12	Not Recommended	

The label on your tool may include the following symbols. The symbols and their definitions are as follows:

- V volts
- RPM revolutions per minute
- Hz hertz
- s fpm surface feet per minute
- min minutes
- — — or DC..... direct current
- Ⓢ Class I Construction (grounded)
- SPM strokes per minute
- OPM..... oscillations per minute
- ... /min..... per minute
- A amperes
- BPM beats per minute
- W watts
- IPM impacts per minute
- ~ or AC..... alternating current

 or AC/DC....alternating or direct current	avoid staring at light
Class II Construction (double insulated)	wear respiratory protection
n_0no load speed	wear eye protection
nrated speed	wear hearing protection
earthing terminal	read all documentation
safety alert symbol	IPXX
visible radiation	

Motor

Be sure your power supply agrees with the nameplate marking. Voltage decrease of more than 10% will cause loss of power and overheating. These tools are factory tested; if this tool does not operate, check power supply.

Intended Use

This heavy-duty circular saw is designed for professional wood cutting applications. Do not cut metal, plastic, concrete, masonry or fiber cement materials.

 **WARNING:** Do not cut any metals, masonry, glass, tile or plastic with this saw. A dull blade will cause slow, inefficient cutting overload on the saw motor, excessive splintering, and could increase the possibility of kickback.

- DO NOT use any abrasive wheels.
- Use only blades designed for wood cutting.

 **WARNING:** Cutting sap coated wood, and other materials may cause melted substances to accumulate on the blade tips and the body of the saw blade, increasing the risk of the blade overheating and binding while cutting.

DO NOT use under wet conditions or in presence of flammable liquids or gases.

These heavy-duty saws are professional power tools.

DO NOT let children come into contact with the tool.

Supervision is required when inexperienced operators use this tool.

ASSEMBLY AND ADJUSTMENTS

 **WARNING:** To reduce the risk of serious personal injury, turn unit off and disconnect it from power source before making any adjustments or removing/installing attachments or accessories. An accidental start-up can cause injury.

Changing Blades

To Install the Blade (Fig. B–D)

1. Using the lower guard lever **11**, retract the lower blade guard **9** and place blade on saw spindle against the inner clamp washer **13**, making sure that the blade will rotate in the proper direction (the direction of the rotation arrow on the saw blade and the teeth must point in the same direction as the direction of rotation arrow on the saw). Do not assume that the printing

on the blade will always be facing you when properly installed. When retracting the lower blade guard to install the blade, check the condition and operation of the lower blade guard to assure that it is working properly. Make sure it moves freely and does not touch the blade or any other part, in all angles and depths of cut.

2. Place outer clamp washer **14** on saw spindle with the large flat surface against the blade and the wording on the outer clamp washer facing you.
3. Thread blade clamping screw **10** into saw spindle by hand (screw has right-hand threads and must be turned clockwise to tighten).
4. Depress the blade lock **3** while turning the saw spindle with the blade wrench **15** stored underneath the main handle **2** (Fig. D), until the blade lock engages and the blade stops rotating.
5. Tighten the blade clamping screw firmly with the blade wrench.

Fig. B

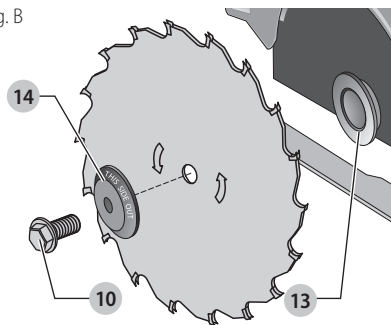
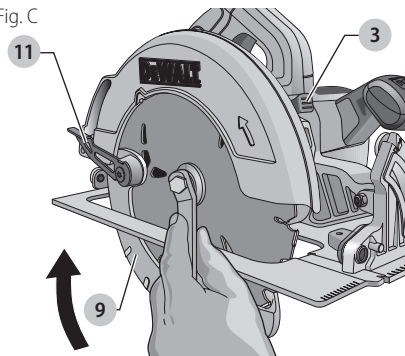

Fig. C



NOTE: Never engage the blade lock while saw is running, or engage in an effort to stop the tool. Never turn the saw on while the blade lock is engaged. Serious damage to your saw will result.

To Replace the Blade (Fig. B–D)

1. To loosen the blade clamping screw **10**, depress the blade lock **3** and turn the saw spindle with the blade wrench **15**, stored underneath the main handle **2**, until the blade lock engages and the blade stops rotating. With the blade lock engaged, turn the blade

clamping screw counterclockwise with the blade wrench (screw has right-hand threads and must be turned counterclockwise to loosen).

Fig. D

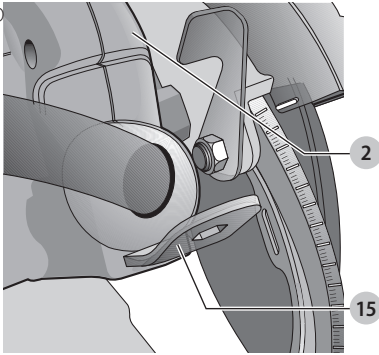

2. Remove the blade clamping screw **10** and outer clamp washer **14**. Remove old blade.
3. Clean any sawdust that may have accumulated in the guard or clamp washer area and check the condition and operation of the lower blade guard as previously outlined. Do not lubricate this area.
4. Select the proper blade for the application (refer to **Recommended Blade Types** under **Blades**). Always use blades that are the correct size (7–1/4" [178 mm] diameter) with the proper size and shape center hole for mounting on the saw spindle. Always assure that the maximum recommended speed (rpm) on the saw blade meets or exceeds the speed (rpm) of the saw.
5. Follow steps 1 through 5 under **To Install the Blade**, making sure that the blade will rotate in the proper direction.

Lower Blade Guard

⚠ WARNING: *The lower blade guard is a safety feature which reduces the risk of serious personal injury. Never use the saw if the lower blade guard is missing, damaged, misassembled or not working properly. Do not rely on the lower blade guard to protect you under all circumstances. Your safety depends on following all warnings and precautions as well as proper operation of the saw. Check lower blade guard for proper closing before each use as outlined in Further Safety Instructions for All Saws. If the lower blade guard is missing or not working properly, have the saw serviced before using. To assure product safety and reliability, repair, maintenance and adjustment should be performed by an authorized service center or other qualified service organization, always using identical replacement parts.*

Blades

⚠ WARNING: *To minimize the risk of eye injury, always use eye protection. Carbide is a hard but brittle material. Foreign objects in the workpiece such as wire*

or nails can cause tips to crack or break. Only operate saw when proper saw blade guard is in place. Mount blade securely in proper rotation direction before using, and always use a clean, sharp blade.

⚠ WARNING: *Do not cut metal, plastic, concrete, masonry or fiber cement materials with this saw.*

Do not use abrasive wheels or blades. A dull blade will cause slow inefficient cutting, overload on the saw motor, excessive splintering, and could increase the possibility of kickback. Please refer to the table below to determine the correct size replacement blade for your model saw.

RECOMMENDED BLADE TYPES

Combination Framing	5/8" Round arbor, 24 teeth All purpose fast rip and cross cuts.
Pressure Treated/Wet Lumber	5/8" Round arbor, 20 teeth Coated, resistant to gum build-up.
Extreme Durability	5/8" Round arbor, 18 teeth Coated, rock carbide.
Finishing	5/8" Round arbor, 36 teeth More teeth for finer finish cuts.
Fast Cut Framing	5/8" round arbor, 18 teeth Fastest blade for rips and cross cuts.

If you need assistance regarding blades, please call 1-800-4-DEWALT (1-800-433-9258).

Kickback

Kickback is a sudden reaction to a pinched, bound or misaligned saw blade, causing an uncontrolled saw to lift up and out of the workpiece toward the operator. When the blade is pinched or bound tightly by the kerf closing down, the blade stalls and the motor reaction drives the unit rapidly back toward the operator. If the blade becomes twisted or misaligned in the cut, the teeth at the back edge of the blade can dig into the top surface of the wood causing the blade to climb out of the kerf and jump back toward the operator.

Kickback is more likely to occur when any of the following conditions exists.

1. **IMPROPER WORKPIECE SUPPORT**
 - a. Sagging or improper lifting of the cut off piece can cause pinching of the blade and lead to kickback.
 - b. Cutting through material supported at the outer ends only can cause kickback. As the material weakens it sags, closing down the kerf and pinching the blade (Fig. N).
 - c. Cutting off a cantilevered or overhanging piece of material from the bottom up in a vertical direction can cause kickback. The falling cut off piece can pinch the blade.
 - d. Cutting off long narrow strips (as in ripping) can cause kickback. The cut off strip can sag or twist closing the kerf and pinching the blade.

- e. Snagging the lower guard on a surface below the material being cut momentarily reduces operator control. The saw can lift partially out of the cut increasing the chance of blade twist.

2. IMPROPER DEPTH OF CUT SETTING ON SAW

- a. To make the most efficient cut, the blade should protrude only far enough to expose one-half of a tooth as shown in Figure F. This allows the shoe to support the blade and minimizes twisting and pinching in the material. See the section titled **Cutting Depth Adjustment**.

3. BLADE TWISTING (MISALIGNMENT IN CUT)

- a. Pushing harder to cut through a knot, a nail or a hard grain area can cause the blade to twist.
 b. Trying to turn the saw in the cut (trying to get back on the marked line) can cause blade twist.
 c. Overreaching or operating the saw with poor body control (out of balance), can result in twisting the blade.
 d. Changing hand grip or body position while cutting can result in blade twist.
 e. Backing up the saw to clear blade can lead to twist.

4. MATERIALS THAT REQUIRE EXTRA ATTENTION

- a. Wet lumber
 b. Green lumber (material freshly cut or not kiln dried)
 c. Pressure treated lumber (material treated with preservatives or anti-rot chemicals)

5. USE OF DULL OR DIRTY BLADES

- a. Dull blades cause increased loading of the saw. To compensate, an operator will usually push harder which further loads the unit and promotes twisting of the blade in the kerf. Worn blades may also have insufficient body clearance which increases the chance of binding and increased loading.

6. LIFTING THE SAW WHEN MAKING A BEVEL CUT

- a. Bevel cuts require special operator attention to proper cutting techniques – especially guidance of the saw. Both blade angle to the shoe and greater blade surface in the material increase the chance for binding and misalignment (twist) to occur.

7. RESTARTING A CUT WITH THE BLADE TEETH JAMMED AGAINST THE MATERIAL

- a. The saw should be brought up to full operating speed before starting a cut or restarting a cut after the unit has been stopped with the blade in the kerf. Failure to do so can cause stalling and kickback.

Any other conditions which could result in pinching, binding, twisting, or misalignment of the blade could cause kickback. Refer to the sections **Further Safety Instructions for All Saws** and **Blades** for procedures and techniques that will minimize the occurrence of kickback.

Cutting Depth Adjustment (Fig. E–G)

NOTE: The maximum depth of cut for this saw is 2-9/16" (65 mm) at 90°.

1. Hold the saw firmly. Raise the depth adjustment lever **16** to loosen and move foot plate to obtain the desired depth of cut, as shown. Make sure the depth adjustment lever has been retightened (lowered) before operating the saw.
2. Align the appropriate mark on the depth adjustment strap **17** with notch **18** on the upper blade guard. Your depth is set.

For the most efficient cutting action, set the depth adjustment so that one-half tooth of the blade will project below the material to be cut. This distance is from the tip of the tooth to the bottom of the gullet in front of it. This keeps blade friction at a minimum, removes sawdust from the cut, results in cooler, faster sawing and reduces the chance of kickback. A method for checking for correct cutting depth is shown in Figure G. Lay a piece of the material you plan to cut along the side of the blade, as shown, and observe how much tooth projects beyond the material.

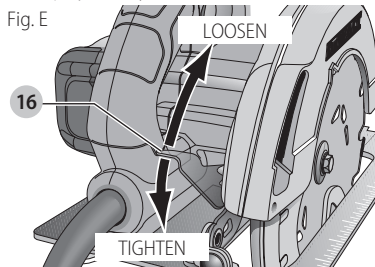

Fig. F

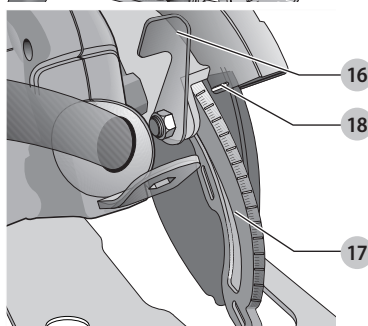
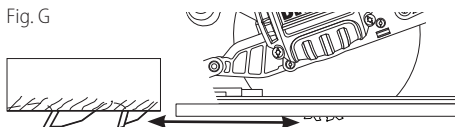

Fig. G



Bevel Angle Adjustment (Fig. A, H)

The full range of the bevel adjustment is from 0° to 57°. The quadrant is graduated in increments of 1°. On the front of the saw is a bevel angle adjustment mechanism consisting of a calibrated quadrant and a bevel adjustment lever **6**.

To Set the Saw for a Bevel Cut

1. Loosen (counterclockwise) the bevel adjustment lever **6** and tilt shoe (**8**, Fig. A) to the desired angle by aligning the pointer with the desired angle mark.
2. Retighten lever firmly (clockwise).

Fig. H

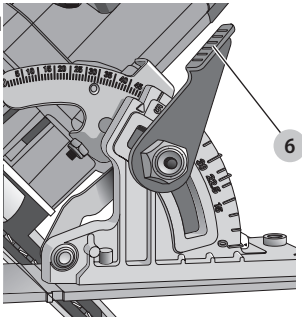

Shoe Adjustment for 90° Cuts (Fig. H, I)

If Additional Adjustment is Needed

1. Adjust the saw to 0° bevel.
2. Retract the lower blade guard. Place the saw on blade side.
3. Loosen bevel adjustment lever (6, Fig. H). Place a square against the blade and shoe to adjust the 90° setting.
4. Turn the calibration screw (19, Fig. I) so that the shoe will stop at the proper angle.
5. Confirm the accuracy of the setting by checking the squareness of an actual cut on a scrap piece of material.

Fig. I

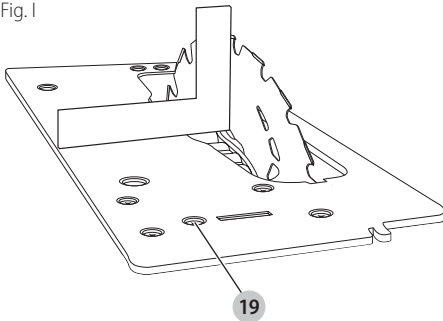

Kerf Indicator (Fig. J)

The front of the saw shoe has a kerf indicator 22 for vertical and bevel cutting. This indicator enables you to guide the saw along cutting lines penciled on the material being cut. The kerf indicator lines up with the left (inner) side of the saw blade, which makes the slot or “kerf” cut by the moving blade fall to the right of the indicator. Guide along the penciled cutting line so that the kerf falls into the waste or surplus material.

Fig. J

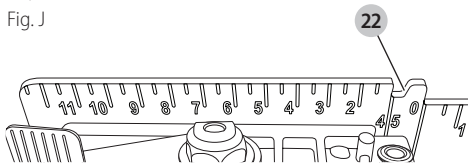

Cut Length Indicator (Fig. K)

The markings on the side of the foot plate show the length of the slot being cut into the material at the full depth of the cut. The markings are in increments of 1/8" (3.2 mm).

Fig. K

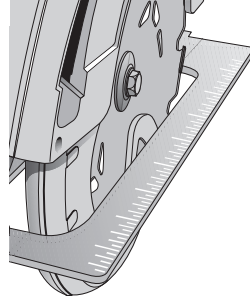

OPERATION

! **WARNING:** To reduce the risk of serious personal injury, turn unit off and disconnect it from power source before making any adjustments or removing/installing attachments or accessories. An accidental start-up can cause injury.

Proper Hand Position (Fig. L)

! **WARNING:** To reduce the risk of serious personal injury, ALWAYS use proper hand position as shown.

! **WARNING:** To reduce the risk of serious personal injury, ALWAYS hold securely in anticipation of a sudden reaction.

Proper hand position requires one hand on the auxiliary handle 5 and one hand on the main handle 2.

Fig. L

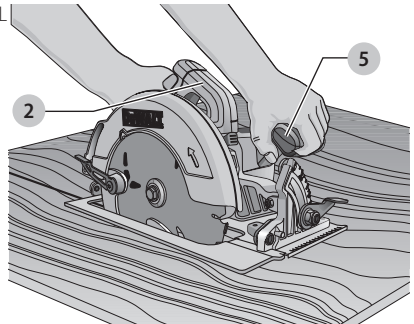

Trigger Switch (Fig. A)

! **WARNING:** This tool has no provision to lock the trigger switch in the ON position and should never be locked ON by any other means.

Pull the trigger switch 1 to turn the motor on. Releasing the trigger turns the motor off. This tool has no provision to lock the switch in the on position, and the tool should never be locked on in any way.

Workpiece Support (Fig. L–N)

! **WARNING:** It is important to support the work properly and to hold the saw firmly to prevent loss of

control which could cause personal injury. Figure L illustrates proper hand support of the saw. Maintain a firm grip with both hands on the saw and position your body and arm to allow you to resist kickback if it occurs. **ALWAYS TURN OFF TOOL AND REMOVE BATTERY BEFORE MAKING ANY ADJUSTMENTS!**

Figure L shows proper sawing position. Note that hands are kept away from cutting area. **To avoid kickback,** DO support board or panel NEAR the cut (Fig. M). DON'T support board or panel away from the cut (Fig. N).

Place the work with its "good" side – the one on which appearance is most important – down. The saw cuts upward, so any splintering will be on the work face that is up when you cut it.

Fig. M

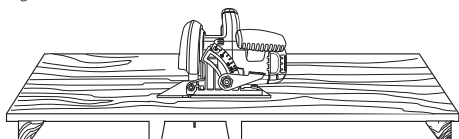
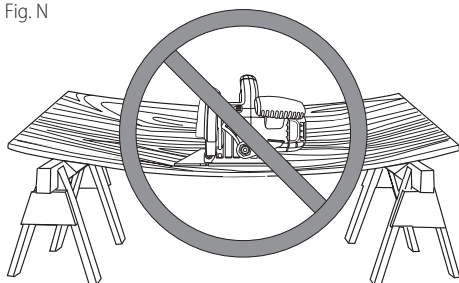
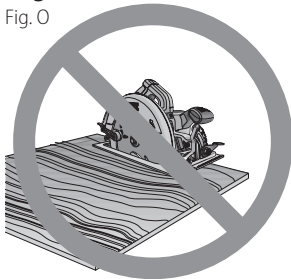

Fig. N



Cutting (Fig. O)

Fig. O



Place the wider portion of the saw shoe on that part of the workpiece which is solidly supported, not on the section that will fall off when the cut is made. As an example, Figure O illustrates the RIGHT way to cut off the end of a board. Always clamp work. Don't try to hold short pieces by hand! Remember to support cantilevered and overhanging material. Use caution when sawing material from below.

Be sure saw is up to full speed before blade contacts material to be cut. Starting saw with blade against material to be cut or pushed forward into kerf can result in kickback. Push the saw forward at a speed which allows the blade to cut without laboring.

Hardness and toughness can vary even in the same piece of material, and knotty or damp sections can put a heavy load on the saw. When this happens, push the saw more slowly, but hard enough to keep working without much decrease in speed. Forcing the saw can cause rough cuts, inaccuracy, kickback, and over-heating of the motor.

Should your cut begin to go off the line, don't try to force it back on. Release the trigger switch and allow blade to come to a complete stop. Then you can withdraw the saw, sight anew, and start a new cut slightly inside the wrong one. Withdraw the saw if you must shift the cut. Forcing a correction inside the cut can stall the saw and lead to kickback.

IF SAW STALLS, RELEASE THE TRIGGER SWITCH AND BACK THE SAW UNTIL IT IS LOOSE. BE SURE BLADE IS STRAIGHT IN THE CUT AND CLEAR OF THE CUTTING EDGE BEFORE RESTARTING.

As you finish a cut, release the trigger switch and allow the blade to stop before lifting the saw from the work. As you lift the saw, the spring-tensioned lower blade guard will automatically close under the blade. Remember the blade is exposed until this occurs. Never reach under the work for any reason. When you have to retract the lower blade guard manually (as is necessary for starting pocket cuts), always use the retracting lever.



WARNING: When cutting thin strips, be careful to ensure that small cutoff pieces don't hang up on the inside of the lower blade guard.

Ripping (Fig. P)

Ripping is the process of cutting wider boards into narrower strips – cutting grain lengthwise. Hand guiding is more difficult for this type of sawing and the use of a DEWALT rip fence is recommended.

Fig. P

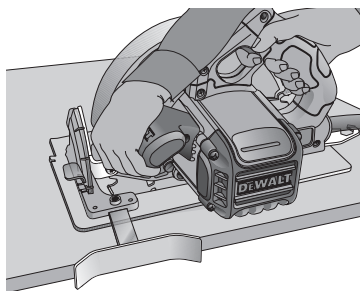

Pocket Cutting (Fig. Q)



WARNING: Never tie the lower blade guard in a raised position. Never move the saw backwards when pocket cutting. This may cause the saw to raise up off the work surface, which could cause injury.

Fig. Q

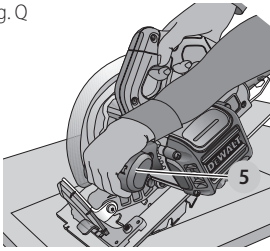

A pocket cut is one that is made in a floor, wall or other flat surface.

1. Adjust the saw shoe so the blade cuts at desired depth.
2. Tilt the saw forward and rest front of the shoe on material to be cut.
3. Using the lower blade guard retracting lever, retract the lower blade guard to an upward position. Lower the rear of the shoe until the blade teeth almost touch the cutting line.
4. Release the lower blade guard (its contact with the work will keep it in position to open freely as you start the cut). Remove your hand from the lower blade guard retracting lever and firmly grip the auxiliary handle **5**, as shown in Figure Q. Position your body and arm to allow you to resist kickback if it occurs.
5. Make sure blade is not in contact with cutting surface before starting saw.
6. Start the motor and gradually lower the saw until its shoe rests flat on the material to be cut. Advance saw along the cutting line until cut is completed.
7. Release the trigger switch and allow the blade to stop completely before withdrawing the blade from the material.
8. When starting each new cut, repeat the above steps.

MAINTENANCE

WARNING: To reduce the risk of serious personal injury, turn unit off and disconnect it from power source before making any adjustments or removing/installing attachments or accessories. An accidental start-up can cause injury.

Cleaning

WARNING: Blow dirt and dust out of all air vents with clean, dry air at least once a week. To minimize the risk of eye injury, always wear ANSI Z87.1 approved eye protection when performing this procedure.

WARNING: Never use solvents or other harsh chemicals for cleaning the non-metallic parts of the tool. These chemicals may weaken the plastic materials used in these parts. Use a cloth dampened only with water and mild soap. Never let any liquid get inside the tool; never immerse any part of the tool into a liquid.

Lubrication

Self lubricating ball and roller bearings are used in the tool and relubrication is not required. However, it is

recommended that, once a year, you take or send the tool to a service center for a thorough cleaning, inspection and lubrication of the gear case.

Electric Brake (DWE575SB)

Your saw has an automatic electric brake which is designed to stop the blade from coasting in about two seconds, after you release the trigger switch. It is useful when making certain cuts in wood where a coasting blade would result in a wide, imprecise cut.

Occasionally, the brake will not function properly and won't stop the saw in the 2 seconds discussed above. If this condition persists, turn the saw on and off four or five times. If the brake still does not stop the blade in about 2 seconds, the problem may be worn brushes. Have the brushes replaced at a DeWALT authorized service center.

Repairs

WARNING: To assure product SAFETY and RELIABILITY, repairs, maintenance and adjustment (including brush inspection and replacement) should be performed by a DeWALT factory service center or a DeWALT authorized service center. Always use identical replacement parts..

Refer to **Brushes** for brush replacement information.

Brushes (Fig. R)

WARNING: To reduce the risk of injury, turn unit off and disconnect it from power source before installing and removing accessories, before adjusting or when making repairs. An accidental start-up can cause injury.

Inspect carbon brushes regularly by disconnecting the tool from the power source, removing the four end cap screws **20** with a screwdriver, then removing the end cap **4**.

Fig. R

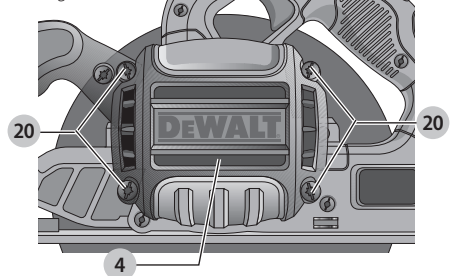

Keep brushes clean and sliding freely in their guides. Always replace a used brush in the same orientation in the holder as it was prior to removal. Carbon brushes have varying symbols stamped into their sides, and if either brush is worn down to the line closest to the spring, take the tool to a DeWALT authorized service center for brush assembly replacement. Use only identical DeWALT brushes. Always replace the end cap after inspecting or servicing brushes. The tool should be allowed to "run in" (run at

no load without a blade) for 5 minutes before use to seat new brushes.

While “running in” DO NOT TIE, TAPE, OR OTHERWISE LOCK THE TRIGGER SWITCH ON. HOLD BY HAND ONLY.

Accessories

! **WARNING:** Since accessories, other than those offered by DEWALT, have not been tested with this product, use of such accessories with this tool could be hazardous. To reduce the risk of injury, only DEWALT recommended accessories should be used with this product.

Recommended accessories for use with your tool are available at extra cost from your local dealer or authorized service center. If you need assistance in locating any accessory, please contact DEWALT call 1-800-4-DEWALT (1-800-433-9258) or visit our website: www.dewalt.com.

Dust Extraction

! **WARNING:** Risk of dust inhalation. To reduce the risk of personal injury, **ALWAYS** wear an approved dust mask.

! **WARNING: ALWAYS** use a vacuum extractor designed in compliance with the applicable directives regarding dust emission when sawing wood. Vacuum hoses of most common vacuum cleaners will fit directly into the dust extraction outlet.

A dust extraction port is available at extra cost from your local dealer or authorized service center.

Assembling the Dust Port (Fig. 5)

1. Align the dust port **23** over upper blade guard **12** as shown.
2. Insert two dust port screws **24** as shown and tighten securely.

Fig. 5

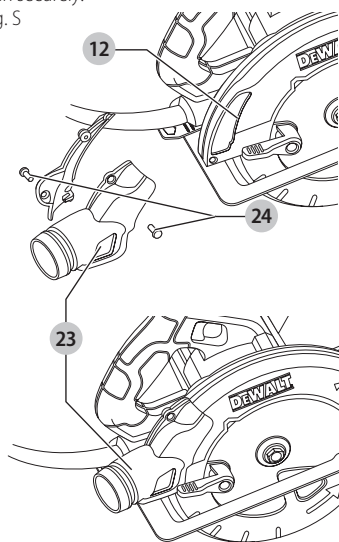

Repairs

! **WARNING:** To assure product SAFETY and RELIABILITY, repairs, maintenance and adjustment (including power cord repairs, and brush inspection and replacement, when applicable) should be performed by a DEWALT factory service center or a DEWALT authorized service center. Always use identical replacement parts.

Register Online

Thank you for your purchase. Register your product now for:

- **WARRANTY SERVICE:** Registering your product will help you obtain more efficient warranty service in case there is a problem with your product.
- **CONFIRMATION OF OWNERSHIP:** In case of an insurance loss, such as fire, flood or theft, your registration of ownership will serve as your proof of purchase.
- **FOR YOUR SAFETY:** Registering your product will allow us to contact you in the unlikely event a safety notification is required under the Federal Consumer Safety Act.
- Register online at www.dewalt.com

Three Year Limited Warranty

DEWALT will repair or replace, without charge, any defects due to faulty materials or workmanship for three years from the date of purchase. This warranty does not cover part failure due to normal wear or tool abuse. For further detail of warranty coverage and warranty repair information, visit www.dewalt.com or call 1-800-4-DEWALT (1-800-433-9258). This warranty does not apply to accessories or damage caused where repairs have been made or attempted by others. THIS LIMITED WARRANTY IS GIVEN IN LIEU OF ALL OTHERS, INCLUDING THE IMPLIED WARRANTY OF MERCHANTABILITY AND FITNESS FOR A PARTICULAR PURPOSE, AND EXCLUDES ALL INCIDENTAL OR CONSEQUENTIAL DAMAGES. Some states do not allow limitations on how long an implied warranty lasts or the exclusion or limitation of incidental or consequential damages, so these limitations may not apply to you. This warranty gives you specific legal rights and you may have other rights which vary in certain states or provinces. In addition to the warranty, DEWALT tools are covered by our:

1 YEAR FREE SERVICE

DEWALT will maintain the tool and replace worn parts caused by normal use, for free, any time during the first year after purchase.

90 DAY MONEY BACK GUARANTEE

If you are not completely satisfied with the performance of your DEWALT Power Tool or Nailer for any reason, you can return it within 90 days from the date of purchase with a receipt for a full refund – no questions asked.

LATIN AMERICA: This warranty does not apply to products sold in Latin America. For products sold in Latin America, see country specific warranty information contained in

ENGLISH

the packaging, call the local company or see website for warranty information.

FREE WARNING LABEL REPLACEMENT: If your warning labels become illegible or are missing, call 1-800-4-DEWALT (1-800-433-9258) for a free replacement.