

M SERIES BLOWER MODULE

Model Number

M 2430 B L 1 - ST2 1
 ① ② ③ ④ ⑤ ⑥ ⑦

- ① **Unit Type**
M=Modular
- ② **Nominal Capacity**
2430=24000 to 30000 Btu/hr (7.0 to 8.8 kW)
3036=30000 to 36000 Btu/hr (8.8 to 10.5 kW)
3642=36000 to 42000 Btu/hr (10.5 to 12.3 kW)
4860=48000 to 60000 Btu/hr (14.0 to 17.5 kW)
- ③ **Module Type**
B=Blower Module
- ④ **Configuration**
L=Left-hand connection
- ⑤ **Revision**
1, 2, 3, etc.
- ⑥ **Power Supply, Motor Type**
ST2=1/60/208-240, single-speed
EC1=1/60/120, variable-speed
EC2=1/50-60/240, variable-speed
- ⑦ **Paint Option**
(Blank)=None
1=White

* A cross-reference chart listing current and past model numbers is available at the end of this bulletin.

General Information

The Unico System patented† modular blowers are designed for use with the Unico System small-duct high-velocity (SDHV) system. The blowers exceed the U.S. Department of Energy requirements for SDHV systems requiring a minimum external static pressure of 1.2 inches of water (0.3 kPa) at the rated airflow when installed with the compatible Unico cooling module. All cooling modules are available in Heat Pump, Chilled Water and refrigerant configurations.

Blower Module	Matching Heating/Cooling Coil Module
M2430BL1	M2430CL1-*
M3036BL1	M3036CL1-*
M3642BL1	M3642CL1-*
M4860BL1	M4860CL1-*

Standard Modules Note: Model numbers listed above may not include the latest revision code.



Figure 1. Typical Blower Module with cutaway revealing motor (-ST2 Model)

Typical Application

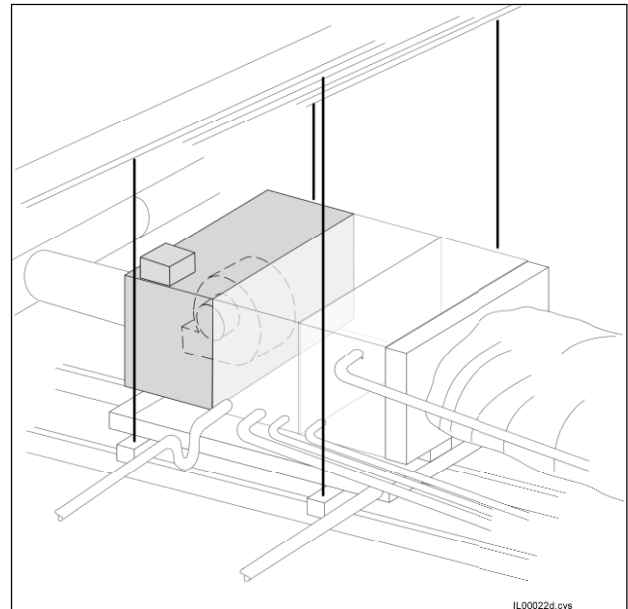

Figure 2. Attic Installation with Unico System Cooling Module, Heating

Applications

For air-conditioning, the rated airflow is 250 CFM per nominal* ton (34 L/kW-s) and for heat pumps it is 275 CFM per nominal ton (37 L/kW-s). For proper operation, we do not recommend flow rates less than 200 CFM per nominal ton (27 L/kW-s). Refer to the *Blower Capacity Data* tables and graphs later in this bulletin for blower performance data showing static pressure and amperage versus air flow.



CERTIFIED TO UL STD 1995
 CONFORMS TO CAN/CSA STD C22.2
 NO. 236

† U.S. Patent No. 5,277,036

* "Nominal" refers to the nameplate size of the condensing unit or heat pump.
 Note — Dimensions and specifications are subject to change without notice.

Motor and Control Box Options

The blower module comes with several different motor and control options as follows.

OLS (Old-Style) – Most economical, single-speed motor, simple sequencer fan relay, transformer, and terminal block. No frills.

ST (Standard Model) – Very economical. Same as the OLS, but additionally includes a variable speed controller for ventilation.

EC (Electronically Commutated) – Part of the Unico *Green Series*. This control box includes a super-efficient variable speed EC motor with the Unico SCB (S.M.A.R.T. Control Board). Features user-programmable speeds.

Control Board Features and Settings

Control Box Configuration	ST	EC
Balanced wheels	✓	✓
Direct drive motor	✓	✓
Shaft key connection	✓	✓
Quick motor replacement (QMR)	✓	✓
Separate control box	✓	✓
Control voltage transformer	✓	✓
Screw terminal connections	✓	✓
Heat pump AFS bypass	✓	✓
Boiler relay	**	✓
Number of modes of operation	2	6
Adjustable low airflow mode	✓	✓
Adjustable restrictor plate	✓	
Efficient ventilation mode		✓
Point-to-point wiring		✓
Electric heater fan interlock		✓
Electric heater stage 3 lockout protection		✓
Chilled water relay		✓
Fan cycling		✓
EAC, ERV, or HRV relay		✓
Potable water circulation		✓
Humidifier compatibility		✓
UniChiller Leader/Follower control		✓
Soft-start and soft-stop		✓
Constant airflow		✓
Low airflow indicator		✓
Preset airflow rate		✓
Laptop configurable		✓
Laptop troubleshooting		✓
Optimized for zone damper systems		✓
Optimized for efficiency and sound		✓

** The ST control box includes room for a relay to be added.

Balanced wheels (ST and EC) – All blower wheels are individually balanced.

Direct drive motor (ST and EC) – The blower wheel is mounted directly to the motor shaft to improve drive efficiency and lower costs.

Shaft key (ST and EC) – The blower wheel is attached to the motor shaft using a square keyway which is more secure than a simple set screw.

Quick motor replacement (QMR) (ST and EC) – The QMR feature is a quick twist-and-lock motor mount for easy maintenance. The motor is mounted to the inlet ring which is attached to the blower housing with six screws through twist-lock keyholes. When service is required by the motor or the wheel, the entire assembly may be removed as a whole. See *Figure 3* for details.

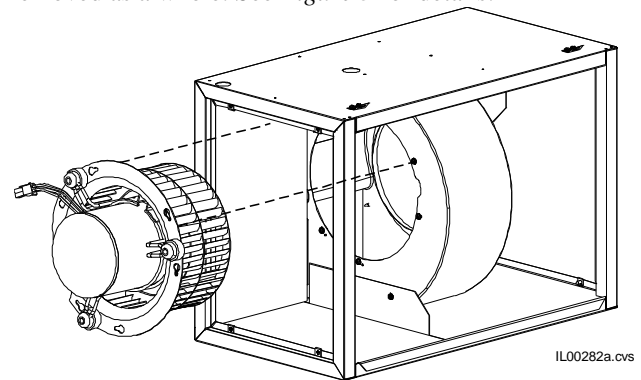

Figure 3. Quick motor replacement (QMR) feature.

Separate control box (ST and EC) – The control box is separate from the cabinet (ships loose) so that it may be mounted to the top or front of the cabinet, depending on which is more convenient. Knockout and starter holes for the screws are provided to assist in mounting. Control boards include the following features:

Control voltage transformer (ST and EC) – A 50VA 24-volt transformer which provides control voltage power to the thermostat, electric heaters, and other optional equipment.

Screw terminal connections (ST and EC) – Terminal blocks with large screws and wire washers to securely connect the control wires.

Heat pump AFS bypass (ST and EC) – Removes the anti-frost switch (AFS) from the circuit during heat pump heating mode which eliminates nuisance shutdowns during defrost mode.

Boiler relay (EC) – The SCB includes a separate dry-contact relay that can be used to turn on the boiler, boiler pump, or hot water coil valve. The ST control box includes room for a relay to be added.

Modes of operation (ST and EC) – The ST control board allows for high and low airflow modes. The EC control board has 6 modes (Fan-Only, Low-Cool, High-Cool, Low-Heat, High-Heat, and Emergency-Heat).

Adjustable low airflow mode (ST and EC) – The ST control board allows the user to adjust the low airflow, but it is not very efficient. The EC board allows the user to program the airflow for each mode, maintaining high efficiency.

Adjustable restrictor plate (ST) – Our patented restrictor plate provides a low-cost solution to finely tune the airflow when using a single speed motor. The adjustable restrictor plate is accessible from the outside front of the unit even with the duct installed.

Point-to-point wiring (EC) – The control boards have separate terminals for the thermostat, electric heater, outdoor condenser, and other options for easy wiring and troubleshooting.

Electric heater fan interlock (EC) – This is a safety feature that prevents the heater from energizing when there is low or no airflow. This prevents the heating elements from overheating, which can severely reduce their useful life.

Electric heater stage 3 lockout protection (EC) – The control board includes a lockout feature to prevent the third stage of the electric heater from turning on if the heat pump is also on. This prevents nuisance shutdowns from overheating the electric heater. This feature can be added to the ST control box by using an outside thermostat.

Chiller water relay (EC)– The control box includes a separate dry-contact relay (ColdW) to turn on a chiller or zone pump.

Fan cycling (EC) – The control board includes a separate switch to provide periodic cycling of the fan to reduce the chance for water to collect in the ducts if located in a cold space and not used, or to provide periodic fresh air if connected to a fresh air source.

EAC, ERV, or HRV relay (EC) – For the optimum in indoor air quality, the control board includes a dry-contact relay to turn on an electronic air cleaner, energy recovery ventilator, or heat recovery ventilator any time the fan is on.

Potable water circulation (EC) – For improved health safety, the control board provides a switch-selectable feature to turn on the boiler pump periodically (if installed as part of a domestic water system) to prevent the formation of stagnant water.

Humidifier compatibility (EC) – The control board includes the ability to connect a humidistat and a humidifier so that the humidistat turns on the humidifier

when needed. The user may choose whether the fan with humidifier operates at the high or low-heat airflow setting.

UniChiller Leader/Follower control (EC) – This feature allows one air handler(Leader) to control the UniChiller mode of operation and force all other air handlers to be dependent(Follower(s)).

Soft-start and soft-stop (EC) – For quieter operation, the unit slowly ramps the motor from stop to full speed, and vice versa.

Constant airflow (EC) – The EC control board will deliver the airflow requested without requiring the user to measure the amperage, or make any other adjustments to the duct system.

Low airflow indicator (EC) – The S.M.A.R.T. control board (SCB) includes an indicator light that signals the user if the desired airflow is not being met. This is usually caused by a restrictive duct system or too few outlets.

Pre-set airflow rate (EC) – The SCB is pre-programmed with two different air flow rates for High-Cool. These rates are based on the nominal tonnage of the unit(See the *Applications* section) and can be selected with a board mounted switch. Each of the six different airflow control modes are a fixed percentage of this selected airflow.

Laptop configurable (EC) – The airflow for each mode of operation is adjustable to any value between the blower minimum and maximum using the ECMconfig software (available for download at www.unicosystem.com) and an ordinary USB cable.

Laptop troubleshooting (EC) – The ECMconfig software will also provide the user with feedback reporting the actual airflow, motor speed, communications status between the control board and the motor, and the state of various inputs and outputs.

Optimized for zoning with hydronic systems (EC) – The ECMconfig software provides an additional feature that allows the user to limit the maximum motor speed. This prevents excessive motor ramping and eliminates the need for bypass loops and pressure switch controls when zone dampers are closed. It reduces noise at the outlets caused by the blower ramping to maintain a constant airflow with fewer outlets. Do not set the maximum airflow to approximate constant static pressure with a single speed condensing unit. Refer to Unico Technical Bulletin 110 on zoning for more information.

Optimized for efficiency and sound (EC) – The EC control uses the lowest motor speed that can achieve the required airflow, which minimizes noise and maximizes electrical efficiency.

Cabinet Construction

The cabinet is constructed of 22 gauge (0.7mm) galvanized steel with removable access panels installed on both sides for ease of service. All access panels are secured with slotted hex head washer screws and hardened steel U-clip nuts to prevent stripping. The cabinet is fully insulated with closed cell insulation. There is no exposed fiberglass inside the cabinet. See dimension drawing.

All blower modules feature electrical connections and service access panels on the left-hand side of the unit when viewing the return with the airflow at your back.

Right hand blowers are available upon request. In this case, the blower discharge opening is near the top of the cabinet.

Dimensional Data

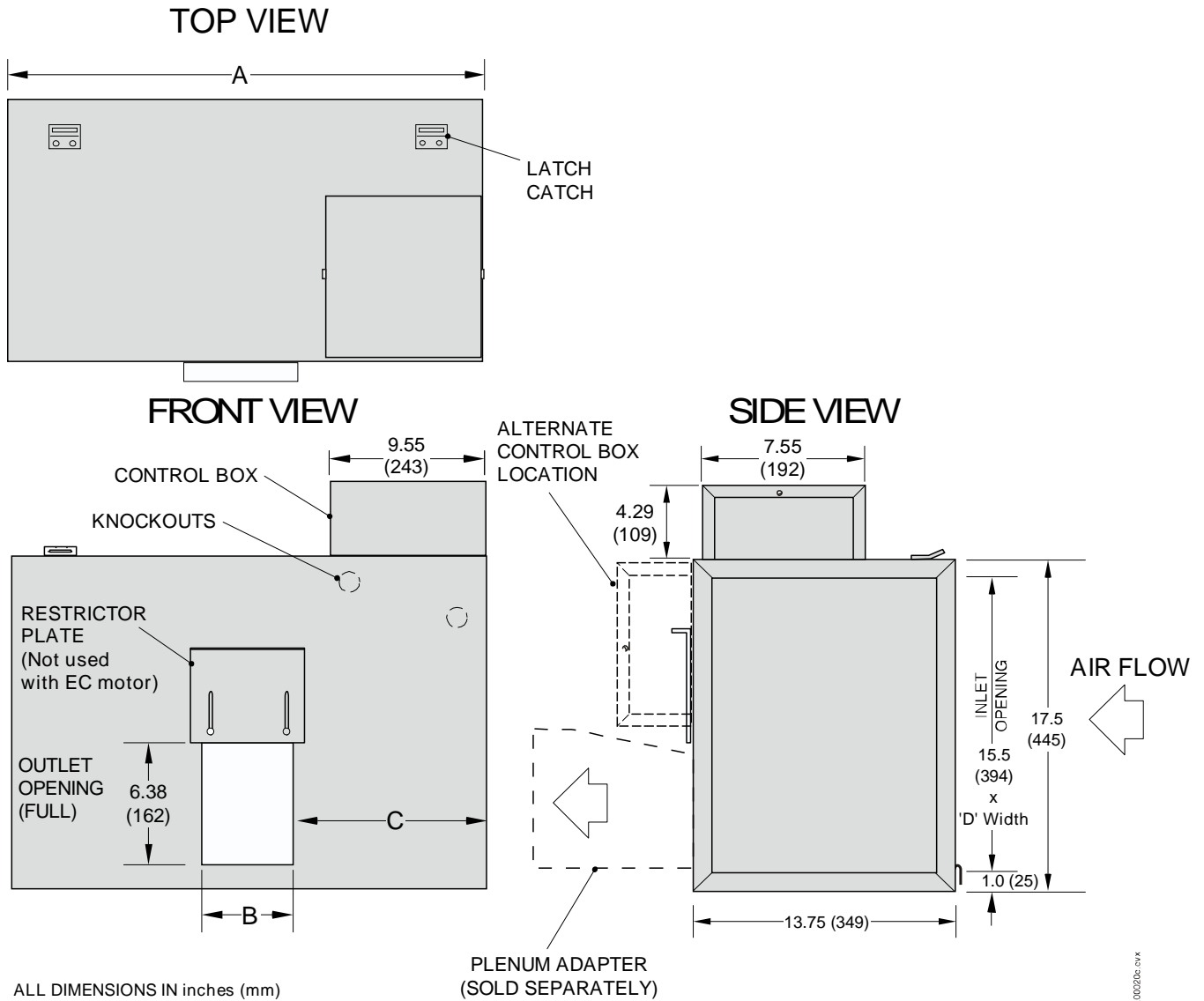

IL0020E.svx

Model No.	M2430BL1	M3036BL1	M3642BL1	M4860BL1
Dimensions [in. (mm)]	A	25.00 (635)	30.00 (762)	38.00 (965)
	B	6.00 (152)	7.24 (184)	7.16 (182)
	C	9.50 (242)	11.38 (289)	15.40 (392)
	D	23.00 (584)	28.00 (711)	36.00 (915)

Blower Module Specifications – 60 Hz

Model No.		M2430BL	M3036BL	M3642BL	M4860BL
Motor Electrical Characteristics	-ST2	208-230V		60Hz	1 phase
	-SCB	120/240V		60Hz	1 phase
Motor Size [HP, (kW)]		1/2 (0.37)	1 (0.75)		
Motor Type	-ST2	PSC			
	-SCB	EC (variable speed)			
Motor Capacitor [mfd.]	-ST2	10			
Motor Capacitor [mfd.]	-SCB	none			
Motor MCA	-ST2	3.8	7.8		
	-SCB 120/240V	7.0 / 4.0	12.8 / 7.7		
Max. Over Current Protection [A]	-ST2	15	15		
	-SCB 120/240V	15 / 15	20 / 15		
Motor Full Load Amps	-ST2	3.0	6.2		
	-SCB 120/240V	5.6 / 3.2	10.2 / 6.1		
Motor Speed [RPM]	-ST2	1625			
	-SCB	400 – 1800			
Blower Wheel Nom. Diameter	[in., (mm)]	9.5 (241)			
Blower Wheel Width	[in., (mm)]	3.75 (95)	5.0 (127)	5.0 (127)	7.75 (197)
Nominal Air Flow Rate*	[CFM, (L/s)]	600 (283)	750 (354)	900 (425)	1250 (590)
Plenum Static Pressure*	[in. w.c., (kPa)]	1.5 (0.373)	1.5(0.373)	1.5 (0.373)	1.5 (0.373)
Minimum Plenum Size, ID	[in., (mm)]	7 (178)	9 (229)	9 (229)	10 (254)
Sound Pressure Level	[dB(A)]	56	56	56	58
	[NC]	50	47	47	50
Shipping Weight [lbs, (kg)]		62 (28)	65 (30)	72 (33)	74 (34)

* Based on full open restrictor and minimum plenum size at 230V.

Motor Temperature Limits

Motor Type	Recommended Temperature Limit	Maximum Temperature Limit
PSC	160 °F (71.1 °C)	160 °F (71.1 °C)
EC	130 °F (54.4 °C)	150 °F (65.6 °C)

Note: The EC motor is sensitive to air temperatures that exceed the recommended temperature limit. A reduction in motor life of as much as 50% could result when operating at the maximum temperature limit.

To determine the airflow when using the single speed motors (-ST models), measure the amperage and look up the airflow in the Blower Capacity Data tables below. This is not necessary for the variable speed motors because they are programmed to deliver the airflow that you need.

Measuring Airflow

Acoustic Data

Sound is always present in our lives and is important to comfort. Understanding how sound is defined is essential to understanding how to design a proper Unico System. Sound is defined as a physical disturbance in pressure that is detectable by the human ear. Sound is usually presented as Sound Pressure Level (SPL) in decibels (dB), but can also be presented as Sound Power Level (SWL). Sound pressure is what you hear so it is the only value that is important to the occupant. However, determining the value is difficult because it is dependent on the surroundings and distance from the sound source. For instance, a carpeted room is much quieter than a room with wood floors.

For the Unico System, it is also important to consider sound transmission losses through ceilings and walls. Since the blower is never placed in an occupied space, the SPL in that space is always less than the published value. This reduction in sound level depends on the construction of the ceiling or wall. For instance, a ceiling structure made of gypsum board with insulation above it will have a much greater sound transmission loss (TL) than a dropped ceiling without insulation.

The data shown in this catalog comes from measurements taken in a large room with hard surfaces for the walls and floor. It is considered to be the worst case (i.e. loudest) situation. The SPL in the occupied space will always be considerably less than this, depending on where the unit is located. To determine the actual SPL, subtract the TL for the barrier from the sound data of the unit. The table below shows typical TL values for common construction configurations. Subtract these values from the Unico air handler data.

Transmission Loss for Common Construction [dB]							
Frequency [Hz]	125	250	500	1k	2k	4k	R
Sheet Metal, 24 ga	13	17	20	27	34	39	18
Ceiling Tile, mineral fiber	13	21	27	31	35	40	20
Gypsum Frame wall	12	23	31	38	42	37	20
Gypsum Frame wall, insul.	15	30	32	43	46	38	23
Wood Floor, uninsulated	22	28	37	43	46	43	25
Wood Floor, insulated	29	40	51	57	60	58	26
Concrete Block, 190-mm	38	41	43	50	55	61	26
Concrete, 100-mm (4 in.)	41	41	45	52	56	64	26

Ref: *Handbook of Acoustical Measurements and Noise Control*, 1998
 R = Overall Loss for typical Blower Module

All -STD models include a patented restrictor plate to fine tune the airflow. This plate creates a small amount of turbulence and noise. However, this is only noticeable near the unit if the unit is installed close to the occupied space. The -EC models do not need a restrictor plate and, consequently, the sound pressure level in the occupied space can be as much as 3-5 dB quieter.

Note: Using muffler on the discharge of the unit will reduce the sound pressure by 3 dB. The muffler should be a metal duct with at least 1.5 inches (38 mm) of fiberglass

insulation, measuring at least 10in. D × 20in. L (250mm D × 500mm L).

Example. Consider an M2430BL1 located above a dropped ceiling. The SPL generated by the unit is 56dB, and the transmission loss due to the ceiling is 20dB, resulting in a overall SPL of 36dB. Similarly, if the same unit were installed in an attic with insulation(TL=26dB), the SPL would be only 30dB. This makes the Unico System one of the quietest systems on the market.

Sound Pressure Levels (L_p)

The sound pressure level for each unit was measured in a reverberant room measuring approximately 21ft × 35ft (6.4m × 10.7m) with hard tiled floors, hard walls, acoustical ceiling tiles, and no furniture. The sound level meter was located near the side of the unit as shown below.

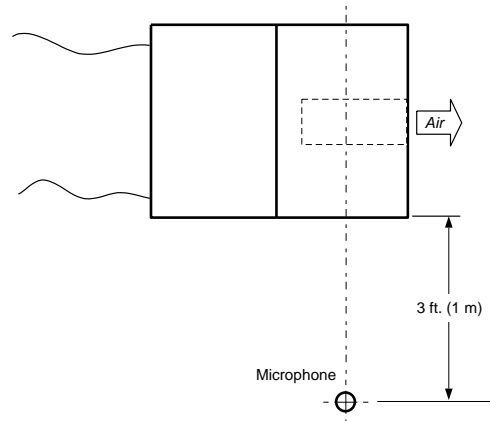

The data shown on the next page was measured at a motor speed of 1700 RPM at maximum airflow. It is considered the worst (loudest) case scenario. Using the EC motor with additional outlets will significantly reduce the radiated sound by reducing the required static pressure and consequently the motor speed.

Acoustic Data (Max airflow at 1.5 in. w.c. (0.37kPa))

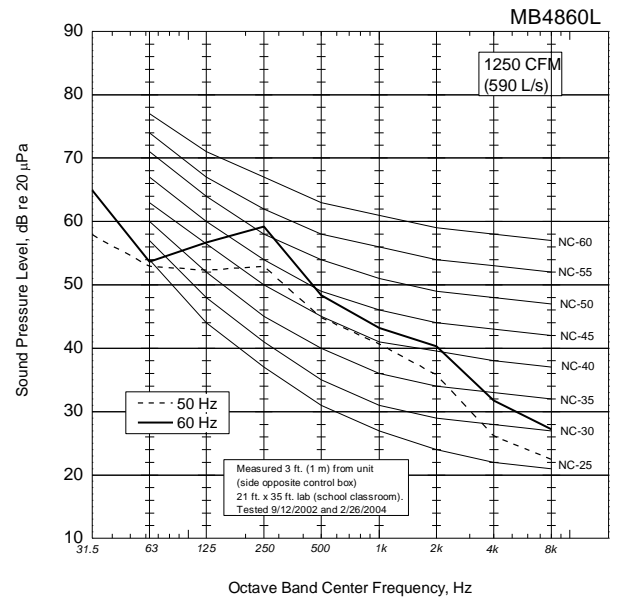
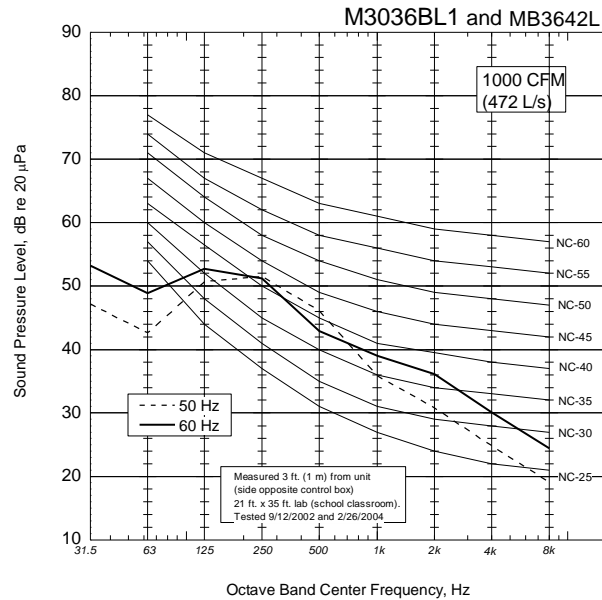
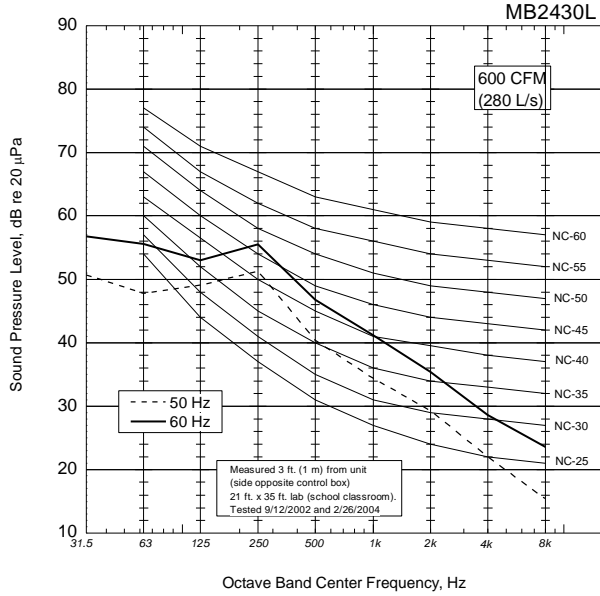

Blower Performance Data for –ST2 models(with cooling module installed) at 60Hz/230V.

Model	External Static Pressure [in. w.c. (kPa)]									
	1.0 (0.25)		1.25 (0.31)		1.5 (0.37)		1.75 (0.44)		2.0 (0.50)	
	CFM (L/s)	Amps	CFM (L/s)	Amps	CFM (L/s)	Amps	CFM (L/s)	Amps	CFM (L/s)	Amps
-STD Models										
M2430BL1	870 (410)	3.1	810 (383)	2.9	740 (351)	2.7	660 (310)	2.4	510 (240)	2.0
M3036BL1	1170 (552)	4.6	1150 (543)	4.4	1070 (505)	4.1	965 (455)	3.8	825 (389)	3.2
M3642BL1	1240 (585)	4.8	1170 (552)	4.5	1070 (505)	4.1	925 (437)	3.6	745 (352)	3.1
M4860BL1	1472 (695)	4.7	1400 (660)	4.5	1300 (610)	4.2	1162 (548)	3.9	953 (450)	3.4

Blower Capacity Data (-STD models)

M2430BL1-ST2

60Hz

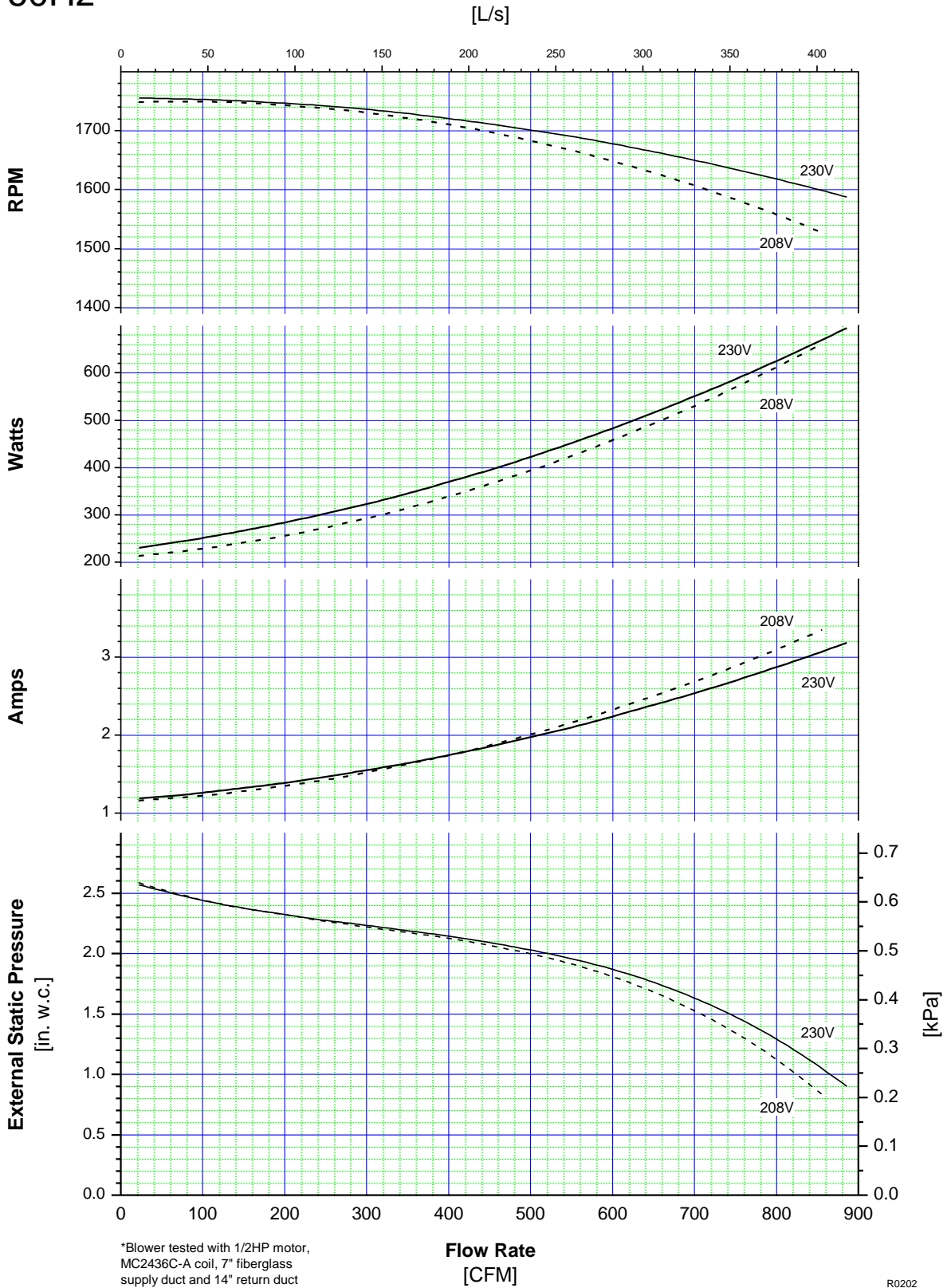

*Blower tested with 1/2HP motor, MC2436C-A coil, 7" fiberglass supply duct and 14" return duct with filter grille.

R0202
2012_09-10

M3036BL1-ST2

60Hz

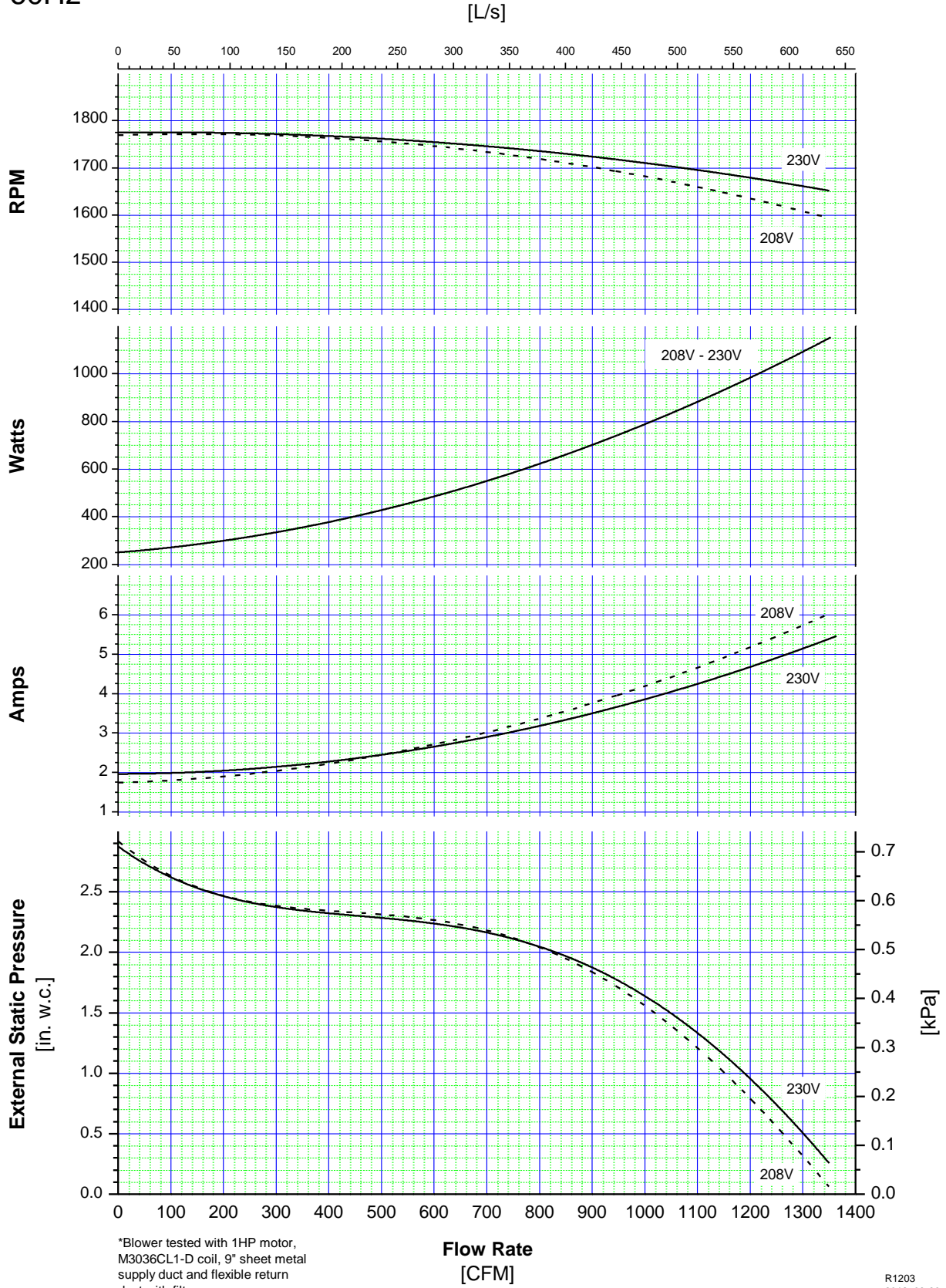

R1203
2012_03-30

M3642BL1-ST2

60Hz

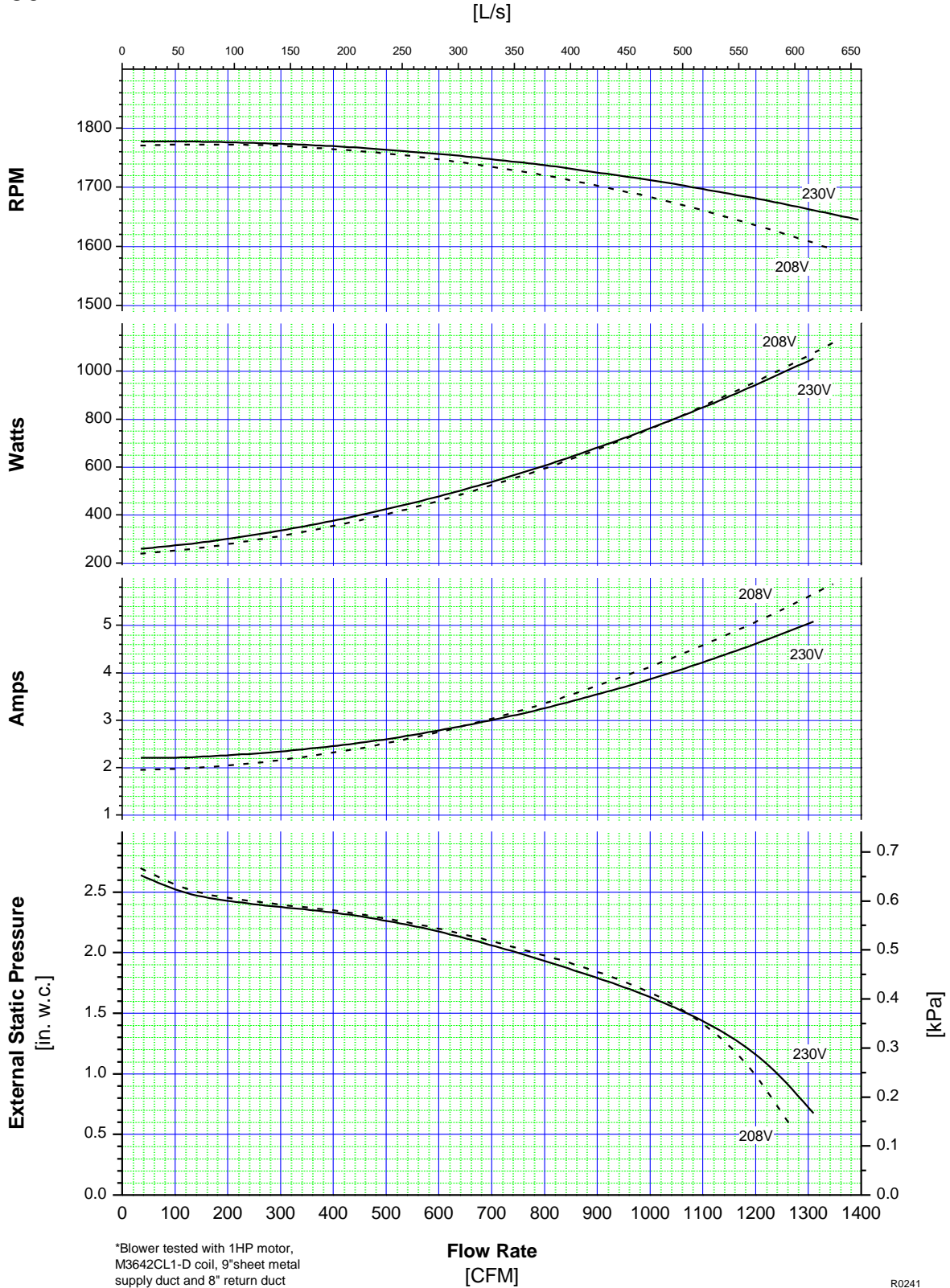

R0241
2012_09-10

M4860BL1-ST2

60Hz

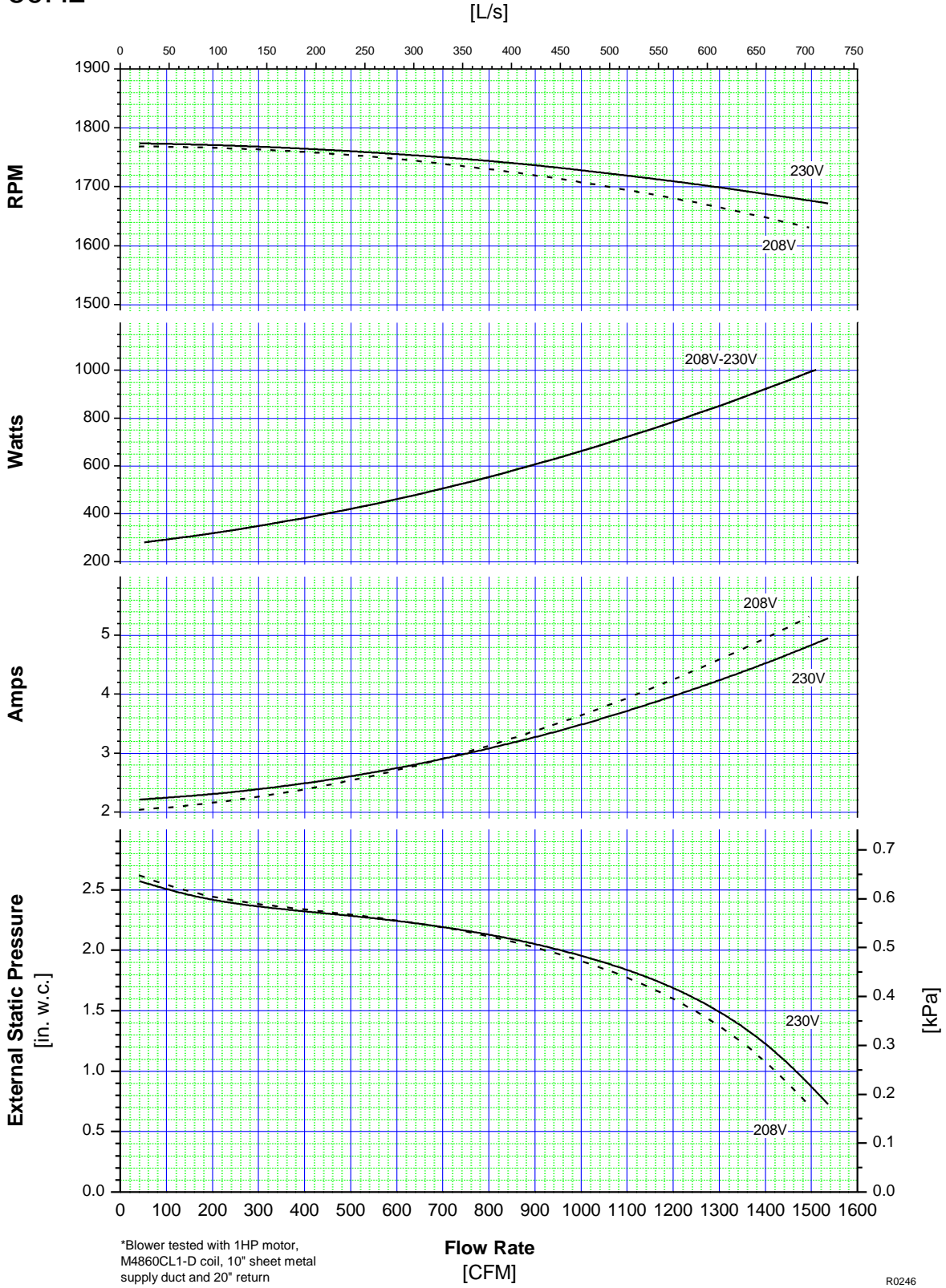

Blower Capacity Data (-EC models)

M2430BL1-EC

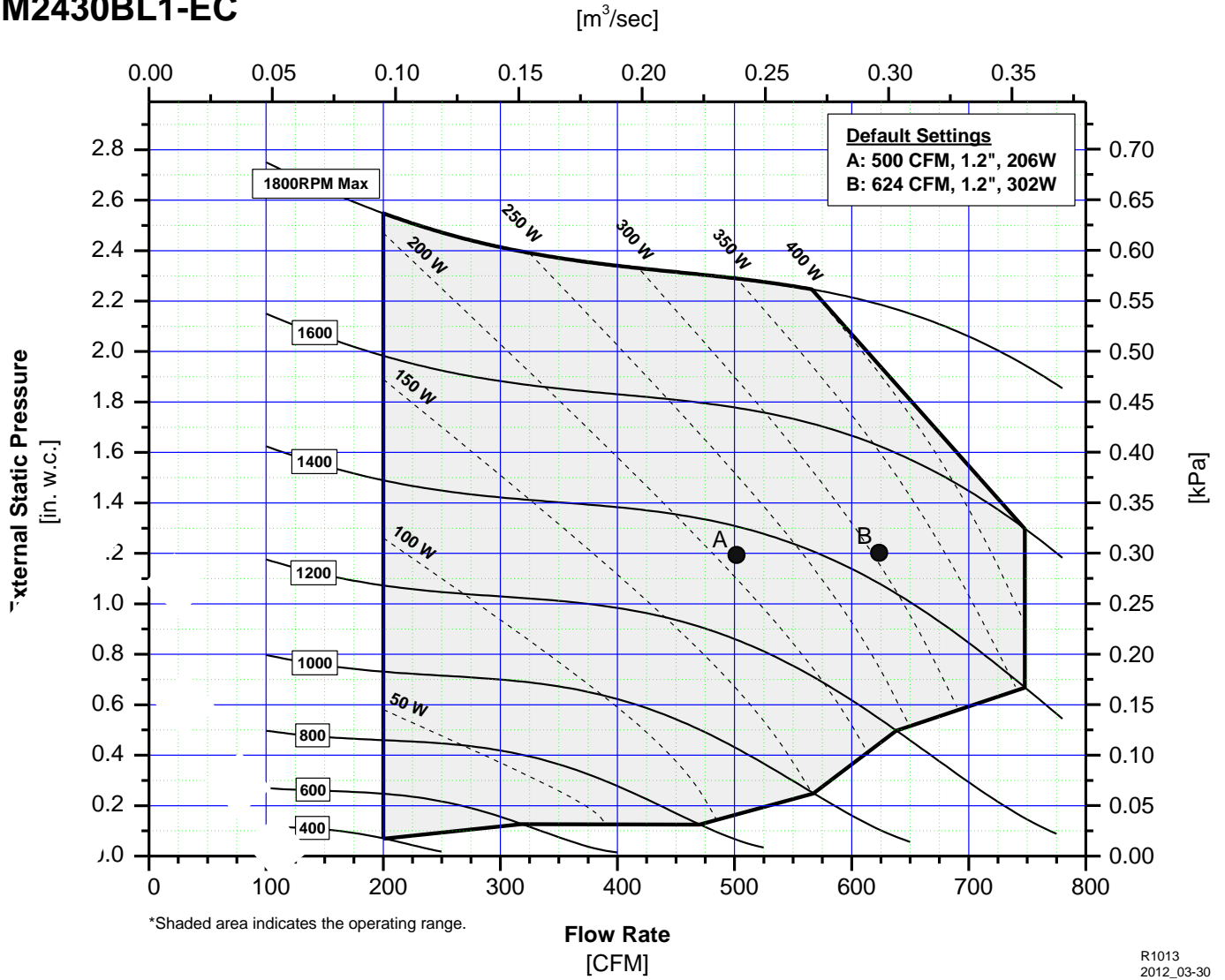

M3036BL1-EC

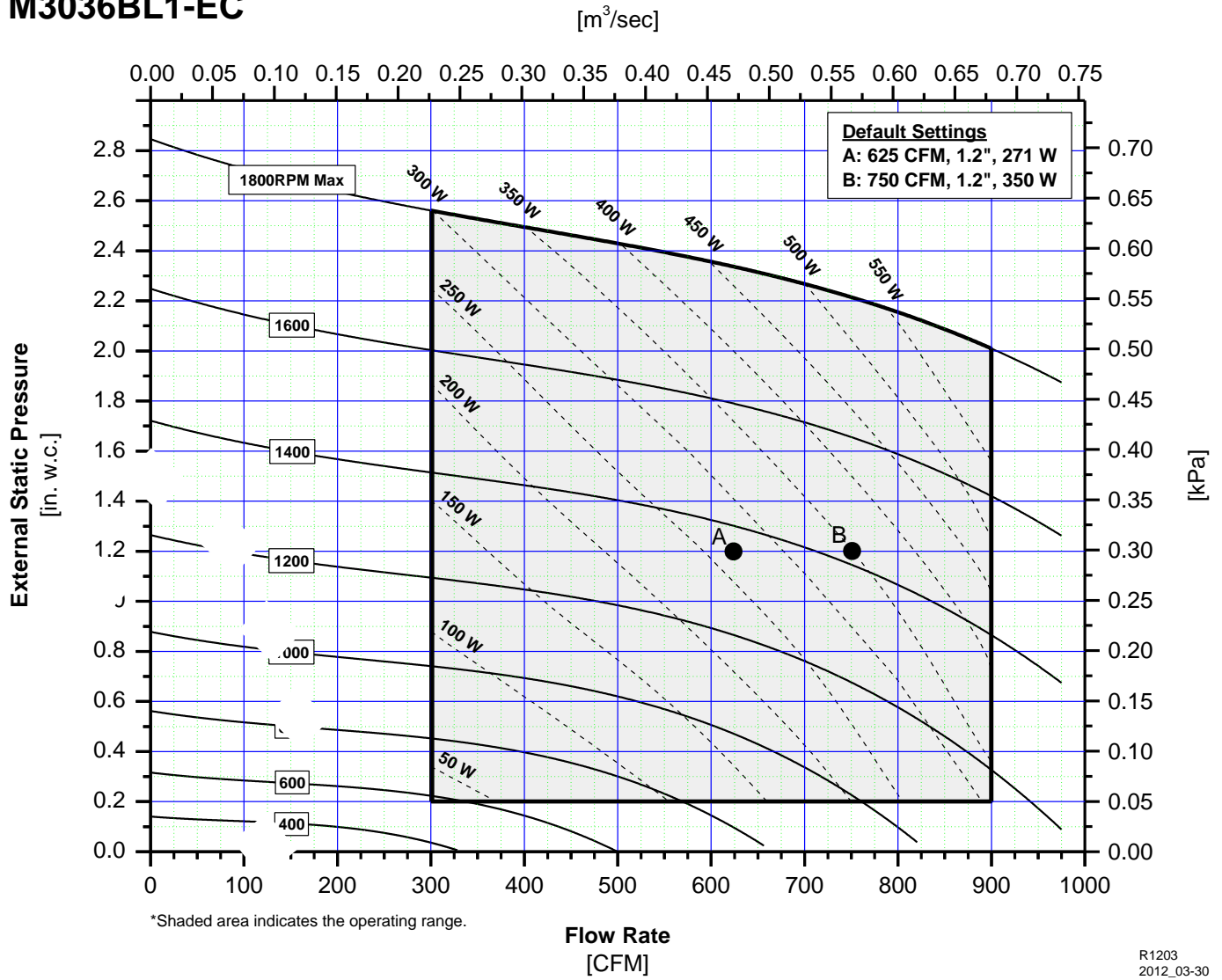

R1203
2012_03-30

M3642BL1-EC

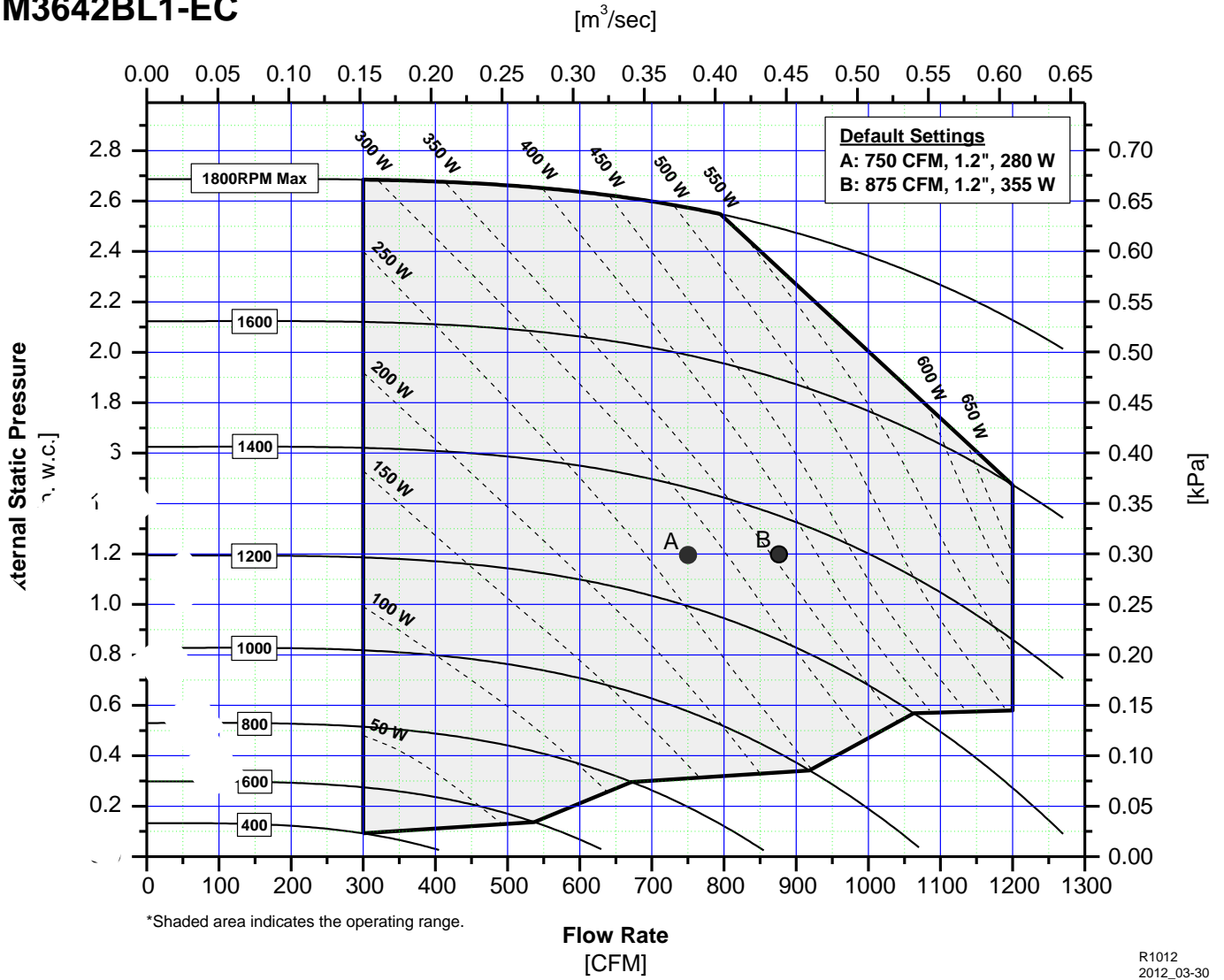

*Shaded area indicates the operating range.

R1012
2012_03-30

M4860BL1-EC

[m³/sec]

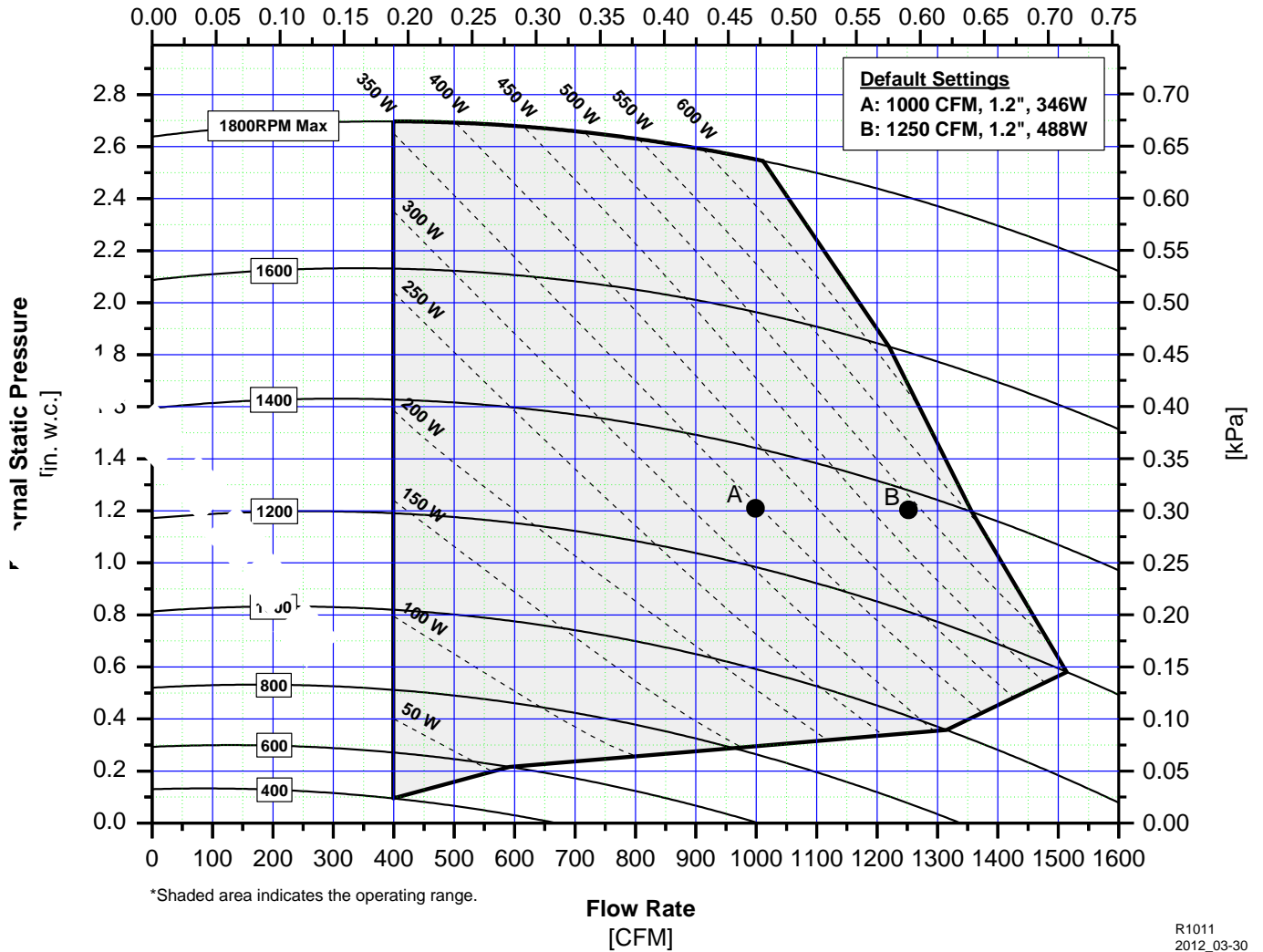

R1011
2012_03-30

Model Number Cross-reference Chart

Model Number		Motor and Controls Box Option
Current Model Number	Past Model Number	
MxxxxBL1-OLS	MBxxxxL	Single speed motor with time-delay sequencer. 1ph, 208/230, 50/60 Hz (CE marked)
MxxxxBL1-ST2	MBxxxxL	Single speed motor with variable low speed controller. 1ph, 208/230V, 60 Hz only
MxxxxBL1-EC1	None	Variable speed EC motor with S.M.A.R.T. control board. 1ph, 120V, 60 Hz only
MxxxxBL1-EC2	None	Variable speed EC motor with S.M.A.R.T. control board. 1ph, 208/230V, 50/60 Hz
MxxxxBL1-EC3	None	Variable speed EC motor with S.M.A.R.T. control board. 1ph, 220/240V, 50/60 Hz (CE marked)