



SEYMOUR
MIDWEST

FAMILY OWNED AMERICAN TOOL COMPANY SINCE 1872



SEYMOUR MIDWEST RAKE® LINK HANDLES®

KENYON Toolite® ProValue SMARTBUY

WARRANTY



Limited Lifetime Warranty

Since 1872, the Seymour name has been synonymous with quality, durability and honest value.

At Seymour Midwest, we build tools that offer outstanding performance, year-after-year. We stand behind our products by extending to the original purchaser a LIMITED LIFETIME WARRANTY that our products will be free from manufacturing defects in materials and workmanship during normal use, subject to the qualifications indicated below. Simply return the defective tool to where you purchased it, with proof of purchase, or visit SeymourMidwest.com to learn how to make a warranty claim.

The typical life of a tool is determined by the conditions and level of use. Frequent, daily use will wear out a tool faster than infrequent, occasional use. Defects in materials or workmanship typically arise early in the life of a tool. Our limited warranty does not cover normal wear, lost parts, damage inflicted intentionally by the user, or failures due to accident, misuse, abuse, negligence, alteration or modification. Seymour Midwest's sole liability and the purchaser's sole remedy for a failure of products under this warranty shall be limited to the replacement or repair of the product, or the issuance of a credit therefor, at the option of Seymour Midwest (no automatic deductions by the purchaser are allowed).

Lifetime Warranty Exceptions: The period of warranty for Striking tools, ProValue tools and SmartBuy tools is for one (1) year rather than for lifetime.

Seymour Midwest assumes no liability for special, incidental or consequential damages caused by a product's failure to conform to the above written warranty, except where required by law. Seymour Midwest's warranty as set forth above is the sole and exclusive warranty. There are no other warranties expressed or implied. No person is authorized to give any other warranties.

If you have any questions concerning the warranty or its application, please write to:
Customer Care, Seymour Midwest LLC, PO Box 1674, Warsaw, Indiana 46581 USA

Genuine Seymour Midwest Replacement Parts

Frequent professional use can wear out the parts on many tools. We offer replacement blades, wood handles, springs and other component parts for our products. Identify replacement parts easily by visiting the Replacement Parts and Replacement Handles sections of our website at SeymourMidwest.com.

We're always improving. Product configurations, specifications and photos shown in this catalog can change to better meet market needs. Consult our website at SeymourMidwest.com for the latest information and to see additional products not included in this print catalog.

TABLE OF CONTENTS



Warranty Information	2
Our Brands	6-15
The Structron Advantage	16
Shovels	
<i>Fiberglass / Standard</i>	17-19
<i>Fiberglass / Specialty</i>	20-23
<i>Fiberglass / Trenching & Cleanout</i>	24-25
<i>Wood / Standard</i>	26-28
<i>Wood / Specialty</i>	29-31
<i>Wood / Trenching & Cleanout</i>	32-33
<i>Polymer / Specialty</i>	34
<i>All-Steel / Specialty</i>	35
<i>Toolite / Specialty</i>	36-37
Rakes	
<i>Lawn & Leaf</i>	38-40
<i>Bow</i>	41-42
<i>Level Head</i>	43
<i>Landscape</i>	44-45
<i>Aluminum / Specialty</i>	46-47
<i>Aquatic</i>	48
Brooms	49-51
Hoes	52-53
Edgers	54
Cultivators	55
Forks	56-57
Scoops	58-60
Scrapers	61
Post Hole Diggers	62-63
Fencing Tools	64
Augers	65
Snaths & Scythe Blades	66
Weed & Brush Cutting	67
Machetes & Knives	68

Pruning Tools	
<i>Saws</i>	69
<i>Hand Pruners</i>	70
<i>Hedge Shears</i>	71
<i>Loppers</i>	72-73
<i>Tree Pruners / Fruit Picker</i>	74
Extension Handles	75
Planting Tools	76
Garden Tools	77
Squeegees	78-80
Lutes	81
Concrete Tools	82
Asphalt & Seal Coating Tools	83
Tampers & Rollers	84
Soil Probes & Trenchers	85
Wheelbarrows	86-87
Striking Tools	
<i>Hammers</i>	88
<i>Hammers / Mauls / Axes</i>	89
<i>Axes / Picks / Mattocks</i>	90
<i>Digging / Pry Bars</i>	91
Measuring Tools	92
Valve Keys & Wrenches	93
Irrigation Tools	94-95
Sports Field Tools	96-97
Snow Tools	98-99
LINK Replacement Handles	
<i>Introduction</i>	100-102
<i>Handle Display Merchandising</i>	103
<i>Handles</i>	104-118
<i>Eye Size Charts</i>	119-121
<i>How To Replace A Handle</i>	122
Fireplace	
<i>Outdoor Living</i>	123
<i>Firestarter</i>	124-125
Rings & Ring Fasteners	126-127
Merchandising	128-129
New Products for 2016	131

HERITAGE

In 1872, Seymour Manufacturing was founded as an agricultural tool and implement manufacturer in Seymour, Indiana. Early products were grain cradles, wagon wheels, scythes, and snaths.



Julius C. Birge of St. Louis, Missouri was among the initial group of investors in the company and eventually bought out his partners to begin over a century of ownership by members of the Birge family.

Early in the 20th century, Seymour purchased the Hall Manufacturing Company of Indiana to expand the product offering into post hole diggers and earth augers. The Dunn Edge Tool Company and the North Indianapolis Cradle Works were purchased after World War I to further expand the company's offerings.

As part of the national efforts in World War II, Seymour produced starter cartridges for airplanes, magazines for small arms and wooden wheelbarrows that required minimal metal for assembly. The company also expanded with new innovations for the farm and ranch markets including hog rings and ringers, cattle de-horners and other rugged farm tools.

The company expanded into consumer markets in the 1950's with the launch of fireplace tools and a snow sled for children. These winter-time product offerings eventually were expanded into a full range of snow tools.



Seymour embraced the development of stronger, lightweight tools using fiberglass handles in the early 1990's. The 1995 acquisition of Structron Corporation of San Marcos, California positioned Seymour as the market leader in tools made with handles of pultruded fiberglass

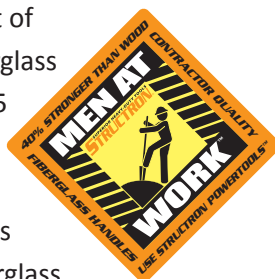

composite plastics. Structron has grown to be the company's most popular brand worldwide.

In 2004, Seymour acquired the O.P. Link Corporation, which included the O.P. Link Company of Salem, Indiana, the Sequatchie Handle Works of Sequatchie, Tennessee, the Bruner-Ivory Company of Hope, Arkansas, and the Turner-Day Handle Company of Crossville, Tennessee.



These combined companies are the leading All-American manufacturers of hickory replacement handles for tools of all shapes and sizes. Today the Link operation offers 8,000 different handle patterns and has helped customers worldwide renew tools with new handles.

In 2012, Seymour Manufacturing was purchased by the shareholders of Midwest Rake Company to form Seymour Midwest. Also



based in Indiana, Midwest Rake had previously acquired the Kenyon, Toolite, and Northstar brands and has a long history of manufacturing professional-grade tools. Today the family-owned company sells over 3,500 tools and 8,000 different repair handles to customers worldwide. The consolidated product offering includes a broad selection of styles, price-points, and features to appeal to both consumers and professionals.

SEYMOUR MIDWEST FACTS-AT-A-GLANCE

Company Headquarters: Warsaw, Indiana USA

Manufacturing Facilities: Seymour and Warsaw, Indiana; Altamont, Crossville and Sequatchie, Tennessee

Distribution Centers: Warsaw, Indiana • Seymour, Indiana • Sequatchie, Tennessee

Products Offered: Over 10,000 items



GET TO KNOW SEYMOUR MIDWEST

Seymour Midwest is a family-owned, global supplier to the hand-tools market, providing both innovative solutions and time-tested products from our manufacturing facilities in Indiana and Tennessee.

The quality, dependability, and performance of our products meet the high standards of those who use tools everyday: contractors, handymen, farmers, ranchers, landscapers and others. Our diverse selection of products and brands allows our customers to order all of their tool needs from a single source.

Beyond best-in-class products, Seymour Midwest is also known as a leader in outstanding customer service, product training, and technical support in all of our business segments.

As a family-owned company, we believe in the values of integrity, quality, commitment, and innovation. We work hard to achieve performance that sets a standard of excellence and to build relationships with our customers that endure, not just because it is good business, but because it is the right thing to do.

ABOUT OUR BRANDS



Structron is our premium line of tools for tough job site conditions.

SEYMOUR

Seymour tools continue our tradition of genuine value since 1872.

MIDWEST RAKE

Midwest Rake has a reputation for the finest rakes, brooms, and squeegees on the market today.

LINK HANDLES

Link Replacement Handles are individually hand-crafted in Tennessee by skilled artisans from American hickory.

Toolite

Toolite is a revolutionary and patented shovel that are highly valued for their releasing "hole" design, as well as their sifting capabilities.



Kenyon is the market leader in tools for professional landscaping and irrigation contractors.

ProValue

ProValue tools blend contractor-friendly features and attractive pricing to appeal to both professional and consumer users.

SMARTBUY

Outstanding value is the key feature of our SmartBuy tools.



A DEDICATED TEAM

The hardworking men and women who build our tools and serve our customers are driven by pride and commitment. It's our heritage to do what's right.



OUR BRANDS

SUPERIOR HEAVY-DUTY TOOLS **STRUCTRON**® RANGE OF TOOLS

The Structron name has long been synonymous with best-in-class industrial / contractor tools. We have added dozens of new tools to the Structron line including wood-handled shovels, striking tools, scrapers and post hole diggers.



RANGE OF TOOLS SUPERIOR HEAVY-DUTY TOOLS **STRUCTRON**[®]

New choices in fiberglass, aluminum, and wood handled tools such as brooms, rakes, squeegees, and specialty tools plus new wheelbarrows make Structron the industry's broadest premium brand.



OUR BRANDS

SEYMOUR® RANGE OF TOOLS

Seymour tools continue our tradition of genuine value since 1872. They are built to stand up to the rigors of everyday use by contractors, farmers, handymen, and others who appreciate a well-built tool.



RANGE OF TOOLS **SEYMOUR®**

Seymour shovels offer legendary pro-grade performance on the job site, farm and ranch. Experience tough features like highest quality contoured hardwood handles, front-turned steps for secure foot placement and rugged head-to-handle connections. It's no wonder why they're top-sellers worldwide.



OUR BRANDS

MIDWEST RAKE® RANGE OF TOOLS

Midwest Rake has a reputation for the finest rakes, brooms and squeegees on the market today. The Midwest Rake line also includes innovative tools for special needs.



RANGE OF TOOLS LINK HANDLES[®]

We offer the industry's widest selection of replacement handles that help you extend the life of your trusted tools. With over 6,000 handle patterns available, we can provide an exact match that fits the tool with an ergonomically-superior turned design.



OUR BRANDS

Toolite® RANGE OF TOOLS

These revolutionary and patented shovels are highly valued for their mud and muck releasing “hole” design, as well as their sifting capabilities. A superior tool when digging in mud, clay, and water saturated materials, but also ideal when sifting debris from sand, gravel, grain, sports turf maintenance, public works/utility and agricultural markets. Toolite shovels are lightweight, ergonomic, and will cause less fatigue than other shovels because of their unique design.



OUR BRANDS

RANGE OF TOOLS **KENYON**

Kenyon is the market leader in tools for professional landscaping and irrigation contractors. These hard-working tools beautify landscapes worldwide.



OUR BRANDS

ProValue *RANGE OF TOOLS*

ProValue tools blend contractor-friendly features and attractive pricing to appeal to both professional and consumer users. They simplify both weekend projects and daily maintenance.



RANGE OF TOOLS **SMARTBUY**

Outstanding value is the key feature of our SmartBuy shovels. For homeowner-duty tasks, we offer several choices that handily blend attractive price and in-field performance. Our SmartBuy line is also ideal for special promotions.



ANATOMY OF A WINNER

BEST-IN-CLASS CONTRACTOR TOOLS

Since 1979, the Structron brand has lead the industry in contractor and industrial tools. Nearly indestructible, Structron tools are always there when you need them the most.



PermaGrip™ steel collar

A rivetless ring of steel connects the shovel neck, handle, and fiberglass PowerCore™ rod, making it one solid unit. Provides the strongest head to handle connection.

Highest quality tool head

14-gauge spring steel blade flexes but won't bend or break as easily as other shovel blades. Extra-sharp heat-treated, high-carbon stamped steel head provides the ultimate in durability - *wears better, lasts longer.*

ProGrip™ comfort grip

Made of durable textured vinyl with a non-slip surface for a secure grip with excellent shock-absorbing protection. Unique double-wall construction for greater durability. Weather resistant.

Safety yellow reinforced fiberglass handle

Strong yet lightweight hollow fiberglass handle provides maximum durability and visual impact.

ASSEMBLED IN THE USA

with American hands in Indiana.

PowerCore™ solid fiberglass reinforcing rod

Extends 12.5 inches from the handle into the shank and blade for maximum strength at this critical stress point.

ROUND POINT SHOVEL	WEIGHT	HANDLE LENGTH	CONNECTION SYSTEM	HANDLE/HEAD INSERT	DYNAMIC TOOL TEST POUNDS TO FAILURE
49730 / S700	4.9#	48"	CRIMPED FERRULE NO RIVET	FIBERGLASS POWERCORE™	250 POUNDS
COMPETITOR 1	4.4#	46"	RIVET / FERRULE	4.5" PLASTIC PLUG	200 POUNDS
COMPETITOR 2	6.5#	47"	DUEL RIVET TAB SOCKET W/STEEL SPACER	SOLID WOOD HANDLE	216 POUNDS
COMPETITOR 3	4.2#	46"	RIVET / FERRULE	6" PLASTIC PLUG	110 POUNDS



SUPERIOR HEAVY-DUTY TOOLS
STRUCTRON®

FIBERGLASS - SHOVELS

The 700 Series shovels feature heat treated, high-carbon, polished spring steel for the ultimate in durability.

The 600 Series shovels feature tempered, heavy-duty, blades finished with a protective coating.

Exclusive PowerCore™ solid fiberglass reinforcing rods extend 12.5 inches from the handle into the shank and blade.



49730 Structron round point shovel S700

- 14 gauge spring steel #2 head, rear rolled step
- 48" fiberglass handle with cushion grip
- PowerCore™ solid fiberglass reinforcing rod



49560 Structron round point shovel S600

- 14 gauge tempered #2 head, forward turned step
- 48" fiberglass handle with cushion grip
- PowerCore™ solid fiberglass reinforcing rod



49744 Structron closed back shovel S712

- 14 gauge tempered #2 head, forward turned step
- 48" fiberglass handle with cushion grip
- PowerCore™ solid fiberglass reinforcing rod

WHY CLOSED BACK?

Closed back shovels have welded backplates to prevent material build-up. These plates also provide extra strength.



49731 Structron round point shovel S700D, d-grip

- 14 gauge spring steel #2 head, rear rolled step
- 29" fiberglass handle with poly d-grip
- PowerCore™ solid fiberglass reinforcing rod



49561 Structron round point shovel S600D, d-grip

- 14 gauge tempered #2, forward turned step
- 29" fiberglass handle with poly d-grip
- PowerCore™ solid fiberglass reinforcing rod



49732 Structron square point shovel S701

- 14 gauge spring steel #2 head, rear rolled step
- 48" fiberglass handle with cushion grip
- PowerCore™ solid fiberglass reinforcing rod



49562 Structron square point shovel S601

- 14 gauge tempered #2 head, forward turned step
- 48" fiberglass handle with cushion grip
- PowerCore™ solid fiberglass reinforcing rod



49742 Structron square point shovel S701D, d-grip

- 14 gauge spring steel #2 head, rear rolled step
- PowerCore™ solid fiberglass reinforcing rod
- 29" fiberglass handle with poly d-grip



49563 Structron square point shovel S601D, d-grip

- 14 gauge tempered #2, forward turned step
- PowerCore™ solid fiberglass reinforcing rod
- 29" fiberglass handle with poly d-grip

STRUCTRON QUALITY FEATURES



PowerCore™ solid fiberglass rod with PermaGrip™ rivetless steel collar

Extra large d-grip (SP51049) held with steel rivet (RM61002)



ProGrip™ comfort that's self-healing and all-weather resistant (SA32000)

SHOVELS - FIBERGLASS

Our Structron 800 series forged shovels feature a head made from a single piece of steel billet that is hammered and compressed to make the strongest tool available. They're ideal for heavy-duty contractor and industrial applications and will provide years of superior performance.



WHAT'S SO SPECIAL ABOUT FORGED SHOVELS?

Forged shovels are built to be stronger and more durable so they stand up to the toughest of job-site conditions. Every forged shovel is made from a single piece of steel billet that is hammered and compressed while hot to form the head, neck (shank) and socket.

As the metal is shaped during the forging process, its internal grain is modified to match the shape of the part. As a result, the grain is continuous throughout the part, creating a single-piece shovel head that is dramatically stronger than a cast or machined part.

KEY CHARACTERISTICS OF SEYMOUR MIDWEST FORGED SHOVELS:

- Thicker and heavier head than traditional stamped steel
- Solid shank in the neck joins the blade and the socket providing maximum strength
- Sharp blade edge penetrates ground more easily

FORGED SHOVELS



49770 Structron forged round point shovel S800

- Rugged forged-head, solid-shank design
- Solid fiberglass reinforcing rod
- 44.5" fiberglass handle with cushion grip



49772 Structron forged square point shovel S801

- Rugged forged-head, solid-shank design
- Solid fiberglass reinforcing rod
- 45.5" fiberglass handle with cushion grip, S801



WHY FORGED SHOVELS?

- Forged heads are thicker and heavier than stamped.
- They're made from a single piece of steel billet.
- Forging compresses and stamps the steel resulting in exceptional strength and durability.
- Forged blades lack the traditional "frog". Thus, they don't collect and hold material.

SOLID FIBERGLASS HANDLE



49599 Structron closed back shovel

- 14 gauge #2 round point with front-turned step
- Closed back
- 48" solid fiberglass handle



49585 Structron impact irrigation shovel

- 10 ga. stamped & hot formed head, 7.5" x 9.5"
- Most rugged & reliable caprock on the market
- PermaGrip steel collar
- 48" fiberglass handle with ProGrip cushioned grip



49589 Structron impact drain spade

- 10 ga. stamped & hot formed head
- Most rugged & reliable caprock on the market
- PermaGrip steel collar
- 48" fiberglass handle with ProGrip cushioned grip

FIBERGLASS - SHOVELS

Seymour contractor-grade tools are designed for frequent heavy-duty use by farmers, ranchers, landscapers, and other professionals.

ProValue homeowner-grade tools have features usually found only on more expensive tools. They provide good value in economical line of fiberglass handle tools.

SEYMOUR®



49450 Seymour round point shovel

- 16 gauge #2 head, forward turned step
- Fiberglass core insert
- 46" fiberglass handle with vinyl grip, SV-LR40



49452 Seymour square point shovel

- 16 gauge #2 head, forward turned step
- Fiberglass core insert
- 46" fiberglass handle with vinyl grip, SV-LS41



CONTRACTOR QUALITY CONSTRUCTION

Durable, heat-treated carbon steel heads. Forward turned steps provide secure foot placement and comfort. Square-shoulder 9" sockets. Fiberglass handles up to 50% stronger than wood.



49451 Seymour round point shovel, d-grip

- 16 gauge #2 head, forward turned step
- Fiberglass core insert
- 28" fiberglass handle with poly d-grip, SV-DR42



49462 Seymour square point shovel, d-grip

- 16 gauge #2 head, forward turned step
- Fiberglass core insert
- 28" fiberglass handle with poly d-grip, SV-DS43

ProValue



49430 ProValue round point shovel

- 16 gauge #2 head, forward turned step
- Solid, hardwood core insert
- 43" fiberglass handle with vinyl grip, SV-LR80



49432 ProValue square point shovel

- 16 gauge #2 head, forward turned step
- Solid, hardwood core insert
- 43" fiberglass handle with vinyl grip, SV-LS81



49431 ProValue round point shovel, d-grip

- 16 gauge #2 head, forward turned step
- Solid, hardwood core insert
- 26" fiberglass handle with poly d-grip, SV-DR82



49433 ProValue square point shovel, d-grip

- 16 gauge #2 head, forward turned step
- Solid, hardwood core insert
- 26" fiberglass handle with poly d-grip, SV-DS83



ProValue Fiberglass Tools Offer Exceptional Value for Homeowner Use

SHOVELS - FIBERGLASS / SPECIALTY

Our SuperShovel® tools continue to win contractor accolades for their superior ability to penetrate hard-packed, rocky and clay soils. They also easily chop through roots and tough sod. Our irrigation shovels have a special head that allows for digging of vertical-wall trenches and valve pits. The Caprock versions offer a forged head.

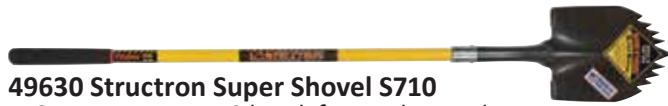

49630 Structron Super Shovel S710

- 14 gauge #2 head, forward turned step
- PowerCore™ solid fiberglass reinforcing rod
- 48" fiberglass handle with cushion grip



SUPER SHOVEL®: BEST FOR TOUGH SOIL

Our Super Shovel® tools have cutting teeth to penetrate hard-packed, rocky and clay soils and also chop through roots and sod. They're 100% made in Seymour, Indiana USA.



49631 Structron Super Shovel S710D, d-grip

- 14 gauge #2 head, forward turned step
- PowerCore™ solid fiberglass reinforcing rod
- 29" fiberglass handle with poly d-grip



49735 Structron irrigation shovel S706

- 14 gauge head, forward turned step
- PowerCore™ solid fiberglass reinforcing rod
- 48" fiberglass handle with cushion grip



49575 Structron forged irrigation shovel S714

- Rugged #00 forged-head, 7" x 9.5", solid-shank design
- PowerCore™ solid fiberglass reinforcing rod
- 48" fiberglass handle with cushion grip



49455 Seymour irrigation shovel

- 16 gauge #2 head, forward turned step, 20 degree head lift
- Fiberglass core insert
- 48" fiberglass handle with vinyl grip



49748 Structron rice shovel S713

- 14 gauge head, forward turned step
- PowerCore™ solid fiberglass reinforcing rod
- 48" fiberglass handle with cushion grip



49465 Seymour rice shovel SV-RS40

- 16 gauge head, forward turned step
- Fiberglass core insert
- 48" fiberglass handle with cushion grip

NEW FOR
2016

STRUCTRON® IMPACT CAPROCK SHOVEL

Seymour Midwest introduces the new "Impact" caprock shovel, the most rugged and reliable caprock shovel on the market today. The result of precision engineering and best-in-class materials, this new shovel design will deliver outstanding performance for the professional user.



THICKEST AND STRONGEST HEAD:
10 gauge stamped and hot formed steel with rounded edge



PERMAGRIP STEEL COLLAR:
For solid head-to-handle connection, warranted lock tight



FLAT BLADE CAPROCK STYLE:
18 degree lift



SOLID FIBERGLASS HANDLE:
With polymer outer jacket, finite reinforced



PROGRIP CUSHIONED GRIP:
Made of durable textured vinyl with non-slip surface, weather resistant



see page 131 for all of our new products for 2016

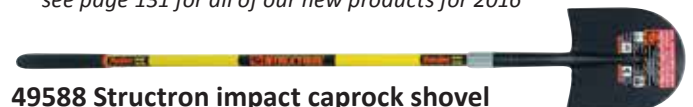

49588 Structron impact caprock shovel

- 10 ga. stamped & hot formed head
- Most rugged & reliable caprock on the market
- PermaGrip steel collar
- Solid fiberglass 48" handle with ProGrip cushioned grip



49781 Structron forged irrigation shovel S707

- Rugged #2 forged-head, solid-shank design
- PowerCore™ solid fiberglass reinforcing rod
- 44.5" fiberglass handle with cushion grip

FIBERGLASS / SPECIALTY - SHOVELS

Roofing contractors love our top-selling SG1 shingle removal shovel because it makes shingle removal fast and easy and it stands up to continuous use. We offer a wide selection of garden and nursery spades for planting, preparing beds, bed edging and other landscape tasks. Our unique post spade has an elongated forged head perfect for post holes.



- 49749 Structron shingle remover SG1**
- 9" steel head, fulcrum for leverage
 - 36" fiberglass handle with poly d-grip
 - Replacement blade: SP16003

ULTIMATE SHINGLE REMOVER

This professional quality tool makes shingle and nail removal easier. It has an extra strong steel brace and carbon steel skid plate.



POST SPADE



- 49782 Structron forged post spade S819D, poly d-grip**
- Rugged forged-head, solid-shank design
 - PowerCore™ solid fiberglass reinforcing rod
 - 29" Fiberglass Handle with poly d-Grip

SEYMOUR®



- 49454 Seymour garden/nursery spade SV-GD44**
- 16 gauge #2 head, rear turned step
 - Heavy-duty fiberglass core insert
 - 27" fiberglass handle with poly d-grip



- 49453 Seymour garden/nursery spade**
- 16 gauge #2 head, rear turned step
 - Fiberglass core insert
 - 48" fiberglass handle with vinyl grip

GARDEN/NURSERY SPADES



- 49733 Structron garden/nursery spade S705**
- 14 gauge spring steel #2 head, rear rolled step
 - PowerCore™ solid fiberglass reinforcing rod
 - 48" fiberglass handle with cushion grip



- 49553 Structron garden/nursery spade S605**
- 14 gauge #2 head, forward turned step
 - PowerCore™ solid fiberglass reinforcing rod
 - 48" fiberglass handle with cushion grip



- 49734 Structron garden/nursery spade S705D, poly d-grip**
- 14 gauge spring steel #2 head, rear rolled step
 - PowerCore™ solid fiberglass reinforcing rod
 - 29" fiberglass handle with poly d-grip



- 49554 Structron garden/nursery spade S605D, poly d-grip**
- 14 gauge #2 head, forward turned step
 - PowerCore™ solid fiberglass reinforcing rod
 - 29" fiberglass handle with poly d-grip



- 49774 Structron forged garden/nursery spade S805D, poly d-grip**
- Rugged forged-head, solid-shank design
 - PowerCore™ solid fiberglass reinforcing rod
 - 29" fiberglass handle with poly d-grip



- 49653 Kenyon garden/nursery spade, polymer handle**
- 14 gauge #2 head, forward turned step
 - 48" solid fiberglass cored construction polymer handle



- 49654 Kenyon garden/nursery spade, polymer handle**
- 14 gauge #2 head, forward turned step
 - 28" solid fiberglass cored construction polymer handle with d-grip

SHOVELS - FIBERGLASS / SPECIALTY

Whether you're digging a trench, working in a tight space or transplanting shrubs, Seymour Midwest's large selection of drain spades provides you with options on blade length, handle and grip. The slightly cupped blade is effective in penetrating the ground and moving soil with minimum effort.

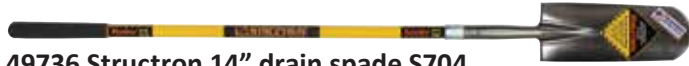

49736 Structron 14" drain spade S704

- 14 gauge spring steel #2 head, rear rolled step
- PowerCore™ solid fiberglass reinforcing rod
- 48" fiberglass handle with cushion grip



49558 Structron 16" drain spade S604

- 14 gauge #2 head, forward turned step
- PowerCore™ solid fiberglass reinforcing rod
- 48" fiberglass handle with cushion grip



49778 Structron 16" forged drain spade S715

- Rugged forged-head, solid-shank design
- PowerCore™ solid fiberglass reinforcing rod
- 48" fiberglass handle with cushion grip



49576 Structron 14" forged drain spade

- Rugged forged-head, solid-shank design
- PowerCore™ solid fiberglass reinforcing rod
- 48" fiberglass handle with cushion grip



49556 Structron 14" drain spade

- 14 gauge #2 head, forward turned step
- 48" solid fiberglass handle w/polymer outer jacket, finite reinforced



49566 Structron 14" drain spade, closed back

- 14 gauge #2 head, forward turned step, closed back
- PowerCore™ solid fiberglass reinforcing rod
- 48" fiberglass handle with comfort grip



49737 Structron 14" drain spade S704D

- 14 gauge spring steel #2 head, rear rolled step
- PowerCore™ solid fiberglass reinforcing rod
- 29" fiberglass handle with poly d-grip



49559 Structron 16" drain spade S604D

- 14 gauge #2 head, forward turned step
- PowerCore™ solid fiberglass reinforcing rod
- 29" fiberglass handle with poly d-grip



49779 Structron 16" forged drain spade S715D

- Rugged forged-head, solid-shank design
- PowerCore™ solid fiberglass reinforcing rod
- 29" fiberglass handle with poly d-grip



49577 Structron 14" forged drain spade

- Rugged forged-head, solid-shank design
- PowerCore™ solid fiberglass reinforcing rod
- 30" fiberglass handle with poly d-grip



49557 Structron 14" drain spade

- 14 gauge head, forward turned step
- Solid fiberglass reinforcing rod
- 30" fiberglass handle with poly d-grip



49567 Structron 14" drain spade, closed back

- 14 gauge #2 head, forward turned step, closed back
- PowerCore™ solid fiberglass reinforcing rod
- 30" fiberglass handle with poly d-grip

SEYMOUR®



49456 Seymour 14" drain spade SV-LD40

- 14 gauge head, forward turned step
- Heavy-duty fiberglass core insert
- 47" fiberglass handle with cushion grip



49457 Seymour 14" drain spade SV-DD40, d-grip

- 14 gauge head, forward turned step
- Heavy-duty fiberglass core insert
- 26" fiberglass handle with poly d-grip



Seymour 16" drain spade with d-grip

- 14 gauge head, forward turned step
- Heavy-duty fiberglass core insert
- Blue fiberglass handle with poly d-grip

49459 - 26" fiberglass handle, SV-DD46

49459LO - 30" fiberglass handle



49597 Kenyon 14" drain spade

- 14 gauge "V" shaped head, closed back
- Heavy-duty fiberglass core insert
- 48" fiberglass handle with vinyl grip



49437 ProValue 14" drain spade SV-DD80, d-grip

- 16 gauge head, forward turned step
- Solid hardwood core insert
- 26" fiberglass handle with poly d-grip



SEYMOUR® MINI PRO

49352 Seymour MiniPRO Shovel SV-DRMPFG



Rugged strength in a compact design.

MANY DIFFERENT APPLICATIONS:

- Camping & Firepits
- Truck Shovel
- Confined Spaces
- Track Cleaning

Fiberglass handle with a poly d-grip

Compact, but hard-working round point head

Compact dimensions - 27.5" x 6" x 2.25"

Wood versions of the MiniPRO can be found on page 30.

SHOVELS - FIBERGLASS / TRENCHING & CLEAN OUT

Every contractor has their favorite! We offer the industry's most widest range of proven trenching shovels for cleaning mechanically-dug trenches or for hand digging in a variety of soil conditions. Color-coding of blades/labels makes for easy selection in-store. Tempered steel heads feature a boot-saver step.

28° TRENCH DIGGING, 14 GAUGE PUTS HANDLE CLOSER TO WORKER

89273 Structron 3" trenching shovel S708

- 14 gauge, 28 degree "V" shaped head, forward turned step
- Solid fiberglass reinforcing rod
- 54" extended fiberglass handle with cushion grip
- Boot Saver™ step

89233 Kenyon 3" trenching shovel

- 14 gauge, 28 degree "V" shaped head with Boot Saver™ step
- Wood reinforcing core
- 48" fiberglass handle with cushion grip
- Boot Saver™ step

89274 Structron 4" trenching shovel S709

- 14 gauge, 28 degree "V" shaped head, forward turned step
- Solid fiberglass reinforcing rod
- 54" extended fiberglass handle with cushion grip
- Boot Saver™ step



28° TRENCH DIGGING, 14 GAUGE PUTS HANDLE CLOSER TO WORKER

89234 Kenyon 4" trenching shovel

- 14 gauge, 28 degree "V" shaped head with Boot Saver™ step
- Wood reinforcing core
- 48" fiberglass handle with cushion grip

89275 Structron 5" trenching shovel S717

- 14 gauge, 28 degree "V" shaped head,
- Forward turned Boot Saver™ step
- Solid fiberglass reinforcing rod
- 54" extended fiberglass handle with cushion grip

89235 Kenyon 5" trenching shovel

- 14 gauge, 28 degree "V" shaped head with Boot Saver™ step
- Wood reinforcing core
- 48" fiberglass handle with cushion grip

89236 Kenyon 6" trenching shovel

- 14 gauge, 28 degree "V" shaped head with Boot Saver™ step
- Wood reinforcing core
- 48" fiberglass handle with cushion grip

TRENCHING COLOR CODES AND HEAD WIDTHS

DIGGING STYLE	HANDLE STYLE	3 inch head COLOR CODE BLUE	4 inch head COLOR CODE ORANGE	5 inch head COLOR CODE RED	6 inch head COLOR CODE GREEN
28° angle Puts handle closer to worker for greater productivity 14 gauge Heavy duty blade	48" hardwood	89223	89224	89225	89226
	48" fiberglass	89233	89234	89235	89236
	48" solid polymer	89243	89244	89245	89246
	54" extended fiberglass	89273	89274	89275	
35° angle Ideal for BOTH digging and cleaning trenches 11 gauge Extra heavy duty ribbed blade	47" hardwood	89023	89024	89025	89026
	48" fiberglass	89123	89124	89125	89126
	53" extended fiberglass	89133	89134	89135	89136

CLEAN OUT TRENCHING SHOVELS AND HEADS SMALLER THAN 3" ARE NOT LISTED IN THIS GRID BUT ARE AVAILABLE IN THE TRENCHING SHOVEL SECTION OF THE CATALOG

FIBERGLASS / TRENCHING & CLEAN OUT - SHOVELS

35° GENERAL PURPOSE, 11 GAUGE IDEAL FOR BOTH DIGGING AND CLEANING TRENCHES



89123 Kenyon 3" trenching shovel

- 11 gauge, 35 degree "V" shaped head
- Forward turned Boot Saver™ step
- Solid fiberglass reinforcing core
- 48" fiberglass handle with vinyl grip



89124 Kenyon 4" trenching shovel

- 11 gauge, 35 degree "V" shaped head
- Forward turned Boot Saver™ step
- Solid fiberglass reinforcing core
- 48" fiberglass handle with vinyl grip



89125 Kenyon 5" trenching shovel

- 11 gauge, 35 degree "V" shaped head
- Forward turned Boot Saver™ step
- Solid fiberglass reinforcing core
- 48" fiberglass handle with vinyl grip



89126 Kenyon 6" trenching shovel

- 11 gauge, 35 degree "V" shaped head
- Forward turned Boot Saver™ step
- Solid fiberglass reinforcing core
- 48" fiberglass handle with vinyl grip

35° EXTENDED HANDLE, 11 GAUGE IDEAL FOR BOTH DIGGING AND CLEANING TRENCHES



89133 Kenyon 3" digging/trenching shovel

- 11 gauge, 35 degree "V" shaped head
- Forward turned Boot Saver™ step
- Solid fiberglass reinforcing core
- 53" extended fiberglass handle with vinyl grip



89134 Kenyon 4" digging/trenching shovel

- 11 gauge, 35 degree "V" shaped head
- Forward turned Boot Saver™ step
- Solid fiberglass reinforcing core
- 53" extended fiberglass handle with vinyl grip



89135 Kenyon 5" digging/trenching shovel

- 11 gauge, 35 degree "V" shaped head
- Forward turned Boot Saver™ step
- Solid fiberglass reinforcing core
- 53" extended fiberglass handle with vinyl grip



89136 Kenyon 6" digging/trenching shovel

- 11 gauge, 35 degree "V" shaped head, forward turned step
- Solid fiberglass reinforcing core
- 53" extended fiberglass handle with vinyl grip

CLEAN OUT / TRENCHING SHOVELS 14 GAUGE STEEL HEADS



89184 Structron 4" clean out/trenching shovel S703

- 14 gauge spring steel head, forward turned step
- Solid fiberglass reinforcing rod
- 48" fiberglass handle with cushion grip



89084 Kenyon 4" clean out shovel SV-TR44

- 14 gauge tempered steel head
- Heavy-duty fiberglass core insert
- 45" fiberglass handle with vinyl grip



89185 Structron 5" clean out/trenching shovel S702

- 14 gauge spring steel head
- Forward turned Boot Saver™ step
- Solid fiberglass reinforcing rod
- 48" fiberglass handle with cushion grip



89085 Kenyon 5" clean out shovel SV-TR45

- 14 gauge tempered steel head
- Heavy-duty fiberglass core insert
- 45" fiberglass handle with vinyl grip



89095 Kenyon 5" compact clean out shovel

- 14 gauge tempered steel head
- Fiberglass handle with poly d-grip
- 31" overall length

SHOVELS - WOOD

We're proud to introduce wood handled shovels as good as their name. As the Structron brand indicates, these are the finest wood handled shovels available. Structron wood features highest-grade hardwood handles with super-tough coating that resists sunlight and wet conditions. They won't let you down.



49330 Structron round point shovel

- 14 gauge #2 head, forward turned step
- Extended tab 11" socket, dual riveted
- 48" tapered hardwood handle, SV-LR30



49344 Structron round point shovel

- 14 gauge #2 head, forward turned step, closed back
- Extended tab 11" socket, dual riveted
- 48" tapered hardwood handle, SV-LR30CB



49340 Structron round point shovel

- 14 gauge #2 head, rear rolled step
- Extended tab 11" socket, dual riveted
- 48" tapered hardwood handle, SV-LR34



49170 Structron forged round point shovel

- Rugged forged-head, solid-shank design
- 48" tapered hardwood handle, SV-LR50



49331 Structron round point shovel

- 14 gauge #2 head, forward turned step
- Extended tab 11" socket, dual riveted
- 30" hardwood handle, steel d-grip, SV-DR32



49171 Structron forged round point shovel

- Rugged forged-head, solid-shank design
- 27" hardwood handle, steel d-grip, SV-DR52

STRUCTRON WOOD QUALITY FEATURES

Durable, heat-treated



high carbon steel heads

Extra large steel d-grip



Held with steel rivets

Extended tab 11" socket



Double-riveted for strength



49332 Structron square point shovel

- 14 gauge #2 head, forward turned step
- Extended tab 11" socket, dual riveted
- 48" tapered hardwood handle, SV-LS31



49345 Structron square point shovel

- 14 gauge #2 head, forward turned step, closed back
- Extended tab 11" socket, dual riveted
- 48" tapered hardwood handle, SV-LS31CB



49342 Structron square point shovel

- 14 gauge #2 head, rear rolled step
- Extended tab 11" socket, dual riveted
- 48" tapered hardwood handle, SV-LS35



49172 Structron forged square point shovel

- Rugged forged-head, solid-shank design
- 48" tapered hardwood handle, SV-LS51



49333 Structron square point shovel

- 14 gauge #2 head, forward turned step
- Extended tab 11" socket, dual riveted
- 30" hardwood handle, steel d-grip, SV-DS33



49173 Structron forged square point shovel

- Rugged forged-head, solid-shank design
- 27" hardwood handle, steel d-grip, SV-DS53

WOOD-SHOVELS

Seymour shovels offer legendary pro-grade performance on the job site, farm and ranch. Experience tough features like highest quality contoured hardwood handles, front-turned steps for secure foot placement and rugged head-to-handle connections. It's no wonder why they're top-sellers worldwide.



49150 Seymour round point shovel

- 16 gauge #2 head, forward turned step, riveted
- 48" hardwood handle, SV-LR20



49151 Seymour round point shovel

- 16 gauge #2 head, forward turned step, riveted
- 30" hardwood handle, steel d-grip, SV-DR22



49152 Seymour square point shovel

- 16 gauge #2 head, forward turned step, riveted
- 48" hardwood handle, SV-LS21



49162 Seymour square point shovel

- 16 gauge #2 head, forward turned step, riveted
- 30" hardwood handle, steel d-grip, SV-DS23

SEYMOUR®

16 gauge heat-treated carbon steel head with forward turned step



PRO-GRADE PERFORMANCE

Frequent heavy-duty use by:

- Farmers
- Ranchers
- Contractors
- Other professionals with demanding industrial & commercial applications

Steel collar and rivet for strong head to handle connection

Highest quality hardwood handle

Contoured handle with super tough coating



SHOVELS - WOOD

Outstanding value is the key feature of our ProValue and SmartBuy shovels. For contractors looking to outfit a crew economically or for homeowner-duty tasks, we offer several choices that handily blend attractive price and in-field performance. Our SmartBuy line is ideal for special promotions.

ProValue



49130 ProValue round point shovel

- 16 gauge heat-treated #2 head, forward turned step
- Square shoulder 9-inch sockets
- 43" hardwood handle, SV-LR10



49131 ProValue round point shovel

- 16 gauge heat-treated #2 head, forward turned step
- Square shoulder 9-inch sockets
- 26" hardwood handle, steel d-grip, SV-DR12



49132 ProValue square point shovel

- 16 gauge heat-treated #2 head, forward turned step
- Square shoulder 9-inch sockets
- 43" hardwood handle, SV-LS11



49142 ProValue square point shovel

- 16 gauge heat-treated #2 head, forward turned step
- Square shoulder 9-inch sockets
- 26" hardwood handle, steel d-grip, SV-DS13

SMARTBUY



49830 SmartBuy round point shovel

- 16 gauge #2 head with step
- Square shoulder 9-inch socket
- 42" hardwood handle, SV-LR90



49831 SmartBuy round point shovel

- 16 gauge #2 head with step
- Square shoulder 9-inch socket
- 26" hardwood handle, poly d-grip, SV-DR92



49832 SmartBuy square point shovel

- 16 gauge #2 head with step
- Square shoulder 9-inch socket
- 42" hardwood handle, SV-LS91



49833 SmartBuy square point shovel

- 16 gauge #2 head with step
- Square shoulder 9-inch socket
- 26" hardwood handle, poly d-grip, SV-DS93





49180 Structron forged irrigation shovel

- Rugged forged-head, solid-shank design
- 46.5" tapered hardwood handle, SV-IR50



49175 Structron forged irrigation shovel

- Rugged forged-head, solid-shank design
- 48" tapered hardwood handle



49155 Seymour irrigation shovel

- 16 gauge head, forward turned step
- 48" tapered hardwood handle



49181 Structron forged caprock shovel

- Rugged forged-head, solid-shank design
- 46.5" tapered hardwood handle, SV-CR50

Caprock irrigation shovels feature forged heads and low lift for near vertical digging. The solid shank provides exceptional strength.



49185 Structron forged rice shovel

- Rugged forged-head, solid-shank design
- 46.5" tapered hardwood handle, SV-RS50

Rice shovels are used for rice farming and irrigation. The perforations allow draining and ease of suction break.



49085 Seymour rice shovel

- 16 gauge head, forward turned step
- 48" tapered hardwood handle, SV-RS20



45420 Seymour transplant / floral shovel

- 16 gauge #0 head, forward turned step
- 44" tapered hardwood handle, SV-LR25



45411 Seymour transplant / floral shovel

- 16 gauge #00 head, forward turned step
- 44" tapered hardwood handle



49163 Seymour Super Shovel

- 14 gauge #2 head, forward turned step
- 48" tapered hardwood handle, SV-LT34



Our Super Shovel® tools have cutting teeth to penetrate hard-packed, rocky and clay soils and also chop through roots and sod.



49164 Seymour Super Shovel, d-grip

- 14 gauge #2 head, forward turned step
- 29" hardwood handle, steel d-grip, SV-DT35



SHOVELS - WOOD / SPECIALTY

We're proud to introduce wood handled shovels as good as their name. As the Structron brand indicates, these are the finest wood handled shovels available. Seymour shovels offer legendary pro-grade performance on the job site, farm and ranch; outstanding value is the key feature of our ProValue shovels.



49174 Structron forged garden spade, d-grip

- Rugged forged-head, solid-shank design
- 30" hardwood handle, steel d-grip, SV-GD50



49334 Structron garden spade, d-grip

- 16 gauge #2 head, rear rolled step
- 30" hardwood handle, steel d-grip, SV-GD34



49335 Structron garden spade, closed back, d-grip

- 16 gauge #2 head, closed back, rear rolled step
- 30" hardwood handle, steel d-grip, SV-GD34CB



49153 Seymour garden spade

- 16 gauge #2 head, rear rolled step
- 48" tapered hardwood handle, SV-GL24



49154 Seymour garden spade, d-grip

- 16 gauge #2 head, rear rolled step
- 30" hardwood handle, steel d-grip, SV-GD24



49134 ProValue garden spade, d-grip

- 16 gauge #2 head, rear rolled step
- 26" hardwood handle, steel d-grip, SV-GD10



49178 Structron forged post spade, d-grip

- 12" rugged forged-head, solid-shank design
- 30" hardwood handle, steel d-grip, SV-PD50



49168 Seymour notched roofing spade

- Fulcrum head
- 48" tapered hardwood handle, SG-2LH

Roofing spades have a heavy-duty fulcrum welded to the back of the blade for leverage.



49169 Seymour notched roofing spade

- Fulcrum head
- 29" hardwood handle, steel d-grip, SG-2DH



49191 Seymour ceremonial shovel, round point

- Chrome #2 head
- 29" hardwood handle with chrome d-grip, SV-DRCH



49351 Seymour MiniPRO shovel, round point

- Compact round point head, compact 27" overall length
- Hardwood handle with poly d-grip, SV-DRMP



49353 Seymour MiniPRO shovel, square point

- Compact square point head, compact 27" overall length
- Hardwood handle with poly d-grip, SV-DSMP



- 49336 Structron 14" drain spade, closed back**
- 14 gauge head, "V" shaped head, closed back
 - 48" tapered hardwood handle
 - The original "Sharp Shooter"



- 49337 Structron 14" drain spade**
- 14 gauge head, "V" shaped head, closed back
 - 27" hardwood handle with steel d-grip
 - The original "Sharp Shooter"



- 49357 Structron 14" drain spade**
- 14 gauge head, closed back
 - 30" hardwood handle with steel d-grip



- 49346 Structron 16" drain spade**
- 14 gauge head, forward turned step
 - 48" tapered hardwood handle, SV-LD30



- 49347 Structron 16" drain spade, d-grip**
- 14 gauge head, forward turned step
 - 30" hardwood handle with steel d-grip, SV-DD30



- 49348 Structron 16" drain spade, d-grip**
- 14 gauge head, forward turned step, closed back
 - 30" hardwood handle with steel d-grip, SV-DD30CB



- 49179 Structron 16" forged drain spade**
- Forged head, solid-shank design, forward turned step
 - 30" hardwood handle with steel d-grip, SV-DD50



- 49156 Seymour 14" drain spade**
- 14 gauge head, forward turned step
 - 48" tapered hardwood handle, SV-LD20



- 49157 Seymour 14" drain spade, d-grip**
- 14 gauge head, forward turned step
 - 30" hardwood handle with steel d-grip, SV-DD20



- 49138 Seymour 16" drain spade, d-grip**
- 14 gauge head, forward turned step
 - 30" hardwood handle with steel d-grip



- 49137 ProValue 14" drain spade, d-grip**
- 16 gauge head, forward turned step
 - 26" hardwood handle with steel d-grip, SV-DD10



SHOVELS - WOOD / TRENCHING & CLEAN OUT

Every contractor has their favorite! We offer the industry's most widest range of proven trenching shovels for cleaning mechanically-dug trenches or for hand digging in a variety of soil conditions. Color-coding of blades/labels makes for easy selection in-store. Tempered steel heads feature a Boot-Saver™ step.

28° TRENCH DIGGING, 14 GAUGE PUTS HANDLE CLOSER TO WORKER



89223 Kenyon 3" trenching shovel

- 14 gauge, 28 degree "V" shaped head with Boot Saver™ step
- 48" hardwood handle



89224 Kenyon 4" trenching shovel

- 14 gauge, 28 degree "V" shaped head with Boot Saver™ step
- 48" hardwood handle



89225 Kenyon 5" trenching shovel

- 14 gauge, 28 degree "V" shaped head with Boot Saver™ step
- 48" hardwood handle



89226 Kenyon 6" trenching shovel

- 14 gauge, 28 degree "V" shaped head with Boot Saver™ step
- 48" hardwood handle



35° GENERAL PURPOSE, 11 GAUGE IDEAL FOR BOTH DIGGING AND CLEANING TRENCHES



89023 Kenyon 3" digging/trenching shovel

- 11 gauge, 35 degree "V" shaped head
- Forward turned Boot Saver™ step
- 47" hardwood handle



89024 Kenyon 4" digging/trenching shovel

- 11 gauge, 35 degree "V" shaped head
- Forward turned Boot Saver™ step
- 47" hardwood handle



89025 Kenyon 5" digging/trenching shovel

- 11 gauge, 35 degree "V" shaped head
- Forward turned Boot Saver™ step
- 47" hardwood handle



89026 Kenyon 6" digging/trenching shovel

- 11 gauge, 35 degree "V" shaped head
- Forward turned Boot Saver™ step
- 47" hardwood handle

CLEAN OUT / TRENCHING SHOVELS 14 GAUGE STEEL HEADS



89044 Kenyon 4" clean out shovel SV-TR14

- 14 gauge, 35 degree tempered steel head
- 44" hardwood handle



89045 Kenyon 5" clean out shovel SV-TR15

- 14 gauge, 35 degree tempered steel head
- 44" hardwood handle



28° angle



35° angle

We offer two different head angles / thicknesses for our trenching shovels. Our 28 degree, 14 gauge heads put the handle closer to the worker for greater productivity while the 35 degree, 11 gauge heads are ideal for both digging and cleaning out trenches.

POLYMER / TRENCHING & CLEAN OUT - SHOVELS

28° TRENCH DIGGING, 14 GAUGE PUTS HANDLE CLOSER TO WORKER



89243 Kenyon 3" trenching shovel

- 14 gauge, 28 degree "V" shaped head with Boot Saver™ step
- Solid fiberglass reinforcing core
- 48" polymer handle



89244 Kenyon 4" trenching shovel

- 14 gauge, 28 degree "V" shaped head with Boot Saver™ step
- Solid fiberglass reinforcing core
- 48" polymer handle



89245 Kenyon 5" trenching shovel

- 14 gauge, 28 degree "V" shaped head with Boot Saver™ step
- Solid fiberglass reinforcing core
- 48" polymer handle



89246 Kenyon 6" trenching shovel

- 14 gauge, 28 degree "V" shaped head with Boot Saver™ step
- Solid fiberglass reinforcing core
- 48" polymer handle

CLEAN OUT / TRENCHING SHOVELS 14 GAUGE STEEL HEADS



89194 Kenyon 4" clean out shovel

- 14 gauge tempered steel head
- Solid fiberglass reinforcing core
- 48" polymer handle



89195 Kenyon 5" clean out shovel

- 14 gauge tempered steel head
- Solid fiberglass reinforcing core
- 48" polymer handle

WHY PROFESSIONALS PREFER OUR POLYMER HANDLE TRENCHING SHOVELS

For the ultimate in durability, longevity and performance, there is no better solution than our solid fiberglass cored polymer jacketed handles. The solid core provides unmatched strength and high rigidity. The outer polyethylene jacket protects the tool from sun and weather damage. It also protects the user from handle splintering. These innovative tools last longer, keeping you productive, job after job.

See other Kenyon Polymer tools on page 34.

TRENCHING COLOR CODES AND HEAD WIDTHS

DIGGING STYLE	HANDLE STYLE	3 inch head COLOR CODE BLUE	4 inch head COLOR CODE ORANGE	5 inch head COLOR CODE RED	6 inch head COLOR CODE GREEN
28° angle Puts handle closer to worker for greater productivity 14 gauge Heavy duty blade	48" hardwood	89223	89224	89225	89226
	48" fiberglass	89233	89234	89235	89236
	48" solid polymer	89243	89244	89245	89246
	54" extended fiberglass	89273	89274	89275	
35° angle Ideal for BOTH digging and cleaning trenches 11 gauge Extra heavy duty ribbed blade	47" hardwood	89023	89024	89025	89026
	48" fiberglass	89123	89124	89125	89126
	53" extended fiberglass	89133	89134	89135	89136

CLEAN OUT TRENCHING SHOVELS AND HEADS SMALLER THAN 3" ARE NOT LISTED IN THIS GRID BUT ARE AVAILABLE IN THE TRENCHING SHOVEL SECTION OF THE CATALOG

SHOVELS - SPECIALTY / POLYMER

We call it the “new fiberglass,” for we believe that solid fiberglass cored polymer jacketed handles are attracting a growing following. You will find uses for the handle long after the head wears out. Maximum durability, maximum life; it’s just that simple.



49666 Kenyon 14" drain spade

- 14 gauge "V" shaped head, closed back
- Solid fiberglass reinforcing core
- 48" polymer handle
- The original "Sharp Shooter"



49667 Kenyon 14" drain spade, d-grip

- 14 gauge "V" shaped head, closed back
- Solid fiberglass reinforcing core
- 28" polymer handle with d-grip
- The original "Sharp Shooter"



49656 Kenyon 14" drain spade

- 14 gauge head, forward turned step
- Solid fiberglass reinforcing core
- 48" polymer handle



49657 Kenyon 14" drain spade

- 14 gauge head, forward turned step
- Solid fiberglass reinforcing core
- 28" polymer handle with d-grip



49691 Kenyon forged caprock shovel

- Rugged forged-head, solid-shank design
- Solid fiberglass reinforcing core
- 48" polymer handle



49692 Kenyon forged caprock shovel, d-grip

- Rugged forged-head, solid-shank design
- Solid fiberglass reinforcing core
- 28" polymer handle with d-grip



49650 Kenyon round point shovel

- 14 gauge #2 head, double riveted, forward turned step
- Solid fiberglass reinforcing core
- 48" polymer handle



49652 Kenyon square point shovel

- 14 gauge #2 head, double riveted, forward turned step
- Solid fiberglass reinforcing core
- 48" polymer handle



Solid fiberglass polymer handles are encased in polyethylene plastic to prevent any splinters.



49662 Kenyon square point shovel, d-grip

- 14 gauge #2 head, forward turned step
- Solid fiberglass reinforcing core
- 27" polymer handle with d-grip



49640 Kenyon round point shovel

- 16 gauge #2 head, forward turned step
- Solid fiberglass reinforcing core
- 48" polymer handle



49641 Kenyon round point shovel, d-grip

- 16 gauge #2 head, forward turned step
- Solid fiberglass reinforcing core
- 28" polymer handle with d-grip

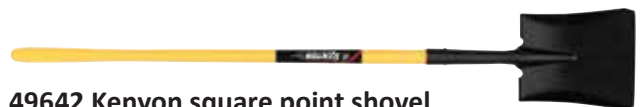

49642 Kenyon square point shovel

- 16 gauge #2 head, forward turned step
- Solid fiberglass reinforcing core
- 48" polymer handle



49643 Kenyon square point shovel, d-grip

- 16 gauge #2 head, forward turned step
- Solid fiberglass reinforcing core
- 28" polymer handle with d-grip

SPECIALTY / ALL-STEEL - SHOVELS

Landscape and construction contractors who do heavy digging love our Kenyon all-steel products. They provide the best in rock-moving, root chopping and prying capabilities. Constructed of ultra-thick, heavy-weight 12 gauge welded steel with a smooth powder coat, these tools are ready for extreme applications.

KENYON

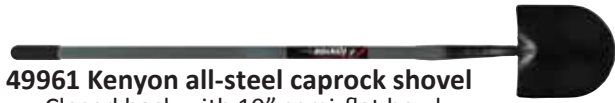

49961 Kenyon all-steel caprock shovel

- Closed back with 10" semi-flat bowl
- 3" handle lift
- 48" steel handle, 58" overall length



49957 Kenyon 12" all-steel spade

- 14 gauge "V" shaped head, closed back
- 27" steel d-grip handle, 39" overall length

Generous 1.25" steel step for secure foot placement with all shoe types



49958 Kenyon 15" all-steel spade

- 14 gauge "V" shaped head, closed back
- 27" steel d-grip handle, 42" overall length



49044 Kenyon all-steel landscape lighting trencher

- 8.25" wide and 10" long blade with 1.25" step
- 48" handle

Generous 1.25" steel step for secure foot placement with all shoe types. For installing landscape lighting, irrigation line, landscape edging and more.



49045 Kenyon all-steel landscape lighting trencher

- 8.25" wide and 10" long blade with 1.25" step
- 45" t-handle, 45" overall length



ALL-STEEL PRODUCTS: NOT POLISHED... JUST POWERFUL!

Nursery spades are ideal for edging, transplanting and general purpose digging where cutting through stubborn soil or roots is required. Turned steps add operator comfort. Flat blade reduces soil buildup.

Landscape Lighting Trencher cuts a slit for easy installation of landscape edging, lighting wire, irrigation cable, CATV, dog fencing wire and other landscape products. Use it with model 85468 cable placer to push the wire into the full depth of the opening. Choose T-handle or straight-handle options

Caprock shovel has a medium lift for a more vertical cut. The semi-flat bowl allows for a clean cut.

SHOVELS - SPECIALTY / TOOLITE® MUD SHOVELS

These revolutionary and patented shovels are highly valued for their mud and muck releasing “hole” design, as well as their sifting capabilities. A superior tool when digging in mud, clay, and water saturated materials, but also ideal when sifting debris from sand, gravel, grain, sports turf maintenance, public works/utility and agricultural markets.

Toolite®

- *Mud and muck releasing blades*
- *14 gauge tempered steel heads with 3/8" holes*
- *Thick walled fiberglass, polymer or wood handles*
- *5" double dipped grip or 1 piece molded D-grip on fiberglass handles*
- *All reinforcing cores are polymer jacketed fiberglass*
- *Polymer handles have solid fiberglass core with polymer jacket*
- *Crimped collar and riveted head-to-handle connection on fiberglass handles*
- *Lightweight, ergonomic, and will cause less fatigue*
- *U.S. Patent 5,601,325
Canada Patent 2,238,027
Mexico Patent 207,533*

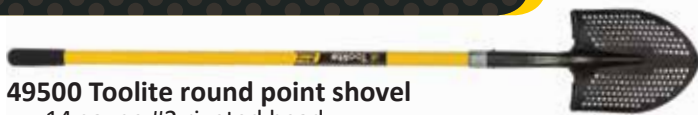

49500 Toolite round point shovel

- 14 gauge #2 riveted head
- 48" fiberglass handle



49501 Toolite round point shovel, d-grip

- 14 gauge #2 riveted head
- 29" fiberglass handle with poly d-grip



49502 Toolite square point shovel

- 14 gauge #2 riveted head
- 48" fiberglass handle



49503 Toolite square point shovel, d-grip

- 14 gauge #2 riveted head
- 29" fiberglass handle with poly d-grip



49507 Toolite 14" drain spade

- 14 gauge #2 riveted head
- 29" fiberglass handle with poly d-grip



49538 Toolite compact round point shovel

- 14 gauge #2 riveted head
- 28" overall length with poly d-grip



49539 Toolite compact square point shovel

- 14 gauge #2 riveted head
- 28" overall length with poly d-grip



49540 Toolite round point shovel, polymer handle

- 14 gauge #2 riveted head
- Solid fiberglass reinforcing core
- 48" polymer handle



49541 Toolite round point shovel, polymer handle

- 14 gauge #2 riveted head
- Solid fiberglass reinforcing core
- 29" polymer handle with d-grip



49542 Toolite square point shovel, polymer handle

- 14 gauge #2 riveted head
- Solid fiberglass reinforcing core
- 48" polymer handle



49543 Toolite square point shovel, polymer handle

- 14 gauge #2 riveted head
- Solid fiberglass reinforcing core
- 29" polymer handle with d-grip

SPECIALTY / TOOLITE® SCOOPS - SHOVELS

Toolite® scoops are perfect tools for sifting and removing debris when top-dressing athletic fields, courses, and diamonds. They sift debris from sand on beaches and in golf course bunkers and all types of soil. Great for screening and sifting rocks and unwanted material during pre-seeding and pre-sodding of lawns and landscapes.



49546 Toolite 14" drain spade, polymer handle

- 14 gauge #2 riveted head
- Solid fiberglass reinforcing core
- 48" polymer handle



49547 Toolite 14" drain spade, polymer handle

- 14 gauge #2 riveted head
- Solid fiberglass reinforcing core
- 29" polymer handle with d-grip



49490 Toolite round point shovel

- 14 gauge #2 riveted head
- 48" hardwood handle



49491 Toolite round point shovel

- 14 gauge #2 riveted head
- 29" hardwood handle with poly d-grip



49492 Toolite square point shovel

- 14 gauge #2 riveted head
- 48" hardwood handle



49493 Toolite square point shovel

- 14 gauge #2 riveted head
- 29" hardwood handle with poly d-grip



49497 Toolite 14" drain spade

- 14 gauge #2 riveted head
- 29" hardwood handle with poly d-grip

Toolite®

- *Mud and muck releasing blades*
- *14 gauge tempered steel heads with 3/8" holes*
- *Thick walled fiberglass, polymer or wood handles*
- *5" double dipped grip or 1 piece molded D-grip on fiberglass handles*
- *All reinforcing cores are polymer jacketed fiberglass*
- *Polymer handles have solid fiberglass core with polymer jacket*
- *Crimped collar and riveted head-to-handle connection on fiberglass handles*
- *Lightweight, ergonomic, and will cause less fatigue*
- *U.S. Patent 5,601,325
Canada Patent 2,238,027
Mexico Patent 207,533*



49510 Toolite scoop, d-grip



- One-piece, injection molded
- 14" x 17" head
- 27" handle with d-grip



49512 Toolite traditional scoop

- 13" x 12" traditional, aluminum head
- 48" hardwood handle



49513 Toolite shovel/scoop

- 10" x 12" aluminum head
- 48" hardwood handle

RAKES - LAWN & LEAF / SPRING BRACE

Our spring brace leaf rakes are built better to last longer. Intelligently-designed features include continuous tines from handle to tip and a durable spring brace that gives you the power to dig into thickly-matted leaves. Most of our rakes have single or double through-bolted heads that won't get loose or wobbly.



40928 Structron 24" spring brace rake SR22

- 24 tine 24" steel head, double-bolted
- 54" extra-reach fiberglass handle with comfort cushion grip
- Highest overall strength



40948 Midwest Rake 24/24 spring brace rake LF-40

- Heavy-duty, 24 tine 24" steel head, single-bolted
- 54" extra-reach fiberglass handle, 6" vinyl grip



40945 Midwest Rake 24" spring brace rake

- 24 tine steel head, single-bolted
- 54" extra-reach wood handle LF-25



Midwest Rake 24/24 spring brace rake

- Heavy-duty, 24 tine steel head, double-bolted
- 54" extra-reach hardwood handle

40912 - Bulk 12 pack
40901 - BA
40902 - IB



Midwest Rake 18/18 spring-brace rake

- Heavy-duty, 18 tine steel head, double-bolted
- 54" extra-reach wood handle

40932 - Bulk 12 pack
40930 - IB



Midwest Rake ProGrade 24/24 spring-brace rake

- Heavy-duty, 24 tine steel head, double-bolted
- 54" extra-reach powder-coated aluminum handle

40924 - Bulk 12 pack
40904 - BA
40905 - IB



Midwest Rake ProGrade 18/18 spring-brace rake

- Heavy-duty, 18 tine steel head, double-bolted
- 54" extra-reach powder-coated aluminum handle

40936 - Bulk 12 pack
40931 - IB

40955 - Replacement spring
for spring-brace rakes

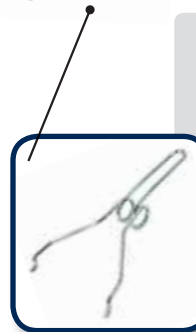

MIDWEST RAKE SPRING BRACE RAKES:

- Oversized heavy-duty replaceable spring
- ProGrade rakes offer large, 1" powder-coated aluminum handles while our heavy-duty rakes have 15/16" hardwood handles
- Double through-bolted head-to-handle connection
- 24" head with 24 heavy-duty steel continuous tines or 18" head with 18 heavy-duty steel continuous tines



40940 ProValue 18/18 spring brace rake

- Heavy-duty, 18 tine 18" steel head, no bolt
- 48" hardwood handle LF-18



40942 ProValue 22/22 spring brace rake

- Heavy-duty, 22 tine 22" steel head, no bolt
- 48" tapered hardwood handle LF-22

LAWN & LEAF - RAKES

Preferred by landscapers and gardeners when working in tighter spaces, our Pro-Flex rakes have more closely-spaced tines for moving lighter and finer debris. These rakes are ideal for everyday cleanup tasks. The tempered spring steel tines apply lighter pressure to avoid damage to plant roots.

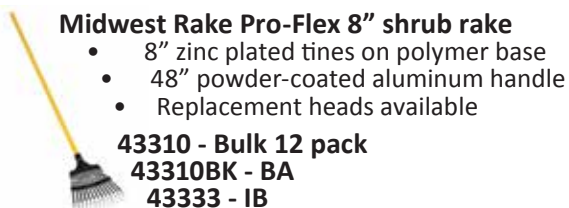

Midwest Rake Pro-Flex 8" shrub rake

- 8" zinc plated tines on polymer base
- 48" powder-coated aluminum handle
- Replacement heads available

43310 - Bulk 12 pack
43310BK - BA
43333 - IB

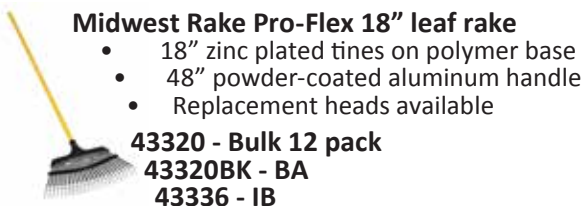

Midwest Rake Pro-Flex 18" leaf rake

- 18" zinc plated tines on polymer base
- 48" powder-coated aluminum handle
- Replacement heads available

43320 - Bulk 12 pack
43320BK - BA
43336 - IB

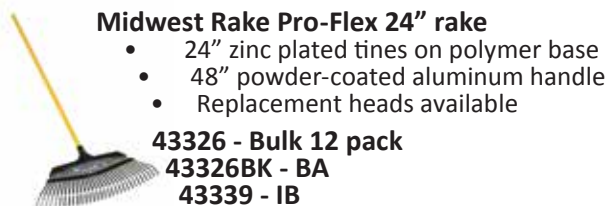

Midwest Rake Pro-Flex 24" rake

- 24" zinc plated tines on polymer base
- 48" powder-coated aluminum handle
- Replacement heads available

43326 - Bulk 12 pack
43326BK - BA
43339 - IB

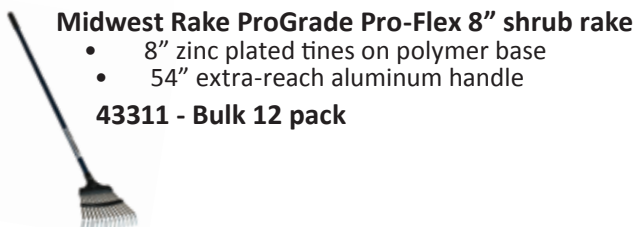

Midwest Rake ProGrade Pro-Flex 8" shrub rake

- 8" zinc plated tines on polymer base
- 54" extra-reach aluminum handle

43311 - Bulk 12 pack

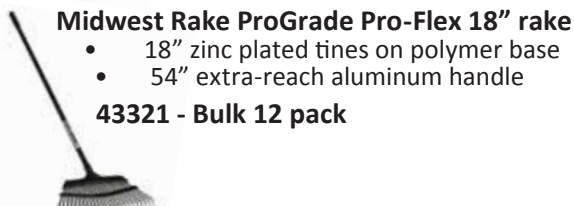

Midwest Rake ProGrade Pro-Flex 18" rake

- 18" zinc plated tines on polymer base
- 54" extra-reach aluminum handle

43321 - Bulk 12 pack

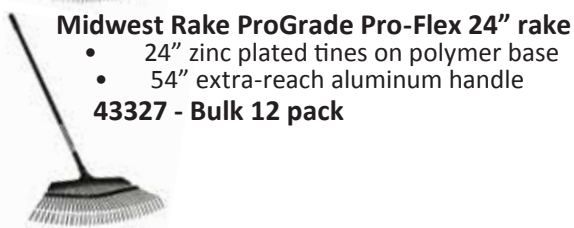

Midwest Rake ProGrade Pro-Flex 24" rake

- 24" zinc plated tines on polymer base
- 54" extra-reach aluminum handle

43327 - Bulk 12 pack

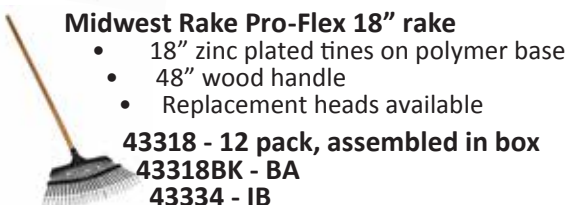

Midwest Rake Pro-Flex 18" rake

- 18" zinc plated tines on polymer base
- 48" wood handle
- Replacement heads available

43318 - 12 pack, assembled in box
43318BK - BA
43334 - IB

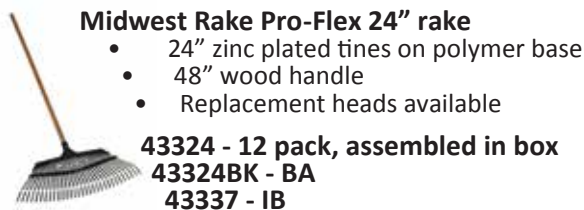

Midwest Rake Pro-Flex 24" rake

- 24" zinc plated tines on polymer base
- 48" wood handle
- Replacement heads available

43324 - 12 pack, assembled in box
43324BK - BA
43337 - IB

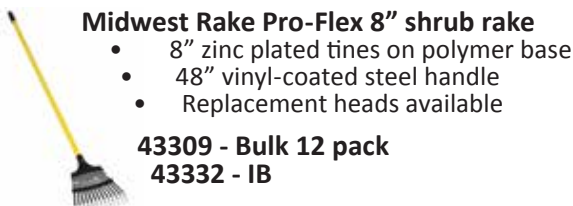

Midwest Rake Pro-Flex 8" shrub rake

- 8" zinc plated tines on polymer base
- 48" vinyl-coated steel handle
- Replacement heads available

43309 - Bulk 12 pack
43332 - IB

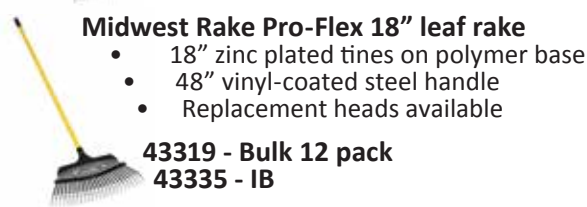

Midwest Rake Pro-Flex 18" leaf rake

- 18" zinc plated tines on polymer base
- 48" vinyl-coated steel handle
- Replacement heads available

43319 - Bulk 12 pack
43335 - IB

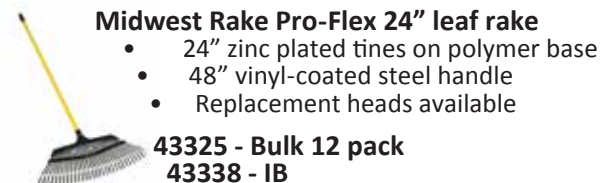

Midwest Rake Pro-Flex 24" leaf rake

- 24" zinc plated tines on polymer base
- 48" vinyl-coated steel handle
- Replacement heads available

43325 - Bulk 12 pack
43338 - IB

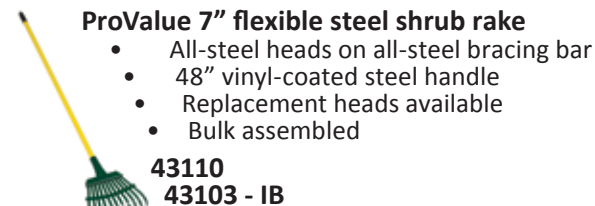

ProValue 7" flexible steel shrub rake

- All-steel heads on all-steel bracing bar
- 48" vinyl-coated steel handle
- Replacement heads available
- Bulk assembled

43110
43103 - IB

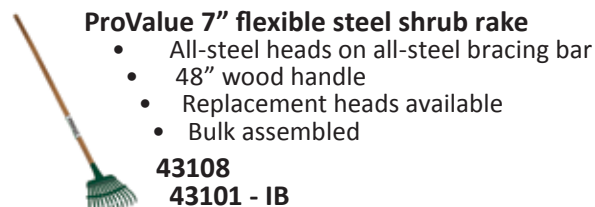

ProValue 7" flexible steel shrub rake

- All-steel heads on all-steel bracing bar
- 48" wood handle
- Replacement heads available
- Bulk assembled

43108
43101 - IB

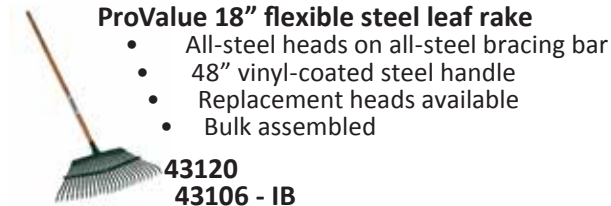

ProValue 18" flexible steel leaf rake

- All-steel heads on all-steel bracing bar
- 48" vinyl-coated steel handle
- Replacement heads available
- Bulk assembled

43120
43106 - IB



ProValue 18" flexible steel leaf rake

- All-steel heads on all-steel bracing bar
- 48" wood handle
- Replacement heads available
- Bulk assembled

43118
43104 - IB

PRO-FLEX REPLACEMENT HEADS:

- 43351 - Midwest Rake Pro-Flex 8" Replacement Head**
- 43352 - Midwest Rake Pro-Flex 18" Replacement Head**
- 43353 - Midwest Rake Pro-Flex 24" Replacement Head**

RAKES - LAWN AND LEAF

Our poly leaf rakes offer a single-piece head design for durability and longevity. The self-cleaning design is one of the best on the market. It typically only takes one easy back sweep to free the tines from leaves and debris.

40872 Structron 24" poly leaf rake PR24

- 26 tine 24" poly head
- 51" extra-reach fiberglass handle with comfort cushion grip

SP13729 - Replacement 24" poly head



Midwest Rake 8" poly shrub rake

- 8" poly head
- 42" wood handle LF-8

40880 - Bulk 12 pack
40881 - IB



Midwest Rake 24" poly leaf rake

- 24" poly head
- 54" extra-reach wood handle LF-20

40882 - Bulk 12 pack



Midwest Rake 24" poly leaf rake, cushion grip

- 24" poly head
- 54" extra-reach wood handle with cushion grip LF-20CG

40883 - Bulk 12 pack



Midwest Rake 32" poly leaf rake

- 32" poly head
- 48" wood handle LF-30P

40884 - Bulk 12 pack



Midwest Rake 32" poly leaf rake, cushion grip

- 32" poly head
- 48" wood handle with cushion grip, LF-30PCG

40885 - Bulk 12 pack



43372 ProValue 22/22 poly leaf rake

- 22 tine 22" poly head with steel tines
- 48" hardwood handle



FIBERGLASS / BOW - RAKES

Curved tines on our bow rakes move soil effectively and are useful for separating and gathering stones and other debris from topsoil. The bow design gives the user greater control over the tine depth, while the extended-handle models allow maximum control.

- 42366 Structron 16" bow rake BR16**
- 16 tine 16" forged head
 - 60" extended length fiberglass handle with cushion grip (SA32000)



- 42324 Seymour 15" bow rake BR-40**
- 14 tine 15" welded head
 - 60" extended length fiberglass handle with vinyl grip



SUPERIOR STRENGTH: WELDED AND RIVETED



Our Kenyon and Seymour bow rakes are heavy-duty and long lasting tools. The head-to-handle connection features a unique tapered steel plug (except 42324) that is press fit into the powder-coated aluminum handle and then drilled and riveted all the way through. The bow rakes also feature a steel bow that is moved closer to the edge of the head, providing greater lateral stability, and is welded on both the front and back sides of the head for greater strength.

- 42314 Seymour 14" bow rake**
- 14" tempered head with welded & riveted steel plug
 - 60" extended length powder-coated aluminum handle



- 42600 Kenyon 14" bow rake**
- 14" tempered head with welded & riveted steel plug
 - 60" extended length powder-coated aluminum handle



- 42316 Seymour 17" bow rake**
- 17" tempered head with welded & riveted steel plug
 - 60" extended length powder-coated aluminum handle



- 42604 Kenyon 17" bow rake**
- 17" tempered head with welded & riveted steel plug
 - 60" extended length powder-coated aluminum handle



- 42364 ProValue 14" bow rake BR-80**
- 14 tine 14" welded head
 - 48" fiberglass handle



RAKES - WOOD / BOW AND SPECIAL

42357 Structron 16" bow rake

- 16 tine 16" forged head
- 60" extended length hardwood handle BR-35



42356 Seymour 15" bow rake

- 14 tine 15" welded head
- 60" extended length hardwood handle BR-30



42355 Seymour 15" bow rake

- 14 tine 15" welded head
- 54" hardwood handle BR-20



42320 ProValue 14" bow rake

- 14 tine 14" welded head
- 54" hardwood handle BR-10



42016 Smart Buy 14" bow rake

- 14 tine 14" welded head
- 48" wood handle BR-90



ASPHALT RAKE

63128 Structron 16" forged asphalt rake

- 14 tine 16" forged steel head with 1/2" shank
- 60" hardwood handle AR-30

ADVANTAGES:

- Heavy-duty construction, designed for tough use in asphalt paving
- Long shank for extra reach to prevent asphalt build up



THATCHING RAKE

63130 Seymour grooming and thatching rake

- 20 teeth 15" head
- 60" extended hardwood handle TR-30

WHY THATCH?

Flanged teeth on both sides are designed for removing then collecting thatch and dead grass from lawns



LEVEL HEAD - RAKES

42390 Structron 16" level head rake LH16

- 16 tine 16" steel head
- Riveted head-to-handle connection
- 64" fiberglass handle

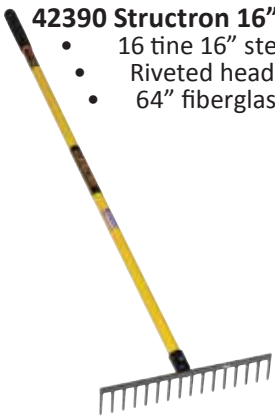

63126 Structron 18" forged stone rake

- 16 tine 18" forged steel head
- Double riveted head-to-handle connection thru 8" steel ferrule
- 62" hardwood handle



42690 Kenyon 17" level head rake

- 16 tine 17" tempered head with welded & riveted steel plug
- 66" powder-coated aluminum handle



42350 Seymour 15" level head rake

- 14 tine 15" steel head
- 60" hardwood handle FR-21



40020 Seymour 17" level head rake

- 16 tine 17" tempered head with welded & riveted steel plug
- 66" powder-coated aluminum handle



63124 Structron 16" forged stone rake

- 14 tine 16" forged steel head
- 62" hardwood handle SR-30



42351 Seymour 16" level head rake

- 16 tine 16" steel head
- 66" hardwood handle



RAKES - LANDSCAPE

We invented the bolted-through wrap-around bracing that distinguishes the Structron and Midwest Rake brand rakes from other imitators. We use a solid aluminum plug in the head-to-handle connection, unlike other brands that use wood or plastic plugs, or even no plug at all. The rake head is an engineered aluminum/magnesium alloy, selected for durability and strength.

Structron aluminum landscape rake

- Heavy-duty aluminum head and wrap-around bracing
- 66" fiberglass handle with cushion grip
- Replacement handle available (#SA20400)

12100 - 24" head LR24

12101 - 30" head

12102 - 36" head LR36

12103 - 42" head

12104 - 48" head



Structron aluminum screening rake

- Heavy-duty aluminum head and wrap-around bracing
- 66" fiberglass handle with cushion grip

11100 - 24" head

11101 - 30" head

11102 - 36" head

11103 - 42" head

11104 - 48" head



16114 Midwest Rake 14" aluminum mini landscape rake

- All-aluminum construction with "push-pull" bracing
- 60" powder-coated aluminum handle
- Great for gardening and homeowner landscaping



16117 Midwest Rake 17" aluminum mini landscape rake

- All-aluminum construction with "push-pull" bracing
- 60" powder-coated aluminum handle
- Great for gardening and homeowner landscaping



**ALL PRODUCTS ON THIS PAGE
ARE MADE IN THE USA** (UNLESS NOTED)

Midwest Rake aluminum landscape rake

- Heavy-duty aluminum head & wrap-around bracing
- 66" powder-coated aluminum handle with vinyl grip

10024 - 24" head

10030 - 30" head

10036 - 36" head

10042 - 42" head

10048 - 48" head



LANDSCAPE RAKES

have rounded teeth which provide a smooth non-gouging raking action, while its striking edge is excellent for grading. Strong wrap-around bracing and heavy-duty double rib construction maximizes head stability and ensures long-lasting performance, even under the heaviest professional use.

Midwest Rake aluminum field/aggregate rake

- Heavy-duty aluminum head & wrap-around bracing
- 66" powder-coated aluminum handle with vinyl grip

12024 - 24" head

12030 - 30" head

12036 - 36" head

12042 - 42" head

12048 - 48" head

12072 - 72" head

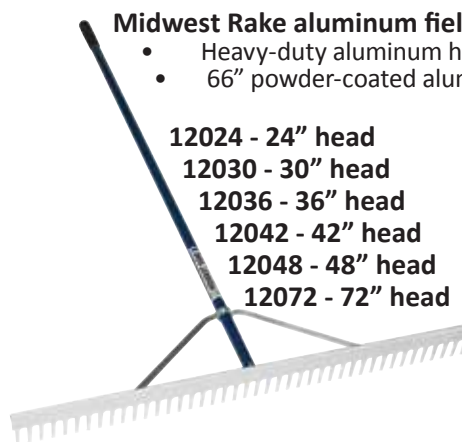

FIELD/AGGREGATE RAKES

have rounded teeth offer smooth non-gouging raking action, while its durable 66" powder-coated aluminum handle with non-slip vinyl grip and strong wrap-around bracing take a real beating and yet still provide for long-lasting, comfortable performance.



ALL PRODUCTS ON THIS PAGE
ARE MADE IN THE USA (UNLESS NOTED)

Kenyon Great Rake II

- Heavy-duty aluminum head and wrap-around bracing
- 66" powder-coated aluminum handle

14024 - 24" single rake	14124 - Bulk 6 pack
14030 - 30" single rake	14130 - Bulk 6 pack
14036 - 36" single rake	14136 - Bulk 6 pack
14042 - 42" single rake	14142 - Bulk 6 pack
14048 - 48" single rake	14148 - Bulk 6 pack

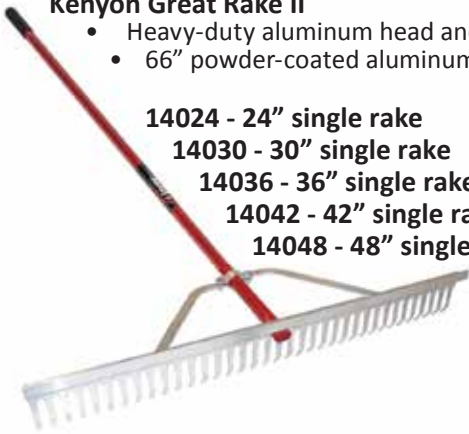

GREAT RAKE II

The name says it all... this is a "great rake" for raking and leveling. The long curved teeth provide more efficient grading on the backstroke, while the deep grading edge allows for superior leveling. All aluminum construction with a 66" red powder-coated aluminum handle and wrap-around bracing.

ProValue aluminum field/aggregate rake

- All-aluminum construction with "push-pull" bracing
- 66" powder-coated aluminum handle
- Bulk 6 pack

92324 - 24" POP pkg	92024 - Brown box
92330 - 30" POP pkg	92030 - Brown box
92336 - 36" POP pkg	92036 - Brown box
92342 - 42" POP pkg	92042 - Brown box
92348 - 48" POP pkg	92048 - Brown box



ProValue



FIELD / AGGREGATE RAKES

This head is designed with an excellent grading and striking edge and rounded, non-gouging teeth. Its 66" powder-coated aluminum handle provides extra comfort, while its push-pull bracing is twisted in opposite directions to eliminate head wobble.

ProValue aluminum landscape rake

- Solid aluminum head with "push-pull" bracing
- 60" hardwood handle
- Bulk 6 pack

90424 - 24" POP pkg	90324 - Brown box
90430 - 30" POP pkg	90330 - Brown box



ProValue



HOMEOWNER LANDSCAPING

Designed with the consumer in mind, this landscape rake comes complete with a solid aluminum head, "push-pull" bracing to eliminate head wobble, and a 60" hardwood handle.

RAKES - ALUMINUM / SPECIALTY

Our specialty rakes include innovations only available from Midwest Rake. We listen to user needs and develop tools that get the job done better and smarter. Some tools offer multi-tasking capability for ultimate convenience.



ALL PRODUCTS ON THIS PAGE
ARE MADE IN THE USA (UNLESS NOTED)

Midwest Rake aluminum dual purpose rake

- Heavy-duty aluminum head and bracing
- Powder-coated aluminum handle with vinyl grip

12517 - 17" head, "push-pull" bracing and 60" handle

12524 - 24" head, wrap-around bracing and 66" handle

12536 - 36" head, wrap-around bracing and 66" handle



MIDWEST RAKE®



WHY A DUAL PURPOSE RAKE?

A Seymour Midwest exclusive. This innovative and versatile tool has two teeth profiles. The short teeth are used for breaking up hard packed clay and grading, while the long teeth are for wet clay and general raking.

Midwest Rake aluminum chisel tooth rake

- Extra-thick aluminum teeth and wrap-around bracing
- 66" powder-coated aluminum handle with vinyl grip

20024 - 24" head

20030 - 30" head

20036 - 36" head

20042 - 42" head

20048 - 48" head

20060 - 60" head

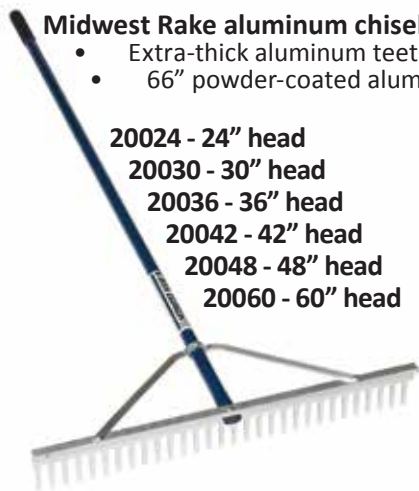

CHISEL TOOTH RAKE DESIGN:

The aggressive chisel-sharp teeth and forward grading edge set this rake apart from our others. It is an excellent choice when you need to penetrate and break up hard soils. It also works exceptionally well when spreading concrete or stone.

Midwest Rake aluminum screening rake

- Heavy-duty aluminum head and wrap-around bracing
- 66" powder-coated aluminum handle with vinyl grip

11024 - 24" head

11030 - 30" head

11036 - 36" head

11042 - 42" head

11048 - 48" head



SCREENING RAKE DESIGN:

This rake is specially designed for sifting, grading, and screening. It is an excellent tool when you need to sift or screen stones and debris from sand or fine soil.

ALUMINUM / SPECIALTY - RAKES

73320 Kenyon steel backfill rake

- Heavy-duty 20" replaceable steel head
- 60" powder-coated aluminum handle with vinyl grip

SP13470 - Replacement head for 73320



MORE EFFECTIVE THAN A SHOVEL FOR...

many landscaping, irrigation, and utility settings. A great tool for quickly backfilling trenches and moving soil and aggregate materials. Heads are replaceable.

41366 Seymour 11" McLeod rake

- Heat-treated, 11" steel head with 4" teeth
- Head is welded to the ferrule with 4 rivets
- 48" hardwood handle



WHAT IS A MCLEOD RAKE?

A favored tool for firefighters when clearing fire lines, but also a heavy-duty tool for clearing any form of trail or pathway... or even creating a new planting bed or garden. The head measures 9" tall x 11" wide with 4" reinforced teeth.

16113 Seymour 14" horse trailer rake

- All-aluminum construction with "push-pull" bracing
- 50" powder-coated aluminum handle



COMPACT FOR A PURPOSE

A compact 50" length rake that fits in a trailer tack box. This small 14" head size has straighter pitched teeth and a generous grading edge and is easy to handle.

Midwest Rake baserunner field rake

- Aluminum head with rounded, non-gouging teeth
- Double lock 39" - 70" telescoping fiberglass Superhandle®

12501 - 24" head
12502 - 30" head
12503 - 36" head



THE PROFESSIONALS CHOICE

Knocks down for easy storage. The perfect tool for grooming infields and beach volleyball courts. The head was designed specifically for the sports turf industry, but it is also highly respected in the professional lawn and garden industry. The high straight edge is excellent for grading.

52917 Midwest Rake 17" mound and plate shaper

- Heavy-duty aluminum head and bracing
- 66" powder-coated aluminum handle



A "UTILITY INFIELDER" YOU CAN PLAY EVERYDAY...

The perfect size for restoring the pitching mound to a professional surface, just scarify, level, tamp and repeat. Great for shaving and carving the pitching mound. The flat front of this tool can be used as a tamp in secondary areas where light tamping is required.

RAKES - AQUATIC

Our aquatic rakes are a safe and effective way to remove unwanted weeds from lakes, ponds and golf course water hazards, without need for hazardous chemicals or expensive dredging. Built for maximum reach from on-shore or on-dock use, these rakes make it easy to gather and remove plant debris.



ALL PRODUCTS ON THIS PAGE
ARE MADE IN THE USA (UNLESS NOTED)

87028 Midwest Rake 28" Aquatic Weed Eradicator (AWE)

- Reinforced 28" serrated cutting blade (replaceable)
- 11', 2-piece rust proof powder-coated aluminum handle
Additional 66" extension handle sections available

SA10024 - Replacement blades for AWE

87003 - Extension handle sections



MIDWEST RAKE®



SIMPLY AN AWE-SOME TOOL

The AWE, exclusive to Seymour Midwest, is the most effective bottom-cutting weed removal tool available on the market. No need for dangerous and expensive chemicals; this tool removes weeds at their source. You don't have to worry about the reinforced blades bending under a heavy load of weeds.

86036 Midwest Rake 36" aluminum lake rake with 11' handle

- Heavy-duty aluminum head with wrap-around bracing
- Detachable poly float and 50' poly rope also included
- 11', 2-piece rust proof powder-coated aluminum handle
Additional 66" extension handle sections available

SP50065 - Replacement poly rope for lake rake (not made in USA)

87003 - Extension handle sections



A FLOATING RAKE?

Use it to skim floating aquatic vegetation and algae from the water. By shortening the handle and removing the float, you have a professional-grade landscaping rake, excellent for dressing beach sand. Float colors may vary.

86050 Midwest Rake 36" aluminum lake rake with 66" handle

- Heavy-duty aluminum head and wrap-around bracing
- Wire woven through heavy-duty teeth uproots aquatic weeds
- 66" powder-coated aluminum handle with 50' of poly rope

SP50065 - Replacement poly rope
for lake rake (not made in USA)



WIRE WOVEN TEETH...

A safe and effective way to seasonally weed lakes, ponds, golf course water traps. Wire woven through heavy-duty teeth uproots aquatic weeds.



**ALL PRODUCTS ON THIS PAGE
ARE MADE IN THE USA (UNLESS NOTED)**

82728 Structron 28" broom, 2 bristle rows

- Industrial - maximum duty broom
- 60" fiberglass handle, cushion grip



83728 Structron 28" broom, 3 bristle rows

- Industrial - maximum duty broom
- 60" fiberglass handle, cushion grip



82704 Structron 24" duo broom

- Heavy-duty broom for smooth surfaces
- 60" fiberglass handle, cushion grip



82706 Structron 36" broom, 3 bristle rows

- Heavy-duty broom
- 60" fiberglass handle, cushion grip



These brooms have a highly effective sweeping action because of its strong inside bristles with outside bristles specifically designed to sweep the finest of materials.



82104 Structron 24" duo broom

- Heavy-duty broom for smooth surfaces
- 60" ergonomic powder coated aluminum handle



82106 Structron 36" duo broom

- Heavy-duty broom for smooth surfaces
- 60" ergonomic powder-coated aluminum handle



47045 Structron 12" flat steel wire broom

- Heavy-duty broom
- 60" fiberglass handle, cushion grip
- For aggressive cleaning or scrubbing



47046 Structron 16" round steel wire broom

- Heavy-duty broom
- 60" fiberglass handle, cushion grip
- For aggressive cleaning or scrubbing



82014 Seymour 24" push broom PB24

- Medium-duty broom for smooth surfaces
- 60" fiberglass handle, cushion grip



82008 Seymour 24" push broom PB24R

- Medium-duty broom for rough surfaces
- 60" fiberglass handle, cushion grip



82724 Structron 24" general purpose broom

- Heavy-duty broom
- 60" fiberglass handle, cushion grip



82736 Structron 36" general purpose broom

- Heavy-duty broom
- 60" fiberglass handle, cushion grip



82124 Structron 24" general purpose broom

- Heavy-duty broom
- 60" ergonomic powder-coated aluminum handle



82136 Structron 36" general purpose broom

- Heavy-duty broom
- 60" ergonomic powder-coated aluminum handle



82118 Structron 18" street/landscape broom

- Heavy-duty broom
- 60" ergonomic powder-coated aluminum handle



82718 Structron 18" street broom

- Heavy-duty broom
- 60" fiberglass handle, cushion grip



82926 Seymour 24" general purpose broom

- Heavy-duty broom
- Collapsible fiberglass handle



82018 Seymour 24" street broom SB24R

- Medium-duty broom for rough surfaces
- 60" fiberglass handle, cushion grip



BROOMS

Building a better professional broom starts with our super-strong gusset bracing, the strongest head-to-handle connection on the market today. Choose from brooms for rough surfaces, smooth surfaces or “duo” models that combine bristles for all-purpose use. Our bent “ergonomic” aluminum handles provide more effective head-to-surface contact while promoting comfort and ease of use.



**ALL PRODUCTS ON THIS PAGE
ARE MADE IN THE USA** (UNLESS NOTED)

82614 Kenyon 24" wonder broom

- 3" medium bristles, super-strong gusset bracing
- 60" powder-coated aluminum handle
- Superior sweeping action

For smooth and semi-smooth surfaces such as warehouse floors and cement. The best value for maintenance dollars spent.



82602 Kenyon 24" wonder broom

- 3" dual bristles, super-strong gusset bracing
- 60" powder-coated aluminum handle
- Versatile multi-purpose

An ideal combination broom for gardeners, landscapers and anyone wanting to move a heavy load as well as fine dust with the same broom.



82624 Kenyon 24" wonder broom

- 3" stiff bristles, super-strong gusset bracing
- 60" powder-coated aluminum handle
- Heavy-duty garage style

Unaffected by chemicals, oils, or petroleum solvents. A top performing, best selling garage style broom.



82918 Seymour 18" street/landscape broom

- 5" stiff bristles, super-strong gusset bracing
- 60" ergonomic powder-coated aluminum handle

The ergonomic handle is very comfortable to use and levels the bristle contact to the floor for maximized efficiency.



82919 Seymour 18" street/landscape broom

- 5" stiff bristles, super-strong gusset bracing
- 60" powder-coated aluminum handle

Stiff, extra-long bristles make this street broom an excellent choice when you are dealing with rough surfaces.



82902 ProValue 24" economy duo broom

- 3" stiff bristles, wrap-around bracing
- 60" hardwood handle



82924 Seymour 24" general purpose broom

- 3" durable bristles, super-strong gusset bracing
- 60" ergonomic powder-coated aluminum handle



82925 Seymour 24" general purpose broom

- 3" durable bristles, super-strong gusset bracing
- 60" straight powder-coated aluminum handle



These general purpose brooms use durable polypropylene bristles, firmly attached to a high quality hardwood shoulder.



82936 Seymour 36" general purpose broom

- 3" durable bristles, super-strong gusset bracing
- 60" ergonomic powder-coated aluminum handle



82904 Seymour 24" duo broom

- 3" durable bristles, super-strong gusset bracing
- For use on smooth surfaces
- 60" ergonomic powder-coated aluminum handle



82905 Seymour 24" duo broom

- 3" durable bristles, super-strong gusset bracing
- For use on smooth surfaces
- 60" straight powder-coated aluminum handle



82906 Seymour 36" duo broom

- 3" durable bristles, super-strong gusset bracing
- For use on smooth surfaces
- 60" ergonomic powder-coated aluminum handle



SPECIALTY - BROOMS

Our selection of brooms extends beyond traditional pavement-style brooms. We also offer specialty brooms for large-area pavement cleaning, athletic field dressing and brushes for applying pavement seal coating products. For additional cleaning solutions, also see our squeegee products.



**ALL PRODUCTS ON THIS PAGE
ARE MADE IN THE USA (UNLESS NOTED)**

Seymour 28" industrial maximum duty broom

- 3" durable bristles, wrap-around bracing
- Scraping edge for breaking up dirt
- 60" ergonomic powder-coated aluminum handle
- Replaceable bristle rows (SP50068)

82928 - Broom with 2 bristle rows
83928 - Broom with 3 bristle rows



Seymour 28" double play scarifier broom

- 3" durable bristles, wrap-around bracing
- 66" powder-coated aluminum handle
- Replaceable bristle rows (SP50068)

82328 - Broom with 2 bristle rows
83328 - Broom with 3 bristle rows

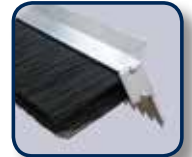

Seymour 7' double play monster field broom

- 3.5" bristles plus short teeth for breaking up dirt
- Grooms infield and then brush to finish
- A-frame foam padded handle with hanging hooks
- Replaceable bristle rows (SP50067)

82384 - Broom with 2 bristle rows
83384 - Broom with 3 bristle rows



Seymour 7' monster warehouse stadium drag broom

- 3.5" durable bristles
- For large area pavement cleaning
- A-frame foam padded handle with hanging hooks
- Replaceable bristle rows (SP50067)

82084 - Broom with 2 bristle rows
83084 - Broom with 3 bristle rows



82500 Seymour heavy-duty contractor corn broom

- Contractor-grade product
- Not a typical "box house" broom *(not made in the USA)*



Midwest Rake water broom

- Aluminum with high-pressure nozzles
- Insulated pistol grip garden hose type nozzle
- Brass fittings and caster roller wheels
- Not for use with pressure washers

**46032 - 32" water broom
w/8 nozzles, 4.75 GPM at 50PSI**
**46048 - 48" water broom
w/12 nozzles, 5 GPM at 50PSI**



47025 Midwest Rake 12" flat steel wire broom

- 5" wire head and super-strong gusset bracing
- 60" ergonomic powder-coated aluminum handle



47026 Midwest Rake 16" round steel wire broom

- 3.75" wire head and super-strong gusset bracing
- 60" ergonomic powder-coated aluminum handle



77036 Midwest Rake aluminum blacktop sealing brush

- 36" brush with flexible 2.5" poly bristles
- Solid aluminum frame
- 66" powder-coated aluminum handle
- Replacement bristles (SP50039)



77136 Midwest Rake blacktop sealing brush

- 36" brush with durable poly bristles
- Solid aluminum frame
- Used with a threaded tip handle



HOES - STANDARD AND SPECIALTY

Our wide selection of professional-quality hoes offers models for every application and user preference. Standard hoes are for general-duty cultivating and cutting. Warren hoes have a pointed tip for making furrows and working close to existing plants. Beet/nursery hoes have 3 edges for precise use.

- 42458 Structron garden hoe H800**
- 6" heavy-duty forged head
 - Riveted nylon collar
 - 60" fiberglass handle with cushion grip



- 42485 Structron Norwegian krafse hoe**
- 14" curved crescent-shaped head
 - The most popular hand tool in Norway
 - 44" fiberglass handle with cushion grip
 - Great for moving aggregate and dirt!



- 42455 Seymour garden hoe GH-40**
- 6" heavy-duty forged head
 - Riveted nylon collar
 - 54" fiberglass handle with cushion grip



- 42425 ProValue garden hoe GH-80**
- 6" medium-duty welded head
 - Riveted nylon collar
 - 48" fiberglass handle with vinyl grip



- 42410 Seymour gooseneck hoe**
- 6" medium-duty welded head with riveted steel plug
 - 60" powder-coated aluminum handle, vinyl grip



- 42460 Seymour warren hoe (pointed)**
- 6.25" heavy-duty forged head
 - 54" hardwood handle, WH-30



- 42450 Structron garden hoe**
- 6" heavy-duty forged head
 - Steel ferrule
 - 60" hardwood handle, GH-30



- 42420 Seymour garden hoe**
- 6" medium-duty welded head
 - Steel ferrule
 - 54" hardwood handle, GH-20



- 42448 ProValue garden hoe**
- 6" medium-duty welded head
 - Steel ferrule
 - 54" hardwood handle, GH-10



- 42441 SmartBuy garden hoe**
- 6" medium-duty welded head
 - Steel ferrule
 - 48" hardwood handle, GH-90



- 42468 Seymour southern meadow hoe**
- 6" medium-duty welded head
 - 60" hardwood handle, SH-36



- 42469 Seymour southern meadow hoe**
- 7" medium-duty welded head
 - 60" hardwood handle, SH-37



- 42465 Seymour beet / onion hoe**
- 7" heavy-duty forged head
 - 54" hardwood handle, BH-30



- 42466 Seymour beet / nursery hoe**
- 7" heavy-duty forged head
 - 60" hardwood handle, BH-35

SPECIALTY - HOES

Our eye hoes are preferred for heavy-duty digging and cutting to open up planting beds. The grub hoes have a narrower blade for easier and deeper ground penetration. Hardwood handles are sold separately to allow these products to be customized to your preference.

42141 Seymour loop hoe

- 6" x 4" head
- 54" hardwood handle, SH-20



42100 Seymour loop hoe

- 6" x 4" head
- 60" powder-coated aluminum handle
- Replaceable blade (SP10129)



40100 - Individually boxed

WHAT IS A 2-WAY LOOP HOE?

Rocking action makes light work of regular maintenance in the garden with each push-pull.



42610 Kenyon 2-way loop hoe

- 6" x 4" head for landscape contractor
- 60" powder-coated aluminum handle
- Replaceable head assembly (63051)



WHY IS 2-WAY BETTER?

Double-edged weeder bar for efficient push-pull action. Excellent for cultivating, aerating, and weeding.



42800 Seymour eye hoe

- 7" blade, 1-3/4" diameter hole
- American pattern
- Head only, 2E-AE0

63009 - 54" circular shaped handle, DG-AEH
63001 - 60" circular shaped handle, DG-AEH-60
(both handles are 1-3/4" diameter)



42801 Seymour eye hoe

- 7.5" blade, 1-3/4" diameter hole
- American pattern
- Head only, 2E-AE1

63009 - 54" circular shaped handle, DG-AEH
63001 - 60" circular shaped handle, DG-AEH-60
(both handles are 1-3/4" diameter)



42802 Seymour eye hoe

- 7.75" blade, 1-3/4" diameter hole
- American pattern
- Head only, 2E-AE2

63009 - 54" circular shaped handle, DG-AEH
63001 - 60" circular shaped handle, DG-AEH-60
(both handles are 1-3/4" diameter)

EYE HOE FEATURES:

Eye hoes feature large, heavy blades best for heavy-duty digging and cultivating.



42805 Seymour grub hoe

- 4.5" blade, 1-3/4" diameter hole
- Head only, 2E-G60

63009 - 54" circular shaped handle, DG-AEH
63001 - 60" circular shaped handle, DG-AEH-60
(both handles are 1-3/4" diameter)

GRUB HOE FEATURES:

Grub hoe blades are narrower than eye hoes for easier and deeper ground penetration.



42808 Seymour Italian grape hoe

- 7" blade
- Head only, 2E-IG7

63011 - 40" oval shaped handle, DG-IGH

GRAPE HOE FEATURES:

Grape hoes are designed specifically for cultivating and weeding around grape vines.

EDGERS

Create crisp turf boundaries along walkways, driveways and other paved surfaces with our edgers. Our rotary turf edgers have been used for decades for crisp edges without stooping or bending. Gardeners and landscapers appreciate the easy, precise cuts from our half-moon edger.



49042 Seymour half moon turf edger

- 8.75" steel blade welded to ferrule
- 48" hardwood handle, WE-60



HALF MOON TURF EDGERS

Feature turned steps for comfort and control.



49047 Seymour rotary turf edger, single wheel

- 6" blade, single wheel
- 48" hardwood handle, WE-51

ROTARY TURF EDGERS

Features self-sharpening zinc plated blades mounted to ribbed rubber tires for superior cutting power.



49048 Seymour rotary turf edger, dual wheel

- 6" blades, dual wheel
- 48" hardwood handle, WE-52



49043 Seymour half moon turf edger

- 8.75" 12 gauge steel blade with cast-iron socket for maximum durability
- 48" hardwood handle, WE-65



49079 Seymour sod lifter

- 8.75" forged blade
- Removes sod for planting beds and sod repair
- 30" hardwood handle with steel d-grip, SD-20



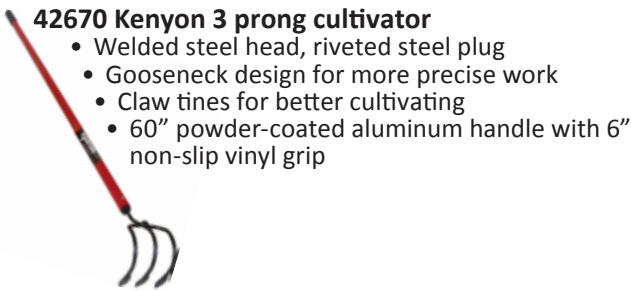

42670 Kenyon 3 prong cultivator

- Welded steel head, riveted steel plug
- Gooseneck design for more precise work
- Claw tines for better cultivating
- 60" powder-coated aluminum handle with 6" non-slip vinyl grip



42244 Seymour 4 prong forged cultivator, GC-40

- 5" forged head, riveted on nylon collar
- 54" fiberglass handle with vinyl grip

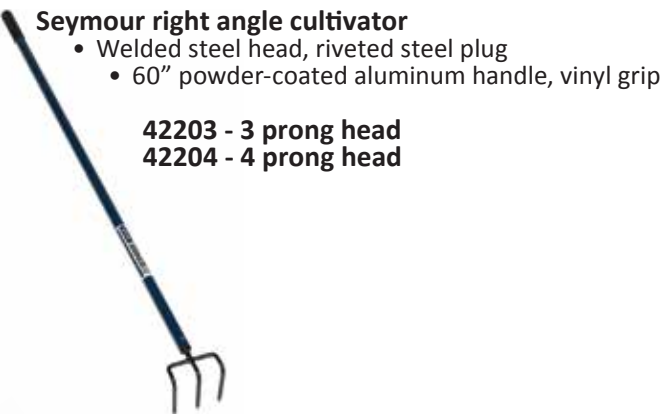

Seymour right angle cultivator

- Welded steel head, riveted steel plug
- 60" powder-coated aluminum handle, vinyl grip

42203 - 3 prong head
42204 - 4 prong head

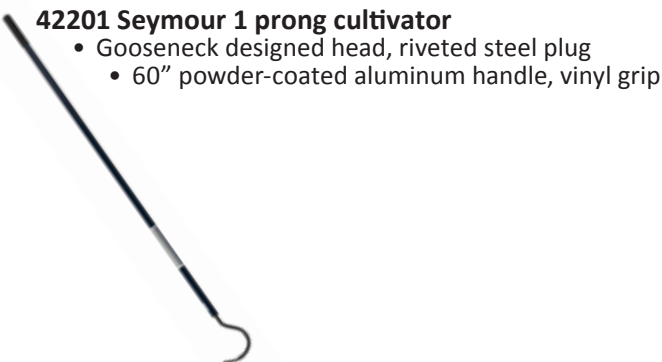

42201 Seymour 1 prong cultivator

- Gooseneck designed head, riveted steel plug
- 60" powder-coated aluminum handle, vinyl grip



42103 Seymour combo cultivator/loop hoe

- 3 prong cultivator head, riveted steel plug
- Replacement loop hoe blade (SP10129)
- 60" powder-coated aluminum handle, vinyl grip

DUAL-PURPOSE DESIGN!
The perfect tool for weeding and cultivating.



42254 Structron 4 prong forged cultivator

- 5" forged head
- 54" contoured hardwood handle, GC-30

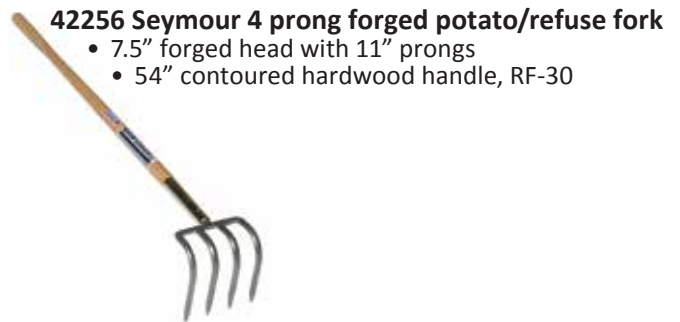

42256 Seymour 4 prong forged potato/refuse fork

- 7.5" forged head with 11" prongs
- 54" contoured hardwood handle, RF-30



42224 Seymour 4 prong cultivator

- 5" welded head
- 54" contoured hardwood handle, GC-20



42004 ProValue 4 prong cultivator

- 5" welded head
- 54" contoured hardwood handle, GC-10

FORKS

Our spading forks are used to work loose soil, aerate sod, dig root crops, transplant bulbs and divide perennial plants. Our manure forks are prized for moving mulch and light material without sifting.



49284 Structron forged spading fork SP30

- 4 tine head riveted on 8" chrome ferrule
- 30" fiberglass handle with poly d-grip



49283 Seymour forged spading fork SF-40

- 4 tine head
- 30" fiberglass handle with poly d-grip



49077 Structron forged spading fork

- 4 tine head
- 29" hardwood handle with steel d-grip, SF-30



49076 ProValue forged spading fork

- 4 tine head
- 31" hardwood handle steel d-grip, SF-10



49288 Structron forged compost fork CF5

- 5 tine head riveted on 8" chrome ferrule
- 54" fiberglass handle with cushion d-grip



49286 Seymour forged manure fork

- 5 tine head
- 48" fiberglass handle with vinyl grip, MF-45



49274 Seymour forged manure fork

- 4 tine head
- 48" hardwood handle, MF-24



49275 Seymour forged manure fork

- 4 tine head
- 54" hardwood handle, MF-24L



49276 Seymour forged manure fork

- 5 tine head
- 48" hardwood handle, MF-25



49277 Seymour forged manure fork

- 5 tine head
- 54" hardwood handle, MF-25L



49278 Seymour forged manure fork

- 6 tine head
- 54" hardwood handle, MF-26



49070 Seymour bedding fork

- 10 tine welded head
- 48" hardwood handle, BF-25



44111 Seymour bedding fork

- 16" poly head
- 52" wood handle
- Individually boxed

44111BA Seymour bedding fork

- 16" poly head
- 52" wood handle
- Bulk assembled, BF-20P



Bedding forks are designed to remove manure from stock bedding. They also work great for spreading mulch, compost and sifting leaves. Ensilage forks are for loading and unloading silage and working with mulch. Hay and barley straw forks make it easy to lift and move hay and straw.



44112 Seymour bedding fork

- 16" poly head
- 42" wood handle with poly d-grip



44115 Seymour super bedding fork

- 16" poly head
- Doubles as a clean-up tool
- 52" vinyl-coated steel handle



44118 Seymour super bedding fork

- 16" poly head
- Doubles as a clean-up tool
- 52" powder-coated aluminum handle



49273 Seymour forged hay fork

- 3 tine head
- 48" hardwood handle, HF-20



49279 Seymour forged barley/straw fork

- 5 tine head
- 54" hardwood handle, AF-20



49280 Seymour forged barley/straw fork

- 5 tine head
- 30" hardwood handle with steel d-grip, AF-20D



49285 Structron forged ensilage fork

- 10 tine head
- 30" hardwood handle with steel d-grip, EF-30D

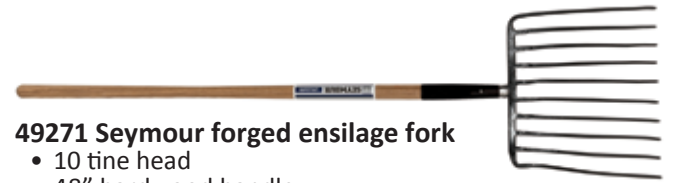

49271 Seymour forged ensilage fork

- 10 tine head
- 48" hardwood handle



49272 Seymour forged ensilage fork

- 10 tine head
- 30" hardwood handle with steel d-grip



49078 Seymour ensilage fork

- 10 tine welded head
- 30" hardwood handle with poly d-grip, EF-20D



42258 Seymour mushroom fork

- 4 tine head
- 30" hardwood handle with steel d-grip, FF-30

SCOOPS - FIBERGLASS AND POLYMER

Our professional aluminum and poly scoops are lightweight for operator comfort and corrosion resistant for longevity. Grain scoops are ideal for moving bulk granular materials and are offered in multiple configurations to match user preference. Western patterns have reinforcing ribs in the pan for heavy use.



49217 Structron general purpose scoop GP14

- #2 steel head
- 48" fiberglass handle with cushion grip



49216 Structron general purpose scoop GP14D

- #2 steel head
- 29" fiberglass handle with poly d-grip

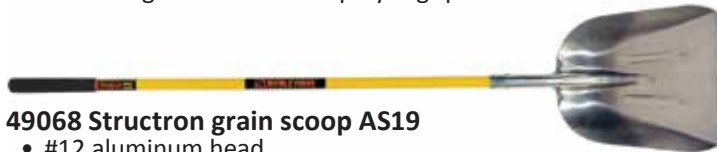

49068 Structron grain scoop AS19

- #12 aluminum head
- 51" fiberglass handle with cushion grip



49069 Structron grain scoop AS19D

- #12 aluminum head
- 29" fiberglass handle with poly d-grip



49251 Structron grain scoop GS18

- #12 ABS head
- 51" fiberglass handle with cushion grip



49253 Structron grain scoop GS18D

- #12 ABS head
- 29" fiberglass handle with poly d-grip



49010 Seymour grain scoop SV-SDP12

- #12 poly head
- 27" fiberglass handle with poly d-grip

SCOOP SIZE CHART		
HEAD STYLE	MATERIAL TYPE	HEAD SIZE
#2 Gen Purp	Steel	11" x 13.5"
#2 Coal	Steel	13.5" x 14.5"
#6	Steel	12" x 16.25"
#8	Polymer	14" x 17"
#8	Steel	14" x 17"
#10	Aluminum	14.5" x 18"
#10	Heavy Alum	14.5" x 18"
#10	Poly	13.5" x 17"
#12	ABS / Poly	14.25" x 19"
#12	Aluminum	15.25" x 19"
#12	Steel	15" x 19"
#14	Aluminum	15.5" x 20"



49510 Toolite scoop, d-grip

- One-piece, injection molded polymer
- #8, 14" x 17" head
- 27" handle with d-grip



49910 Seymour Eastern pattern scoop

- One-piece, injection molded
- #8, 14" x 17" head
- 27" handle with d-grip



49010LO Seymour grain scoop SV-SDP12L

- #12 poly head
- 36" fiberglass handle with poly d-grip



49257 Structron Eastern pattern scoop

- #2 steel head, 11.125" x 16"
- 27" hardwood handle with steel d-grip



49260 Structron grain scoop

- #10 heavy aluminum head
- 36" hardwood handle with steel d-grip



49262 Structron grain scoop

- #14 heavy aluminum head
- 36" hardwood handle with steel d-grip



49512 Toolite traditional scoop

- 13" x 12" traditional, aluminum head
- 48" hardwood handle



49513 Toolite shovel/scoop

- 10" x 12" aluminum head
- 48" hardwood handle



49062 Seymour grain scoop

- #10 aluminum head
- 29" hardwood handle with steel d-grip, SV-SDA10



49240 Seymour grain scoop

- #10 heavy aluminum head
- 29" hardwood handle with steel d-grip, SV-SDA10H



49242 Seymour grain scoop

- #10 heavy aluminum head
- 40" hardwood handle with steel d-grip, SV-SDA10HL



49241 Seymour grain scoop

- #10 aluminum head
- 36" hardwood handle with steel d-grip, SV-SDA10HM



49061 Seymour Western pattern scoop

- #10 aluminum head
- 48" hardwood handle



49266 Seymour Western pattern scoop

- #12 aluminum head
- 36" hardwood handle with steel d-grip



49265 Seymour grain scoop

- #12 aluminum head
- 29" hardwood handle with steel d-grip, SV-SDA12



49064 Seymour grain scoop

- #12 aluminum head
- 48" hardwood handle, SV-SLA12



49267 Seymour grain scoop

- #14 aluminum head
- 36" hardwood handle with steel d-grip, SV-SDA14HM



49269 Seymour grain scoop

- #14 aluminum head
- 40" hardwood handle with steel d-grip, SV-SDA14HL

SCOOPS - WOOD

General purpose scoops provide handy tools sized between square point shovels and larger grain scoops. They are best for moving sand, gravel, asphalt and other construction materials. They are also often used for snow removal, scraping and general clean-up.



- 49270 Seymour grain scoop**
- #14 aluminum head
 - 29" hardwood handle with steel d-grip, SV-SDA14



- 49066 Seymour Western pattern scoop**
- #14 aluminum head
 - 48" hardwood handle



- 49060 Seymour Eastern pattern general purpose scoop**
- #2 11" x 13.5" aluminum head
 - 48" hardwood handle



- 49219 Seymour Western pattern scoop**
- #12 steel head
 - 36" hardwood handle with steel d-grip



- 49019 Seymour grain scoop**
- #12 steel head
 - 29" hardwood handle with steel d-grip, SV-SDS12



- 49248 Seymour coal scoop**
- #2 steel head
 - 29" hardwood handle with steel d-grip, SV-SDSC2



- 49249 Seymour coal scoop**
- #2 steel head
 - 54" hardwood handle, SV-SLSC2-54



- 49018 Seymour Eastern pattern scoop**
- #2 steel head
 - 29" hardwood handle with steel d-grip



- 49006 Seymour Eastern pattern scoop**
- #6 steel head
 - 29" hardwood handle with steel d-grip



- 49008 Seymour Western pattern scoop**
- #8 steel head
 - 29" hardwood handle with steel d-grip



- 49013 ProValue general purpose scoop**
- #2 steel head
 - 26" hardwood handle with steel d-grip, SV-SS10



- 49016 ProValue scoop/asphalt shovel**
- #2 steel head
 - 36" hardwood handle with steel d-grip, SV-SS10L



- 49017 ProValue scoop/asphalt shovel**
- #2 steel head
 - 44" hardwood handle, SV-SS11



- 49053 Seymour grain scoop**
- #12 poly head
 - 29" hardwood handle with poly d-grip, SV-SDP12W



- 49054 Seymour grain scoop**
- #12 poly head
 - 36" hardwood handle with poly d-grip, SV-SDP12WL



- 49051 Seymour Western pattern scoop**
- #12 ABS head
 - 48" hardwood handle



- 49050 ProValue grain/snow scoop**
- #12 poly head
 - 29" hardwood handle with poly d-grip, SV-SDP12WP

SCRAPERS

Scrapers are used to remove ice on walks and drives, remove old flooring and roofing, clean concrete, and for general clean-up on construction sites and farms. These super-duty scrapers are also rugged enough to sever roots and loosen hard-packed soil.



- 49039 Structron 7" scraper SW7**
- Forged head
 - 51" fiberglass handle, cushion grip

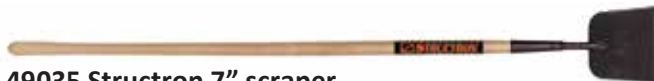

- 49035 Structron 7" scraper**
- Forged head
 - 54" hardwood handle, SC-30



- 49030 Seymour 7" scraper**
- Riveted head
 - 48" hardwood handle, SC-20



- 49029 ProValue 7" scraper**
- Welded head
 - 48" hardwood handle, SC-10



- 96640 Seymour 3.5" ice chisel**
- Forged head
 - 48" hardwood handle, IC-30



- 96811 Seymour barn scraper**
- 24" x 7" reversible steel head (SA11014)
 - 60" hardwood handle, SC-24



IDEAL FOR GENERAL CLEAN UP ON CONSTRUCTION SITES AND FARMS

- 15 gauge, heavy-duty steel
- Steel, dual bracket bracing
- Chrome plated ferrule

SUPERSCRAPERS™ ARE USEFUL FOR...

removing ice on walks and drives, removing old flooring and roofing, cleaning concrete, and for general clean-up on construction sites and farms. These super-duty scrapers are also rugged enough to sever roots and loosen hard-packed soil.



- 49031 Seymour 4" SuperScraper™**
- Steel head
 - 54" hardwood handle, SC-48



- 49032 Seymour 4" SuperScraper™**
- Steel head
 - 36" hardwood handle with poly d-grip



- 49033 Seymour 7" SuperScraper™**
- Steel head
 - 54" hardwood handle, SC-79



- 49034 Seymour 7" SuperScraper™**
- Steel head
 - 36" hardwood handle with poly d-grip, SC-79D

MIDWEST RAKE

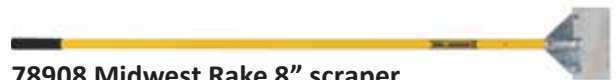

- 78908 Midwest Rake 8" scraper**
- Stainless steel head
 - Replaceable blade (SP50027)
 - Gusset bracing
 - 66" powder-coated aluminum handle



- 78912 Midwest Rake 12" scraper**
- Stainless steel head
 - Replaceable blade (SP50028)
 - Gusset bracing
 - 66" powder-coated aluminum handle



- 78916 Midwest Rake 16" scraper**
- Stainless steel head
 - Replaceable blade (SP50029)
 - Gusset bracing
 - 66" powder-coated aluminum handle



POST HOLE DIGGERS

Our post hole diggers have been and always will be 100% American made. Seymour Midwest manufactures the most complete line of post hole diggers in the industry, consisting of 25 different diggers, including models for fencing contractors, utility linemen, and others who require precision performance.

THE HERCULES PATTERN...
provides maximum strength for the most demanding industrial and commercial jobs.



- 21210 Structron hercules digger PD48**
- 6.25" point spread, .112" thick
 - 48" fiberglass handle, cushion grip



- 21219 Structron hercules digger PD96**
- 6.25" point spread, .112" thick
 - 96" fiberglass handle, cushion grip



- 21211 Seymour Hercules digger DG-11FG**
- 6.25" point spread, .112" thick
 - 48" fiberglass handle, vinyl grip



- 21215 Structron hercules digger**
- 6.25" point spread, .112" thick
 - 48" hardwood handle



- 21200 Seymour hercules digger**
- 6.25" point spread, .112" thick
 - 48" hardwood handle, DG-11



- 21206 Seymour hercules digger**
- 6.25" point spread, .112" thick
 - 72" hardwood handle, DG-116



- 21208 Seymour hercules digger**
- 6.25" point spread, .112" thick
 - 96" hardwood handle, DG-118

THE ATLAS PATTERN...
is best suited for homeowner use and other occasional use applications.



- 21117 Seymour extra heavy-duty atlas digger DG-17FG**
- 6" point spread, .085" thick
 - 48" fiberglass handle, vinyl grip



ALL PRODUCTS ON THIS PAGE ARE MADE IN THE USA (UNLESS NOTED)



- 21110 Seymour atlas digger DG-100FG**
- 6" point spread, .062" thick
 - 48" fiberglass handle, vinyl grip



- 21180 ProValue homeowner digger DG-80FG**
- 5" point spread, .083" thick
 - 48" fiberglass handle, vinyl grip *(not made in the USA)*



- 21109 Seymour extra heavy-duty atlas digger**
- 5" point spread, .085" thick
 - 48" hardwood handle, DG-17



- 21105 Seymour medium-duty atlas digger**
- 5" point spread, .068" thick
 - 48" hardwood handle, DG-10



- 21106 Seymour medium-duty atlas digger**
- 5" point spread, .068" thick
 - 72" hardwood handle, DG-106



- 21108 Seymour medium-duty atlas digger**
- 5" point spread, .068" thick
 - 96" hardwood handle, DG-108



- 21100 Seymour atlas digger**
- 5" point spread, .062" thick
 - 48" hardwood handle, DG-100



- 21025 ProValue junior atlas digger**
- 5" point spread, .083" thick
 - 42" hardwood handle, DG-25

POST HOLE DIGGERS

THE PERFECTION PATTERN...

has a unique "clamshell" head for digging in sandy, loamy, loosely-packed soils.



21245 Seymour perfection digger DG-12FG

- 7.25" point spread, .085" thick
- 48" fiberglass handle, vinyl grip



21244 Seymour perfection digger

- 5" point spread, .085" thick
- 48" hardwood handle, DG-12



21246 Seymour perfection digger

- 5" point spread, .085" thick
- 72" hardwood handle, DG-126



21248 Seymour perfection digger

- 5" point spread, .085" thick
- 96" hardwood handle, DG-128

THE GIBBS PATTERN...

combines a single blade with hinge action that acts like a bucket to bring loose soil to the surface. Also called a mud bucket.



21264 Seymour Gibbs digger

- Single blade with hinge action, .085" thick
- 54" hardwood handle, DG-18



21266 Seymour Gibbs digger

- Single blade with hinge action, .085" thick
- 72" hardwood handle, DG-186



21268 Seymour Gibbs digger

- Single blade with hinge action, .085" thick
- 96" hardwood handle, DG-188



ALL PRODUCTS ON THIS PAGE ARE MADE IN THE USA. (UNLESS NOTED)

THE BUCKEYE PATTERN...

features strong steel pipe handles welded to the square steel shanks and yoke. Super tough square-cut steel blades are ideal for digging in heavy, rocky soils.



21230 Seymour buckeye digger

- 6.5" point spread, .117" thick
- 48" steel handles, DG-16

THE LONESTAR PATTERN...

features strong tubular steel handles welded to the thick yokes for digging in the hardest soils.



21220 Seymour lonestar digger

- 6.25" point spread, .112" thick
- 48" steel handles, DG-15



21075 ProValue homeowner digger

- 5" point spread, .083" thick
- 48" hardwood handle, DG-75



21060 SmartBuy promotional digger

- 5" point spread, .083" thick
- 48" hardwood handle, DG-60

POST HOLE DIGGER REPLACEMENT HANDLES

SP21096 48" replacement handle for DG-100, DG-75

SP21099 72" replacement handle for DG-106, DG-116, DG-126

SP21100 96" replacement handle for DG-108, DG-118, DG-128

SP21095 48" replacement handle for DG-10, DG-11, DG-12

SP21004 48" replacement handle for DG-14

SP21005 72" replacement handle for DG-186

SP21006 96" replacement handle for DG-188

SP21007 54" replacement handle for DG-18

SP21008 Short lever replacement handle for DG-18

FENCING TOOLS

For decades farmers, ranchers and fencing professionals have counted on Seymour for high quality fencing tools. Our all-steel post drivers can install posts in the toughest soil conditions. Handy fencing pliers are often used with our ring fasteners for wire and mesh fencing.



85620 Seymour post driver

- 2.5" square tube, 19 pounds of power
- Heavy-duty, powder coated construction



85623 Seymour post driver

- 3" square tube, 22 pounds of power
- Heavy-duty, powder coated construction



85630 Seymour long reach post driver

- 2.5" square tube, 19 pounds of power
- Heavy-duty, powder coated construction



85633 Seymour long reach post driver

- 3" square tube, 22 pounds of power
- Heavy-duty, powder coated construction

POST DRIVER CONSTRUCTION

- All steel
- Square tubing
- Powder coated
- Heavy-duty

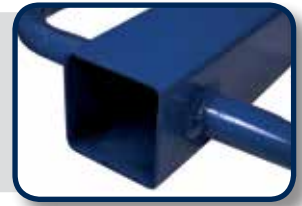

41026 Seymour fence pliers

- 10.5" alloy steel head
- Forged handles with vinyl grips, 2T-1900



41020 Seymour fence pliers

- 10" square nose head
- Forged handles with vinyl grips, 2T-110



41021 Seymour fence pliers

- 10" round nose head
- Forged handles with vinyl grips, 2T-120



AUGERS

Professionals have relied on Seymour augers for generations to bore holes in all soil types. We offer models for post installation, shallow well drilling, tree root feeding, pest control and other applications. Count on these time-proven tools for great results.



ALL PRODUCTS ON THIS PAGE ARE MADE IN THE USA (UNLESS NOTED)

IWAN AUGERS

are designed for general purpose use in a variety of soils. Steel blades are riveted to tough pliable iron yoke. Has a steel shaft with a welded steel t-handle.



- 21302 Seymour 2" Iwan auger**
- 2" point spread, steel head/shaft
 - Hardwood handle, AU-S2

- 21303 Seymour 3" Iwan auger**
- 3" point spread, steel head/shaft
 - Hardwood handle, AU-S3

- 21304 Seymour 4" Iwan auger**
- 4" point spread, steel head/shaft
 - Hardwood handle, AU-S4

- 21306 Seymour 6" Iwan auger**
- 6" point spread, steel head/shaft
 - Hardwood handle, AU-S6

- 21308 Seymour 8" Iwan auger**
- 8" point spread, steel head/shaft
 - Hardwood handle, AU-S8

- 21310 Seymour 10" Iwan auger**
- 10" point spread, steel head/shaft
 - Hardwood handle, AU-S10

- 21312 Seymour 12" Iwan auger**
- 12" point spread, steel head/shaft
 - Hardwood handle, AU-S12

ADJUSTABLE IWAN AUGERS

will bore holes of varying diameters



- 21324 Seymour 4-5-6" diameter adjustable iwan auger**
- Steel head/shaft
 - Hardwood handle, AU-A1

- 21326 Seymour 6-7-8" diameter adjustable iwan auger**
- Steel head/shaft
 - Hardwood handle, AU-A2

TREE FEEDING AUGERS

bore a 2" diameter hole for applying plant food and water to roots.

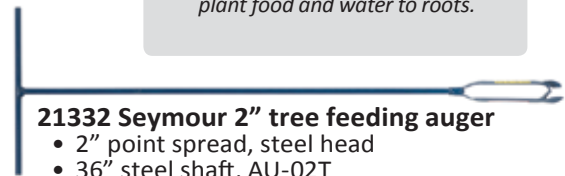

- 21332 Seymour 2" tree feeding auger**
- 2" point spread, steel head
 - 36" steel shaft, AU-O2T

DIGWELL AUGERS

have a telescoping steel handle for a total working length up to 9'. The square steel extension is dimpled at 7" intervals for locking in settings.

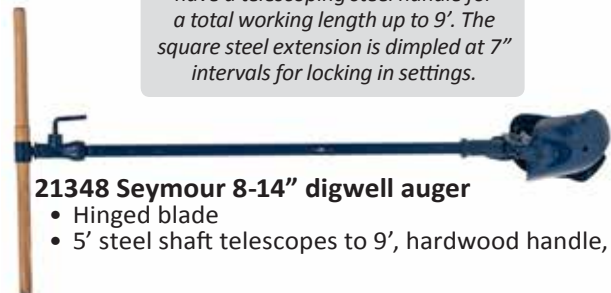

- 21348 Seymour 8-14" digwell auger**
- Hinged blade
 - 5' steel shaft telescopes to 9', hardwood handle, DW-D1

AUGER REPLACEMENT HANDLES & PARTS

- SA22036 Auger Handle, hardwood cross, 21", for all except AU-S12
- SA22035 Auger extensions, 3/4" X 48" with threaded coupling
- SA22076 Auger Handle, hardwood cross, 30", for AU-S12
- SA11028 AU-A1 adjustable auger blade (including rivets)
- SA11029 AU-A2 adjustable auger blade (including rivets)
- SA11020 Iwan auger head, 10"
- SA11021 Iwan auger head, 12"
- SA11022 Iwan auger head, 8"

SNATHS & SCYTHE BLADES

The scythe is a powerful, versatile and useful tool for the mowing and removal of unwanted grasses, weeds, and young woody growth. Quiet and pleasant to use, the scythe provides numerous advantages over mechanical mowers and string trimmers, and can be used in many locations where mechanical mowers cannot.

SEYMOUR®

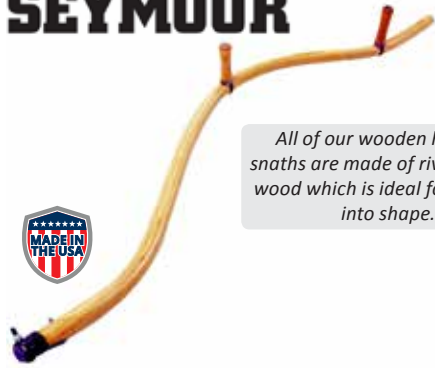

All of our wooden handled snaths are made of river-bottom wood which is ideal for forming into shape.



21401 Seymour snath, wood handle

- Steel web, iron loop bolt, SN-1
- For grass, weeds, and light brush

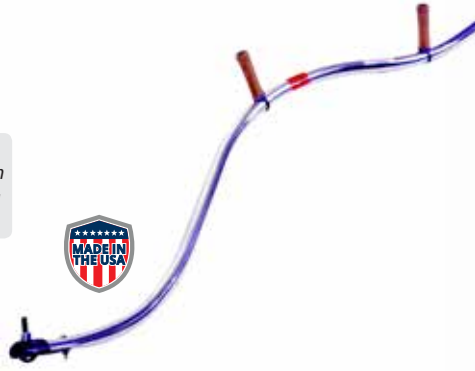

21408 Seymour snath, aluminum handle

- Steel web, iron loop bolt, SN-8
- For light duty cutting

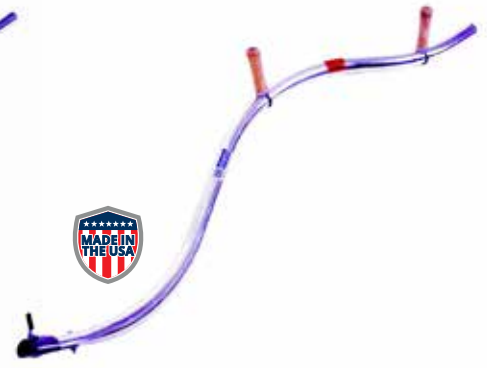

21409 Seymour snath, aluminum handle

- Iron loop bolt, SN-9
- For medium duty cutting

○ = Good ◐ = Better ● = Best ✕ = Do Not Use

Snath style	Light, thin grasses	Lush vegetation	Reedy grasses & thatch	Woody-stemmed plants & weeds	Green young saplings or bushes
No. 1 (wood)	◐	◐	●	●	●
No. 8 (aluminum)	●	●	○	✕	✕
No. 9 (aluminum)	◐	●	◐	○	✕



21428 Grass scythe
• 28" steel blade
• 2B-42G28



21424 Weed scythe
• 24" steel blade
• 2B-42W24



21420 Bush scythe
• 20" steel blade
• 2B-42B20



21438 Scythe blade
• 28" steel blade, lightweight
• 2B-040128



21450 Nib for snath, SP-16UB
• Lower and upper nib for 21401 & 21409
• Reverse threaded hex nut

21430 Grass scythe
• 30" blade
• 2B-42G30

21426 Weed scythe
• 26" blade
• 2B-42W26

21440 Scythe blade
• 30" steel blade, lightweight
• 2B-040130

21451 Nib for snath, SP-16LB
• Lower bush nib for 21401
• Reverse threaded hex nut

21452 Nib for snath, SP-16UG
• Upper grass nib for 21401 & both nibs for 21408
• Reverse threaded hex nut

○ = Good ◐ = Better ● = Best ✕ = Do Not Use

Scythe style	Light, thin grasses	Lush vegetation	Reedy grasses & thatch	Woody-stemmed plants & weeds	Green young saplings or bushes
Grass Blade	●	●	◐	◐	○
Weed Blade	◐	◐	●	●	◐
Bush Blade	○	○	◐	◐	●
Hybrid Blade	●	◐	○	○	✕

Usage charts courtesy Benjamin Bouchard

WEED & BRUSH CUTTING

Cutting dense brush and weeds is easy with our time-proven grass hooks, weed cutters and ditch bank blades. These rugged tools are based on decades-old designs that continue to be reliable favorites for their reliability and functionality.



87640 Seymour ditch bank blade



- Steel blade, 3-bolt head with formed steel brackets
- 40" hardwood handle, DT-1640



Detail of serrated edges

87600 Seymour weed cutter



- Serrated edges with formed steel brackets
- 30" hardwood handle WE-20
- Replacement handle - 65163 / 7248-00



87605 Seymour grass whip

- Serrated blade riveted to steel shaft
- 12" hardwood handle, WE-30



Edges can be sharpened

87610 Seymour brush cutter



- Heavy duty steel blade
- 30" hardwood handle, WE-40



87625 Seymour dandelion/lawn weeder

- Steel tip, WE-35
- Reaches deep to remove the whole root
- 36" hardwood handle



41700 Seymour grass hook, general purpose

- Non-offset serrated edge blade
- Hardwood handle, 2G-497



41705 Seymour grass hook, general purpose

- Offset plain edge blade
- Hardwood handle, 2G-507



41710 Seymour grass hook, American pattern

- Plain edge blade, steel ferrule
- Hardwood handle, 2G-25



41711 Seymour grass hook, long handle, American pattern

- Plain edge blade, steel ferrule
- 53" hardwood handle, 2G-25LH



49081 Seymour hay hook

- Steel hook with wood handle
- 11" overall length

MACHETES AND KNIVES

Whether you are trimming, harvesting or clearing brush, Seymour Midwest has a high-quality knife or machete that is ready for the task. Each of our tough and durable products are fully resharpenable for use season after season.



41418 Kenyon 4" sickle / sod cutter

- 4" steel blade
- 6" polymer handle



41420 Kenyon 6.5" sickle

- 6.5" steel blade
- 8" wood handle



41044 Seymour sod cutter / harvesting knife

- 3" steel blade
- 5" polymer handle



41046 Seymour row crop harvesting knife

- 6" steel blade
- 5" polymer handle



41045 Seymour landscaper's pocket knife

- 2.5" closeable steel blade
- 4.5" polymer handle



41730 Seymour cane knife

- 13" steel blade
- Hardwood handle, 2P-CN13



41745 Seymour 15" corn knife

- Tapered steel blade
- Hardwood handle, 2C-66



41740 Seymour 18" corn knife

- Flexible steel blade
- Hardwood handle, 2C-33



41748 Seymour 18" corn knife

- Tapered steel blade
- Hardwood handle, 2C-99



41712 Seymour 12" machete

- Cutlery steel blade
- Black poly handle with brass rivets, 2P-MA12



41718 Seymour 18" machete

- Cutlery steel blade
- Black poly handle with brass rivets, 2P-MA18



41719 Seymour 18" sheath for machete

- Canvas sheath with belt loop, 2P-MA18S



41722 Seymour 22" machete

- Cutlery steel blade
- Black poly handle with brass rivets, 2P-MA22



41723 Seymour 22" sheath for machete

- Canvas sheath with belt loop, 2P-MA22S



41724 Seymour 24" machete

- Cutlery steel blade
- Black poly handle with brass rivets, 2P-MA24



41725 Seymour 24" sheath for machete

- Canvas sheath with belt loop, 2P-MA24S

SAWS - PRUNING TOOLS

Kenyon pruning saws are professional-grade tools that are designed to cut more easily. Choose folding models for small to medium branches and convenient in-field portability. Curved blades make cutting easier. Larger bow saws have increased capacity for larger branches and sharp, self-cleaning teeth.

KENYON

**PROFESSIONAL TOOLS
CUT FASTER & EASIER!**

Kenyon brand cutting tools are small, powerful and functional tools that will give you an "edge".



41429 Kenyon pruning saw

- 13" tempered alloy curved blade
- 6 precision ground teeth per inch
- Poly handle



41428 Kenyon folding saw

- 10" tempered alloy curved blade
- 6 precision ground teeth per inch
- Wood handle



41426 Kenyon folding pruning saw

- 8" steel blade
- Comfort poly grip with safety lock, WP-8708



41453 Kenyon 21" bow saw

- Replaceable steel blade (SP16047) with guard
- Tubular steel handle, WP-7621



41454 Kenyon 24" bow saw

- Replaceable steel blade (SP16048) with guard
- Tubular steel handle, WP-7624



41455 Kenyon 30" bow saw

- Replaceable steel blade (SP16049) with guard
- Tubular steel handle, WP-7630

PRUNING TOOLS - HAND PRUNERS

Classic design and dependability characterize each of our hand pruning tools. We offer the best in price and performance with tools that provide clean, consistent cuts, without binding or tearing. For contractor-friendly performance, upgrade to models with forged blades for added durability.



41407 Kenyon 1" forged professional bypass pruner

- Resharpenable blades, sap groove and wire-cutting notch
- 8.5" overall length with ergonomic handles
- Replaceable blade (SP13312) and spring (SP13311)



41406 Kenyon .75" forged professional bypass pruner

- Resharpenable blades, sap groove and wire-cutting notch
- 8" overall length with ergonomic handles
- Replaceable spring (SP13310)



41401 Kenyon .75" bypass pruner

- Hardened and coated non-gumming blades
- Ergonomically designed vinyl handles
- Metal latch for safe storage



41403 Kenyon 1" bypass pruner

- Hardened and coated non-gumming blades
- Ergonomically designed vinyl handles
- Metal latch for safe storage



41419 Kenyon forged professional thinning shear

- Resharpenable alloy blades
- 8.25" overall length with cushioned non-slip grips
- Replaceable spring (SP13313)



41405 Kenyon .75" anvil pruner

- Hardened and coated non-gumming blades
- Ergonomically designed vinyl handles
- Metal latch for safe storage



41054 Kenyon nylon scabbard with belt clip

- Fits hand pruners and folding saws
- Keeps tools handy in the field



41055 Kenyon leather scabbard with belt slots

- Top-grain leather



41473 ProValue .5" consumer bypass pruner

- Comfort molded handles
- Quick release, WP-1010



41474 ProValue .625" consumer bypass pruner

- Single action, enclosed spring
- Textured vinyl grips, WP-1030



41476 ProValue .625" consumer anvil pruner

- Single action, enclosed spring
- Textured vinyl grips, WP-1020

HEDGE SHEARS - PRUNING TOOLS

For trimming and shaping of large and dense shrubs and hedges, we offer a diverse selection of hedge shears for contractor and consumer use. Of special note are the models which incorporate innovative telescoping handles for instant added reach. All models feature resharpenable blades.



41471 Structron forged hedge shears with extension handles EXS24

- 9" steel blades
- Fiberglass handles with cushion grip
- Handles extend from 24" to 36" for added reach



41492 ProValue hedge shears

- 9" steel blades with serrated edge for compound action
- 10" hardwood handles with cushion grips, WP-3230



41424 Kenyon forged hedge shears

- 9" steel blades with shock absorbing stop
- 12" aluminum handles with poly grips



41423 Kenyon forged hedge shears

- 9" steel blades with shock absorbing stop
- 11" hardwood handles with poly grips



41421 Kenyon hedge shears

- 8" steel blades with branch pruning notch for larger limbs
- 10" hardwood handles, WP-3220



41422 Kenyon hedge shears

- 8" steel blades with branch pruning notch for larger limbs
- 9" steel handles with vinyl grips, WP-3210



PRUNING TOOLS - LOPPERS

For cutting larger limbs and vines, select from our wide offering of landscape loppers. Choose from models with traditional hardwood handles, fatigue-reducing aluminum, fiberglass, or high-strength tubular steel. Models with easy-reach extension handles are offered. Get extra cutting power (up to 3 times more) with compound-action models.



- 41467 Structron telescoping bypass lopper EXB36**
- Single action steel blades
 - 24"-33" fiberglass extension handles with cushion grips



- 41465 Structron bypass lopper BL24**
- Single action steel blades
 - 24" fiberglass handles with cushion grips

EXTENSION HANDLES...

feature a dual lock and STA-LOK® positive locking system (SA32002) that increases the reach of Structron loppers and hedge shears.



"These loppers are absolutely the best in the field."
- Patti Merick, Lawnranger Landscape



- 41463 Structron telescoping anvil lopper EXA36**
- Compound action steel blades (SP16013 + SP16012)
 - 24"-33" fiberglass extension handles with cushion grips



- 41461 Structron anvil lopper CL24**
- Compound action steel blades (SP16013 + SP16012)
 - 24" fiberglass handles with cushion grips

COMPOUND ACTION LEVER DESIGN

on pruning tools multiplies handle force to cutting blades for easier cutting.



- 41414 Kenyon 1.25" forged bypass lopper**
- Resharpenable blades with sap groove
 - Shock absorbing stop
 - Tubular steel handles with poly grips, 19" overall length



- 41415 Kenyon 2.25" forged bypass lopper**
- Resharpenable blades with sap groove
 - Shock absorbing stop
 - Aluminum handles with poly grips, 28" overall length



- 41411 Kenyon 1.25" bypass lopper**
- Hardened and coated, non-gumming blades
 - Shock absorbing stop, 29" overall length
 - Oval-shaped steel handles with cushioned grips



- 41416 Kenyon 1.5" telescoping bypass lopper**
- Hardened and coated, non-gumming blades
 - Shock absorbing stop, 29" overall length
 - 26"-39" aluminum handles with poly grips



- 41417 Kenyon 1.5" bypass lopper**
- Hardened and coated, non-gumming blades
 - Shock absorbing stop, 28" overall length
 - Wood handles with poly grip



- 41413 Kenyon 1.5" anvil lopper**
- Hardened and coated, non-gumming blades
 - Shock absorbing stop, 29" overall length
 - Oval-shaped steel handles with cushioned grips

LOPPERS - PRUNING TOOLS



41488 ProValue 2" bypass lopper

- Compound action steel blades
- Shock absorbing stop
- 20" hardwood handles with cushion grips, WP-2140



41484 ProValue 1.25" bypass lopper

- Single action steel blades
- Shock absorbing stop
- 20" hardwood handles with cushion grips, WP-2130



41486 ProValue 1.25" bypass lopper

- Single action steel blades
- Shock absorbing stop
- 30" hardwood handles, WP-2136



41487 ProValue 1.25" bypass lopper

- Single action steel blades
- Shock absorbing stop
- 30" hardwood handles with cushion grips, WP-2137



41481 ProValue 1.25" bypass lopper

- Single action steel blades
- Shock absorbing stop
- 19" tubular steel handles with vinyl grips, WP-2120



41489 ProValue 2" anvil lopper

- Compound action steel blades
- 20" hardwood handles with cushion grips, WP-2145



41485 ProValue 1.5" anvil lopper

- Single action steel blades
- 20" hardwood handles with cushion grips, WP-2135



41483 ProValue 1.5" anvil lopper

- Single action steel blades
- 19" tubular steel handles with vinyl grips, WP-2110



Bypass loppers are recommended for pruning green wood while anvil loppers are for pruning dead or dying wood.

ProValue

PRUNING TOOLS - TREE PRUNERS AND FRUIT PICKER

Our rugged tree pruners use telescoping fiberglass or aluminum handles for extended reach and lightweight operation. The exclusive patented STÄ-LOK on the Structron TP612 locks the handle in place to the exact length needed. Choose a model with compound action for extra cutting power.



41398 Structron tree pruner TP612

- 1.125" cutting capacity compound action lopper with 15" saw blade
- 15" replacement saw blade (SP16097)
- 6'-12' fiberglass extension handle, lightweight for easy reaching
- Non-slip foam grip

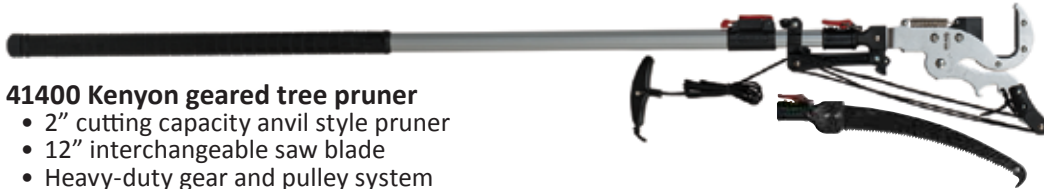

41400 Kenyon geared tree pruner

- 2" cutting capacity anvil style pruner
- 12" interchangeable saw blade
- Heavy-duty gear and pulley system
- 4.5'-8' oval shaped aluminum telescoping handle with superior telescoping locking mechanism



41395 Kenyon tree pruner WP-6555

- 1.125" cutting capacity compound action lopper with 13" blade
- Replacement saw blade (SP13441) and replacement rope (SP50323)
- 7'-14' fiberglass extension handle with superior telescoping locking mechanism



41498 ProValue tree pruner WP-6525

- 1" cutting capacity compound action lopper with 13" blade
- Replacement saw blade (SP13441) and replacement rope (SP50323)
- 6'-12' fiberglass extension handle



41499 ProValue tree pruner WP-6535

- 1.125" cutting capacity compound action lopper with 13" blade
- Replacement saw blade (SP13441) and replacement rope (SP50323)
- 6'-12' fiberglass extension handle



42280 Seymour fruit picker FP-20

- Heavy gauge vinyl coated wire basket, grab and pull action
- 8' - 2 piece wood handle

FIBERGLASS - EXTENSION HANDLES

Prized by painting contractors, cleaning professionals and other users who look for extended reach with maximum adjustability, our extension handles have been top-sellers for decades. Our patented STĀ-LOCK mechanism is the most convenient and reliable to use. Just twist to lock in any position.



ALL PRODUCTS ON THIS PAGE
ARE MADE IN THE USA (UNLESS NOTED)



Structron Superhandle® II Ultra extension handle with milled aluminum tip

- Machined aluminum tip
- Fiberglass telescoping handle with cushion grip
- Ultra Threaded Tip Replacement Kit (60279)

60270 - 1' to 2' handle w/STĀ-LOK & end cap

60271 - 2' to 4' handle w/dual lock

60276 - 3' to 6' handle w/dual lock

60272 - 4' to 8' handle w/dual lock

60273 - 6' to 12' handle w/dual lock

60274 - 8' to 16' handle w/dual lock

60275 - 8' to 24' handle w/dual lock



UPGRADE TO ULTRA

Our new "Ultra" version includes a virtually indestructible threaded tip milled from solid aluminum bar stock. Use it for heavier-weight ends or when the tool end will be subject to high leverage forces.

SUPERHANDLE II ULTRA



Structron Superhandle® II extension handle

- Threaded #5 Acme aluminum tip
- Fiberglass telescoping handle with cushion grip
- Threaded Tip Replacement kit (60259)

60250 - 1' to 2' handle w/STĀ-LOK & end cap SE12

60251 - 2' to 4' handle w/dual lock SE24

60256 - 3' to 6' handle w/dual lock SE36

60252 - 4' to 8' handle w/dual lock SE48

60253 - 6' to 12' handle w/dual lock SE612

60254 - 8' to 16' handle w/dual lock SE816

60255 - 8' to 24' handle w/dual lock SE824

SUPERHANDLE® II DUAL LOCKING SYSTEM

The world's first extension handle with two locking systems to ensure the most secure handle lock available today. Built to industrial quality standards for outstanding performance and durability.

EXTERNAL LOCK

Screw down threaded collar to secure handle in any position. Comfortable ergonomic design.

INTERNAL LOCK

Twist inner pole with patented STĀ-LOCK® positive locking system until it snaps into locking position to quickly secure handle at any length

U.S. Patent 5,549,407.

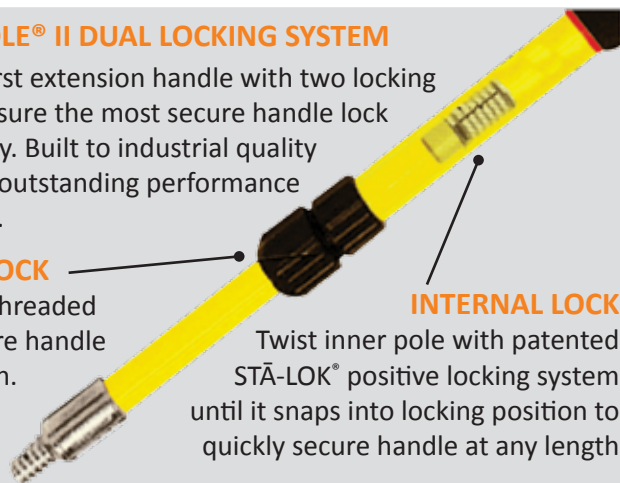

SA22028 - Replacement part for collar lock poles



Structron Superhandle® extension handle

- Threaded #5 Acme aluminum tip
- Fiberglass telescoping handle with collar lock, cushion grip
- Threaded Tip Replacement kit (60259)

60245 - 2' to 4' handle CE24

60244 - 3' to 6' handle CE36

60246 - 4' to 8' handle CE48

60247 - 6' to 12' handle CE612

60248 - 8' to 16' handle CE816



Structron straight extension handle

- Threaded #5 Acme aluminum tip
- Fiberglass handle with vinyl end cap
- Threaded Tip Replacement kit (60259)

60240 - 48" handle SS48

60241 - 60" handle SS60

60242 - 72" handle SS72

PLANTING TOOLS

Our rugged all-steel planting mattocks and cultivators easily cut into hard soils allowing for fast setting of groundcovers and bedding plants. Fine gardeners love our digging/weeding knife which provides precision, ease of cutting and ability to work in tough soils.



41202 Kenyon all steel ultimate planting mattock

- Pro-grade heavy-duty construction with 3/16" steel head
- Wide edge is 2", narrow edge is 1.25" for all plant sizes
- 14" overall length, anti-slip vinyl grip



41212 Kenyon all steel bedding mattock

- Pro-grade heavy-duty construction with 14 gauge head
- 3" wide, shovel-style head
- 14" overall length, anti-slip vinyl grip



41222 Kenyon all steel bedding cultivator and mattock

- Pro-grade heavy-duty construction with 14 gauge head
- 3" wide cultivator fork, 1.25" planting head
- 14" overall length, anti-slip vinyl grip

41040 Seymour landscaper digging / weeding knife

- 6.5" blade with tapered slicing edge
- 4.5" polymer handle with comfortable grip and thumb rest
- For digging, planting, weeding, cutting roots and more



41041 Seymour sheath for digging / weeding knife

41042 Seymour landscaper digging/weeding knife with sheath

Seymour Midwest developed these short-handled tools to better meet the needs of home gardeners who prefer more compact tools. They're durable and feel great in your hands.



41033 Seymour hand trowel

- Chrome plated 3.5" x 6" head
- Wood handle, WP-5400
- Hole in handle to hang up when not in use



41034 Seymour hand transplanter

- Chrome plated 2.5" x 6" head
- Wood handle, WP-5401
- Hole in handle to hang up when not in use



41035 Seymour dandelion weeder

- Chrome plated .75" x 2.5" head
- Wood handle, WP-5402
- Hole in handle to hang up when not in use



41031 Seymour hand cultivator

- Chrome plated 3" x 5" head
- Wood handle, WP-5403
- Hole in handle to hang up when not in use

GARDEN TOOLS

Our long-handled garden tools are the perfect fit for garden beds, smaller spaces and smaller hands. They are smaller and easier-to-use but are constructed of the same materials as our larger tools. Their versatility extends to floral or edible gardens, square-foot gardening, raised beds and use by children.



60700 Seymour floral shovel, round point

- Tempered high-carbon steel floral head
- Front-turned step
- 44" hardwood handle, SV-LR70



60701 Seymour floral shovel, round point with d-grip

- Tempered high-carbon steel floral head
- Front-turned step
- 30" hardwood handle with poly d-grip, SV-DR72



60703 Seymour floral shovel, square point with d-grip

- Tempered high-carbon steel floral head
- Front-turned step
- 30" hardwood handle with poly d-grip, SV-DS73



60710 Seymour v-hoe

- Forged 4" head
- 54" hardwood handle, VH-70



60711 Seymour garden cultivator

- Forged 3 tine head
- 54" hardwood handle, GC-70



60712 Seymour level head rake

- Forged 8 tine head
- 54" hardwood handle, FR-70

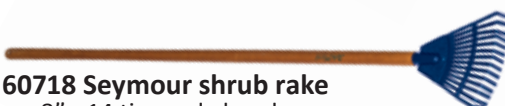

60718 Seymour shrub rake

- 8" - 14 tine poly head
- 50" hardwood handle, LF-70



60720 Seymour soil knife

- Forged 2" head
- 15" hardwood handle with leather thong, SK-70H



60727 Seymour weeding hoe

- Forged 2.5" head
- 15" hardwood handle with leather thong, WH-70H



60721 Seymour garden cultivator

- Forged 3 tine head
- 15" hardwood handle with leather thong, GC-70H



60725 Seymour dandelion weeder

- Forged 1" head
- 15" hardwood handle with leather thong, WE-70H



60723 Seymour nursery trowel

- Forged 3.75" head
- 15" hardwood handle with leather thong, NT-70H



41038 Seymour bulb planter

- 3" heavy-duty head with beveled edge blade and foot step
- 30" steel loop handle, BP-20

SQUEEGEES - GENERAL

Our general purpose squeegees are ideal for pushing or pulling liquids off from hard surfaces. Each is sold as a complete tool – handle, frame and blade. Our straight-edge squeegee has a stiffer blade for a more robust scraping action. Replacement blades are always available for all of these items.



**ALL PRODUCTS ON THIS PAGE
ARE MADE IN THE USA (UNLESS NOTED)**

Structron general purpose squeegee

- 3" extra-wide reversible neoprene rubber blade
- Heavy-duty aluminum head with wrap-around bracing
- 66" fiberglass handle, cushion grip

76502 - 24" squeegee
76503 - 36" squeegee



EASILY REPLACEABLE BLADES

The "clamp-style" frame has wing nuts to make blade installation and replacement convenient.

Seymour snow squeegee

- 3" deep reversible and replaceable rubber blade
- Clamp-style frame for ease of use
- 66" powder-coated aluminum handle, vinyl grip

96624 - 24" squeegee
96636 - 36" squeegee



A SQUEEGEE... FOR SNOW?

Great for the removal of fresh snow and slush on walks, driveways and entry floors. Doesn't hang up on uneven surfaces.

Seymour general purpose squeegee

- Replaceable neoprene rubber blade
- Black powder-coated steel scraper head
- 60" fiberglass handle, cushion grip

76602 - 24" squeegee IC24
76603 - 36" squeegee IC36



Midwest Rake medium-duty squeegee head, curved frame design

- Durable neoprene rubber blade
- Cast aluminum "T"-style handle adapter
- Replaceable blades available
- Uses a tapered wood handle (see page 116)

47210 - 18" squeegee **SP50125 - Replacement blade**
47211 - 24" squeegee **SP50126 - Replacement blade**
47212 - 30" squeegee **SP50127 - Replacement blade**
47213 - 36" squeegee **SP50128 - Replacement blade**

Midwest Rake straight blade squeegee

- 36" double-edge neoprene blade with wrap-around bracing
- 66" powder-coated aluminum handle
- Replaceable blade (SP50076)

75036 - Squeegee with yellow handle
75936 - Squeegee with blue handle



Midwest Rake medium-duty squeegee head, straight frame design

- Durable neoprene rubber blade
- Cast aluminum "T"-style handle adapter
- Replaceable blades available
- Uses a tapered wood handle (see page 116)

47100 - 18" squeegee **SP50125 - Replacement blade**
47101 - 24" squeegee **SP50126 - Replacement blade**
47102 - 30" squeegee **SP50127 - Replacement blade**
47103 - 36" squeegee **SP50128 - Replacement blade**



STRAIGHT BLADE SQUEEGEE

is excellent for removing heavier liquids such as mud and for moving fine aggregate. The neoprene blade is stiffer, so it scrapes as well as squeegees.

ROLLER - SQUEEGEES

Widely used on sports fields, tennis courts and golf courses, our roller squeegees lead the industry in features and performance. Choose from a variety of head widths which are paired with our ergonomic handle design for maximum efficiency. Two roller types are offered for turf and pavement.

70924 Midwest Rake 24" non-absorbent roller squeegee

- Great for turf applications
- 60" ergonomic powder-coated blue aluminum handle
- Replacement rollers (SA10047)



ERGONOMIC HANDLE DESIGN

Our bent "ergonomic" powder-coated aluminum handles allow for effective downward and forward pressure which provides increased head-to-surface contact. It's also more comfortable to use.

70936 Midwest Rake 36" non-absorbent roller squeegee

- Great for turf applications
- 60" ergonomic powder-coated blue aluminum handle
- Replacement rollers (SA10048)



STAINLESS STEEL AXLES

Just roll water off floors, pavement, tennis courts, golf greens and sports fields with a roller squeegee. The heavy-duty aluminum frame construction and stainless steel axles ensure the roller stays secure.

70948 Midwest Rake 48" non-absorbent roller squeegee

- Great for turf applications
- 60" ergonomic powder-coated blue aluminum handle
- Replacement rollers (SA10049)



POWDER-COATED HANDLES MAKE A DIFFERENCE

A high quality poly-blend powder-coating formula is bonded to our durable aluminum handles, providing a superior grip when the tool is wet, blister reduction, and greater durability.

72036 Midwest Rake 36" PVA absorbent roller squeegee

- Great for hard surfaces like concrete and asphalt
- 60" ergonomic powder-coated blue aluminum handle
- Replacement rollers (SA10051)



PVA ABSORBENT ROLLERS

are great for hard surfaces like concrete and asphalt

SQUEEGEES - APPLICATION

Applying seal coatings to asphalt, sports courts and other hard surfaces is best accomplished with one of our renowned Midwest Rake seal coating squeegees. Choose from a variety of blade styles and dimensions. Our pull-action squeegees apply evenly, preventing wasted material.



ALL PRODUCTS ON THIS PAGE ARE MADE IN THE USA (UNLESS NOTED)

46001 Midwest Rake heavy-duty u-crack filler squeegee

- 5/16" x 2.25" neoprene rubber blade with steel frame
- 9.5" deep by 3" U-shaped cavity
- Replaceable blade (SP50120)
- Uses a tapered wood handle (see page 116)



46002 Midwest Rake lightweight u-crack filler squeegee

- 1.25" tall neoprene rubber blade
- 2.5" inside cavity
- Replaceable blade (SP50121)
- Uses a tapered wood handle (see page 116)

46005 Midwest Rake push/pull v-crack filler squeegee

- .25" x 2" neoprene rubber blade
- 70 degree, 2" tall v-shaped cavity
- Replaceable blade (SP50122)
- Uses a tapered wood handle (see page 116)

SEAL COATING APPLICATION SQUEEGEES

Our clamp-style seal coating frame is equipped with wing nuts and loc washers to prevent loosening and to make blade installation and replacement very convenient. The squeegees below are sold as "complete" tools: frame, blade, bracing and handle.



Round Edge
Non-Tapered



Round Edge
Tapered *



Square Edge

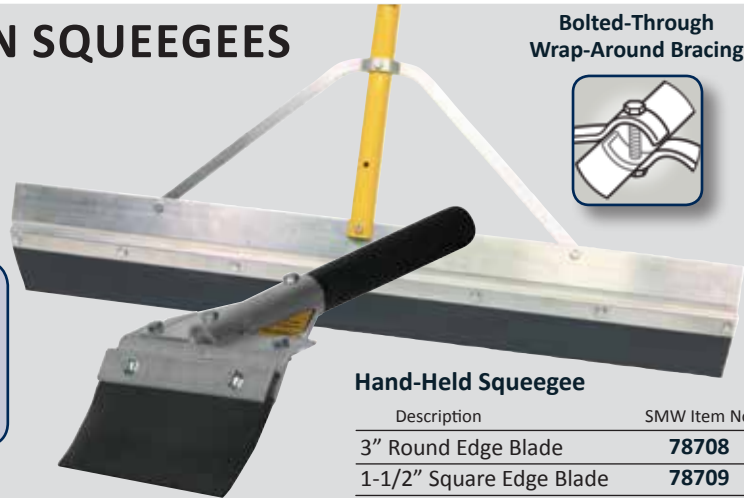

Bolted-Through
Wrap-Around Bracing



Hand-Held Squeegee

Description	SMW Item No.
3" Round Edge Blade	78708
1-1/2" Square Edge Blade	78709

Description	Handle Length in.	24"	36"	48"	60"	72"
A. 3" Round Edge Non-Tapered Seal Coat Squeegee <i>Complete Tool</i>	66	76062	76063	76064	76065	-
	66 OS*	76092	76093	76094	76095	-
	82	76072	76073	76074	76075	-
	82 OS*	76082	76083	76084	76085	-
	Blade Only	SP50071	SP50072	SP50073	SP50074	-
B. 3" Round Edge Tapered Seal Coat Squeegee <i>Complete Tool</i> * Favored when coating Sports Surfaces	66	76124	76136	76148	76160	-
	66 OS*	76162	76163	76164	76165	76166
	82	76172	76173	76174	76175	-
	82 OS*	76182	76183	76184	76185	76186
	Blade Only	SP50054	SP50055	SP50056	SP50057	SP50058
C. 3" Square Edge Seal Coat Squeegee <i>Complete Tool</i>	66	76024	76036	76048	76060	-
	66 OS*	76324	76336	76348	76360	-
	82	76224	76236	76248	76260	-
	82 OS*	76424	76436	76448	76460	76472
	Blade Only	SP50034	SP50035	SP50036	SP50037	SP50038

*OS - 1-3/8" Oversized Diameter (Standard diameter is 1-1/8")

Move and smooth material quickly and efficiently with exactly the right lute for the task. We can customize the tool you need. Start by choosing from 5 different head styles in 4 different widths. Then choose your preferred handle diameter, bracing and length. The chart shows dozens of high performing options.

Structron light lute/rake

- Aluminum head with Goliath bracing
- 82" fiberglass 1.25" handle with cushion grip

56824 - 24" head **56830 - 30" head**
56836 - 36" head **56842 - 42" head**

Structron standard lute/rake

- Aluminum head with Goliath bracing
- 82" fiberglass 1.25" handle with cushion grip

50824 - 24" head **50830 - 30" head**
50836 - 36" head **50842 - 42" head**

Kenyon super lute

- Oversized 1-3/8" handle diameter
- Extra Long 82" powder-coated aluminum handles
- Brown box single shippers

56730 - 30" head, bulk 6 pack
56735 - 36" head, bulk 6 pack
56742 - 42" head, bulk 6 pack
56630 - 30" head, brown box single shipper
56635 - 36" head, brown box single shipper
56642 - 42" head, brown box single shipper



ALL PRODUCTS ON THIS PAGE ARE MADE IN THE USA (UNLESS NOTED)

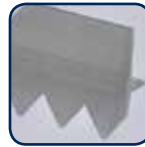

Light



Standard

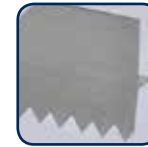

Scarifier



Straight Standard

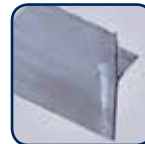

Straight Light



Gusset Bracing



Wrap-Around Bracing



GOLIATH Bracing

GOLIATH BRACING IS THE BEST!

Dual and convertible gusset and wrap-around bracing system with bolted-through "bracing to handle" and "handle to head" connection points

Head Style	Handle Diameter in.	Handle Length in.	Brace Style	Head Width 24"	Head Width 30"	Head Width 36"	Head Width 42"	
Light Lute	1-1/8	66	Goliath	56001	56002	56138	56003	
			Wrap-Around	56024	56030	56036	56042	
		82	Gusset	56025	56031	56037	56043	
	Goliath		56004	56130	56137	56005		
	Wrap-Around		56224	56230	56236	56242		
	Gusset		56225	56231	56237	56243		
	Oversized 1-3/8		82	Goliath	56006	56131	56437	56007
				Wrap-Around	56324	56330	56336	56342
			106	Gusset	56325	56331	56337	56343
	Goliath	56008		56009	56335	56010		
Straight Light Lute	1-1/8	66	Goliath	56011	56012	56141	56013	
			Wrap-Around	56027	56033	56039	56045	
		82	Gusset	56026	56032	56038	56044	
	Goliath		56014	56133	56140	56015		
	Oversized 1-3/8	82	Wrap-Around	56227	56233	56239	56245	
			Gusset	56226	56232	56238	56244	
		106	Wrap-Around	56327	56333	56339	56345	
			Gusset	56326	56332	56338	56344	
			Goliath	50024	50030	50036	50042	
	Standard Lute	1-1/8	82	Gusset	50025	50031	50037	50043
Goliath				-	-	50136	-	
Oversized 1-3/8			82	Wrap-Around	50224	50230	50236	50242
		Gusset		50225	50231	50237	50243	
		106	Wrap-Around	50324	50330	50336	50342	
			Gusset	50325	50331	50337	50343	
			Straight Standard Lute	1-1/8	82	Wrap-Around	50026	50033
Scarifier Lute		1-1/8	66	Wrap-Around	52024	52030	52036	-
	82		Wrap-Around	-	-	52037	-	
	Oversized 1-3/8	82	Wrap-Around	-	52032	52038	52044	

CONCRETE TOOLS

Our concrete placers are durable but also lightweight to minimize operator fatigue. Choose from aluminum, hardwood or fiberglass handles. The heads can set at varying angles to match the application and are replaceable to renew the tool for additional use.

- 73310 Structron steel concrete placer with hook CC20**
- Steel 20" x 4" head
 - 60" fiberglass 1.25" handle with cushion grip



- 73020 Structron aluminum concrete placer CC20A**
- Aluminum 20" x 4" head without hooks
 - Head-to-handle connection with varying angles
 - 60" fiberglass 1.25" handle



SA60058 - Universal replacement hooks (pair) for *aluminum* placers
 73000 - Replacement head kit w/o hooks for *aluminum* placers
 73001 - Replacement head kit w hooks for *aluminum* placers

- 73021 Midwest Rake aluminum concrete placer**
- Aluminum 20" x 4" head with hooks
 - Head-to-handle connection with varying angles
 - 60" fiberglass 1.25" handle



- Midwest Rake aluminum concrete placer**
- Aluminum 20" x 4" head
 - Head-to-handle connection with varying angles
 - 60" powder-coated aluminum handle



73121 - Tool with hooks
73122 - Tool without hooks

- 73120 Midwest Rake aluminum concrete placer**
- Aluminum 20" x 4" head
 - Head-to-handle connection with varying angles
 - 66" powder-coated aluminum handle



- 73123 Midwest Rake aluminum concrete placer**
- Aluminum 20" x 4" head
 - Head-to-handle connection with varying angles
 - 82" powder-coated aluminum handle



- Midwest Rake aluminum concrete placer**
- Aluminum 20" x 4" head
 - Head-to-handle connection with varying angles
 - 60" oversized (1.375") powder-coated aluminum handle



73131 - Tool with hooks
73132 - Tool without hooks

- Midwest Rake aluminum concrete placer**
- Aluminum 20" x 4" head
 - Head-to-handle connection with varying angles
 - 60" painted hardwood handle



73141 - Tool with hooks
73140 - Tool without hooks

- 73300 Midwest Rake steel concrete placer with hook**
- Steel 20" x 4" head
 - 60" hardwood handle, CM-30



- 42437 Structron mortar hoe MH10**
- 10" forged steel head riveted with nylon connector
 - 66" fiberglass handle with cushion grip



- 42430 Midwest Rake mortar hoe**
- 10" steel head with steel plug and rivet connection
 - 66" powder-coated aluminum handle



- 42434 Midwest Rake mortar hoe**
- 10" steel head
 - 66" hardwood handle, MH-30



- 42432 Midwest Rake mortar hoe**
- 7" steel head
 - 54" hardwood handle, MH-20



CONCRETE TROWELS



ROUNDED END TROWELS

- 4" x 16" - 47465
- 4" x 18" - 47466
- 3" x 12" - 47475
- 3" x 16" - 47477



NOTCHED TROWELS

11" x 4-1/2" overall

- 3/16" V-Notch - 47406
- 1/4" V-Notch - 47403
- 1/2" V-Notch - 47402



MORE FLEXIBLE "SPRING FORM" TROWEL

Shorter rib, more flexibility

- Square Edge 5" x 16" - 47470
- Rounded Edge 5" x 16" - 47468



EPOXY MORTAR TROWELS

- 3" x 12" - 47460
- 3" x 16" - 47461



FINISHING TROWELS

- 4" x 12" - 47404
- 4" x 16" - 47405

ASPHALT & SEAL COATING

Midwest Rake offers an industry-leading assortment of asphalt seal coating tools for paving contractors, asphalt maintenance experts and municipal maintenance departments. We are a single source for the professional tools seal-coating experts prefer.

63128 Structron forged steel asphalt rake

- 14 tine 15.5" head
- 60" hardwood handle, AR-30



47245 Midwest Rake 24" blacktop sealing brush

- Head only
- Threaded socket



47246 Midwest Rake 36" blacktop sealing brush

- Head only
- Threaded socket



47002 Midwest Rake 7" edging brush

- Head only
- Threaded socket



46102 Midwest Rake asphalt shoes

- Heavy riveted felt-soled shoes (pair)
- Contractor choice for comfort and protection



Midwest Rake seal coat II squeegee with black rubber blade

- Aluminum handle with black vinyl grip



76801 24" blade with 66" handle

76802 30" blade with 66" handle

76803 36" blade with 66" handle

76804 48" blade with 66" handle

76805 60" blade with 66" handle

76806 72" blade with 66" handle

76811 24" blade with 82" handle

76812 30" blade with 82" handle

76813 36" blade with 82" handle

76814 48" blade with 82" handle

76815 60" blade with 82" handle

76816 72" blade with 82" handle

Seal coat II black rubber

- Replacement rubber for squeegee

SP50241 - 24"

SP50242 - 30"

SP50243 - 36"

SP50244 - 48"

SP50245 - 60"

SP50246 - 72"



Midwest Rake seal coat II squeegee with black rubber blade

- Oversized (1.375") aluminum handle with black vinyl grip



76821 24" blade with 66" handle

76822 30" blade with 66" handle

76823 36" blade with 66" handle

76824 48" blade with 66" handle

76825 60" blade with 66" handle

76826 72" blade with 66" handle

76831 24" blade with 82" handle

76832 30" blade with 82" handle

76833 36" blade with 82" handle

76834 48" blade with 82" handle

76835 60" blade with 82" handle

76836 72" blade with 82" handle

TAMPERS AND ROLLERS

Our rugged tampers make it easy to compact loose soil, sand and aggregate. They are a must-have tool for preparing a foundation for paving surfaces on drives, walks and patios. They also prized for compacting trenches (especially the narrow version) and for making sod repairs.



85078 Structron 8" tamper TP-8FG

- 8" x 8" cast iron head with braced corners
- 44" fiberglass handle with cushion grip



85008 Kenyon 8" all-steel tamper

- 8" x 8" 3/8" steel base plate
- Heavy-duty construction for maximum strength
- 48" steel handle with 12" double-dipped vinyl grip



85058 Kenyon 8" all-steel tamper

- 8" x 8" 3/8" steel base plate
- Heavy-duty construction for maximum strength
- 60" steel handle with 12" double-dipped vinyl grip



85010 Kenyon 10" all-steel tamper

- 10" x 10" 1/4" steel base plate
- Heavy-duty construction for maximum strength
- 48" steel handle with 12" double-dipped vinyl grip



85050 Kenyon 10" all-steel tamper

- 10" x 10" 1/4" steel base plate
- Heavy-duty construction for maximum strength
- 58" steel handle with 12" double-dipped vinyl grip



85054 Kenyon 4" x 10" all-steel tamper

- 4" x 10" 1/4" steel base plate
- Heavy-duty construction for maximum strength
- 58" steel handle with 12" double-dipped vinyl grip
- Ideal for trench tamping

WHERE CAN I USE A SMALL TAMPER?

The smaller 4" x 10" size is perfect for tight spaces, mounds, plates and trenches and comes with a 58" handle.



85088 Kenyon 8" tamper

- 8" x 8" cast iron head with braced corners
- 44" tapered hardwood handle, TP-30



85090 Kenyon 10" tamper

- 10" x 10" cast iron head with braced corners
- 44" tapered hardwood handle, TP-32



WHAT IS A TAMPER BOOT?

A tamper boot softens the blow and prevents soil from sticking.



85098 Kenyon 8" tamper boot



- 8" x 8" vinyl tamper boot with velcro closure



Our lawn roller helps even-out new sod installations and holds up to 270 lbs. (approx. 28 gallons) of water.

85750 Seymour lawn/sod roller



- 24" wide with 18" diameter
- 14 gauge steel
- Replacement plug is available (63221)



Our compost spreader is often used for topdressing existing lawns.

85755 Seymour compost spreader



- 24" wide with 18" diameter

SOIL PROBES AND TRENCHERS

Soil probes allow contractors to test soil consistency and identify underground obstructions. CATV, landscape lighting and irrigation contractors use our wire trenchers and cable placers for installing low voltage cables in the landscape.



85465 Structron 48" soil probe SP48

- Cast metal tip
- 48" fiberglass handle with t-cushion grip



85466 Structron 60" soil probe SP60

- Cast metal tip
- 60" fiberglass handle with t-cushion grip



PROBE TIPS

Steel tips provide strength with light weight



85462 Kenyon 48" steel tile probe

- Solid steel construction, .5" shaft
- Handle end caps



85468 Structron 36" wire and swing pipe placer

- .5" solid fiberglass rod with .75" hard nylon placer tip
- Handle end caps



PROBE TIPS

The .75" hard nylon tip is non-conductive. It grips the cable to place it into the trench bottom.



85469 Structron 48" wire and swing pipe placer

- .5" solid fiberglass rod with .75" hard nylon placer tip
- Handle end caps



49045 Kenyon all-steel landscape lighting trencher/edger

- 8.25" x 10" head
- 45" steel t-handle

GENEROUS STEPS

An all-steel tool for installing landscape lighting, irrigation line, landscape edging and more. The head is 8-1/4" wide and nearly 10" long with a 1-1/4" generous step.



49044 Kenyon all-steel landscape lighting trencher/edger

- 8.25" x 10" head
- 48" steel handle



85310 Kenyon all-steel manhole lifter with digout spike

- .75" steel hex shaft
- 36" overall length with sure-grip handle



ALL-STEEL CONSTRUCTION

- Heavy-duty 3/4" hex shaft
- Dig-out spike
- Steel leverage step
- Sure-grip handle
- 36" overall length

WHEELBARROWS

Our wheelbarrows make hard work easy. Choose heavy-duty features like all-steel construction and flat-free tires for reliable job-site performance. Large-capacity trays are available for hauling mulch and compost. Standard-duty units provide an optimum mix of price and performance.



Large poly tray for mulch and compost

85765 Seymour 10 cu. ft. wheelbarrow, poly tray

- Homeowner-duty poly tray - black, dual standard tires
- Hardwood handles, WB-10P



85725 ProValue 6 cu. ft. wheelbarrow, poly tray

- Light-duty poly tray - black, standard tire
- Hardwood handles, WB-6P



85724 Seymour 6 cu. ft. heavy-duty wheelbarrow, steel tray

- Heavy-duty steel tray - blue, with steel handles
- Flat-free tire
- Skid pad leg brace brackets (not shown), WB-6SHDS



85740 Seymour 6 cu. ft. wheelbarrow, steel tray

- Heavy-duty steel tray - blue, with hardwood handles
- Standard knobby tire
- Skid pad leg brace brackets (not shown), WB-6SHD



85728 Seymour 6 cu. ft. wheelbarrow, steel tray

- Light-duty steel tray - orange, standard tire
- Hardwood handles



85723 ProValue 6 cu. ft. wheelbarrow, steel tray

- Light-duty steel tray - green, standard tire
- Hardwood handles



85721 ProValue 4 cu. ft. wheelbarrow, steel tray

- Light-duty steel tray - green, standard tire
- Hardwood handles, WB-4S



85720 Seymour children's wheelbarrow, poly tray

- Poly tray - red, solid rubber tire
- Hardwood handles, WB-JR
- Also available in plain box (85720IB / WB-JRB)

85720PP Seymour children's wheelbarrow in retail box

- 85720 in full color retail box
- Nesting design

WHEELBARROWS

LOOKING FOR THE MOST DURABLE WHEELBARROW ON THE MARKET TODAY? **STRUCTRON'S GOT IT.**

EXCAVATOR MAX

SUPERIOR HEAVY-DUTY TOOLS
BY **STRUCTRON**

The new EXCAVATOR MAX is built solid to handle the toughest jobs and designed to last for years.

- Rugged steel tray and frame - haul soil, gravel, pavers and more with ease.
- "Flat-free" tires standard - eliminates down-time and maintenance hassles.
- Crew tested and preferred - for hardscape, concrete and landscape tasks.



85736 Structron Excavator® 6 cu. ft. wheelbarrow

- Rugged steel tray - yellow, with steel handles
- Flat free knobby tire



85738 Structron Excavator® 6 cu. ft. wheelbarrow

- Rugged steel tray - yellow, with steel handles
- Dual flat free knobby tires

6 REASONS WHY CONTRACTORS PREFER "FLAT-FREE" TIRES:

- No employee down-time due to flats.
- Roll over nails, glass, staples without worries.
- Eliminates maintenance and spare parts.
- No need to carry an air pump.
- Same bounce and load handling.
- Abrasion, chemical and UV resistant.



EXCAVATOR

BY SEYMOUR

85730 Seymour Excavator® 6 cu. ft. wheelbarrow

- Heavy-duty steel tray - blue, with steel handles
- Standard knobby tire



85731 Seymour Excavator® 6 cu. ft. wheelbarrow

- Heavy-duty steel tray - blue, with steel handles
- Flat-free knobby tire

EXCAVATOR CONSTRUCTION:

- All steel design assembles in less than 10 minutes
- The 6 cubic foot tray is reinforced at the bottom with a heavy-duty 1/4" thick "H" shaped support to prevent damage when used for hauling rock or concrete
- The front roll bar supports heavy loads when dumping
- The location of the cross bar does not impede step



85732 Seymour Excavator® 6 cu. ft. wheelbarrow

- Heavy-duty steel tray - blue, with steel handles
- Dual standard knobby tires



85733 Seymour Excavator® 6 cu. ft. wheelbarrow

- Heavy-duty steel tray - blue, with steel handles
- Dual flat-free knobby tires

STRIKING TOOLS - HAMMERS



Structron cross peen hammer

- Chamfered edges
- 16" double-injected fiberglass handle

41576 - 2 lb. head HB-2FG
 41577 - 3 lb. head HB-3FG
 41578 - 4 lb. head HB-4FG



Seymour cross peen hammer

- Chamfered edges
- 16" hickory handle

41572 - 2 lb. head HB-2
 41573 - 3 lb. head HB-3
 41574 - 4 lb. head HB-4



Structron drilling hammer

- Chamfered edges
- 10.5" double-injected fiberglass handle

41511 - 3 lb. head HD-3FG
 41512 - 4 lb. head HD-4FG



Seymour drilling hammer

- Chamfered edges
- 10.5" hickory handle

41550 - 2 lb. head HD-2
 41551 - 3 lb. head HD-3
 41552 - 4 lb. head HD-4



41503 Seymour 32 oz. dead blow hammer

- Molded polymer



Structron engineer hammer

- Chamfered edges
- 16" double-injected fiberglass handle

41509 - 2 lb. head HE-2FG
 41514 - 3 lb. head HE-3FG
 41515 - 4 lb. head HE-4FG
 41516 - 6 lb. head
 41517 - 8 lb. head
 41513 - 10 lb. head

Cross peen (or blacksmith) hammers are used to strike, shape, and bend unhardened metal.

Also used to shape block, brick, and stone.

Drilling hammers are used to strike cold chisels, punches, star drills, brick chisels, and hardened nails.

They are designed to deliver heavy blows with limited swing in tight spaces.



41536 Structron engineer hammer

- 4 lb. head with chamfered edges
- 16" premium hickory handle with double-dip grip



Seymour engineer hammer

- Chamfered edges
- 16" hickory handle

41553 - 2 lb. head HE-2
 41554 - 3 lb. head HE-3
 41555 - 4 lb. head HE-4
 41566 - 6 lb. head HE-6
 41567 - 8 lb. head HE-8

Engineers hammers (short handle sledges) are used to strike stone, concrete, metal, and wood.

Often used to drive stakes and rods or move timbers.



41500 Seymour 16 oz. rip hammer

- 13" hickory handle



41501 Seymour 16 oz. rubber mallet

- 10" hickory handle



41502 Seymour 24 oz. framing hammer

- Milled face
- 15" hickory handle



Structron sledge hammer

- Chamfered edges
- 36" double-injected fiberglass handle

41525 - 6 lb. head SH-6FG
 41520 - 8 lb. head SH-8FG
 41518 - 10 lb. head SH-10FG
 41519 - 12 lb. head SH-12FG
 41523 - 16 lb. head SH-16FG
 41524 - 20 lb. head SH-20FG



Structron sledge hammer

- Chamfered edges
- 36" premium hickory handle with double-dip grip

41537 - 6 lb. head
 41538 - 8 lb. head
 41539 - 10 lb. head

HAMMERS (CONT.) / MAULS / AXES - STRIKING TOOLS



Seymour sledge hammer

- Chamfered edges
- 36" hickory handle

41571 - 4 lb. head, SH-4
 41556 - 6 lb. head SH-6
 41560 - 8 lb. head SH-8
 41558 - 10 lb. head SH-10
 41559 - 12 lb. head SH-12
 41561 - 16 lb. head SH-16
 41562 - 20 lb. head SH-20W



41569 SmartBuy 8 lb. sledge hammer

- Promotional quality
- Chamfered edges
- 36" hickory handle SH-8P



Structron splitting maul, sledge eye

- Sledge eye head
- 36" double-injected fiberglass handle

41586 - 6 lb. head SM-6FG
 41588 - 8 lb. head SM-8FG



Seymour splitting maul, sledge eye

- Sledge eye head
- 36" hickory handle

41580 - 6 lb. head SM-6
 41582 - 8 lb. head SM-8

SPLITTING MAUL EYE DESIGNS

For splitting mauls, sledge eye design is the most widely used while axe eye design is preferred in some regions.



Seymour splitting maul, axe eye

- Axe eye head
- 36" hickory handle

41581 - 6 lb. head SM-6A
 41583 - 8 lb. head SM-8A



41589 SmartBuy 6 lb. splitting mail, sledge eye

- Promotional quality, sledge eye head
- 36" hickory handle SM-6P



Seymour wood-splitting wedge

- All-steel

41594 - 4 lb. WW-4
 41595 - 5 lb. WW-5
 41596 - 6 lb. WW-6



41599 Seymour grenade wedge

- 3.5 lb. splitting wedge
- 7" long

The grenade wedge makes splitting wood less of a chore than it is with a typical flat wedge. Unique four-sided diamond shape keeps the wedge from getting buried like standard wedges. Pointed end starts wedge easily, even by hand. Large head means fewer misses.



41521 Structron Michigan single bit axe AX-3FG

- Single bit 3.5 lb. head
- 36" double-injected fiberglass handle

Structron® premium fiberglass handles feature a solid fiberglass core with a double-injected molded polypropylene cover for the ultimate in durability for striking tools.



Structron Michigan single bit axe

- Single bit 3.5 lb. head
- 36" premium hickory handle with double-dip grip

41531 - 3.5 lb. head
 41532 - 5 lb. head



Seymour Michigan single bit axe

- Single bit 3.5 lb. head
- 36" hickory handle

41547 - 3.5 lb. head AX-3
 41544 - 5 lb. head AX-5



41543 SmartBuy Michigan single bit axe

- Single bit 3.5 lb. head
- Promotional quality
- 36" hickory handle AX-3P

STRIKING TOOLS - AXES (CONT.) / PICKS / MATTOCKS



41522 Structron Michigan double bit axe AX-DB3FG

- Double bit 3.5 lb. head
- 36" double-injected fiberglass handle



41533 Structron Michigan double bit axe

- Double bit 3.5 lb. head
- 36" premium hickory handle with double-dip grip



41548 Seymour Michigan double bit axe

- Double bit 3.5 lb. head
- 36" hickory handle AX-DB3



41542 Seymour miners axe

- Single bit 3.5 lb. head
- 27" hickory handle AX-3M

The miners axes features a 3.5 lb. head on a shorter 27" straight handle for use in tight places. Also makes a great camp axe for packing and splitting wood.



41545 Seymour boys single bit axe

- Single bit 2.25 lb. head
- 28" hickory handle AX-B2

Boys (house) single bit axes are lighter duty axes used to cut saplings, split kindling, trim branches, and prune trees.



41530 Structron boys single bit camp axe

- Single bit 1.25 lb. head
- 14" premium hickory handle with double-dip grip



41546 Seymour boys single bit camp axe

- Single bit 1.25 lb. head
- 14" hickory handle AX-B1



41510 Structron Pulaski axe

- Single bit 3.5 lb. head
- 36" double-injected fiberglass handle

Pulaski axes combine a single bit axe blade with a mattock blade. This blade combination makes it ideal for firefighting and for a variety of landscaping applications.



41534 Structron Pulaski axe

- Single bit 3.5 lb. head
- 36" premium hickory handle with double-dip grip

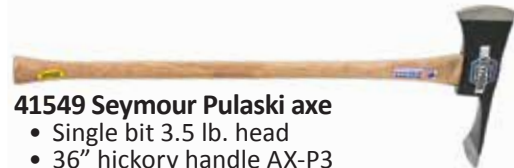

41549 Seymour Pulaski axe

- Single bit 3.5 lb. head
- 36" hickory handle AX-P3



85535 Structron garden pick mattock GP-2FG

- 2.5 lb. head, #10 slip eye
- 36" double-injected fiberglass handle



85532 Structron garden pick mattock

- 2.5 lb. head
- 36" premium hickory handle with double-dip grip



85534 Seymour garden pick mattock

- 2.5 lb. head
- 36" hickory handle GP-2



Structron railroad pick

- #6 eye
- 36" double-injected fiberglass handle

85545 - 5 lb. head RP-5FG

85547 - 6 lb. head RP-6FG

85525 - 5 lb. head only RP-5H

85526 - 6 lb. head only RP-6H



63007 Structron fiberglass pick/mattock handle

- Nylon head (handle only)
- 36" poly coated handle

MATTOCKS (CONT.) / PRY BARS - STRIKING TOOLS



85555 Seymour railroad pick

- 5 lb., #6 eye
- 36" hickory handle, RP-5

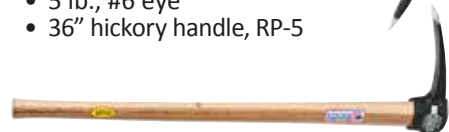

85556 Seymour railroad pick

- 6 lb., #6 eye
- 36" hickory handle, RP-6

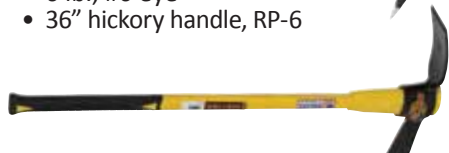

85543 Structron cutter mattock MC-5FG

- 5 lb. #6 eye
- 36" double-injected fiberglass handle



85552 Seymour cutter mattock

- 5 lb. #6 eye
- 36" hickory handle MC-5
- Replaceable head (85522 / MC-5H)



85537 Structron garden cutter mattock MG-2FG

- 2.5 lb., #10 slip eye
- 36" double-injected fiberglass handle



85536 Seymour garden cutter mattock

- 2.5 lb.
- 36" hickory handle MG-2

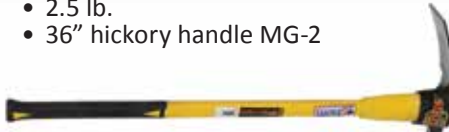

85541 Structron pick mattock MP-5FG

- 5 lb. #6 eye
- 36" double-injected fiberglass handle



85560 Structron pick mattock

- 5 lb. #6 eye
- 36" premium hickory handle with double-dip grip

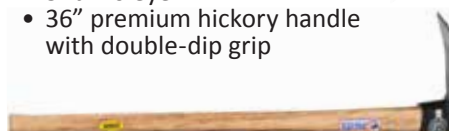

85550 Seymour pick mattock

- 5 lb. #6 eye
- 36" hickory handle MP-5
- Replaceable head (85520 PM-5H)



85549 SmartBuy pick mattock

- 5 lb. #6 eye
- Promotional quality
- 36" hickory handle MP-5P



63031 Seymour wood pick/mattock handle

- Poly head
- 36" handle



85529 ProValue garden hoe mattock

- 2 lb.
- 51" handle HM-949



Seymour wrecking bar

- Hex shank

85300 - 12" x 1/2" WR-12

85302 - 24" x 3/4" WR-24

85303 - 36" x 3/4" WR-36

85301 - 18" x 5/8" WR-18

85305 - 30" x 3/4" WR-30

85304 - 48" x 1"



85364 Seymour San Angelo bar

- 60" x 1" hex shank, 14 lb.
- Chisel head & diamond point



85367 Seymour San Angelo bar

- 72" x 1" hex shank, 17 lb.
- Chisel head & diamond point DG-23



85366 Seymour posthole digging bar

- 72" x 1" shank, 17 lb.
- Chisel head & tamper head DG-19



85365 Seymour wedge point bar

- 60" x 1.25" shank, 18 lb. DG-WP60



85368 Seymour pinch point bar

- 60" x 1.25" shank, 18 lb. DG-PP60



Seymour slate bar

- 1" shank
- Bent chisel head & diamond point

85360 - 48" 11 lb. SB-48

85361 - 60" 14 lb. SB-60



85332 Seymour landscape bar

- 69" x 1.25" round shank, 29 lb.

MEASURING TOOLS

Kenyon ProGrade measuring wheel

- Heavy-duty 3/4" steel tube frame and handle
- Wheel is positioned in the center of frame
- Folds in half for storage and portability
- 5 digit, easy-to-read counter
- Measurements in feet up to 99,999 ft.
- Comes with mud scraper

85713 - 3' wheel circumference
85714 - 4' wheel circumference



Kenyon Groundscaper

- Molded ABS wheel
- Telescopic metal handle with kickstand
- Geared counter
- Measurements in feet and inches up to 9,999 ft
- Lightweight and durable

85703 - 3' wheel circumference
85704 - 4' wheel circumference



41050 Kenyon tape measure

- 1" x 25' tape measure

85701 Kenyon small telescoping measuring wheel

- Wheel has 1' circumference with 4" diameter
- Handle telescopes from 17" to 38"
- Fits in a toolbox or briefcase
- Geared counter
- Measurements in feet and inches up to 9,999 ft
- Adds while rolling forward and subtracts when pulled in reverse
- Weights less than 2 pounds



85712 Kenyon wide-trak measuring wheel

- Wheel has 2' circumference with 7.5" diameter
- Solid and wider wheel for excellent balance
- Heavy-duty 3/4" steel handle
- 5 digit, easy-to-read counter
- Measurements in feet up to 99,999 ft.



VALVE KEYS & WRENCHES

INTERCHANGEABLE 3-IN-1 OPERATING WRENCH

Comes equipped with your choice of 3 ends that snap into place and store in the tool.



85490 Kenyon adjustable operating wrench

- 3'-5' with A, B, D

85491 Kenyon adjustable operating wrench

- 3'-5' with A, B, C

85495 Kenyon adjustable operating wrench

- 5'-9' with A, B, D

85496 Kenyon adjustable operating wrench

- 5'-9' with A, B, C

SP50162 Kenyon (A) square key

- Fits 2" operating nut

SP50163 Kenyon (B) valve key

- Fits 1" opening

SP50164 Kenyon (C) meter key

- Fits 1-1/8" opening

SP50167 Kenyon (D) meter key

- Fits 1/2" opening



(A) 2"
SQUARE KEY



(B) 1"
VALVE KEY



(C) 1-1/8"
METER KEY

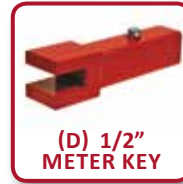

(D) 1/2"
METER KEY

KENYON

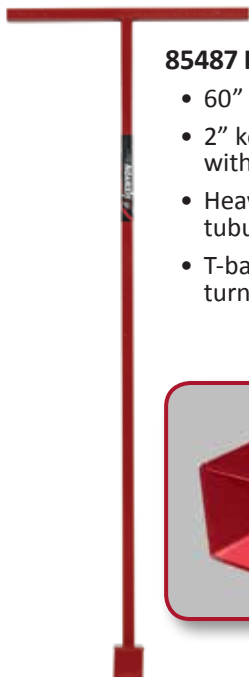

85487 Kenyon operating wrench

- 60" long, 1" shaft diameter
- 2" key for operating gate valves with a 2" square nut
- Heavy duty structural tubular steel
- T-bar handle provides maximum turning leverage



METER & CURB STOP KEYS

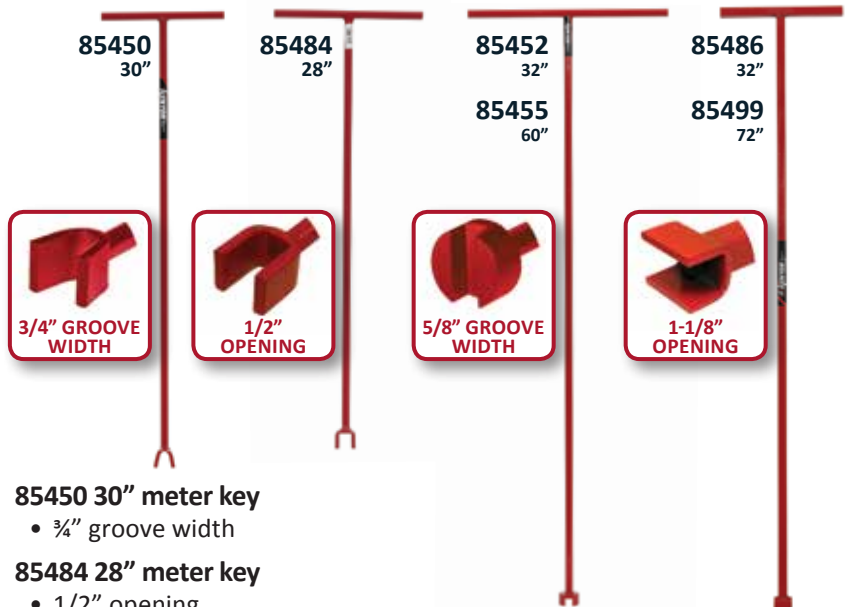

85450
30"



3/4" GROOVE
WIDTH

85450 30" meter key

- 3/4" groove width

85484
28"



1/2" OPENING

85484 28" meter key

- 1/2" opening

85452
32"



5/8" GROOVE
WIDTH

85452 32" heavy-duty meter key

- 5/8" groove width

85455
60"

85455 60" heavy-duty meter key

- 5/8" groove width

85486
32"



1-1/8" OPENING

85486 32" meter key

- 1-1/8" opening

85499
72"

85499 6' meter key

- 1-1/8" opening

IRRIGATION TOOLS

SPRINKLER VALVE KEYS

For opening valves with cross handles

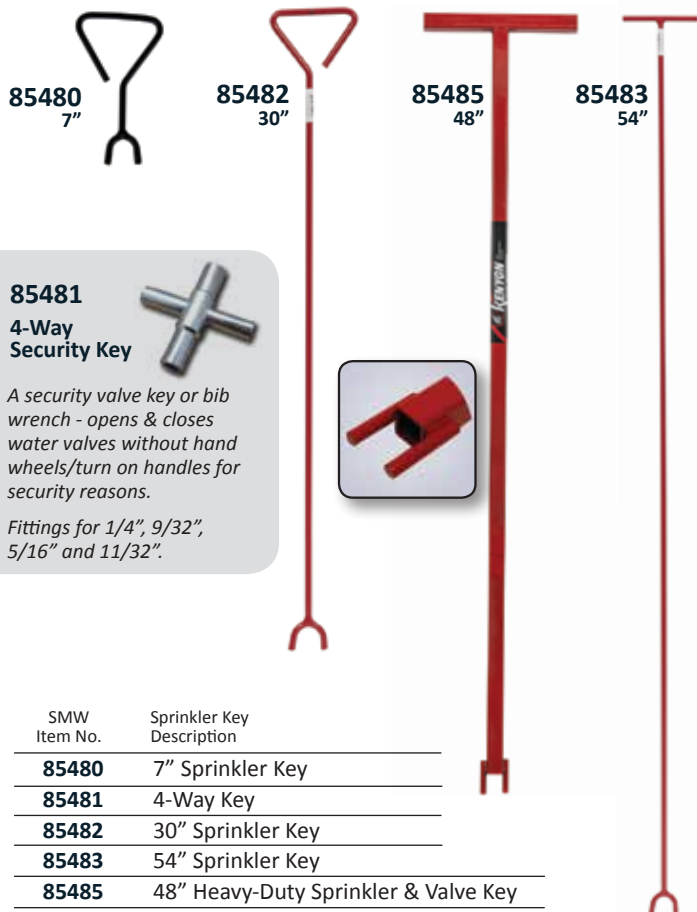

85481
4-Way
Security Key

A security valve key or bib wrench - opens & closes water valves without hand wheels/turn on handles for security reasons.

Fittings for 1/4", 9/32", 5/16" and 11/32".

SMW Item No.	Sprinkler Key Description
85480	7" Sprinkler Key
85481	4-Way Key
85482	30" Sprinkler Key
85483	54" Sprinkler Key
85485	48" Heavy-Duty Sprinkler & Valve Key

Seymour drain and irrigation channel cleaner

- 15" steel head
- 72" hardwood handle

21504 - 4" blade DR-DC4
21505 - 5" blade DR-DC5



41250 Kenyon EZ Out

- .5" & .75" all-steel
- For extracting broken plastic pipe risers
- T-handle for extra torque

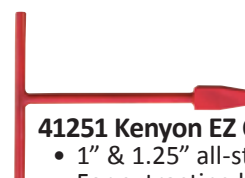

41251 Kenyon EZ Out

- 1" & 1.25" all-steel
- For extracting broken plastic pipe risers
- T-handle for extra torque



41255 Kenyon EZ Out

- .5" & .75" aluminum head
- For extracting broken plastic pipe risers
- Hand grip for extra torque

SPRINKLER HEAD TRIMMERS



- 5/8" structural steel rod shaft
- Red powder-coated steel
- Step plate for ease of use
- Available in seven diameters

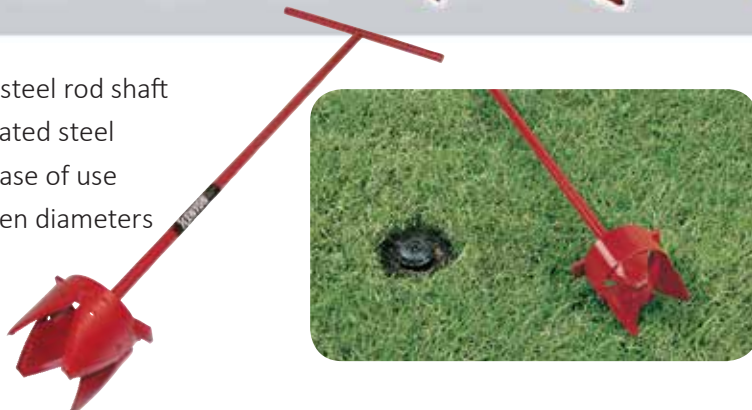

SMW Item No.	Inside Head Diameter in.	O/A Length in.
85422	2-3/4	33
85423	3-1/2	33
85424	4	33
85426	6	33
85427	7	33
85428	8	33
85430	10	33

IRRIGATION & PLUMBING PIPE SAWS



41440 Kenyon 6" mini hacksaw

- 6" x 1/2" blade, for use in tight spaces
- Cuts metal or plastic pipe
- Replaceable blade (SP13300, pack of 10)



41442 Kenyon high tension hacksaw

- 12" bi-metal blade
- Replaceable blade (SP13304)



41444 Kenyon tool box saw

- 14" flexible blade
- For general purpose cutting



41446 Kenyon 18" PVC saw

- 18" blade
- Specially designed to cut PVC, CPVC, ABS, and plastic drainage pipe
- Replaceable blade (SP13305)



41448 Kenyon 36" cable saw

- 36" cable blade
- Cuts PVC, CPVC, ABS, and poly pipe
- Works well in trenches or tight spaces
- T-handles

PIPE & HOSE CUTTERS



41430 Kenyon 1-5/8" professional PVC pipe cutter

- Ratchet action cuts CL200 or SCH 40 PVC pipe
- Replaceable blade (SP13301)



41432 Kenyon 2" professional PVC pipe cutter

- Ratchet action cuts CL200 or SCH 40 PVC pipe
- Replaceable blade (SP13302)



41434 Kenyon professional pipe & hose cutter

- Unique spring-loaded design
- Cuts poly pipe, hose, or drip tubing
- Replaceable blade (SP13303)



41436 Kenyon ratcheting PVC pipe cutter

- 2" max cut

PIPE WRENCHES



41610 Kenyon 14" aluminum pipe wrench

- 14" overall length



41612 Kenyon 18" aluminum pipe wrench

- 18" overall length



41614 Kenyon 24" aluminum pipe wrench

- 24" overall length



41600 Kenyon 14" steel pipe wrench

- 14" overall length



41602 Kenyon 18" steel pipe wrench

- 18" overall length



41604 Kenyon 24" steel pipe wrench

- 24" overall length

SPORTS FIELD TOOLS

We are the leading toolmaker and supplier of choice to many different sports and recreational venues from the amateur to the professional level. The highly trained and passionate professionals who care for these sportsapes demand tools of quality and durability. Our line consistently exceeds their expectations.



ALL PRODUCTS ON THIS PAGE ARE MADE IN THE USA (UNLESS NOTED)

- Midwest Rake aluminum dual purpose rake**
- Heavy-duty aluminum head and wrap-around bracing
 - 66" powder-coated aluminum handle with vinyl grip

12524 - 24" head
12536 - 36" head



- Midwest Rake field rake**
- Rounded teeth offer smooth non-gouging raking action
 - Wrap-around bracing
 - 66" powder-coated aluminum handle with vinyl grip

12024 - 24" head **12030 - 30" head**
12036 - 36" head **12042 - 42" head**
12048 - 48" head



- Seymour plug pusher**
- Aluminum head with wrap-around bracing
 - 66" powder-coated aluminum handle

51924 - 24" head
51936 - 36" head



- Midwest Rake baserunner field rake**
- Aluminum head with rounded, non-gouging teeth
 - Double lock 39" - 70" telescoping fiberglass Superhandle™

12501 - 24" head
12502 - 30" head
12503 - 36" head



- Midwest Rake aluminum screening rake**
- Heavy-duty aluminum head and wrap-around bracing
 - 66" powder-coated aluminum handle with vinyl grip

11024 - 24" head **11030 - 30" head**
11036 - 36" head **11042 - 42" head**
11048 - 48" head



- 52936 Midwest Rake scarifier lute rake**
- 36" aluminum head with wrap-around bracing
 - Fine serrated teeth along with extended grading edge
 - 66" powder-coated aluminum handle with vinyl grip



- Midwest Rake ProTurf lute**
- Heavy-duty aluminum head with wrap-around bracing
 - Powder-coated aluminum handle

56923 - 24" head with 66" handle
56929 - 30" head with 66" handle
56935 - 36" head with 66" handle
56924 - 24" head with 82" handle
56930 - 30" head with 82" handle
56936 - 36" head with 82" handle



WHY A DUAL PURPOSE RAKE?

A Seymour Midwest exclusive. This innovative and versatile tool has two teeth profiles. The short teeth are used for breaking up hard packed clay and grading, while the long teeth are for wet clay and general raking.



THE RAKE THE PROS USE...

Engineered to the specifications of landscapers and professional baseball grounds crews, the extended grading edge on this rake was designed specifically for leveling.

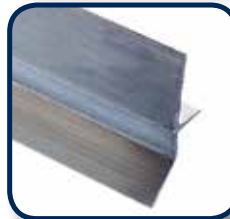

PERFECT FOR AERATION...

A durable, versatile tool used to push aeration plugs off of turf and as a very effective scraper/leveler in a variety of settings.



TELESCOPING HANDLE RAKE

Knocks down for easy storage. The perfect tool for grooming infields and beach volleyball courts. The head was designed specifically for the sports turf industry. The high straight edge is excellent for grading.



SCREENING RAKE DESIGN:

This rake is specially designed for sifting, grading, and screening. It is an excellent tool when you need to sift or screen stones and debris from sand or fine soil.

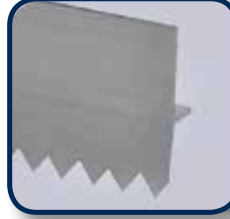

OUR SCARIFIER LUTE RAKE...

has fine serrated teeth on this rake break up hardened surface materials, while the extended grading edge smooths and levels, while spreading material. Excellent for baseball and softball diamonds as well as clay tennis courts.

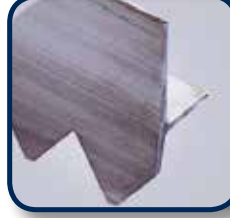

ON THE FIELDS & SKI SLOPES...

This lightweight, heavy-duty lute combines an engineered head design with our strong wrap-around bracing and is another great infield grooming rake. We use a solid aluminum plug in our head-to-handle connection, unlike the plastic or wood plugs used in many other brands.



ALL PRODUCTS ON THIS PAGE
ARE MADE IN THE USA (UNLESS NOTED)



- 82925 Seymour 24" general purpose broom**
- 3" durable bristles, super-strong gusset bracing
 - 60" straight powder-coated aluminum handle



OUR GENERAL PURPOSE BROOMS...

are often flipped for a final dressing of base paths and other skinned areas. These brooms use durable polypropylene bristles, firmly attached to a high quality hardwood shoulder.

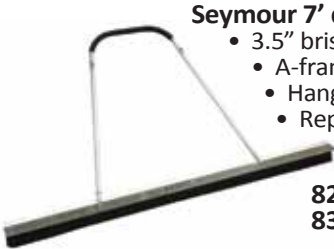

- Seymour 7' double play monster broom**
- 3.5" bristles plus short teeth for breaking up dirt
 - A-frame foam padded handle
 - Hanging hooks
 - Replaceable bristle rows (SP50067)

- 82384 - Broom with 2 bristle rows**
83384 - Broom with 3 bristle rows



- Seymour 7' monster warehouse drag broom**
- 3.5" durable bristles
 - A-frame foam padded handle
 - Hanging hooks
 - Replaceable bristle rows (SP50067)

- 82084 - Broom with 2 bristle rows**
83084 - Broom with 3 bristle rows



7' DOUBLE PLAY & 7' STANDARD MONSTER DRAG BROOMS...

we've taken the standard infield drag broom and added a scarifier edge allowing the 7' double play drag broom to perform double duty. It functions as a 7' grooming rake and by simply flipping it over to the bristle side, you have the perfect finishing drag. The 7' Standard Drag Broom is still a great finishing drag, but can also be used as a top dressing broom on greens and tee boxes around the golf course. It also clears dew.



- 52917 Midwest Rake 17" mound and plate shaper**
- Heavy-duty aluminum head and bracing
 - 66" powder-coated aluminum handle



A UTILITY INFIELDER YOU CAN PLAY EVERYDAY...

The perfect size for restoring the pitching mound to a professional surface, just scarify, level, tamp and repeat. Great for shaving and carving the pitching mound. The flat front of this tool can be used as a tamp in secondary areas where light tamping is required.



- Midwest Rake 36" non-absorbent roller squeegee**
- Great for turf applications
 - 60" ergonomic powder-coated aluminum handle
 - Replacement rollers (SA10048)

- 70936 - Squeegee with blue handle**
70636 - Squeegee with yellow handle



- Midwest Rake 48" non-absorbent roller squeegee**
- Great for turf applications
 - 60" ergonomic powder-coated aluminum handle
 - Replacement rollers (SA10049)

- 70948 - Squeegee with blue handle**
70648 - Squeegee with yellow handle



ERGONOMICS & PREMIUM HANDLES MATTER!

Our bent "ergonomic" powder-coated aluminum handles allow for a more effective downward and forward pressure which provides more effective head-to-surface contact while promoting comfort and ease of use. A high quality poly-blend powder-coating formula is bonded to our durable aluminum handles, providing a superior grip when the tool is wet, blister reduction, and greater durability.

SNOW TOOLS



- 96820 Structron snow shovel SS200**
- 18" steel blade
 - 41" fiberglass handle with poly d-grip



- 96823 Structron snow shovel AS200**
- 18" aluminum blade with wear strip
 - 41" fiberglass handle with poly d-grip



- 96800 Seymour snow shovel**
- 18" steel blade
 - 41" hardwood handle with poly d-grip, SV-SS25



- 96803 Structron snow shovel**
- 18" aluminum blade with wear strip
 - 41" hardwood handle with poly d-grip, SV-SS22



- 96830 Structron snow pusher SP100**
- 24" steel blade with braces
 - 42" fiberglass handle with poly d-grip



- 96833 Structron snow pusher AP100**
- 24" aluminum blade with wear strip & braces
 - 42" fiberglass handle with poly d-grip



- 96810 Seymour snow pusher**
- 24" steel blade with braces
 - 42" hardwood handle with poly d-grip, SV-SP25



- 96813 Seymour snow pusher**
- 24" aluminum blade with wear strip & braces
 - 42" hardwood handle with poly d-grip, SV-SP22



- 96827 Structron ergonomic snow shovel PSE200**
- 19" 50/50 polycarbonate & ABS blend blade
 - 34" bent steel handle with poly d-grip



- 96829 Structron snow shovel PS200**
- 19" 50/50 polycarbonate & ABS blend blade
 - 43" fiberglass handle with poly d-grip



- 96809 Seymour snow shovel**
- 19" 50/50 polycarbonate & ABS blend blade
 - 44" hardwood handle with poly d-grip, SV-SS20



- 96838 Structron snow pusher PP100**
- 24" 50/50 polycarbonate & ABS blend blade
 - 44" fiberglass handle with poly d-grip



- 96818 Seymour snow pusher**
- 24" 50/50 polycarbonate & ABS blend blade
 - 44" hardwood handle with poly d-grip, SV-SP20



ALL PRODUCTS ON THIS PAGE
ARE MADE IN THE USA (UNLESS NOTED)



96806 ProValue snow shovel

- 16.5" poly blade
- 30" vinyl coated steel handle with poly d-grip



96808 ProValue ergonomic snow shovel

- 16.5" poly blade
- 35" bent tubular steel handle with cushion middle grip & poly d-grip



96807 ProValue snow shovel

- 18" poly blade
- 31" vinyl coated steel handle with poly d-grip



96817 ProValue snow pusher

- 19" poly blade
- 30" vinyl coated steel handle with poly d-grip

SNOW SQUEEGEE

Seymour snow squeegee

- 3" deep reversible and replaceable rubber blade
- Clamp-style frame for ease of use
- 66" powder-coated aluminum handle with vinyl grip

96624 - 24" blade

96636 - 36" blade



ROOF RAKES

96032 Structron snow roof rake RR-25X

- 24" aluminum blade with braces (*not made in the USA*)
- 1-piece 22' telescoping handle with vinyl grip



96701 Shingle saver sleeve

96022 Seymour snow roof rake RR-25

- 24" aluminum blade with braces
- 16', 3-section extendable handle with vinyl grip



96048 Seymour 4' extension handle, BA

96060 Seymour 5' extension handle

96148 Seymour 4' extension handle, IB

96701 Shingle saver sleeve

96322 Seymour snow roof rake

- 24" aluminum blade with braces
- 16', 4-section extendable handle with vinyl grip
- 60" POP display box is UPS-compatible

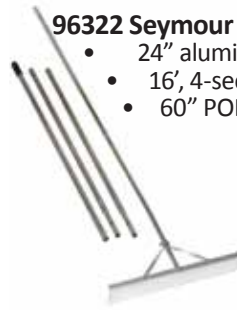

96048 Seymour 4' extension handle, BA

96060 Seymour 5' extension handle

96148 Seymour 4' extension handle, IB

96701 Shingle saver sleeve

96716 ProValue snow roof rake

- 24" aluminum blade with braces
- Shingle saver sleeve
- 16', 3-section extendable aluminum handle



96758 ProValue 5' extension handle

96701 Shingle saver sleeve

96721 ProValue snow roof rake

- 24" aluminum blade with braces
- Shingle saver sleeve
- 21', 4-section extendable aluminum handle



96758 ProValue 5' extension handle

96701 Shingle saver sleeve

LINK HANDLES - ABOUT

We offer the industry's widest selection of replacement handles that help you extend the life of your trusted tools. With over 6,000 handle patterns available, we can provide an exact match that fits the tool with an ergonomically-superior turned design.



LINK HANDLES®

FACTS TO KNOW WHEN SELECTING A REPLACEMENT HANDLE

Tool handles can be made from a variety of hardwoods as well as fiberglass and steel. Each material has certain advantages and disadvantages for replacement handles.

American hickory and ash

The best replacement handles are made from American hickory and American ash because of their strength, elasticity, and ability to absorb shock. Hardwood handles do not conduct electricity.

Shock-absorbing American hickory

American hickory is dense, heavy, and a natural shock absorber making it ideal for striking and cutting tool handles.

The long fibers and unique cell structure of American hickory allow it to flex repeatedly and return to its original shape. It absorbs and dissipates shock before it reaches the user's hands.

The best hickory is grown in the Tennessee region of the USA

The best American hickory logs come from Tennessee, Kentucky, North Carolina, and South Carolina. This region has the ideal combination of soil minerals, rainfall, and sunshine to produce trees that grow slowly and uniformly for exceptional strength.

Wood from slower growing trees is denser and thus stronger than the lighter wood that comes from faster growing trees.

All Link hickory comes from the Tennessee region of the USA. Some hickory grows in the northeastern United States, but it is generally of lower quality than the hickory grown in the Tennessee region.

American ash handles for agricultural tools

Many agricultural tool handles such as shovels, rakes, and hoes are made from American ash. It has a uniform grain structure that provides both the strength and the elasticity needed for the bending stresses these tools must endure.

Other hardwoods

When ash or hickory is not used, other hardwoods suitable for the application are selected.

While ash gives the finest strength to weight ratio, handles of other hardwoods are appropriately selected for many types of tools.

Fiberglass handles

Fiberglass handles are strong, lightweight, and do not conduct electricity. Fiberglass, however, is not flexible and *does not absorb shock*. Fiberglass handles cost more than hardwood handles.

Link offers fiberglass replacement handles.

Steel handles

Steel handles are extremely strong, but they are *heavy and expensive*. They are *not flexible* and *do not absorb shock*. Steel handles conduct electricity.



Vintage logo from the Sequatchie Handle Works

ABOUT - LINK HANDLES

Choose our shock-absorbing hickory handles for striking or cutting tools. The unique fibers of American hickory provide outstanding durability and shock absorption for less wear-and-tear on the user's hands. It's no wonder why drumsticks are made of hickory!

LINK HANDLES®

ACCEPT NO SUBSTITUTES!

Turned handles are ergonomically superior to shaped handles

There are two ways to produce handles: shaping and turning.

Shaped handles are made from flat boards that are smoothed and rounded on the top and bottom. Shaping is a faster and less costly way to make handles.

Turned handles are made on a lathe from wood blanks that are about 25% larger than the flat boards. The result is a handle that has better grips and contours.

Anyone who holds a shaped handle and then a turned handle will immediately feel the higher quality of the turned handle. Link handles uses the turned handle method.

Shaped

Turned

Hammer handles typically come with a wood and metal wedge. Axe handles typically come with a wood wedge. Slip eye handles (pick, garden mattock, grub hoe, long tire tool, etc.) don't come with any wedges.



The best replacement handles are turned rather than shaped. Turning results in ergonomically-superior handles that provide better comfort, control, and safety.

Only Link Handles offer superior ergonomic design

Link handles are designed with the best combination of length and contours so the user can best hold the handle and use the tool.

Our handle shape always works with the user. The handle becomes an extension of the body to provide better comfort, control, and safety.



WE TAKE THESE STEPS IN MAKING EVERY TURNED AXE HANDLE:



1. Start with an axe wood square or blank.



2. Half turned axe handle.



3. Full rough turned axe handle.



4. Axe handle after sanding.



5. Finished axe handle with label and wedge.

LINK HANDLES - QUALITY LEVELS

Link Handles have set the industry benchmark for when it comes to what customers care about most: consistent quality, outstanding ergonomics and exact fit matches to over 6,000 tools.

LINK HANDLES®

ALL HANDLES ARE CAREFULLY GRADED & SORTED

LINK's experienced timber buyers grade log quality. They are looking for logs that are heavy and defect-free.

When the logs are sawed into squares (or blanks), the squares are graded. After the squares are turned into handles, they are graded again.

PRIMARY LOG QUALITY FACTORS

Some of the factors used to determine quality include:

STRAIGHTNESS OF GRAIN

MOISTURE CONTENT

DENSITY

FREEDOM FROM DEFECTS

WOOD COLOR NOT A QUALITY FACTOR

Color of the wood is not a factor in determining the quality of hickory handles. The best hickory handles may be all white, red-and-white, or all red.

LINK AMERICAN HICKORY QUALITY LEVELS

01 Best quality American hickory with sanded finish and yellow non slip grip. Meets or exceeds all government "A" specifications. Ideal for the most demanding industrial and commercial applications.

02 Best quality American hickory with a wax finish. Meets or exceeds all government "A" specifications. Ideal for the most demanding industrial and commercial applications.

04 Better quality American hickory with a wax finish. Ideal for frequent heavy-duty use by farmers, ranchers, contractors and other professionals with demanding construction and other professional applications.

19 Better quality American hickory with a clear lacquer finish. Fire finish provides a highly pleasing appearance. Ideal for frequent heavy-duty use by farmers, ranchers, contractors and other professionals with demanding construction and other professional applications.

08 Good quality American hickory with wax finish. These handles provide exceptional value and economy for homeowner and other occasional use applications.

09 Promotional quality American hickory with wax finish. These handles provide good value and economy for homeowner and other occasional use applications.

LINK AMERICAN ASH QUALITY LEVELS

18 Best quality American ash with a clear lacquer finish. Ideal for the most demanding industrial and commercial applications.

21 Better quality American ash with a clear finish. Ideal for frequent heavy-duty use by farmers, ranchers, contractors and other professionals with demanding construction and other professional applications.

SUMMARY OF LINK FINISHES AND QUALITY LEVELS

Quality Level #	Quality Level	Finish Type	Special Features	Govt. Specs	Suggested User
AMERICAN HICKORY					
01	Best	Sanded	Non-slip grip	A	Industrial, commercial
02	Best	Wax		A	Industrial, commercial
04	Better	Wax			Contractor, professional
19	Better	Clear lacquer	Fire finish		Contractor, homeowner
08	Good	Wax			Homeowner
09	Promo	Wax			Homeowner
AMERICAN ASH					
18	Best	Clear lacquer			Industrial, commercial
21	Better	Clear lacquer			Contractor, homeowner

MERCHANDISING - LINK HANDLES

Link replacement handles allow today's consumer or professional contractor to get additional years of life out of trusted tools by replacing cracked, worn or broken handles. Handy merchandising units act as silent salesmen, guiding customers to the correct replacement.

THERE IS NO SUBSTITUTE FOR A GOOD DISPLAY

- Let customers know you carry common replacements.
- Illustrated display banner shows and tells which tools each handle fits.
- Simple plan makes every clerk an instant replacement handle expert.
- Makes selection easy for customers.
- Requires minimum space.
- Organized and neat.
- Strong and attractive rack.
- Available in 5, 8, and 12 hook models.
- Available in wall or floor versions.
- Easily customized to your exact needs.
- Improves inventory control.
- Simplifies re-orders.
- Increases sales profits.



The wall mount displays can be used as floor displays by using the floor stands (ordered separately).

Model

64024 / LINK5HD
64026 / LINK8HD
64021 / LINK12HD
64027 / LINKFSD

Description

5-hook display, pegboard wall mount, 15" wide
8-hook display, pegboard wall mount, 24" wide
12-hook display, pegboard wall mount, 24" wide
Floor stand for wall mount displays

LINK HANDLES - HICKORY

AXE AND BUSH HOOK HANDLES

SINGLE BIT CURVED GRIP AXE HANDLES

For 3 to 5 lb. axes and bush hooks, eye 2-5/16" x 3/4"



Model	Length	UPC 0 25545 +	Pack qty	Pack wgt	Pack cube
64698 / 100-01	36"	10001-5	12	18.0	0.92
64701 / 100-02	36"	10002-2	12	18.0	0.92
64702 / 100-04	36"	10004-6	12	18.0	0.92
64703 / 100-08	36"	10008-4	12	18.0	0.92
64707 / 100-09	36"	00109-1	12	18.0	0.92
64709 / 100-19	36"	10019-0	12	18.0	0.92
64889 / 102-02	32"	10202-6	12	15.0	0.92
64890 / 102-08	32"	10208-8	12	15.0	0.92
64894 / 102-19	32"	10219-4	12	15.0	0.92
64903 / 104-08	28"	10204-2	12	12.0	0.92

BOYS SINGLE BIT CURVED GRIP AXE HANDLES

For 2-1/4 lb. axes, eye 2-1/16" x 11/16"



Model	Length	UPC 0 25545 +	Pack qty	Pack wgt	Pack cube
64913 / 116-02	28"	11602-3	12	10.0	0.66
64914 / 116-08	28"	11608-5	12	10.0	0.66
64918 / 116-19	28"	11619-1	12	10.0	0.66

HOUSE CURVED GRIP AXE HANDLES

For 2-1/4 lb. axes, eye 2-1/16" x 11/16"



Model	Length	UPC 0 25545 +	Pack qty	Pack wgt	Pack cube
64926 / 118-04	18"	11804-1	12	8.0	0.60
64927 / 118-19	18"	11819-5	12	8.0	0.60

STRAIGHT SINGLE BIT AXE HANDLES

For 3 to 5 lb. axes, eye 2" x 13/16"



Model	Length	UPC 0 25545 +	Pack qty	Pack wgt	Pack cube
64730 / 119-09	36"	11909-3	12	18.0	0.92
64731 / 119-19	36"	11919-2	12	18.0	0.92

MINER'S STRAIGHT SINGLE BIT AXE HANDLES

For 3 to 5 lb. axes, eye 2" x 13/16"



Model	Length	UPC 0 25545 +	Pack qty	Pack wgt	Pack cube
64937 / 124-02	27"	12402-8	12	12.0	0.60
64939 / 124-19	27"	12419-6	12	12.0	0.60



ALL PRODUCTS ON THIS PAGE
ARE MADE IN THE USA (UNLESS NOTED)

DOUBLE BIT AXE HANDLES

For 3 to 5 lb. axes, some Pulaski axes, and #2 and #3 coal picks, eye 2-7/8" x 5/8"



Model	Length	UPC 0 25545 +	Pack qty	Pack wgt	Pack cube
64738 / 140-02	36"	14002-8	12	18.0	0.92
64739 / 140-04	36"	14004-2	12	18.0	0.92
64740 / 140-08	36"	14008-0	12	18.0	0.92
64743 / 140-09	36"	14009-7	12	18.0	0.92
64745 / 140-19	36"	14019-6	12	18.0	0.92
64941 / 142-19	32"	14219-0	12	15.0	0.92

CRUISER'S OR CEDAR DOUBLE BIT AXE HANDLES

For 2-1/2 lb. axes, eye 2-1/4" x 5/8"



Model	Length	UPC 0 25545 +	Pack qty	Pack wgt	Pack cube
64944 / 145-02	28"	14502-3	12	10.0	0.66
64945 / 145-08	28"	14508-5	12	10.0	0.66
64946 / 145-09	28"	14509-2	12	10.0	0.66
64947 / 145-19	28"	14519-1	12	10.0	0.66

PICK, MATTOCK & GRUB HOE HANDLES

DOUBLE BIT GARDEN MATTOCK HANDLES

For 2-1/2 lb. mattocks, No. 10 eye 3" x 1"



Model	Length	UPC 0 25545 +	Pack qty	Pack wgt	Pack cube
64761 / 200-09	36"	20009-8	12	18.0	0.92
64762 / 200-19	36"	20019-7	12	18.0	0.92

CURVED GRUB HOE HANDLES

For 3-1/2 to 5 lb. grub hoes, No. 8 eye 3" x 2"



Model	Length	UPC 0 25545 +	Pack qty	Pack wgt	Pack cube
65117 / 210-19	36"	21019-6	12	30.0	1.37

STRAIGHT GRUB HOE HANDLES

For 3-1/2 to 5 lb. grub hoes, No. 8 eye 3" x 2"



Model	Length	UPC 0 25545 +	Pack qty	Pack wgt	Pack cube
65121 / 214-19	36"	21419-4	12	30.0	1.37
65123 / 215-19	40"	21519-1	12	34.0	1.57

HICKORY - LINK HANDLES



**ALL PRODUCTS ON THIS PAGE
ARE MADE IN THE USA (UNLESS NOTED)**

PICK, MATTOCK & GRUB HOE HANDLES (cont.)

SMALL EYE GRUB HOE HANDLES

For 3 lb. grub hoes, No. 9 eye 2-1/2" x 1-7/8"



Model	Length	UPC 0 25545 +	Pack qty	Pack wgt	Pack cube
65119 / 213-19	40"	21319-7	12	32.0	1.66

SMALL EYE ITALIAN GRAPE HOE HANDLE

For 2E-IG7 Italian grape hoe, 2" x 1-5/8"



Model	Length	UPC 0 25545 +	Pack qty	Pack wgt	Pack cube
65126 / 216-19	40"	21619-8	12	32.0	1.57

RAILROAD OR CLAY PICK OR MATTOCK HANDLES

For 5 lb. and heavier picks and mattocks, No. 6 eye 3" x 2"



Model	Length	UPC 0 25545 +	Pack qty	Pack wgt	Pack cube
65030 / 220-01	36"	22001-0	12	30.0	1.37
65031 / 220-02	36"	22002-7	12	30.0	1.37
65033 / 220-04	36"	22004-1	12	30.0	1.37
65035 / 220-08	36"	22008-9	12	30.0	1.37
65039 / 220-09	36"	22009-6	12	30.0	1.37
63025 / 220-19	36"	22019-5	12	30.0	1.37

GARDEN OR NURSERY MATTOCK HANDLES

For 3 lb. mattocks, No. 7 eye 2-3/4" x 1-3/4"



Model	Length	UPC 0 25545 +	Pack qty	Pack wgt	Pack cube
65058 / 240-04	36"	24004-9	12	25.0	0.92
65059 / 240-08	36"	24008-7	12	25.0	0.92
65060 / 240-19	36"	24019-3	12	25.0	0.92

MATTOCK HANDLE

For Laurel, Dig-Ezy, Southern Queen pattern mattocks, 1-1/2" round eye



Model	Length	UPC 0 25545 +	Pack qty	Pack wgt	Pack cube
66689 / 813-21	54"	81321-2	6	9.0	0.61

STRIKING TOOL HANDLES

SLEDGE OR MAUL HANDLES

Oval eye 1-1/4" x 1"



Model	Length	UPC 0 25545 +	Pack qty	Pack wgt	Pack cube
64403 / 001-01	36"	00101-5	12	18.0	0.74
64407 / 001-02	36"	00102-2	12	18.0	0.74

64409 / 001-04	36"	00104-6	12	18.0	0.74
64412 / 001-08	36"	00108-4	12	18.0	0.74
64417 / 001-09	36"	00109-1	12	18.0	0.74
64419 / 001-19	36"	00119-0	12	18.0	0.74
64536 / 002-01	32"	00201-2	12	16.0	0.60
64537 / 002-02	32"	00202-9	12	16.0	0.60
64538 / 002-08	32"	00208-1	12	16.0	0.60
64542 / 002-19	32"	00219-7	12	16.0	0.60

For 6 to 8 lb. sledge or striking hammers

64547 / 003-02	30"	00302-6	12	14.0	0.66
64548 / 003-04	30"	00304-0	12	14.0	0.66
64549 / 003-08	30"	00308-8	12	14.0	0.66
64552 / 003-19	30"	00319-4	12	14.0	0.66
64558 / 004-01	24"	00401-6	12	10.0	0.60
64559 / 004-08	24"	00408-5	12	10.0	0.60
64563 / 004-19	24"	00419-1	12	10.0	0.60
64441 / 009-19	36"	00919-6	12	18.0	0.60

HEAVY AND EXTRA HEAVY SLEDGE HANDLES



Model	Length	UPC 0 25545 +	Pack qty	Pack wgt	Pack cube
For 18 to 24 lb. heavy sledges, eye 1-1/2" x 1-1/4"					
64645 / 010-02	36"	01002-4	12	20.0	0.92
64650 / 010-09	36"	01009-3	12	20.0	0.92
64652 / 010-19	36"	01019-2	12	20.0	0.92
64574 / 023-19	32"	02319-2	12	18.0	0.60

For extra heavy sledges, eye 1-3/4" x 1-1/4"

64659 / 015-02	36"	01503-6	12	22.0	0.92
64662 / 015-19	36"	01519-7	12	22.0	0.92

STRAIGHT DOUBLE BIT EYE SPLITTING MAUL HANDLES

No. 5 eye 2-1/8" x 7/8"



Model	Length	UPC 0 25545 +	Pack qty	Pack wgt	Pack cube
64765 / 205-02	36"	20502-4	12	18.0	0.92
64766 / 205-04	36"	20504-8	12	18.0	0.92
64767 / 205-08	36"	20508-6	12	18.0	0.92
64768 / 205-19	36"	20519-2	12	18.0	0.92

STRAIGHT SINGLE BIT EYE SPLITTING MAUL & BUSH HOOK HANDLES

Eye 2-5/16" x 13/16"



Model	Length	UPC 0 25545 +	Pack qty	Pack wgt	Pack cube
64772 / 206-02	36"	20602-1	12	18.0	0.92
64773 / 206-04	36"	20604-6	12	18.0	0.92
64774 / 206-08	36"	20608-3	12	18.0	0.92
64777 / 206-19	36"	20619-9	12	18.0	0.92

LINK HANDLES - HICKORY

STRIKING TOOL HANDLES (cont.)

CARPENTER'S ADZE HANDLES

For house or railroad carpenter's adze, eye 2-5/16" x 1-1/2"



Model	Length	UPC 0 25545 +	Pack qty	Pack wgt	Pack cube
65130 / 224-02	36"	22402-5	12	20.0	0.92
65132 / 224-19	36"	22419-3	12	20.0	0.92

POST MAUL HANDLES



Model	Length	UPC 0 25545 +	Pack qty	Pack wgt	Pack cube
For cast iron mauls, eye 2" x 1-7/16"					
65136 / 228-01	36"	22801-6	12	20.0	0.92
65138 / 228-19	36"	22819-1	12	20.0	0.92
For cast iron mauls, eye 2-1/4" x 1-11/16"					
65140 / 229-08	36"	22908-2	12	20.0	0.92
65141 / 229-19	36"	22919-8	12	20.0	0.92

DITCH BANK BLADE HANDLES

DITCH BANK BLADE HANDLES



Model	Length	UPC 0 25545 +	Pack qty	Pack wgt	Pack cube
For 4-hole blades					
65220 / 255-19	40"	25519-7	12	22.9	1.02
For 3-hole blades					
65227 / 260-08	40"	26008-5	12	22.8	1.02
65228 / 260-19	40"	26019-1	12	22.8	1.02
65236 / 262-19	36"	26219-5	12	21.9	0.92

CLAW HAMMER HANDLES

CLAW, RIPPING, NAIL HAMMER HANDLES



Model	Length	UPC 0 25545 +	Pack qty	Pack wgt	Pack cube
For 16 oz. hammers, eye 1-1/16" x 9/16"					
65382 / 300-02	14"	30002-6	12	5.0	0.20
65383 / 300-04	14"	30004-0	12	5.0	0.20
65386 / 300-08	14"	30008-8	12	5.0	0.20
65388 / 300-09	14"	30009-5	12	5.0	0.20
65392 / 300-19	14"	30019-4	12	5.0	0.20
For 16 oz. and some 20 oz. hammers, eye 1-1/16" x 9/16"					
65402 / 302-02	16"	30202-0	12	6.5	0.21
65403 / 302-04	16"	30204-4	12	6.5	0.21



ALL PRODUCTS ON THIS PAGE
ARE MADE IN THE USA (UNLESS NOTED)

For 20, 22, and 24 oz. hammers, eye 1-1/16" x 5/8"

65412 / 310-02	14"	31002-5	12	5.0	0.18
65415 / 312-02	16"	31202-9	12	6.5	0.21
65416 / 312-04	16"	31204-3	12	6.5	0.21
65417 / 312-08	16"	31208-1	12	6.5	0.21
65419 / 312-19	16"	31219-7	12	6.5	0.21
65424 / 313-19	18"	31319-4	12	7.0	0.25

For 28 to 32 oz. hammers, eye 1-3/16" x 3/4"

65426 / 321-02	16"	32102-1	12	6.5	0.33
65427 / 321-08	16"	32108-3	12	6.5	0.33
65428 / 321-19	16"	32119-9	12	6.5	0.33
65430 / 322-04	18"	32204-2	12	8.0	0.32
65431 / 322-19	18"	32219-6	12	8.0	0.32

For 13 oz. hammers, eye 1" x 1/2"

65435 / 325-02	13"	32502-9	12	4.0	0.18
65436 / 325-04	13"	32504-3	12	4.0	0.18
65437 / 325-08	13"	32508-1	12	4.0	0.18
65438 / 325-09	13"	32509-8	12	4.0	0.18
65440 / 325-19	13"	32519-7	12	4.0	0.18

For 7 oz. hammers, eye 7/8" x 1/2"

65445 / 327-04	12"	32704-7	12	3.0	0.12
65447 / 327-09	12"	32709-2	12	3.0	0.12
65449 / 327-19	12"	32719-1	12	3.0	0.12

CLAW, RIPPING, NAIL OCTAGON BODY HAMMER HANDLES

For octagon body, 16 oz. hammers, eye 1-1/16" x 9/16"



Model	Length	UPC 0 25545 +	Pack qty	Pack wgt	Pack cube
65406 / 304-02	14"	30402-4	12	5.0	0.18
65407 / 304-08	14"	30408-6	12	5.0	0.18
65409 / 304-19	14"	30419-2	12	5.0	0.18

BALL PEIN HAMMER HANDLES

BALL PEIN MACHINIST HAMMER HANDLES



Model	Length	UPC 0 25545 +	Pack qty	Pack wgt	Pack cube
For 2 oz. hammers, eye 7/16" x 1/4"					
65530 / 400-19	10"	40019-1	12	2.0	0.12
For 4 to 6 oz. hammers, eye 9/16" x 5/16"					
65535 / 401-19	10"	40119-8	12	2.5	0.12
For 8 to 12 oz. hammers, eye 3/4" x 7/16"					
65539 / 403-02	12"	40302-4	12	3.0	0.12
65541 / 403-04	12"	40304-8	12	3.0	0.12
65544 / 403-08	12"	40308-6	12	3.0	0.12
65546 / 403-09	12"	40309-3	12	3.0	0.12
65548 / 403-19	12"	40319-2	12	3.0	0.12
For 16 to 20 oz. hammers, 29/32" x 17/32"					
65559 / 405-02	14"	40502-8	12	4.0	0.18
65560 / 405-04	14"	40504-2	12	4.0	0.18
65562 / 405-08	14"	40508-0	12	4.0	0.18
65565 / 405-09	14"	40509-7	12	4.0	0.18
65569 / 405-19	14"	40519-6	12	4.0	0.18

HICKORY - LINK HANDLES



**ALL PRODUCTS ON THIS PAGE
ARE MADE IN THE USA** (UNLESS NOTED)

BALL PEIN HAMMER HANDLES (cont.)

For 24 to 28 oz. hammers, 1-1/16" x 19/32"

65578 / 407-02	16"	40702-2	12	5.0	0.21
65579 / 407-04	16"	40704-6	12	5.0	0.21
65581 / 407-08	16"	40708-4	12	5.0	0.21
65583 / 407-09	16"	40709-1	12	5.0	0.21
65586 / 407-19	16"	40719-0	12	5.0	0.21

For 32 to 48 oz. hammers, eye 1-3/16" x 11/16"

65592 / 409-02	18"	40902-6	12	6.0	0.25
65594 / 409-08	18"	40908-8	12	6.0	0.25
65596 / 409-09	18"	40909-5	12	6.0	0.25
65598 / 409-19	18"	40919-4	12	6.0	0.25

TIRE HAMMER HANDLES

TIRE HAMMER HANDLES FOR KEN TOOL HAMMERS



Model	Length	UPC 0 25545 +	Pack qty	Pack wgt	Pack cube
Safety grip, for T11, T11C, T34, T35, and T36, eye 1-13/16" x 1-15/16"					
65360 / 474-23	17"	47423-9	12	10.0	0.31
Safety grip, for T11E, eye 1-13/16" x 1-11/16"					
65364 / 477-23	30"	47723-0	12	20.0	0.54



Non-slip grip, for T11, T11C, T34, T35, and T36
eye 1-3/16" x 1-5/16"

65361 / 474-55	17"	47455-0	12	10.0	0.31
65365 / 477-55	30"	47755-1	12	20.0	0.54

SHORT SLEDGE AND OTHER HAMMER HANDLES

ENGINEER'S HAMMER HANDLES, OVAL EYE



Model	Length	UPC 0 25545 +	Pack qty	Pack wgt	Pack cube
For 1-1/2 to 2-1/2 lb. hammers, eye 7/8" x 5/8"					
65768 / 435-19	12"	43519-3	12	4.0	0.18
65697 / 421-02	14"	42102-8	12	4.0	0.22
65701 / 421-19	14"	42119-6	12	4.0	0.22
For 3 to 4 lb. hammers, eye 1" x 3/4"					
65710 / 423-01	16"	42301-5	12	5.0	0.21
65711 / 423-02	16"	42302-2	12	5.0	0.21
65712 / 423-04	16"	42304-6	12	5.0	0.21
65714 / 423-08	16"	42308-4	12	5.0	0.21
65716 / 423-09	16"	42309-1	12	5.0	0.21
65720 / 423-19	16"	42319-0	12	5.0	0.21
For 3 to 4 lb. hammers, eye 1" x 3/4"					
65737 / 424-19	18"	42419-7	12	6.0	0.25

BLACKSMITH HAMMER HANDLES, FLAT EYE

For 2 to 3 lb. hammers, eye 1-3/16" x 11/16"



Model	Length	UPC 0 25545 +	Pack qty	Pack wgt	Pack cube
65741 / 430-01	14"	43001-3	12	4.5	0.23
65742 / 430-02	14"	43002-0	12	4.5	0.23
65743 / 430-04	14"	43004-4	12	4.5	0.23
65744 / 430-08	14"	43008-2	12	4.5	0.23
65746 / 430-19	14"	43019-8	12	4.5	0.23

For 3.5 lb. and heavier hammers, eye 1-1/4" x 1"

65748 / 432-02	16"	43202-4	12	6.0	0.30
65749 / 432-04	16"	43204-8	12	6.0	0.30
65751 / 432-19	16"	43219-2	12	6.0	0.30

For 3.5 lb. and heavier hammers, eye 1-1/4" x 1"

65758 / 433-02	18"	43302-1	12	7.0	0.33
65759 / 433-04	18"	43304-6	12	7.0	0.33
65760 / 433-08	18"	43308-3	12	7.0	0.33
65762 / 433-09	18"	43309-0	12	7.0	0.33
65764 / 433-19	18"	43319-9	12	7.0	0.33

BRICK HAMMER HANDLES

For brick hammers and scutches, eye 1-1/16" x 19/32"



Model	Length	UPC 0 25545 +	Pack qty	Pack wgt	Pack cube
65782 / 440-19	12"	44019-7	12	5.0	0.18

STONE MASON HAMMER HANDLES

Oval eye 1-1/8" x 5/8"



Model	Length	UPC 0 25545 +	Pack qty	Pack wgt	Pack cube
65868 / 451-19	16"	45119-3	12	5.5	0.28

HAND DRILL AND SLEDGE HAMMER HANDLES

For 2 to 4 lb. hammers, oval eye 1" x 3/4"



Model	Length	UPC 0 25545 +	Pack qty	Pack wgt	Pack cube
65993 / 480-02	10-1/2"	48002-5	12	5.0	0.23
65994 / 480-19	10-1/2"	48019-3	12	5.0	0.23
66004 / 481-19	12"	48119-0	12	6.0	0.21

LINK HANDLES - HICKORY & FILE HANDLES

SHORT SLEDGE AND OTHER HAMMER HANDLES (cont.)

STRAIGHT CALIFORNIA FRAMING HAMMER HANDLES



Model	Length	UPC	0 25545 +	Pack qty	Pack wgt	Pack cube
For 23 oz. Hart hammers, eye 1-5/8" x 11/16"						
65898 / 1172-02	18"	00643-3		12	6.0	0.33
65899 / 1172-04	18"	00593-8		12	6.0	0.33
For 23 oz. Vaughn & Bushnell hammers, eye 1-11/16" x 11/16"						
65902 / 6321-19	18"	03957-5		12	6.0	0.33

CURVED CALIFORNIA FRAMING HAMMER HANDLES

For 25 oz. hammers, eye 1-11/16" x 11/16"



Model	Length	UPC	0 25545 +	Pack qty	Pack wgt	Pack cube
65905 / 7078-19	18"	06493-5		12	7.0	0.33

HATCHET HANDLES

HATCHET HANDLES



Model	Length	UPC	0 25545 +	Pack qty	Pack wgt	Pack cube
For No. 2 shingling, half-hatchet, claw, and No. 1 broad hatchets, eye 1-19/32" x 19/32"						
65273 / 330-02	14"	33002-3		12	6.0	0.23
65274 / 330-04	14"	33004-7		12	6.0	0.23
65275 / 330-08	14"	33008-5		12	6.0	0.23
65276 / 330-09	14"	33009-2		12	6.0	0.23
65278 / 330-19	14"	33019-1		12	6.0	0.23
For No. 3 and 4 broad hatchets and linesmen's hatchets, eye 1-13/16" x 5/8"						
65282 / 334-04	16"	33404-5		12	8.0	0.28
65283 / 334-09	16"	33409-0		12	8.0	0.28
65285 / 334-19	16"	33419-9		12	8.0	0.28

PLUMB EXPERT HATCHET HANDLES

For plumb, box, wallboard, and California lathe hatchets eye 1-1/4" x 1/2"



Model	Length	UPC	0 25545 +	Pack qty	Pack wgt	Pack cube
65288 / 350-02	14"	35002-1		12	5.0	0.23
65289 / 350-19	14"	35019-9		12	5.0	0.23



ALL PRODUCTS ON THIS PAGE ARE MADE IN THE USA (UNLESS NOTED)

RIG BUILDER'S (RIGSTER) HATCHET HANDLES

For rig hatchets, eye 1-9/16" x 5/8"



Model	Length	UPC	0 25545 +	Pack qty	Pack wgt	Pack cube
65292 / 365-02	18"	36502-5		12	7.0	0.33
65293 / 365-19	18"	36519-3		12	7.0	0.33

BOY SCOUT AXE HANDLES



Model	Length	UPC	0 25545 +	Pack qty	Pack wgt	Pack cube
For 1-1/4 lb. axes, eye 1-5/8" x 19/32"						
65295 / 368-02	14"	36802-6		12	6.0	0.28
65296 / 368-04	14"	36804-0		12	6.0	0.28
65297 / 368-08	14"	36808-8		12	6.0	0.28
65300 / 368-19	14"	36819-4		12	6.0	0.28
For 1-3/4 lb. axes, 1-3/4" x 11/16"						
65309 / 369-19	16"	36919-1		12	7.0	0.33

FILE HANDLES

LONG FERRULE FILE HANDLES



Model	Length	UPC	0 25545 +	Pack qty	Pack wgt	Pack cube
4" x 1" (size No. 1) for 3" to 6" files						
64223 / 29541-00	4"	00018-6		36	2.0	0.06
4-1/2" x 1-3/16" (size No. 2) for 6" to 8" files						
64224 / 29542-00	4-1/2"	00019-3		36	4.0	0.10
5" x 1-5/16" (size No. 3) for 8" to 12" files						
64225 / 29543-00	5"	00020-9		36	5.3	0.12
5-1/2" x 1-7/16" (size No. 4) for 12" to 16" files						
64227 / 29544-00	5-1/2"	00021-6		36	7.0	0.18
6" x 1-9/16" (size No. 5) for 16" to 20" files						
64229 / 29545-00	6"	00022-3		36	9.0	0.21

LINK HANDLES®

FILE HANDLES & WEDGES - LINK HANDLES

FILE HANDLES (cont.)

SHORT FERRULE FILE HANDLES



Model	Length	UPC 0 25545 +	Pack qty	Pack wgt	Pack cube
3-1/2" x 13/16" (size No. 00), bore 1/8", for chain saws					
64240 / 31559-00	3-1/2"	00024-7	36	1.5	0.12
3-1/2" x 13/16" (size No. 01), bore 5/32", for 3" to 4" files					
64241 / 31561-00	3-1/2"	00025-4	36	1.5	0.12
4" x 15/16" (size No. 02), bore 3/16", for 4" to 6" files					
64242 / 31562-00	4"	00026-1	36	2.0	0.09
4-1/4" x 1-3/64" (size No. 03), bore 7/32", for 6" to 8" files					
64243 / 31563-00	4-1/4"	00027-8	36	2.5	0.12
4-3/4" x 1-1/8" (size No. 04), bore 9/32", for 8" to 10" files					
64244 / 31564-00	4-3/4"	00028-5	36	3.5	0.15
5" x 1-1/4" (size No. 05), bore 3/8", for 10" to 14" files					
64245 / 31565-00	5"	00029-2	36	4.0	0.14

TITEGRIP SCREW-ON FILE HANDLES

A screw on handle that makes its own thread on tang of file



Model	Length	UPC 0 25545 +	Pack qty	Pack wgt	Pack cube
For 4" files					
64232 / 30571-00		00032-2	36	1.5	0.05
For 5" files					
64234 / 30572-00		00033-9	36	3.0	0.09
For 6" files					
64231 / 30569-00		00034-6	36	3.0	0.07
For 8" files					
64235 / 30573-00		00035-3	36	5.0	0.13
For 10" files					
64236 / 30574-00		00036-0	36	5.0	0.13
For 12" files and rasps					
64238 / 30576-00		00037-7	36	7.3	0.19
For 14" files and rasps					
64237 / 30575-00		00038-4	36	7.3	0.19

NO. 10 FILE CARD

The sharp steel bristles quickly remove filings from file grooves



Model	Length	UPC 0 25545 +	Pack qty	Pack wgt	Pack cube
64246 / 324-00	8"	32400-8	12	2.0	0.07



ALL PRODUCTS ON THIS PAGE
ARE MADE IN THE USA (UNLESS NOTED)

HANDLE WEDGES

WOOD AND STEEL WEDGES

Each package contains 1 wood wedge and 2 steel wedges. Color coded for display. Includes step-by-step instructions and diagrams.



Model	Color	UPC 0 25545 +	Pack qty	Pack wgt	Pack cube
Hammer handle wedges					
64128 / 04510-00	Blue	00001-8	24	1.3	0.12
Hatchet handle wedges					
64131 / 04511-00	Green	00002-5	24	1.3	0.12
Sledge and maul handle wedges					
64133 / 04512-00	Red	00003-2	24	1.5	0.12
Axe handle wedges					
64136 / 04513-00	Brown	00004-9	24	2.0	0.12
Boxed assortment with 24 wood and steel wedges (6 each of all sizes)					
64139 / 04514-00		00005-6	1	1.8	

CORRUGATED STEEL WEDGES



Model	Package wgt	UPC 0 25545 +	Pack qty	Pack wgt	Pack cube
Hammer handle wedges, No. 2, 5/16" W x 13/16" H, 36 per package					
64144 / 50-490	3 oz.	00006-3	1	0.2	0.07
Carpenter's hammer handle wedges, No. 3, 1/2" W x 1-1/16" H, 36 per package					
64145 / 50-491	9 oz.	00007-0	1	0.6	0.07
Large hammer handle wedges, No. 4, 3/4" W x 1-1/16" H, 36 per package					
64146 / 50-492	10 oz.	00008-7	1	0.6	0.07
Sledge hammer handle wedges, No. 5, 1" W x 1-1/16" H, 36 per package					
64147 / 50-493	12 oz.	00009-4	1	0.8	0.07
Axe handle wedges, No. 18, 1-1/4" W x 1-3/16" H, 12 per package					
64148 / 50-494	10 oz.	00010-0	1	0.6	0.07

LINK HANDLES - WEDGES

HANDLE WEDGES (cont.)

STEEL WEDGE AND RIVET ASSORTMENT IN COUNTER DISPLAY



Assortment includes 252 pieces plus display box. Contains 12 LR1 and 12 LR2 round wedges; 36 #2, 36 #3, 36 #4, 36 #5, and 12 #18 flat steel wedges; plus 72 rivets.

Model	UPC 0 25545 +	Pack qty	Pack wgt	Pack cube
64149 / 50-497	00011-7	1	3.0	0.07

WOOD WEDGES

Each package contains 12 wood wedges. Includes step-by-step instructions and diagrams.



Model	Package wgt	UPC 0 25545 +	Pack qty	Pack wgt	Pack cube
Single bit axe handle wedges, No. 2WW, 2-1/2" W x 2-1/2" H					
64151 / 13-390	5.0	00012-4	12	2.1	0.18
Sledge handle wedges, No. 3WW, 1-3/8" W x 2-1/2" H					
64153 / 13-391	2.7	00013-1	12	1.3	0.18
Machinist hammer handle wedges, No. 4WW, 1-1/16" W x 1-1/2" H					
64155 / 13-392	0.8	00014-8	12	0.5	0.08
Hatchet handle wedges, No. 8WW, 1-5/8" W x 2" H					
64157 / 13-393	3.4	00015-5	12	1.6	0.18
Double bit axe handle wedges, No. 9WW, 3" W x 2-1/2" H					
64158 / 13-394	5.5	00016-2	12	2.5	0.18
Nail hammer handle wedges, No. 10WW, 1-3/16" W x 1-1/2" H					
64159 / 13-395	0.8	00017-9	12	0.5	0.08



ALL PRODUCTS ON THIS PAGE ARE MADE IN THE USA (UNLESS NOTED)

ROUND (CONE-SHAPED) STEEL WEDGES

- Expands wood equally in all directions for tightest fit.
- Provides better holding power than flat wedges.
- Eliminates need for flat wood and steel wedges.
- Two sizes fit every need.

Contoured top rim helps keep wedge in place

Beveled bottom rim shears wood fibers and compresses them toward the center

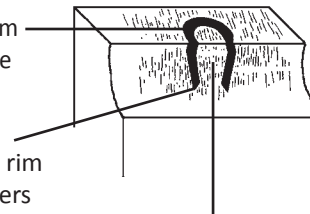

Wood expands into interior of wedge to create a secure and safe grip

ROUND STEEL WEDGES, RETAIL PACK

Each retail package contains 2 round steel wedges. Includes step-by-step instructions and diagrams.



Model	Package wgt	UPC 0 25545 +	Pack qty	Pack wgt	Pack cube
LR1 round steel wedges, 9/16" H x 9/16" diameter					
64140 / 06903-00	0.7	06903-9	6	0.5	0.08
LR2 round steel wedges, 3/4" H x 3/4" diameter					
64142 / 06905-00	1.1	16905-0	6	0.6	0.08

ROUND STEEL WEDGES, BULK PACK

Each bulk package contains 12 round steel wedges.



Model	Package wgt	UPC 0 25545 +	Pack qty	Pack wgt	Pack cube
LR1 round steel wedges, 9/16" H x 9/16" diameter					
64141 / 06904-00	3.7	16904-3	12	1.5	0.05
LR2 round steel wedges, 3/4" H x 3/4" diameter					
64143 / 06906-00	6.1	16906-7	12	2.4	0.05

FIBERGLASS - LINK HANDLES

HEAVY-DUTY FIBERGLASS HANDLES

SLEDGE AND MAUL FIBERGLASS HANDLE

001 is for 6 to 16 lb. and some 18 to 24 lb. sledges and mauls. 010 is for heavy sledges. Handle comes with epoxy kit.



Model	Length	UPC 0 25545 +	Pack qty	Pack wgt	Pack cube
64430 / 001-99	34"	00199-2	6	13.0	0.74
64657 / 010-99	36"	01099-4	6	15.6	0.85

SINGLE BIT AXE FIBERGLASS HANDLE

For 3 to 5 lb. single bit axes. Handle comes with epoxy kit.



Model	Length	UPC 0 25545 +	Pack qty	Pack wgt	Pack cube
64718 / 100-99	34"	10099-2	6	14.0	0.92

DOUBLE BIT AXE FIBERGLASS HANDLE

For 3 to 5 lb. double bit axes. Handle comes with epoxy kit.



Model	Length	UPC 0 25545 +	Pack qty	Pack wgt	Pack cube
64749 / 140-99	34"	06932-9	6	14.0	0.92

RAILROAD AND GARDEN PICK FIBERGLASS HANDLE

220 is for railroad No. 6 eye picks and mattocks. 200 is for 2.5 lb. mattocks with #10 eye. Centrifugal force tightens head so no epoxy needed. 221 is for 2.5 lb. mattocks with 2-1/4" x 1-1/2" slip eye.



Model	Length	UPC 0 25545 +	Pack qty	Pack wgt	Pack cube
64764 / 200-99	36"	20099-9	6	14.6	1.20
65053 / 220-99	36"	06933-6	6	16.0	1.37
65057 / 221-99	36"	22199-4	6	16.0	1.30



63007 Structron fiberglass pick/mattock handle

- Nylon head (handle only)
- 36" poly coated handle

CLAW HAMMER FIBERGLASS HANDLE

Handle comes with epoxy kit.



Model	Length	UPC 0 25545 +	Pack qty	Pack wgt	Pack cube
65399 / 300-99	14"	06929-9	6	4.0	0.20

ENGINEER'S AND BLACKSMITH'S HAMMER FIBERGLASS HANDLE

Handle comes with epoxy kit.



Model	Length	UPC 0 25545 +	Pack qty	Pack wgt	Pack cube
65725 / 423-99	15"	42399-2	6	7.0	0.20
65998 / 480-99	10.5"	48099-5	6	2.6	0.15

SHOVEL FIBERGLASS HANDLE

For hollowback and closed back shovels. Handle comes with rivet.



Model	Length	UPC 0 25545 +	Pack qty	Pack wgt	Pack cube
66770 / 870-99	46"	06940-4	6	14.0	0.53

D-GRIP SHOVEL FIBERGLASS HANDLE

For D-grip hollowback and closed back shovels. Handle comes with rivet.

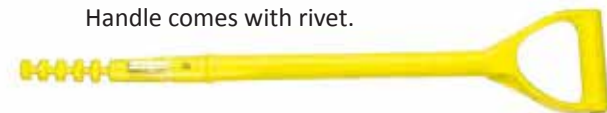

Model	Length	UPC 0 25545 +	Pack qty	Pack wgt	Pack cube
66776 / 871-99	27"	06931-2	6	10.0	0.68

EPOXY KIT

For attaching fiberglass handles



Model	Length	UPC 0 25545 +	Pack qty	Pack wgt	Pack cube
64112 / 7001-00		04033-5	6	2.0	0.11

LINK HANDLES - ASH

FORK HANDLES

STRAIGHT HAY FORK HANDLES

1-7/16" diameter, 7/16" bore, 8" ferrule



Model	Length	UPC 0 25545 +	Pack qty	Pack wgt	Pack cube
66560 / 700-21	48"	70021-5	6	11	0.53
66561 / 701-21	54"	70121-2	6	12	0.51
66562 / 702-21	60"	70221-9	6	14	0.55

BENT HAY, 3-TINE HEADER, AND ALFALFA FORK HANDLES

1-7/16" diameter, 7/16" bore, 8" ferrule



Model	Length	UPC 0 25545 +	Pack qty	Pack wgt	Pack cube
66564 / 706-21	48"	70621-7	6	11	0.53
66566 / 707-21	54"	70721-4	6	12	0.61
66568 / 708-21	60"	70821-1	6	14	0.55

BENT MANURE AND BARLEY FORK HANDLES

1-7/16" diameter, 1/2" bore, 8" ferrule



Model	Length	UPC 0 25545 +	Pack qty	Pack wgt	Pack cube
66574 / 715-18	48"	71518-9	6	11	0.53
66575 / 715-21	48"	71521-9	6	11	0.53
66580 / 716-21	54"	71621-6	6	12	0.61
66585 / 717-21	60"	71721-3	6	13	0.55

BENT SPADING FORK HANDLES

1-1/2" diameter, 5/8" bore, 8" ferrule



Model	Length	UPC 0 25545 +	Pack qty	Pack wgt	Pack cube
66570 / 711-21	48"	71121-1	6	13	0.53
66806 / 922-21	54"	92221-1	6	14	0.61

BENT SPADING FORK HANDLE, STEEL D-GRIP

1-1/2" diameter, 5/8" bore, 8" ferrule



(not made in the USA)

Model	Length	UPC 0 25545 +	Pack qty	Pack wgt	Pack cube
66595 / 730-21	30"	73021-2	6	13	0.68



ALL PRODUCTS ON THIS PAGE ARE MADE IN THE USA (UNLESS NOTED)

BENT MANURE FORK, CLAM FORK, BARLEY FORK, AND SOD LIFTER HANDLES, STEEL D-GRIP



(not made in the USA)

Model	Length	UPC 0 25545 +	Pack qty	Pack wgt	Pack cube
66599 / 731-21	32"	73121-9	6	13	0.68
66601 / 736-21	36"	73621-4	6	14	0.68

BENT SEED, COKE, ENSILAGE, AND HEAVY MANURE FORK HANDLES, STEEL D-GRIP

1-1/2" diameter, 11/16" bore, 8" ferrule



(not made in the USA)

Model	Length	UPC 0 25545 +	Pack qty	Pack wgt	Pack cube
66592 / 728-21	30"	72821-9	6	13	0.68
66600 / 734-21	32"	73421-0	6	14	0.68

HOE & HOOK HANDLES

EYE HOE AND FIRE RAKE HANDLE

1-3/4" round eye



Model	Length	UPC 0 25545 +	Pack qty	Pack wgt	Pack cube
66678 / 810-21	54"	81021-1	6	11	0.77
66681 / 811-18	60"	81118-8	6	12	0.86
66682 / 811-21	60"	81121-8	6	12	0.86

POTATO HOOK HANDLES

1-7/16" diameter, 1/2" bore, 4" ferrule



Model	Length	UPC 0 25545 +	Pack qty	Pack wgt	Pack cube
66826 / 977-21	48"	97721-1	6	10	0.55
66827 / 978-21	54"	97821-8	6	11	0.61



**ALL PRODUCTS ON THIS PAGE
ARE MADE IN THE USA** (UNLESS NOTED)

HOE & HOOK HANDLES (cont.)

GARDEN HOE HANDLES

1-1/4" diameter, 3/8" bore, 4" ferrule. Also used for meadow hoes, light cotton hoes, light scuffle hoes, light hooks, stone hooks, and light potato hooks.



Model	Length	UPC 0 25545 +	Pack qty	Pack wgt	Pack cube
66607 / 741-21	48"	74121-8	6	8	0.98
66611 / 742-21	52"	74221-5	6	8	0.50
66615 / 743-21	54"	74321-2	6	9	0.50
66618 / 744-21	60"	74421-9	6	9	0.55

GARDEN HOE, MEADOW HOE, LIGHT COTTON HOE HANDLES

1-1/4" diameter, 3/8" bore, chucked



Model	Length	UPC 0 25545 +	Pack qty	Pack wgt	Pack cube
66621 / 746-21	52"	74621-3	6	8	0.50
66623 / 747-21	54"	74721-0	6	8	0.50
66627 / 748-21	60"	74821-7	6	9	0.55

SOCKET PATTERN HOE HANDLES

1-1/4" diameter, chucked



Model	Length	UPC 0 25545 +	Pack qty	Pack wgt	Pack cube
66639 / 756-21	52"	75621-2	6	8	0.50
66643 / 757-21	54"	75721-9	6	8	0.50
66644 / 758-21	60"	75821-6	6	9	0.55

HEAVY COTTON HOE AND SCRAPER HANDLES, WITH FERRULES

1-3/8" diameter, 7/16" bore, chucked, 4" ferrule



Model	Length	UPC 0 25545 +	Pack qty	Pack wgt	Pack cube
66631 / 752-21	54"	75221-4	6	9	0.50
66635 / 753-21	60"	75321-1	6	11	0.55

HEAVY COTTON HOE HANDLE, WITHOUT FERRULE

1-3/8" diameter, 7/16" bore, chucked, no ferrule



Model	Length	UPC 0 25545 +	Pack qty	Pack wgt	Pack cube
66646 / 760-21	54"	76021-9	6	8	0.50

PLANTER'S HOE HANDLE

1-7/16" diameter, 9/16" bore, 4" ferrule



Model	Length	UPC 0 25545 +	Pack qty	Pack wgt	Pack cube
66603 / 739-21	60"	73921-5	6	11	0.55

MORTAR HOE, SCUFFLE HOE, HEAVY HOOK, ROAD RAKE, ASPHALT RAKE, TAR RAKE, ETC. HANDLE

1-7/16" diameter, 9/16" bore, chucked, 8" ferrule



Model	Length	UPC 0 25545 +	Pack qty	Pack wgt	Pack cube
66647 / 765-21	60"	76521-4	6	15	0.55
66649 / 767-21	72"	76721-8	6	17	0.55

MORTAR HOE, SCUFFLE HOE, HEAVY HOOK, ROAD RAKE, AND PINE NEEDLE RAKE HANDLE

1-7/16" diameter, 9/16" bore, 4" ferrule



Model	Length	UPC 0 25545 +	Pack qty	Pack wgt	Pack cube
66651 / 780-21	60"	78021-7	6	30	0.55

HEAVY SOCKET COTTON HOE & SIDEWALK SCRAPER HANDLE

1-3/8" diameter, chucked



Model	Length	UPC 0 25545 +	Pack qty	Pack wgt	Pack cube
66807 / 924-21	60"	92421-5	6	10	0.55

RAKE HANDLES (not made in the USA)

LAWN AND LEAF RAKE HANDLES

15/16" diameter, 2-1/2" chuck to 5/8"



Model	Length	UPC 0 25545 +	Pack qty	Pack wgt	Pack cube
66454 / 22-342	42"	05385-4	6	5	0.98
66455 / 22-348	48"	04806-5	6	6	0.98
66460 / 22-351	51"	04803-4	6	6	0.29
66464 / 22-360	60"	05095-2	6	7	0.86

LAWN AND LEAF RAKE HANDLES

15/16" diameter, straight end, 9/32" cross drill 1-5/8" from end



Model	Length	UPC 0 25545 +	Pack qty	Pack wgt	Pack cube
66491 / 22-604	54"	05240-6	12	11.2	1.06

LINK HANDLES - ASH

RAKE HANDLES (not made in the USA)

LEVEL HEAD RAKE AND GARDEN HOE HANDLE

1-1/4" diameter, 3/8" bore, turned end ferrule



Model	Length	UPC 0 25545 +	Pack qty	Pack wgt	Pack cube
66656 / 790-21	60"	79021-6	6	10	0.55

LEVEL HEAD RAKE HANDLE

1-1/4" diameter, 3/8" bore, chucked



Model	Length	UPC 0 25545 +	Pack qty	Pack wgt	Pack cube
66664 / 794-21	60"	79421-4	6	9	0.55

BOW RAKE HANDLE

1-1/4" diameter, 4" ferrule, 7/16" bore



Model	Length	UPC 0 25545 +	Pack qty	Pack wgt	Pack cube
66668 / 797-21	60"	79721-5	6	10	0.55

SCRAPER HANDLES

SIDEWALK SCRAPER HANDLE

1-3/8" socket style, 3-7/8" chuck



Model	Length	UPC 0 25545 +	Pack qty	Pack wgt	Pack cube
66802 / 905-21	48"	90521-4	6	9	0.53

BARN SCRAPER HANDLE

1-7/16" diameter, 7/16" bore, 8" ferrule



Model	Length	UPC 0 25545 +	Pack qty	Pack wgt	Pack cube
66808 / 930-21	60"	93021-6	6	15	0.86

AUGER, DRAIN TILE AND POST HOLE DIGGER HANDLES

AUGER HANDLE

For augers with cross T handles



Model	Length	UPC 0 25545 +	Pack qty	Pack wgt	Pack cube
66427 / 22-027	21"	04848-5	6	2	0.68



ALL PRODUCTS ON THIS PAGE
ARE MADE IN THE USA (UNLESS NOTED)

DRAIN TILE CLEANER HANDLE

For all size drain cleaners



Model	Length	UPC 0 25545 +	Pack qty	Pack wgt	Pack cube
66430 / 22-076	72"	04877-5	6	2	0.95

SQUARE EYE POST HOLE DIGGER HANDLES

For Atlas, Hercules, and similar post hole diggers, drilled



Model	Length	UPC 0 25545 +	Pack qty	Pack wgt	Pack cube
66744 / 863-18	48"	86318-7	6	10	0.53
66745 / 863-21	48"	86321-7	6	10	0.53
66761 / 866-21	72"	86621-8	6	17	0.95
66763 / 867-21	96"	86721-5	6	20	0.76

ROUND END POST HOLE DIGGER HANDLES

Drilled



Model	Length	UPC 0 25545 +	Pack qty	Pack wgt	Pack cube
66753 / 864-18	48"	86418-4	6	10	0.53
66754 / 864-21	48"	86421-4	6	10	0.53

POST HOLE DIGGER HANDLES

For Eureka post hole diggers



Model	Length	UPC 0 25545 +	Pack qty	Pack wgt	Pack cube
66759 / 865-21	48"	86521-1	6	10	0.53

PRUNING TOOL HANDLES

HEDGE SHEAR HANDLES

21/32" bore, ferruled



(not made in the USA)

Model	Length	UPC 0 25545 +	Pack qty	Pack wgt	Pack cube
66425 / 22-023	10"	04845-4	6	2	1.18

LOPPING SHEAR HANDLES

4" ferrule, 1/2" bore



Model	Length	UPC 0 25545 +	Pack qty	Pack wgt	Pack cube
66428 / 22-033	24"	04854-6	6	5	1.18



ALL PRODUCTS ON THIS PAGE
ARE MADE IN THE USA (UNLESS NOTED)

WHEELBARROW HANDLES & WEDGES

WHEELBARROW HANDLES

Model	Length	UPC 0 25545 +	Pack qty	Pack wgt	Pack cube
1-3/8" x 1-3/4", straight pattern, parallel end to end, shaped grip end, clear finish					
66534 / 35-025	60"	04769-3	6	27	0.86
1-3/8" x 1-3/4", straight pattern, parallel end to end, shaped grip end, sand finish					
66545 / 36-025	60"	04771-6	6	27	0.86
1-3/8" x 1-3/4", straight pattern, parallel end to end, shaped grip end, no bore, sand finish, homeowner quality					
66542 / 35-029	54"	05473-8	6	23	1.06

WHEELBARROW WEDGES, CLEAR FINISH

Model	Length	UPC 0 25545 +	Pack qty	Pack wgt	Pack cube
66539 / 35-026	24"	04770-9	6	5	1.18

PAINT ROLLER, SQUEEGEE, AND PUSH BROOM HANDLES

PUSH BROOM AND SQUEEGEE HANDLES, TAPERED END

1-1/8" diameter, tapered to 3/4" within 3"

Model	Length	UPC 0 25545 +	Pack qty	Pack wgt	Pack cube
66439 / 22-245	54"	04809-6	12	11	0.86
66441 / 22-250	60"	04810-2	12	15	0.86

PUSH BROOM HANDLES, METAL THREAD

15/16" diameter, 3/4" Acme metal thread

(not made in the USA)

Model	Length	UPC 0 25545 +	Pack qty	Pack wgt	Pack cube
66446 / 22-299	54"	05042-6	12	13	1.06
66448 / 22-300	60"	04802-7	12	15	0.55

PUSH BROOM HANDLES, WOOD THREAD

15/16" diameter, 3/4" Acme wood thread

(not made in the USA)

Model	Length	UPC 0 25545 +	Pack qty	Pack wgt	Pack cube
66459 / 22-350	60"	04811-9	12	14	0.86

WEED CUTTER HANDLES

WEED CUTTER HANDLE

Model	Length	UPC 0 25545 +	Pack qty	Pack wgt	Pack cube
65163 / 7248-00	30"	04123-3	12	15	1.18

TURF EDGER HANDLE

Model	Length	UPC 0 25545 +	Pack qty	Pack wgt	Pack cube
66426 / 22-025	48"	04846-1	12	12	0.53

TAMPER HANDLES

SHAPED TAMPER HANDLE

1-7/16" diameter, straight eye, sanded finish

Model	Length	UPC 0 25545 +	Pack qty	Pack wgt	Pack cube
66547 / 39652-21	44"	00582-2	6	2.5	0.53

UNSHAPED TAMPER HANDLE

1-1/2" diameter, straight eye, sanded finish

Model	Length	UPC 0 25545 +	Pack qty	Pack wgt	Pack cube
No slot					
66548 / 39658-21	48"	00588-4	6	1.8	0.53
66549 / 39659-21	42"	00589-1	6	1.5	0.53
With single 2" slot					
66554 / 49658-21	48"	00852-6	6	1.8	0.53
66555 / 49659-21	42"	05851-4	6	1.5	0.53

BENT HOLLOWBACK SHOVEL HANDLES WITH SHOULDER

LONG BENT HOLLOWBACK SHOVEL/SCOOP HANDLES WITH SHOULDER

1-1/2" diameter, 9" chuck with slot

Model	Length	UPC 0 25545 +	Pack qty	Pack wgt	Pack cube
66704 / 827-18	48"	82718-9	6	10	0.53
66705 / 827-21	48"	82721-9	6	10	0.53
66713 / 828-21	54"	82821-6	6	12	0.61

LINK HANDLES - ASH

BENT HOLLOWBACK SHOVEL HANDLES WITH SHOULDER (cont..)

BENT HOLLOWBACK SHOVEL/SCOOP HANDLES WITH SHOULDER, STEEL D-GRIP

1-1/2" diameter, 9" chuck with slot



(not made in the USA)

Model	Length	UPC 0 25545 +	Pack qty	Pack wgt	Pack cube
66716 / 829-18	30"	82918-3	6	10	0.68
66717 / 829-21	30"	82921-3	6	10	0.68
66823 / 960-21	36"	96021-3	6	12	0.53
66794 / 892-21	38"	89221-7	6	12	0.53
66781 / 876-21	42"	87621-7	6	13	0.53

BENT HOLLOWBACK SHOVEL HANDLES WITHOUT SHOULDER

LONG BENT HOLLOWBACK SHOVEL/SCOOP HANDLES WITHOUT SHOULDER

1-1/2" diameter, 9-1/2" eye chuck, eye slot



Model	Length	UPC 0 25545 +	Pack qty	Pack wgt	Pack cube
66693 / 823-18	48"	82318-1	6	10	0.53
66694 / 823-21	48"	82321-1	6	10	0.53
66700 / 824-21	54"	82421-8	6	12	0.61

BENT HOLLOWBACK SHOVEL HANDLES WITHOUT SHOULDER, STEEL D-GRIP

1-1/2" diameter, 9-1/2" eye chuck, eye slot



(not made in the USA)

Model	Length	UPC 0 25545 +	Pack qty	Pack wgt	Pack cube
66702 / 825-21	30"	82521-5	6	10	0.68

STRAIGHT HOLLOWBACK SHOVEL HANDLES WITH SHOULDER

LONG STRAIGHT HOLLOWBACK FLORAL SHOVEL HANDLES WITH SHOULDER

1-7/16" diameter, 9" chuck with slot



Model	Length	UPC 0 25545 +	Pack qty	Pack wgt	Pack cube
66628 / 750-21	42"	75021-0	6	7	0.53



ALL PRODUCTS ON THIS PAGE ARE MADE IN THE USA (UNLESS NOTED)

LONG STRAIGHT HOLLOWBACK SHOVEL/SCOOP HANDLES WITH SHOULDER

1-1/2" diameter, 9" chuck with slot



Model	Length	UPC 0 25545 +	Pack qty	Pack wgt	Pack cube
66766 / 870-21	48"	87021-5	6	10	0.53
66784 / 880-21	54"	88021-4	6	11	0.61

STRAIGHT HOLLOWBACK SHOVEL/SCOOP HANDLES WITH SHOULDER, STEEL D-GRIP

1-1/2" diameter, 9" chuck with slot



(not made in the USA)

Model	Length	UPC 0 25545 +	Pack qty	Pack wgt	Pack cube
66773 / 871-21	30"	87121-2	6	10	0.68
66653 / 789-21	38"	78921-0	6	13	0.68

STRAIGHT HOLLOWBACK SHOVEL HANDLES WITHOUT SHOULDER

STRAIGHT HOLLOWBACK SHOVEL HANDLES WITHOUT SHOULDER, STEEL D-GRIP

1-1/2" diameter, 9-1/2" chuck with slot



(not made in the USA)

Model	Length	UPC 0 25545 +	Pack qty	Pack wgt	Pack cube
66778 / 873-21	30"	87321-6	6	10	0.68

LONG STRAIGHT HOLLOWBACK SHOVEL HANDLES WITHOUT SHOULDER

1-1/2" diameter, 9-1/2" chuck with slot



Model	Length	UPC 0 25545 +	Pack qty	Pack wgt	Pack cube
66787 / 881-21	48"	88121-1	6	10	0.53

LINK HANDLES®



ALL PRODUCTS ON THIS PAGE
ARE MADE IN THE USA (UNLESS NOTED)

CLOSED BACK SHOVEL HANDLES WITH SHOULDER

CLOSED BACK SOLID SHANK SHOVEL AND SPADE HANDLES WITH SHOULDER, STEEL D-GRIP

1-1/2" diameter, 6-1/2" chuck, regular weight



(not made in the USA)

Model	Length	UPC 0 25545 +	Pack qty	Pack wgt	Pack cube
66722 / 834-21	24"	83421-7	6	8	0.68

CLOSED BACK SOLID SHANK SHOVEL AND SPADE HANDLES WITH SHOULDER

1-1/2" diameter, 5-1/2" chuck, featherweight



Model	Length	UPC 0 25545 +	Pack qty	Pack wgt	Pack cube
66724 / 836-21	44-1/2"	83621-1	6	8	0.68

CLOSED BACK SOLID SHANK SHOVEL AND SPADE HANDLES WITH SHOULDER, STEEL D-GRIP

1-1/2" diameter, 5-1/2" chuck, featherweight



(not made in the USA)

Model	Length	UPC 0 25545 +	Pack qty	Pack wgt	Pack cube
66727 / 838-21	24"	83821-5	6	8	0.68

CLOSED BACK SOLID SHANK SHOVEL AND SPADE HANDLES WITH SHOULDER

1-1/2" diameter, 6-1/2" chuck



Model	Length	UPC 0 25545 +	Pack qty	Pack wgt	Pack cube
66798 / 896-21	44-1/2"	89621-5	6	8	0.53
66800 / 897-21	46-1/2"	89721-2	6	9	0.53
66801 / 898-21	48"	89821-9	6	10	0.53

GENERAL PURPOSE SHOVEL HANDLE WITH SHOULDER

1-1/2" diameter



Model	Length	UPC 0 25545 +	Pack qty	Pack wgt	Pack cube
66833 / 990-21	48"	99021-0	6	9	0.53

CLOSED BACK SHOVEL HANDLES WITHOUT SHOULDER

CLOSED BACK SOLID SHANK SHOVEL HANDLES WITHOUT SHOULDER, STEEL D-GRIP

1-1/2" diameter, 4-1/2" chuck



(not made in the USA)

Model	Length	UPC 0 25545 +	Pack qty	Pack wgt	Pack cube
66673 / 807-21	24"	80721-1	6	9	0.68
66675 / 808-21	25-1/2"	80821-8	6	9	0.68

CLOSED BACK SOLID SHANK SHOVEL HANDLES WITHOUT SHOULDER

1-1/2" diameter, 4-1/2" chuck



Model	Length	UPC 0 25545 +	Pack qty	Pack wgt	Pack cube
66733 / 844-21	44-1/2"	84421-6	6	9	0.53
66728 / 841-21	46-1/2"	84121-5	6	9.5	0.53
66730 / 842-21	48"	84221-2	6	10	0.53

CLOSED BACK SOLID SHANK SHOVEL HANDLES WITHOUT SHOULDER

1-1/2" diameter, 5-1/2" chuck



Model	Length	UPC 0 25545 +	Pack qty	Pack wgt	Pack cube
66831 / 989-21	44"	98921-4	6	9	0.86
66813 / 950-21	48"	95021-4	6	10	0.53

CLOSED BACK SOLID SHANK SHOVEL HANDLES WITHOUT SHOULDER, STEEL D-GRIP

1-1/2" diameter, 5-1/2" chuck



(not made in the USA)

Model	Length	UPC 0 25545 +	Pack qty	Pack wgt	Pack cube
66816 / 951-21	24"	95121-1	6	8	0.68
66819 / 952-21	27"	95221-8	6	9	0.68
66820 / 953-21	30"	95321-8	6	10	0.68

LINK HANDLES - RED OAK / D-GRIPS / RIVETS

PLOW HANDLE & WALKING STICK

PLOW HANDLE

56" walking plow handle, red oak



Model	Length	UPC	Pack qty	Pack wgt	Pack cube
64205 / 22-388	56"	0 25545 + 05115-7	2	3.2	1.79

BENT WALKING STICK / CANE

37.5" waling stick / cane, red oak



Model	Length	UPC	Pack qty	Pack wgt	Pack cube
64207 / 22-849	37.5"	0 25545 + 53601-2	12	13.2	1.35

D-GRIPS

TUBULAR STEEL D-GRIP

Rugged steel D-grips are designed to provide the best combination of balance, grip, and comfort. Sized to provide the best grip for both gloved and ungloved hands.



(not made in the USA)

Model	UPC	Pack qty	Pack wgt	Pack cube
64084 / 50001-00	0 25545 + 00048-3	12	10	0.45

POLY D-GRIP

Extra-large D-grip handle designed to provide more room for gloved hands. Solid polypropylene grip is light weight yet durable. 1-1/4" diameter socket.



Model	UPC	Pack qty	Pack wgt	Pack cube
64085 / 50025-00	0 25545 + 05492-9	12	8	0.40

IRON RIVETS

IRON RIVETS* FOR SHOVEL HANDLES

Rivets are furnished with each shovel handle. It is wise, however, to have extra rivets on hand.

3/16" diameter, 1-3/4" long



Model	UPC	Pack qty	Pack wgt	Pack cube
64098 / 50005-00	0 25545 + 00052-0	1	8 oz.	0.08
64099 / 50006-00	00053-7	1	1 oz.	0.04

* (50006-00 contains 4 rivets per package, 50005-00 has 36)



ALL PRODUCTS ON THIS PAGE
ARE MADE IN THE USA (UNLESS NOTED)

OUR SAWMILL LOCATIONS



SEYMOUR, IN



SEQUATCHIE, TN



CROSSVILLE, TN



ALTAMONT, TN

BETTER BY DESIGN

When your customers buy tool handles, they need handles with proper fit. The handle becomes an extension of their bodies and determines the comfort of the user. Link handles provide the time tested ergonomic shape and design that allows for better control, comfort, and safety.

COMMON HANDLE EYE SHAPES - LINK HANDLES

CLAW HAMMERS, 16 OZ.



Handle models
300
304

1-1/16" X 9/16"

CLAW HAMMERS, 20 TO 24 OZ.

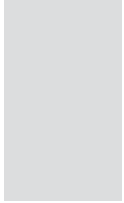

Handle models
310
312
313

1-1/16" X 5/8"

CLAW HAMMERS, 28 TO 32 OZ.

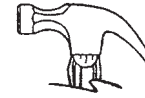
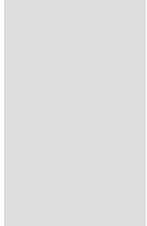

Handle models
321
322

1-3/16" X 3/4"

BALL PEIN HAMMERS, 16 TO 20 OZ.

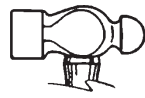

Handle models
405

29/32" X 17/32"

BALL PEIN HAMMERS, 24 TO 28 OZ.

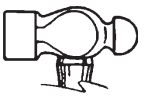

Handle models
407

1-1/16" X 19/32"

ENGINEER OR BLACKSMITH OR DRILLING HAMMERS



Handle models
423
424
480
481

1" X 3/4"

BLACKSMITH HAMMERS, 3-1/2 LB. AND HEAVIER



Handle models
432
433

1-1/4" X 1"

SLEDGES AND MAULS, 6 TO 16 LB., OVAL EYE

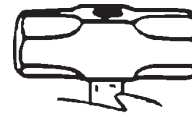

Handle models
001 003
002 004

1-1/4" X 1"

SLEDGES AND MAULS, 18 TO 24 LB.

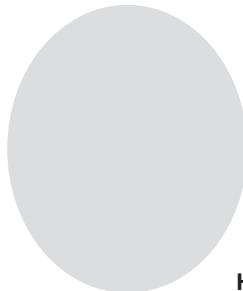

Handle models
010
023

1-1/2" X 1-1/4"

SPLITTING MAULS, NO. 5 EYE

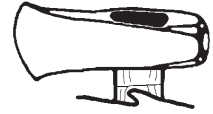

Handle models
205

2-1/8" X 7/8"

SINGLE BIT SPLITTING MAULS

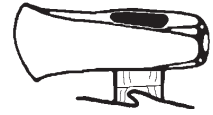

Handle models
206

2-5/16" X 13/16"

SCOUT OR HUNTER AXES, 1-3/4 LB.



Handle models
369

1-3/4" X 11/16"

DOUBLE-BIT AXES, 3-5 LB.



Handle models
140
142

2-7/8" X 5/8"

SCOUT AXES, 1-1/4 LB.



Handle models
368

1-11/16" X 5/8"

LINK HANDLES - COMMON HANDLE EYE SHAPES

BROAD HATCHETS

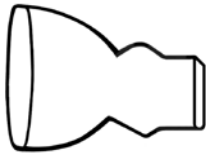

Handle models
334

1-5/8" X 19/32"

HALF HATCHETS



Handle models
330

1-17/32" X 17/32"

GRUB HOES, NO. 8 EYE

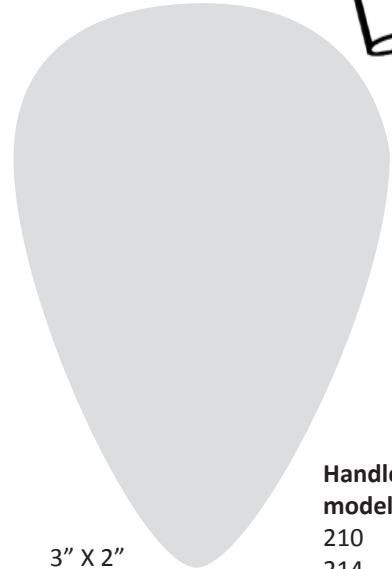

Handle
models
210
214
215

3" X 2"

RAILROAD OR CLAY PICKS & MATTOCKS, NO. 6 EYE

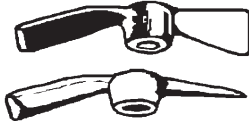

3" X 2"

Handle models
220

GARDEN OR NURSERY MATTOCKS, NO. 7 EYE



Handle
models
240

2-3/4" X 1-3/4"

SMALL EYE GRUB HOES, NO. 9 EYE

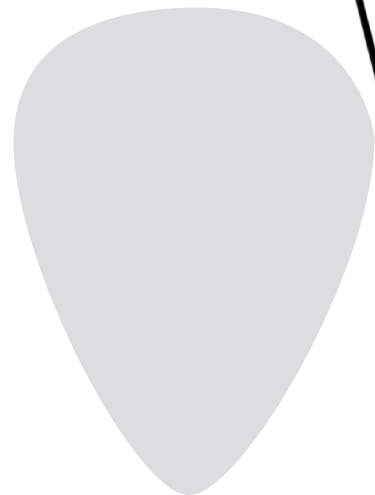

Handle models
216

2-1/2" X 1-7/8"

CARPENTER'S ADZE

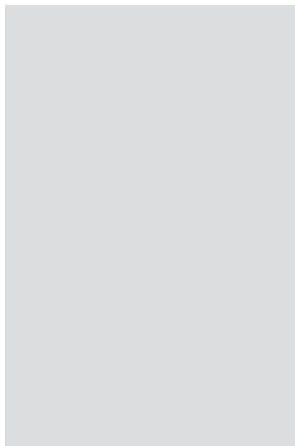

Handle
models
224

2-5/16" X 1-1/2"

DOUBLE BIT GARDEN MATTOCKS, NO. 10 EYE

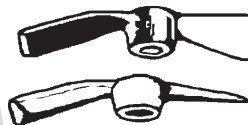

Handle models
200

3" X 1"

HOW TO REPLACE HANDLES - LINK HANDLES

HAMMER & HAND AXE HANDLES

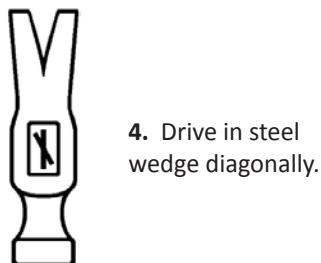
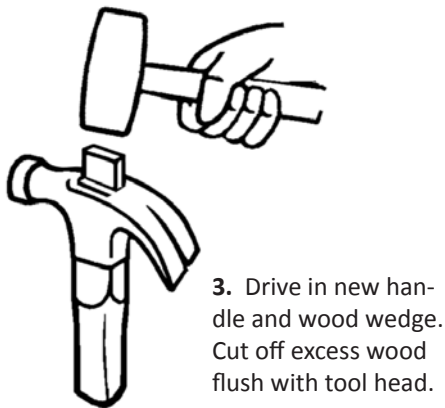
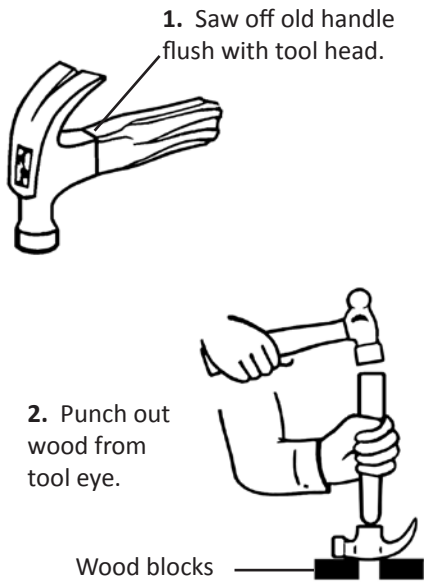

SLEDGE & AXE HANDLES

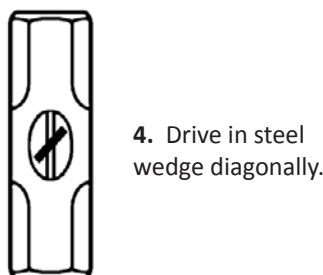
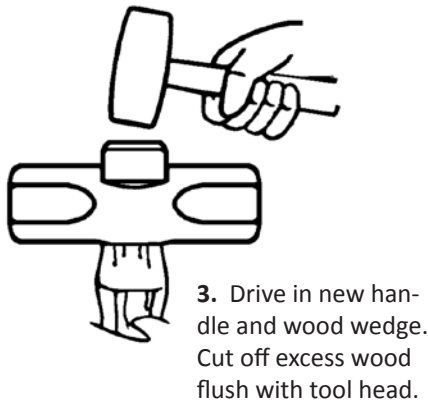
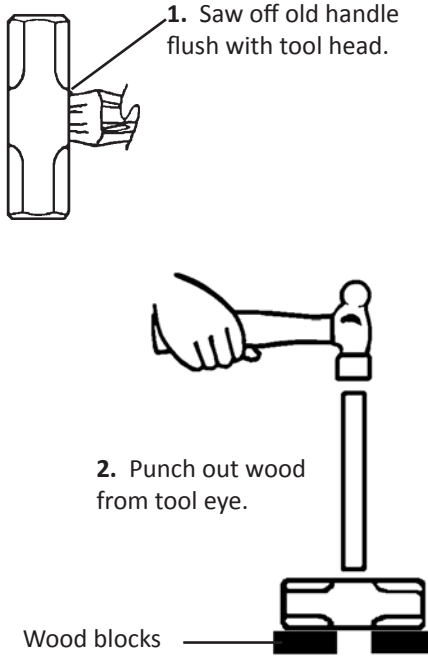

MATTOCK & EYE HOE HANDLES

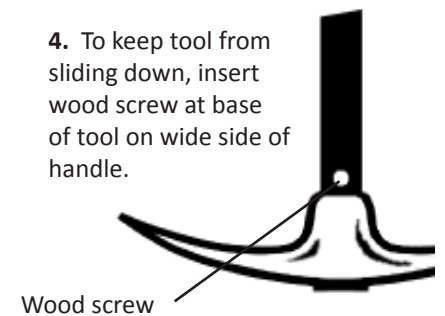
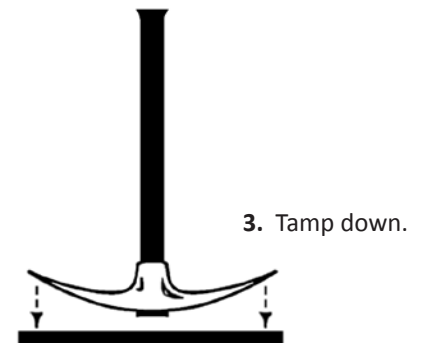
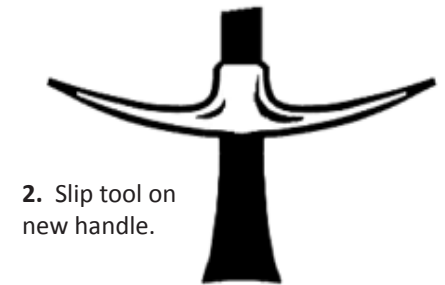
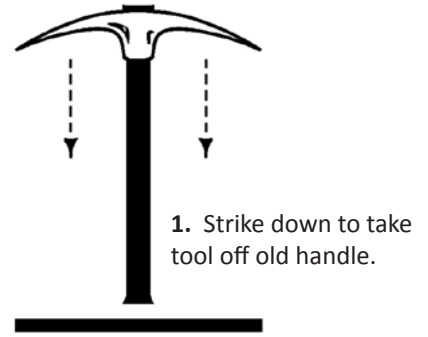

For your safety and convenience:

Wear safety goggles to protect your eyes.
Bring old tool to store to measure for replacement handle.

LINK HANDLES - HOW TO REPLACE HANDLES

FORKS WITH D-GRIP HANDLES

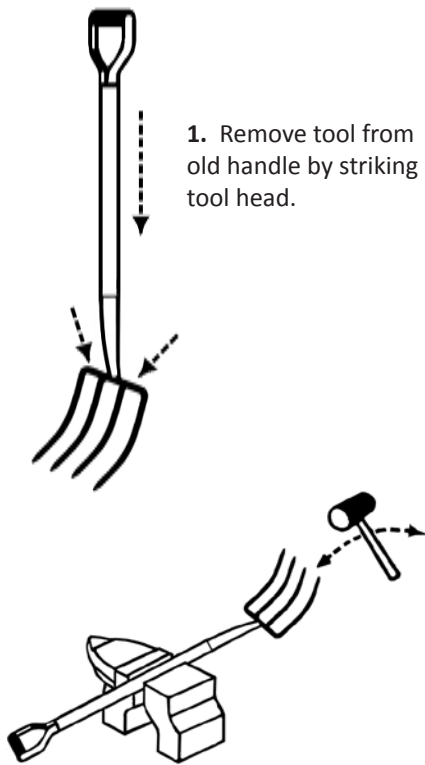

1. Remove tool from old handle by striking tool head.

2. Put protective wrap on new handle and place in vise. Drive tool head onto handle.

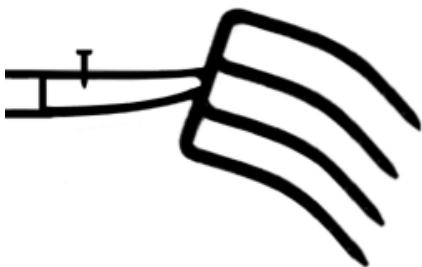

3. Secure handle to head with a screw or nail.

HOE, RAKE, & FORK HANDLES

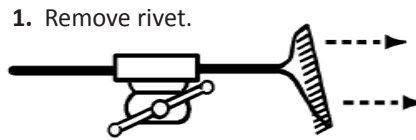

1. Remove rivet.

2. Lock handle in vise and pull tool head from old handle.

3. Check handle fit and resize handle hole if needed. Put wood glue in handle hole.

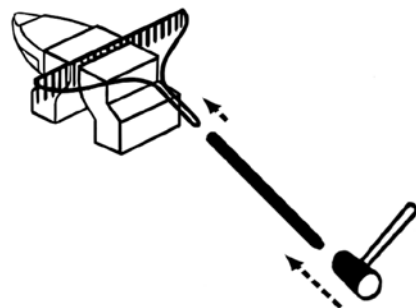

4a. Lock tool in vise and drive on new handle.

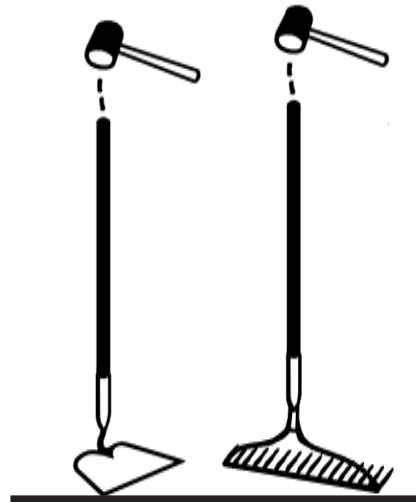
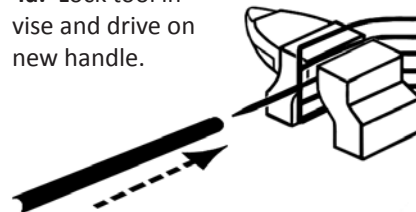

4b. For socket pattern tools, follow steps 1 through 3. Then place head on solid surface and drive on handle.

SHOVEL & SPADE HANDLES

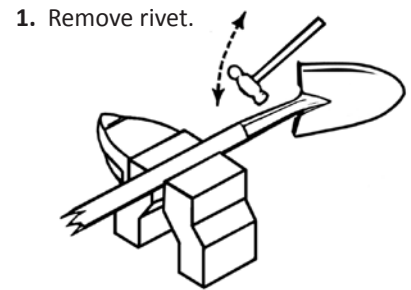

1. Remove rivet.

2. Rotate shovel on anvil of vise while hammering on shank of tool to loosen handle.

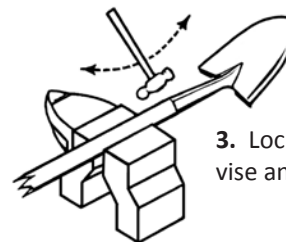

3. Lock old handle in vise and drive tool off.

4. Check tool for fit and lubricate with oil.

5a. For long handle, drive on against hard surface.

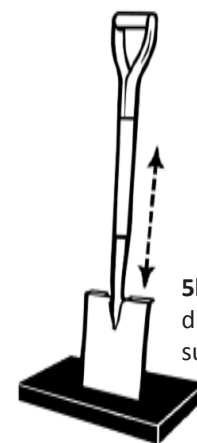

5b. For D-grip handle, drive on against wood surface or block.

6. Drill 3/16" hole and install rivet. Brad the rivet with round end of ball peen hammer.

Campfires • Charcoal Cookin' • Firepits



98036 Seymour popcorn popper

- 27" overall length
- 30-2682185



98030 Seymour 14" hearth safety gloves

- Leather with cotton lining, in poly bag
- 30-2682403

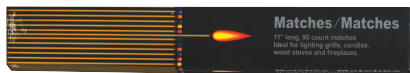

98020 Seymour hearth matches

- 11" long, 90 count
- 30-059



98032 Tan canvas log carrier.

- Heavy duty, cotton canvas with sewn "box" ends
- Tan with color trim. 32" L x 18" T
- 30-2682383



98039 Seymour Stack•It Brackets™



- All-steel construction
- Packaged as sets with 4 brackets per box
- 30-360

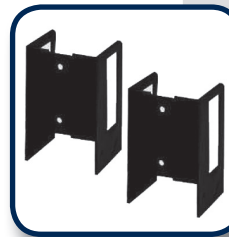

OUR HEAVY-DUTY STACK•IT BRACKETS™...

are steel fixtures used to hold two-by-fours together for storage racks, shelving, workbenches, and stands.

- *Protects firewood:* They have a unique design that keeps firewood high, dry, and safe from pests and decay.
- *Adjustable:* They can be built to any length.
- *Easy to use:* Simple, fast assembly and disassembly without tools, screws or bolts.



Submitted photo of a rack made with STACK•IT BRACKETS

FIRESTARTER

USA MADE

Campfires • Charcoal Cookin' • Firepits



J. Seymour

BACK IN THE 1870'S

when everybody used wood or coal for cooking and heating, Julius Seymour invented the practically perfect lighter: safe, clean, sure. Lost for 100 years, his original formula was rediscovered by the Seymour family. Now it's the practically perfect lighter for today's charcoal grills, fireplaces, and campfires.

BURNS CLEAN

Seymour Midwest Fire Blox fire starters meet the strictest air quality codes on the country. Product complies with the South Coast Air Quality Management District Rule 1174. Ref. C14

California Prop. 65: Combustion of this product will result in the emission of carbon monoxide, soot and other combustion by-products which are known by the state of California to cause cancer, birth defects of other reproductive harm.

In California, use of this and other solid fuels may be restricted at times by law. Call 1-877-466-2876 or check www.8774noburn.org before burning.

WHY SEYMOUR FIRE BLOX FIRESTARTERS:

Starts all types of fires

- *Each piece measures 1.75" x 1.5" x .5"*
- Superior to liquids and other solid starters.
- Great for starting firewood, pellets, coal, and charcoal.
- Eliminates the need for liquids, kindling, and newspaper.

Works great even when it's wet

- Pieces burn hot for about 12 min. for fast, sure starts.
- Lights quickly, even when wet.
- Will ignite even damp firewood.

Safe to use anywhere

- Can't leak, spill, flash, flare-up, or explode.
- Safe to use both indoors and outdoors.
- Non-toxic.
- Stores safely anywhere with long shelf life.

Economical - just pennies per light

- Need only 2 or 3 pieces to start.
- A 24-pc. package provides 8-12 starts.
- Pieces are scored and separate easily.

Burns clean

- Environmentally friendly
- Meets the strictest US air quality codes.

FOR CAMPFIRES -



Use one or more Fire Blox with twigs / wood scraps under the logs. Starts in rain and moderate wind. Ignites even damp wood.

FOR CHARCOAL GRILLS -



Place 3 Fire Blox cubes on edge in charcoal, leaving air space as shown, and light frayed edges of cubes.

FOR FIREPLACES -



Place one or more Fire Blox under at least 3 logs and light; no kindling needed.



ALL PRODUCTS ON THIS PAGE
ARE MADE IN THE USA (UNLESS NOTED)



24-PIECE FIRESTARTER BOXES

98010 FIRE BLOX

- 24 pc. box
- 12 boxes in brown master carton
- 30-050-12



144-PIECE FIRESTARTER BOXES

98019 FIRE BLOX

- 144 pc. box
- 8 boxes in shipper box
- 30-589-08



4-PIECE FIRESTARTER CELLO PACKS

98016 FIRE BLOX

- Trial size plain box
- 104 packs of 4 pieces
- 30-054-104PB



24-PIECE FIRESTARTER CELLO PACKS

98011 FIRE BLOX

- Cello-pack, 12 packs of 24 pieces
- In brown master carton
- 30-052-12

THESE CARTONS CONVERT INTO POP DISPLAYS

The 24 box/pack shipper cartons can be quickly converted to an attention-grabbing full-color shelf or counter display with a large header card.



FIRESTARTER COUNTER/SHELF DISPLAYS

98013 FIRE BLOX carton

- 24 boxes of 24 pieces
- POP display
- 15" x 10" x 7"
- 30-050-24



FIRESTARTER COUNTER/SHELF DISPLAYS

98014 FIRE BLOX carton

- 24 packs of 24 pieces
- POP display
- 15" x 8" x 8"
- 30-052-24

**SEYMOUR FIRE BLOX CAPTURE INSTANT
ADD-ON SALES IN A VARIETY OF STORE
ENVIRONMENTS.**

MERCHANDISE THEM WITH:

- Outdoor grills and outdoor fireplace supplies
- Patio firepits, outdoor heaters and chimineas
- Camping supplies including hunting, fishing and backpacking
- Indoor fireplaces, wood stoves and heaters

RING FASTENERS

CUT STYLES OF RING TIPS



Slant



Slant
Offset



Blunt



Blunt
Offset

HOG RINGS are used to prevent swine from rooting in the ground. They are made from copper coated wire and come in various sizes.

Rings are defined by wire gage or diameter, material properties and cost, pattern, and cut. The ring wire materials below are listed in order of relative cost, with the least expensive listed first. For best value, select the lowest cost material that has the properties needed for the intended application.

BRIGHT BASIC STEEL RINGS are the most economical and are used for general purpose applications such as attaching tags.

COPPER COATED RINGS are economical and used for hog rings and general purpose applications.

GALVANIZED STEEL RINGS are best for applications such as fencing where moderate cost and resistance to rust are important.

ALUMINUM RINGS are relatively expensive, light weight and won't rust or corrode making them ideal for salt water use, cages and traps, and other special requirement applications.

STAINLESS STEEL RINGS are the most expensive and won't rust or corrode making them ideal for salt water use, cages and traps, food industry applications, and other special requirement applications.

HILL PATTERN RINGS close in a triangle shape.

BLAIR PATTERN RINGS close in an oval shape.

PREBENT RINGS reduce the effort needed to close the rings thus reducing hand fatigue.

ROPE TIE PATTERN RINGS are ideal for clamping rope and cable.

UPHOLSTERY PATTERN RINGS are designed to hold fabric to furniture frames.

SLANT CUT RINGS are best for applications requiring penetration such as upholstery and hog rings.

BLUNT CUT RINGS are best for applications such as fencing. They have no sharp points to cut or pierce, making them safer to handle.

NON-OFFSET RINGS close with the tips nearly touching. They are ideal for fastening large diameter materials such as fence wire where a small gap between the tips is OK.

OFFSET RING design allows the ring tips to pass for complete closure. They are best for fastening small diameter materials that could pass through a small gap.

RING FASTENERS are used for fastening wire fences, slit fences, steel mesh for wall reinforcement, fish traps, crab pots, animal cages, upholstery, and attaching tags. They are also used to clamp rubber tie-down straps and for clamping rope. Seymour rings have a variety of uses in arts and crafts such as fastening holiday wreath materials.



TAB-TOP BOXES: Packaged rings come in convenient tab-top boxes that make them ideal for effective pegboard merchandising. Each box holds from 25 to 100 rings depending on the size of the rings.



10-PACK DISPENSER BOX: Packaged ring boxes are packed in convenient dispenser cartons with 10 tab-top boxes in each dispenser carton.

BULK RINGS



ALL PRODUCTS IN THIS CHART ARE MADE IN THE USA (UNLESS NOTED)

Bulk rings prices are listed in the price list and special order rings are available on a quotation basis. For special needs, just provide samples or specifications.

Model	Description	Point Style	Wire Gage	Material	Pieces per Cwt.
RN-1H1	Hill pig rings, bulk pack	Slant	12.5	Copper plated steel	28,000
RN-1H2	Hill shoat rings, bulk pack	Slant	12.5	Copper plated steel	23,600
RN-1H3	Hill hog rings, bulk pack	Slant	12.5	Copper plated steel	20,600
RN-1H4	Hill hog rings, bulk pack	Slant	11.0	Copper plated steel	10,800
RN-1B1	Blair pig rings, bulk pack	Slant	12.5	Copper plated steel	24,000
RN-1B2	Blair shoat rings, bulk pack	Slant	12.5	Copper plated steel	20,500
RN-1B3	Blair hog rings, bulk pack	Slant	12.5	Copper plated steel	18,800
RN-1PBH1	Hill prebent pig rings, bulk pack	Slant	12.5	Copper plated steel	26,000
RN-1PBH2	Hill prebent shoat rings, bulk pack	Slant	12.5	Copper plated steel	22,600
RN-1PBH3	Hill prebent hog rings, bulk pack	Slant	12.5	Copper plated steel	18,200

RING FASTENERS



RN-1H1 Hill



RR-HM / 69045



RN-1PBH1 Prebent hill



RR-HS / 69046



RR-XM / 69305



RN-1B1 Blair



RR-HLM / 69042



RR-SM / 69356



RB-31 / 69005



RR-HHM / 69041



RR-DN / 69352



RB-53 / 69006



ALL PRODUCTS IN THIS CHART ARE MADE IN THE USA (UNLESS NOTED)

Model	Description	Point Style	Wire Gage	Material	Pieces Per Box
RN-H1 / 69022	Hill pig rings	Slant	12.5	Copper plated steel	100
RN-H2 / 69024	Hill shoat rings	Slant	12.5	Copper plated steel	100
RN-H3 / 69027	Hill hog rings	Slant	12.5	Copper plated steel	100
RN-H4 / 69029	Hill hog rings	Slant	11.0	Copper plated steel	65
RN-B1 / 69011	Blair pig rings	Slant	12.5	Copper plated steel	100
RN-B2 / 69013	Blair shoat rings	Slant	12.5	Copper plated steel	100
RN-B3 / 69017	Blair hog rings	Slant	12.5	Copper plated steel	100
RN-PBH1 / 69032	Hill prebent pig rings	Slant	12.5	Copper plated steel	100
RN-PBH2 / 69034	Hill prebent shoat rings	Slant	12.5	Copper plated steel	100
RN-PBH3 / 69038	Hill prebent hog rings	Slant	12.5	Copper plated steel	100
RN-X1 / 69300	Humane pig rings	Slant	11.0	Copper plated steel	25
RN-X3 / 69302	Humane hog rings	Slant	11.0	Copper plated steel	25
RN-541 / 69326	Cage/trap rings	Blunt	14.0	Stainless steel	5 lbs
RN-542 / 69327	Cage/trap rings	Slant	14.0	Stainless steel	5 lbs
RN-641 / 69323	Cage/trap rings	Blunt	14.0	Galvanized steel	5 lbs
RN-642 / 69324	Cage/trap rings	Slant	14.0	Galvanized steel	5 lbs
RN-741 / 69320	Cage/trap rings	Blunt	11.0	Aluminum	2 lbs
RN-742 / 69321	Cage/trap rings	Slant	11.0	Aluminum	2 lbs

Ringer pliers are specially designed to hold and close hog rings and ring fasteners.

The chart below indicates which pliers to use with the various ring patterns.

RR-SM Small

541,542, 641,642, 741,742, all rings less than 3/4"

RR-HM Hill

H1, H2, H3, PBH1, PBH2, PBH3, B1, B2, B3

RR-HS Hill spring

H1,H2, H3, PBH1, PBH2, PBH3, B1, B2, B3

RR-HLM Hill wide jaw

H4, all heavy wire rings

RR-HHM Hill heavy

H4, all heavy wire rings

RR-XM Humane

X1,X3, H1,H2, H3, PBH1, PBH2, PBH3, B1, B2, B3

RR-DN De Neu

H1,H2, PBH1, PBH2, B1,B2

Model	Description	Material
RR-HM / 69045	Hill ringer pliers	Malleable iron casting with chrome finish
RR-HS / 69046	Hill spring ringer pliers	Malleable iron casting with chrome finish
RR-HLM / 69042	Hill wide jaw ringer pliers	Malleable iron casting with chrome finish
RR-HHM / 69041	Hill large ringer pliers	Malleable iron casting with chrome finish
RR-XM / 69305	Humane ringer pliers	Malleable iron casting with chrome finish
RR-SM / 69356	Small ringer pliers	Malleable iron casting with chrome finish
RR-DN / 69352	Denui ringer pliers	Malleable iron casting with chrome finish
RB-31 / 69005	Bull ring, 5/16" x 2-1/2", solid brass, hinged and secured with solid brass set screw	
RB-53 / 69006	Bull ring 3/8" x 3", solid brass, hinged and secured with solid brass set screw	

MERCHANDISING

FLOOR MERCHANDISERS

Colorful floor displays can double or triple your inventory turns by attracting customer attention and using space efficiently. Great for end-caps, sidewalk displays, and seasonal merchandise. Ask for a complimentary copy of our brand new merchandising ideas guide with many standard display assortments.



2' X 2' STRIKING TOOL RACK



4' X 2' STRIKING TOOL RACK



2' X 2' & 3' X 4' PALLET DISPLAYS



1' X 2' FLOOR DISPLAY



3' X 3' WHEELBARROW DISPLAY



NEW 1' X 2' MINI MAX RACK



2' X 2' STATIONARY RACK



2' X 3' ROLLING RACK



MINI ROLLING RACKS



EXTENSION HANDLES

STEEL MOBILE RACKS

are easy to assemble and can be used indoors or outdoors in any weather. They attract customer attention, and display tools and use space efficiently.

NO SET UP REQUIRED

for pallet displays. They come fully loaded with a removable protective wrap, and are attached to wooden pallets for ease of handling.

OUR NEW MERCHANDISING GUIDE

Our new 2015-2016 Merchandising Ideas Guide is now available from your Seymour Midwest representative. The right merchandising can dramatically accelerate tool sales by creating visibility and accessibility. This 40 page booklet details a fully-updated selection of proven display options for both retail and wholesale (contractor-supply) sales environments. Choose from rolling and stationary tool racks, in-aisle and impulse displays and updated signage.

Contact your representative for a complimentary copy and a consultation on your specific display needs.

2015 MERCHANDISING CATALOG



USE SPACE EFFICIENTLY AND MAXIMIZE IMPACT

We custom-design planograms to maximize customer appeal and sell-through. Careful planning ensures that premium wall space yields maximum return on inventory investment.

MANY PLANOGRAM OPTIONS ARE AVAILABLE

with a variety of long handled and garden tool assortments. We develop planogram systems for retail hardware, lawn and garden, industrial supply, landscape wholesaler, irrigation wholesaler, utility wholesaler, fencing dealer / distributor, lumberyard, farm and ranch supply, and other markets.

To get started, contact our merchandising experts at Marketing@SeymourMidwest.com.

WIRE DISPLAY HOOKS



YDIS109 2-digger hanger

- Space saving front load design holds 2 post hole diggers.



YDIS112 waterfall hanger

- Ideal for long handle tools such as shovels and rakes. Holds 3 tools.



YDIS113 waterfall hanger

- Ideal for long handle tools such as shovels and rakes. Holds 6 tools.



YDIS111 weeder/pruner holder

- Designed to hold loppers, hedge shears, and bow saws horizontally.



YDIS110 hoe hanger

- Designed specifically for garden, mortar, & specialty hoes. Also great for bow saws.



YDIS108 11" double hook

- Best hook for D-handled tools.



YDIS107 10" single hook

- Ideal for tools and cards with a single hanging point

**OUR DISPLAY HOOKS
WORK WITH 1/4"
PEGBOARD AND
HEAVY-DUTY
SLATWALL**

Learn more about our complete family of brands including options for both professionals and consumers.

Download high resolution photos, spec sheets and product instructions.

Directly search for specific products by Seymour or Midwest Rake model code or UPC number.

Browse products by tool type or by industry category. Compare features and advantages at a glance.

Explore Seymour Midwest's history and learn how we are growing a sustainable, community-oriented future.

Submit technical questions and other inquiries using our Ask the Expert system.

Discover new products, merchandising tips, promotional ideas and more in our "What's New" pages.

**NEW FOR
2016**

Stay up to date with all of the new quality products that Seymour Midwest has to offer! We have expanded our selection of tools that includes new products for every type of user.

STRUCTRON® IMPACT TOOLS

Seymour Midwest introduces 3 new “Impact” shovels - a caprock, irrigation, and drain spade - that are the most rugged and reliable shovels on the market today. The result of precision engineering and best-in-class materials, these new shovel designs will deliver outstanding performance for the professional user.



49588 Structron impact caprock shovel

- 10 ga. stamped & hot formed head
- Most rugged & reliable caprock on the market
- PermaGrip steel collar
- Solid fiberglass 48” handle with ProGrip cushioned grip



49585 Structron impact irrigation shovel

- 10 ga. stamped & hot formed head, 7.5” x 9.5”
- Most rugged & reliable caprock on the market
- PermaGrip steel collar
- 48” fiberglass handle with ProGrip cushioned grip



49589 Structron impact drain spade

- 10 ga. stamped & hot formed head
- Most rugged & reliable caprock on the market
- PermaGrip steel collar
- 48” fiberglass handle with ProGrip cushioned grip

STRUCTRON® SCOOPS

Seymour Midwest introduces a new Eastern pattern scoop for construction use. The result of precision engineering and best-in-class materials, this new shovel design will deliver outstanding performance for the professional user. Common applications include transferring bulk materials including asphalt, aggregate, sand and mulch.



49257 Structron Eastern pattern scoop

- #2 steel head, 11.125” x 16”
- 27” hardwood handle with steel d-grip

THE ORANGE SEYMOUR® WHEELBARROW IS BACK BY POPULAR DEMAND!



85728 Seymour 6 cu. ft. wheelbarrow, steel tray

- Light-duty steel tray - orange, standard tire
- Hardwood handles

INDEX

SYMBOLS

2B-42B20	66	12524	46, 96	21401	66	41400	74	41513	88	41594	89
2B-42G28	66	12536	46, 96	21408	66	41401	70	41514	88	41595	89
2B-42G30	66	14024	45	21409	66	41403	70	41515	88	41596	89
2B-42W24	66	14030	45	21420	66	41405	70	41516	88	41600	95
2B-42W26	66	14036	45	21428	66	41406	70	41517	88	41602	95
2B-040128	66	14042	45	21430	66	41407	70	41518	88	41604	95
2B-040130	66	14048	45	21438	66	41411	72	41519	88	41610	95
2C-33	68	14124	45	21440	66	41413	72	41520	88	41612	95
2C-66	68	14130	45	21450	66	41414	72	41521	89	41614	95
2C-99	68	14136	45	21451	66	41415	72	41522	90	41700	67
2E-AE0	53	14142	45	21452	66	41416	72	41523	88	41705	67
2E-AE1	53	14148	45	21504	94	41417	72	41524	88	41710	67
2E-AE2	53	16113	47	21505	94	41418	68	41525	88	41711	67
2E-G60	53	16114	44	24124	66	41419	70	41530	90	41712	68
2E-IG7	53	16117	44	24126	66	41420	68	41531	89	41718	68
2G-25	67	20024	46	40020	43	41421	71	41532	89	41719	68
2G-25LH	67	20030	46	40100	53	41422	71	41533	90	41722	68
2G-497	67	20036	46	40872	40	41423	71	41534	90	41723	68
2G-507	67	20042	46	40880	40	41424	71	41536	88	41724	68
2P-CN13	68	20048	46	40882	40	41426	69	41537	88	41725	68
2P-MA12	68	20060	46	40883	40	41428	69	41538	88	41730	68
2P-MA18	68	21025	62	40884	40	41429	69	41539	88	41740	68
2P-MA18S	68	21060	63	40885	40	41430	95	41542	90	41745	68
2P-MA22	68	21075	63	40912	38	41432	95	41543	89	41748	68
2P-MA22S	68	21100	62	40924	38	41434	95	41544	89	42004	55
2P-MA24	68	21105	62	40928	38	41436	95	41545	90	42016	42
2P-MA24S	68	21106	62	40930	38	41440	95	41546	90	42100	53
10024	44	21108	62	40931	38	41442	95	41547	89	42103	55
10030	44	21108	62	40931	38	41444	95	41548	90	42141	53
10036	44	21109	62	40940	38	41444	95	41548	90	42201	55
10042	44	21110	62	40942	38	41446	95	41549	90	42203	55
10048	44	21117	62	40945	38	41453	69	41550	88	42204	55
11024	46, 96	21180	62	40948	38	41454	69	41551	88	42204	55
11030	46, 96	21200	62	40955	38	41455	69	41552	88	42224	55
11036	46, 96	21206	62	41020	64	41461	72	41553	88	42244	55
11042	46, 96	21208	62	41021	64	41463	72	41554	88	42254	55
11048	46, 96	21210	62	41026	64	41465	72	41555	88	42256	55
11100	44	21211	62	41031	76	41467	72	41556	89	42258	57
11101	44	21215	62	41033	76	41471	71	41558	89	42280	74
11102	44	21219	62	41034	76	41473	70	41559	89	42314	41
11103	44	21220	63	41035	76	41474	70	41560	89	42316	41
11104	44	21230	63	41038	77	41476	70	41561	89	42320	42
12024	44, 96	21244	63	41040	76	41481	73	41562	89	42324	41
12030	44, 96	21245	63	41041	76	41483	73	41566	88	42350	43
12036	44, 96	21246	63	41042	76	41484	73	41567	88	42351	43
12042	44, 96	21248	63	41044	68	41485	73	41569	89	42355	42
12048	44, 96	21264	63	41045	68	41486	73	41571	89	42356	42
12072	44	21266	63	41046	68	41487	73	41572	88	42357	42
12100	44	21268	63	41050	92	41488	73	41573	88	42364	41
12101	44	21302	65	41054	70	41489	73	41574	88	42366	41
12102	44	21303	65	41055	70	41492	71	41576	88	42390	43
12103	44	21304	65	41202	76	41498	74	41577	88	42410	52
12104	44	21306	65	41212	76	41499	74	41578	88	42420	52
12501	47, 96	21308	65	41222	76	41500	88	41580	89	42425	52
12502	47, 96	21310	65	41250	94	41501	88	41581	89	42430	82
12503	47, 96	21312	65	41251	94	41502	88	41582	89	42432	82
12517	46	21312	65	41251	94	41503	88	41583	89	42434	82
		21324	65	41255	94	41509	88	41586	89	42437	82
		21326	65	41366	47	41511	88	41588	89	42441	52
		21332	65	41395	74	41512	88	41589	89	42448	52
		21348	65	41398	74						

42450	52	47245	83	49163	29	49344	26	49576	22	56935	96
42455	52	47246	83	49164	29	49345	26	49577	22	56936	96
42458	52	49006	60	49168	30	49346	31	49585	18, 131	60240	75
42460	52	49008	60	49169	30	49347	31	49588	20, 131	60241	75
42465	52	49010	58	49170	26	49348	31	49589	18, 131	60242	75
42466	52	49010LO	58	49171	26	49351	30	49597	23	60244	75
42468	52	49013	60	49172	26	49352	23	49599	18	60245	75
42469	52	49016	60	49173	26	49353	30	49630	20	60246	75
42485	52	49017	60	49174	30	49357	31	49631	20	60247	75
42600	41	49018	60	49175	29	49430	19, 28	49640	34	60248	75
42604	41	49019	60	49178	30	49431	19, 28	49641	34	60250	75
42610	53	49029	61	49179	31	49432	19, 28	49642	34	60251	75
42670	55	49030	61	49180	29	49433	19	49643	34	60252	75
42690	43	49031	61	49181	29	49437	23	49650	34	60253	75
42800	53	49032	61	49185	29	49450	19	49652	34	60254	75
42801	53	49033	61	49191	30	49451	19	49653	21	60255	75
42802	53	49034	61	49216	58	49452	19	49654	21	60256	75
42805	53	49035	61	49217	58	49453	21	49656	34	60270	75
42808	53	49039	61	49219	60	49454	21	49657	34	60271	75
43101	39	49042	54	49240	59	49455	20	49662	34	60272	75
43103	39	49043	54	49241	59	49456	23	49666	34	60273	75
43106	39	49044	35, 85	49242	59	49457	23	49667	34	60274	75
43118	39	49045	35, 85	49248	60	49459	23	49691	34	60275	75
43332	39	49047	54	49249	60	49462	19	49692	34	60276	75
43333	39	49048	54	49251	58	49465	20	49730	17	60700	77
43334	39	49050	60	49253	58	49490	37	49731	17	60701	77
43335	39	49051	60	49257	59, 131	49491	37	49732	17	60703	77
43336	39	49053	60	49260	59	49492	37	49733	21	60710	77
43337	39	49054	60	49262	59	49493	37	49734	21	60711	77
43338	39	49060	60	49265	59	49497	37	49735	20	60712	77
43339	39	49061	59	49266	59	49500	36	49736	22	60718	77
43343	39	49062	59	49267	59	49501	36	49737	22	60720	77
43346	39	49064	59	49269	59	49502	36	49742	17	60721	77
43349	39	49066	60	49270	60	49503	36	49744	17	60723	77
43372	40	49068	58	49271	57	49507	36	49748	20	60725	77
44111	56	49069	58	49272	57	49510	37, 58	49749	21	60727	77
44112	57	49070	56	49273	57	49512	37, 59	49770	18	63001	53
44115	57	49076	56	49274	56	49513	37, 59	49772	18	63007	90, 111
44118	57	49077	56	49275	56	49538	36	49774	21	63009	53
45411	29	49078	57	49276	56	49539	36	49778	22	63011	53
45420	29	49079	54	49277	56	49540	36	49779	22	63031	91
46001	80	49081	67	49278	56	49541	36	49781	20	63124	43
46002	80	49085	29	49279	57	49542	36	49782	21	63126	43
46005	80	49130	28	49280	57	49543	36	49830	28	63128	42, 83
46032	51	49131	28	49283	56	49546	37	49831	28	63130	42
46048	51	49132	28	49284	56	49547	37	49832	28	70624	79
47002	83	49134	30	49285	57	49553	21	49833	28	70636	79, 97
47025	51	49137	31	49286	56	49554	21	49910	58	70648	79, 97
47026	51	49138	31	49288	56	49556	22	49957	35	70924	79
47045	49	49142	28	49330	26	49557	22	49958	35	70936	79, 97
47046	49	49150	27	49331	26	49558	22	49961	35	70948	79, 97
47100	78	49151	27	49332	26	49559	22	51924	96	72036	79
47101	78	49152	27	49333	26	49560	17	51936	96	73020	82
47102	78, 83	49153	30	49334	30	49561	17	52917	47, 97	73021	82
47103	78	49154	30	49335	30	49562	17	52936	96	73120	82
47210	78	49155	29	49336	31	49563	17	56923	96	73121	82
47211	78	49156	31	49337	31	49566	22	56924	96	73122	82
47212	78	49157	31	49340	26	49567	22	56929	96	73123	82
47213	78	49162	27	49342	26	49575	20	56930	96	73131	82

INDEX

73132	82	85054	84	85713	92	89245	33	AU-S4	65	DG-80FG	62
73140	82	85058	84	85714	92	89246	33	AU-S6	65	DG-100	62
73141	82	85078	84	85720	86	89273	24	AU-S8	65	DG-100FG	62
73300	82	85088	84	85720IB	86	89274	24	AU-S10	65	DG-106	62
73310	82	85090	84	85720PP	86	89275	24	AU-S12	65	DG-108	62
73320	47	85098	84	85721	86	90324	45	AX-3	89	DG-116	62
75036	78	85310	85	85723	86	90330	45	AX-3FG	89	DG-118	62
75936	78	85422	94	85725	86	90424	45	AX-3M	90	DG-126	63
76502	78	85423	94	85728	86, 131	90430	45	AX-3P	89	DG-128	63
76503	78	85424	94	85730	87	92024	45	AX-5	89	DG-186	63
76602	78	85426	94	85731	87	92030	45	AX-B1	90	DG-188	63
76603	78	85427	94	85732	87	92036	45	AX-B2	90	DG-AEH	53
76801	83	85428	94	85733	87	92042	45	AX-DB3	90	DG-AEH-60	53
76821	83	85430	94	85736	87	92048	45	AX-DB3FG	90	DG-IGH	53
77036	51	85450	93	85738	87	92324	45	AX-P3	90	DG-PP60	91
77136	51	85452	93	85740	86	92330	45			DG-WP60	91
78908	61	85455	93	85750	84	92336	45	B		DR-DC4	94
78912	61	85462	85	85755	84	92342	45	BF-20P	56	DR-DC5	94
78916	61	85465	85	85765	86	92348	45	BF-25	56	DT-1640	67
82008	49	85466	85	86036	48	96022	99	BH-30	52	DW-D1	65
82014	49	85468	85	86050	48	96032	99	BH-35	52	E	
82018	49	85469	85	87003	48	96322	99	BL24	72	EF-20D	57
82084	51, 97	85480	94	87028	48	96624	78, 99	BP-20	77	EF-30D	57
82104	49	85481	94	87600	67	96636	78, 99	BR-10	42	EXA36	72
82106	49	85482	94	87605	67	96640	61	BR16	41	EXB36	72
82118	49	85483	94	87610	67	96716	99	BR-20	42	EXS24	71
82124	49	85484	93	87625	67	96721	99	BR-30	42	F	
82136	49	85485	94	87640	67	96800	98	BR-35	42	FF-30	57
82328	51	85486	93	89023	32	96803	98	BR-40	41	FP-20	74
82384	51, 97	85487	93	89024	32	96806	99	BR-80	41	FR-21	43
82500	51	85490	93	89025	32	96807	99	BR-90	42	FR-70	77
82602	50	85491	93	89026	32	96808	99	C		G	
82614	50	85495	93	89044	32	96809	98	CC20	82	GC-10	55
82624	50	85496	93	89045	32	96810	98	CC20A	82	GC-20	55
82704	49	85499	93	89084	25	96811	61	CE24	75	GC-30	55
82706	49	85525	90	89085	25	96813	98	CE36	75	GC-40	55
82718	49	85526	90	89095	25	96817	99	CE48	75	GC-70	77
82724	49	85529	91	89123	25	96818	98	CE612	75	GC-70H	77
82728	49	85532	90	89124	25	96820	98	CE816	75	GH-10	52
82736	49	85534	90	89125	25	96823	98	CF5	56	GH-20	52
82902	50	85535	90	89126	25	96827	98	CL24	72	GH-30	52
82904	50	85536	91	89133	25	96829	98	D		GH-40	52
82905	50	85537	91	89134	25	96830	98	DG-10	62	GH-80	52
82906	50	85541	91	89135	25	96833	98	DG-11	62	GH-90	52
82918	50	85543	91	89136	25	96838	98	DG-11FG	62	GP-2	90
82919	50	85545	90	89184	25	A		DG-12	63	GP-2FG	90
82924	50	85547	90	89185	25	AF-20	57	DG-15	63	GP14	58
82925	50, 97	85549	91	89194	33	AF-20D	57	DG-16	63	GP14D	58
82926	49	85550	91	89195	33	AP100	98	DG-17	62	GS18	58
82928	51	85552	91	89223	32	AR-30	42, 83	DG-17FG	62	GS18D	58
82936	50	85560	91	89224	32	AS19	58	DG-18	63	H	
83084	51, 97	85620	64	89225	32	AS19D	58	DG-19	91	H800	52
83328	51	85623	64	89226	32	AS200	98	DG-23	91	HB-2	88
83384	51, 97	85630	64	89233	24	AU-02T	65	DG-25	62	HB-2FG	88
83728	49	85633	64	89234	24	AU-A1	65	DG-60	63	HB-3	88
83928	51	85701	92	89235	24	AU-A2	65	DG-75	63		
85008	84	85703	92	89236	24	AU-S2	65				
85010	84	85704	92	89243	33	AU-S3	65				
85050	84	85712	92	89244	33						

HB-3FG	88
HB-4	88
HB-4FG	88
HD-2	88
HD-3	88
HD-3FG	88
HD-4	88
HD-4FG	88
HE-2	88
HE-2FG	88
HE-3	88
HE-3FG	88
HE-4	88
HE-4FG	88
HE-6	88
HE-8	88
HF-20	57
HM-949	91

I	
IC24	78
IC-30	61
IC36	78

L	
LF-18	38
LF-20	40
LF-20CG	40
LF-22	38
LF-25	38
LF-30P	40
LF-30PCG	40
LF-40	38
LF-70	77
LH16	43

M	
MC-5	91
MC-5FG	91
MF-24	56
MF-24L	56
MF-25	56
MF-25L	56
MF-26	56
MF-45	56
MG-2	91
MG-2FG	91
MH10	82
MH-20	82
MH-30	82
MP-5	91
MP-5FG	91
MP-5P	91

N	
NT-70H	77

P	
PB24	49
PB24R	49
PD48	62
PD96	62
PP100	98
PR24	40
PS200	98
PSE200	98

R	
RB-31	127
RB-53	127
RF-30	55
RN-1B1	126
RN-1B2	126
RN-1B3	126
RN-1H1	126
RN-1H2	126
RN-1H3	126
RN-1H4	126
RN-1PBH1	126
RN-1PBH2	126
RN-1PBH3	126
RN-541	127
RN-542	127
RN-641	127
RN-642	127
RN-741	127
RN-742	127
RN-B1	127
RN-B2	127
RN-B3	127
RN-H1	127
RN-H2	127
RN-H3	127
RN-H4	127
RN-PBH1	127
RN-PBH2	127
RN-PBH3	127
RN-X1	127
RN-X3	127
RP-5FG	90
RP-5H	90
RP-6FG	90
RP-6H	90
RR-25	99
RR-25X	99
RR-DN	127
RR-HHM	127
RR-HLM	127
RR-HM	127
RR-HS	127
RR-SM	127
RR-XM	127

S	
S600	17

S600D	17
S601	17
S601D	17
S604	22
S604D	22
S605	21
S605D	21
S700	17
S700D	17
S701	17
S701D	17
S702	25
S703	25
S704	22
S704D	22
S705	21
S705D	21
S706	20
S707	20
S708	24
S709	24
S710	20
S710D	20
S712	17
S713	20
S714	20
S715	22
S715D	22
S717	24
S800	18
S801	18
S805D	21
S819D	21
SB24R	49
SB-48	91
SC-10	61
SC-20	61
SC-24	61
SC-30	61
SC-48	61
SC-79	61
SC-79D	61
SD-20	54
SE12	75
SE24	75
SE36	75
SE48	75
SE612	75
SE816	75
SE824	75
SF-10	56
SF-30	56
SF-40	56
SG1	21
SG-2DH	30
SG-2LH	30
SH-4	89
SH-6	89
SH-6FG	88
SH-8	89
SH-8FG	88
SH-8P	89
SH-10	89
SH-10FG	88

SH-12	89
SH-12FG	88
SH-16	89
SH-16FG	88
SH-20	53
SH-20FG	88
SH-20W	89
SH-36	52
SH-37	52
SK-70H	77
SM-6	89
SM-6A	89
SM-6FG	89
SM-6P	89
SM-8	89
SM-8A	89
SM-8FG	89
SN-1	66
SN-8	66
SN-9	66
SN-9	66
SP-16LB	66
SP-16UB	66
SP-16UG	66
SP30	56
SP48	85
SP60	85
SP100	98
SR22	38
SR-30	43
SS48	75
SS60	75
SS72	75
SS200	98
SV-CR50	29
SV-DD10	31
SV-DD20	31
SV-DD30	31
SV-DD30CB	31
SV-DD40	23
SV-DD46	23
SV-DD50	31
SV-DD80	23
SV-DR12	28
SV-DR22	27
SV-DR32	26
SV-DR42	19
SV-DR52	26
SV-DR72	77
SV-DR82	19
SV-DR92	28
SV-DRCH	30
SV-DRMP	30
SV-DRMPFG	23
SV-DS13	28
SV-DS23	27
SV-DS33	26
SV-DS43	19
SV-DS53	26
SV-DS73	77
SV-DS83	19
SV-DS93	28
SV-DSMP	30
SV-DT35	29
SV-GD10	30

SV-GD24	30
SV-GD34	30
SV-GD34CB	30
SV-GD44	21
SV-GD50	30
SV-GL24	30
SV-IR50	29
SV-LD20	31
SV-LD30	31
SV-LD40	23
SV-LR10	28
SV-LR20	27
SV-LR25	29
SV-LR30	26
SV-LR30CB	26
SV-LR34	26
SV-LR40	19
SV-LR50	26
SV-LR70	77
SV-LR80	19
SV-LR90	28
SV-LS11	28
SV-LS21	27
SV-LS31	26
SV-LS31CB	26
SV-LS35	26
SV-LS41	19
SV-LS51	26
SV-LS81	19
SV-LS91	28
SV-LT34	29
SV-PD50	30
SV-RS20	29
SV-RS40	20
SV-RS50	29
SV-SDA10HM	59
SV-SDA12	59
SV-SDA14	60
SV-SDA14HL	59
SV-SDA14HM	59
SV-SDP12	58
SV-SDP12L	58
SV-SDP12W	60
SV-SDP12WL	60
SV-SDP12WP	60
SV-SDS12	60
SV-SDSC2	60
SV-SLA12	59
SV-SLSC2-54	60
SV-SP20	98
SV-SP22	98
SV-SP25	98
SV-SS10	60
SV-SS10L	60
SV-SS11	60
SV-SS20	98
SV-SS22	98
SV-SS25	98
SV-TR14	32
SV-TR15	32
SV-TR44	25
SV-TR45	25
SW7	61

T	
TP-8FG	84
TP-30	84
TP-32	84
TP612	74
TR-30	42

V	
VH-70	77

W	
WB-4S	86
WB-6P	86
WB-6S	86
WB-6SHD	86
WB-6SHDS	86
WB-10P	86
WB-JR	86
WB-JRB	86
WE-20	67
WE-30	67
WE-35	67
WE-40	67
WE-51	54
WE-52	54
WE-60	54
WE-65	54
WE-70H	77
WH-30	52
WH-70H	77
WP-1010	70
WP-1020	70
WP-1030	70
WP-2110	73
WP-2120	73
WP-2130	73
WP-2135	73
WP-2136	73
WP-2137	73
WP-2140	73
WP-2145	73
WP-3210	71
WP-3220	71
WP-3230	71
WP-5400	76
WP-5401	76
WP-5402	76
WP-5403	76
WP-5405	74
WP-5407	74
WP-5408	69
WR-12	91
WW-4	89
WW-5	89
WW-6	89



SEYMOUR



LINK HANDLES



MIDWEST RAKE



Toolite



KENYON



ProValue



SMART BUY



SEYMOUR MIDWEST LLC • P.O. BOX 1674, WARSAW, IN 46581-1674
P 844-SEYMOUR (739-6687) • 574-267-7875 • F 574-267-8508
SEYMOURMIDWEST.COM

